

DIVIDENDS HORIZON

Price List
February 2014



Knoll

| | | |
|----------------------------|---|-----|
| Introduction | Knoll and Sustainable Design | 3 |
| | Knoll Color Program Finishes | 4 |
| | Dividends Legacy Finishes | 6 |
| | Dividends Horizon Fabrics | 7 |
| Planning Guidelines | Panel Specifications | 8 |
| Panels, Pre-Configured | Monolithic Panels | 14 |
| | Tiled Panels | 22 |
| | Beltway Panels | 40 |
| Panels, Build-To-Spec | Topway and Full View Panel Frame Assemblies | 46 |
| | Stack Frames | 52 |
| | Monolithic Panel Fabric Inserts | 56 |
| | Monolithic Laminate Inserts | 60 |
| | Tiled Fabric Inserts | 66 |
| | Tiled Laminate Inserts | 70 |
| | Beltway Inserts | 74 |
| | High Acoustic Core Inserts | 78 |
| | Window Insert Kits | 80 |
| | Markerboard Tiles | 82 |
| | Steel Insert Kits | 86 |
| | Slatwall Tiles | 94 |
| | Technology Tiles | 96 |
| | Rolling Door | 100 |
| | Open Weave and Glass Screens | 104 |
| | Open Weave and Glass Stacking Screens | 112 |
| Frameless Add Up | 116 | |
| Post Connectors/End Trim | Dividends Horizon DP7 Post Assemblies | 120 |
| | Dividends Horizon DP7 Post Components | 122 |
| | Legacy Post Assemblies | 128 |
| | Legacy Post Components | 130 |
| | Panel End Trim and Panel Top Caps | 134 |
| | Panel Wall Starter, Panel-to-Panel Top Cap Transition | 140 |
| | Wall Mount Tracks and Components | 142 |
| | Panel Rigidizer Brackets, Coat Hooks and Reveal Fillers | 146 |
| Alternative Planning | Concealed Post | 150 |
| | 120° Planning | 170 |
| Electrical/Data Components | Electrical Specifications | 178 |
| | Base Raceway Electrical | 181 |
| | Receptacles | 186 |
| | Vertical Electrical | 188 |
| | Desktop Power and Data Modules | 192 |
| | Beltway Electrical | 194 |
| | Electrical Infeeds and Power Poles | 198 |
| | New York City, San Francisco and Chicago Electrical | 202 |
| Cable Management | 206 | |
| Storage Components | Flip-Up Door Overheads | 210 |
| | Sliding Door Overheads | 214 |
| | Up Mounted Overheads | 226 |
| | Overhead Bookshelf and Corner Shelf | 228 |
| | Mounting Brackets and Accessories | 230 |
| | Task Lights | 234 |
| | Pedestals | 236 |
| | Credenzas | 244 |
| | Flip-up Door Overdesk and Tackboards | 266 |
| | Sliding Door Overdesks | 270 |
| | Sliding Door Overdesks with Tackboard | 279 |

| | | |
|---------------------------------|--|-----|
| Worksurfaces | Worksurface Specifications | 290 |
| | Rectangular Worksurfaces | 294 |
| | Curvilinear Wave End Worksurfaces | 300 |
| | Smooth Wave Worksurfaces | 302 |
| | Trapezoidal Worksurfaces | 303 |
| | Corner Worksurfaces | 304 |
| | Peninsula Worksurfaces | 310 |
| | Curvilinear Half- and Corner-Round Worksurfaces | 312 |
| | Transaction Counter Worksurfaces | 314 |
| Cascade Edge Worksurfaces | Rectangular with Cascade Edge | 316 |
| | Blended “D” and Curvilinear Corner with Cascade Edge | 317 |
| | Blended “L” with Cascade Edge | 318 |
| | Half Round and Corner Round with Cascade Edge | 319 |
| | Wave End with Cascade Edge | 320 |
| Worksurface Supports | Panel Mounted Worksurface Brackets | 322 |
| | Screen-to-Worksurface Brackets | 326 |
| | Panel Mounted Worksurface Supports | 328 |
| | Peninsula Worksurface Supports | 330 |
| Tables | Y Leg Tables | 332 |
| | X Base Tables | 340 |
| | Table Supports | 345 |
| | Rectangular and Corner C-Leg and T-Leg Worksurfaces | 349 |
| | Conference Tables | 350 |
| Freestanding Desks | Preconfigured Desks | 354 |
| | Desk Components | 366 |
| | Desk Accessories | 372 |
| Wall Mounting of Knoll Products | | 375 |
| Alpha-Numeric Index | | 377 |
| Selling Policy | | 389 |
| KnollKey Lock Program | | 391 |
| General Ordering Information | | 392 |

Knoll and Sustainable Design

Each year Knoll sets key initiatives in our journey to sustainability. We are members of a global consortium on energy, have adopted a scientific, metrics-based approach to sustainable product design, and maintain a leadership position in establishing universal, verifiable, sustainability standards for our industry.

Knoll promotes independent third-party certification because it provides the most impartial and trustworthy foundation for industry-wide environmental compliance. Certification by established and respected third parties ensures that all manufacturers are held to the same high standards and that customers can trust a company's declaration about the environmental benefits of its products. Knoll third-party partners include: the International Standards Organization (ISO); Forest Stewardship Council (FSC®); Rainforest Alliance; GREENGUARD® Environmental Institute; and The Business and Institutional Furniture Manufacturer's Association (BIFMA) level® certification from Scientific Certification Systems (SCS).

In addition, Knoll is aligned with the U.S. Green Building Council and can help companies, healthcare organizations and educational institutions achieve Leadership in Energy and Environmental Design (LEED®) workplace certification.

Global Climate Change

- Knoll is a sponsor of the Clinton Global Initiative, which brings together a community of global leaders to devise and implement solutions to some of the world's most pressing challenges, including environmental change.
- Knoll has a comprehensive Energy Management Program to increase energy efficiency in products and processes.

Life Cycle Assessment (LCA) Tool

- Life Cycle Assessment is a science-based measurement of a product's environmental impacts throughout its life cycle, from raw materials sourcing through manufacture, shipping, use and re-use or end-of-life. LCA enables cradle-to-cradle implementation of sustainable practices.
- Knoll has partnered with The Green Standard.org to develop an affordable, universal ISO-compliant computer-based LCA tool that can be used by the entire contract furniture industry and is partnering on the development of an Environmental Product Declaration System (EPDs) for Knoll products. EPDs are verified documents containing LCA results and additional environmental performance information about a product.

Setting Industry Standards

- Knoll partners with MTS (The Institute for Market Transformation to Sustainability) to develop the SMaRT® Consensus Sustainable Products Standards, a set of consensus-based sustainable product standards based on the LEED® model, for all building products, fabric, apparel, flooring and carpet. MTS, the developer of SMaRT®, is an accredited American National Standards Institute (ANSI) standard developer.
- Knoll also partners with BIFMA (Business and Institutional Furniture Manufacturers Association) to promote level® sustainability standards for the contract furniture industry.
- Knoll has established FSC® (Forest Stewardship Council) certified wood as the standard for general office open plan office systems, casegoods and tables.
- Knoll has launched Full Circle, a resource recovery program developed with ANEW, to help customers extend the life cycle of surplus furniture, fixtures and equipment (FF&E) in an economically, socially and environmentally responsible manner.
- Our goal is to encourage all manufacturers in the contract furniture industry and related industries to adopt standards that will lead to sustainable products and practices.

For more information about Knoll and sustainable design, visit knoll.com/environment.

Specify Core finishes for all new customers**Paint Finishes:**

Beige Mist Metallic (611T)
 Bright White (118T)
 Brown (112T)
 Dark Grey (113T)
 Folkstone Grey (114T)
 Jet Black (111T)
 Medium Grey (115T)
 Medium Metallic Grey (612T)
 Sandstone (116T)
 Silver (613)
 Soft Grey (117T)

Paint Finish Applications:

Panel base raceway covers
 Screen frames
 Steel and slatwall tile inserts
 D1 style tile supports
 DP7 metal panel trim
 DP7 power poles
 Worksurface supports
 Overhead and overdesk cases and doors
 Credenza case, top and door
 Pedestal case and fronts
 Table bases

Laminate Finishes:

Bright White (118)
 Brushed Grey (123)
 Brushed Sand (122)
 Fog (128)
 Folkstone Grey (114)
 Jet Black (111)
 Medium Cherry (124)
 Micro Grey (121)
 Micro Sand (129)
 Natural Cherry (126)
 Natural Maple (125)
 Pumice (119)
 Soft Grey (117)
 Walnut (127)

Laminate Finish Applications:

Worksurfaces
 Overhead and overdesk doors
 Credenza top and door
 Laminate tile inserts
 Freestanding desk worksurfaces
 Table tops

2mm Edgeband Finishes:

Bright White (118)
 Fog (128)
 Folkstone Grey (114)
 Jet Black (111)
 Medium Cherry (124)
 Natural Cherry (126)
 Natural Maple (125)
 Pumice (119)
 Soft Grey (117)
 Walnut (127)

2mm Edgeband Finish Applications:

Worksurfaces
 Freestanding desk worksurfaces
 Table tops

Cascade Worksurface Finishes:

Bright White (118)
 Folkstone Grey (114)
 Medium Cherry (124)
 Natural Cherry (126)
 Natural Maple (125)
 Pumice (119)
 Soft Grey (117)
 Walnut (127)

Cascade Worksurface Finish Applications:

Cascade edge worksurface

Techwood Finishes:

Black Oak (Y851)
 Blond Maple (Y821) (formerly known as maple techgrain)
 Cherry (Y319)
 Dark Grey Oak (Y343)
 Dark Mahogany (Y326)
 Espresso (Y344)
 Light Cherry (Y831) (formerly known as cherry techgrain)
 Light Oak (Y327)
 Maple (Y316)
 Medium Oak (Y329)
 Medium Teak (Y342)
 Medium Walnut (Y323)
 Natural (Y811)
 Wenge (Y341)

Techwood Finish Applications:

Worksurfaces
 Overhead and overdesk doors
 Credenza top and door
 Panel trim
 Veneer tile inserts
 Table tops

Plastic Trim Finishes:

Dark Grey (113)
 Medium Grey (115)
 Soft Grey (117)

Plastic Trim Finish Applications:

Plastic panel trim
 Beltway covers
 Legacy power pole covers

DS1 Storage Plastic Finishes:

Bright White (118)
 Brown (112)
 Dark Grey (113)
 Folkstone Grey (114)
 Jet Black (111)
 Medium Grey (115)
 Sandstone (116)
 Soft Grey (117)

DS1 Storage Plastic Finish Applications:

DS1 pedestal drawer plugs and handles
 DS1 overhead door end plugs

Note: All Dividends Horizon products except DS1 and DS2 pedestals and doublewide pedestals are painted with a textured finish excluding 613 Silver, which is available as a smooth finish only. X and Y base tables and the freestanding screen kits are always painted with a textured finish, including 613 Silver.

Note: Laminates and other finishes may vary in color due to different dye lots. Slight variations are to be expected.

Note: Worksurfaces, overhead and overdesk doors, credenza tops and doors, and veneer tile inserts will have the same Techwood finish on the surface and the edge.

| Order Code | Color Name | Old Order Code | Paint Grade | Paint Finishes | Laminate Finishes | 2mm Edgeband Finishes | Cascade Worksurface Finishes | Techwood Finishes | Plastic Trim Finishes | DS1 Storage Plastic Finishes |
|-----------------------------|---|----------------|-------------|----------------|-------------------|-----------------------|------------------------------|-------------------|-----------------------|------------------------------|
| Paints and Laminates | | | | | | | | | | |
| 611T* | Beige Mist Metallic | | P2 | • | | | | | | |
| 118T* | Bright White | LH | P1 | • | • | • | • | | | • |
| 112T* | Brown | | P1 | • | | | | | | • |
| 123 | Brushed Grey | | | | • | | | | | |
| 122 | Brushed Sand | | | | • | | | | | |
| 113T* | Dark Grey | Y3 | P1 | • | | • | | | • | • |
| 128 | Fog | G | | | • | • | | | | |
| 114T* | Folkstone Grey | | P1 | • | • | • | • | | | • |
| 111T* | Jet Black | 27 | P1 | • | • | • | | | | • |
| 124 | Medium Cherry | | | | • | • | • | | | |
| 115 | Medium Grey | | | | • | • | | | | |
| 115T* | Medium Grey | Y2 | P1 | • | | | | | • | • |
| 612T* | Medium Metallic Grey | J | P2 | • | | | | | | |
| 121 | Micro Grey | | | | • | | | | | |
| 129 | Micro Sand | | | | • | | | | | |
| 126 | Natural Cherry | | | | • | • | • | | | |
| 125 | Natural Maple | | | | • | • | • | | | |
| 119 | Pumice | LB, F | | | • | • | • | | | |
| 116T* | Sandstone | | P1 | • | | | | | | • |
| 613 | Silver | 3 | P3 | • | | | | | | |
| 117T* | Soft Grey | E, M42 | P1 | • | • | • | • | | • | • |
| 127 | Walnut | | | | • | • | • | | | |
| Techwoods | | | | | | | | | | |
| Y851 | Black Oak | | | | | | | • | | |
| Y821 | Blond Maple (formerly known as maple techgrain) | | | | | | | • | | |
| Y319 | Cherry | | | | | | | • | | |
| Y343 | Dark Grey Oak | | | | | | | • | | |
| Y326 | Dark Mahogany | | | | | | | • | | |
| Y344 | Espresso | | | | | | | • | | |
| Y831 | Light Cherry (formerly known as cherry techgrain) | | | | | | | • | | |
| Y327 | Light Oak | | | | | | | • | | |
| Y316 | Maple | | | | | | | • | | |
| Y329 | Medium Oak | | | | | | | • | | |
| Y342 | Medium Teak | | | | | | | • | | |
| Y323 | Medium Walnut | | | | | | | • | | |
| Y811 | Natural | | | | | | | • | | |
| Y341 | Wenge | | | | | | | • | | |

**T' suffix is for paint finish only

Most products introduced after 2004 are not available in Legacy finishes. See individual pricing pages for availability.

Specify Legacy finishes to match existing product only. Legacy finishes are not available for new customers.

Trim Finishes

- Panel top caps
- Panel post trim
- Pedestal drawer top caps
- Overhead drawer top caps
- Pedestal drawer pulls
 - Y1 Pewter

Paint Finishes

- Panel base raceway covers
- Panel tiled insert supports
- Solid Steel panel inserts
- Perforated steel panel inserts
- Embossed steel panel inserts
- Overhead storage components
- Pedestals
- Desk components
- Metal panel topcaps and trim

P1 Finishes

- Y1 Pewter

P2 Finishes

- H Beige Metallic
- W Light Tan Metallic

All other Knoll paint finishes and custom finishes (Series 2 components only)

Laminates

Worksurfaces

An upcharge applies where specifying Legacy laminates. Add an amount equal to 10% of the solid PVC edgeband list price to the price of any product specified with a Legacy laminate.

- MC Caramel Maple
- CM Clear Maple
- M1 Light Grey
- PA Pearwood
- SD Sand
- B Snow
- WM Warm Cherry
- MR6 Winter Grey Matrix

Note: Laminates and other finishes may vary in color due to different dye lots. Slight variations are to be expected.

Worksurface Edges

2mm edgeband

- MC Caramel Maple
- CM Clear Maple
- Y3 Dark Grey
- Y2 Medium Grey
- MT Metal
- Y1 Pewter
- SD Sand
- B Snow
- WM Warm Cherry

Fabric Options**Grade 10**

Annex (W1360)
 Broadcloth II (W1619)
 Element (W1077)
 Foundation (W351)
 Growth Spurt (W692)
 Symbolic Details (W693)
 Tailor Made II (1610)
 Versatility (W432)

Grade 20

Banyan (W443)
 Bauhaus Block (W296)
 Circle Line (W1146)
 Clarity (W281)
 Criss Cross (W305)
 Labyrinth (W352)
 Photon (W1293)
 Reflect (W884)
 Resolution (W280)
 Weave Three (W298)

Grade 30

Basket Draft (W249)
 Flow (W565)
 Harmony (W232)
 Interknit (W1090)
 Micro (W465)
 Progression (W403)
 Relay (W1020)

Grade 40

Amplify (W1215)
 Bandwidth (W1219)
 Clarkson (W1218)
 Hourglass (K1523)
 Ornament (W1078)
 Palladium (W1030)
 Spellbound (W1464)

Grade 45

Dristi (K872)

Grade 50

Presto (K1000)
 Ricochet (K498)

Grade 55

Ransom (K1298)
 Transition (W816)

Open Weave Fabrics**Warpnet**

White (W1113/1)
 Medium Grey (W1113/2)
 Dark Value Grey (W1113/3)
 Warm Cool Neutral (W1113/4)
 Brushed Gold (W1113/5)

COM (Customer's Own Material)

COM can be applied to Dividends Horizon product on a select basis. Please consult your Knoll Customer Service Representative for details on the COM approval process and testing requirements.

Pricing for COM fabrics is at Grade 10.

Note: Always contact your Customer Service Representative prior to sending any COM (including pre-approved KnollTextiles) to the manufacturing facility.

Note: All fabric components greater than 60" wide may need to have the fabric railroaded (turned 90°). This must be considered when utilizing a patterned textile.

Dividends Horizon Panels

Dividends Horizon is a furniture system comprised of a wide variety of panels, hanging components, storage, screens and freestanding desks.

At the heart of the system is a universal panel frame. The universal frame is an open design that accepts many styles of panel inserts. These include:

- Monolithic Fabric Insert
- Monolithic Laminate Insert
- Tiled Fabric Insert
- Tiled Laminate Insert
- Beltway Electrical
- Technology Tile
- Painted Steel
- Perforated Steel
- Embossed Steel
- Window Kits
- Markerboard

Panel Dimensions

- Widths: 15", 18",24",30",36", 42",48" and 60"
- Heights: worksurface height, 36",42",50", 57", 64" and 78"
- Thickness: 3"

Panel Frame Options

Dividends Horizon offers two panel frame options, which are selected depending on customer's aesthetic and functional needs. Both frames are available in preconfigured and build-to-spec panels.

Topway panel frames feature an integral top cable trough, and are used with D1 style stack frames.

Full View frames have no top trough, leaving a larger window opening in the top position. Full View frames are used with D2 style stack frames.

Dividends Horizon Panels and Components (Base Raceway shown)

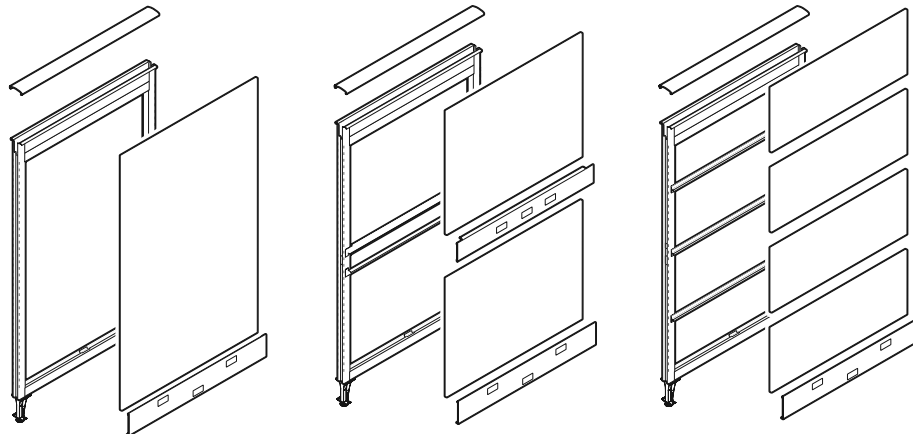

Monolithic Panel

Beltway Panel

Tiled Panel

Panel Frame Construction

Panel frames are robotically welded and consist of vertical channels, horizontal rails and panel feet with leveling glides.

- Topway trough: 22-gauge roll-formed steel (topway frames only)
- Vertical channels: 16-gauge roll-formed steel with 5/8" integral slotted standard with adjustments in 1 1/2" increments
- Horizontal rails: 15-gauge roll-formed steel
- Panel feet: extruded aluminum
- Leveling glides: Steel threads with 1-1/2" height adjustment and 1-1/2" diameter nylon foot

Preconfigured Panels

Dividends Horizon panels can be specified "Preconfigured" in various styles including:

- Monolithic Panel
- Tiled Panel
- Beltway Panel

Monolithic Panel Components

Monolithic panels provide a single fabric or laminate insert per panel side.

Preconfigured Dividends Horizon panels are shipped complete with panel frame, base components, top cap, panel to panel connection hardware and one full height panel insert per side.

Tiled Panel Components

Individual tiled panels allow for a "segmented" aesthetic. Individual tile supports create separation within the panel frame.

"Preconfigured" Dividends Horizon panels ship complete with panel frame, base components, top cap, panel to panel connection hardware, tile supports and tiles.

Beltway Panel Components

Beltway panels allow for electrical and/or data to be accessed above worksurface height. Beltway electrical/data can be specified on one or both sides of a panel.

"Preconfigured" Dividends Horizon beltway panels ship complete with panel frame, base components, top cap, panel to panel connection hardware, beltway panel inserts, beltway covers and beltway insert supports.

Base Options

- Base Raceway
- Open Base
- Tile to the Floor

Note: Standard base, Open base and Tile to the floor components can be retrofitted in either a topway or full view frame.

Stack Frames

Dividends Horizon stack frames increase the overall height of a standard panel.

The stack frame is available in three panel heights, 14", 21" and 28". Dividends Horizon stack panels may be attached to standard 36", 42", 50",57", 64" and 78" high panel. Maximum stacking height above a base panel height is 28".

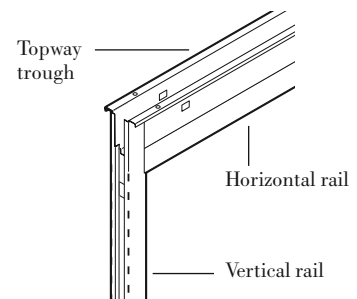

Topway Frame Construction

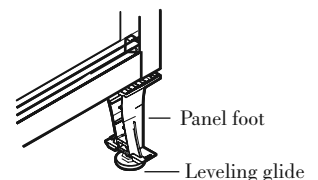

Panel Foot Construction

Open Position Planner

Dividends Horizon now offers an industry leading technology called Open Position Planner, allowing customers and dealers to design, specify and order factory-assembled Dividends Horizon panels in virtually any configuration.

This powerful specification tool eliminates the need for most built-to-spec panels. Since panels arrive at the job site assembled, installation labor is also reduced.

The functionality of Open Position Planner is available only to electronic specification users, and is not available in this price list.

“Build-to-Spec” Panels

“Build-to-Spec” panels are specified by component for special applications. These include: when a different fabric is required on each panel side and when retrofitting existing panels to another style. Panels and components are not shipped assembled.

Universal Panel Connectors

Universal panel connectors are included with Dividends panels. Panel connection hardware is universal to allow:

- Same-height straight panel-to-panel connections
- High-low straight panel-to-panel connections
- Straight high-low panel-to-post connections

Included with universal panel connection hardware:

- Upper wedge block connector
- Lower cactus connectors

Universal panel connection hardware construction:

- Lower connectors: Welded 14-gauge steel cactus style connectors
- Upper connector: Die cast wedge block with 13-gauge steel alignment bracket and 4 1/2" tension screw

Panel Attachment

The lower cactus style connectors engage the lower frames of adjacent panels. The upper wedge block engages the upper frames. The connection is secured by tightening the upper connector's tension screw.

Panel-to-Panel Top Cap Transition

Top cap transitions fill the gap between panel top cap sections in straight panel-to-panel configurations.

- **Construction:** Trim-color black when used with veneer top caps
- **Size:** 1" wide by 3" deep
- **Attachment:** Snaps between top cap sections in straight, same-height panel configurations

Note: Panel-to-panel top cap transitions are ordered separately from panels.

Top Cap

Top cap is included with preconfigured panels.

- **Construction:** Plastic top caps are trim colored, softly radiused plastic extrusion. Veneer top caps are techgrain veneer over plastic extrusion. Metal top caps, available in both radius and flat profiles, are powder coated steel.

- **Attachment:** Snaps onto the trough of a topway panel frame. Retainer clips are used to attach the top cap to the top rail of a full view frame.

Panel End Trim

Panel end trim matches the aesthetics of the panel top cap. It is used to end a panel run and for high-low, panel-to-panel applications.

Four panel trim options are available:

- Enhanced smooth plastic
- Radius Metal
- Flat Metal
- Thin Profile Flat

Note: Panel end trim is ordered separately from panels. Included with the panel end trim are panel end trim brackets.

- **Construction:** Standard panel end trims are trim colored, softly radiused plastic extrusions with a plastic injection molded end cap.

Metal trim is extruded aluminum with powder coat finish.

- **Attachment:** Panel-mount brackets are fastened to the panel with thread-forming screws into pre-punched holes. End trim snaps onto panel mount brackets.

The panel end top cap snaps over the panel end trim and panel top trim.

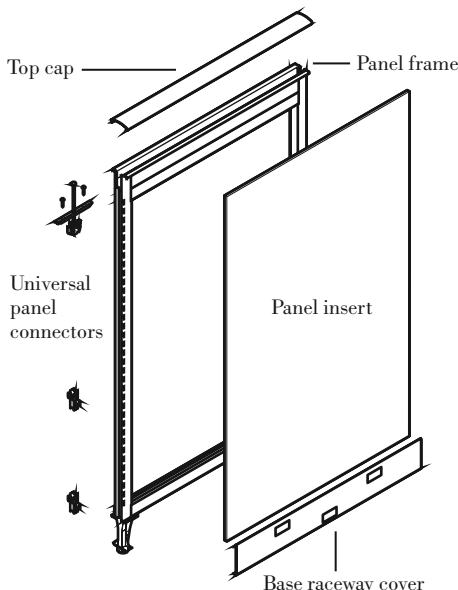

Monolithic Panel

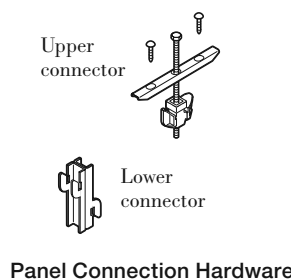

Panel Connection Hardware

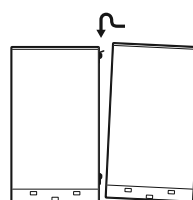

Panel Attachment

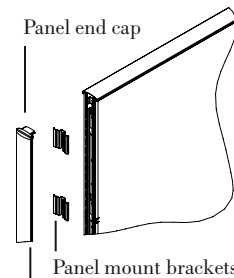

Panel End Trim Attachment

Post Connectors

Post connectors are required for all "L", "T", and "X" configurations. For same-height applications, post connectors are available as an assembly and include the post, vertical trim and top cap.

For high-low panel-to-post applications, post connectors are specified by component.

Post and Post Component Construction

- Post: 3" square extruded aluminum
- Plastic Post Cover: Trim-color plastic extrusion
- Metal Post Cover: 18 gauge steel with powder coat finish
- Post Top Cap: Trim-colored injection-molded plastic

Attachment: Post connectors use the universal panel connection hardware from adjacent panels

Electrical and data access: Posts have cut-outs that match the wire and cable access channels provided by panel frames. This allows wire conduits and data cables to be routed through the post at the topway, beltway and base raceway.

Electrical and Communications
Dividends Horizon provides a logical approach for planning and installing electrical systems and communication cables.

Power is installed along the base raceway with access available in both the base raceway and optional beltway.

Topway Panel Frame Electrical

Allows data cables to be routed horizontally and vertically within the panel.

- Interior dimension: 2 1/2"H x 3/4"W

Cables can be routed along the tops of panels, routed through the interior of panels and along both the beltway and base raceway. The primary channel for distributing cable is provided in the horizontal topway along the top of panels. The topway allows cables to be easily laid-in during initial installation and additional cables to be added as required. It also separates data from power to reduce the chance of interference. A vertical wire pathway is provided in the center of the topway. This allows cables to be run vertically through the interior of the panel to the beltway or base raceway without the use of exterior cable managers.

Data Cabling Bend Radius

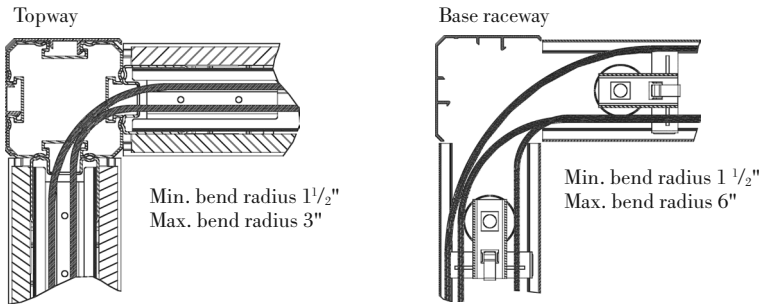

Topway Panel Frame Trough

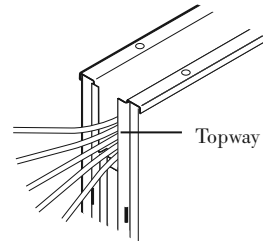

Topway Panel Frame Cable Routing

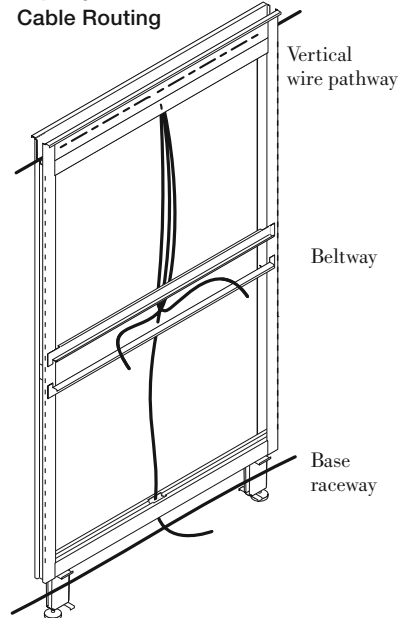

"L" Post Connection

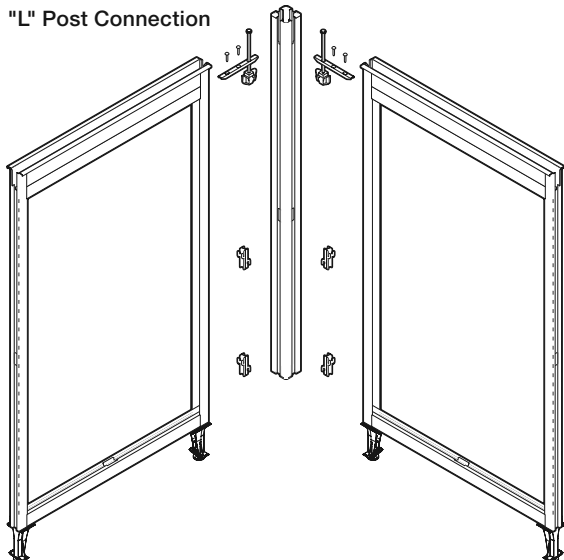

"L" Post Cover Attachment

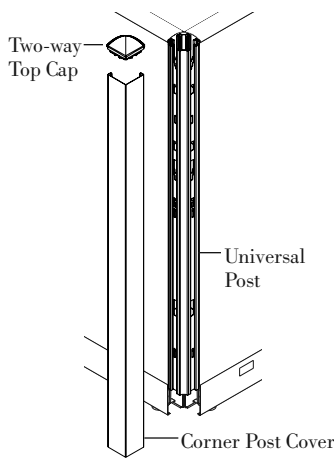

Beltway Electrical

Provides duplex receptacle and data port access at desk-height level.

- Exterior dimension: 4 1/4"H x 3"D
- Interior dimension: 3 1/2"H x 2 3/4"D
- Height from floor: 32 3/4" to center of beltway cover
- Beltway cover construction: Trim-color plastic extrusion
- Beltway cover attachment: Snaps onto beltway panel insert supports
- Duplex access: 30" and wider beltway covers have two duplex knockouts per panel side (18" and 24" wide beltways do not have duplex knockouts)
- Duplex location: Knockouts located 12" on center from each end of cover
- Data access: All beltway covers (except 30" wide) have one center-located data port knockout per panel side
- Additional data access: In panels 30" and wider, the two duplex knockouts can be used as additional data ports when the beltway is not used for duplex receptacles.
- Power capacity: One power module per panel (single or double-sided).

Panel Base Options

Dividends Horizon panels are available with three base options:

- Base Raceway
- Open Base
- Tile-to-Floor.

Overall panel heights, tile configurations and application rules are the same for all three base options.

Base Raceway

Provides duplex receptacle and data port access at base height. Base Raceway panels feature two roll formed steel raceway covers, which are available with or without electrical/data knockouts.

- Exterior dimension: 5"H x 2 15/16"D
- Interior dimension: 5"H x 2 7/8"D
- Dataport Knockout dimension: 1 3/8"H x 2 5/8"D
- Construction: Paint-colored 22-gauge roll-form steel cover
- Duplex access: 24" and wider base raceway covers have two duplex knockouts per panel side (18"W panels do not have duplex knockouts)

- Duplex location: 9" on center from each end
- Data access: All base raceway covers have one center-located data port knockout
- Additional data access: In panels 24" and wider, the outer knockouts can be used as additional data ports when the raceway is not used for duplex receptacles
- Power capacity: One power module or jumper

Note: Knockouts are standard unless specified without.

Open Base panels feature two extruded aluminum feet positioned at the end of each panel. A horizontal trim is located below the bottom tile.

Tile-To-Floor panels eliminate the raceway cover and access on one side, replaced by a fabric or steel tile extended to the floor. A heavy gauge steel internal raceway cover protects the raceway contents and the tile from deflecting when hit by shoes or vacuum cleaners. The other side of the panel features a raceway cover, available with or without electrical/data knockouts. If needed, use one-sided electrical and one-sided base cable trays with this base option.

Beltway Electrical

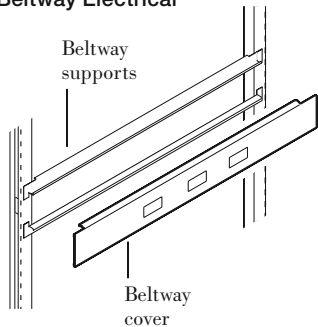

Base Raceway Electrical

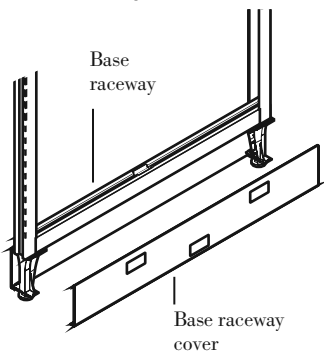

Cable Management Capacities

This chart shows the number of category 5, 4-pair cables that can be routed through various Dividends Horizon pathways. Cable capacities are based on 0.160, 0.200, and 0.250 diameter cables at a full fill capacity.

| Pathway Description | Cable Pathway Area (Square Inches) | Cable Dia. 0.16" | Cable Dia. 0.20" | Cable Dia. 0.25" |
|--------------------------------------|------------------------------------|------------------|------------------|------------------|
| Panel Top Way | 3.00 | 109 | 75 | 41 |
| Panel Base Raceway (w/o electrical) | 8.52 | 270 | 178 | 108 |
| Panel Base Raceway (with electrical) | 3.65 | 162 | 102 | 56 |
| Beltway (w/o electrical) | 1.50 | 72 | 50 | 32 |
| Beltway (with electrical) | 1.10 | 26 | 18 | 11 |
| Vertical Drop (within panel) | 1.90 | 28 | 24 | 15 |

Panel Planning Guidelines

The following panel planning guidelines are provided to ensure stability of Dividends Horizon panels.

Three different scenarios are shown:

- Panel run supported by panels on one end
- Panel run supported by panels on both ends
- High density storage

Panel Run Supported by Panels at One End

- Minimum of an "L" panel connection on one end
- Maximum number of panels in run: 4
- End of panel run must be supported by a pedestal, panel-mounted Open Leg Support, C-leg Support or any height panel

Formula for Depth of Return

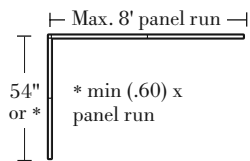

Panel Run Supported by Panels at One End

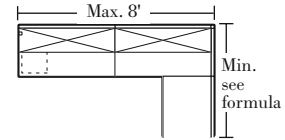
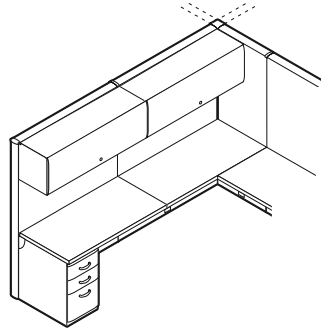

End of Run Supported by Pedestal

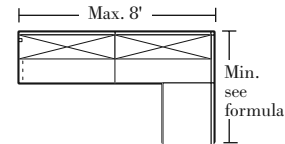
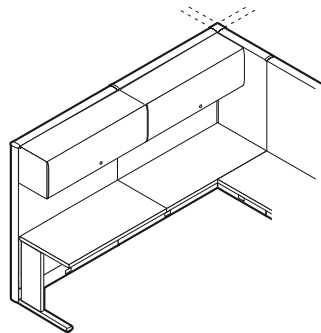

End of Run Supported by Panel Mount C-Leg Support

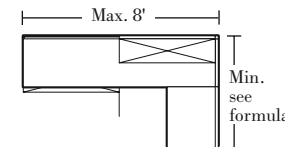
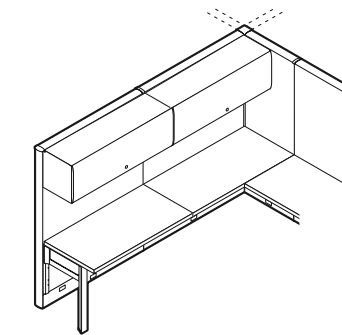

End of Run Supported by Open Leg Support

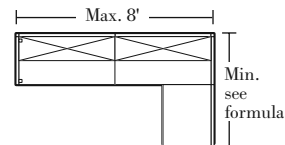
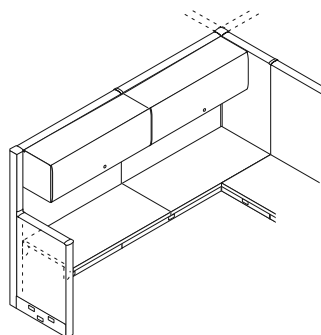

End of Run Supported by Panel of Any Height

Panel Run Supported by Panels at Both Ends

- Minimum of an "L" panel connection on both ends (see Formulas 2 and 3 below)
- Maximum length panel run: 12'
- Maximum number of panels in run: 4

- Both ends of panel run must be supported by matching height panels (see Formulas 2 and 3 below)
- Panel run must be floor supported every 8' with a pedestal, panel mounted Open Support Leg or C-Leg support

High Density Storage

If hanging more than one overhead component vertically per panel side the following is required:

- Panel must be supported by matching height return panels on both ends of the panel

Panel Run Supported by Panels at Both Ends

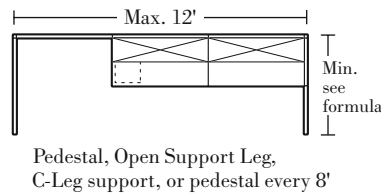
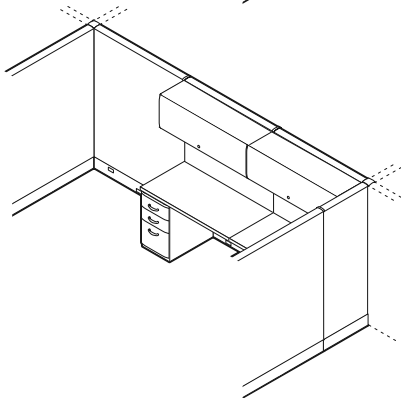
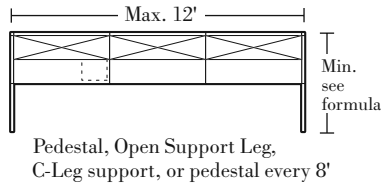
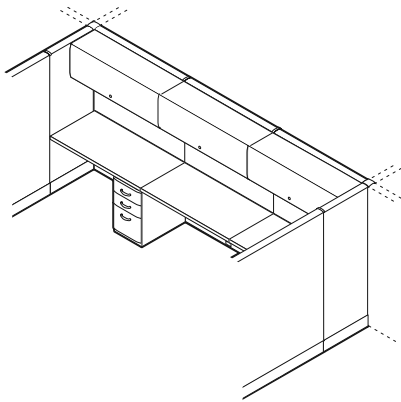

High Density Storage

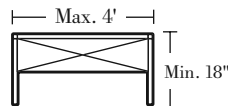
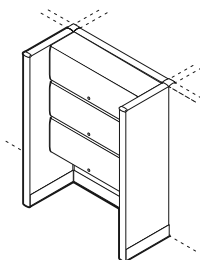

Formulas for Depth Return

Formula 1

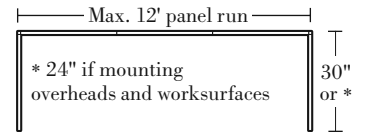

Formula 2

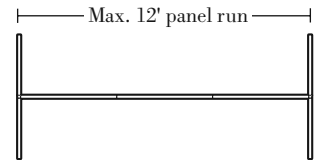

Formula 3

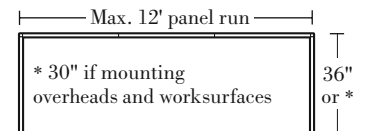

Return panel must be a minimum of 36" wide when laminate tiles are used along the spine panel run.

Monolithic Panel

Monolithic panels provide a single fabric insert per panel side.

Preconfigured Dividends Horizon panels are shipped complete with topway or full view panel frame, base components, top cap, panel to panel connection hardware and one full height fabric panel insert per side.

Panels may also be ordered by components for "Build-to-Spec" applications. This includes when different fabric insert is required on each side of the panel.

Monolithic Panel Insert Construction

Fabric laminated with web adhesive heat-cured to 7/16" thick tackable acoustical board.

Monolithic Panel Ratings

- Noise Reduction Coefficient (NRC) rating: .70
- Sound Transmission Class (STC) rating: 11

Dividends Horizon panels meet the flame spread and smoke generation criteria established in UL1286 safety standard for office furnishings.

Monolithic Panel Insert Attachment

Fabric panel inserts flex to attach to the troughs in the upper and lower horizontal frame supports. Mounting spring clips are attached to inserts for connection to the

vertical frame for additional support. No tools are required for the insert attachment.

Top Cap Options

Three top cap options are available:

- Smooth Radius Plastic
- Radius Metal
- Flat Metal

Top Cap Construction

Smooth radiused plastic top caps are made from extruded plastic. Radius metal and flat metal top caps are made from extruded aluminum.

Top Cap Attachment

Snaps onto the trough of a topway panel frame. Retainer clips are included to attach top caps to a full view frame.

If additional support for monolithic panel inserts is required, a beltway cable tray can be installed.

Three Base Options Available:

- Base Raceway
- Tile to the Floor
- Open Base

Base Raceway covers are available with or without knockouts.

See the preconfigured tiled panel pages for more information on base options.

Carpet Grippers

Carpet grippers should be specified to increase rigidity of unsupported panel runs. The carpet grippers snap onto leveling glides to prevent panel runs from shifting on carpet. The glides rotate in carpet grippers to permit leveling. Carpet grippers have a black finish.

Universal Panel Connectors

Dividends Horizon panels include universal panel connectors to allow same-height straight panel-to-panel connections, high-low straight panel-to-panel connections and straight and high-low panel-to-post connections.

Electrical

Panels 24" and wider will accept two duplex receptacles per panel base side. 18" wide panels will provide pass-through electrical only. All electrical components are ordered separately and must be field-installed.

Preconfigured Monolithic Panel

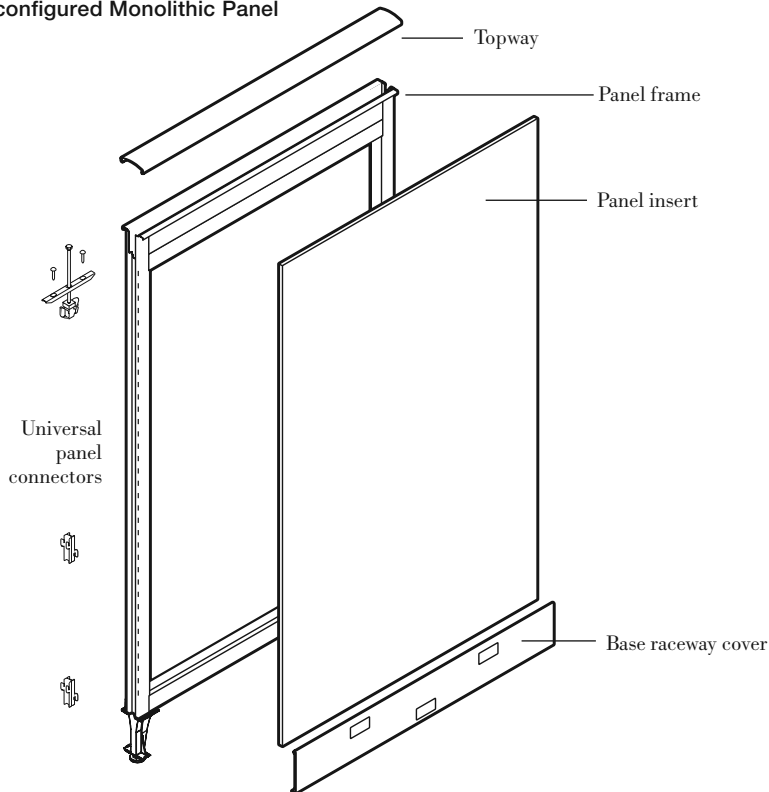



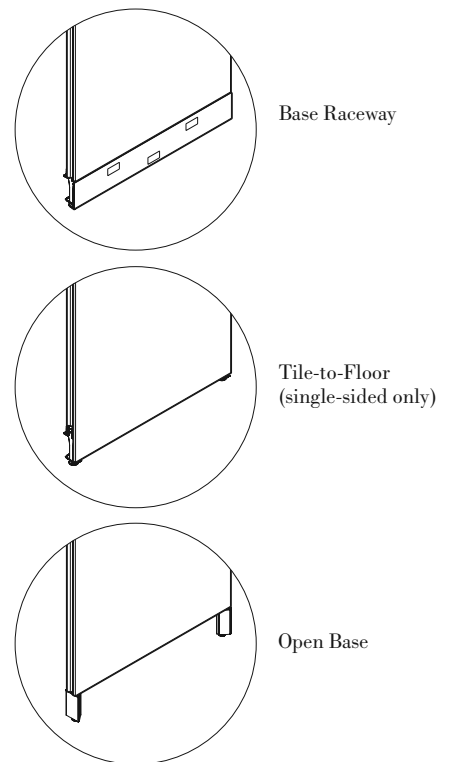

Panel Base Options



Monolithic Panels

Standard Base Raceway

Worksurface Height, 36", 42" and 50" High

| description | h | w | d | pattern no. | grade | | | | | | | |
|--|----------|-----|----|---------------------|--------|--------|--------|--------|--------|--------|--------|--------|
| | | | | | 10 | 15 | 20 | 25 | 30 | 35 | 40 | 45 |
|  Worksurface Height Monolithic Standard Base Raceway | 28 1/2" | 15" | 3" | DP7CMMRRWH15 | \$382. | \$396. | \$414. | \$419. | \$435. | \$441. | \$448. | \$459. |
| | 28 1/2" | 18" | 3" | DP7CMMRRWH18 | 382. | 396. | 414. | 419. | 435. | 441. | 448. | 459. |
| | 28 1/2" | 24" | 3" | DP7CMMRRWH24 | 428. | 441. | 463. | 470. | 483. | 491. | 500. | 511. |
| | 28 1/2" | 30" | 3" | DP7CMMRRWH30 | 450. | 465. | 487. | 495. | 508. | 517. | 526. | 540. |
| | 28 1/2" | 36" | 3" | DP7CMMRRWH36 | 508. | 525. | 551. | 560. | 577. | 587. | 597. | 613. |
| | 28 1/2" | 42" | 3" | DP7CMMRRWH42 | 566. | 583. | 613. | 623. | 640. | 651. | 662. | 681. |
| | 28 1/2" | 48" | 3" | DP7CMMRRWH48 | 600. | 618. | 647. | 657. | 677. | 688. | 702. | 719. |
| | 28 1/2" | 60" | 3" | DP7CMMRRWH60 | 721. | 742. | 777. | 791. | 815. | 830. | 844. | 863. |
|  36" High, Monolithic Standard Base Raceway | 35 1/8" | 15" | 3" | DP7CMMRR3615 | 382. | 396. | 414. | 419. | 435. | 441. | 448. | 459. |
| | 35 1/8" | 18" | 3" | DP7CMMRR3618 | 382. | 396. | 414. | 419. | 435. | 441. | 448. | 459. |
| | 35 1/8" | 24" | 3" | DP7CMMRR3624 | 428. | 441. | 463. | 470. | 483. | 491. | 500. | 511. |
| | 35 1/8" | 30" | 3" | DP7CMMRR3630 | 450. | 465. | 487. | 495. | 508. | 517. | 526. | 540. |
| | 35 1/8" | 36" | 3" | DP7CMMRR3636 | 508. | 525. | 551. | 560. | 577. | 587. | 597. | 613. |
| | 35 1/8" | 42" | 3" | DP7CMMRR3642 | 566. | 583. | 613. | 623. | 640. | 651. | 662. | 681. |
| | 35 1/8" | 48" | 3" | DP7CMMRR3648 | 600. | 618. | 647. | 657. | 677. | 688. | 702. | 719. |
| | 35 1/8" | 60" | 3" | DP7CMMRR3660 | 721. | 742. | 777. | 791. | 815. | 830. | 844. | 863. |
|  42" High, Monolithic Standard Base Raceway | 42 3/16" | 15" | 3" | DP7CMMRR4215 | 400. | 414. | 435. | 442. | 453. | 463. | 470. | 480. |
| | 42 3/16" | 18" | 3" | DP7CMMRR4218 | 400. | 414. | 435. | 442. | 453. | 463. | 470. | 480. |
| | 42 3/16" | 24" | 3" | DP7CMMRR4224 | 435. | 447. | 469. | 475. | 490. | 499. | 505. | 520. |
| | 42 3/16" | 30" | 3" | DP7CMMRR4230 | 475. | 491. | 515. | 525. | 540. | 550. | 558. | 575. |
| | 42 3/16" | 36" | 3" | DP7CMMRR4236 | 521. | 537. | 563. | 575. | 591. | 600. | 610. | 624. |
| | 42 3/16" | 42" | 3" | DP7CMMRR4242 | 577. | 594. | 622. | 633. | 650. | 662. | 675. | 691. |
| | 42 3/16" | 48" | 3" | DP7CMMRR4248 | 612. | 629. | 659. | 673. | 691. | 703. | 714. | 735. |
| | 42 3/16" | 60" | 3" | DP7CMMRR4260 | 735. | 756. | 792. | 809. | 831. | 846. | 859. | 881. |
|  50" High, Monolithic Standard Base Raceway | 49 1/2" | 15" | 3" | DP7CMMRR5015 | 428. | 441. | 463. | 470. | 483. | 491. | 500. | 511. |
| | 49 1/2" | 18" | 3" | DP7CMMRR5018 | 428. | 441. | 463. | 470. | 483. | 491. | 500. | 511. |
| | 49 1/2" | 24" | 3" | DP7CMMRR5024 | 465. | 478. | 501. | 510. | 524. | 531. | 542. | 556. |
| | 49 1/2" | 30" | 3" | DP7CMMRR5030 | 514. | 529. | 555. | 565. | 582. | 593. | 602. | 618. |
| | 49 1/2" | 36" | 3" | DP7CMMRR5036 | 566. | 583. | 613. | 623. | 640. | 651. | 662. | 681. |
| | 49 1/2" | 42" | 3" | DP7CMMRR5042 | 624. | 643. | 675. | 687. | 707. | 719. | 729. | 748. |
| | 49 1/2" | 48" | 3" | DP7CMMRR5048 | 676. | 695. | 728. | 743. | 762. | 776. | 788. | 811. |
| | 49 1/2" | 60" | 3" | DP7CMMRR5060 | 811. | 835. | 876. | 891. | 915. | 933. | 948. | 970. |

Dimensions listed under h w d are actual to the nearest 1/16"



| Ordering Information | Order Code | Included with: | Options |
|---|--|---|--|
| Monolithic Panel with Standard Base Raceway: 1. Pattern number 2. Top cap type 3. Top cap finish 4. Raceway knockout option 5. Raceway trim finish 6. Panel fabric | Monolithic Panel Standard Base Raceway <i>Example:</i> DP7CMMRR3618 4/117/K/117/B191 <hr/> DP7 Dividends Horizon Panel <hr/> C Topway frame <hr/> MM Monolithic both sides <hr/> RR Base Raceway <hr/> 4 Radius Metal top cap <hr/> 117 Soft Grey top cap finish <hr/> K Base raceway with knockouts both sides <hr/> 117 Soft Grey base raceway finish <hr/> B191 Fairfield fabric | Monolithic Panel with Standard Base Raceway: <ul style="list-style-type: none"> Panel frame Acoustic panel inserts (2) Base raceway covers Top cap Connection hardware Note: Preconfigured Worksurface Height panels are not available with plastic top caps. | Monolithic Panel with Standard Base Raceway Options: Full View Frame Option: To specify full view frame for window or stacking applications, replace the "C" in pattern number with "V", No upcharge. Top Cap Options: (2) = Extruded Plastic (Smooth Radius) (3) = No Top Cap (4) = Radius Metal, add \$40 P1, \$42 P2, \$44 P3 (5) = Flat Metal add \$40 P1, \$42 P2, \$44 P3 paint grades Raceway Options: (K) = Knockouts both side (N) = No Knockouts |

Monolithic Panels

Standard Base Raceway

57", 64" and 78" High

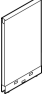
Dividends Horizon

| description | h | w | d | pattern no. | grade | | | | | | | |
|--|------------------------------------|-----|----|---------------------|--------|--------|--------|--------|--------|--------|--------|--------|
| | | | | | 10 | 15 | 20 | 25 | 30 | 35 | 40 | 45 |
| 57" High, Monolithic Standard Base Raceway  | 56 ¹³ / ₁₆ " | 15" | 3" | DP7CMMRR5715 | \$463. | \$475. | \$499. | \$506. | \$523. | \$530. | \$540. | \$555. |
| | 56 ¹³ / ₁₆ " | 18" | 3" | DP7CMMRR5718 | 463. | 475. | 499. | 506. | 523. | 530. | 540. | 555. |
| | 56 ¹³ / ₁₆ " | 24" | 3" | DP7CMMRR5724 | 500. | 514. | 540. | 550. | 565. | 576. | 586. | 600. |
| | 56 ¹³ / ₁₆ " | 30" | 3" | DP7CMMRR5730 | 556. | 575. | 601. | 613. | 629. | 640. | 650. | 669. |
| | 56 ¹³ / ₁₆ " | 36" | 3" | DP7CMMRR5736 | 610. | 629. | 657. | 673. | 690. | 702. | 713. | 730. |
| | 56 ¹³ / ₁₆ " | 42" | 3" | DP7CMMRR5742 | 664. | 684. | 718. | 729. | 750. | 762. | 776. | 798. |
| | 56 ¹³ / ₁₆ " | 48" | 3" | DP7CMMRR5748 | 716. | 737. | 774. | 787. | 810. | 823. | 837. | 859. |
| | 56 ¹³ / ₁₆ " | 60" | 3" | DP7CMMRR5760 | 812. | 836. | 878. | 893. | 917. | 934. | 950. | 972. |
| 64" High, Monolithic Standard Base Raceway  | 64 ¹ / ₁₆ " | 15" | 3" | DP7CMMRR6415 | 495. | 508. | 535. | 544. | 558. | 569. | 580. | 594. |
| | 64 ¹ / ₁₆ " | 18" | 3" | DP7CMMRR6418 | 495. | 508. | 535. | 544. | 558. | 569. | 580. | 594. |
| | 64 ¹ / ₁₆ " | 24" | 3" | DP7CMMRR6424 | 535. | 551. | 579. | 588. | 603. | 615. | 626. | 642. |
| | 64 ¹ / ₁₆ " | 30" | 3" | DP7CMMRR6430 | 598. | 617. | 646. | 656. | 675. | 686. | 700. | 716. |
| | 64 ¹ / ₁₆ " | 36" | 3" | DP7CMMRR6436 | 651. | 673. | 705. | 716. | 738. | 748. | 762. | 781. |
| | 64 ¹ / ₁₆ " | 42" | 3" | DP7CMMRR6442 | 703. | 724. | 758. | 774. | 792. | 810. | 822. | 846. |
| | 64 ¹ / ₁₆ " | 48" | 3" | DP7CMMRR6448 | 756. | 778. | 817. | 833. | 855. | 872. | 884. | 911. |
| | 64 ¹ / ₁₆ " | 60" | 3" | DP7CMMRR6460 | 909. | 936. | 984. | 997. | 1,029. | 1,045. | 1,064. | 1,092. |
| 78" High, Monolithic Standard Base Raceway  | 78 ⁹ / ₁₆ " | 15" | 3" | DP7CMMRR7815 | 708. | 728. | 764. | 778. | 804. | 815. | 828. | 850. |
| | 78 ⁹ / ₁₆ " | 18" | 3" | DP7CMMRR7818 | 708. | 728. | 764. | 778. | 804. | 815. | 828. | 850. |
| | 78 ⁹ / ₁₆ " | 24" | 3" | DP7CMMRR7824 | 780. | 808. | 847. | 860. | 884. | 898. | 916. | 941. |
| | 78 ⁹ / ₁₆ " | 30" | 3" | DP7CMMRR7830 | 849. | 874. | 916. | 933. | 959. | 978. | 992. | 1,018. |
| | 78 ⁹ / ₁₆ " | 36" | 3" | DP7CMMRR7836 | 927. | 957. | 1,000. | 1,020. | 1,049. | 1,067. | 1,086. | 1,114. |
| | 78 ⁹ / ₁₆ " | 42" | 3" | DP7CMMRR7842 | 1,005. | 1,038. | 1,091. | 1,109. | 1,137. | 1,156. | 1,179. | 1,210. |
| | 78 ⁹ / ₁₆ " | 48" | 3" | DP7CMMRR7848 | 1,074. | 1,108. | 1,163. | 1,181. | 1,215. | 1,237. | 1,257. | 1,289. |

Dimensions listed under h w d are actual to the nearest 1/16"

| Ordering Information | Order Code | Included with: | Options |
|---|--|---|--|
| Monolithic Panel with Standard Base Raceway: 1. Pattern number 2. Top cap type 3. Top cap finish 4. Raceway knockout option 5. Raceway trim finish 6. Panel fabric | Monolithic Panel Standard Base Raceway <hr/> <i>Example:</i> DP7CMMRR3618 4/117/K/117/B191 <hr/> DP7 Dividends Horizon Panel <hr/> C Topway frame <hr/> MM Monolithic both sides <hr/> RR Base Raceway <hr/> 4 Radius Metal top cap <hr/> 117 Soft Grey top cap finish <hr/> K Base raceway with knockouts both sides <hr/> 117 Soft Grey base raceway finish <hr/> B191 Fairfield fabric | Monolithic Panel with Standard Base Raceway: <ul style="list-style-type: none"> Panel frame Acoustic panel inserts (2) Base raceway covers Top cap Connection hardware | Monolithic Panel with Standard Base Raceway Options: Full View Frame Option: To specify full view frame for window or stacking applications, replace the "C" in pattern number with "V", No upcharge. Top Cap Options: (2) = Extruded Plastic (Smooth Radius) (3) = No Top Cap (4) = Radius Metal, add \$40 P1, \$42 P2, \$44 P3 (5) = Flat Metal add \$40 P1, \$42 P2, \$44 P3 paint grades Raceway Options: (K) = Knockouts both side (N) = No Knockouts |

Monolithic Panels

Dividends Horizon

Open Base

Worksurface Height, 36", 42" and 50" High

Panels, Pre-Configured

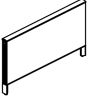
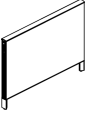
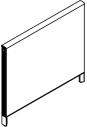
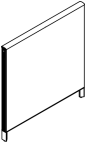
| description | h | w | d | pattern no. | grade | | | | | | | |
|---|----------|-----|----|---------------------|--------|--------|--------|--------|--------|--------|--------|--------|
| | | | | | 10 | 15 | 20 | 25 | 30 | 35 | 40 | 45 |
|  Worksurface Height, Monolithic Open Base | 28 1/2" | 18" | 3" | DP7CMMLLWH18 | \$382. | \$396. | \$414. | \$419. | \$435. | \$441. | \$448. | \$459. |
| | 28 1/2" | 24" | 3" | DP7CMMLLWH24 | 428. | 441. | 463. | 470. | 483. | 491. | 500. | 511. |
| | 28 1/2" | 30" | 3" | DP7CMMLLWH30 | 450. | 465. | 487. | 495. | 508. | 517. | 526. | 540. |
| | 28 1/2" | 36" | 3" | DP7CMMLLWH36 | 508. | 525. | 551. | 560. | 577. | 587. | 597. | 613. |
| | 28 1/2" | 42" | 3" | DP7CMMLLWH42 | 566. | 583. | 613. | 623. | 640. | 651. | 662. | 681. |
| | 28 1/2" | 48" | 3" | DP7CMMLLWH48 | 600. | 618. | 647. | 657. | 677. | 688. | 702. | 719. |
| | 28 1/2" | 60" | 3" | DP7CMMLLWH60 | 721. | 742. | 777. | 791. | 815. | 830. | 844. | 863. |
|  36" High, Monolithic Open Base | 35 1/8" | 18" | 3" | DP7CMMLL3618 | 382. | 396. | 414. | 419. | 435. | 441. | 448. | 459. |
| | 35 1/8" | 24" | 3" | DP7CMMLL3624 | 428. | 441. | 463. | 470. | 483. | 491. | 500. | 511. |
| | 35 1/8" | 30" | 3" | DP7CMMLL3630 | 450. | 465. | 487. | 495. | 508. | 517. | 526. | 540. |
| | 35 1/8" | 36" | 3" | DP7CMMLL3636 | 508. | 525. | 551. | 560. | 577. | 587. | 597. | 613. |
| | 35 1/8" | 42" | 3" | DP7CMMLL3642 | 566. | 583. | 613. | 623. | 640. | 651. | 662. | 681. |
| | 35 1/8" | 48" | 3" | DP7CMMLL3648 | 600. | 618. | 647. | 657. | 677. | 688. | 702. | 719. |
| | 35 1/8" | 60" | 3" | DP7CMMLL3660 | 721. | 742. | 777. | 791. | 815. | 830. | 844. | 863. |
|  42" High, Monolithic Open Base | 42 3/16" | 18" | 3" | DP7CMMLL4218 | 400. | 414. | 435. | 442. | 453. | 463. | 470. | 480. |
| | 42 3/16" | 24" | 3" | DP7CMMLL4224 | 435. | 447. | 469. | 475. | 490. | 499. | 505. | 520. |
| | 42 3/16" | 30" | 3" | DP7CMMLL4230 | 475. | 491. | 515. | 525. | 540. | 550. | 558. | 575. |
| | 42 3/16" | 36" | 3" | DP7CMMLL4236 | 521. | 537. | 563. | 575. | 591. | 600. | 610. | 624. |
| | 42 3/16" | 42" | 3" | DP7CMMLL4242 | 577. | 594. | 622. | 633. | 650. | 662. | 675. | 691. |
| | 42 3/16" | 48" | 3" | DP7CMMLL4248 | 612. | 629. | 659. | 673. | 691. | 703. | 714. | 735. |
| | 42 3/16" | 60" | 3" | DP7CMMLL4260 | 735. | 756. | 792. | 809. | 831. | 846. | 859. | 881. |
|  50" High, Monolithic Open Base | 49 1/2" | 18" | 3" | DP7CMMLL5018 | 428. | 441. | 463. | 470. | 483. | 491. | 500. | 511. |
| | 49 1/2" | 24" | 3" | DP7CMMLL5024 | 465. | 478. | 501. | 510. | 524. | 531. | 542. | 556. |
| | 49 1/2" | 30" | 3" | DP7CMMLL5030 | 514. | 529. | 555. | 565. | 582. | 593. | 602. | 618. |
| | 49 1/2" | 36" | 3" | DP7CMMLL5036 | 566. | 583. | 613. | 623. | 640. | 651. | 662. | 681. |
| | 49 1/2" | 42" | 3" | DP7CMMLL5042 | 624. | 643. | 675. | 687. | 707. | 719. | 729. | 748. |
| | 49 1/2" | 48" | 3" | DP7CMMLL5048 | 676. | 695. | 728. | 743. | 762. | 776. | 788. | 811. |
| | 49 1/2" | 60" | 3" | DP7CMMLL5060 | 811. | 835. | 876. | 891. | 915. | 933. | 948. | 970. |

Dimensions listed under h w d are actual to the nearest 1/16"

Ordering Information

Monolithic Panel with Open Base:

1. Pattern Number
2. Top cap type
3. Top cap finish
4. Base finish
5. Panel fabric

Order Code

Monolithic Panel with Open Base

Example: **DP7CMMLL 3618 4/117/117/B191**

| | |
|-------------|--------------------------|
| DP7 | Dividends Horizon Panel |
| C | Topway frame |
| MM | Monolithic both sides |
| LL | Open base |
| 4 | Radius Metal top cap |
| 117 | Soft Grey top cap finish |
| 117 | Soft Grey raceway finish |
| B191 | Fairfield light fabric |

Included with:

Monolithic Panel with Open Base:

- Panel frame
- Acoustic panel inserts (2)
- Open base
- Top cap
- Connection hardware

Note: Preconfigured Worksurface Height panels are not available with plastic top caps.

Options

Monolithic Panel with Open Base:

Full View Frame Option:

To specify full view frame for window or stacking applications, replace the "C" in pattern number with "V". No upcharge.

Top Cap Options:



- (2)** = Extruded Plastic (Smooth Radius)
- (3)** = No Top Cap
- (4)** = Radius Metal, add \$40 P1, \$42 P2, \$44 P3 paint grades
- (5)** = Flat Metal, add \$40 P1, \$42 P2, \$44 P3 paint grades

Monolithic Panels

Open Base

57", 64" and 78" High

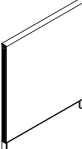
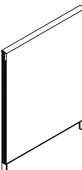
Dividends Horizon

| description | h | w | d | pattern no. | grade | | | | | | | |
|---|-----------------------|-----|----|---------------------|--------|--------|--------|--------|--------|--------|--------|--------|
| | | | | | 10 | 15 | 20 | 25 | 30 | 35 | 40 | 45 |
| 57" High, Monolithic Open Base  | 56 ^{13/16} " | 18" | 3" | DP7CMMLL5718 | \$463. | \$475. | \$499. | \$506. | \$523. | \$530. | \$540. | \$555. |
| | 56 ^{13/16} " | 24" | 3" | DP7CMMLL5724 | 500. | 514. | 540. | 550. | 565. | 576. | 586. | 600. |
| | 56 ^{13/16} " | 30" | 3" | DP7CMMLL5730 | 556. | 575. | 601. | 613. | 629. | 640. | 650. | 669. |
| | 56 ^{13/16} " | 36" | 3" | DP7CMMLL5736 | 610. | 629. | 657. | 673. | 690. | 702. | 713. | 730. |
| | 56 ^{13/16} " | 42" | 3" | DP7CMMLL5742 | 664. | 684. | 718. | 729. | 750. | 762. | 776. | 798. |
| | 56 ^{13/16} " | 48" | 3" | DP7CMMLL5748 | 716. | 737. | 774. | 787. | 810. | 823. | 837. | 859. |
| | 56 ^{13/16} " | 60" | 3" | DP7CMMLL5760 | 812. | 836. | 878. | 893. | 917. | 934. | 950. | 972. |
| 64" High, Monolithic Open Base  | 64 ^{1/16} " | 18" | 3" | DP7CMMLL6418 | 495. | 508. | 535. | 544. | 558. | 569. | 580. | 594. |
| | 64 ^{1/16} " | 24" | 3" | DP7CMMLL6424 | 535. | 551. | 579. | 588. | 603. | 615. | 626. | 642. |
| | 64 ^{1/16} " | 30" | 3" | DP7CMMLL6430 | 598. | 617. | 646. | 656. | 675. | 686. | 700. | 716. |
| | 64 ^{1/16} " | 36" | 3" | DP7CMMLL6436 | 651. | 673. | 705. | 716. | 738. | 748. | 762. | 781. |
| | 64 ^{1/16} " | 42" | 3" | DP7CMMLL6442 | 703. | 724. | 758. | 774. | 792. | 810. | 822. | 846. |
| | 64 ^{1/16} " | 48" | 3" | DP7CMMLL6448 | 756. | 778. | 817. | 833. | 855. | 872. | 884. | 911. |
| | 64 ^{1/16} " | 60" | 3" | DP7CMMLL6460 | 909. | 936. | 984. | 997. | 1,029. | 1,045. | 1,064. | 1,092. |
| 78" High, Monolithic Open Base  | 78 ^{9/16} " | 18" | 3" | DP7CMMLL7818 | 708. | 728. | 764. | 778. | 804. | 815. | 828. | 850. |
| | 78 ^{9/16} " | 24" | 3" | DP7CMMLL7824 | 780. | 808. | 847. | 860. | 884. | 898. | 916. | 941. |
| | 78 ^{9/16} " | 30" | 3" | DP7CMMLL7830 | 849. | 874. | 916. | 933. | 959. | 978. | 992. | 1,018. |
| | 78 ^{9/16} " | 36" | 3" | DP7CMMLL7836 | 927. | 957. | 1,000. | 1,020. | 1,049. | 1,067. | 1,086. | 1,114. |
| | 78 ^{9/16} " | 42" | 3" | DP7CMMLL7842 | 1,005. | 1,038. | 1,091. | 1,109. | 1,137. | 1,156. | 1,179. | 1,210. |
| | 78 ^{9/16} " | 48" | 3" | DP7CMMLL7848 | 1,074. | 1,108. | 1,163. | 1,181. | 1,215. | 1,237. | 1,257. | 1,289. |

Dimensions listed under h w d are actual to the nearest 1/16"

| Ordering Information | Order Code | Included with: | Options |
|---|--|--|--|
| Monolithic Panel with Open Base: | Monolithic Panel with Open Base | Monolithic Panel with Open Base: | Monolithic Panel with Open Base: |
| 1. Pattern Number | <i>Example:</i> DP7CMMLL3618 | <ul style="list-style-type: none"> Panel frame Acoustic panel inserts (2) Open base Top cap Connection hardware | Full View Frame Option: |
| 2. Top cap type | 4/117/117/B191 | | To specify full view frame for window or stacking applications, replace the "C" in pattern number with "V". No upcharge. |
| 3. Top cap finish | DP7 Dividends Horizon Panel | | |
| 4. Base finish | C Topway frame | | |
| 5. Panel fabric | MM Monolithic both sides | | |
| | LL Open Base | | Top Cap Options: |
| | 4 Radius Metal top cap | | (2) = Extruded Plastic (Smooth Radius) |
| | 117 Soft Grey top cap finish | | (3) = No Top Cap |
| | 117 Soft Grey base raceway finish | | (4) = Radius Metal, add \$40 P1, \$42 P2, \$44 P3 paint grades |
| | B191 Fairfield light fabric | | (5) = Flat Metal, add \$40 P1, \$42 P2, \$44 P3 paint grades |

Monolithic Panels

Tile to Floor One Side

Worksurface Height, 36" and 42" High

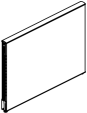
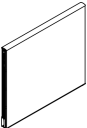
| description | h | w | d | pattern no. | grade | | | | | | | |
|--|----------|-----|----|---------------------|--------|--------|--------|--------|--------|--------|--------|--------|
| | | | | | 10 | 15 | 20 | 25 | 30 | 35 | 40 | 45 |
| Worksurface Height, Monolithic Tile to Floor  | 28 1/2" | 15" | 3" | DP7CMMFRWH15 | \$416. | \$430. | \$448. | \$453. | \$469. | \$475. | \$482. | \$493. |
| | 28 1/2" | 18" | 3" | DP7CMMFRWH18 | 416. | 430. | 448. | 453. | 469. | 475. | 482. | 493. |
| | 28 1/2" | 24" | 3" | DP7CMMFRWH24 | 462. | 475. | 497. | 504. | 517. | 525. | 534. | 545. |
| | 28 1/2" | 30" | 3" | DP7CMMFRWH30 | 484. | 499. | 521. | 529. | 542. | 551. | 560. | 574. |
| | 28 1/2" | 36" | 3" | DP7CMMFRWH36 | 542. | 559. | 585. | 594. | 611. | 621. | 631. | 647. |
| | 28 1/2" | 42" | 3" | DP7CMMFRWH42 | 600. | 617. | 647. | 657. | 674. | 685. | 696. | 715. |
| | 28 1/2" | 48" | 3" | DP7CMMFRWH48 | 634. | 652. | 681. | 691. | 711. | 722. | 736. | 753. |
| | 28 1/2" | 60" | 3" | DP7CMMFRWH60 | 755. | 776. | 811. | 825. | 849. | 864. | 878. | 897. |
| 36" High, Monolithic Tile to Floor  | 35 1/8" | 15" | 3" | DP7CMMFR3615 | 416. | 430. | 448. | 453. | 469. | 475. | 482. | 493. |
| | 35 1/8" | 18" | 3" | DP7CMMFR3618 | 416. | 430. | 448. | 453. | 469. | 475. | 482. | 493. |
| | 35 1/8" | 24" | 3" | DP7CMMFR3624 | 462. | 475. | 497. | 504. | 517. | 525. | 534. | 545. |
| | 35 1/8" | 30" | 3" | DP7CMMFR3630 | 484. | 499. | 521. | 529. | 542. | 551. | 560. | 574. |
| | 35 1/8" | 36" | 3" | DP7CMMFR3636 | 542. | 559. | 585. | 594. | 611. | 621. | 631. | 647. |
| | 35 1/8" | 42" | 3" | DP7CMMFR3642 | 600. | 617. | 647. | 657. | 674. | 685. | 696. | 715. |
| | 35 1/8" | 48" | 3" | DP7CMMFR3648 | 634. | 652. | 681. | 691. | 711. | 722. | 736. | 753. |
| | 35 1/8" | 60" | 3" | DP7CMMFR3660 | 755. | 776. | 811. | 825. | 849. | 864. | 878. | 897. |
| 42" High, Monolithic Tile to Floor  | 42 3/16" | 15" | 3" | DP7CMMFR4215 | 434. | 448. | 469. | 476. | 487. | 497. | 504. | 514. |
| | 42 3/16" | 18" | 3" | DP7CMMFR4218 | 434. | 448. | 469. | 476. | 487. | 497. | 504. | 514. |
| | 42 3/16" | 24" | 3" | DP7CMMFR4224 | 469. | 481. | 503. | 509. | 524. | 533. | 539. | 554. |
| | 42 3/16" | 30" | 3" | DP7CMMFR4230 | 509. | 525. | 549. | 559. | 574. | 584. | 592. | 609. |
| | 42 3/16" | 36" | 3" | DP7CMMFR4236 | 555. | 571. | 597. | 609. | 625. | 634. | 644. | 658. |
| | 42 3/16" | 42" | 3" | DP7CMMFR4242 | 611. | 628. | 656. | 667. | 684. | 696. | 709. | 725. |
| | 42 3/16" | 48" | 3" | DP7CMMFR4248 | 646. | 663. | 693. | 707. | 725. | 737. | 748. | 769. |
| | 42 3/16" | 60" | 3" | DP7CMMFR4260 | 769. | 790. | 826. | 843. | 865. | 880. | 893. | 915. |

Dimensions listed under h w d are actual to the nearest 1/16"

| Ordering Information | Order Code | Included with: | Options |
|---|--|--|---|
| Monolithic Panel with Tile to Floor: 1. Pattern Number 2. Top cap type 3. Top cap finish 4. Raceway knockout option 5. Base raceway finish 6. Panel fabric | Monolithic Panel with Tile to Floor Example: DP7CMMFR 3618 4/117/K/117/B191 <hr/> DP7 Dividends Horizon Panel <hr/> C Topway frame <hr/> MM Monolithic both sides <hr/> FR Tile to Floor <hr/> 4 Radius Metal top cap <hr/> 117 Soft Grey top cap finish <hr/> K Base raceway with knockouts one side <hr/> 117 Soft Grey base raceway finish <hr/> B191 Fairfield light fabric | Monolithic Panel with Tile to Floor: <ul style="list-style-type: none"> Panel frame Acoustic panel inserts (2) Top cap Connection hardware Base raceway on one side Note: Preconfigured Worksurface Height panels are not available with plastic top caps. | Monolithic Panel with Tile to Floor: Full View Frame Option: To specify full view frame for window or stacking applications, replace the "C" in pattern number with "V". No upcharge. Tile to Floor Side Option: Tile to Floor standard on side 2. To specify tile to floor on side 1, change "FR" in pattern number to "RF". Top Cap Options: (2) = Extruded Plastic (Smooth Radius) (3) = No Top Cap (4) = Radius Metal, add \$40 P1, \$42 P2, \$44 P3 (5) = Flat Metal, add \$40 P1, \$42 P2, \$44 P3 paint grades Raceway Knockout Options: (K) = Knockouts on raceway side (N) = No Knockouts |

Monolithic Panels

Tile to Floor One Side

50", 57" and 64" High

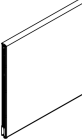
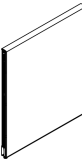
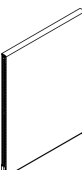
| description | h | w | d | pattern no. | grade | | | | | | | |
|---|-----------|-----|----|---------------------|--------|--------|--------|--------|--------|--------|--------|--------|
| | | | | | 10 | 15 | 20 | 25 | 30 | 35 | 40 | 45 |
| 50" High, Monolithic Tile to Floor  | 49 1/2" | 15" | 3" | DP7CMMFR5015 | \$462. | \$475. | \$497. | \$504. | \$517. | \$525. | \$534. | \$545. |
| | 49 1/2" | 18" | 3" | DP7CMMFR5018 | 462. | 475. | 497. | 504. | 517. | 525. | 534. | 545. |
| | 49 1/2" | 24" | 3" | DP7CMMFR5024 | 499. | 512. | 535. | 544. | 558. | 565. | 576. | 590. |
| | 49 1/2" | 30" | 3" | DP7CMMFR5030 | 548. | 563. | 589. | 599. | 616. | 627. | 636. | 652. |
| | 49 1/2" | 36" | 3" | DP7CMMFR5036 | 600. | 617. | 647. | 657. | 674. | 685. | 696. | 715. |
| | 49 1/2" | 42" | 3" | DP7CMMFR5042 | 658. | 677. | 709. | 721. | 741. | 753. | 763. | 782. |
| | 49 1/2" | 48" | 3" | DP7CMMFR5048 | 710. | 729. | 762. | 777. | 796. | 810. | 822. | 845. |
| | 49 1/2" | 60" | 3" | DP7CMMFR5060 | 845. | 869. | 910. | 925. | 949. | 967. | 982. | 1,004. |
| 57" High, Monolithic Tile to Floor  | 56 13/16" | 15" | 3" | DP7CMMFR5715 | 497. | 509. | 533. | 540. | 557. | 564. | 574. | 589. |
| | 56 13/16" | 18" | 3" | DP7CMMFR5718 | 497. | 509. | 533. | 540. | 557. | 564. | 574. | 589. |
| | 56 13/16" | 24" | 3" | DP7CMMFR5724 | 534. | 548. | 574. | 584. | 599. | 610. | 620. | 634. |
| | 56 13/16" | 30" | 3" | DP7CMMFR5730 | 590. | 609. | 635. | 647. | 663. | 674. | 684. | 703. |
| | 56 13/16" | 36" | 3" | DP7CMMFR5736 | 644. | 663. | 691. | 707. | 724. | 736. | 747. | 764. |
| | 56 13/16" | 42" | 3" | DP7CMMFR5742 | 698. | 718. | 752. | 763. | 784. | 796. | 810. | 832. |
| | 56 13/16" | 48" | 3" | DP7CMMFR5748 | 750. | 771. | 808. | 821. | 844. | 857. | 871. | 893. |
| | 56 13/16" | 60" | 3" | DP7CMMFR5760 | 846. | 870. | 912. | 927. | 951. | 968. | 984. | 1,006. |
| 64" High, Monolithic Tile to Floor  | 64 1/16" | 15" | 3" | DP7CMMFR6415 | 529. | 542. | 569. | 578. | 592. | 603. | 614. | 628. |
| | 64 1/16" | 18" | 3" | DP7CMMFR6418 | 529. | 542. | 569. | 578. | 592. | 603. | 614. | 628. |
| | 64 1/16" | 24" | 3" | DP7CMMFR6424 | 569. | 585. | 613. | 622. | 637. | 649. | 660. | 676. |
| | 64 1/16" | 30" | 3" | DP7CMMFR6430 | 632. | 651. | 680. | 690. | 709. | 720. | 734. | 750. |
| | 64 1/16" | 36" | 3" | DP7CMMFR6436 | 685. | 707. | 739. | 750. | 772. | 782. | 796. | 815. |
| | 64 1/16" | 42" | 3" | DP7CMMFR6442 | 737. | 758. | 792. | 808. | 826. | 844. | 856. | 880. |
| | 64 1/16" | 48" | 3" | DP7CMMFR6448 | 790. | 812. | 851. | 867. | 889. | 906. | 918. | 945. |
| | 64 1/16" | 60" | 3" | DP7CMMFR6460 | 943. | 970. | 1,018. | 1,031. | 1,063. | 1,079. | 1,098. | 1,126. |

Dimensions listed under h w d are actual to the nearest 1/16"

| Ordering Information | Order Code | Included with: | Options |
|---|--|--|---|
| Monolithic Panel with Tile to Floor: 1. Pattern Number 2. Top cap type 3. Top cap finish 4. Raceway knockout option 5. Base raceway finish 6. Panel fabric | Monolithic Panel with Tile to Floor <i>Example:</i> DP7CMMFR 3618 4/117/K/117/B191 <hr/> DP7 Dividends Horizon Panel <hr/> C Topway frame <hr/> MM Monolithic both sides <hr/> FR Tile to Floor <hr/> 4 Radius Metal top cap <hr/> 117 Soft Grey top cap finish <hr/> K Base raceway with knockouts one side <hr/> 117 Soft Grey raceway finish <hr/> B191 Fairfield light fabric | Monolithic Panel with Tile to Floor: <ul style="list-style-type: none"> Panel frame Acoustic panel inserts (2) Top cap Connection hardware Base raceway on one side | Monolithic Panel with Tile to Floor: Full View Frame Option: To specify full view frame for window or stacking applications, replace the "C" in pattern number with "V". No upcharge. Tile to Floor Side Option: Tile to Floor standard on side 2. To specify tile to floor on side 1, change "FR" in pattern number to "RF". Top Cap Options: (2) = Extruded Plastic (Smooth Radius) (3) = No Top Cap (4) = Radius Metal, add \$40 P1, \$42 P2, \$44 P3 (5) = Flat Metal, add \$40 P1, \$42 P2, \$44 P3 paint grades Raceway Knockout Options: (K) = Knockouts on raceway side (N) = No Knockouts |

Monolithic Panels

Tile to Floor One Side

78" High

| description | h | w | d | pattern no. | grade | | | | | | | |
|---------------------------------------|-----------------------------------|-----|----|---------------------|--------|--------|--------|--------|--------|--------|--------|--------|
| | | | | | 10 | 15 | 20 | 25 | 30 | 35 | 40 | 45 |
| 78" High, Monolithic Tile to Floor | 78 ¹ / ₁₆ " | 15" | 3" | DP7CMMFR7815 | \$742. | \$762. | \$798. | \$812. | \$838. | \$849. | \$862. | \$884. |
| | 78 ¹ / ₁₆ " | 18" | 3" | DP7CMMFR7818 | 742. | 762. | 798. | 812. | 878. | 849. | 862. | 884. |
| | 78 ¹ / ₁₆ " | 24" | 3" | DP7CMMFR7824 | 814. | 842. | 881. | 894. | 918. | 932. | 950. | 975. |
| | 78 ¹ / ₁₆ " | 30" | 3" | DP7CMMFR7830 | 883. | 908. | 950. | 967. | 993. | 1,012. | 1,026. | 1,052. |
| | 78 ¹ / ₁₆ " | 36" | 3" | DP7CMMFR7836 | 961. | 991. | 1,034. | 1,054. | 1,083. | 1,101. | 1,120. | 1,148. |
| | 78 ¹ / ₁₆ " | 42" | 3" | DP7CMMFR7842 | 1,039. | 1,072. | 1,125. | 1,143. | 1,171. | 1,190. | 1,213. | 1,244. |
| | 78 ¹ / ₁₆ " | 48" | 3" | DP7CMMFR7848 | 1,108. | 1,142. | 1,197. | 1,215. | 1,249. | 1,271. | 1,291. | 1,323. |



Dimensions listed under h w d are actual to the nearest 1/16"

| Ordering Information | Order Code | Included with: | Options |
|---|--|--|---|
| Monolithic Panel with Tile to Floor: 1. Pattern Number 2. Top cap type 3. Top cap finish 4. Raceway knockout option 5. Base raceway finish 6. Panel fabric | Monolithic Panel with Tile to Floor <i>Example:</i> DP7CMMFR 3618 4/117/K/117/B191 <hr/> DP7 Dividends Horizon Panel <hr/> C Topway frame <hr/> MM Monolithic both sides <hr/> FR Tile to Floor <hr/> 4 Radius Metal top cap <hr/> 117 Soft Grey top cap finish <hr/> K Base raceway with knockouts one side <hr/> 117 Soft Grey raceway finish <hr/> B191 Fairfield light fabric | Monolithic Panel with Tile to Floor: <ul style="list-style-type: none"> Panel frame Acoustic panel inserts (2) Top cap Connection hardware Base raceway on one side | Monolithic Panel with Tile to Floor: Full View Frame Option: To specify full view frame for window or stacking applications, replace the "C" in pattern number with "V". No upcharge. Tile to Floor Side Option: Tile to Floor standard on side 2. To specify tile to floor on side 1, change "FR" in pattern number to "RF". Top Cap Options: (2) = Extruded Plastic (Smooth Radius) (3) = No Top Cap (4) = Radius Metal, add \$40 P1, \$42 P2, \$44 P3 (5) = Flat Metal, add \$40 P1, \$42 P2, \$44 P3 paint grades Raceway Knockout Options: (K) = Knockouts on raceway side (N) = No Knockouts |

Tiled Panel Components

"Preconfigured" Dividends Horizon tiled panels ship completely assembled with a topway or full view panel frame, choice of standard base options including a standard raceway, open base, and tile to the floor. Also, included with every tiled panel are the panel-to-panel connection hardware, top cap, tile inserts and supports.

Tiled Panel Insert Construction

Fabric laminated with roll coat adhesive, heat-cured to 7/16" thick tackable acoustical board.

One-Sided Tiled Panel

Tiled panels are available with fabric tiled inserts attached to one or both panel sides. Non-tiled panel side will have a monolithic insert.

Tiled Panel Insert Supports

All Dividends Horizon panel frames are prepunched to accept tiled panel insert supports which span horizontally across the panel frame. Tiled panel insert supports are mounted above a tiled insert with the exception of the uppermost tile. D2 style recessed insert supports are available in black only.

Tiled Panel Insert Attachment

Tiled panel inserts attach to the troughs in the horizontal panel frame and tiled insert supports. Mounting clips are attached to inserts for connection to frame for additional support. No tools are required for attachment.

Top Cap Options

Three Top Cap Options Available:

- Smooth Radius Plastic
- Radius Metal
- Flat Metal

Top Cap Construction

Smooth radiused plastic top caps are made from extruded plastic. Radius metal and flat metal top caps are made from extruded aluminum.

Top Cap Attachment

Snaps onto the trough of a topway panel frame. Retainer clips are included to attach top caps to full view frames.

Preconfigured Tiled Panel

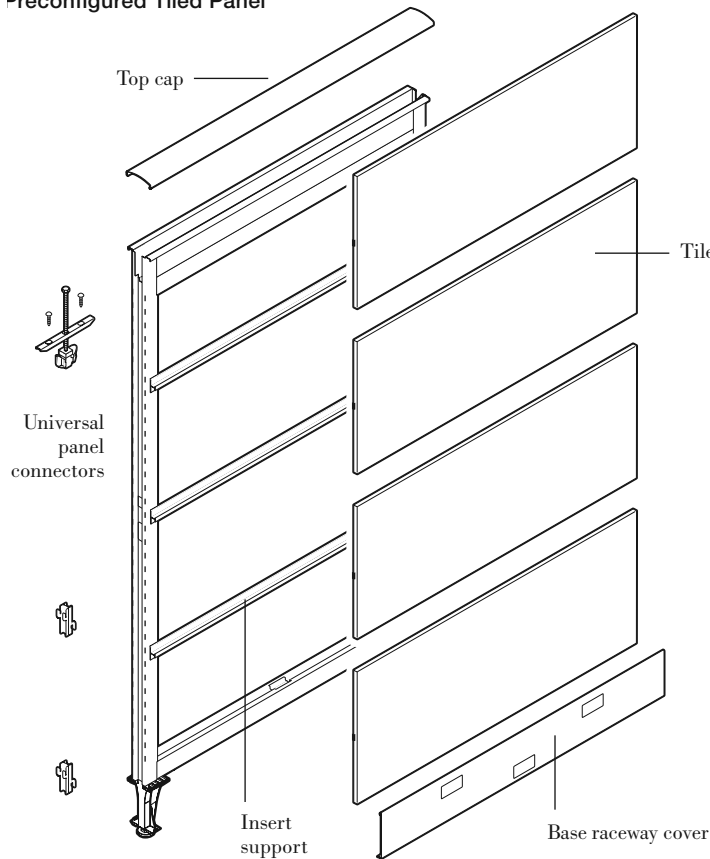

Tiled Panel Standard Configurations

Tiled panels include the following inserts and insert supports per panel side:

| | | | |
|---|--|---|--|
| <p>36" High</p> <ul style="list-style-type: none"> • Two 14"H tiles • One tile supports | | <p>42" High</p> <ul style="list-style-type: none"> • One 7"H tile and two 14"H tiles • Two tile supports | |
| <p>50" High</p> <ul style="list-style-type: none"> • Three 14"H tiles • Two tile supports | | <p>57" High</p> <ul style="list-style-type: none"> • One 7"H tile and three 14"H tiles • Three tile supports | |
| <p>64" High</p> <ul style="list-style-type: none"> • Four 14"H tiles • Three tile supports | | <p>78" High</p> <ul style="list-style-type: none"> • Five 14"H tiles • Four tile supports | |

Panel Base Options

Dividends Horizon panels are available with three base options:

- Base Raceway
- Open Base
- Tile-to-Floor

Overall panel heights, tile configurations and application rules are the same for all three base options.

Base Raceway panels feature two roll formed steel raceway covers, which are available with or without electrical/data knockouts.

Open Base panels feature two extruded aluminum feet with triangular profile, positioned at the end of each panel. Open base panels offer a lighter aesthetic and improved ventilation over raceway panels.

Tile-To-Floor panels eliminate the raceway cover and access on one side, replaced by a fabric tile extended to the floor. A heavy gauge steel internal raceway cover protects the raceway contents and the tile from deflecting when hit by shoes or vacuum cleaners. The other side of the panel features a raceway cover, available with or without electrical/data knockouts. If electrical access is required, one-sided electrical and one-sided base cable trays must be used.

Open Position Planner

Dividends Horizon now offers an industry leading technology called Open Position Planner, allowing customers and dealers to design, specify and order factory-assembled Dividends Horizon panel frames in virtually any configuration.

This powerful specification tool eliminates the need for built-to-spec panels. Since panels arrive at the job site assembled, installation labor is also reduced.

The functionality of Open Position Planner is available only to Electronic Specification users, and is not available in this price list.

Panels may be ordered by component throughout the “Built-to-Spec” option, allowing personalized combinations of the tile types and colors.

Note: Standard configurations of “Preconfigured” tiled panels are also available with 28” base tiles with a standard base raceway, open base or tile to the floor options.

Note: Overheads can only be attached to the upper most position of tiled panels. On 78” high panels the overhead may be positioned on the 4th or 5th tile location from the bottom, but not both locations of a single panel.

Note: Insert dimensions are nominal

Panel Base Options

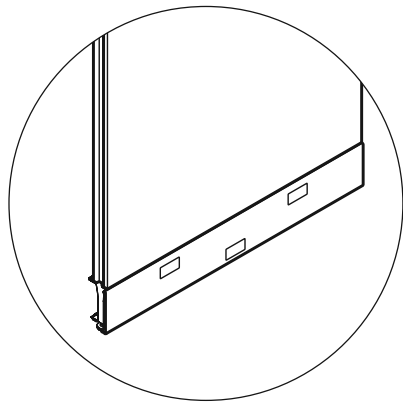

Base Raceway

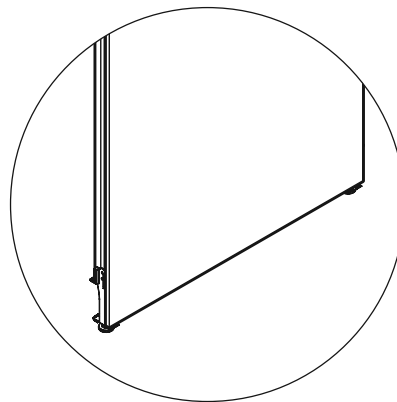

Tile-to-Floor
(single-sided only)

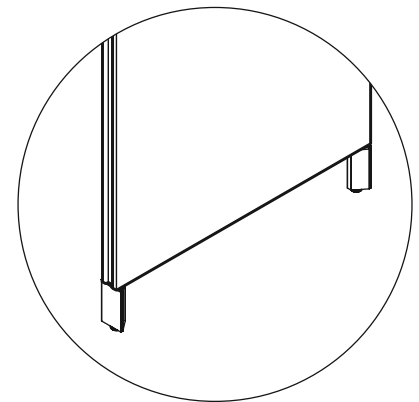



Open Base

Tiled Panels

Base Raceway

36", 42" and 50" High

| description | h | w | d | pattern no. | grade | | | | | | | | Deduct for Monolithic One Side |
|---|----------|-----|----|---------------------|--------|--------|--------|--------|--------|--------|--------|--------|--------------------------------|
| | | | | | 10 | 15 | 20 | 25 | 30 | 35 | 40 | 45 | |
|  36" High Tiled Standard Base Raceway | 35 1/8" | 15" | 3" | DP7CTTRR3615 | \$619. | \$636. | \$670. | \$681. | \$700. | \$711. | \$723. | \$742. | \$88. |
| | 35 1/8" | 18" | 3" | DP7CTTRR3618 | 619. | 636. | 670. | 681. | 700. | 711. | 723. | 742. | 88. |
| | 35 1/8" | 24" | 3" | DP7CTTRR3624 | 657. | 678. | 711. | 724. | 743. | 756. | 771. | 788. | 89. |
| | 35 1/8" | 30" | 3" | DP7CTTRR3630 | 699. | 719. | 751. | 769. | 786. | 806. | 816. | 837. | 94. |
| | 35 1/8" | 36" | 3" | DP7CTTRR3636 | 764. | 783. | 823. | 843. | 861. | 880. | 893. | 916. | 92. |
| | 35 1/8" | 42" | 3" | DP7CTTRR3642 | 820. | 846. | 884. | 899. | 926. | 943. | 959. | 986. | 91. |
| | 35 1/8" | 48" | 3" | DP7CTTRR3648 | 859. | 884. | 928. | 947. | 969. | 989. | 1,004. | 1,033. | 93. |
| | 35 1/8" | 60" | 3" | DP7CTTRR3660 | 1,032. | 1,063. | 1,114. | 1,134. | 1,165. | 1,184. | 1,206. | 1,236. | 95. |
|  42" High Tiled Standard Base Raceway | 42 3/16" | 15" | 3" | DP7CTTRR4215 | 635. | 653. | 686. | 700. | 719. | 729. | 743. | 762. | 88. |
| | 42 3/16" | 18" | 3" | DP7CTTRR4218 | 635. | 653. | 686. | 700. | 719. | 729. | 743. | 762. | 88. |
| | 42 3/16" | 24" | 3" | DP7CTTRR4224 | 675. | 695. | 727. | 742. | 761. | 775. | 787. | 810. | 89. |
| | 42 3/16" | 30" | 3" | DP7CTTRR4230 | 723. | 744. | 780. | 799. | 817. | 833. | 848. | 870. | 90. |
| | 42 3/16" | 36" | 3" | DP7CTTRR4236 | 775. | 801. | 837. | 853. | 876. | 890. | 908. | 928. | 92. |
| | 42 3/16" | 42" | 3" | DP7CTTRR4242 | 830. | 854. | 894. | 913. | 935. | 954. | 966. | 993. | 91. |
| | 42 3/16" | 48" | 3" | DP7CTTRR4248 | 874. | 898. | 944. | 961. | 988. | 1,002. | 1,021. | 1,049. | 93. |
| | 42 3/16" | 60" | 3" | DP7CTTRR4260 | 1,050. | 1,082. | 1,134. | 1,153. | 1,186. | 1,207. | 1,226. | 1,258. | 95. |
|  50" High Tiled Standard Base Raceway | 49 1/2" | 15" | 3" | DP7CTTRR5015 | 657. | 678. | 711. | 724. | 743. | 756. | 771. | 788. | 87. |
| | 49 1/2" | 18" | 3" | DP7CTTRR5018 | 657. | 678. | 711. | 724. | 743. | 756. | 771. | 788. | 87. |
| | 49 1/2" | 24" | 3" | DP7CTTRR5024 | 710. | 729. | 769. | 779. | 806. | 816. | 831. | 852. | 90. |
| | 49 1/2" | 30" | 3" | DP7CTTRR5030 | 750. | 775. | 812. | 825. | 850. | 862. | 880. | 899. | 87. |
| | 49 1/2" | 36" | 3" | DP7CTTRR5036 | 799. | 820. | 859. | 878. | 898. | 916. | 932. | 957. | 81. |
| | 49 1/2" | 42" | 3" | DP7CTTRR5042 | 849. | 876. | 917. | 933. | 959. | 978. | 992. | 1,019. | 76. |
| | 49 1/2" | 48" | 3" | DP7CTTRR5048 | 894. | 922. | 965. | 987. | 1,010. | 1,031. | 1,048. | 1,074. | 74. |
| | 49 1/2" | 60" | 3" | DP7CTTRR5060 | 1,072. | 1,103. | 1,156. | 1,179. | 1,211. | 1,233. | 1,254. | 1,286. | 95. |

Dimensions listed under h w d are actual to the nearest 1/8"

| Ordering Information | Order Code | Included with: | Options |
|--|---|---|--|
| Tiled Panel with Standard Base Raceway: 1. Pattern Number 2. Top cap type 3. Top cap finish 4. Raceway knockout option 5. Raceway finish 6. Tile Support profile 7. Panel fabric | Tiled Panel with Standard Base Raceway <i>Example:</i> DP7CTTRR3618 4/117/K/117/2/B191 <hr/> DP7 Dividends Horizon Panel <hr/> C Topway frame <hr/> TT Tiled both sides <hr/> RR Base raceway <hr/> 36 Height <hr/> 18 Width <hr/> 4 Radius Metal top cap <hr/> 117 Soft Grey top cap finish <hr/> K Base raceway with knockouts both sides <hr/> 117 Soft Grey base raceway finish <hr/> 2 D2 style tile supports <hr/> B191 Fairfield light fabric | Tiled Panel with Standard Base Raceway: <ul style="list-style-type: none"> • Panel frame • Acoustic panel inserts • Base raceway covers • Top cap • Connection hardware | Tiled Panels with Standard Base Raceway: Full View Frame Option: To specify full view frame for window or stacking applications, replace the "C" in pattern number with "V". No upcharge. Monolithic Side Option: For one side tiled, one side monolithic, change "TT" in pattern number to "MT" and deduct amount in far right column. Top Cap Options: (2) = Extruded Plastic (Smooth Radius) (3) = No Top Cap (4) = Radius Metal, add \$40 P1, \$42 P2, \$44 P3 paint grades (5) = Flat Metal, add \$40 P1, \$42 P2, \$44 P3 paint grades Raceway Knockout Options: (K) = Knockouts (N) = No knockouts Tile Support Options: (1) = D1 External Reveal (2) = D2 Recessed Reveal |

Tiled Panels

Base Raceway

57", 64" and 78" High

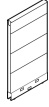
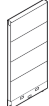
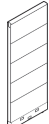
| description | h | w | d | pattern no. | grade | | | | | | | | deduct for Monolithic One Side |
|--|------------------------------------|-----|----|---------------------|--------|--------|--------|--------|--------|--------|--------|--------|--------------------------------|
| | | | | | 10 | 15 | 20 | 25 | 30 | 35 | 40 | 45 | |
|  57" High Tiled Standard Base Raceway | 56 ¹³ / ₁₆ " | 15" | 3" | DP7CTTRR5715 | \$801. | \$822. | \$862. | \$879. | \$902. | \$918. | \$935. | \$959. | \$109. |
| | 56 ¹³ / ₁₆ " | 18" | 3" | DP7CTTRR5718 | 801. | 822. | 862. | 879. | 902. | 918. | 935. | 959. | 109. |
| | 56 ¹³ / ₁₆ " | 24" | 3" | DP7CTTRR5724 | 859. | 884. | 927. | 944. | 968. | 988. | 1,004. | 1,032. | 113. |
| | 56 ¹³ / ₁₆ " | 30" | 3" | DP7CTTRR5730 | 909. | 936. | 984. | 997. | 1,029. | 1,045. | 1,064. | 1,092. | 116. |
| | 56 ¹³ / ₁₆ " | 36" | 3" | DP7CTTRR5736 | 965. | 994. | 1,043. | 1,064. | 1,093. | 1,111. | 1,129. | 1,162. | 118. |
| | 56 ¹³ / ₁₆ " | 42" | 3" | DP7CTTRR5742 | 1,024. | 1,056. | 1,104. | 1,126. | 1,155. | 1,177. | 1,198. | 1,226. | 121. |
| | 56 ¹³ / ₁₆ " | 48" | 3" | DP7CTTRR5748 | 1,081. | 1,114. | 1,168. | 1,188. | 1,220. | 1,242. | 1,263. | 1,298. | 123. |
| | 56 ¹³ / ₁₆ " | 60" | 3" | DP7CTTRR5760 | 1,298. | 1,334. | 1,400. | 1,426. | 1,464. | 1,492. | 1,516. | 1,555. | 125. |
|  64" High Tiled Standard Base Raceway | 64 ¹ / ₁₆ " | 15" | 3" | DP7CTTRR6415 | 847. | 873. | 914. | 930. | 957. | 970. | 990. | 1,015. | 131. |
| | 64 ¹ / ₁₆ " | 18" | 3" | DP7CTTRR6418 | 847. | 873. | 914. | 930. | 957. | 970. | 990. | 1,015. | 131. |
| | 64 ¹ / ₁₆ " | 24" | 3" | DP7CTTRR6424 | 909. | 934. | 984. | 996. | 1,025. | 1,043. | 1,063. | 1,092. | 138. |
| | 64 ¹ / ₁₆ " | 30" | 3" | DP7CTTRR6430 | 961. | 991. | 1,038. | 1,059. | 1,090. | 1,103. | 1,126. | 1,153. | 134. |
| | 64 ¹ / ₁₆ " | 36" | 3" | DP7CTTRR6436 | 1,021. | 1,056. | 1,102. | 1,125. | 1,153. | 1,176. | 1,194. | 1,225. | 135. |
| | 64 ¹ / ₁₆ " | 42" | 3" | DP7CTTRR6442 | 1,083. | 1,115. | 1,171. | 1,191. | 1,223. | 1,245. | 1,266. | 1,300. | 137. |
| | 64 ¹ / ₁₆ " | 48" | 3" | DP7CTTRR6448 | 1,142. | 1,176. | 1,230. | 1,254. | 1,289. | 1,314. | 1,334. | 1,368. | 138. |
| | 64 ¹ / ₁₆ " | 60" | 3" | DP7CTTRR6460 | 1,368. | 1,409. | 1,480. | 1,507. | 1,548. | 1,576. | 1,602. | 1,644. | 138. |
|  78" High Tiled Standard Base Raceway | 78 ⁷ / ₁₆ " | 15" | 3" | DP7CTTRR7815 | 1,330. | 1,368. | 1,436. | 1,462. | 1,501. | 1,530. | 1,556. | 1,595. | 235. |
| | 78 ⁷ / ₁₆ " | 18" | 3" | DP7CTTRR7818 | 1,330. | 1,368. | 1,436. | 1,462. | 1,501. | 1,530. | 1,556. | 1,595. | 235. |
| | 78 ⁷ / ₁₆ " | 24" | 3" | DP7CTTRR7824 | 1,430. | 1,471. | 1,545. | 1,572. | 1,618. | 1,645. | 1,672. | 1,718. | 243. |
| | 78 ⁷ / ₁₆ " | 30" | 3" | DP7CTTRR7830 | 1,516. | 1,561. | 1,634. | 1,667. | 1,713. | 1,741. | 1,774. | 1,816. | 237. |
| | 78 ⁷ / ₁₆ " | 36" | 3" | DP7CTTRR7836 | 1,620. | 1,669. | 1,749. | 1,780. | 1,831. | 1,864. | 1,896. | 1,944. | 258. |
| | 78 ⁷ / ₁₆ " | 42" | 3" | DP7CTTRR7842 | 1,718. | 1,769. | 1,852. | 1,888. | 1,941. | 1,973. | 2,009. | 2,060. | 263. |
| | 78 ⁷ / ₁₆ " | 48" | 3" | DP7CTTRR7848 | 1,819. | 1,876. | 1,967. | 2,005. | 2,058. | 2,095. | 2,131. | 2,184. | 315. |

Dimensions listed under h w d are actual to the nearest 1/8"

| Ordering Information | Order Code | Included with: | Options |
|--|---|--|--|
| Tiled Panel with Standard Base Raceway: 1. Pattern Number 2. Top cap type 3. Top cap finish 4. Raceway knockout option 5. Raceway finish 6. Tile support profile 7. Tile support finish 8. Panel fabric | Tiled Panel with Standard Base Raceway <i>Example:</i> DP7CTTRR3618 4/117/K/117/2/B191 DP7 Dividends Horizon Panel C Topway frame TT Tiled both sides RR Base raceway 36 Height 18 Width 4 Radius Metal top cap 117 Soft Grey top cap finish K Base raceway with knockouts both sides 117 Soft Grey base raceway finish 2 D2 style tile supports B191 Fairfield light fabric | Tiled Panel with Standard Base Raceway: <ul style="list-style-type: none"> Panel frame Acoustic panel inserts Base raceway covers Top cap Connection hardware | Tiled Panels with Standard Base Raceway: Full View Frame Option: To specify full view frame for window or stacking applications, replace the "C" in pattern number with "V". No upcharge. Monolithic Side Option: For one side tiled, one side monolithic, change "TT" in pattern number to "MT" and deduct amount in far right column. Top Cap Options: (2) = Extruded Plastic (Smooth Radius) (3) = No Top Cap (4) = Radius Metal, add \$40 P1, \$42 P2, \$44 P3 paint grades (5) = Flat Metal, add \$40 P1, \$42 P2, \$44 P3 paint grades Raceway Knockout Options: (K) = Knockouts (N) = No knockouts Tile Support Options: (1) = D1 External Reveal (2) = D2 Recessed Reveal |

Tiled Panels

Open Base

36", 42" and 50" High

Dividends Horizon

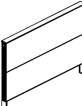
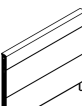
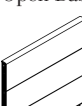
| description | h | w | d | pattern no. | 10 | 15 | 20 | 25 | 30 | 35 | 40 | 45 | Deduct for Monolithic One Side |
|--|----------|-----|----|---------------------|--------|--------|--------|--------|--------|--------|--------|--------|--------------------------------------|
| 36" High Tiled Open Base  | 35 1/8" | 18" | 3" | DP7CTTLL3618 | \$619. | \$636. | \$670. | \$681. | \$700. | \$711. | \$723. | \$742. | \$88. |
| | 35 1/8" | 24" | 3" | DP7CTTLL3624 | 657. | 678. | 711. | 724. | 743. | 756. | 771. | 788. | 89. |
| | 35 1/8" | 30" | 3" | DP7CTTLL3630 | 699. | 719. | 751. | 769. | 786. | 806. | 816. | 837. | 90. |
| | 35 1/8" | 36" | 3" | DP7CTTLL3636 | 764. | 783. | 823. | 843. | 861. | 880. | 893. | 916. | 92. |
| | 35 1/8" | 42" | 3" | DP7CTTLL3642 | 820. | 846. | 884. | 899. | 926. | 943. | 959. | 986. | 91. |
| | 35 1/8" | 48" | 3" | DP7CTTLL3648 | 859. | 884. | 928. | 947. | 969. | 989. | 1,004. | 1,033. | 93. |
| | 35 1/8" | 60" | 3" | DP7CTTLL3660 | 1,032. | 1,063. | 1,114. | 1,134. | 1,165. | 1,184. | 1,206. | 1,236. | 95. |
| 42" High Tiled Open Base  | 42 3/16" | 18" | 3" | DP7CTTLL4218 | 635. | 653. | 686. | 700. | 719. | 729. | 743. | 762. | 88. |
| | 42 3/16" | 24" | 3" | DP7CTTLL4224 | 675. | 695. | 727. | 742. | 761. | 775. | 787. | 810. | 89. |
| | 42 3/16" | 30" | 3" | DP7CTTLL4230 | 723. | 744. | 780. | 799. | 817. | 833. | 848. | 870. | 90. |
| | 42 3/16" | 36" | 3" | DP7CTTLL4236 | 775. | 801. | 837. | 853. | 876. | 890. | 908. | 928. | 92. |
| | 42 3/16" | 42" | 3" | DP7CTTLL4242 | 830. | 854. | 894. | 913. | 935. | 954. | 966. | 993. | 91. |
| | 42 3/16" | 48" | 3" | DP7CTTLL4248 | 874. | 898. | 944. | 961. | 988. | 1,002. | 1,021. | 1,049. | 93. |
| | 42 3/16" | 60" | 3" | DP7CTTLL4260 | 1,050. | 1,082. | 1,134. | 1,153. | 1,186. | 1,207. | 1,226. | 1,258. | 95. |
| 50" High Tiled Open Base  | 49 1/2" | 18" | 3" | DP7CTTLL5018 | 657. | 678. | 711. | 724. | 743. | 756. | 771. | 788. | 88. |
| | 49 1/2" | 24" | 3" | DP7CTTLL5024 | 710. | 729. | 769. | 779. | 806. | 816. | 831. | 852. | 90. |
| | 49 1/2" | 30" | 3" | DP7CTTLL5030 | 750. | 775. | 812. | 825. | 850. | 862. | 880. | 899. | 88. |
| | 49 1/2" | 36" | 3" | DP7CTTLL5036 | 799. | 820. | 859. | 878. | 898. | 916. | 932. | 957. | 81. |
| | 49 1/2" | 42" | 3" | DP7CTTLL5042 | 849. | 876. | 917. | 933. | 959. | 978. | 992. | 1,019. | 76. |
| | 49 1/2" | 48" | 3" | DP7CTTLL5048 | 894. | 922. | 965. | 987. | 1,010. | 1,031. | 1,048. | 1,074. | 74. |
| | 49 1/2" | 60" | 3" | DP7CTTLL5060 | 1,072. | 1,103. | 1,156. | 1,179. | 1,211. | 1,233. | 1,254. | 1,286. | 95. |

Dimensions listed under h w d are actual to the nearest 1/8"

Ordering Information

Tiled Panel with Open Base:

1. Pattern Number
2. Top cap type
3. Top Cap finish
4. Base finish
5. Tile support profile
6. Panel fabric

Order Code

Tiled Panel with Open Base

Example: **DP7CTTLL3618**
4/117/117/2/B191

| | |
|-------------|--------------------------|
| DP7 | Dividends Horizon Panel |
| C | Topway frame |
| TT | Tiled both sides |
| LL | Open base |
| 36 | Height |
| 18 | Width |
| 4 | Radius Metal top cap |
| 117 | Soft Grey top cap finish |
| 117 | Soft Grey base finish |
| 2 | D2 style tile supports |
| B191 | Fairfield light fabric |

Included with:

Tiled Panel with Open Base:

- Panel frame
- Acoustic panel inserts
- Open base
- Top cap
- Connection hardware

Options

Tiled Panel with Open Base:

Full View Frame Option:

To specify full view frame for window or stacking applications, replace the "C" in pattern number with "V". No upcharge.

Monolithic Side Option:

For one side tiled, one side monolithic, change "TT" in pattern number to "MT" and deduct amount in far right column.

Top Cap Options:

- (2) = Extruded Plastic (Smooth Radius)
- (3) = No Top Cap
- (4) = Radius Metal, add \$40 P1, \$42 P2, \$44 P3 paint grades
- (5) = Flat Metal, add \$40 P1, \$42 P2, \$44 P3 paint grades

Tile Support Options:

- (1) = D1 External Reveal
- (2) = D2 Recessed Reveal

Tiled Panels

Open Base

57", 64" and 78" High

Dividends Horizon

Panels, Pre-Configured

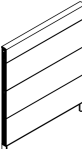
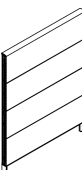
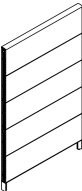
| description | h | w | d | pattern no. | 10 | 15 | 20 | 25 | 30 | 35 | 40 | 45 | deduct for Monolithic One Side |
|--|------------------------------------|-----|----|---------------------|--------|--------|--------|--------|--------|--------|--------|--------|--------------------------------|
| 57" High Tiled Open Base  | 56 ¹³ / ₁₆ " | 18" | 3" | DP7CTTLL5718 | \$801. | \$822. | \$862. | \$879. | \$902. | \$918. | \$935. | \$959. | \$109. |
| | 56 ¹³ / ₁₆ " | 24" | 3" | DP7CTTLL5724 | 859. | 884. | 927. | 944. | 968. | 988. | 1,004. | 1,032. | 113. |
| | 56 ¹³ / ₁₆ " | 30" | 3" | DP7CTTLL5730 | 909. | 936. | 984. | 997. | 1,029. | 1,045. | 1,064. | 1,092. | 116. |
| | 56 ¹³ / ₁₆ " | 36" | 3" | DP7CTTLL5736 | 965. | 994. | 1,043. | 1,064. | 1,093. | 1,111. | 1,129. | 1,162. | 118. |
| | 56 ¹³ / ₁₆ " | 42" | 3" | DP7CTTLL5742 | 1,024. | 1,056. | 1,104. | 1,126. | 1,155. | 1,177. | 1,198. | 1,226. | 121. |
| | 56 ¹³ / ₁₆ " | 48" | 3" | DP7CTTLL5748 | 1,081. | 1,114. | 1,168. | 1,188. | 1,220. | 1,242. | 1,263. | 1,298. | 123. |
| | 56 ¹³ / ₁₆ " | 60" | 3" | DP7CTTLL5760 | 1,298. | 1,334. | 1,400. | 1,426. | 1,464. | 1,492. | 1,516. | 1,555. | 125. |
| 64" High Tiled Open Base  | 64 ¹ / ₁₆ " | 18" | 3" | DP7CTTLL6418 | 847. | 873. | 914. | 930. | 957. | 970. | 990. | 1,015. | 131. |
| | 64 ¹ / ₁₆ " | 24" | 3" | DP7CTTLL6424 | 909. | 934. | 984. | 996. | 1,025. | 1,043. | 1,063. | 1,092. | 138. |
| | 64 ¹ / ₁₆ " | 30" | 3" | DP7CTTLL6430 | 961. | 991. | 1,038. | 1,059. | 1,090. | 1,103. | 1,126. | 1,153. | 134. |
| | 64 ¹ / ₁₆ " | 36" | 3" | DP7CTTLL6436 | 1,021. | 1,056. | 1,102. | 1,125. | 1,153. | 1,176. | 1,194. | 1,225. | 135. |
| | 64 ¹ / ₁₆ " | 42" | 3" | DP7CTTLL6442 | 1,083. | 1,115. | 1,171. | 1,191. | 1,223. | 1,245. | 1,266. | 1,300. | 137. |
| | 64 ¹ / ₁₆ " | 48" | 3" | DP7CTTLL6448 | 1,142. | 1,176. | 1,230. | 1,254. | 1,289. | 1,314. | 1,334. | 1,368. | 138. |
| | 64 ¹ / ₁₆ " | 60" | 3" | DP7CTTLL6460 | 1,368. | 1,409. | 1,480. | 1,507. | 1,548. | 1,576. | 1,602. | 1,644. | 138. |
| 78" High Tiled Open Base  | 78 ⁹ / ₁₆ " | 18" | 3" | DP7CTTLL7818 | 1,330. | 1,368. | 1,436. | 1,462. | 1,501. | 1,530. | 1,556. | 1,595. | 235. |
| | 78 ⁹ / ₁₆ " | 24" | 3" | DP7CTTLL7824 | 1,430. | 1,471. | 1,545. | 1,572. | 1,618. | 1,645. | 1,672. | 1,718. | 243. |
| | 78 ⁹ / ₁₆ " | 30" | 3" | DP7CTTLL7830 | 1,516. | 1,561. | 1,634. | 1,667. | 1,713. | 1,741. | 1,774. | 1,816. | 237. |
| | 78 ⁹ / ₁₆ " | 36" | 3" | DP7CTTLL7836 | 1,620. | 1,669. | 1,749. | 1,780. | 1,831. | 1,864. | 1,896. | 1,944. | 258. |
| | 78 ⁹ / ₁₆ " | 42" | 3" | DP7CTTLL7842 | 1,718. | 1,769. | 1,852. | 1,888. | 1,941. | 1,973. | 2,009. | 2,060. | 263. |
| | 78 ⁹ / ₁₆ " | 48" | 3" | DP7CTTLL7848 | 1,819. | 1,876. | 1,967. | 2,005. | 2,058. | 2,095. | 2,131. | 2,184. | 315. |

Dimensions listed under h w d are actual to the nearest 1/8"

Ordering Information

Tiled Panel with Open Base:

1. Pattern Number
2. Top cap type
3. Top Cap finish
4. Base finish
5. Tile support profile
6. Panel fabric

Order Code

Tiled Panel with Open Base

Example: **DP7CTTLL3618**
4/117/117/2/B191

| | |
|-------------|--------------------------|
| DP7 | Dividends Horizon Panel |
| C | Topway frame |
| TT | Tiled both sides |
| LL | Open base |
| 36 | Height |
| 18 | Width |
| 4 | Radius Metal top cap |
| 117 | Soft Grey top cap finish |
| 117 | Soft Grey base finish |
| 2 | D2 style tile supports |
| B191 | Fairfield light fabric |

Included with:

Tiled Panel with Open Base:

- Panel frame
- Acoustic panel inserts
- Open base
- Top cap
- Connection hardware

Options

Tiled Panel with Open Base:

Full View Frame Option:

To specify full view frame for window or stacking applications, replace the "C" in pattern number with "V". No upcharge.

Monolithic Side Option:

For one side tiled, one side monolithic, change "TT" in pattern number to "MT" and deduct amount in far right column.

Top Cap Options:

- (2) = Extruded Plastic (Smooth Radius)
- (3) = No Top Cap
- (4) = Radius Metal, add \$40 P1, \$42 P2, \$44 P3 paint grades
- (5) = Flat Metal, add \$40 P1, \$42 P2, \$44 P3 paint grades

Tile Support Options:

- (1) = D1 External Reveal
- (2) = D2 Recessed Reveal

Tiled Panels

Tile To Floor One Side

36" and 42" High

Dividends Horizon

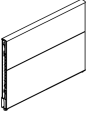
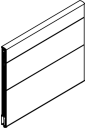
| description | h | w | d | pattern no. | | | | | | | | | Deduct for |
|--|----------|-----|----|---------------------|--------|--------|--------|--------|--------|--------|--------|--------|--------------------------|
| | | | | | 10 | 15 | 20 | 25 | 30 | 35 | 40 | 45 | Monolithic One Sideide 1 |
| 36" High Tiled Panel Tile to Floor One Side  | 35 1/8" | 15" | 3" | DP7CTTFR3615 | \$653. | \$670. | \$704. | \$715. | \$734. | \$745. | \$757. | \$776. | \$88. |
| | 35 1/8" | 18" | 3" | DP7CTTFR3618 | 653. | 670. | 704. | 715. | 734. | 745. | 757. | 776. | 88. |
| | 35 1/8" | 24" | 3" | DP7CTTFR3624 | 691. | 712. | 745. | 758. | 777. | 790. | 805. | 822. | 89. |
| | 35 1/8" | 30" | 3" | DP7CTTFR3630 | 733. | 753. | 785. | 803. | 820. | 840. | 850. | 871. | 90. |
| | 35 1/8" | 36" | 3" | DP7CTTFR3636 | 798. | 817. | 857. | 877. | 895. | 914. | 927. | 950. | 92. |
| | 35 1/8" | 42" | 3" | DP7CTTFR3642 | 854. | 880. | 918. | 933. | 960. | 977. | 993. | 1,020. | 91. |
| | 35 1/8" | 48" | 3" | DP7CTTFR3648 | 893. | 918. | 962. | 981. | 1,003. | 1,023. | 1,038. | 1,067. | 93. |
| | 35 1/8" | 60" | 3" | DP7CTTFR3660 | 1,066. | 1,097. | 1,148. | 1,168. | 1,199. | 1,218. | 1,240. | 1,270. | 95. |
| 42" High Tiled Panel Tile to Floor One Side  | 42 3/16" | 15" | 3" | DP7CTTFR4215 | 669. | 687. | 720. | 734. | 753. | 763. | 777. | 796. | 88. |
| | 42 3/16" | 18" | 3" | DP7CTTFR4218 | 669. | 687. | 720. | 734. | 753. | 763. | 777. | 796. | 88. |
| | 42 3/16" | 24" | 3" | DP7CTTFR4224 | 709. | 729. | 761. | 776. | 795. | 809. | 821. | 844. | 89. |
| | 42 3/16" | 30" | 3" | DP7CTTFR4230 | 757. | 778. | 814. | 833. | 851. | 867. | 882. | 904. | 90. |
| | 42 3/16" | 36" | 3" | DP7CTTFR4236 | 809. | 835. | 871. | 887. | 910. | 924. | 942. | 962. | 92. |
| | 42 3/16" | 42" | 3" | DP7CTTFR4242 | 864. | 888. | 928. | 947. | 969. | 988. | 1,000. | 1,027. | 91. |
| | 42 3/16" | 48" | 3" | DP7CTTFR4248 | 908. | 932. | 978. | 995. | 1,022. | 1,036. | 1,055. | 1,083. | 93. |
| | 42 3/16" | 60" | 3" | DP7CTTFR4260 | 1,084. | 1,116. | 1,168. | 1,187. | 1,220. | 1,241. | 1,260. | 1,292. | 95. |

Dimensions listed under h w d are actual to the nearest 1/8"

| Ordering Information | Order Code | Included with: | Options |
|---|---|---|--|
| Tiled Panel with Tile to Floor: 1. Pattern Number 2. Top cap type 3. Top cap finish 4. Base raceway finish 5. Tile support profile 6. Panel fabric | Tiled Panel with Tile to Floor <i>Example:</i> DP7CTTFR3618 4/117/K/117/2/B191 <hr/> DP7 Dividends Horizon Panel <hr/> C Topway frame <hr/> TT Tiled both sides <hr/> FR Tile to floor side one, raceway side two <hr/> 36 Height <hr/> 18 Width <hr/> 4 Radius Metal top cap <hr/> 117 Soft Grey top cap finish <hr/> K Knockouts for one-sided base raceway <hr/> 117 Soft Grey base raceway finish <hr/> 2 D2 style tile supports <hr/> B191 Fairfield light fabric | Tiled Panel with Tile to Floor: <ul style="list-style-type: none"> Panel frame Acoustic panel inserts Top cap Connection hardware Base raceway with knockout one side Tile to the floor one side | Tiled Panels With Tile To Floor One Side: Full View Frame Option: To specify full view frame for window or stacking applications, replace the "C" in pattern number with "V". No upcharge. Monolithic Side Option: For side 1 monolithic, side 2 tiled, change "TT" in pattern number to "MT" and deduct amount in far right column. Tile to Floor Side Option: Tile to floor standard on side 2. To specify tile to floor on side 1, change "FR" in pattern number to "RF". Top Cap Options: (2) = Extruded Plastic (Smooth Radius) (3) = No Top Cap (4) = Radius Metal, add \$40 P1, \$42 P2, \$44 P3 paint grades (5) = Flat Metal, add \$40 P1, \$42 P2, \$44 P3 paint grades Raceway Knockout Options: (K) = Knockouts on raceway side (N) = No knockouts on raceway side Tile Support Options: (1) = D1 External Reveal (2) = D2 Recessed Reveal |

Tiled Panels

Tile To Floor One Side

50" and 57" High

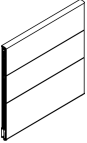
| description | h | w | d | pattern no. | grade | | | | | | | | deduct for Monolithic One Side |
|--|---------|-----|----|---------------------|--------|--------|--------|--------|--------|--------|--------|--------|--------------------------------|
| | | | | | 10 | 15 | 20 | 25 | 30 | 35 | 40 | 45 | |
| 50" High Tiled Panel Tile to Floor One Side  | 49 1/2" | 15" | 3" | DP7CTTFR5015 | \$691. | \$712. | \$745. | \$758. | \$777. | \$790. | \$805. | \$822. | \$87. |
| | 49 1/2" | 18" | 3" | DP7CTTFR5018 | 691. | 712. | 745. | 758. | 777. | 790. | 804. | 822. | 87. |
| | 49 1/2" | 24" | 3" | DP7CTTFR5024 | 744. | 763. | 803. | 813. | 840. | 850. | 865. | 886. | 90. |
| | 49 1/2" | 30" | 3" | DP7CTTFR5030 | 784. | 809. | 846. | 859. | 884. | 896. | 914. | 933. | 87. |
| | 49 1/2" | 36" | 3" | DP7CTTFR5036 | 833. | 854. | 893. | 912. | 932. | 950. | 966. | 991. | 81. |
| | 49 1/2" | 42" | 3" | DP7CTTFR5042 | 883. | 910. | 951. | 967. | 993. | 1,012. | 1,026. | 1,053. | 76. |
| | 49 1/2" | 48" | 3" | DP7CTTFR5048 | 928. | 956. | 999. | 1,021. | 1,044. | 1,065. | 1,082. | 1,108. | 74. |
| | 49 1/2" | 60" | 3" | DP7CTTFR5060 | 1,106. | 1,137. | 1,190. | 1,213. | 1,245. | 1,267. | 1,288. | 1,320. | 95. |

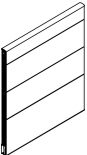
| | | | | | | | | | | | | | |
|--|-----------|-----|----|---------------------|--------|--------|--------|--------|--------|--------|--------|--------|------|
| 57" High Tiled Panel Tile to Floor One Side  | 56 13/16" | 15" | 3" | DP7CTTFR5715 | 835. | 856. | 896. | 912. | 936. | 952. | 969. | 933. | 109. |
| | 56 13/16" | 18" | 3" | DP7CTTFR5718 | 835. | 856. | 896. | 913. | 936. | 952. | 969. | 993. | 109. |
| | 56 13/16" | 24" | 3" | DP7CTTFR5724 | 893. | 918. | 961. | 978. | 1,002. | 1,022. | 1,038. | 1,066. | 113. |
| | 56 13/16" | 30" | 3" | DP7CTTFR5730 | 943. | 970. | 1,018. | 1,031. | 1,063. | 1,079. | 1,098. | 1,126. | 116. |
| | 56 13/16" | 36" | 3" | DP7CTTFR5736 | 999. | 1,028. | 1,077. | 1,098. | 1,127. | 1,145. | 1,163. | 1,196. | 118. |
| | 56 13/16" | 42" | 3" | DP7CTTFR5742 | 1,058. | 1,090. | 1,138. | 1,160. | 1,189. | 1,211. | 1,232. | 1,260. | 121. |
| | 56 13/16" | 48" | 3" | DP7CTTFR5748 | 1,115. | 1,148. | 1,202. | 1,222. | 1,254. | 1,276. | 1,297. | 1,332. | 123. |
| | 56 13/16" | 60" | 3" | DP7CTTFR5760 | 1,332. | 1,368. | 1,434. | 1,460. | 1,498. | 1,526. | 1,550. | 1,589. | 125. |

Dimensions listed under h w d are actual to the nearest 1/8"

| Ordering Information | Order Code | Included with: | Options |
|---|---|---|---|
| Tiled Panel with Tile to Floor: 1. Pattern Number 2. Top cap type 3. Top cap finish 4. Base raceway finish 5. Tile support profile 6. Panel fabric | Tiled Panel with Tile to Floor <i>Example:</i> DP7CTTFR5018 4/117/K/117/2/B191 <hr/> DP7 Dividends Horizon Panel <hr/> C Topway frame <hr/> TT Tiled both sides <hr/> FR Tile to floor side one, raceway side two <hr/> 50 Height <hr/> 18 Width <hr/> 4 Radius Metal top cap <hr/> 117 Soft Grey top cap finish <hr/> K Knockouts for one-sided base raceway <hr/> 117 Soft Grey base raceway finish <hr/> 2 D2 style tile supports <hr/> B191 Fairfield light fabric | Tiled Panel with Tile to Floor: <ul style="list-style-type: none"> Panel frame Acoustic panel inserts Top cap Connection hardware Base raceway with knockout one side Tile to the floor one side | Tiled Panels With Tile To Floor One Side: Full View Frame Option: To specify full view frame for window or stacking applications, replace the "C" in pattern number with "V". No upcharge. Monolithic Side Options: For side 1 monolithic, side 2 tiled, change "TT" in pattern number to "MT" and deduct amount in far right column. Tile to Floor Side Option: Tile to floor standard on side 2. To specify tile to floor on side 1, change "FR" in pattern number to "RF". Top Cap Options: (2) = Extruded Plastic (Smooth Radius) (3) = No Top Cap (4) = Radius Metal, add \$40 P1, \$42 P2, \$44 P3 paint grades (5) = Flat Metal, add \$40 P1, \$42 P2, \$44 P3 paint grades Raceway Knockout Options: (K) = Knockouts on raceway side (N) = No knockouts on raceway side Tile Support Options: (1) = D1 External Reveal (2) = D2 Recessed Reveal |

Tiled Panels

Tile To Floor One Side

64" and 78" High

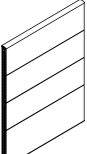
| description | h | w | d | pattern no. | grade | | | | | | | | deduct for Monolithic One Side |
|--|----------|-----|----|---------------------|--------|--------|--------|--------|--------|----------|----------|----------|--------------------------------|
| | | | | | 10 | 15 | 20 | 25 | 30 | 35 | 40 | 45 | |
| 64" High Tiled Panel Tile to Floor One Side  | 64 1/16" | 15" | 3" | DP7CTTFR6415 | \$881. | \$907. | \$948. | \$964. | \$991. | \$1,004. | \$1,024. | \$1,049. | \$131. |
| | 64 1/16" | 18" | 3" | DP7CTTFR6418 | 881. | 907. | 948. | 964. | 991. | 1,004. | 1,024. | 1,049. | 131. |
| | 64 1/16" | 24" | 3" | DP7CTTFR6424 | 943. | 968. | 1,018. | 1,030. | 1,059. | 1,077. | 1,097. | 1,126. | 138. |
| | 64 1/16" | 30" | 3" | DP7CTTFR6430 | 995. | 1,025. | 1,072. | 1,093. | 1,124. | 1,137. | 1,160. | 1,187. | 134. |
| | 64 1/16" | 36" | 3" | DP7CTTFR6436 | 1,055. | 1,090. | 1,136. | 1,159. | 1,187. | 1,210. | 1,228. | 1,259. | 135. |
| | 64 1/16" | 42" | 3" | DP7CTTFR6442 | 1,117. | 1,149. | 1,205. | 1,225. | 1,257. | 1,279. | 1,330. | 1,334. | 137. |
| | 64 1/16" | 48" | 3" | DP7CTTFR6448 | 1,176. | 1,210. | 1,264. | 1,288. | 1,323. | 1,348. | 1,368. | 1,402. | 138. |
| | 64 1/16" | 60" | 3" | DP7CTTFR6460 | 1,402. | 1,443. | 1,514. | 1,541. | 1,582. | 1,610. | 1,636. | 1,678. | 138. |

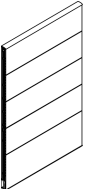
| | | | | | | | | | | | | | |
|--|----------|-----|----|---------------------|--------|--------|--------|--------|--------|--------|--------|--------|------|
| 78" High Tiled Panel Tile to Floor One Side  | 78 1/16" | 15" | 3" | DP7CTTFR7815 | 1,364. | 1,402. | 1,470. | 1,496. | 1,535. | 1,564. | 1,590. | 1,629. | 235. |
| | 78 1/16" | 18" | 3" | DP7CTTFR7818 | 1,364. | 1,402. | 1,470. | 1,496. | 1,535. | 1,564. | 1,590. | 1,629. | 235. |
| | 78 1/16" | 24" | 3" | DP7CTTFR7824 | 1,464. | 1,505. | 1,579. | 1,606. | 1,652. | 1,679. | 1,706. | 1,752. | 243. |
| | 78 1/16" | 30" | 3" | DP7CTTFR7830 | 1,550. | 1,595. | 1,668. | 1,701. | 1,747. | 1,775. | 1,808. | 1,850. | 237. |
| | 78 1/16" | 36" | 3" | DP7CTTFR7836 | 1,654. | 1,703. | 1,783. | 1,814. | 1,865. | 1,898. | 1,930. | 1,978. | 258. |
| | 78 1/16" | 42" | 3" | DP7CTTFR7842 | 1,752. | 1,803. | 1,886. | 1,922. | 1,975. | 2,007. | 2,043. | 2,094. | 263. |
| | 78 1/16" | 48" | 3" | DP7CTTFR7848 | 1,853. | 1,910. | 2,001. | 2,039. | 2,092. | 2,129. | 2,165. | 2,218. | 315. |

Dimensions listed under h w d are actual to the nearest 1/8"

| Ordering Information | Order Code | Included with: | Options |
|---|---|---|---|
| Tiled Panel with Tile to Floor: 1. Pattern Number 2. Top cap type 3. Top cap finish 4. Base raceway finish 5. Tile support profile 6. Panel fabric | Tiled Panel with Tile to Floor <i>Example:</i> DP7CTTFR6418 4/117/K/117/2/B191 <hr/> DP7 Dividends Horizon Panel <hr/> C Topway frame <hr/> TT Tiled both sides <hr/> FR Tile to floor side one, raceway side two <hr/> 64 Height <hr/> 18 Width <hr/> 4 Radius Metal top cap <hr/> 117 Soft Grey top cap finish <hr/> K Knockouts for one-sided base raceway <hr/> 117 Soft Grey base raceway finish <hr/> 2 D2 style tile supports <hr/> B191 Fairfield light fabric | Tiled Panel with Tile to Floor: <ul style="list-style-type: none"> Panel frame Acoustic panel inserts Top cap Connection hardware Base raceway with knockout one side Tile to the floor one side | Tiled Panels With Tile To Floor One Side: Full View Frame Option: To specify full view frame for window or stacking applications, replace the "C" in pattern number with "V". No upcharge. Monolithic Side Options: For side 1 monolithic, side 2 tiled, change "TT" in pattern number to "MT" and deduct amount in far right column. Tile to Floor Side Option: Tile to floor standard on side 2. To specify tile to floor on side 1, change "FR" in pattern number to "RF". Top Cap Options: (2) = Extruded Plastic (Smooth Radius) (3) = No Top Cap (4) = Radius Metal, add \$40 P1, \$42 P2, \$44 P3 paint grades (5) = Flat Metal, add \$40 P1, \$42 P2, \$44 P3 paint grades Raceway Knockout Options: (K) = Knockouts on raceway side (N) = No knockouts on raceway side Tile Support Options: (1) = D1 External Reveal (2) = D2 Recessed Reveal |

Tiled Panels

28" Lower Tile and Base Raceway

42" and 50" High

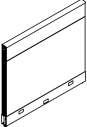
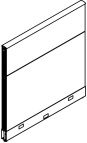
| description | h | w | d | pattern no. | grade | | | | | | | | Deduct for Monolithic One Side |
|--|----------|-----|----|---------------------|--------|--------|--------|--------|--------|--------|--------|--------|--------------------------------|
| | | | | | 10 | 15 | 20 | 25 | 30 | 35 | 40 | 45 | |
| 42" High Tiled Panel with 28" Lower Tile and Base Raceway  | 42 3/16" | 15" | 3" | DP7CPPRR4215 | \$575. | \$592. | \$623. | \$638. | \$655. | \$669. | \$682. | \$700. | \$59. |
| | 42 3/16" | 18" | 3" | DP7CPPRR4218 | 575. | 592. | 623. | 638. | 655. | 669. | 682. | 700. | 59. |
| | 42 3/16" | 24" | 3" | DP7CPPRR4224 | 613. | 633. | 667. | 681. | 699. | 713. | 725. | 746. | 59. |
| | 42 3/16" | 30" | 3" | DP7CPPRR4230 | 661. | 683. | 720. | 735. | 753. | 771. | 782. | 809. | 62. |
| | 42 3/16" | 36" | 3" | DP7CPPRR4236 | 713. | 737. | 775. | 789. | 814. | 829. | 847. | 865. | 62. |
| | 42 3/16" | 42" | 3" | DP7CPPRR4242 | 766. | 791. | 832. | 851. | 873. | 890. | 905. | 932. | 62. |
| | 42 3/16" | 48" | 3" | DP7CPPRR4248 | 812. | 835. | 882. | 899. | 926. | 940. | 960. | 987. | 63. |
| | 42 3/16" | 60" | 3" | DP7CPPRR4260 | 988. | 1,018. | 1,071. | 1,093. | 1,123. | 1,144. | 1,167. | 1,197. | 64. |
| 50" High Tiled Panel with 28" Lower Tile and Base Raceway  | 49 1/2" | 15" | 3" | DP7CPPRR5015 | 596. | 617. | 648. | 662. | 682. | 694. | 709. | 726. | 58. |
| | 49 1/2" | 18" | 3" | DP7CPPRR5018 | 596. | 617. | 648. | 662. | 682. | 694. | 709. | 726. | 58. |
| | 49 1/2" | 24" | 3" | DP7CPPRR5024 | 647. | 669. | 707. | 719. | 742. | 752. | 769. | 788. | 60. |
| | 49 1/2" | 30" | 3" | DP7CPPRR5030 | 688. | 713. | 748. | 762. | 786. | 802. | 818. | 836. | 58. |
| | 49 1/2" | 36" | 3" | DP7CPPRR5036 | 735. | 756. | 799. | 816. | 835. | 854. | 869. | 894. | 54. |
| | 49 1/2" | 42" | 3" | DP7CPPRR5042 | 783. | 814. | 855. | 870. | 896. | 915. | 930. | 958. | 50. |
| | 49 1/2" | 48" | 3" | DP7CPPRR5048 | 832. | 859. | 904. | 925. | 951. | 965. | 986. | 1,010. | 49. |
| | 49 1/2" | 60" | 3" | DP7CPPRR5060 | 1,008. | 1,042. | 1,096. | 1,117. | 1,148. | 1,172. | 1,191. | 1,223. | 64. |

Dimensions listed under h w d are actual to the nearest 1/8"

| Ordering Information | Order Code | Included with: | Options |
|---|--|--|---|
| Tiled Panel with 28" Lower Tile and Base Raceway: 1. Pattern Number 2. Top cap type 3. Top cap finish 4. Raceway knockout option 5. Raceway trim finish 6. Tile support profile 7. Panel fabric | Tiled Panels with 28" Lower Tile and Base Raceway <hr/> <i>Example:</i> DP7CPPRR4218 4/117/K/117/2/B191 <hr/> DP7 Dividends Horizon Panel <hr/> C Topway frame <hr/> PP Tiled both sides, 28" Lower Tile <hr/> RR Raceway both sides <hr/> 42 Height <hr/> 18 Width <hr/> 4 Radius Metal top cap <hr/> 117 Soft Grey top cap finish <hr/> K Base raceway with knockouts both sides <hr/> 117 Soft Grey base raceway finish <hr/> 2 D2 style tile supports <hr/> B191 Fairfield light fabric | Tiled Panel with Standard Base Raceway and 28" Base Tile: <ul style="list-style-type: none"> • Panel frame • Acoustic panel inserts • Base raceway covers • Top cap • Connection hardware | Tiled Panel with 28" Lower Tile and Base Raceway: Full View Frame Option: To specify full view frame for window or stacking applications, replace the "C" in pattern number with "V". No upcharge. Monolithic Side Option: For side 1 monolithic, side 2 tiled, change "PP" in pattern number to "MP" and deduct amount in far right column. Top Cap Options: (2) = Extruded Plastic (Smooth Radius) (3) = No Top Cap (4) = Radius Metal, add \$40 P1, \$42 P2, \$44 P3 paint grades (5) = Flat Metal, add \$40 P1, \$42 P2, \$44 P3 paint grades Raceway Knockout Options: (K) = Knockouts on raceway side (N) = No knockouts Tile Support Options: (1) = D1 External Reveal (2) = D2 Recessed Reveal |

Tiled Panels

28" Lower Tile and Base Raceway

57" and 64" High

| description | h | w | d | pattern no. | grade | | | | | | | | Deduct for Monolithic One Side |
|---|----------------------|-----|----|---------------------|--------|--------|--------|--------|--------|--------|--------|--------|--------------------------------|
| | | | | | 10 | 15 | 20 | 25 | 30 | 35 | 40 | 45 | |
| 57" High Tiled Panel with 28" Lower Tile and Base Raceway | 56 ^{13/16"} | 15" | 3" | DP7CPPRR5715 | \$737. | \$758. | \$802. | \$817. | \$840. | \$856. | \$873. | \$896. | \$73. |
| | 56 ^{13/16"} | 18" | 3" | DP7CPPRR5718 | 737. | 758. | 802. | 817. | 840. | 856. | 873. | 896. | 73. |
| | 56 ^{13/16"} | 24" | 3" | DP7CPPRR5724 | 799. | 823. | 863. | 882. | 908. | 926. | 942. | 966. | 76. |
| | 56 ^{13/16"} | 30" | 3" | DP7CPPRR5730 | 848. | 874. | 921. | 936. | 963. | 984. | 1,000. | 1,031. | 78. |
| | 56 ^{13/16"} | 36" | 3" | DP7CPPRR5736 | 904. | 933. | 981. | 1,000. | 1,032. | 1,049. | 1,067. | 1,097. | 79. |
| | 56 ^{13/16"} | 42" | 3" | DP7CPPRR5742 | 961. | 991. | 1,043. | 1,064. | 1,095. | 1,115. | 1,136. | 1,167. | 81. |
| | 56 ^{13/16"} | 48" | 3" | DP7CPPRR5748 | 1,016. | 1,051. | 1,103. | 1,126. | 1,156. | 1,179. | 1,201. | 1,234. | 82. |
| | 56 ^{13/16"} | 60" | 3" | DP7CPPRR5760 | 1,234. | 1,275. | 1,335. | 1,362. | 1,403. | 1,429. | 1,455. | 1,493. | 85. |

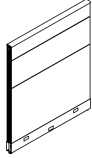

| | | | | | | | | | | | | | |
|---|---------------------|-----|----|---------------------|--------|--------|--------|--------|--------|--------|--------|--------|-----|
| 64" High Tiled Panel with 28" Lower Tile and Base Raceway | 64 ^{1/16"} | 15" | 3" | DP7CPPRR6415 | 781. | 811. | 852. | 868. | 894. | 911. | 928. | 955. | 89. |
| | 64 ^{1/16"} | 18" | 3" | DP7CPPRR6418 | 781. | 811. | 852. | 868. | 894. | 911. | 928. | 955. | 89. |
| | 64 ^{1/16"} | 24" | 3" | DP7CPPRR6424 | 848. | 872. | 921. | 935. | 962. | 981. | 999. | 1,031. | 93. |
| | 64 ^{1/16"} | 30" | 3" | DP7CPPRR6430 | 899. | 929. | 973. | 994. | 1,029. | 1,042. | 1,064. | 1,093. | 90. |
| | 64 ^{1/16"} | 36" | 3" | DP7CPPRR6436 | 960. | 991. | 1,041. | 1,063. | 1,093. | 1,114. | 1,134. | 1,166. | 91. |
| | 64 ^{1/16"} | 42" | 3" | DP7CPPRR6442 | 1,019. | 1,055. | 1,108. | 1,129. | 1,164. | 1,182. | 1,203. | 1,237. | 92. |
| | 64 ^{1/16"} | 48" | 3" | DP7CPPRR6448 | 1,081. | 1,114. | 1,171. | 1,191. | 1,225. | 1,251. | 1,275. | 1,308. | 93. |
| | 64 ^{1/16"} | 60" | 3" | DP7CPPRR6460 | 1,308. | 1,349. | 1,418. | 1,444. | 1,486. | 1,513. | 1,540. | 1,581. | 93. |

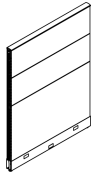

Dimensions listed under h w d are actual to the nearest 1/8"

| Ordering Information | Order Code | Included with: | Options |
|---|---|---|--|
| Tiled Panel with 28" Lower Tile and Base Raceway: 1. Pattern Number 2. Top cap type 3. Top cap finish 4. Raceway knockout option 5. Raceway trim finish 6. Tile support style 7. Panel fabric | Tiled Panels with 28" Lower Tile and Base Raceway <i>Example:</i> DP7CPPRR5718 4/117/K/117/2/B191 DP7 Dividends Horizon Panel C Topway frame PP Tiled both sides, 28" Lower Tile RR Raceway both sides 57 Height 18 Width 4 Radius Metal top cap 117 Soft Grey top cap finish K Base raceway with knockouts both sides 117 Soft Grey base raceway finish 2 D2 style tile support B191 Fairfield light fabric | Tiled Panel with Standard Base Raceway and 28" Base Tile: <ul style="list-style-type: none"> • Panel frame • Acoustic panel inserts • Base raceway covers • Top cap • Connection hardware | Tiled Panels with 28" Lower Tile and Base Raceway: Full View Frame Option: To specify full view frame for window or stacking applications, replace the "C" in pattern number with "V". No upcharge. Monolithic Side Option: For side 1 monolithic, side 2 tiled, change "PP" in pattern number to "MP" and deduct amount in far right column. Top Cap Options: (2) = Extruded Plastic (Smooth Radius) (3) = No Top Cap (4) = Radius Metal, add \$40 P1, \$42 P2, \$44 P3 paint grades (5) = Flat Metal, add \$40 P1, \$42 P2, \$44 P3 paint grades Raceway Knockout Options: (K) = Knockouts on raceway side (N) = No knockouts Tile Support Options: (1) = D1 External Reveal (2) = D2 Recessed Reveal |

Tiled Panels

28" Lower Tile and Base Raceway

78" High

| description | h | w | d | pattern no. | grade | | | | | | | | deduct for Monolithic One Side |
|---|-----------------------------------|-----|----|--------------------|----------|----------|----------|----------|----------|----------|----------|----------|--------------------------------|
| | | | | | 10 | 15 | 20 | 25 | 30 | 35 | 40 | 45 | |
| 78" High Tiled Panel with 28" Lower Tile and Base Raceway | 78 ¹ / ₁₆ " | 15" | 3" | DP7CPRR7815 | \$1,271. | \$1,308. | \$1,373. | \$1,401. | \$1,438. | \$1,465. | \$1,494. | \$1,535. | \$158. |
| | 78 ¹ / ₁₆ " | 18" | 3" | DP7CPRR7818 | 1,271. | 1,308. | 1,373. | 1,401. | 1,438. | 1,465. | 1,494. | 1,535. | 158. |
| | 78 ¹ / ₁₆ " | 24" | 3" | DP7CPRR7824 | 1,367. | 1,409. | 1,484. | 1,510. | 1,556. | 1,582. | 1,609. | 1,655. | 163. |
| | 78 ¹ / ₁₆ " | 30" | 3" | DP7CPRR7830 | 1,455. | 1,499. | 1,572. | 1,604. | 1,649. | 1,680. | 1,712. | 1,756. | 160. |
| | 78 ¹ / ₁₆ " | 36" | 3" | DP7CPRR7836 | 1,559. | 1,606. | 1,686. | 1,718. | 1,770. | 1,802. | 1,832. | 1,881. | 173. |
| | 78 ¹ / ₁₆ " | 42" | 3" | DP7CPRR7842 | 1,655. | 1,707. | 1,790. | 1,824. | 1,877. | 1,912. | 1,948. | 1,999. | 176. |
| | 78 ¹ / ₁₆ " | 48" | 3" | DP7CPRR7848 | 1,759. | 1,814. | 1,905. | 1,943. | 1,997. | 2,032. | 2,069. | 2,123. | 211. |

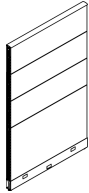

Dimensions listed under h w d are actual to the nearest 1/8"

| Ordering Information | Order Code | Included with: | Options |
|---|--|---|--|
| Tiled Panel with 28" Lower Tile and Base Raceway: 1. Pattern Number 2. Top cap type 3. Top cap finish 4. Raceway knockout option 5. Raceway trim finish 6. Tile support style 7. Panel fabric | Tiled Panels with 28" Lower Tile and Base Raceway <i>Example:</i> DP7CPRR7818 4/117/K/117/2/B191 DP7 Dividends Horizon Panel C Topway frame PP Tiled both sides, 28" Lower Tile RR Raceway both sides 78 Height 18 Width 4 Radius Metal top cap 117 Soft Grey top cap finish K Base raceway with knockouts both sides 117 Soft Grey base raceway finish 2 D2 style tile support B191 Fairfield light fabric | Tiled Panel with Standard Base Raceway and 28" Base Tile: <ul style="list-style-type: none"> • Panel frame • Acoustic panel inserts • Base raceway covers • Top cap • Connection hardware | Tiled Panels with 28" Lower Tile and Base Raceway: Full View Frame Option: To specify full view frame for window or stacking applications, replace the "C" in pattern number with "V". No upcharge. Monolithic Side Option: For side 1 monolithic, side 2 tiled, change "PP" in pattern number to "MP" and deduct amount in far right column. Top Cap Options: (2) = Extruded Plastic (Smooth Radius) (3) = No Top Cap (4) = Radius Metal, add \$40 P1, \$42 P2, \$44 P3 paint grades (5) = Flat Metal, add \$40 P1, \$42 P2, \$44 P3 paint grades Raceway Knockout Options: (K) = Knockouts on raceway side (N) = No knockouts Tile Support Options: (1) = D1 External Reveal (2) = D2 Recessed Reveal |

Tiled Panels

28" Lower Tile and Open Base

42" and 50" High

Dividends Horizon

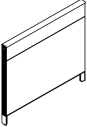
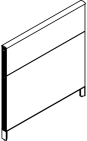
| description | h | w | d | pattern no. | grade | | | | | | | | Deduct for Monolithic One Side |
|---|----------|-----|----|---------------------|--------|--------|--------|--------|--------|--------|--------|--------|--------------------------------------|
| | | | | | 10 | 15 | 20 | 25 | 30 | 35 | 40 | 45 | |
| 42" High Tiled Panel with 28" Lower Tile and Open Base  | 42 3/16" | 18" | 3" | DP7CPPLL4218 | \$575. | \$592. | \$623. | \$638. | \$655. | \$669. | \$682. | \$700. | \$59. |
| | 42 3/16" | 24" | 3" | DP7CPPLL4224 | 613. | 633. | 667. | 681. | 699. | 713. | 725. | 746. | 59. |
| | 42 3/16" | 30" | 3" | DP7CPPLL4230 | 661. | 683. | 720. | 735. | 753. | 771. | 782. | 809. | 60. |
| | 42 3/16" | 36" | 3" | DP7CPPLL4236 | 713. | 737. | 775. | 789. | 814. | 829. | 847. | 865. | 62. |
| | 42 3/16" | 42" | 3" | DP7CPPLL4242 | 766. | 791. | 832. | 851. | 873. | 890. | 905. | 932. | 62. |
| | 42 3/16" | 48" | 3" | DP7CPPLL4248 | 812. | 835. | 882. | 899. | 926. | 940. | 960. | 987. | 63. |
| | 42 3/16" | 60" | 3" | DP7CPPLL4260 | 988. | 1,018. | 1,071. | 1,093. | 1,123. | 1,144. | 1,167. | 1,197. | 64. |
| 50" High Tiled Panel with 28" Lower Tile and Open Base  | 49 1/2" | 18" | 3" | DP7CPPLL5018 | 596. | 617. | 648. | 662. | 682. | 694. | 709. | 726. | 58. |
| | 49 1/2" | 24" | 3" | DP7CPPLL5024 | 647. | 669. | 707. | 719. | 742. | 752. | 769. | 788. | 60. |
| | 49 1/2" | 30" | 3" | DP7CPPLL5030 | 688. | 713. | 748. | 762. | 786. | 802. | 818. | 836. | 58. |
| | 49 1/2" | 36" | 3" | DP7CPPLL5036 | 735. | 756. | 799. | 816. | 835. | 854. | 869. | 894. | 54. |
| | 49 1/2" | 42" | 3" | DP7CPPLL5042 | 783. | 814. | 855. | 870. | 896. | 915. | 930. | 958. | 50. |
| | 49 1/2" | 48" | 3" | DP7CPPLL5048 | 832. | 859. | 904. | 925. | 951. | 965. | 986. | 1,010. | 49. |
| | 49 1/2" | 60" | 3" | DP7CPPLL5060 | 1,008. | 1,042. | 1,096. | 1,117. | 1,148. | 1,172. | 1,191. | 1,223. | 64. |

Dimensions listed under h w d are actual to the nearest 1/8"

| Ordering Information | Order Code | Included with: | Options |
|---|--|--|--|
| Tiled Panels with 28" Lower Tile and Open Base: 1. Pattern Number 2. Top cap type 3. Top cap trim finish 4. Base support trim finish 5. Tile support style 6. Panel fabric | Tiled Panels with 28" Lower Tile and Open Base <hr/> <i>Example:</i> DP7CPPLL4218 4/117/KK/117/2/B191 <hr/> DP7 Dividends Horizon Panel <hr/> C Topway frame <hr/> PP Tiled both sides, 28" Lower Tile <hr/> LL Open Base <hr/> 42 Height <hr/> 18 Width <hr/> 4 Radius Metal top cap <hr/> 117 Soft Grey top cap finish <hr/> 117 Soft Grey base support finish <hr/> 2 D2 style tile supports <hr/> B191 Fairfield light fabric | Tiled Panels with 28" Lower Tile and Open Base: <ul style="list-style-type: none"> Panel frame Acoustic panel inserts Open base Top cap Connection hardware | Tiled Panels with 28" Lower Tile and Open Base: Full View Frame Option: To specify full view frames for window or stacking applications, replace the "C" in pattern number with "V". No upcharge. Monolithic Side Option: To specify monolithic on side one of panel, change "PP" in pattern number to "MP" and deduct amount in far right column. Top Cap Options: (2) = Extruded Plastic (Smooth Radius) (3) = No Top Cap (4) = Radius Metal, add \$40 P1, \$42 P2, \$44 P3 paint grades (5) = Flat Metal, add \$40 P1, \$42 P2, \$44 P3 paint grades Base Raceway Knockout Options: (K) = Knockouts on raceway side (N) = No knockouts Tile Support Options: (1) = D1 External Reveal (2) = D2 Recessed Reveal |

Tiled Panels

28" Lower Tile and Open Base

57" and 64" High

| description | h | w | d | pattern no. | grade | | | | | | | | deduct for Monolithic One Side |
|--|------------------------------------|-----|----|---------------------|--------|--------|--------|--------|--------|--------|--------|--------|--------------------------------|
| | | | | | 10 | 15 | 20 | 25 | 30 | 35 | 40 | 45 | |
| 57" High Tiled Panel with 28" Lower Tile and Open Base | 56 ¹³ / ₁₆ " | 18" | 3" | DP7CPPLL5718 | \$737. | \$758. | \$802. | \$817. | \$840. | \$856. | \$873. | \$896. | \$73. |
| | 56 ¹³ / ₁₆ " | 24" | 3" | DP7CPPLL5724 | 799. | 823. | 863. | 882. | 908. | 926. | 942. | 966. | 76. |
| | 56 ¹³ / ₁₆ " | 30" | 3" | DP7CPPLL5730 | 848. | 874. | 921. | 936. | 963. | 984. | 1,000. | 1,031. | 78. |
| | 56 ¹³ / ₁₆ " | 36" | 3" | DP7CPPLL5736 | 904. | 933. | 981. | 1,000. | 1,032. | 1,049. | 1,067. | 1,097. | 79. |
| | 56 ¹³ / ₁₆ " | 42" | 3" | DP7CPPLL5742 | 961. | 991. | 1,043. | 1,064. | 1,095. | 1,115. | 1,136. | 1,167. | 81. |
| | 56 ¹³ / ₁₆ " | 48" | 3" | DP7CPPLL5748 | 1,016. | 1,051. | 1,103. | 1,126. | 1,156. | 1,179. | 1,201. | 1,234. | 82. |
| | 56 ¹³ / ₁₆ " | 60" | 3" | DP7CPPLL5760 | 1,234. | 1,275. | 1,335. | 1,362. | 1,403. | 1,429. | 1,455. | 1,493. | 85. |

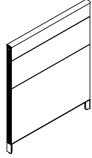

| | | | | | | | | | | | | | |
|--|-----------------------------------|-----|----|---------------------|--------|--------|--------|--------|--------|--------|--------|--------|-----|
| 64" High Tiled Panel with 28" Lower Tile and Open Base | 64 ¹ / ₁₆ " | 18" | 3" | DP7CPPLL6418 | 781. | 811. | 852. | 868. | 894. | 911. | 928. | 955. | 89. |
| | 64 ¹ / ₁₆ " | 24" | 3" | DP7CPPLL6424 | 848. | 872. | 921. | 935. | 962. | 981. | 999. | 1,031. | 93. |
| | 64 ¹ / ₁₆ " | 30" | 3" | DP7CPPLL6430 | 899. | 929. | 973. | 994. | 1,029. | 1,042. | 1,064. | 1,093. | 90. |
| | 64 ¹ / ₁₆ " | 36" | 3" | DP7CPPLL6436 | 960. | 991. | 1,041. | 1,063. | 1,093. | 1,114. | 1,134. | 1,166. | 91. |
| | 64 ¹ / ₁₆ " | 42" | 3" | DP7CPPLL6442 | 1,019. | 1,055. | 1,108. | 1,129. | 1,164. | 1,182. | 1,203. | 1,237. | 92. |
| | 64 ¹ / ₁₆ " | 48" | 3" | DP7CPPLL6448 | 1,081. | 1,114. | 1,171. | 1,191. | 1,225. | 1,251. | 1,275. | 1,308. | 93. |
| | 64 ¹ / ₁₆ " | 60" | 3" | DP7CPPLL6460 | 1,308. | 1,349. | 1,418. | 1,444. | 1,486. | 1,513. | 1,540. | 1,581. | 93. |

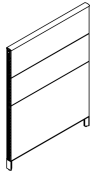

Dimensions listed under h w d are actual to the nearest 1/8"

| Ordering Information | Order Code | Included with: | Options |
|---|---|---|--|
| Tiled Panels with 28" Lower Tile and Open Base: 1. Pattern Number 2. Top cap type 3. Top cap trim finish 4. Base support trim finish 5. Tile support style 6. Panel fabric | Tiled Panels with 28" Lower Tile and Open Base <i>Example:</i> DP7CPPLL5718 4/117/KK/117/2/B191 DP7 Dividends Horizon Panel C Topway frame PP Tiled both sides, 28" Lower Tile LL Open Base 57 Height 18 Width 4 Radius Metal top cap 117 Soft Grey top cap finish 117 Soft Grey base support finish 2 D2 style tile support B191 Fairfield light fabric | Tiled Panels with 28" Lower Tile and Open Base: <ul style="list-style-type: none"> • Panel frame • Acoustic panel inserts • Open base • Top cap • Connection hardware | Tiled Panels with 28" Lower Tile and Open Base: Full View Frame Option: To specify full view frames for window or stacking applications, replace the "C" in pattern number with "V". No upcharge. Monolithic Side Option: To specify monolithic on side one of panel, change "PP" in pattern number to "MP" and deduct amount in far right column. Top Cap Options: (2) = Extruded Plastic (Smooth Radius) (3) = No Top Cap (4) = Radius Metal, add \$40 P1, \$42 P2, \$44 P3 paint grades (5) = Flat Metal, add \$40 P1, \$42 P2, \$44 P3 paint grades Base Raceway Knockout Options: (K) = Knockouts on raceway side (N) = No knockouts Tile Support Options: (1) = D1 External Reveal (2) = D2 Recessed Reveal |

Tiled Panels

28" Lower Tile and Open Base

78" High

| description | h | w | d | pattern no. | grade | | | | | | | deduct for Monolithic One Side | |
|--|-----------------------------------|-----|----|---------------------|----------|----------|----------|----------|----------|----------|----------|--------------------------------------|--------|
| | | | | | 10 | 15 | 20 | 25 | 30 | 35 | 40 | | 45 |
| 78" High Tiled Panel with 28" Lower Tile and Open Base | 78 ¹ / ₁₆ " | 18" | 3" | DP7CPPLL7818 | \$1,271. | \$1,308. | \$1,373. | \$1,401. | \$1,438. | \$1,465. | \$1,494. | \$1,535. | \$158. |
| | 78 ¹ / ₁₆ " | 24" | 3" | DP7CPPLL7824 | 1,367. | 1,409. | 1,484. | 1,510. | 1,556. | 1,582. | 1,609. | 1,655. | 163. |
| | 78 ¹ / ₁₆ " | 30" | 3" | DP7CPPLL7830 | 1,455. | 1,499. | 1,572. | 1,604. | 1,649. | 1,680. | 1,712. | 1,756. | 160. |
| | 78 ¹ / ₁₆ " | 36" | 3" | DP7CPPLL7836 | 1,559. | 1,606. | 1,686. | 1,718. | 1,770. | 1,802. | 1,832. | 1,881. | 173. |
| | 78 ¹ / ₁₆ " | 42" | 3" | DP7CPPLL7842 | 1,655. | 1,707. | 1,790. | 1,824. | 1,877. | 1,912. | 1,948. | 1,999. | 176. |
| | 78 ¹ / ₁₆ " | 48" | 3" | DP7CPPLL7848 | 1,759. | 1,814. | 1,905. | 1,943. | 1,997. | 2,032. | 2,069. | 2,123. | 211. |

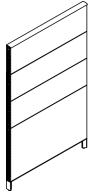

Dimensions listed under h w d are actual to the nearest 1/8"

| Ordering Information | Order Code | Included with: | Options |
|---|---|---|--|
| Tiled Panels with 28" Lower Tile and Open Base: 1. Pattern Number 2. Top cap type 3. Top cap trim finish 4. Base support trim finish 5. Tile support style 6. Panel fabric | Tiled Panels with 28" Lower Tile and Open Base <i>Example:</i> DP7CPPLL7818 4/117/KK/117/2/B191 DP7 Dividends Horizon Panel C Topway frame PP Tiled both sides, 28" Lower Tile LL Open Base 78 Height 18 Width 4 Radius Metal top cap 117 Soft Grey top cap finish 117 Soft Grey base support finish 2 D2 style tile support B191 Fairfield light fabric | Tiled Panels with 28" Lower Tile and Open Base: <ul style="list-style-type: none"> • Panel frame • Acoustic panel inserts • Open base • Top cap • Connection hardware | Tiled Panels with 28" Lower Tile and Open Base: Full View Frame Option: To specify full view frames for window or stacking applications, replace the "C" in pattern number with "V". No upcharge. Monolithic Side Option: To specify monolithic on side one of panel, change "PP" in pattern number to "MP" and deduct amount in far right column. Top Cap Options: (2) = Extruded Plastic (Smooth Radius) (3) = No Top Cap (4) = Radius Metal, add \$40 P1, \$42 P2, \$44 P3 paint grades (5) = Flat Metal, add \$40 P1, \$42 P2, \$44 P3 paint grades Base Raceway Knockout Options: (K) = Knockouts on raceway side (N) = No knockouts Tile Support Options: (1) = D1 External Reveal (2) = D2 Recessed Reveal |

Tiled Panels

28" Lower Tile and Tile To Floor

42" and 50" High

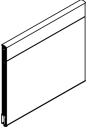
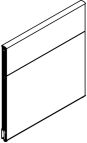
| description | h | w | d | pattern no. | grade | | | | | | | | Deduct for 1 side Monolithic |
|---|----------|-----|----|---------------------|--------|--------|--------|--------|--------|--------|--------|--------|------------------------------------|
| | | | | | 10 | 15 | 20 | 25 | 30 | 35 | 40 | 45 | |
| 42" High Tiled Panel with 28" Lower Tile and Tile to Floor  | 42 3/16" | 15" | 3" | DP7CPPFR4215 | \$609. | \$626. | \$657. | \$672. | \$689. | \$703. | \$716. | \$734. | \$59. |
| | 42 3/16" | 18" | 3" | DP7CPPFR4218 | 609. | 626. | 657. | 672. | 689. | 703. | 716. | 734. | 59. |
| | 42 3/16" | 24" | 3" | DP7CPPFR4224 | 647. | 667. | 701. | 715. | 733. | 747. | 759. | 780. | 59. |
| | 42 3/16" | 30" | 3" | DP7CPPFR4230 | 695. | 717. | 754. | 769. | 787. | 805. | 816. | 843. | 60. |
| | 42 3/16" | 36" | 3" | DP7CPPFR4236 | 747. | 771. | 809. | 823. | 848. | 863. | 881. | 899. | 62. |
| | 42 3/16" | 42" | 3" | DP7CPPFR4242 | 800. | 825. | 866. | 885. | 907. | 924. | 939. | 966. | 62. |
| | 42 3/16" | 48" | 3" | DP7CPPFR4248 | 846. | 869. | 916. | 933. | 960. | 974. | 994. | 1,021. | 63. |
| | 42 3/16" | 60" | 3" | DP7CPPFR4260 | 1,022. | 1,052. | 1,105. | 1,127. | 1,157. | 1,178. | 1,201. | 1,231. | 64. |
| 50" High Tiled Panel with 28" Lower Tile and Tile to Floor  | 49 1/2" | 15" | 3" | DP7CPPFR5015 | 630. | 851. | 682. | 696. | 716. | 728. | 743. | 760. | 58. |
| | 49 1/2" | 18" | 3" | DP7CPPFR5018 | 630. | 651. | 682. | 696. | 716. | 728. | 743. | 760. | 58. |
| | 49 1/2" | 24" | 3" | DP7CPPFR5024 | 681. | 703. | 741. | 753. | 776. | 786. | 803. | 822. | 60. |
| | 49 1/2" | 30" | 3" | DP7CPPFR5030 | 722. | 747. | 782. | 796. | 820. | 836. | 852. | 870. | 58. |
| | 49 1/2" | 36" | 3" | DP7CPPFR5036 | 769. | 790. | 833. | 850. | 869. | 888. | 903. | 928. | 54. |
| | 49 1/2" | 42" | 3" | DP7CPPFR5042 | 817. | 848. | 889. | 904. | 930. | 949. | 964. | 992. | 61. |
| | 49 1/2" | 48" | 3" | DP7CPPFR5048 | 866. | 893. | 938. | 959. | 985. | 999. | 1,020. | 1,044. | 49. |
| | 49 1/2" | 60" | 3" | DP7CPPFR5060 | 1,042. | 1,076. | 1,130. | 1,151. | 1,182. | 1,206. | 1,225. | 1,257. | 64. |

Dimensions listed under h w d are actual to the nearest 1/8"

| Ordering Information | Order Code | Included with: | Options |
|---|---|--|---|
| Tiled Panels with 28" Lower Tile and Tile To Floor: 1. Pattern Number 2. Top cap type 3. Top cap finish 4. Knockout option 5. Base raceway finish 6. Tile support style 7. Panel fabric | Tiled Panels with 28" Lower Tile and Tile To Floor: <i>Example:</i> DP7CPPFF4218 4/117/K/117/2B191 <hr/> DP7CPP Pattern number <hr/> FF4218 <hr/> 4 Radius Metal top cap <hr/> 117 Soft Grey top cap finish <hr/> K Base raceway with knockouts <hr/> 117 Soft grey base raceway finish <hr/> 2 D2 style tile supports <hr/> B191 Fairfield light fabric | Tiled Panels with 28" Lower Tile and Tile To Floor: <ul style="list-style-type: none"> Panel frame Acoustic panel inserts Top cap Connection hardware Tile to floor side 1 Base raceway with knockout when required side 2 | Tiled Panels with 28" Lower Tile and Tile To Floor: Full View Frame Option: To specify full view frames for window or stacking applications, replace the "C" in pattern number with "V". No upcharge. Tile to Floor Side Option: Tile to Floor standard on side 2. To specify tile to floor on side 1, change "FR" in pattern number to "RF". Monolithic Side Option: To specify monolithic on side one of panel, change "PP" in pattern number to "MP" and deduct amount in far right column. Top Cap Options: (2) = Extruded Plastic (Smooth Radius) (3) = No Top Cap (4) = Radius Metal, add \$40 P1, \$42 P2, \$44 P3 paint grades (5) = Flat Metal, add \$40 P1, \$42 P2, \$44 P3 paint grades Raceway Knockout Options: (K) = Knockouts on raceway side (N) = No knockouts Tile Support Options: (1) = D1 External Reveal (2) = D2 Recessed Reveal |

Tiled Panels

28" Lower Tile and Tile To Floor

57" and 64" High

| description | h | w | d | pattern no. | grade | | | | | | | | deduct for |
|--|------------------------------------|-----|----|---------------------|--------|--------|--------|--------|--------|--------|--------|--------|----------------------|
| | | | | | 10 | 15 | 20 | 25 | 30 | 35 | 40 | 45 | 1 side Monolithic |
| 57" High Tiled Panel with 28" Lower Tile and Tile to Floor | 56 ¹³ / ₁₆ " | 15" | 3" | DP7CPPFR5715 | \$771. | \$792. | \$836. | \$851. | \$874. | \$890. | \$907. | \$930. | \$73. |
| | 56 ¹³ / ₁₆ " | 18" | 3" | DP7CPPFR5718 | 771. | 792. | 836. | 851. | 874. | 890. | 907. | 930. | 73. |
| | 56 ¹³ / ₁₆ " | 24" | 3" | DP7CPPFR5724 | 833. | 857. | 897. | 916. | 942. | 960. | 976. | 1,000. | 76. |
| | 56 ¹³ / ₁₆ " | 30" | 3" | DP7CPPFR5730 | 882. | 908. | 955. | 970. | 997. | 1,018. | 1,034. | 1,065. | 78. |
| | 56 ¹³ / ₁₆ " | 36" | 3" | DP7CPPFR5736 | 938. | 967. | 1,015. | 1,034. | 1,066. | 1,083. | 1,101. | 1,131. | 79. |
| | 56 ¹³ / ₁₆ " | 42" | 3" | DP7CPPFR5742 | 995. | 1,025. | 1,077. | 1,098. | 1,129. | 1,149. | 1,170. | 1,202. | 81. |
| | 56 ¹³ / ₁₆ " | 48" | 3" | DP7CPPFR5748 | 1,050. | 1,085. | 1,137. | 1,160. | 1,190. | 1,213. | 1,235. | 1,268. | 82. |
| | 56 ¹³ / ₁₆ " | 60" | 3" | DP7CPPFR5760 | 1,268. | 1,309. | 1,369. | 1,396. | 1,437. | 1,463. | 1,489. | 1,527. | 85. |

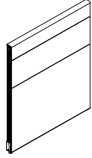

| | | | | | | | | | | | | | |
|--|-----------------------------------|-----|----|---------------------|--------|--------|--------|--------|--------|--------|--------|--------|-----|
| 64" High Tiled Panel with 28" Lower Tile and Tile to Floor | 64 ¹ / ₁₆ " | 15" | 3" | DP7CPPFR6415 | 815. | 845. | 886. | 902. | 928. | 945. | 962. | 989. | 89. |
| | 64 ¹ / ₁₆ " | 18" | 3" | DP7CPPFR6418 | 815. | 845. | 886. | 902. | 928. | 945. | 962. | 989. | 89. |
| | 64 ¹ / ₁₆ " | 24" | 3" | DP7CPPFR6424 | 882. | 906. | 995. | 969. | 996. | 1,015. | 1,033. | 1,065. | 93. |
| | 64 ¹ / ₁₆ " | 30" | 3" | DP7CPPFR6430 | 933. | 963. | 1,007. | 1,028. | 1,063. | 1,076. | 1,098. | 1,127. | 90. |
| | 64 ¹ / ₁₆ " | 36" | 3" | DP7CPPFR6436 | 944. | 1,025. | 1,075. | 1,097. | 1,127. | 1,148. | 1,168. | 1,200. | 91. |
| | 64 ¹ / ₁₆ " | 42" | 3" | DP7CPPFR6442 | 1,053. | 1,089. | 1,142. | 1,163. | 1,198. | 1,216. | 1,237. | 1,271. | 92. |
| | 64 ¹ / ₁₆ " | 48" | 3" | DP7CPPFR6448 | 1,115. | 1,148. | 1,205. | 1,225. | 1,259. | 1,285. | 1,309. | 1,342. | 93. |
| | 64 ¹ / ₁₆ " | 60" | 3" | DP7CPPFR6460 | 1,342. | 1,383. | 1,452. | 1,478. | 1,520. | 1,547. | 1,574. | 1,615. | 93. |

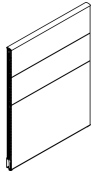

Dimensions listed under h w d are actual to the nearest 1/8"

| Ordering Information | Order Code | Included with: | Options |
|---|--|--|--|
| Tiled Panels with 28" Lower Tile and Tile To Floor: 1. Pattern Number 2. Top cap type 3. Top cap finish 4. Knockout option 5. Base raceway finish 6. Tile support style 7. Panel fabric | Tiled Panels with 28" Lower Tile and Tile To Floor: <i>Example:</i> DP7CPPFF4218 4/117/K/117/2/B191 <hr/> DP7CPP Pattern number FF4218 <hr/> 4 Radius Metal top cap <hr/> 117 Soft Grey top cap finish <hr/> K Base raceway with knockouts <hr/> 117 Soft Grey base raceway finish <hr/> 2 D2 style tile supports <hr/> B191 Fairfield light fabric | Tiled Panels with 28" Lower Tile and Tile To Floor: <ul style="list-style-type: none"> • Panel frame • Acoustic panel inserts • Top cap • Connection hardware • Tile to floor side 1 • Base raceway with knockout when required side 2 | Tiled Panels with 28" Lower Tile and Tile To Floor: Full View Frame Option: To specify full view frames for window or stacking applications, replace the "C" in pattern number with "V". No upcharge. Tile to Floor Side Option: Tile to Floor standard on side 2. To specify tile to floor on side 1, change "FR" in pattern number to "RF". Monolithic Side Option: To specify monolithic on side one of panel, change "PP" in pattern number to "MP" and deduct amount in far right column. Top Cap Options: (2) = Extruded Plastic (Smooth Radius) (3) = No Top Cap (4) = Radius Metal, add \$40 P1, \$42 P2, \$44 P3 paint grades (5) = Flat Metal, add \$40 P1, \$42 P2, \$44 P3 paint grades Raceway Knockout Options: (K) = Knockouts on raceway side (N) = No knockouts Tile Support Options: (1) = D1 External Reveal (2) = D2 Recessed Reveal |

Tiled Panels

28" Lower Tile and Tile To Floor

78" High

| description | h | w | d | pattern no. | grade | | | | | | | | deduct for 1 side Monolithic |
|--|-----------------------------------|-----|----|---------------------|----------|----------|----------|----------|----------|----------|----------|----------|------------------------------------|
| | | | | | 10 | 15 | 20 | 25 | 30 | 35 | 40 | 45 | |
| 78" High Tiled Panel with 28" Lower Tile and Tile to Floor | 78 ¹ / ₁₆ " | 15" | 3" | DP7CPPFR7815 | \$1,305. | \$1,342. | \$1,407. | \$1,435. | \$1,472. | \$1,499. | \$1,528. | \$1,569. | \$158. |
| | 78 ¹ / ₁₆ " | 18" | 3" | DP7CPPFR7818 | 1,305. | 1,342. | 1,407. | 1,435. | 1,472. | 1,499. | 1,528. | 1,569. | 158. |
| | 78 ¹ / ₁₆ " | 24" | 3" | DP7CPPFR7824 | 1,401. | 1,443. | 1,518. | 1,544. | 1,590. | 1,616. | 1,643. | 1,689. | 163. |
| | 78 ¹ / ₁₆ " | 30" | 3" | DP7CPPFR7830 | 1,489. | 1,533. | 1,606. | 1,638. | 1,683. | 1,714. | 1,746. | 1,790. | 160. |
| | 78 ¹ / ₁₆ " | 36" | 3" | DP7CPPFR7836 | 1,593. | 1,640. | 1,720. | 1,752. | 1,804. | 1,836. | 1,866. | 1,915. | 173. |
| | 78 ¹ / ₁₆ " | 42" | 3" | DP7CPPFR7842 | 1,689. | 1,741. | 1,824. | 1,858. | 1,911. | 1,946. | 1,982. | 2,033. | 176. |
| | 78 ¹ / ₁₆ " | 48" | 3" | DP7CPPFR7848 | 1,793. | 1,848. | 1,939. | 1,977. | 2,031. | 2,066. | 2,103. | 2,157. | 211. |

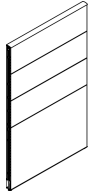

Ordering Information

Tiled Panels with 28" Lower Tile and Tile To Floor:

1. Pattern Number
2. Top cap type
3. Top cap finish
4. Knockout option
5. Base raceway finish
6. Tile support style
7. Panel fabric

Order Code

Tiled Panels with 28" Lower Tile and Tile To Floor:

Example: **DP7CPPFF4218**
4/117/K/117/2/B191

| | |
|---------------|-------------------------------|
| DP7CPP | Pattern number |
| FF4218 | |
| 4 | Radius Metal top cap |
| 117 | Soft Grey top cap finish |
| K | Base raceway with knockouts |
| 117 | Soft Grey base raceway finish |
| 2 | D2 style tile supports |
| B191 | Fairfield light fabric |

Included with:

Tiled Panels with 28" Lower Tile and Tile To Floor:

- Panel frame
- Acoustic panel inserts
- Top cap
- Connection hardware
- Base raceway with knockout when required

Options

Tiled Panels with 28" Lower Tile and Tile To Floor:

Full View Frame Option:

To specify full view frames for window or stacking applications, replace the "C" in pattern number with "V". No upcharge.

Tile to Floor Side Option:

Tile to Floor standard on side 2. To specify tile to floor on side 1, change "FR" in pattern number to "RF".

Monolithic Side Option:

To specify monolithic on side one of panel, change "PP" in pattern number to "MP" and deduct amount in far right column.

Top Cap Options:

- (2) = Extruded Plastic (Smooth Radius)
- (3) = No Top Cap
- (4) = Radius Metal, add \$40 P1, \$42 P2, \$44 P3 paint grades
- (5) = Flat Metal, add \$40 P1, \$42 P2, \$44 P3 paint grades

Raceway Knockout Options:

- (K) = Knockouts on raceway side
- (N) = No knockouts

Tile Support Options:

- (1) = D1 External Reveal
- (2) = D2 Recessed Reveal

Beltway Panel Components

“Preconfigured” Dividends Horizon beltway panels ship completely assembled with a universal panel frame, choice of standard base raceway, open base or tiled to the floor base options, top cap, panel-to-panel connection hardware and beltway inserts.

Beltway panels may be ordered by component for “Build-to-Spec” applications. This includes when panel inserts are required on one side only or when a different fabric color or material is required on opposite panel sides.

Beltway Panel Insert Supports

All Dividends Horizon panel frames are pre-punched to accept beltway supports which span horizontally across the panel frame. Beltway panel inserts are mounted above and below the beltway and attach to the upper and lower panel frame and the beltway supports. Beltway supports are painted black.

Note: Slatwall tiles may not be specified or installed with beltway.

Beltway Panel Insert Construction

Fabric inserts are constructed of fabric laminated with a web adhesive and heat cured to 1/2" thick tackable acoustic board. Laminate inserts are constructed of a particle board core with laminate on the front and back. Steel tiles are constructed of formed steel that is painted in any Knoll core paint finish.

Beltway Cover Construction

Trim-colored plastic extrusion available in smooth finish.

Electrical

Panel base raceways 24" and wider will accept two duplex receptacles per panel side. 18" wide panels provide pass-through electrical only. Beltway raceways 30" and wider will accept two duplex receptacles per panel side. 18" and 24" wide beltways provide pass-through electrical only. All electrical components are ordered separately and must be field-installed.

One-Sided Beltway Panel

Beltway panels are available with one beltway per panel or per panel sides. Non-beltway side will have a monolithic insert.

Three Top Cap Options Available

- Smooth Radius Plastic
- Radius Metal
- Flat Metal

Top Cap Construction

Smooth radiused top caps are made from extruded plastic. Radius and flat metal top caps are made from extruded aluminum.

Top Cap Attachment

Snaps onto the trough of a topway panel frame. Retainer clips are included to attach top caps to full view frames.

Preconfigured Beltway Panel

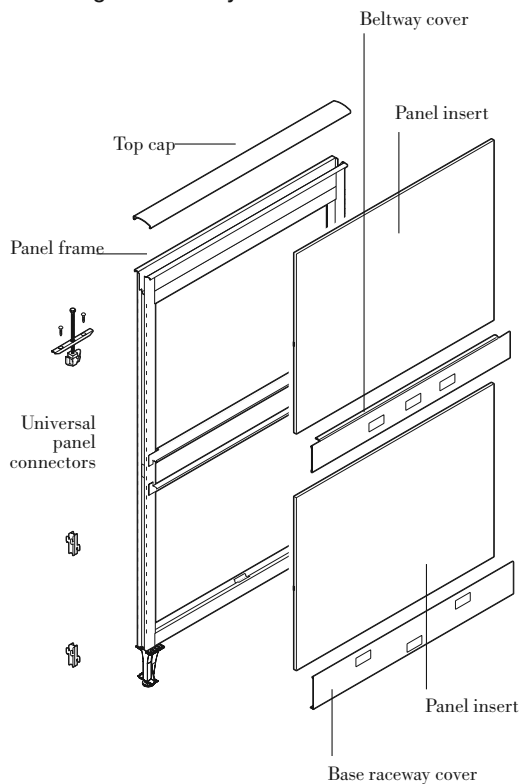

Panel Base Options

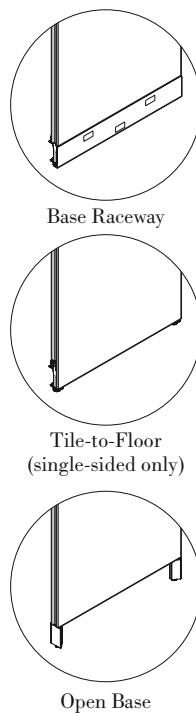

Beltway Panel Standard Configurations

42"H Panels

- One 7"H upper insert
- One 4"H beltway cover and insert support
- One 24"H lower insert

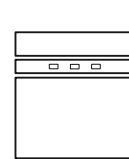

57"H Panels

- One 21"H upper insert
- One 4"H beltway cover and insert support
- One 24"H lower insert



64"H Panels

- One 28"H upper insert
- One 4"H beltway cover and insert support
- One 24"H lower insert

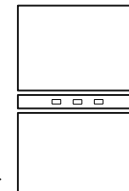

50"H Panels

- One 14"H upper panel insert
- One 4"H beltway cover and insert support
- One 24"H lower insert

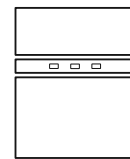

78"H Panels

- One 50"H upper insert
- One 4"H beltway cover and insert support
- One 24"H lower panel insert

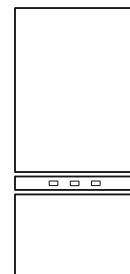

Beltway Panels

Standard Base Raceway

42" and 50" High

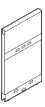
| description | h | w | d | pattern no. | grade | | | | | | | | | Deduct for Monolithic on side 2 |
|---|-----------------------------------|-----|----|---------------------|--------|--------|--------|--------|--------|--------|--------|--------|-------|---------------------------------|
| | | | | | 10 | 15 | 20 | 25 | 30 | 35 | 40 | 45 | | |
|  42" Beltway Panels with Standard Base Raceway | 42 ³ / ₁₆ " | 18" | 3" | DP7CBBRR4218 | \$618. | \$635. | \$669. | \$678. | \$699. | \$710. | \$722. | \$740. | \$92. | |
| | 42 ³ / ₁₆ " | 24" | 3" | DP7CBBRR4224 | 702. | 723. | 756. | 773. | 791. | 809. | 820. | 844. | 114. | |
| | 42 ³ / ₁₆ " | 30" | 3" | DP7CBBRR4230 | 771. | 792. | 833. | 848. | 872. | 885. | 899. | 925. | 123. | |
| | 42 ³ / ₁₆ " | 36" | 3" | DP7CBBRR4236 | 846. | 870. | 913. | 927. | 955. | 967. | 988. | 1,014. | 136. | |
| | 42 ³ / ₁₆ " | 42" | 3" | DP7CBBRR4242 | 916. | 944. | 990. | 1,005. | 1,036. | 1,056. | 1,071. | 1,098. | 142. | |
| | 42 ³ / ₁₆ " | 48" | 3" | DP7CBBRR4248 | 979. | 1,004. | 1,058. | 1,074. | 1,102. | 1,125. | 1,143. | 1,173. | 153. | |
| | 42 ³ / ₁₆ " | 60" | 3" | DP7CBBRR4260 | 1,110. | 1,143. | 1,199. | 1,221. | 1,254. | 1,278. | 1,299. | 1,331. | 153. | |
|  50" Beltway Panels with Standard Base Raceway | 49 ¹ / ₂ " | 18" | 3" | DP7CBBRR5018 | 642. | 661. | 694. | 707. | 724. | 738. | 750. | 771. | 91. | |
| | 49 ¹ / ₂ " | 24" | 3" | DP7CBBRR5024 | 736. | 756. | 792. | 810. | 831. | 847. | 859. | 882. | 115. | |
| | 49 ¹ / ₂ " | 30" | 3" | DP7CBBRR5030 | 801. | 821. | 860. | 879. | 899. | 917. | 933. | 958. | 119. | |
| | 49 ¹ / ₂ " | 36" | 3" | DP7CBBRR5036 | 865. | 890. | 934. | 953. | 979. | 994. | 1,010. | 1,038. | 125. | |
| | 49 ¹ / ₂ " | 42" | 3" | DP7CBBRR5042 | 935. | 964. | 1,010. | 1,032. | 1,060. | 1,077. | 1,097. | 1,126. | 131. | |
| | 49 ¹ / ₂ " | 48" | 3" | DP7CBBRR5048 | 997. | 1,031. | 1,080. | 1,099. | 1,129. | 1,149. | 1,172. | 1,201. | 136. | |
| | 49 ¹ / ₂ " | 60" | 3" | DP7CBBRR5060 | 1,135. | 1,169. | 1,224. | 1,247. | 1,282. | 1,305. | 1,327. | 1,360. | 136. | |

Dimensions listed under h w d are actual to the nearest 1/16"



| Ordering Information | Order Code | Included with: | Options |
|--|--|--|--|
| Beltway Panel with Standard Base Raceway: 1. Pattern Number 2. Top cap type 3. Top cap finish 4. Base raceway knockout option 5. Base raceway finish 6. Beltway finish 7. Panel fabric | Beltway Panel with Standard Base Raceway <i>Example:</i> DP7CBBRR4218 4/117/K/117/117/B191 <hr/> DP7CBB Pattern number <hr/> RR4218 <hr/> 4 Radius Metal top cap <hr/> 117 Soft Grey top cap finish <hr/> K Base Raceway with knockouts both sides <hr/> 117 Soft Grey base raceway finish <hr/> 117 Beltway finish <hr/> B191 Fairfield light fabric | Beltway Panel with Standard Base Raceway: <ul style="list-style-type: none"> Panel frame Acoustic panel inserts Base raceway covers Beltway covers Top cap Connection hardware | Beltway Panel with Standard Raceway Options: Full View Frame Option: To specify full view frames for window or stacking applications, replace the "C" in pattern number with "V". No upcharge. Monolithic Side Option: To specify monolithic on side one of panel, change "BB" in pattern number to "MB" and deduct amount in far right column. Top Cap Options: (2) = Extruded Plastic (Smooth Radius) (3) = No Top Cap (4) = Radius Metal, add \$40 P1, \$42 P2, \$44 P3 paint grades (5) = Flat Metal, add \$40 P1, \$42 P2, \$44 P3 paint grades Raceway Knockout Options: (K) = Knockouts on raceway side (N) = No Knockouts |

Beltway Panels

Standard Base Raceway

57", 64" and 78" High

Dividends Horizon

| description | h | w | d | pattern no. | grade | | | | | | | | Deduct for Monolithic on side 2 |
|---|------------------------------------|-----|----|---------------------|--------|--------|--------|--------|--------|--------|--------|--------|---------------------------------|
| | | | | | 10 | 15 | 20 | 25 | 30 | 35 | 40 | 45 | |
|  57" Beltway Panels with Standard Base Raceway | 56 ¹³ / ₁₆ " | 18" | 3" | DP7CBBRR5718 | \$686. | \$708. | \$740. | \$753. | \$775. | \$788. | \$805. | \$823. | \$91. |
| | 56 ¹³ / ₁₆ " | 24" | 3" | DP7CBBRR5724 | 778. | 805. | 843. | 858. | 880. | 895. | 912. | 935. | 115. |
| | 56 ¹³ / ₁₆ " | 30" | 3" | DP7CBBRR5730 | 843. | 867. | 909. | 926. | 953. | 966. | 986. | 1,009. | 119. |
| | 56 ¹³ / ₁₆ " | 36" | 3" | DP7CBBRR5736 | 926. | 954. | 999. | 1,018. | 1,046. | 1,065. | 1,083. | 1,110. | 125. |
| | 56 ¹³ / ₁₆ " | 42" | 3" | DP7CBBRR5742 | 993. | 1,024. | 1,073. | 1,094. | 1,123. | 1,143. | 1,164. | 1,192. | 131. |
| | 56 ¹³ / ₁₆ " | 48" | 3" | DP7CBBRR5748 | 1,066. | 1,097. | 1,150. | 1,173. | 1,205. | 1,224. | 1,246. | 1,280. | 136. |
| | 56 ¹³ / ₁₆ " | 60" | 3" | DP7CBBRR5760 | 1,200. | 1,236. | 1,297. | 1,321. | 1,356. | 1,380. | 1,404. | 1,439. | 136. |
|  64" Beltway Panels with Standard Base Raceway | 64 ¹ / ₁₆ " | 18" | 3" | DP7CBBRR6418 | 728. | 750. | 786. | 806. | 822. | 840. | 853. | 876. | 98. |
| | 64 ¹ / ₁₆ " | 24" | 3" | DP7CBBRR6424 | 821. | 848. | 887. | 907. | 928. | 947. | 961. | 988. | 121. |
| | 64 ¹ / ₁₆ " | 30" | 3" | DP7CBBRR6430 | 883. | 912. | 955. | 969. | 996. | 1,016. | 1,034. | 1,062. | 121. |
| | 64 ¹ / ₁₆ " | 36" | 3" | DP7CBBRR6436 | 986. | 1,014. | 1,063. | 1,082. | 1,110. | 1,130. | 1,149. | 1,179. | 138. |
| | 64 ¹ / ₁₆ " | 42" | 3" | DP7CBBRR6442 | 1,055. | 1,084. | 1,136. | 1,155. | 1,188. | 1,211. | 1,228. | 1,260. | 146. |
| | 64 ¹ / ₁₆ " | 48" | 3" | DP7CBBRR6448 | 1,132. | 1,168. | 1,222. | 1,245. | 1,280. | 1,302. | 1,324. | 1,358. | 159. |
| | 64 ¹ / ₁₆ " | 60" | 3" | DP7CBBRR6460 | 1,279. | 1,317. | 1,380. | 1,406. | 1,444. | 1,468. | 1,496. | 1,535. | 159. |
|  78" Beltway Panels with Standard Base Raceway | 78 ⁹ / ₁₆ " | 18" | 3" | DP7CBBRR7818 | 916. | 944. | 990. | 1,005. | 1,036. | 1,056. | 1,071. | 1,098. | 89. |
| | 78 ⁹ / ₁₆ " | 24" | 3" | DP7CBBRR7824 | 1,029. | 1,059. | 1,109. | 1,128. | 1,156. | 1,179. | 1,201. | 1,228. | 102. |
| | 78 ⁹ / ₁₆ " | 30" | 3" | DP7CBBRR7830 | 1,101. | 1,135. | 1,191. | 1,214. | 1,246. | 1,267. | 1,289. | 1,324. | 105. |
| | 78 ⁹ / ₁₆ " | 36" | 3" | DP7CBBRR7836 | 1,220. | 1,257. | 1,318. | 1,342. | 1,380. | 1,404. | 1,429. | 1,464. | 123. |
| | 78 ⁹ / ₁₆ " | 42" | 3" | DP7CBBRR7842 | 1,312. | 1,352. | 1,414. | 1,440. | 1,484. | 1,508. | 1,536. | 1,572. | 126. |
| | 78 ⁹ / ₁₆ " | 48" | 3" | DP7CBBRR7848 | 1,444. | 1,490. | 1,561. | 1,591. | 1,632. | 1,663. | 1,692. | 1,735. | 156. |

Dimensions listed under h w d are actual to the nearest 1/16"

| Ordering Information | Order Code | Included with: | Options |
|--|--|--|--|
| Beltway Panel with Standard Base Raceway: 1. Pattern Number 2. Top cap type 3. Top cap finish 4. Base raceway knockout option 5. Base raceway finish 6. Beltway finish 7. Panel fabric | Beltway Panel with Standard Base Raceway <i>Example:</i> DP7CBBRR4218 4/117/K/117/117/B191 DP7CBB Pattern number RR4218 4 Radius Metal top cap 117 Soft Grey top cap finish K Base Raceway with knockouts both sides 117 Soft Grey base raceway finish 117 Beltway finish B191 Fairfield light fabric | Beltway Panel with Standard Base Raceway: <ul style="list-style-type: none"> Panel frame Acoustic panel inserts Base raceway covers Beltway covers Top cap Connection hardware | Beltway Panel with Standard Raceway Options: Full View Frame Option: To specify full view frames for window or stacking applications, replace the "C" in pattern number with "V". No upcharge. Monolithic Side Option: To specify monolithic on side one of panel, change "BB" in pattern number to "MB" and deduct amount in far right column. Top Cap Options: (2) = Extruded Plastic (Smooth Radius) (3) = No Top Cap (4) = Radius Metal, add \$40 P1, \$42 P2, \$44 P3 paint grades (5) = Flat Metal, add \$40 P1, \$42 P2, \$44 P3 paint grades Raceway Knockout Options: (K) = Knockouts on raceway side (N) = No Knockouts |

Beltway Panels

Tile to the Floor

42" and 50" High

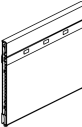
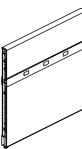
| description | h | w | d | pattern no. | grade | | | | | | | | Deduct for Monolithic side 1 |
|---|-----------------------------------|-----|----|---------------------|--------|--------|--------|--------|--------|--------|--------|--------|------------------------------|
| | | | | | 10 | 15 | 20 | 25 | 30 | 35 | 40 | 45 | |
|  42" Beltway Panels with Tile to the Floor | 42 ³ / ₁₆ " | 18" | 3" | DP7CBBFR4218 | \$652. | \$669. | \$703. | \$712. | \$733. | \$744. | \$756. | \$774. | \$92. |
| | 42 ³ / ₁₆ " | 24" | 3" | DP7CBBFR4224 | 736. | 767. | 790. | 807. | 825. | 843. | 854. | 878. | 114. |
| | 42 ³ / ₁₆ " | 30" | 3" | DP7CBBFR4230 | 805. | 826. | 867. | 882. | 906. | 919. | 933. | 959. | 123. |
| | 42 ³ / ₁₆ " | 36" | 3" | DP7CBBFR4236 | 880. | 904. | 947. | 961. | 989. | 1,001. | 1,022. | 1,048. | 136. |
| | 42 ³ / ₁₆ " | 42" | 3" | DP7CBBFR4242 | 950. | 978. | 1,024. | 1,039. | 1,070. | 1,090. | 1,105. | 1,132. | 142. |
| | 42 ³ / ₁₆ " | 48" | 3" | DP7CBBFR4248 | 1,013. | 1,038. | 1,092. | 1,108. | 1,136. | 1,159. | 1,177. | 1,207. | 153. |
| | 42 ³ / ₁₆ " | 60" | 3" | DP7CBBFR4260 | 1,144. | 1,177. | 1,233. | 1,255. | 1,288. | 1,312. | 1,333. | 1,365. | 153. |
|  50" Beltway Panels with Tile to the Floor | 49 ¹ / ₂ " | 18" | 3" | DP7CBBFR5018 | 676. | 695. | 728. | 741. | 758. | 772. | 784. | 805. | 91. |
| | 49 ¹ / ₂ " | 24" | 3" | DP7CBBFR5024 | 770. | 790. | 826. | 844. | 865. | 881. | 893. | 916. | 115. |
| | 49 ¹ / ₂ " | 30" | 3" | DP7CBBFR5030 | 835. | 855. | 894. | 913. | 933. | 951. | 967. | 992. | 119. |
| | 49 ¹ / ₂ " | 36" | 3" | DP7CBBFR5036 | 899. | 924. | 968. | 987. | 1,013. | 1,028. | 1,044. | 1,072. | 125. |
| | 49 ¹ / ₂ " | 42" | 3" | DP7CBBFR5042 | 969. | 998. | 1,044. | 1,066. | 1,094. | 1,111. | 1,131. | 1,160. | 131. |
| | 49 ¹ / ₂ " | 48" | 3" | DP7CBBFR5048 | 1,031. | 1,065. | 1,114. | 1,133. | 1,163. | 1,183. | 1,206. | 1,235. | 136. |
| | 49 ¹ / ₂ " | 60" | 3" | DP7CBBFR5060 | 1,169. | 1,203. | 1,258. | 1,281. | 1,316. | 1,339. | 1,351. | 1,394. | 136. |

Dimensions listed under h w c are actual to the nearest 1/16"

| Ordering Information | Order Code | Included with: | Options |
|--|---|---|--|
| Beltway Panel with Tile to the Floor: 1. Pattern Number 2. Top cap type 3. Top cap finish 4. Base raceway knockout option 5. Base raceway finish 6. Beltway finish 7. Panel fabric | Beltway Panel with Tile to the Floor: <i>Example:</i> DP7CBBFR4218 4/117/K/117/117/B191 <hr/> DP7CBB Pattern number <hr/> FR4218 <hr/> 4 Radius Metal top cap <hr/> 117 Soft Grey top cap finish <hr/> K Base raceway with knockouts both sides <hr/> 117 Soft Grey base raceway finish <hr/> 117 Soft Grey beltway cover finish <hr/> B191 Fairfield light fabric | Beltway Panel with Tile to the Floor: <ul style="list-style-type: none"> Panel frame Acoustic panel inserts Top cap Connection hardware Base raceway side 2 Beltway with covers Tile to the floor side 1 | Beltway Panel with Tile to the Floor: Full View Frame Option: To specify full view frames for window or stacking applications, replace the "C" in pattern number with "V". No upcharge. Monolithic Side Option: For side 1 monolithic, side 2 beltway, change "BB" in pattern number to "MB" and deduct amount in far right column. Tile to Floor Side Option: Panels are standard with tile to floor side 1, raceway side 2. To specify raceway side one and tile to floor side 2, change "FR" in pattern number to "RF". Top Cap Options: (2) = Extruded Plastic (Smooth Radius) (3) = No Top Cap (4) = Radius Metal, add \$40 P1, \$42 P2, \$44 P3 paint grades (5) = Flat Metal, add \$40 P1, \$42 P2, \$44 P3 paint grades Raceway Knockout Options: (K) = Knockouts on raceway side (N) = No Knockouts |

Beltway Panels

Tile to the Floor

57" and 64" High

| description | height | width | depth | pattern number | | | | | | | | | Deduct for Monolithic side 1 |
|---|-----------|-------|-------|---------------------|--------|--------|--------|--------|--------|--------|--------|--------|------------------------------|
| | | | | | 10 | 15 | 20 | 25 | 30 | 35 | 40 | 45 | |
| 57" Beltway Panels with Tile to the Floor | 56 13/16" | 18" | 3" | DP7CBBFR5718 | \$720. | \$742. | \$774. | \$787. | \$809. | \$822. | \$839. | \$857. | \$91. |
| | 56 13/16" | 24" | 3" | DP7CBBFR5724 | 812. | 839. | 877. | 892. | 914. | 929. | 946. | 969. | 115. |
| | 56 13/16" | 30" | 3" | DP7CBBFR5730 | 877. | 901. | 943. | 960. | 987. | 1,000. | 1,020. | 1,043. | 119. |
| | 56 13/16" | 36" | 3" | DP7CBBFR5736 | 960. | 988. | 1,033. | 152. | 1,080. | 1,099. | 1,117. | 1,144. | 125. |
| | 56 13/16" | 42" | 3" | DP7CBBFR5742 | 1,027. | 1,058. | 1,107. | 1,128. | 1,157. | 1,177. | 1,198. | 1,226. | 131. |
| | 56 13/16" | 48" | 3" | DP7CBBFR5748 | 1,100. | 1,131. | 1,184. | 1,207. | 1,239. | 1,258. | 1,280. | 1,314. | 136. |
| | 56 13/16" | 60" | 3" | DP7CBBFR5760 | 1,234. | 1,270. | 1,331. | 1,355. | 1,390. | 1,414. | 1,438. | 1,473. | 136. |

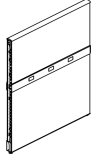

| | | | | | | | | | | | | | |
|---|----------|-----|----|---------------------|--------|--------|--------|--------|--------|--------|--------|--------|------|
| 64" Beltway Panels with Tile to the Floor | 64 1/16" | 18" | 3" | DP7CBBFR6418 | 762. | 784. | 820. | 840. | 856. | 874. | 887. | 910. | 98. |
| | 64 1/16" | 24" | 3" | DP7CBBFR6424 | 855. | 882. | 921. | 941. | 962. | 981. | 995. | 1,022. | 121. |
| | 64 1/16" | 30" | 3" | DP7CBBFR6430 | 917. | 946. | 989. | 1,003. | 1,030. | 1,050. | 1,068. | 1,096. | 121. |
| | 64 1/16" | 36" | 3" | DP7CBBFR6436 | 1,020. | 1,048. | 1,097. | 1,116. | 1,144. | 1,164. | 1,183. | 1,213. | 138. |
| | 64 1/16" | 42" | 3" | DP7CBBFR6442 | 1,089. | 1,118. | 1,170. | 1,189. | 1,222. | 1,245. | 1,262. | 1,294. | 146. |
| | 64 1/16" | 48" | 3" | DP7CBBFR6448 | 1,166. | 1,202. | 1,256. | 1,279. | 1,314. | 1,336. | 1,358. | 1,392. | 159. |
| | 64 1/16" | 60" | 3" | DP7CBBFR6460 | 1,313. | 1,351. | 1,414. | 1,440. | 1,478. | 1,502. | 1,530. | 1,569. | 159. |

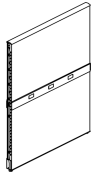

Dimensions listed under h w c are actual to the nearest 1/16"

| Ordering Information | Order Code | Included with: | Options |
|--|--|--|--|
| Beltway Panel with Tile to the Floor: 1. Pattern Number 2. Top cap type 3. Top cap finish 4. Base raceway knockout option 5. Base raceway finish 6. Beltway finish 7. Panel fabric | Beltway Panel with Tile to the Floor: <i>Example:</i> DP7CBBFR5718 4/117/K/117/117/B191 <hr/> DP7CBBFR5718 Pattern number <hr/> 4 Radius Metal top cap <hr/> 117 Soft Grey top cap finish <hr/> K Base raceway with knockouts both sides <hr/> 117 Soft Grey base raceway finish <hr/> 117 Soft Grey beltway cover finish <hr/> B191 Fairfield light fabric | Beltway Panel with Tile to the Floor: <ul style="list-style-type: none"> • Panel frame • Acoustic panel inserts • Top cap • Connection hardware • Base raceway • Beltway with covers • Tile to the floor side 1 | Beltway Panel with Tile to the Floor: Full View Frame Option: To specify full view frames for window or stacking applications, replace the "C" in pattern number with "V". No upcharge. Monolithic Side Option: For side 1 monolithic, side 2 beltway, change "BB" in pattern number to "MB" and deduct amount in far right column. Tile to Floor Side Option: Panels are standard with tile to floor side 1, raceway side 2. To specify raceway side one and tile to floor side 2, change "FR" in pattern number to "RF". Top Cap Options: (2) = Extruded Plastic (Smooth Radius) (3) = No Top Cap (4) = Radius Metal, add \$40 P1, \$42 P2, \$44 P3 paint grades (5) = Flat Metal, add \$40 P1, \$42 P2, \$44 P3 paint grades Raceway Knockout Options: (K) = Knockouts on raceway side (N) = No Knockouts |

Beltway Panels

Tile to the Floor

78" High

| description | height | width | depth | pattern number | | | | | | | | | Deduct for |
|---|-----------------------------------|-------|-------|---------------------|--------|--------|----------|----------|----------|----------|----------|----------|-------------------|
| | | | | | 10 | 15 | 20 | 25 | 30 | 35 | 40 | 45 | Monolithic side 1 |
| 78" Beltway Panels with Tile to the Floor | 78 ⁹ / ₁₆ " | 18" | 3" | DP7CBBFR7818 | \$950. | \$978. | \$1,024. | \$1,039. | \$1,070. | \$1,090. | \$1,105. | \$1,132. | \$89. |
| | 78 ⁹ / ₁₆ " | 24" | 3" | DP7CBBFR7824 | 1,063. | 1,093. | 1,143. | 1,162. | 1,190. | 1,213. | 1,235. | 1,262. | 102. |
| | 78 ⁹ / ₁₆ " | 30" | 3" | DP7CBBFR7830 | 1,135. | 1,169. | 1,225. | 1,248. | 1,280. | 1,301. | 1,323. | 1,358. | 105. |
| | 78 ⁹ / ₁₆ " | 36" | 3" | DP7CBBFR7836 | 1,254. | 1,291. | 1,352. | 1,376. | 1,414. | 1,438. | 1,463. | 1,498. | 123. |
| | 78 ⁹ / ₁₆ " | 42" | 3" | DP7CBBFR7842 | 1,346. | 1,386. | 1,448. | 1,474. | 1,518. | 1,542. | 1,570. | 1,606. | 126. |
| | 78 ⁹ / ₁₆ " | 48" | 3" | DP7CBBFR7848 | 1,478. | 1,524. | 1,595. | 1,625. | 1,666. | 1,697. | 1,726. | 1,769. | 156. |

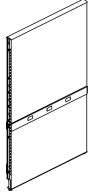

Dimensions listed under h w c are actual to the nearest 1/16"

| Ordering Information | Order Code | Included with: | Options |
|---|---|---|---|
| Beltway Panel with Tile to the Floor: <ol style="list-style-type: none"> 1. Pattern Number 2. Top cap type 3. Top cap finish 4. Base raceway knockout option 5. Base raceway finish 6. Beltway finish 7. Panel fabric | Beltway Panel with Tile to the Floor: <i>Example:</i> DP7CBBFR7818 4/117/K/117/117/B191 <hr/> DP7CBB Pattern number <hr/> FR7818 <hr/> 4 Radius Metal top cap <hr/> 117 Soft Grey top cap finish <hr/> K Base raceway with knockouts both sides <hr/> 117 Soft Grey base raceway finish <hr/> 117 Soft Grey beltway cover finish <hr/> B191 Fairfield light fabric | Beltway Panel with Tile to the Floor: <ul style="list-style-type: none"> • Panel frame • Acoustic panel inserts • Top cap • Connection hardware • Base raceway • Beltway with covers • Tile to the floor side 1 | Beltway Panel with Tile to the Floor: <p>Full View Frame Option: To specify full view frames for window or stacking applications, replace the "C" in pattern number with "V". No upcharge.</p> <p>Monolithic Side Option: For side 1 monolithic, side 2 beltway, change "BB" in pattern number to "MB" and deduct amount in far right column.</p> <p>Tile to Floor Side Option: Panels are standard with tile to floor side 1, raceway side 2. To specify raceway side one and tile to floor side 2, change "FR" in pattern number to "RF".</p> <p>Top Cap Options: (2) = Extruded Plastic (Smooth Radius) (3) = No Top Cap (4) = Radius Metal, add \$40 P1, \$42 P2, \$44 P3 paint grades (5) = Flat Metal, add \$40 P1, \$42 P2, \$44 P3 paint grades</p> <p>Raceway Knockout Options: (K) = Knockouts on raceway side (N) = No Knockouts</p> |

Panel Frame Options

Dividends Horizon offers two panel frame options, which are selected depending on customer's aesthetic and functional needs. Both frames are available in preconfigured and build-to-spec panels, and may also be specified in CAP.

Dividends Horizon panel frames may be specified separately for "Build-to-Spec" applications. These include when panel inserts are only required on one side or when a beltway is required on one side and tiled inserts are on the other.

Panel frames may be specified with a standard base raceway, an open base or a tile to the floor. Panel frames ship complete with the base components, top cap and universal connection hardware. Raceway cover knockouts are standard with standard base raceway. If not required raceway covers without knockouts may be specified.

Topway panel frames feature an integral top cable trough, and are used with D1 style stack panels.

Full View frames have no top trough, leaving a larger window opening in the top position. Full view panels frames are designed for use with windows in the top position. They are also required when stacking with D2 style stack frames or DP7 stacking screens.

Topway and full view panel frames are offered in worksurface height, 36", 42", 50", 57", 64" and 78" high.

Three Top Cap Options Available:

- Smooth Radius Plastic
- Radius Metal
- Flat Metal

Top Cap Construction

Smooth radiused plastic top caps are made from extruded plastic. Radius and flat metal top caps are made from steel.

Top Cap Attachment

Full view frames ordered with top caps include top cap attachment clips on the panel frame.

If top caps are ordered separately, top cap attachment clips ship with the top cap and must be field-installed to the panel frame.

Open Position Planner

Open Position Planner allows specifiers to design and order factory assembled panels in virtually any configuration. Open Position Planner is available only through CAP, and is not available in this price list.

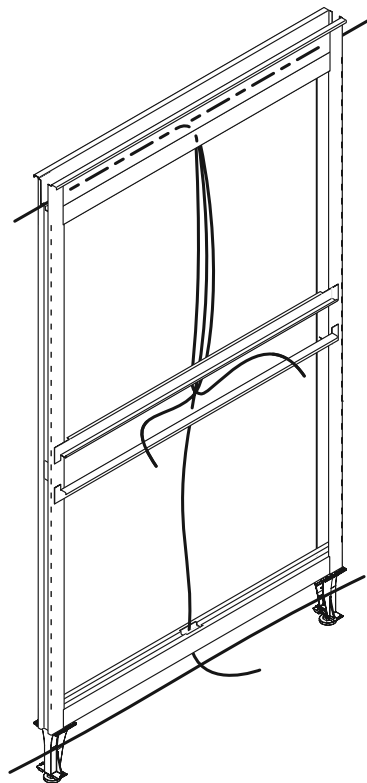

Topway Panel Frame

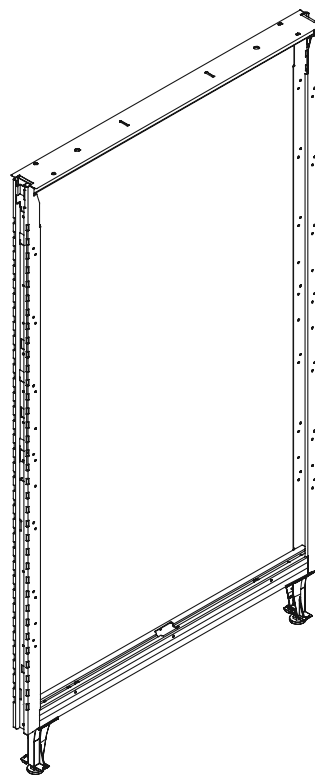

Full View Panel Frame

Panel Base Options

Dividends Horizon panels are available with three base options:

- Base Raceway
- Open Base
- Tile-to-Floor.

Overall panel heights, tile configurations and application rules are the same for all three base options.

Base Raceway

Provides duplex receptacle and data port access at base height. Base Raceway panels feature two roll formed steel raceway covers, which are available with or without electrical/data knockouts.

- Exterior dimension: 5"H x 2 15/16"D
- Interior dimension: 5"H x 2 7/8"D
- Dataport Knockout dimension: 1 3/8"H x 2 5/8"D
- Construction: Paint-colored 22-gauge roll-form steel cover
- Duplex access: 24" and wider base raceway covers have two duplex knockouts per panel side (18"W panels do not have duplex knockouts)
- Duplex location: 9" on center from each end

Panel Base Options

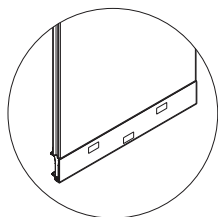

Base Raceway

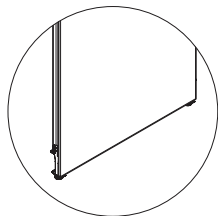

Tile-to-Floor
(single-sided only)

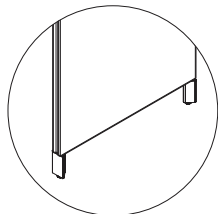

Open Base

- Data access: All base raceway covers have one center-located data port knockout
- Additional data access: In panels 24" and wider, the outer knockouts can be used as additional data ports when the raceway is not used for duplex receptacles
- Power capacity: One power module or jumper

Note: Knockouts are standard unless specified without.

Open Base panels feature two extruded aluminum feet positioned at the end of each panel. A horizontal trim is located below the bottom tile.

Tile-To-Floor panels eliminate the raceway cover and access on one side, replaced by a fabric tile extended to the floor. A heavy gauge steel internal raceway cover protects the raceway contents and the tile from deflecting when hit by shoes or vacuum cleaners. The other side of the panel features a raceway cover, available with or without electrical/data knockouts. If needed, use one-sided electrical and one-sided base cable trays with this base option.

Note: Worksurface height monolithic tiles are to be used with worksurface height panel frames only.

Note: 24"H inserts are to only be used below beltways.

Monolithic and Tiled Panel Standard Configuration

Worksurface Height



- Monolithic
- One worksurface height monolithic insert

36"H Panel Frames



- Monolithic
- One 28"H monolithic insert



- Tiled
- Two 14"H tiled inserts

42"H Panel Frames



- Monolithic
- One 35"H monolithic insert



- Tiled
- One 7"H tiled insert
 - Two 14"H tiled inserts



- Beltway
- One 7"H upper insert
 - One 4"H beltway cover
 - One 24"H lower insert

50"H Panel Frames



- Monolithic
- One 42"H monolithic insert



- Tiled
- Three 14"H tiled inserts



- Beltway
- One 14"H upper insert
 - One 4"H beltway cover
 - One 24"H lower insert

57"H Panel Frames



- Monolithic
- One 49"H monolithic insert



- Tiled
- One 7"H tiled inserts
 - Three 14"H tiled inserts

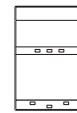

- Beltway
- One 7"H tiled insert
 - One 14"H tiled insert
 - One 4"H beltway cover
 - One 24"H lower insert

64"H Panel Frames



- Monolithic
- One 56"H monolithic insert

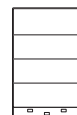

- Tiled
- Four 14" H tiled inserts

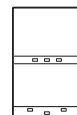

- Beltway
- One 28"H upper insert
 - One 4"H beltway cover
 - One 24"H lower insert

78"H Panel Frames

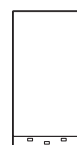

- Monolithic
- One 70"H monolithic insert



- Tiled
- Five 14"H tiled inserts



- Beltway
- One 50"H Upper insert
 - One 4"H Beltway cover
 - One 24"H Lower insert

Note: Insert dimensions are nominal. Inserts are for one side only.

Topway and Full View Panel Frame Assemblies

Worksurface Height, 36" and 42" High

Dividends Horizon

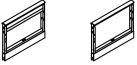
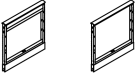
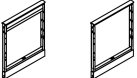
| description | h | w | d | pattern no. | list |
|---|----------|-----|----|---------------------|--------|
| Worksurface Height | 28 1/2" | 15" | 3" | DP7() RRWH15 | \$230. |
| Panel Frame Assembly | 28 1/2" | 18" | 3" | DP7() RRWH18 | 230. |
| Standard Base Raceway | 28 1/2" | 24" | 3" | DP7() RRWH24 | 237. |
|  | 28 1/2" | 30" | 3" | DP7() RRWH30 | 246. |
| | 28 1/2" | 36" | 3" | DP7() RRWH36 | 262. |
| | 28 1/2" | 42" | 3" | DP7() RRWH42 | 292. |
| | 28 1/2" | 48" | 3" | DP7() RRWH48 | 292. |
| | 28 1/2" | 60" | 3" | DP7() RRWH60 | 337. |
| 36" High Panel Frame Assembly | 35 1/8" | 15" | 3" | DP7() RR3615 | 230. |
| Standard Base Raceway | 35 1/8" | 18" | 3" | DP7() RR3618 | 230. |
|  | 35 1/8" | 24" | 3" | DP7() RR3624 | 237. |
| (topway and full view shown) | 35 1/8" | 30" | 3" | DP7() RR3630 | 246. |
| | 35 1/8" | 36" | 3" | DP7() RR3636 | 262. |
| | 35 1/8" | 42" | 3" | DP7() RR3642 | 292. |
| | 35 1/8" | 48" | 3" | DP7() RR3648 | 292. |
| | 35 1/8" | 60" | 3" | DP7() RR3660 | 337. |
| 42" High Panel Frame Assembly | 42 3/16" | 15" | 3" | DP7() RR4215 | 207. |
| Standard Base Raceway | 42 3/16" | 18" | 3" | DP7() RR4218 | 207. |
|  | 42 3/16" | 24" | 3" | DP7() RR4224 | 213. |
| (topway and full view shown) | 42 3/16" | 30" | 3" | DP7() RR4230 | 230. |
| | 42 3/16" | 36" | 3" | DP7() RR4236 | 246. |
| | 42 3/16" | 42" | 3" | DP7() RR4242 | 266. |
| | 42 3/16" | 48" | 3" | DP7() RR4248 | 280. |
| | 42 3/16" | 60" | 3" | DP7() RR4260 | 321. |

Dimensions listed under h w d are actual to the nearest 1/16"

| Ordering Information | Order Code | Included with: | Options |
|------------------------------------|--|--|--|
| Panel Frame Assembly | Topway Panel Frame Assembly | Panel Frame Assembly: | Panel Frame Assembly: |
| 1. Pattern Number | <i>Example:</i> DP7CRR6448 | <ul style="list-style-type: none"> Panel frame Top cap (optional) Connection hardware Base raceway | Option: |
| 2. Top cap type | 4/117K/117 | | (C) = Topway Panel Frame |
| 3. Top cap trim finish | DP7CRR Topway Panel Frame | Note: Worksurface Height panel frame assemblies are not available with plastic top caps. | (V) = Full View Panel Frame |
| 4. Raceway knockout option | 6448 Assemblies with Base Raceway | Note: 15" wide panels are only available with standard base raceway or tile to floor. | Panel Base Options |
| 5. Base raceway finish if required | 4 Radius metal topcap | | Open Panel Base Option: For open panel base, change 'RR' to 'LL'. |
| | 117 Soft Grey top cap finish | | Tile to Floor Option: For tile to floor on one side and base raceway on the other side change 'RR' to 'FR' and add \$34 to list price. |
| | K Raceway knockouts | | Top Cap Options: |
| | 117 Soft Grey raceway finish | | (2) = Extruded Plastic (Smooth Radius) |
| | | | (3) = No Top Cap |
| | | | (4) = Radius Metal, add \$40 P1, \$42 P2, \$44 P3 paint grades |
| | | | (5) = Flat Metal, add \$40 P1, \$42 P2, \$44 P3 paint grades |
| | | | Base Raceway Knockout Options: (for RR and RF bases only) |
| | | | (K) = Knockouts on raceway side |
| | | | (N) = No knockouts |

Topway and Full View Panel Frame Assemblies

50", 57" and 64" High

Dividends Horizon

Panels, Build-To-Spec

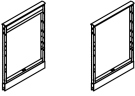
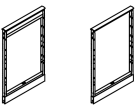
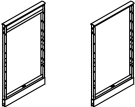
| description | h | w | d | pattern no. | list |
|---|-----------|-----|----|---------------------|--------|
| 50" High Panel Frame Assembly Standard Base Raceway  (topway and full view shown) | 49 1/2" | 15" | 3" | DP7()RR5015 | \$213. |
| | 49 1/2" | 18" | 3" | DP7()RR5018 | 213. |
| | 49 1/2" | 24" | 3" | DP7()RR5024 | 223. |
| | 49 1/2" | 30" | 3" | DP7()RR5030 | 240. |
| | 49 1/2" | 36" | 3" | DP7()RR5036 | 253. |
| | 49 1/2" | 42" | 3" | DP7()RR5042 | 272. |
| | 49 1/2" | 48" | 3" | DP7()RR5048 | 286. |
| | 49 1/2" | 60" | 3" | DP7()RR5060 | 311. |
| 57" High Panel Frame Assembly Standard Base Raceway  (topway and full view shown) | 56 13/16" | 15" | 3" | DP7()RR5715 | 213. |
| | 56 13/16" | 18" | 3" | DP7()RR5718 | 213. |
| | 56 13/16" | 24" | 3" | DP7()RR5724 | 223. |
| | 56 13/16" | 30" | 3" | DP7()RR5730 | 235. |
| | 56 13/16" | 36" | 3" | DP7()RR5736 | 251. |
| | 56 13/16" | 42" | 3" | DP7()RR5742 | 265. |
| | 56 13/16" | 48" | 3" | DP7()RR5748 | 281. |
| | 56 13/16" | 60" | 3" | DP7()RR5760 | 296. |
| 64" High Panel Frame Assembly Standard Base Raceway  (topway and full view shown) | 64 1/16" | 15" | 3" | DP7()RR6415 | 225. |
| | 64 1/16" | 18" | 3" | DP7()RR6418 | 225. |
| | 64 1/16" | 24" | 3" | DP7()RR6424 | 243. |
| | 64 1/16" | 30" | 3" | DP7()RR6430 | 253. |
| | 64 1/16" | 36" | 3" | DP7()RR6436 | 269. |
| | 64 1/16" | 42" | 3" | DP7()RR6442 | 286. |
| | 64 1/16" | 48" | 3" | DP7()RR6448 | 302. |
| | 64 1/16" | 60" | 3" | DP7()RR6460 | 350. |

Dimensions listed under h w d are actual to the nearest 1/16"

| Ordering Information | Order Code | Included with: | Options |
|---|--|--|---|
| Panel Frame Assembly 1. Pattern Number 2. Top cap type 3. Top cap trim finish 4. Raceway knockout option 5. Base raceway finish if required | Topway Panel Frame Assembly Example: DP7CRR6448 4/117K/117 DP7CRR Topway Panel Frame 6448 Assembly with Base Raceway <hr/> 4 Radius metal topcap <hr/> 117 Soft Grey top cap finish <hr/> K Raceway knockouts <hr/> 117 Soft Grey raceway finish | Panel Frame Assembly: <ul style="list-style-type: none"> Panel frame Top cap (optional) Connection hardware Base raceway Note: 15" wide panels are only available with a standard base raceway or tile to floor. | Panel Frame Assembly: Option: (C) = Topway Panel Frame (V) = Full View Panel Frame Panel Base Options Open Panel Base Option: For open panel base, change 'RR' to 'LL'. Tile to Floor Option: For tile to floor on one side and base raceway on the other side change 'RR' to 'FR' and add \$34 to list price. Top Cap Options: (2) = Extruded Plastic (Smooth Radius) (3) = No Top Cap (4) = Radius Metal, add \$40 P1, \$42 P2, \$44 P3 paint grades (5) = Flat Metal, add \$40 P1, \$42 P2, \$44 P3 paint grades Base Raceway Knockout Options: (for RR and RF base only) (K) = Knockouts on raceway side (N) = No knockouts |

Topway and Full View Panel Frame Assemblies 78" High

Dividends Horizon

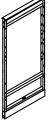
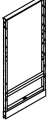
| description | h | w | d | pattern no. | list |
|---|-----------------------------------|-----|----|---------------------|--------|
| 78" High Panel Frame Assembly | 78 ⁹ / ₁₆ " | 15" | 3" | DP7()RR7815 | \$345. |
| Standard Base Raceway | 78 ⁹ / ₁₆ " | 18" | 3" | DP7()RR7818 | 345. |
|  | 78 ⁹ / ₁₆ " | 24" | 3" | DP7()RR7824 | 365. |
|  | 78 ⁹ / ₁₆ " | 30" | 3" | DP7()RR7830 | 380. |
| | 78 ⁹ / ₁₆ " | 36" | 3" | DP7()RR7836 | 408. |
| | 78 ⁹ / ₁₆ " | 42" | 3" | DP7()RR7842 | 431. |
| | 78 ⁹ / ₁₆ " | 48" | 3" | DP7()RR7848 | 449. |

(topway and full view shown)

Dimensions listed under h w d are actual to the nearest 1/16"

| Ordering Information | Order Code | Included with: | Options |
|---|---|--|---|
| Panel Frame Assembly 1. Pattern Number 2. Top cap type 3. Top cap trim finish 4. Raceway knockout option 5. Base raceway finish if required | Topway Panel Frame Assembly <i>Example:</i> DP7CRR7848 4/117K/117 DP7CRR Topway Panel Frame 7848 Assembly with Base Raceway <hr/> 4 Radius metal topcap <hr/> 117 Soft Grey top cap finish <hr/> K Raceway knockouts <hr/> 117 Soft Grey raceway finish | Panel Frame Assembly: <ul style="list-style-type: none"> Panel frame Top cap (optional) Connection hardware Base raceway Note: 15" wide panels are only available with a standard base raceway or tile to floor. | Panel Frame Assembly: Option: (C) = Topway Panel Frame (V) = Full View Panel Frame Panel Base Options Open Panel Base Option: For open panel base, change 'RR' to 'LL'. Tile to Floor Option: For tile to floor on one side and base raceway on the other side change 'RR' to 'FR' and add \$34 to list price. Top Cap Options: (2) = Extruded Plastic (Smooth Radius) (3) = No Top Cap (4) = Radius Metal, add \$40 P1, \$42 P2, \$44 P3 paint grades (5) = Flat Metal, add \$40 P1, \$42 P2, \$44 P3 paint grades Base Raceway Knockout Options: (for RR and RF base only) (K) = Knockouts on raceway side (N) = No knockouts |

This page intentionally left blank

Stack Frames

Dividends Horizon stack frames provide the flexibility to increase the overall height of a standard Dividends Horizon panel.

Stack frames are available in three panel heights, 14", 21" and 28" all capable of attaching to any panel height. Maximum stacking height above the "base" standard panel is 28". This can be accomplished with one 28" high stack panel or by stacking two 14" high panels on each other.

21" stack panel frames may be attached to 42" standard Dividends Horizon panels allowing the overall panel height to be 64" or to 57" panels for an overall height of 78".

The 28" high stack panel frame is prepunched to accept tile insert support rails to provide a tiled look if required.

Stack Frame Options

Dividends Horizon offers two stack panel frame options, which are selected depending on customer's aesthetic and functional needs.

D1 Style Stack Frame Planning

D1 style stack frames feature a D1 style painted aluminum horizontal trim at the bottom of each stack frame. D1 style stack frames mount on top of Dividends Horizon topway panel frames only. D1 style stack panels are load bearing on the first tier only.

Note: When stacking (2) D1 style stack frames, the stack frame in the first tier position must have a topway to be able to accept the second tier stack frame.

D2 Style Stack Frame Planning

D2 style stack frames feature a D2 style black recessed horizontal reveal at the bottom of each stack frame. D2 style stack frames mount on top of Dividends Horizon DP7V full view panel frames only. D2 style stack frames are load bearing on the first or second tier, and are designed to align overhead storage components hung at 64" with overhead components hung off 64" full height panels. Components hung on stack panels at 50" or 57" will not align with components hung off 50" or 57" full height panels.

D2 style stack frames also have the option to be used with tiled or monolithic tiles on one or both side of the base/stack panel assembly. See options on panel pricing page.

Note: The single and double pane window insert kits are not compatible with the D2 style stack frame. Use D1 style stack frames with single or double pane window insert kits.

Note: D2 style stack frames are not compatible with slatwall tiles.

Stack Panel Dimensions

- Widths: 18", 24", 30", 36", 42", and 48"
- Heights: 14", 21" and 28"
- Thickness: 3"

Construction

The stack panel frame is an all-welded steel construction.

- Topway: 22-gauge roll-formed steel (if applicable)
- Vertical channels: 16-gauge roll-formed steel
- Horizontal rails: 16-gauge steel tubing

Panel Trim

When stack panels are installed, the "base" standard panel's top cap is utilized by attaching to the top of the stack panel.

Panel end trim is ordered separately from the stack panel. To specify panel end trim for the end of a panel run, simply add the stack panel and base panel frame height (i.e., a 50" high base panel frame with one 14" high stack panel will require a 64" high panel end trim kit).

In a high-to-low panel-to-panel application where stack panels are used, simply deduct the panel height difference between the two panels to determine size of the high-to-low panel end trim required.

Post Trim

Post trim covers must match the overall height of the "base" standard post and stack post.

Stack Post (Same-height panels)

When two or more stack panels are connected together in a 2-way "L", 3-way "T" or a 4-way "X" condition, and all the panel heights are of the same height, a stack panel post kit may be used.

The stack post kit attaches to the top of a base universal post and is available in a 14" or 28" height and ships with connecting hardware.

Stack Post (Multi-height panels)

When stack panels are used in a high-to-low panel-to-post applications, high-to-low post trim must be ordered separately.

Note: A universal post must match the height of the tallest base standard panel being connected.

Construction

Posts are 3" square extruded aluminum construction.

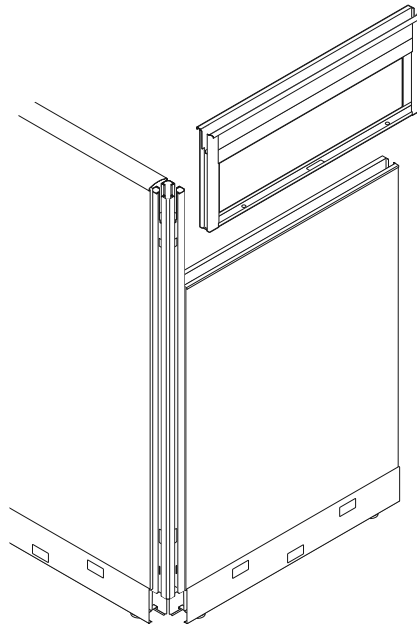

Stack Frame

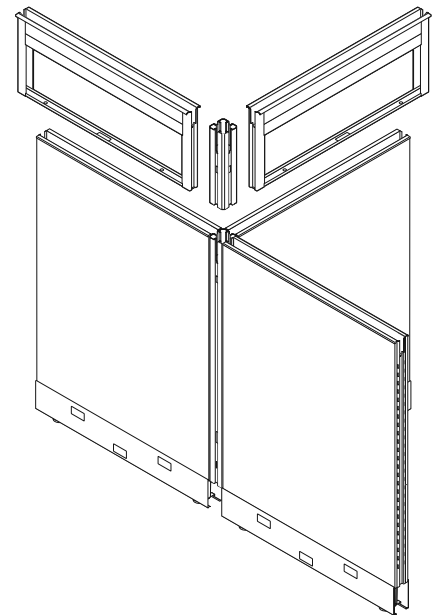



Stack Post (Same-Height Panels)

Stack Frames

D1 Style With External Reveal

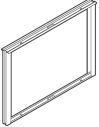
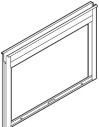
(For Use With Topway Panels Only)

| description | h | w | d | pattern no. | with topway | full view (without topway) |
|--|---------|-----|----|------------------------|-------------|-------------------------------|
| 28" High Stack Panel Frame Only (full view shown)  | 29 1/4" | 18" | 3" | DP2S(T/N)F 2818 | \$180. | \$215. |
| | 29 1/4" | 24" | 3" | DP2S(T/N)F 2824 | 183. | 227. |
| | 29 1/4" | 30" | 3" | DP2S(T/N)F 2830 | 200. | 241. |
| | 29 1/4" | 36" | 3" | DP2S(T/N)F 2836 | 224. | 260. |
| | 29 1/4" | 42" | 3" | DP2S(T/N)F 2842 | 240. | 281. |
| | 29 1/4" | 48" | 3" | DP2S(T/N)F 2848 | 253. | 290. |
| 21" High Stack Panel Frame Only  | 21 7/8" | 18" | 3" | DP2STF 2118 | 184. | n/a |
| | 21 7/8" | 24" | 3" | DP2STF 2124 | 198. | n/a |
| | 21 7/8" | 30" | 3" | DP2STF 2130 | 213. | n/a |
| | 21 7/8" | 36" | 3" | DP2STF 2136 | 233. | n/a |
| | 21 7/8" | 42" | 3" | DP2STF 2142 | 256. | n/a |
| | 21 7/8" | 48" | 3" | DP2STF 2148 | 266. | n/a |
| 14" High Stack Panel, load bearing  | 14" | 18" | 3" | DP2 STFL1418 | 150. | n/a |
| | 14" | 24" | 3" | DP2 STFL1424 | 155. | n/a |
| | 14" | 30" | 3" | DP2 STFL1430 | 180. | n/a |
| | 14" | 36" | 3" | DP2 STFL1436 | 199. | n/a |
| | 14" | 42" | 3" | DP2 STFL1442 | 220. | n/a |
| | 14" | 48" | 3" | DP2 STFL1448 | 236. | n/a |
| 14" High Stack Panel non-load bearing  | 14" | 18" | 3" | DP2S(T/N)F 1418 | 150. | 180. |
| | 14" | 24" | 3" | DP2S(T/N)F 1424 | 155. | 183. |
| | 14" | 30" | 3" | DP2S(T/N)F 1430 | 180. | 200. |
| | 14" | 36" | 3" | DP2S(T/N)F 1436 | 199. | 224. |
| | 14" | 42" | 3" | DP2S(T/N)F 1442 | 220. | 240. |
| | 14" | 48" | 3" | DP2S(T/N)F 1448 | 236. | 253. |

Panels, Build-To-Spec

NOTE: D1 Stack Frames may be used with Topway Panels only.

| Ordering Information | Order Code | Included with: | Options |
|---|---|--|---|
| Stack Panel Frame 1. Pattern Number 2. Trim Finish | Stack Panel Frame <i>Example:</i> DP2STF 1448, 113 DP1STF Pattern Number 1448 113 Dark grey paint finish Stack Panel Post <i>Example:</i> DP2ASPO 14 DP2ASPO Pattern Number 14 | Stack Panel Frame Note: When stacking (2) D1 style stack frames, the stack frame in the first tier position must have a topway trough to be able to accept the second tier stack frame. | Stack Panel Frame Stack frame option: (T) = with topway (N) = without topway Note: 21" stack panel frame not available without a topway. Note: D1 Stack Frames are load bearing on first tier only. |

Stack Frames
D2 Style With Recessed Reveal
(For Use With DP7 Full View Panels Only)

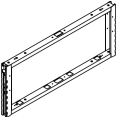
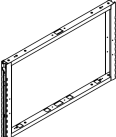
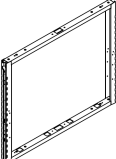
| description | w | h | d | pattern no. | list |
|--|-----|----------------------------------|----|---------------------|--------|
|  14" High Dividends Stack Frame | 18" | 14 ⁵ / ₈ " | 3" | DPS7V1418() | \$227. |
| | 24" | 14 ⁵ / ₈ " | 3" | DPS7V1424() | 230. |
| | 30" | 14 ⁵ / ₈ " | 3" | DPS7V1430() | 251. |
| | 36" | 14 ⁵ / ₈ " | 3" | DPS7V1436() | 272. |
| | 42" | 14 ⁵ / ₈ " | 3" | DPS7V1442() | 281. |
| | 48" | 14 ⁵ / ₈ " | 3" | DPS7V1448() | 289. |
|  21" High Dividends Stack Frame | 18" | 21 ⁷ / ₈ " | 3" | DPS7V2118() | 263. |
| | 24" | 21 ⁷ / ₈ " | 3" | DPS7V2124() | 278. |
| | 30" | 21 ⁷ / ₈ " | 3" | DPS7V2130() | 290. |
| | 36" | 21 ⁷ / ₈ " | 3" | DPS7V2136() | 309. |
| | 42" | 21 ⁷ / ₈ " | 3" | DPS7V2142() | 319. |
| | 48" | 21 ⁷ / ₈ " | 3" | DPS7V2148() | 329. |
|  28" High Dividends Stack Frame | 18" | 29 ¹ / ₄ " | 3" | DPS7V2818() | 252. |
| | 24" | 29 ¹ / ₄ " | 3" | DPS7V2824() | 265. |
| | 30" | 29 ¹ / ₄ " | 3" | DPS7V2830() | 282. |
| | 36" | 29 ¹ / ₄ " | 3" | DPS7V2836() | 305. |
| | 42" | 29 ¹ / ₄ " | 3" | DPS7V2842() | 319. |
| | 48" | 29 ¹ / ₄ " | 3" | DPS7V2848() | 330. |

NOTE: D2 Stack Frames may be used with DP7 Full View Panels only.

| Ordering Information | Order Code | Included with: | Options |
|--|--|--|---|
| Stack Frames: 1. Pattern Number 2. Tile Support Configuration | Stack Panel Frame Assembly <i>Example:</i> DPS7V1418TT <hr/> DPS7 Stack Panel Frame <hr/> V Full View <hr/> 14 Height <hr/> 18 Width <hr/> TT Segmented Tile Supports Both Side | Stack Panel Frame: <ul style="list-style-type: none"> Stack Frame <p>Note: Slatwall tiles, single pane and double pane window kits cannot be used with D2 stack frames.</p> <p>Note: D2 Stack Frames are load bearing on first and second tier.</p> | Tile Options/Pattern Number Suffix: <p>(TT) = Tile support located at the base of stacker to support segmented tiles on both sides of a panel.</p> <p>(TM) = Tile support located at the base of the stacker to support segmented tiles on one side and a monolithic tile on the other side of the panel.</p> <p>(MM) = Monolithic tiles on both sides of the panel.</p> |

This page intentionally left blank

Monolithic Fabric Inserts

Dividends Horizon monolithic inserts are available by component for use with panel frames or wall mount tracks for "Build-to-Spec" applications. These applications include when inserts are only required on one panel side, when a different fabric is required on each panel side, or when wall mount tracks are being used.

Tile to floor option available for worksurface height, 36", 42", 50", 57", 64" and 78" panel heights.

Monolithic Fabric Insert Construction

Fabric laminated with adhesive, heat-cured to 7/16" thick tackable acoustical board.

Monolithic Fabric Insert Ratings

Noise Reduction Coefficient (NRC) rating: .70
Sound Transmission Class (STC) rating: 11

The materials in Dividends Horizon panels meet the flame spread and smoke generation criteria established in UL1286 safety standard for office furniture.

Monolithic Fabric Insert Attachment

Panel inserts flex to attach to the troughs in the upper and lower horizontal panel frame supports or to the bottom tile channel in a wall mount track application. Mounting clips are attached to panel inserts for connection to the vertical frame or wall mount tracks for additional support. No tools are required for insert attachment.

Note: If additional mid-span support for monolithic panel inserts is required, a beltway cable tray can be installed.

Note: Insert dimensions are nominal. Inserts are for one side only.

Note: Worksurface height monolithic tiles are to be used with worksurface height panel frames only.

Monolithic Fabric Insert

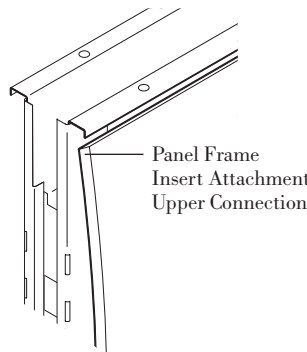
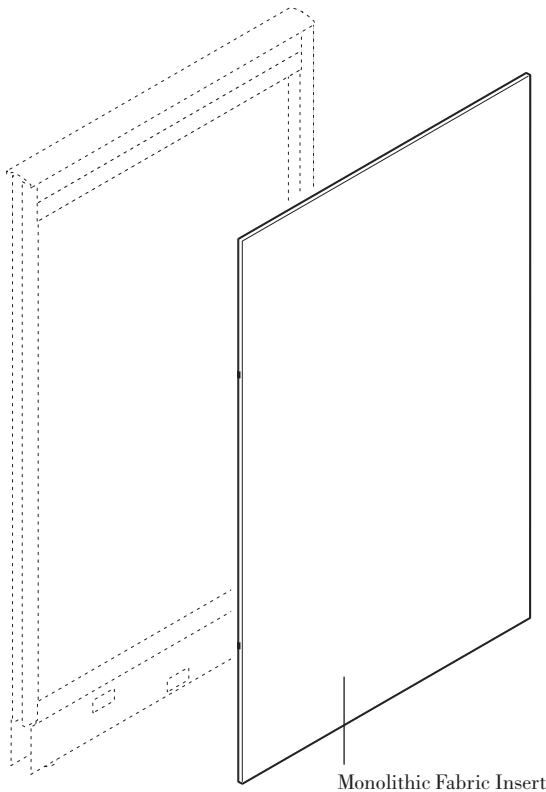

Monolithic Fabric Insert Attachment

Monolithic Fabric Insert Configurations



Worksurface Height
• One worksurface height monolithic insert



36"H Panel Frames
• One 28"H monolithic insert



42"H Panel Frames
• One 35"H monolithic insert



50"H Panel Frames
• One 42"H monolithic insert



57"H Panel Frames
• One 49"H monolithic insert



64"H Panel Frames
• One 56"H monolithic insert

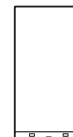





78"H Panel Frames
• One 70"H monolithic insert

Monolithic Panel Fabric Inserts

For Worksurface Height, 36", 42" and 50" High Panel Frames

Dividends Horizon

| description | w* | w | h | d | pattern no. | grade | | | | | | | |
|--|-----|----------------------------------|-----------------------------------|----------------------------------|-------------|-------|--------|--------|--------|--------|--------|--------|--------|
| | | | | | | 10 | 15 | 20 | 25 | 30 | 35 | 40 | 45 |
| Worksurface Height Individual Monolithic Fabric Insert (For worksurface height Panel Frame only)  | 15" | 14 ³ / ₈ " | 22 ¹ / ₂ " | 3" | DP1SOWH15 | \$96. | \$104. | \$109. | \$116. | \$121. | \$126. | \$132. | \$136. |
| | 18" | 17 ³ / ₈ " | 22 ¹ / ₂ " | 3" | DP1SOWH18 | 96. | 104. | 109. | 116. | 121. | 126. | 132. | 136. |
| | 24" | 23 ³ / ₈ " | 22 ¹ / ₂ " | 3" | DP1SOWH24 | 119. | 123. | 136. | 142. | 148. | 151. | 156. | 170. |
| | 30" | 29 ³ / ₈ " | 22 ¹ / ₂ " | 3" | DP1SOWH30 | 130. | 136. | 148. | 154. | 161. | 170. | 174. | 183. |
| | 36" | 35 ³ / ₈ " | 22 ¹ / ₂ " | 3" | DP1SOWH36 | 141. | 148. | 161. | 171. | 180. | 186. | 190. | 198. |
| | 42" | 41 ³ / ₈ " | 22 ¹ / ₂ " | 3" | DP1SOWH42 | 147. | 153. | 163. | 172. | 182. | 187. | 194. | 204. |
| | 48" | 47 ³ / ₈ " | 22 ¹ / ₂ " | 3" | DP1SOWH48 | 153. | 161. | 174. | 183. | 188. | 196. | 207. | 217. |
| | 60" | 59 ³ / ₈ " | 22 ¹ / ₂ " | 3" | DP1SOWH60 | 175. | 180. | 187. | 190. | 198. | 201. | 211. | 223. |
| 28" High Individual Monolithic Fabric Insert (For 36"H Panel Frame)  | 15" | 14 ³ / ₈ " | 29" | 7 ¹ / ₁₆ " | DP1SO2815 | 100. | 104. | 107. | 114. | 116. | 122. | 128. | 133. |
| | 18" | 17 ³ / ₈ " | 29" | 7 ¹ / ₁₆ " | DP1SO2818 | 100. | 104. | 107. | 114. | 116. | 122. | 128. | 133. |
| | 24" | 23 ³ / ₈ " | 29" | 7 ¹ / ₁₆ " | DP1SO2824 | 115. | 122. | 133. | 138. | 145. | 148. | 152. | 163. |
| | 30" | 29 ³ / ₈ " | 29" | 7 ¹ / ₁₆ " | DP1SO2830 | 127. | 133. | 145. | 150. | 156. | 163. | 168. | 178. |
| | 36" | 35 ³ / ₈ " | 29" | 7 ¹ / ₁₆ " | DP1SO2836 | 137. | 145. | 156. | 164. | 176. | 182. | 186. | 191. |
| | 42" | 41 ³ / ₈ " | 29" | 7 ¹ / ₁₆ " | DP1SO2842 | 142. | 149. | 157. | 167. | 177. | 183. | 189. | 198. |
| | 48" | 47 ³ / ₈ " | 29" | 7 ¹ / ₁₆ " | DP1SO2848 | 149. | 156. | 168. | 178. | 184. | 190. | 199. | 213. |
| | 60" | 59 ³ / ₈ " | 29" | 7 ¹ / ₁₆ " | DP1SO2860 | 176. | 180. | 188. | 191. | 196. | 201. | 207. | 211. |
| 35" High Individual Monolithic Fabric Insert (For 42"H Panel Frame)  | 15" | 14 ³ / ₈ " | 36 ³ / ₈ " | 7 ¹ / ₁₆ " | DP1SO4215 | 110. | 116. | 127. | 134. | 139. | 141. | 148. | 152. |
| | 18" | 17 ³ / ₈ " | 36 ³ / ₈ " | 7 ¹ / ₁₆ " | DP1SO4218 | 110. | 116. | 127. | 134. | 139. | 141. | 148. | 152. |
| | 24" | 23 ³ / ₈ " | 36 ³ / ₈ " | 7 ¹ / ₁₆ " | DP1SO4224 | 127. | 133. | 142. | 148. | 154. | 161. | 164. | 173. |
| | 30" | 29 ³ / ₈ " | 36 ³ / ₈ " | 7 ¹ / ₁₆ " | DP1SO4230 | 139. | 148. | 161. | 164. | 176. | 179. | 183. | 189. |
| | 36" | 35 ³ / ₈ " | 36 ³ / ₈ " | 7 ¹ / ₁₆ " | DP1SO4236 | 154. | 163. | 178. | 183. | 185. | 196. | 201. | 211. |
| | 42" | 41 ³ / ₈ " | 36 ³ / ₈ " | 7 ¹ / ₁₆ " | DP1SO4242 | 177. | 183. | 198. | 207. | 214. | 219. | 225. | 235. |
| | 48" | 47 ³ / ₈ " | 36 ³ / ₈ " | 7 ¹ / ₁₆ " | DP1SO4248 | 185. | 192. | 213. | 217. | 228. | 235. | 241. | 251. |
| | 60" | 59 ³ / ₈ " | 36 ³ / ₈ " | 7 ¹ / ₁₆ " | DP1SO4260 | 192. | 199. | 210. | 214. | 218. | 222. | 225. | 231. |
| 42" High Individual Monolithic Fabric Insert (For 50"H Panel Frame)  | 15" | 14 ³ / ₈ " | 43 ¹ / ₁₆ " | 7 ¹ / ₁₆ " | DP1SO5015 | 123. | 130. | 139. | 142. | 150. | 154. | 161. | 167. |
| | 18" | 17 ³ / ₈ " | 43 ¹ / ₁₆ " | 7 ¹ / ₁₆ " | DP1SO5018 | 123. | 130. | 139. | 142. | 150. | 154. | 161. | 167. |
| | 24" | 23 ³ / ₈ " | 43 ¹ / ₁₆ " | 7 ¹ / ₁₆ " | DP1SO5024 | 137. | 145. | 156. | 161. | 167. | 176. | 179. | 185. |
| | 30" | 29 ³ / ₈ " | 43 ¹ / ₁₆ " | 7 ¹ / ₁₆ " | DP1SO5030 | 154. | 163. | 178. | 183. | 189. | 196. | 201. | 210. |
| | 36" | 35 ³ / ₈ " | 43 ¹ / ₁₆ " | 7 ¹ / ₁₆ " | DP1SO5036 | 178. | 185. | 199. | 207. | 214. | 218. | 227. | 236. |
| | 42" | 41 ³ / ₈ " | 43 ¹ / ₁₆ " | 7 ¹ / ₁₆ " | DP1SO5042 | 196. | 208. | 223. | 228. | 238. | 244. | 252. | 261. |
| | 48" | 47 ³ / ₈ " | 43 ¹ / ₁₆ " | 7 ¹ / ₁₆ " | DP1SO5048 | 216. | 228. | 243. | 252. | 261. | 268. | 275. | 287. |
| | 60" | 59 ³ / ₈ " | 43 ¹ / ₁₆ " | 7 ¹ / ₁₆ " | DP1SO5060 | 249. | 257. | 269. | 274. | 282. | 286. | 290. | 298. |

w* = nominal width
 Dimensions listed under w h d are actual to the nearest 1/16"

| Ordering Information | Order Code | Included with: | Options |
|--|--|--|--|
| Monolithic Fabric Inserts 1. Pattern Number 2. Fabric | Monolithic Fabric Inserts <hr/> <i>Example:</i> DP1 SO6442, W351-3 DP1 Pattern Number SO6442 <hr/> W351-3 Foundation Corn Silk Fabric | Monolithic Fabric Inserts • Attachment clips Note: Worksurface height monolithic tiles are to be used with worksurface height panel frames only. | Monolithic Fabric Inserts Tile to Floor Option: To specify tile to floor for use with panel frames, add an "F" suffix to the pattern number and add \$11 to the list price. Note: Tile to floor option available for Worksurface Heights, 36", 42", 50", 57", 64" and 78" panel heights. |

Panels, Build-To-Spec

Monolithic Panel Fabric Inserts

For 57", 64" and 78" High Panel Frames

Dividends Horizon

| description | w* | w | h | d | pattern no. | grade | | | | | | | | |
|--|-----|----------------------------------|-----------------------------------|--------------------------------|------------------|--------|--------|--------|--------|--------|--------|--------|--------|--|
| | | | | | | 10 | 15 | 20 | 25 | 30 | 35 | 40 | 45 | |
| 49" High Individual Monolithic Fabric Insert (For 57"H Panel Frame) | 15" | 14 ³ / ₈ " | 50 ¹ / ₁₆ " | ⁷ / ₁₆ " | DP1SO5715 | \$136. | \$139. | \$148. | \$150. | \$154. | \$156. | \$159. | \$163. | |
| | 18" | 17 ³ / ₈ " | 50 ¹ / ₁₆ " | ⁷ / ₁₆ " | DP1SO5718 | 136. | 139. | 148. | 150. | 154. | 156. | 159. | 163. | |
| | 24" | 23 ³ / ₈ " | 50 ¹ / ₁₆ " | ⁷ / ₁₆ " | DP1SO5724 | 151. | 154. | 162. | 166. | 171. | 175. | 178. | 182. | |
| | 30" | 29 ³ / ₈ " | 50 ¹ / ₁₆ " | ⁷ / ₁₆ " | DP1SO5730 | 175. | 179. | 187. | 189. | 193. | 199. | 202. | 209. | |
| | 36" | 35 ³ / ₈ " | 50 ¹ / ₁₆ " | ⁷ / ₁₆ " | DP1SO5736 | 193. | 201. | 212. | 215. | 219. | 224. | 228. | 235. | |
| | 42" | 41 ³ / ₈ " | 50 ¹ / ₁₆ " | ⁷ / ₁₆ " | DP1SO5742 | 215. | 220. | 231. | 236. | 242. | 246. | 252. | 258. | |
| | 48" | 47 ³ / ₈ " | 50 ¹ / ₁₆ " | ⁷ / ₁₆ " | DP1SO5748 | 235. | 241. | 251. | 258. | 263. | 269. | 272. | 282. | |
| | 60" | 59 ³ / ₈ " | 50 ¹ / ₁₆ " | ⁷ / ₁₆ " | DP1SO5760 | 270. | 279. | 290. | 297. | 306. | 312. | 317. | 323. | |
| 56" High Individual Monolithic Fabric Insert (For 64"H Panel Frame) | 15" | 14 ³ / ₈ " | 58 ¹ / ₄ " | ⁷ / ₁₆ " | DP1SO6415 | 150. | 157. | 173. | 178. | 184. | 189. | 192. | 202. | |
| | 18" | 17 ³ / ₈ " | 58 ¹ / ₄ " | ⁷ / ₁₆ " | DP1SO6418 | 150. | 157. | 173. | 178. | 184. | 189. | 192. | 202. | |
| | 24" | 23 ³ / ₈ " | 58 ¹ / ₄ " | ⁷ / ₁₆ " | DP1SO6424 | 163. | 173. | 186. | 190. | 199. | 208. | 211. | 219. | |
| | 30" | 29 ³ / ₈ " | 58 ¹ / ₄ " | ⁷ / ₁₆ " | DP1SO6430 | 190. | 201. | 216. | 224. | 233. | 238. | 244. | 255. | |
| | 36" | 35 ³ / ₈ " | 58 ¹ / ₄ " | ⁷ / ₁₆ " | DP1SO6436 | 213. | 224. | 241. | 245. | 258. | 262. | 270. | 281. | |
| | 42" | 41 ³ / ₈ " | 58 ¹ / ₄ " | ⁷ / ₁₆ " | DP1SO6442 | 231. | 242. | 260. | 268. | 279. | 284. | 292. | 306. | |
| | 48" | 47 ³ / ₈ " | 58 ¹ / ₄ " | ⁷ / ₁₆ " | DP1SO6448 | 253. | 262. | 283. | 291. | 305. | 312. | 319. | 331. | |
| | 60" | 59 ³ / ₈ " | 58 ¹ / ₄ " | ⁷ / ₁₆ " | DP1SO6460 | 261. | 269. | 283. | 287. | 293. | 301. | 308. | 315. | |
| 70" High Individual Monolithic Fabric Insert (For 78"H Panel Frame) | 15" | 14 ³ / ₈ " | 72 ⁷ / ₈ " | ⁷ / ₁₆ " | DP1SO7815 | 176. | 179. | 186. | 189. | 196. | 199. | 202. | 210. | |
| | 18" | 17 ³ / ₈ " | 72 ⁷ / ₈ " | ⁷ / ₁₆ " | DP1SO7818 | 176. | 179. | 186. | 189. | 196. | 199. | 202. | 210. | |
| | 24" | 23 ³ / ₈ " | 72 ⁷ / ₈ " | ⁷ / ₁₆ " | DP1SO7824 | 207. | 211. | 219. | 224. | 229. | 235. | 238. | 244. | |
| | 30" | 29 ³ / ₈ " | 72 ⁷ / ₈ " | ⁷ / ₁₆ " | DP1SO7830 | 231. | 238. | 251. | 255. | 261. | 266. | 270. | 278. | |
| | 36" | 35 ³ / ₈ " | 72 ⁷ / ₈ " | ⁷ / ₁₆ " | DP1SO7836 | 258. | 263. | 278. | 283. | 290. | 293. | 303. | 310. | |
| | 42" | 41 ³ / ₈ " | 72 ⁷ / ₈ " | ⁷ / ₁₆ " | DP1SO7842 | 287. | 296. | 311. | 317. | 323. | 331. | 337. | 346. | |
| | 48" | 47 ³ / ₈ " | 72 ⁷ / ₈ " | ⁷ / ₁₆ " | DP1SO7848 | 315. | 323. | 342. | 347. | 357. | 364. | 368. | 376. | |

w* = nominal width
Dimensions listed under w h d are actual to the nearest ¹/₁₆"

| Ordering Information | Order Code | Included with: | Options |
|----------------------------------|--|---|--|
| Monolithic Fabric Inserts | Monolithic Fabric Inserts | Monolithic Fabric Inserts | Monolithic Fabric Inserts |
| 1. Pattern Number 2. Fabric | <i>Example:</i> DP1 SO6442, W351-3 DP1 Pattern Number SO6442 W351-3 Foundation Corn Silk Fabric | <ul style="list-style-type: none"> Attachment clips Note: Worksurface height monolithic tiles are to be used with worksurface height panel frames only. | Title to Floor Option: To specify tile to floor for use with panel frames, add an "F" suffix to the pattern number and add \$11 to the list price. Note: Tile to floor option available for Worksurface Heights, 36", 42", 50" 57", 64" and 78" panel heights. |

This page intentionally left blank

Monolithic Laminate Inserts

Dividends Horizon monolithic laminate inserts provide another material option for Dividends Horizon panels and wall mount applications. Monolithic tile sizes are for use with frames from worksurface height to 57", and widths of up to 48" in tile to raceway, open base and tile to floor applications. Monolithic laminate tiles may also be wall mounted using wall mount tracks. Monolithic laminate inserts with matching surface and edge are available in the following finishes:

- (114) Folkstone Grey
- (117) Soft Grey
- (118) Bright White
- (119) Pumice

Legacy finishes are not available.

Monolithic Laminate Insert Construction

Surface material: laminate on front and back surface

Edge material: .5mm edgeband

Core material: particle board

Thickness: 7/16 inches

Monolithic Laminate Insert Attachment

Laminate tiles are installed on one side or both sides of a panel frame, or attach to wall mount tracks. Mounting clips are attached to laminate inserts for connection to the panel frame or vertical wall mount tracks.

Note: Insert dimensions are nominal. Insert configurations shown below are for one side only.

Note: Laminate inserts are not compatible with the slotted standard coat hook (DP2CHTP).

Note: Worksurface height monolithic tiles are to be used with worksurface height panel frames only.

Monolithic Laminate Insert

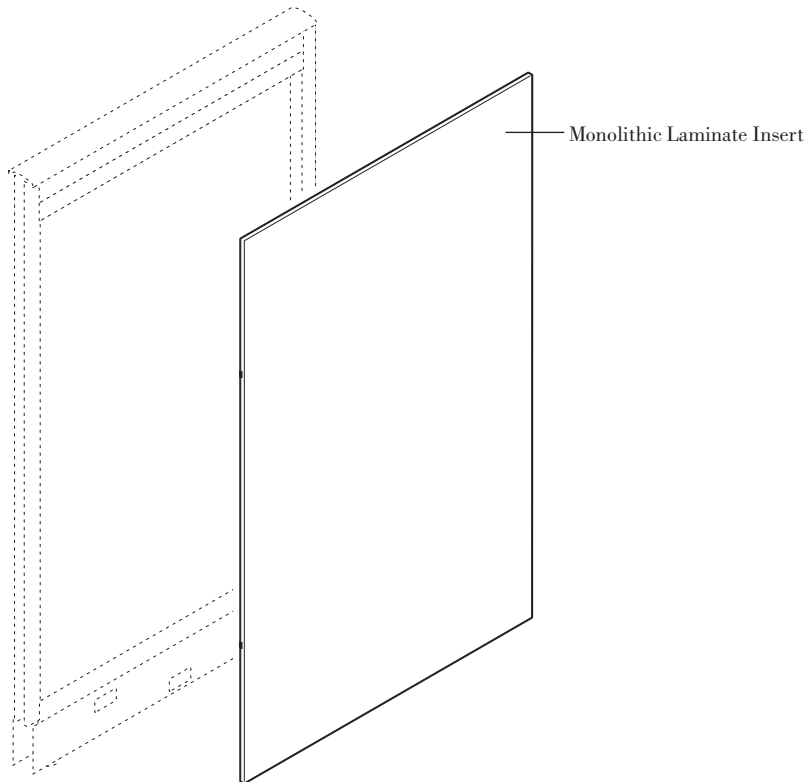

Monolithic Laminate Insert Configurations



Worksurface Height
 • One worksurface height monolithic insert



36"H Panel Frames
 • One 28"H monolithic insert



42"H Panel Frames
 • One 35"H monolithic insert



50"H Panel Frames
 • One 42"H monolithic insert





57"H Panel Frames
 • One 49"H monolithic insert

Monolithic Laminate Inserts

For Worksurface Height, 36" and 42" High Panel Frames

Base Raceway or Open Base

| description | w * | w | h | d | pattern no. | List |
|---|-----|----------------------------------|----------------------------------|--------------------------------|------------------|--------|
| Worksurface Height Individual Monolithic Laminate Insert Base Raceway or Open Base (For worksurface height panel frame only)  | 15" | 14 ⁵ / ₈ " | 22 ¹ / ₂ " | ⁷ / ₁₆ " | DP3L1WH15 | \$172. |
| | 18" | 17 ⁵ / ₈ " | 22 ¹ / ₂ " | ⁷ / ₁₆ " | DP3L1WH18 | 181. |
| | 24" | 23 ⁵ / ₈ " | 22 ¹ / ₂ " | ⁷ / ₁₆ " | DP3L1WH24 | 208. |
| | 30" | 29 ⁵ / ₈ " | 22 ¹ / ₂ " | ⁷ / ₁₆ " | DP3L1WH30 | 242. |
| | 36" | 35 ⁵ / ₈ " | 22 ¹ / ₂ " | ⁷ / ₁₆ " | DP3L1WH36 | 261. |
| | 42" | 41 ⁵ / ₈ " | 22 ¹ / ₂ " | ⁷ / ₁₆ " | DP3L1WH42 | 312. |
| | 48" | 47 ⁵ / ₈ " | 22 ¹ / ₂ " | ⁷ / ₁₆ " | DP3L1WH48 | 317. |
| 28" High Individual Monolithic Laminate Insert Base Raceway or Open Base (For 36"H Panel Frame)  | 15" | 14 ⁵ / ₈ " | 29" | ⁷ / ₁₆ " | DP3L12815 | 172. |
| | 18" | 17 ⁵ / ₈ " | 29" | ⁷ / ₁₆ " | DP3L12818 | 181. |
| | 24" | 23 ⁵ / ₈ " | 29" | ⁷ / ₁₆ " | DP3L12824 | 208. |
| | 30" | 29 ⁵ / ₈ " | 29" | ⁷ / ₁₆ " | DP3L12830 | 242. |
| | 36" | 35 ⁵ / ₈ " | 29" | ⁷ / ₁₆ " | DP3L12836 | 261. |
| | 42" | 41 ⁵ / ₈ " | 29" | ⁷ / ₁₆ " | DP3L12842 | 312. |
| | 48" | 47 ⁵ / ₈ " | 29" | ⁷ / ₁₆ " | DP3L12848 | 317. |
| 35" High Individual Monolithic Laminate Insert Base Raceway or Open Base (For 42"H Panel Frame)  | 15" | 14 ⁵ / ₈ " | 36 ³ / ₈ " | ⁷ / ₁₆ " | DP3L14215 | 207. |
| | 18" | 17 ⁵ / ₈ " | 36 ³ / ₈ " | ⁷ / ₁₆ " | DP3L14218 | 226. |
| | 24" | 23 ⁵ / ₈ " | 36 ³ / ₈ " | ⁷ / ₁₆ " | DP3L14224 | 258. |
| | 30" | 29 ⁵ / ₈ " | 36 ³ / ₈ " | ⁷ / ₁₆ " | DP3L14230 | 309. |
| | 36" | 35 ⁵ / ₈ " | 36 ³ / ₈ " | ⁷ / ₁₆ " | DP3L14236 | 419. |
| | 42" | 41 ⁵ / ₈ " | 36 ³ / ₈ " | ⁷ / ₁₆ " | DP3L14242 | 441. |
| | 48" | 47 ⁵ / ₈ " | 36 ³ / ₈ " | ⁷ / ₁₆ " | DP3L14248 | 445. |

Panels, Build-To-Spec



w* = nominal width
 Dimensions listed under w h d are actual to the nearest 1/16"

| Ordering Information | Order Code | Included with: | Options |
|---|--|---|---|
| Monolithic Laminate Inserts 1. Pattern Number 2. Laminate Finish 3. Edgeband Finish | Monolithic Laminate Inserts <i>Example:</i> DP3L14224 <hr/> DP3L1 Pattern Number <hr/> 4224 <hr/> 118 Bright White Laminate <hr/> 118 Bright White Edgeband | Monolithic Laminate Inserts • Attachment clips Note: Worksurface height monolithic tiles are to be used with worksurface height panel frames only. | Monolithic Laminate Inserts Finish Options: 114 Folkstone Grey 117 Soft Grey 118 Bright White 119 Pumice |

Monolithic Laminate Inserts

Dividends Horizon

For Worksurface Height, 36" and 42" High Panel Frames Tile To Floor

| description | w* | w | d | pattern no. | List |
|---|-----|----------------------------------|---------------------------------|-------------------|--------|
| Worksurface Height Individual Monolithic Laminate Insert Tile To Floor (For worksurface height panel frame only)  | 15" | 14 ⁵ / ₈ " | 7 ¹ / ₆ " | DP3L1WH15F | \$172. |
| | 18" | 17 ³ / ₈ " | 7 ¹ / ₆ " | DP3L1WH18F | 181. |
| | 24" | 23 ³ / ₈ " | 7 ¹ / ₆ " | DP3L1WH24F | 208. |
| | 30" | 29 ³ / ₈ " | 7 ¹ / ₆ " | DP3L1WH30F | 242. |
| | 36" | 35 ³ / ₈ " | 7 ¹ / ₆ " | DP3L1WH36F | 261. |
| | 42" | 41 ³ / ₈ " | 7 ¹ / ₆ " | DP3L1WH42F | 312. |
| | 48" | 47 ³ / ₈ " | 7 ¹ / ₆ " | DP3L1WH48F | 317. |
| 36" High Individual Monolithic Laminate Insert Tile To Floor (For 36"H panel frame)  | 15" | 14 ⁵ / ₈ " | 7 ¹ / ₆ " | DP3L12815F | 172. |
| | 18" | 17 ³ / ₈ " | 7 ¹ / ₆ " | DP3L12818F | 181. |
| | 24" | 23 ³ / ₈ " | 7 ¹ / ₆ " | DP3L12824F | 208. |
| | 30" | 29 ³ / ₈ " | 7 ¹ / ₆ " | DP3L12830F | 242. |
| | 36" | 35 ³ / ₈ " | 7 ¹ / ₆ " | DP3L12836F | 261. |
| | 42" | 41 ³ / ₈ " | 7 ¹ / ₆ " | DP3L12842F | 312. |
| | 48" | 47 ³ / ₈ " | 7 ¹ / ₆ " | DP3L12848F | 317. |
| 42" High Individual Monolithic Laminate Insert Tile To Floor (For 42"H panel frame)  | 15" | 14 ⁵ / ₈ " | 7 ¹ / ₆ " | DP3L14215F | 210. |
| | 18" | 17 ³ / ₈ " | 7 ¹ / ₆ " | DP3L14218F | 242. |
| | 24" | 23 ³ / ₈ " | 7 ¹ / ₆ " | DP3L14224F | 270. |
| | 30" | 29 ³ / ₈ " | 7 ¹ / ₆ " | DP3L14230F | 312. |
| | 36" | 35 ³ / ₈ " | 7 ¹ / ₆ " | DP3L14236F | 422. |
| | 42" | 41 ³ / ₈ " | 7 ¹ / ₆ " | DP3L14242F | 445. |
| | 48" | 47 ³ / ₈ " | 7 ¹ / ₆ " | DP3L14248F | 449. |

w* = nominal width

Dimensions listed under w h d are actual to the nearest 1/16"

Ordering Information

Monolithic Laminate Inserts

1. Pattern Number
2. Laminate Finish
3. Edgeband Finish

Order Code

Monolithic Laminate Inserts

Example: **DP3L14224F**

| | |
|--------------|-----------------------|
| DP3L1 | Pattern Number |
| 4224F | |
| 118 | Bright White Laminate |
| 118 | Bright White Edgeband |

Included with:

Monolithic Laminate Inserts

- Attachment clips
- Note:** Worksurface height monolithic tiles are to be used with worksurface height panel frames only.

Options

Monolithic Laminate Inserts

- Finish Options:**
- | | |
|------------|----------------|
| 114 | Folkstone Grey |
| 117 | Soft Grey |
| 118 | Bright White |
| 119 | Pumice |

Monolithic Laminate Inserts

For 50" and 57" High Panel Frames

Base Raceway or Open Base

| description | w * | w | h | d | pattern no. | List |
|---|-----|----------------------------------|------------------------------------|----------------------------------|------------------|--------|
| 42" High Individual Monolithic Laminate Insert Base Raceway or Open Base (For 50"H Panel Frame) | 15" | 14 ⁵ / ₈ " | 43 ¹¹ / ₁₆ " | 7 ⁷ / ₁₆ " | DP3L15015 | \$212. |
| | 18" | 17 ⁵ / ₈ " | 43 ¹¹ / ₁₆ " | 7 ⁷ / ₁₆ " | DP3L15018 | 244. |
| | 24" | 23 ⁵ / ₈ " | 43 ¹¹ / ₁₆ " | 7 ⁷ / ₁₆ " | DP3L15024 | 272. |
| | 30" | 29 ⁵ / ₈ " | 43 ¹¹ / ₁₆ " | 7 ⁷ / ₁₆ " | DP3L15030 | 315. |
| | 36" | 35 ⁵ / ₈ " | 43 ¹¹ / ₁₆ " | 7 ⁷ / ₁₆ " | DP3L15036 | 424. |
| | 42" | 41 ⁵ / ₈ " | 43 ¹¹ / ₁₆ " | 7 ⁷ / ₁₆ " | DP3L15042 | 447. |
| | 48" | 47 ⁵ / ₈ " | 43 ¹¹ / ₁₆ " | 7 ⁷ / ₁₆ " | DP3L15048 | 451. |
| 49" High Individual Monolithic Laminate Insert Base Raceway or Open Base (For 57"H Panel Frame) | 15" | 14 ⁵ / ₈ " | 50 ¹ / ₁₆ " | 7 ⁷ / ₁₆ " | DP3L15715 | 246. |
| | 18" | 17 ⁵ / ₈ " | 50 ¹ / ₁₆ " | 7 ⁷ / ₁₆ " | DP3L15718 | 264. |
| | 24" | 23 ⁵ / ₈ " | 50 ¹ / ₁₆ " | 7 ⁷ / ₁₆ " | DP3L15724 | 316. |
| | 30" | 29 ⁵ / ₈ " | 50 ¹ / ₁₆ " | 7 ⁷ / ₁₆ " | DP3L15730 | 396. |
| | 36" | 35 ⁵ / ₈ " | 50 ¹ / ₁₆ " | 7 ⁷ / ₁₆ " | DP3L15736 | 430. |
| | 42" | 41 ⁵ / ₈ " | 50 ¹ / ₁₆ " | 7 ⁷ / ₁₆ " | DP3L15742 | 526. |
| | 48" | 47 ⁵ / ₈ " | 50 ¹ / ₁₆ " | 7 ⁷ / ₁₆ " | DP3L15748 | 530. |



Panels, Build-To-Spec

w* = nominal width
 Dimensions listed under w h d are actual to the nearest 1/16"



| Ordering Information | Order Code | Included with: | Options |
|---|--|--|---|
| Monolithic Laminate Inserts 1. Pattern Number 2. Laminate Finish 3. Edgeband Finish | Monolithic Laminate Inserts <i>Example:</i> DP3L15024 <hr/> DP3L1 Pattern Number <hr/> 5024 <hr/> 118 Bright White Laminate <hr/> 118 Bright White Edgeband | Monolithic Laminate Inserts • Attachment clips Note: Worksurface height monolithic tiles are to be used with worksurface height panel frames only. | Monolithic Laminate Inserts Finish Options: 114 Folkstone Grey 117 Soft Grey 118 Bright White 119 Pumice |

Monolithic Laminate Inserts

For 50" and 57" High Panel Frames

Tile To Floor

Dividends Horizon

| description | w * | w | d | pattern no. | List |
|---|-----|----------------------------------|--------------------------------|-------------------|--------|
| 50" High Individual Monolithic Laminate Insert Tile To Floor (For 50"H panel frame)  | 15" | 14 ⁵ / ₈ " | ⁷ / ₁₆ " | DP3L15015F | \$245. |
| | 18" | 17 ⁵ / ₈ " | ⁷ / ₁₆ " | DP3L15018F | 262. |
| | 24" | 23 ⁵ / ₈ " | ⁷ / ₁₆ " | DP3L15024F | 314. |
| | 30" | 29 ⁵ / ₈ " | ⁷ / ₁₆ " | DP3L15030F | 394. |
| | 36" | 35 ⁵ / ₈ " | ⁷ / ₁₆ " | DP3L15036F | 427. |
| | 42" | 41 ⁵ / ₈ " | ⁷ / ₁₆ " | DP3L15042F | 523. |
| | 48" | 47 ⁵ / ₈ " | ⁷ / ₁₆ " | DP3L15048F | 527. |
| 57" High Individual Monolithic Laminate Insert Tile To Floor (for 57"H panel frame)  | 15" | 14 ⁵ / ₈ " | ⁷ / ₁₆ " | DP3L15715F | 251. |
| | 18" | 17 ⁵ / ₈ " | ⁷ / ₁₆ " | DP3L15718F | 268. |
| | 24" | 23 ⁵ / ₈ " | ⁷ / ₁₆ " | DP3L15724F | 319. |
| | 30" | 29 ⁵ / ₈ " | ⁷ / ₁₆ " | DP3L15730F | 399. |
| | 36" | 35 ⁵ / ₈ " | ⁷ / ₁₆ " | DP3L15736F | 434. |
| | 42" | 41 ⁵ / ₈ " | ⁷ / ₁₆ " | DP3L15742F | 528. |
| | 48" | 47 ⁵ / ₈ " | ⁷ / ₁₆ " | DP3L15748F | 532. |

w* = nominal width
 Dimensions listed under w h d are actual to the nearest ¹/₁₆"

| Ordering Information | Order Code | Included with: | Options |
|---|--|--|---|
| Monolithic Laminate Inserts 1. Pattern Number 2. Laminate Finish 3. Edgeband Finish | Monolithic Laminate Inserts <i>Example:</i> DP3L15024F <hr/> DP3L1 Pattern Number <hr/> 5024F <hr/> 118 Bright White Laminate <hr/> 118 Bright White Edgeband | Monolithic Laminate Inserts • Attachment clips Note: Worksurface height monolithic tiles are to be used with worksurface height panel frames only. | Monolithic Laminate Inserts Finish Options: 114 Folkstone Grey 117 Soft Grey 118 Bright White 119 Pumice |

This page intentionally left blank

Tiled Inserts

Dividends Horizon tiled inserts are available by component for use with panel frames or wall mount tracks for "Build-to-Spec" applications. These applications include when inserts are only required on one panel side, when fabrics are mixed tile-to-tile or side-to-side, or when wall mount tracks are being used.

Tiled inserts are also included in "Preconfigured" tiled panel assemblies.

Tiled Insert Construction

Fabric laminated with web adhesive, heat-cured to $\frac{7}{16}$ " thick tackable acoustical board.

Tiled Insert Supports

All Dividends Horizon panel frames and wall mount tracks are pre-punched to accept tiled panel insert supports which span horizontally across the panel frame.

Tiled panel insert supports are mounted above each tiled insert with the exception of the uppermost insert which attaches to the upper panel frame. D1 style insert supports are trim finish to match top caps and raceway covers.

D2 Tile Support Mounting Brackets

D2 tile supports require the use of D2 tile support mounting brackets. One pair of mounting brackets can be used to attach D2 tile supports on one or both sides of a panel at the installed height.

Tiled Insert Attachment

Tiled inserts attach to the troughs in the horizontal panel frame and tiled insert supports or to the bottom tile channel in a wall mount track application. Mounting clips are attached to inserts for connection to the vertical frame or wall mount tracks for additional support. No tools are required for insert attachment.

Note: When attaching cantilevers to tiled panels, they can only be hung at the 28 $\frac{1}{2}$ " worksurface height.

Note: Insert dimensions are nominal. Inserts and tiled supports are for one side only.

Note: Overheads can only be attached to the uppermost position of tiled panels. On 78" H panels the overhead may be positioned on the 4th or 5th tile location from the bottom, but not both locations of a single panel.

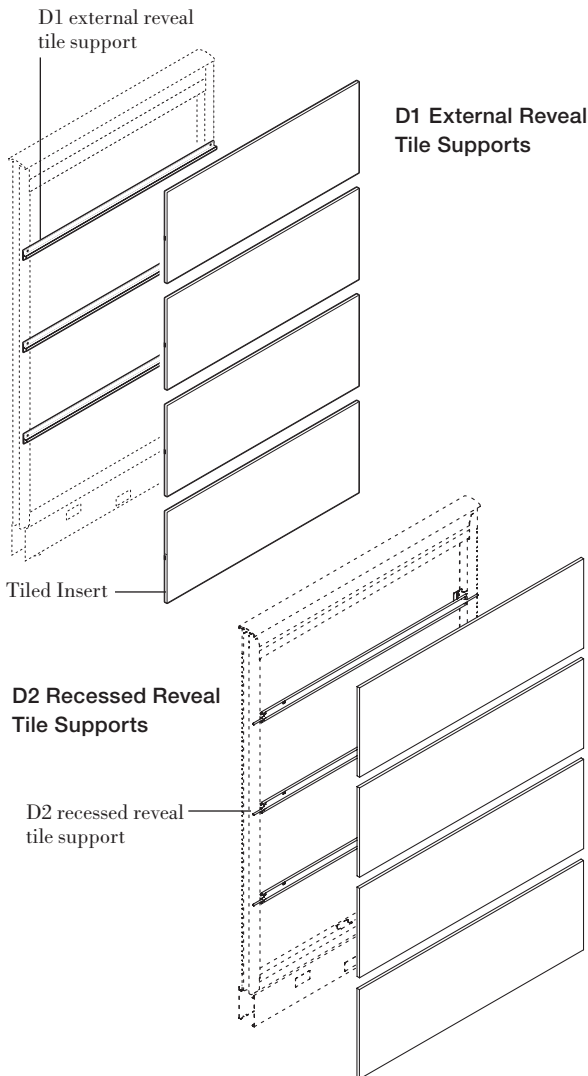

Tiled Insert Configurations

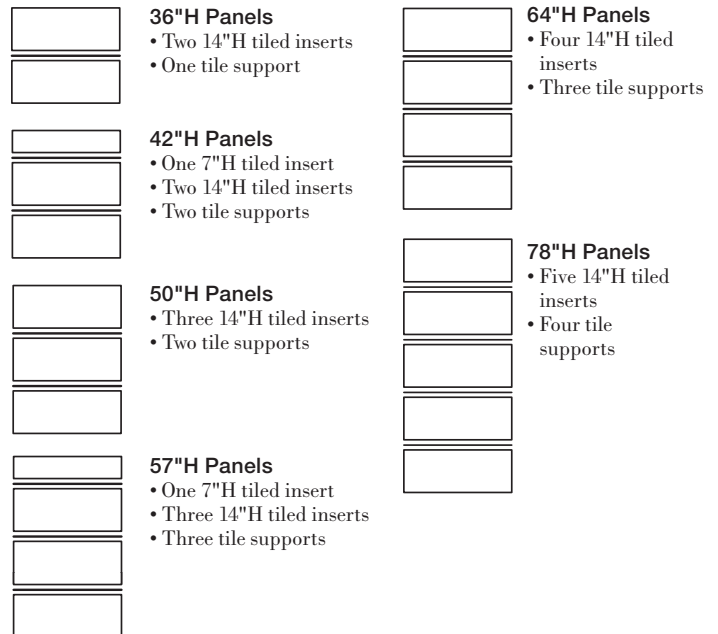

Tiled Insert Attachment (D1 Style)

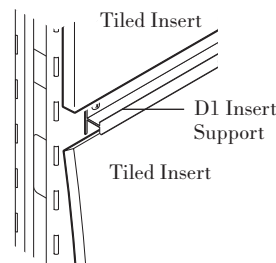

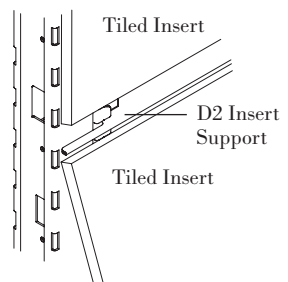

Tiled Insert Attachment (D2 Style)



Tiled Fabric Inserts

7", 10" and 14" High

Dividends Horizon

| description | w* | w | h | d | pattern no. | grade | | | | | | | |
|--|-----|----------------------------------|-----------------------------------|--------------------------------|------------------|-------|-------|-------|-------|-------|-------|-------|-------|
| | | | | | | 10 | 15 | 20 | 25 | 30 | 35 | 40 | 45 |
| 7" High Individual Tiled Fabric Insert  | 15" | 14 ⁵ / ₈ " | 7 ³ / ₁₆ " | ⁷ / ₁₆ " | DP1SO715 | \$44. | \$47. | \$51. | \$57. | \$62. | \$63. | \$66. | \$71. |
| | 18" | 17 ⁵ / ₈ " | 7 ³ / ₁₆ " | ⁷ / ₁₆ " | DP1SO718 | 44. | 47. | 51. | 57. | 62. | 63. | 66. | 71. |
| | 24" | 23 ⁵ / ₈ " | 7 ³ / ₁₆ " | ⁷ / ₁₆ " | DP1SO724 | 47. | 50. | 60. | 62. | 64. | 69. | 70. | 72. |
| | 30" | 29 ⁵ / ₈ " | 7 ³ / ₁₆ " | ⁷ / ₁₆ " | DP1SO730 | 54. | 60. | 66. | 69. | 72. | 74. | 77. | 81. |
| | 36" | 35 ⁵ / ₈ " | 7 ³ / ₁₆ " | ⁷ / ₁₆ " | DP1SO736 | 62. | 64. | 72. | 74. | 77. | 78. | 81. | 84. |
| | 42" | 41 ⁵ / ₈ " | 7 ³ / ₁₆ " | ⁷ / ₁₆ " | DP1SO742 | 66. | 71. | 76. | 78. | 82. | 84. | 86. | 94. |
| | 48" | 47 ⁵ / ₈ " | 7 ³ / ₁₆ " | ⁷ / ₁₆ " | DP1SO748 | 71. | 75. | 79. | 82. | 86. | 90. | 100. | 103. |
| | 60" | 59 ⁵ / ₈ " | 7 ³ / ₁₆ " | ⁷ / ₁₆ " | DP1SO760 | 77. | 79. | 83. | 84. | 87. | 88. | 90. | 94. |
| 10" High Individual Tiled Fabric Insert  | 15" | 14 ⁵ / ₈ " | 10 ⁷ / ₈ " | ⁷ / ₁₆ " | DP1SO1015 | 63. | 66. | 71. | 72. | 75. | 77. | 78. | 81. |
| | 18" | 17 ⁵ / ₈ " | 10 ⁷ / ₈ " | ⁷ / ₁₆ " | DP1SO1018 | 63. | 66. | 71. | 72. | 75. | 77. | 78. | 81. |
| | 24" | 23 ⁵ / ₈ " | 10 ⁷ / ₈ " | ⁷ / ₁₆ " | DP1SO1024 | 69. | 71. | 76. | 77. | 79. | 82. | 84. | 88. |
| | 30" | 29 ⁵ / ₈ " | 10 ⁷ / ₈ " | ⁷ / ₁₆ " | DP1SO1030 | 71. | 74. | 78. | 81. | 83. | 86. | 88. | 94. |
| | 36" | 35 ⁵ / ₈ " | 10 ⁷ / ₈ " | ⁷ / ₁₆ " | DP1SO1036 | 75. | 78. | 83. | 84. | 90. | 94. | 102. | 103. |
| | 42" | 41 ⁵ / ₈ " | 10 ⁷ / ₈ " | ⁷ / ₁₆ " | DP1SO1042 | 78. | 81. | 88. | 90. | 100. | 103. | 105. | 107. |
| | 48" | 47 ⁵ / ₈ " | 10 ⁷ / ₈ " | ⁷ / ₁₆ " | DP1SO1048 | 83. | 84. | 96. | 102. | 105. | 106. | 108. | 115. |
| | 60" | 59 ⁵ / ₈ " | 10 ⁷ / ₈ " | ⁷ / ₁₆ " | DP1SO1060 | 88. | 92. | 97. | 98. | 101. | 102. | 104. | 106. |
| 14" High Individual Tiled Fabric Insert  | 15" | 14 ⁵ / ₈ " | 14 ³ / ₁₆ " | ⁷ / ₁₆ " | DP1SO1415 | 63. | 66. | 71. | 72. | 75. | 77. | 78. | 81. |
| | 18" | 17 ⁵ / ₈ " | 14 ³ / ₁₆ " | ⁷ / ₁₆ " | DP1SO1418 | 63. | 66. | 71. | 72. | 75. | 77. | 78. | 81. |
| | 24" | 23 ⁵ / ₈ " | 14 ³ / ₁₆ " | ⁷ / ₁₆ " | DP1SO1424 | 69. | 71. | 76. | 77. | 79. | 82. | 84. | 88. |
| | 30" | 29 ⁵ / ₈ " | 14 ³ / ₁₆ " | ⁷ / ₁₆ " | DP1SO1430 | 71. | 74. | 78. | 81. | 83. | 86. | 88. | 94. |
| | 36" | 35 ⁵ / ₈ " | 14 ³ / ₁₆ " | ⁷ / ₁₆ " | DP1SO1436 | 75. | 78. | 83. | 84. | 90. | 94. | 102. | 103. |
| | 42" | 41 ⁵ / ₈ " | 14 ³ / ₁₆ " | ⁷ / ₁₆ " | DP1SO1442 | 78. | 81. | 88. | 90. | 100. | 103. | 105. | 107. |
| | 48" | 47 ⁵ / ₈ " | 14 ³ / ₁₆ " | ⁷ / ₁₆ " | DP1SO1448 | 83. | 84. | 96. | 102. | 105. | 106. | 108. | 115. |
| | 60" | 59 ⁵ / ₈ " | 14 ³ / ₁₆ " | ⁷ / ₁₆ " | DP1SO1460 | 88. | 92. | 97. | 98. | 101. | 102. | 104. | 106. |

Panels, Build-To-Spec

w* = nominal width
Dimensions listed under w h d are actual to the nearest 1/16"

| Ordering Information | Order Code | Included with: | Options |
|--|---|--|---|
| Tiled Inserts 1. Pattern Number 2. Fabric | Tiled Inserts Example: DP1 SO1436, W234-5 DP1 Pattern Number SO1436 W234-5 Peano Sand fabric | Tiled Inserts • Attachment clips Note: Tiled insert supports must be ordered separately (see opposite page for quantities required). | Tiled Inserts Title to Floor Option: To specify tile to floor for use with panel frames, add an "F" suffix to the pattern number and add \$11 to the list price. Note: Tile to floor option available for 14" and 28" High inserts. |

Tiled Fabric Inserts

21" and 28" High

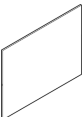
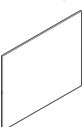
| description | w* | w | h | d | pattern no. | grade | | | | | | | |
|--|---------|----------|----------|------------------|------------------|-------|--------|--------|--------|--------|--------|--------|--------|
| | | | | | | 10 | 15 | 20 | 25 | 30 | 35 | 40 | 45 |
| 21" High Individual Tiled Fabric Insert  | 15" | 14 5/8" | 21 3/16" | 7/16" | DP1SO2115 | \$92. | \$101. | \$106. | \$110. | \$116. | \$122. | \$127. | \$132. |
| | 18" | 17 5/8" | 21 3/16" | 7/16" | DP1SO2118 | 92. | 101. | 106. | 110. | 116. | 122. | 127. | 132. |
| | 24" | 23 5/8" | 21 3/16" | 7/16" | DP1SO2124 | 114. | 119. | 132. | 137. | 142. | 146. | 151. | 162. |
| | 30" | 29 5/8" | 21 3/16" | 7/16" | DP1SO2130 | 124. | 132. | 142. | 149. | 154. | 162. | 167. | 177. |
| | 36" | 35 5/8" | 21 3/16" | 7/16" | DP1SO2136 | 136. | 142. | 154. | 163. | 173. | 180. | 185. | 190. |
| | 42" | 41 5/8" | 21 3/16" | 7/16" | DP1SO2142 | 141. | 148. | 156. | 164. | 176. | 182. | 188. | 196. |
| | 48" | 47 5/8" | 21 3/16" | 7/16" | DP1SO2148 | 148. | 154. | 167. | 177. | 183. | 189. | 198. | 211. |
| 60" | 59 5/8" | 21 3/16" | 7/16" | DP1SO2160 | 162. | 167. | 176. | 179. | 184. | 187. | 189. | 193. | |
| 28" High Individual Tiled Fabric Insert  | 15" | 14 5/8" | 29" | 7/16" | DP1SO2815 | 100. | 104. | 107. | 114. | 116. | 122. | 128. | 133. |
| | 18" | 17 5/8" | 29" | 7/16" | DP1SO2818 | 100. | 104. | 107. | 114. | 116. | 122. | 128. | 133. |
| | 24" | 23 5/8" | 29" | 7/16" | DP1SO2824 | 115. | 122. | 133. | 138. | 145. | 148. | 152. | 163. |
| | 30" | 29 5/8" | 29" | 7/16" | DP1SO2830 | 127. | 133. | 145. | 150. | 156. | 163. | 168. | 178. |
| | 36" | 35 5/8" | 29" | 7/16" | DP1SO2836 | 137. | 145. | 156. | 164. | 176. | 182. | 186. | 191. |
| | 42" | 42 5/8" | 29" | 7/16" | DP1SO2842 | 142. | 149. | 157. | 167. | 177. | 183. | 189. | 198. |
| | 48" | 47 5/8" | 29" | 7/16" | DP1SO2848 | 149. | 156. | 168. | 178. | 184. | 190. | 199. | 213. |
| 60" | 59 5/8" | 29" | 7/16" | DP1SO2860 | 176. | 180. | 188. | 191. | 196. | 201. | 207. | 211. | |

w* = nominal width
Dimensions listed under w h d are actual to the nearest 1/16"

| Ordering Information | Order Code | Included With: | Options |
|--|--|--|---|
| Tiled Inserts 1. Pattern Number 2. Fabric | Tiled Inserts <hr/> <i>Example:</i> DP1 SO1436, W234-5 <hr/> DP1 Pattern Number <hr/> SO1436 <hr/> W234-5 Peano Sand fabric | Tiled Inserts • Attachment clips Note: Tiled insert supports must be ordered separately (see opposite page for quantities required). | Tiled Inserts Title to Floor Option: To specify tile to floor for use with panel frames, add an "F" suffix to the pattern number and add \$11 to the list price. Note: Tile to floor option available for 14" and 28" High inserts. |

Tiled Fabric Inserts

Tile Supports

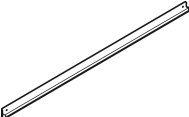
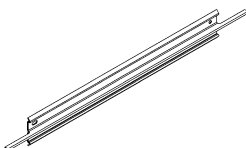
| description | w* | d | pattern no. | list |
|--|-----|------|-----------------|-------|
|  D1 Tile Support/ External Reveal | 15" | 5/8" | DP1SOS15 | \$30. |
| | 18" | 5/8" | DP1SOS18 | 30. |
| | 24" | 5/8" | DP1SOS24 | 31. |
| | 30" | 5/8" | DP1SOS30 | 34. |
| | 36" | 5/8" | DP1SOS36 | 35. |
| | 42" | 5/8" | DP1SOS42 | 37. |
| | 48" | 5/8" | DP1SOS48 | 37. |
| | 60" | 5/8" | DP1SOS60 | 41. |
|  D2 Tile Support/ Recessed Reveal | 15" | | DP2SOS15 | 27. |
| | 18" | | DP2SOS18 | 27. |
| | 24" | | DP2SOS24 | 28. |
| | 30" | | DP2SOS30 | 30. |
| | 36" | | DP2SOS36 | 31. |
| | 42" | | DP2SOS42 | 34. |
| | 48" | | DP2SOS48 | 34. |
| | 60" | | DP2SOS60 | 37. |
| D2 Tile Support Mounting Brackets (pair) | | | DP2SOSC | 7. |

Panels, Build-To-Spec

w* = nominal width
 Dimensions listed under w h d are actual to the nearest 1/16"

| Ordering Information | Order Code | Included with: | Options |
|---|--|---|------------------------------|
| D1 Tile Support / External Reveal 1. Pattern Number 2. Trim Finish | D1 Tile Support / External Reveal Supports <i>Example:</i> DP1 SOS18, 117 | Note: D2 insert supports require mounting brackets. | Tiled Insert Supports |
| D2 Tile Support / Recessed Reveal 1. Pattern Number | DP1 Pattern Number SOS18 117 Soft Grey trim finish | | |

Tiled Laminate Inserts

Dividends Horizon tiled laminate inserts provide another material option for Dividends Horizon panels and wall mount applications. Tiled sizes are for use with frames from 36" to 78" high, and widths of up to 48" in tile to raceway, open base and tile to floor applications. Tiled laminate inserts may also be wall mounted using wall mount tracks. Tiled laminate inserts with matching surface and edge are available in the following finishes:

- (114) Folkstone Grey
- (117) Soft Grey
- (118) Bright White
- (119) Pumice

Legacy finishes are not available.

Tiled Laminate Insert Construction

- Surface material: laminate on front and back surface
- Edge material: .5 mm edgeband
- Core material: particle board
- Thickness: 7/16"

Tiled Insert Supports

All Dividends Horizon panel frames are pre-punched to accept tiled panel insert supports, which span horizontally across the panel frame. Tiled panel insert supports are mounted above each tiled insert with the exception of the uppermost insert which attaches to the upper panel frame. D1 style insert supports are trim finish to match top caps and raceway covers.

D2 Tile Support Mounting Brackets

D2 tile supports require the use of D2 tile support mounting brackets. One pair of mounting brackets can be used to attach D2 tile supports on one or both sides of a panel at the installed height.

Tiled Laminate Insert Attachment

Laminate tiles are installed on one side or both sides of a panel frame or attached to wall mount tracks. Mounting clips are attached to laminate inserts for connection to the panel frame or vertical wall mount tracks.

Tiled Laminate Insert Planning Guidelines

Insert dimensions are nominal. Insert configurations shown below are for one side only. Laminate inserts are not compatible with the slotted standard coat hook (DP2CHTP). When attaching cantilevers to tiled panels, they can only be hung at 28-1/2" worksurface height. Overheads can only be attached to the uppermost position of tiled panels. On 78"-high panels the overhead may be positioned on the 4th or 5th tile location from the bottom, but not both locations of a single panel.

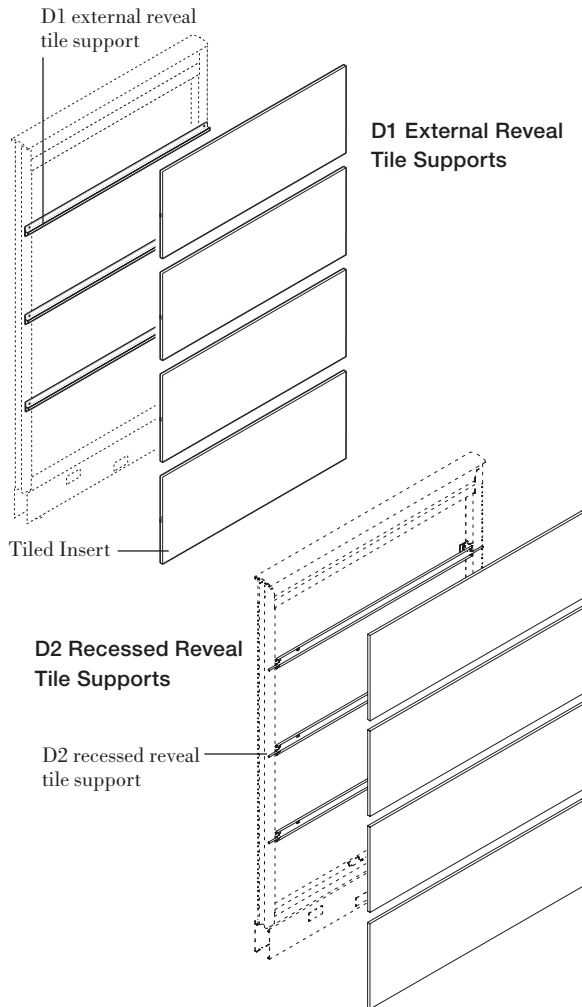



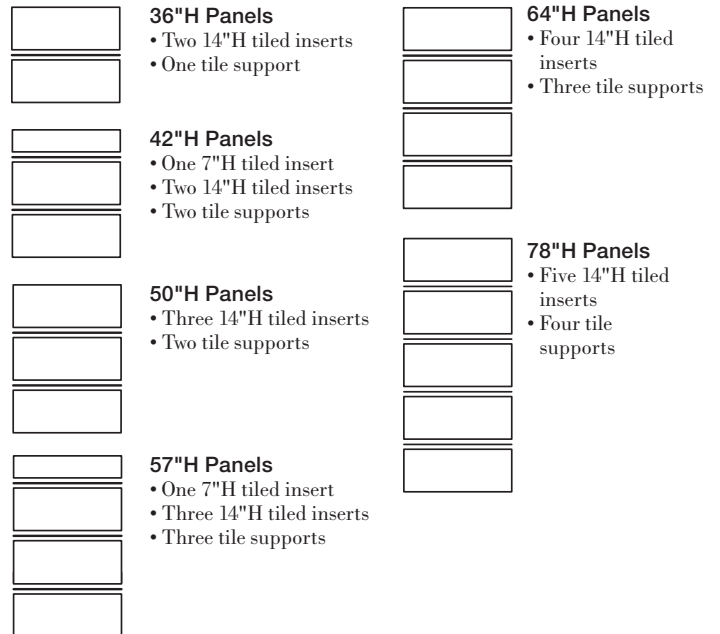

Tiled Insert Configurations



Tiled Laminate Inserts

7", 10", 14", 21" and 28" High

Base Raceway or Open Base

| description | w* | w | h | d | pattern no. | list |
|--|-----|----------------------------------|-----------------------------------|----------------------------------|------------------|--------|
|  7" High Individual Tiled Laminate Insert Base Raceway or Open Base | 15" | 14 ⁵ / ₈ " | 7 ³ / ₁₆ " | 7 ¹ / ₁₆ " | DP3L10715 | \$114. |
| | 18" | 17 ⁵ / ₈ " | 7 ³ / ₁₆ " | 7 ¹ / ₁₆ " | DP3L10718 | 116. |
| | 24" | 23 ⁵ / ₈ " | 7 ³ / ₁₆ " | 7 ¹ / ₁₆ " | DP3L10724 | 120. |
| | 30" | 29 ⁵ / ₈ " | 7 ³ / ₁₆ " | 7 ¹ / ₁₆ " | DP3L10730 | 124. |
| | 36" | 35 ⁵ / ₈ " | 7 ³ / ₁₆ " | 7 ¹ / ₁₆ " | DP3L10736 | 140. |
| | 42" | 41 ⁵ / ₈ " | 7 ³ / ₁₆ " | 7 ¹ / ₁₆ " | DP3L10742 | 145. |
| | 48" | 47 ⁵ / ₈ " | 7 ³ / ₁₆ " | 7 ¹ / ₁₆ " | DP3L10748 | 149. |
|  10" High Individual Tiled Laminate Insert Base Raceway or Open Base | 15" | 14 ⁵ / ₈ " | 10 ³ / ₁₆ " | 7 ¹ / ₁₆ " | DP3L11015 | 118. |
| | 18" | 17 ⁵ / ₈ " | 10 ³ / ₁₆ " | 7 ¹ / ₁₆ " | DP3L11018 | 120. |
| | 24" | 23 ⁵ / ₈ " | 10 ³ / ₁₆ " | 7 ¹ / ₁₆ " | DP3L11024 | 124. |
| | 30" | 29 ⁵ / ₈ " | 10 ³ / ₁₆ " | 7 ¹ / ₁₆ " | DP3L11030 | 137. |
| | 36" | 35 ⁵ / ₈ " | 10 ³ / ₁₆ " | 7 ¹ / ₁₆ " | DP3L11036 | 156. |
| | 42" | 41 ⁵ / ₈ " | 10 ³ / ₁₆ " | 7 ¹ / ₁₆ " | DP3L11042 | 162. |
| | 48" | 47 ⁵ / ₈ " | 10 ³ / ₁₆ " | 7 ¹ / ₁₆ " | DP3L11048 | 167. |
|  14" High Individual Tiled Laminate Insert Base Raceway or Open Base | 15" | 14 ⁵ / ₈ " | 14 ³ / ₁₆ " | 7 ¹ / ₁₆ " | DP3L11415 | 120. |
| | 18" | 17 ⁵ / ₈ " | 14 ³ / ₁₆ " | 7 ¹ / ₁₆ " | DP3L11418 | 122. |
| | 24" | 23 ⁵ / ₈ " | 14 ³ / ₁₆ " | 7 ¹ / ₁₆ " | DP3L11424 | 134. |
| | 30" | 29 ⁵ / ₈ " | 14 ³ / ₁₆ " | 7 ¹ / ₁₆ " | DP3L11430 | 148. |
| | 36" | 35 ⁵ / ₈ " | 14 ³ / ₁₆ " | 7 ¹ / ₁₆ " | DP3L11436 | 174. |
| | 42" | 41 ⁵ / ₈ " | 14 ³ / ₁₆ " | 7 ¹ / ₁₆ " | DP3L11442 | 178. |
| | 48" | 47 ⁵ / ₈ " | 14 ³ / ₁₆ " | 7 ¹ / ₁₆ " | DP3L11448 | 181. |
|  21" High Individual Tiled Laminate Insert Base Raceway or Open Base | 15" | 14 ⁵ / ₈ " | 21 ³ / ₁₆ " | 7 ¹ / ₁₆ " | DP3L12115 | 132. |
| | 18" | 17 ⁵ / ₈ " | 21 ³ / ₁₆ " | 7 ¹ / ₁₆ " | DP3L12118 | 145. |
| | 24" | 23 ⁵ / ₈ " | 21 ³ / ₁₆ " | 7 ¹ / ₁₆ " | DP3L12124 | 171. |
| | 30" | 29 ⁵ / ₈ " | 21 ³ / ₁₆ " | 7 ¹ / ₁₆ " | DP3L12130 | 175. |
| | 36" | 35 ⁵ / ₈ " | 21 ³ / ₁₆ " | 7 ¹ / ₁₆ " | DP3L12136 | 251. |
| | 42" | 41 ⁵ / ₈ " | 21 ³ / ₁₆ " | 7 ¹ / ₁₆ " | DP3L12142 | 254. |
| | 48" | 47 ⁵ / ₈ " | 21 ³ / ₁₆ " | 7 ¹ / ₁₆ " | DP3L12148 | 258. |
|  28" High Individual Tiled Laminate Insert Base Raceway or Open Base | 15" | 14 ⁵ / ₈ " | 29" | 7 ¹ / ₁₆ " | DP3L12815 | 172. |
| | 18" | 17 ⁵ / ₈ " | 29" | 7 ¹ / ₁₆ " | DP3L12818 | 181. |
| | 24" | 23 ⁵ / ₈ " | 29" | 7 ¹ / ₁₆ " | DP3L12824 | 208. |
| | 30" | 29 ⁵ / ₈ " | 29" | 7 ¹ / ₁₆ " | DP3L12830 | 242. |
| | 36" | 35 ⁵ / ₈ " | 29" | 7 ¹ / ₁₆ " | DP3L12836 | 261. |
| | 42" | 41 ⁵ / ₈ " | 29" | 7 ¹ / ₁₆ " | DP3L12842 | 312. |
| | 48" | 47 ⁵ / ₈ " | 29" | 7 ¹ / ₁₆ " | DP3L12848 | 317. |

w* = nominal width
Dimensions listed under w h d are actual to the nearest 1/16"

| Ordering Information | Order Code | Included with: | Options |
|-------------------------------|----------------------------------|---|-------------------------------|
| Tiled Laminate Inserts | Tiled Laminate Inserts | Tiled Laminate Inserts | Tiled Laminate Inserts |
| 1. Pattern Number | <i>Example:</i> DP3L10724 | • Attachment clips | Finish Options: |
| 2. Laminate Finish | DP3L1 Pattern Number | Note: Tiled insert supports must be ordered separately (see opposite page for quantities required) | 114 Folkstone Grey |
| 3. Edgeband Finish | 0724 | | 117 Soft Grey |
| | 118 Bright White Laminate | | 118 Bright White |
| | 118 Bright White Edgeband | | 119 Pumice |

Tiled Laminate Inserts
 14" and 28" High
 Tile To Floor

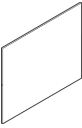
| description | w* | w | d | pattern no. | list |
|---|-----|----------------------------------|--------------------------------|-------------------|--------|
| 14" High Individual Tiled Laminate Insert Tile to Floor  | 15" | 14 ⁵ / ₈ " | ⁷ / ₁₆ " | DP3L11415F | \$127. |
| | 18" | 17 ⁵ / ₈ " | ⁷ / ₁₆ " | DP3L11418F | 135. |
| | 24" | 23 ⁵ / ₈ " | ⁷ / ₁₆ " | DP3L11424F | 147. |
| | 30" | 29 ⁵ / ₈ " | ⁷ / ₁₆ " | DP3L11430F | 166. |
| | 36" | 35 ⁵ / ₈ " | ⁷ / ₁₆ " | DP3L11436F | 196. |
| | 42" | 41 ⁵ / ₈ " | ⁷ / ₁₆ " | DP3L11442F | 211. |
| | 48" | 47 ⁵ / ₈ " | ⁷ / ₁₆ " | DP3L11448F | 214. |
| 28" High Individual Tiled Laminate Insert Tile to Floor  | 15" | 14 ⁵ / ₈ " | ⁷ / ₁₆ " | DP3L12815F | 172. |
| | 18" | 17 ⁵ / ₈ " | ⁷ / ₁₆ " | DP3L12818F | 181. |
| | 24" | 23 ⁵ / ₈ " | ⁷ / ₁₆ " | DP3L12824F | 208. |
| | 30" | 29 ⁵ / ₈ " | ⁷ / ₁₆ " | DP3L12830F | 242. |
| | 36" | 35 ⁵ / ₈ " | ⁷ / ₁₆ " | DP3L12836F | 261. |
| | 42" | 41 ⁵ / ₈ " | ⁷ / ₁₆ " | DP3L12842F | 312. |
| | 48" | 47 ⁵ / ₈ " | ⁷ / ₁₆ " | DP3L12848F | 317. |

w* = nominal width
 Dimensions listed under w h d are actual to the nearest ¹/₁₆"

| Ordering Information | Order Code | Included with: | Options |
|-------------------------------|-----------------------------------|---|-------------------------------|
| Tiled Laminate Inserts | Tiled Laminate Inserts | Tiled Laminate Inserts | Tiled Laminate Inserts |
| 1. Pattern Number | <i>Example:</i> DP3L11424F | • Attachment clips | Finish Options: |
| 2. Laminate Finish | DP3L1 Pattern Number | Note: Tiled insert supports must be ordered separately (see opposite page for quantities required) | 114 Folkstone Grey |
| 3. Edgeband Finish | 1424F | | 117 Soft Grey |
| | 118 Bright White Laminate | | 118 Bright White |
| | 118 Bright White Edgeband | | 119 Pumice |

This page intentionally left blank

Beltway Inserts

Dividends Horizon beltway panel inserts are available by component for use with panel frames for "build-to-spec" applications. These applications include when inserts are only required on one panel side and when fabrics or materials are mixed insert-to-insert or side-to-side.

Beltway inserts are also included in "Preconfigured" beltway panel assemblies.

Beltway Insert Construction

Fabric inserts are constructed of fabric laminated with web adhesive and heat-cured to 7/16" thick acoustical board. Laminate inserts are constructed of a particle laminate on the front and back. Steel tiles are constructed of formed steel that is painted in any Knoll core paint finish. 24" high inserts are to only be used below beltways.

Beltway Insert Attachment

Beltway panel inserts attach to the troughs in the upper and lower horizontal frame supports and beltway insert supports. Beltway top and bottom panel inserts require beltway cover and insert supports. Mounting clips attach to panel inserts and connect to vertical frame for additional support. No tools are required for insert attachment.

Note: Slatwall tiles may not be specified or installed with beltway.

Beltway Cover

Beltway covers snap into the beltway supports and are constructed of extruded plastic. Beltway covers include knockouts with covers for duplex receptacles centered 12" from each panel end (except for 18 and 24" wide). A single communications knockout cover in the center of the beltway is included on all beltways except for 30" wide. Electrical knockouts are the same size as communications

knockouts and can be used for communications cables and data ports if terminal blocks are not installed within the beltway.

Beltway covers and insert supports can be installed on one or both sides of panels. Beltway cover and insert supports require top and bottom beltway panel inserts.

Beltway Cover Construction

Color injected plastic extrusion that is available in smooth finish.

Electrical

Beltways 30" and wider accept two duplex receptacles per beltway. 18" and 24" wide beltways provide pass-through electrical only. All electrical components are ordered separately and must be field-installed.

One-Sided Beltway Panel

Beltway panels are available with one beltway per panel or per panel side.

Note: Insert dimensions are nominal. Inserts and beltway cover/supports are for one side only.

Beltway Insert Locations

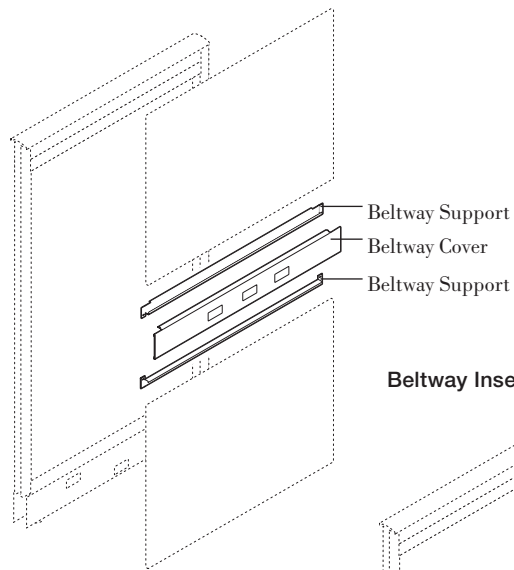

Beltway Insert Locations

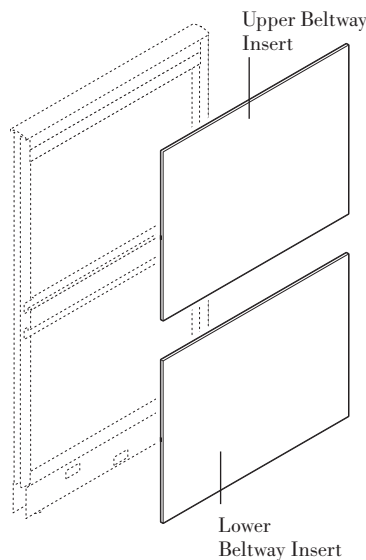

Beltway Insert Attachment

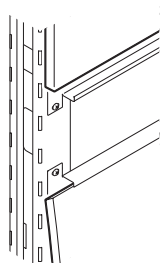

Beltway Insert Configurations

42"H Panels

- One 7"H upper insert
- One 4"H beltway cover and insert support
- One 24"H lower insert

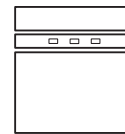

50"H Panels

- One 14"H upper panel insert
- One 4"H beltway cover and insert support
- One 24"H lower insert

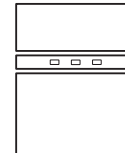

57"H Panels

- One 21"H upper insert
- One 4"H beltway cover and insert support
- One 24"H lower insert

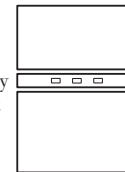

78"H Panels

- One 50"H upper insert
- One 4"H beltway cover and insert support
- One 24"H lower panel insert

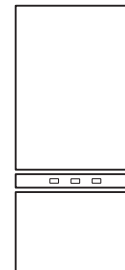

64"H Panels

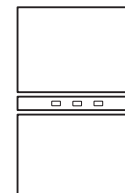

- One 28"H upper insert
- One 4"H beltway cover and insert support
- One 24"H lower insert



Beltway Inserts

Lower Fabric Inserts

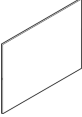
Beltway Cover and Insert Supports

| description | w* | w | h | d | pattern no. | grade | | | | | | | |
|--|-----------|---------|---------|-------|------------------|-------|--------|--------|--------|--------|--------|--------|--------|
| | | | | | | 10 | 15 | 20 | 25 | 30 | 35 | 40 | 45 |
| 24" High Fabric Beltway Lower Insert, (For Beltway Panels only)  | 18" | 17 5/8" | 25 1/2" | 7/16" | DP1SO2418 | \$96. | \$104. | \$109. | \$116. | \$121. | \$126. | \$132. | \$136. |
| | 24" | 23 5/8" | 25 1/2" | 7/16" | DP1SO2424 | 119. | 123. | 136. | 142. | 148. | 151. | 156. | 170. |
| | 30" | 29 5/8" | 25 1/2" | 7/16" | DP1SO2430 | 130. | 136. | 148. | 154. | 161. | 170. | 174. | 183. |
| | 36" | 35 5/8" | 25 1/2" | 7/16" | DP1SO2436 | 141. | 148. | 161. | 171. | 180. | 186. | 190. | 198. |
| | 42" | 41 5/8" | 25 1/2" | 7/16" | DP1SO2442 | 147. | 153. | 163. | 172. | 182. | 187. | 194. | 204. |
| | 48" | 47 5/8" | 25 1/2" | 7/16" | DP1SO2448 | 153. | 161. | 174. | 183. | 188. | 196. | 207. | 217. |
| | 60" | 59 5/8" | 25 1/2" | 7/16" | DP1SO2460 | 175. | 180. | 187. | 190. | 198. | 201. | 211. | 223. |
| Beltway Cover and Insert Supports  | 18" | | | 7/16" | DP2BC18K | 104. | n/a | n/a | n/a | n/a | n/a | n/a | n/a |
| | 24" | | | 7/16" | DP2BC24K | 121. | n/a | n/a | n/a | n/a | n/a | n/a | n/a |
| | 30" | | | 7/16" | DP2BC30K | 134. | n/a | n/a | n/a | n/a | n/a | n/a | n/a |
| | 36" | | | 7/16" | DP2BC36K | 147. | n/a | n/a | n/a | n/a | n/a | n/a | n/a |
| | 42" | | | 7/16" | DP2BC42K | 163. | n/a | n/a | n/a | n/a | n/a | n/a | n/a |
| | 48" | | | 7/16" | DP2BC48K | 182. | n/a | n/a | n/a | n/a | n/a | n/a | n/a |
| | 60" | | | 7/16" | DP2BC60K | 212. | n/a | n/a | n/a | n/a | n/a | n/a | n/a |
| Beltway Knockout Replacement Cover for Electrical and Data  | Pkg of 10 | | | | DE2KC10 | 74. | n/a | n/a | n/a | n/a | n/a | n/a | n/a |

Panels, Build-To-Spec

w* = nominal width
 Dimensions listed under w h d are actual to the nearest 1/16"

| Ordering Information | Order Code | Included with: | Options |
|---|---|--|---|
| Beltway Cover/Insert Supports 1. Pattern Number 2. Beltway Cover/Trim Finish | Beltway Inserts <i>Example:</i> DP1 SO2442, W257-6 DP1 Pattern Number SO2442 W257-6 Solid Crepe Blue Pine fabric | Beltway Inserts Beltway Cover/Insert Supports <ul style="list-style-type: none"> Individual beltway cover Insert supports (top and bottom rail) Attachment hardware Beltway knockout covers Note: 24"H inserts are to only be used below beltways. | Beltway Panel Inserts Beltway Cover/Insert Supports Beltway cover has a smooth finish Tile to Floor Option: To specify tile to floor, add an "F" suffix to the pattern number and add \$10 to the list price. Note: Tile to floor option available for 24" high inserts. |
| Beltway Inserts 1. Pattern Number 2. Fabric | Beltway Cover/Insert Supports <i>Example:</i> DP2 BC42K, 117 DP2 Pattern Number BC42K 117 Soft Grey Beltway Cover Trim | | |

Beltway Inserts

Lower Steel Inserts

Dividends Horizon

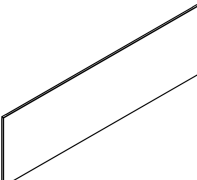
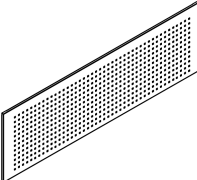
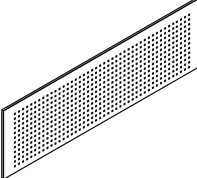
| description | w* | w | h | d | pattern no. | 1 pack P1 | 1 pack P2 | 1 pack P3 | 2 pack P1 | 2 pack P2 | 2 pack P3 |
|---|-----|----------------------------------|----------------------------------|--------------------------------|----------------------|--------------|--------------|--------------|--------------|--------------|--------------|
| 24" High Solid Steel Insert  | 18" | 17 ⁵ / ₈ " | 25 ¹ / ₂ " | ⁷ / ₁₆ " | DP3SS()2418 | \$105. | \$127. | \$136. | \$183. | \$215. | \$235. |
| | 24" | 23 ⁵ / ₈ " | 25 ¹ / ₂ " | ⁷ / ₁₆ " | DP3SS()2424 | 132. | 150. | 164. | 229. | 261. | 285. |
| | 30" | 29 ⁵ / ₈ " | 25 ¹ / ₂ " | ⁷ / ₁₆ " | DP3SS()2430 | 139. | 163. | 177. | 244. | 285. | 309. |
| | 36" | 35 ⁵ / ₈ " | 25 ¹ / ₂ " | ⁷ / ₁₆ " | DP3SS()2436 | 156. | 178. | 198. | 271. | 309. | 344. |
| | 42" | 41 ⁵ / ₈ " | 25 ¹ / ₂ " | ⁷ / ₁₆ " | DP3SS()2442 | 162. | 179. | 199. | 283. | 314. | 348. |
| | 48" | 47 ⁵ / ₈ " | 25 ¹ / ₂ " | ⁷ / ₁₆ " | DP3SS()2448 | 166. | 189. | 208. | 292. | 335. | 366. |
| 24" High Perforated Steel Insert  | 18" | 17 ⁵ / ₈ " | 25 ¹ / ₂ " | ⁷ / ₁₆ " | DP3PSB()2418 | 159. | 188. | 207. | 275. | 323. | 352. |
| | 24" | 23 ⁵ / ₈ " | 25 ¹ / ₂ " | ⁷ / ₁₆ " | DP3PSB()2424 | 196. | 225. | 246. | 344. | 394. | 431. |
| | 30" | 29 ⁵ / ₈ " | 25 ¹ / ₂ " | ⁷ / ₁₆ " | DP3PSB()2430 | 212. | 244. | 263. | 368. | 431. | 464. |
| | 36" | 35 ⁵ / ₈ " | 25 ¹ / ₂ " | ⁷ / ₁₆ " | DP3PSB()2436 | 236. | 265. | 296. | 408. | 464. | 514. |
| | 42" | 41 ⁵ / ₈ " | 25 ¹ / ₂ " | ⁷ / ₁₆ " | DP3PSB()2442 | 243. | 268. | 297. | 425. | 471. | 523. |
| | 48" | 47 ⁵ / ₈ " | 25 ¹ / ₂ " | ⁷ / ₁₆ " | DP3PSB()2448 | 249. | 284. | 310. | 442. | 503. | 548. |
| 24" High Embossed Steel Insert  | 18" | 17 ⁵ / ₈ " | 25 ¹ / ₂ " | ⁷ / ₁₆ " | DP3ESB()2418 | 159. | 188. | 207. | 275. | 323. | 352. |
| | 24" | 23 ⁵ / ₈ " | 25 ¹ / ₂ " | ⁷ / ₁₆ " | DP3ESB()2424 | 196. | 225. | 246. | 344. | 394. | 431. |
| | 30" | 29 ⁵ / ₈ " | 25 ¹ / ₂ " | ⁷ / ₁₆ " | DP3ESB()2430 | 212. | 244. | 263. | 368. | 431. | 464. |
| | 36" | 35 ⁵ / ₈ " | 25 ¹ / ₂ " | ⁷ / ₁₆ " | DP3ESB()2436 | 236. | 265. | 296. | 408. | 464. | 514. |
| | 42" | 41 ⁵ / ₈ " | 25 ¹ / ₂ " | ⁷ / ₁₆ " | DP3ESB()2442 | 243. | 268. | 297. | 425. | 471. | 523. |
| | 48" | 47 ⁵ / ₈ " | 25 ¹ / ₂ " | ⁷ / ₁₆ " | DP3ESB()2448 | 249. | 284. | 310. | 442. | 503. | 548. |

w* = nominal width
 Dimensions listed under w h d are actual to the nearest ¹/₁₆"

| Ordering Information | Order Code | Included with: | Options |
|---|--|--|---|
| Steel Insert 1. Pattern number 2. Paint finish | Steel Insert <hr/> Example: DP3SS()2418 115 DP3 Pattern number SS22418 <hr/> 115 Medium Grey paint | Steel Insert Note: 24"H inserts are to only be used below beltways. | Steel Insert Insert pack quantity into parenthesis in pattern number Title to Floor Option: To specify tile to floor, add an 'F' suffix to the pattern number and add \$17 for a single pack or \$33 for a double pack. Note: Tile to Floor option available for 24" high inserts. |

Beltway Inserts

Lower Laminate Inserts

Dividends Horizon

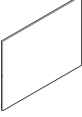
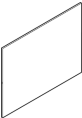
| description | w* | w | d | pattern no. | list |
|--|-----|---------|-------|-------------------|--------|
| 24" High Laminate Beltway Lower Insert Base Raceway or Open Base  | 15" | 14 7/8" | 7/16" | DP3L12415 | \$145. |
| | 18" | 17 7/8" | 7/16" | DP3L12418 | 154. |
| | 24" | 23 7/8" | 7/16" | DP3L12424 | 173. |
| | 30" | 29 7/8" | 7/16" | DP3L12430 | 207. |
| | 36" | 35 7/8" | 7/16" | DP3L12436 | 253. |
| | 42" | 41 7/8" | 7/16" | DP3L12442 | 257. |
| | 48" | 47 7/8" | 7/16" | DP3L12448 | 260. |
| 24" High Laminate Beltway Lower Insert Tile to Floor  | 15" | 14 7/8" | 7/16" | DP3L12415F | 145. |
| | 18" | 17 7/8" | 7/16" | DP3L12418F | 154. |
| | 24" | 23 7/8" | 7/16" | DP3L12424F | 173. |
| | 30" | 29 7/8" | 7/16" | DP3L12430F | 207. |
| | 36" | 35 7/8" | 7/16" | DP3L12436F | 253. |
| | 42" | 41 7/8" | 7/16" | DP3L12442F | 257. |
| | 48" | 47 7/8" | 7/16" | DP3L12448F | 260. |

Panels, Build-To-Spec

w* = nominal width
Dimensions listed under w h d are actual to the nearest 1/16"

| Ordering Information | Order Code | Included with: | Options: |
|---------------------------------|----------------------------------|---|--|
| Beltway Laminate Inserts | Beltway Laminate Inserts | Beltway Laminate Inserts | Beltway Laminate Inserts Finish |
| 1. Pattern Number | <i>Example:</i> DP3L12436 | • Attachment clips | Options: |
| 2. Laminate Finish | DP3L1 Pattern Number | Note: 24"H inserts are to only be used below beltways. | 114 Folkstone Grey |
| 3. Edgeband Finish | 2436 | | 117 Soft Grey |
| | 118 Bright White Laminate | | 118 Bright White |
| | 118 Bright White Edgeband | | 119 Pumice |

High Acoustic Core Inserts and Sound Transmission Septum Inserts

Optional high acoustic core inserts or sound transmission septum inserts combine with tiles to provide enhanced acoustics.

High acoustic core inserts can be installed in monolithic and tiled panels but must be field-cut to be installed in beltway panels.

Sound transmission septum inserts can be installed in monolithic and tiled panels and single-sided beltway panels.

High Acoustic Core Insert Construction

1 1/2" thick, three-ply insert with an inner septum and outer fiberglass with polywrap.

Sound Transmission Septum Insert Construction

1/16" thick black asphalt paper.

Core Insert Attachment

High acoustic core inserts and sound transmission septum inserts are inserted into the center of the panel frame. Core inserts are sized to fit into the panel frame without the use of fasteners. In-field installation is required.

High Acoustic Core Insert Panel Ratings

Noise Reduction Coefficient (NRC) rating: .80 when combined with tiles.

Sound Transmission Class (STC) rating: 26 when combined with tiles.

Sound Transmission Septum Insert Panel Ratings

Noise Reduction Coefficient (NRC) rating: .60 when combined with tiles.

Sound Transmission Class (STC) rating: 17 when combined with tiles.

Available Sizes

High acoustic core inserts and sound transmission septum inserts are available for all widths of 50", 64" and 78" high monolithic and tiled panels.

Beltway electrical panels require the high acoustic core inserts or the sound transmission septum inserts to be field-cut prior to installation.

Packaging

High acoustic cores and sound transmission septum inserts are shipped in separate containers.

High Acoustic Core Insert

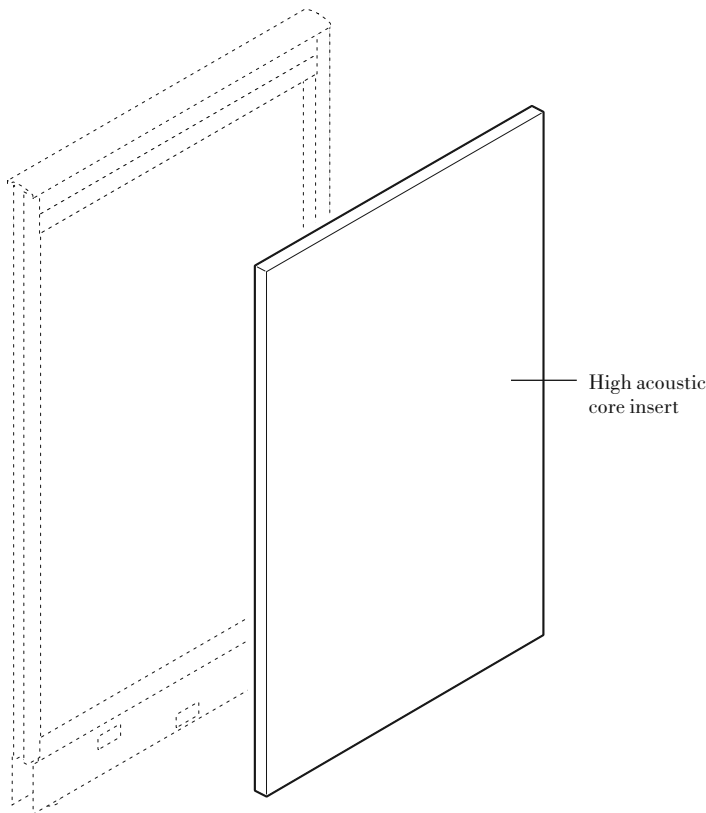

High Acoustic Core Insert Construction

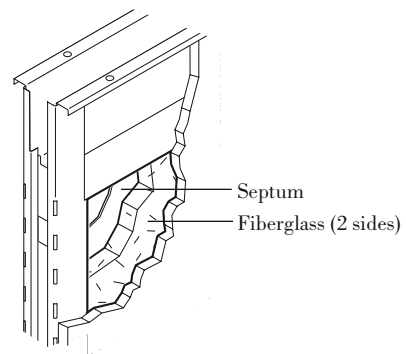

Sound Transmission Septum Insert Construction

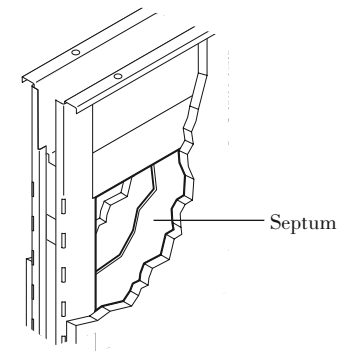

High Acoustic Core Inserts

Sound Transmission Septum Inserts

Dividends Horizon

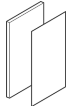
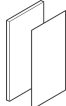
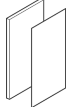
| description | type | pattern no. | High Acoustic Core Insert | Sound Transmission Septum Insert |
|---|---------------------|-------------------|---------------------------|----------------------------------|
|  50" High | For 18" panel width | DP1() 5018 | \$29. | \$14. |
| | For 24" panel width | DP1() 5024 | 34. | 14. |
| | For 30" panel width | DP1() 5030 | 37. | 14. |
| | For 36" panel width | DP1() 5036 | 42. | 24. |
| | For 42" panel width | DP1() 5042 | 47. | 24. |
| | For 48" panel width | DP1() 5048 | 57. | 24. |
|  64" High | For 18" panel width | DP1() 6418 | 38. | 14. |
| | For 24" panel width | DP1() 6424 | 44. | 14. |
| | For 30" panel width | DP1() 6430 | 50. | 14. |
| | For 36" panel width | DP1() 6436 | 60. | 24. |
| | For 42" panel width | DP1() 6442 | 70. | 24. |
| | For 48" panel width | DP1() 6448 | 77. | 24. |
|  78" High | For 18" panel width | DP1() 7818 | 50. | 27. |
| | For 24" panel width | DP1() 7824 | 60. | 27. |
| | For 30" panel width | DP1() 7830 | 69. | 27. |
| | For 36" panel width | DP1() 7836 | 75. | 29. |
| | For 42" panel width | DP1() 7842 | 84. | 29. |
| | For 48" panel width | DP1() 7848 | 100. | 29. |

Panels, Build-To-Spec

Ordering Information

Inserts

1. Pattern Number

Order Code

Inserts

Example: **DP1(AC) 6448**
DP1(AC) Pattern Number
6448

Included with:

Inserts

- High Acoustic Core Insert
- Sound Transmission Septum Insert

Options

Inserts

Insert the appropriate letters for insert required within the parentheses of the pattern number.
(AC) = High Acoustic
(ST) = Sound Transmission

Single Pane Window Insert Kit

Single pane windows are available for three applications:

- Top position, with topway - for use in the top position of panels and D1 style stack frame with a topway trough.
- Top position, full view - for use in the top position of full view panels and D1 style stack frames.
- Middle position - for use in the middle positions of topway and full view panels.

Note: Window insert kits may not be specified in the bottom position of panels. Specify D2 tile supports and insert support mounting brackets separately.

Note: Single and double pane window insert kits are not compatible with the D2 style stack frame. Use D1 style stack frames with top position single or double pane window insert kits.

Construction

Single pane windows are shipped in two components - an "open" frame, and a "window" frame. Each frame snaps onto a Dividends Horizon panel frame. Both frames are constructed of extruded, then robotically-welded aluminum. Single pane windows have 1/4" tempered glass inserts with PVC glazing strip.

Single Pane Window Insert Kit

Available Sizes

- Heights: 14", 21" and 28"
- Widths: 24", 30", 36", 42", and 48"

Attachment

Window insert kits are installed on each side of a panel frame. Glazed insert kits consist of two inserts. Individual tile support rails must be ordered separately.

Note: Window types are aesthetically different, and are not designed to be mixed together within a single installation.

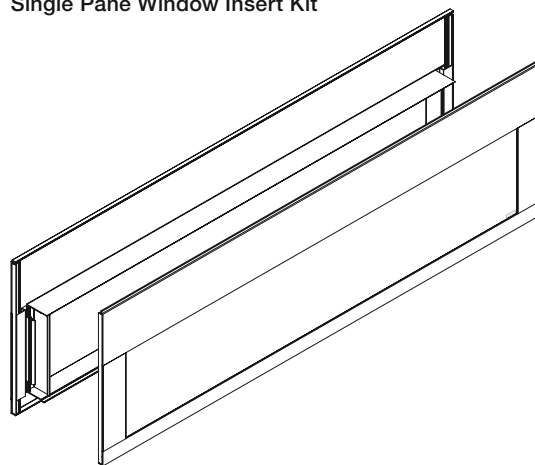

Single Pane Window Insert Kit



Window Insert Kits

Single Pane Windows

Dividends Horizon

| description | h | w | pattern no. | P1 | P2 | P3 |
|--|-----|----------------------|----------------------|--------|--------|--------|
|  Window, top position with topway | 14" | 24" | D2P1()T1424 | \$404. | \$427. | \$447. |
| | 14" | 30" | D2P1()T1430 | 469. | 491. | 515. |
| | 14" | 36" | D2P1()T1436 | 528. | 555. | 582. |
| | 14" | 42" | D2P1()T1442 | 628. | 659. | 691. |
| | 14" | 48" | D2P1()T1448 | 642. | 675. | 708. |
| | 21" | 24" | D2P1()T2124 | 471. | 495. | 517. |
| | 21" | 30" | D2P1()T2130 | 555. | 583. | 612. |
| | 21" | 36" | D2P1()T2136 | 597. | 628. | 656. |
| | 21" | 42" | D2P1()T2142 | 713. | 750. | 783. |
| | 21" | 48" | D2P1()T2148 | 794. | 836. | 876. |
| | 28" | 24" | D2P1()T2824 | 517. | 544. | 573. |
| | 28" | 30" | D2P1()T2830 | 612. | 642. | 674. |
| | 28" | 36" | D2P1()T2836 | 656. | 691. | 723. |
| | 28" | 42" | D2P1()T2842 | 783. | 825. | 865. |
| 28" | 48" | D2P1()T2848 | 876. | 918. | 962. | |
|  Window, top position full view | 14" | 24" | D2P1()VT1424 | 404. | 427. | 447. |
| | 14" | 30" | D2P1()VT1430 | 469. | 491. | 515. |
| | 14" | 36" | D2P1()VT1436 | 528. | 555. | 582. |
| | 14" | 42" | D2P1()VT1442 | 628. | 659. | 691. |
| | 14" | 48" | D2P1()VT1448 | 642. | 675. | 708. |
| | 21" | 24" | D2P1()VT2124 | 471. | 495. | 517. |
| | 21" | 30" | D2P1()VT2130 | 555. | 583. | 612. |
| | 21" | 36" | D2P1()VT2136 | 597. | 628. | 656. |
| | 21" | 42" | D2P1()VT2142 | 713. | 750. | 783. |
| | 21" | 48" | D2P1()VT2148 | 794. | 836. | 876. |
| | 28" | 24" | D2P1()VT2824 | 517. | 544. | 573. |
| | 28" | 30" | D2P1()VT2830 | 612. | 642. | 674. |
| | 28" | 36" | D2P1()VT2836 | 656. | 691. | 723. |
| | 28" | 42" | D2P1()VT2842 | 783. | 825. | 865. |
| 28" | 48" | D2P1()VT2848 | 876. | 918. | 962. | |
|  Window, middle position | 14" | 24" | D2P1()VL1424 | 404. | 427. | 447. |
| | 14" | 30" | D2P1()VL1430 | 469. | 491. | 515. |
| | 14" | 36" | D2P1()VL1436 | 528. | 555. | 582. |
| | 14" | 42" | D2P1()VL1442 | 628. | 659. | 691. |
| | 14" | 48" | D2P1()VL1448 | 642. | 675. | 708. |

Panels, Build-To-Spec

Ordering Information

Single Pane Window Kit

1. Pattern number
2. Paint finish

Order Code

Single Pane Window Kit

| | |
|---------------|------------------------|
| Example: | D2P1GT1448, 117 |
| D2P1 | Single Pane Window w/ |
| GT1448 | Clear Glass |
| 117 | Soft Grey Paint |

Included with:

Single Pane Window Kit

Note: The single pane window insert kit is not compatible with the D2 style stack frame. Use D1 style stack frames with single pane window insert kits.

Note: Use top position window insert kits when using with D1 style stack frames.

Options

Single Pane Window Kit

Note: Single Pane Window Kit must be used with D2 Style Supports

Glass Options:
(G) = Clear Tempered Glass
(F) = Powder Glass

Markerboard Tiles

Markerboard tiles may be attached to any Dividends Horizon universal panel frame or wall mount tracks.

Construction

Markerboard tiles are constructed of 20 gauge steel, powder coated with paint suitable for use with standard dry erase markers.

Available Sizes

- Heights: 7", 10", 14", 21", 24" and 28"
- Widths: 18", 24", 30", 36", 42", and 48"

Attachment

Markerboard tiles are installed on one side or both sides of a panel frame or attached to wall mount tracks. Individual D1 or D2 tile support rails must be ordered separately.

Markerboard Trays

Markerboard trays are positioned directly below markerboard tiles, and are designed to hold dry erase markers and erasers. Trays mount to the outside of tile frames, and replace a D1 or D2 tile support.

Markerboard trays may not be positioned directly above or below a beltway raceway and may not be used with stack frames.

Note: Markerboard tiles can use D1 or D2 tile supports. Legacy D1 and D2 Markerboard tiles use D1 tile supports only.

Markerboard Tile

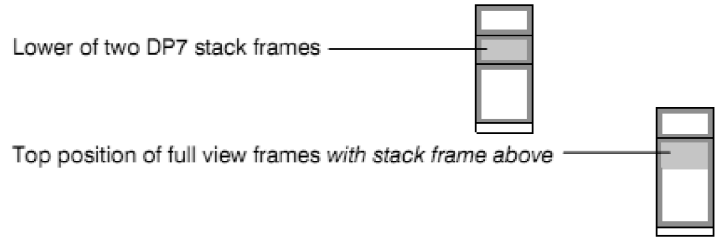
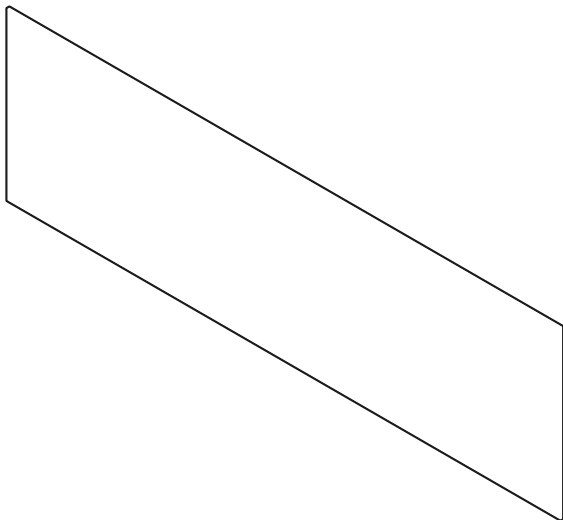

DP7 Stack Frame/Steel Tile Planning Note

When planning steel or markerboard tiles in the lower of two stack frames, or the upper position of full view panels with stack frames above them, different attachment clips are required. Specify pattern number DP7 SSTK (\$10 list) for each steel or markerboard tile used in these applications. This hardware kit is not required for any other tiles, or for steel and markerboard tiles in other locations.

Proper use and regular cleaning of your markerboard surface is essential for preventing permanent stains and/or ghosting typically associated with dry erase markers. By following the care and use instructions below, you will minimize the possibility of permanent stains and ghosting.

Initial Cleaning of Markerboards Before First Use:

- Using a clean, dry cloth and a nonabrasive cleaner, gently clean the entire board to loosen any residue
- Using a dry cloth, wipe the entire surface to remove all dirt and residue from the prior step
- Rinse the entire board with clean water
- Using a dry cloth, wipe dry the entire surface

Daily Use, Care and Maintenance:

- *Use the proper markers.* All dry erase markers will write legibly on the marker board surface, but not all will erase properly due to their composition. Do not use low odor dry erase markers or permanent (indelible) markers. Use of these markers will lead to staining or ghosting, even with regular cleaning.
- *Clean the markerboard regularly.* It is recommended that markerboards be erased daily using an eraser designated for use with dry erase markers. If the markerboard is used daily, we recommend that a complete cleaning is performed at least 2-3 times a week using EXPO® whiteboard cleaner.
- *Remove ghosting.* Using EXPO® whiteboard cleaner and a paper towel, wipe the entire surface and let dry. Mix Joy® dishwashing detergent with warm water and apply to the board using a paper towel, then wipe dry with a clean cloth. Repeat as necessary.
- *Remove permanent marker.* Using a dry erase marker, write on top of the permanent marker, erase with a dry eraser, and then clean with EXPO® whiteboard cleaner.

Note: Do not use other painted tiles as markerboards or product damage will occur and the tile warranty will be voided.

Markerboard Tiles

7", 10", 14" and 21" High

Dividends Horizon

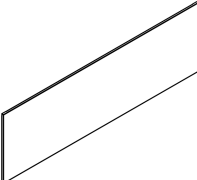
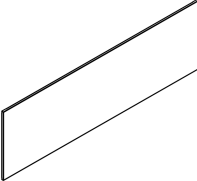
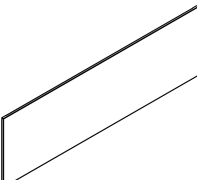
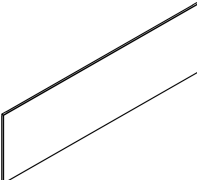
| description | h | w | pattern no. | 1 pack | 6 pack |
|--|-----|-----|---------------------|--------|--------|
| D3 7" Markerboard tile  | 7" | 18" | DP3MB()718 | \$77. | \$342. |
| | 7" | 24" | DP3MB()724 | 81. | 363. |
| | 7" | 30" | DP3MB()730 | 88. | 402. |
| | 7" | 36" | DP3MB()736 | 106. | 468. |
| | 7" | 42" | DP3MB()742 | 115. | 500. |
| | 7" | 48" | DP3MB()748 | 119. | 530. |
| D3 10" Markerboard tile  | 10" | 18" | DP3MB()1018 | 106. | 477. |
| | 10" | 24" | DP3MB()1024 | 115. | 508. |
| | 10" | 30" | DP3MB()1030 | 116. | 530. |
| | 10" | 36" | DP3MB()1036 | 130. | 563. |
| | 10" | 42" | DP3MB()1042 | 134. | 595. |
| | 10" | 48" | DP3MB()1048 | 141. | 636. |
| D3 14" Markerboard tile  | 14" | 18" | DP3MB()1418 | 106. | 477. |
| | 14" | 24" | DP3MB()1424 | 115. | 508. |
| | 14" | 30" | DP3MB()1430 | 116. | 530. |
| | 14" | 36" | DP3MB()1436 | 130. | 563. |
| | 14" | 42" | DP3MB()1442 | 134. | 595. |
| | 14" | 48" | DP3MB()1448 | 141. | 636. |
| D3 21" Markerboard tile  | 21" | 18" | DP3MB()2118 | 137. | 712. |
| | 21" | 24" | DP3MB()2124 | 171. | 891. |
| | 21" | 30" | DP3MB()2130 | 183. | 957. |
| | 21" | 36" | DP3MB()2136 | 207. | 1,063. |
| | 21" | 42" | DP3MB()2142 | 212. | 1,102. |
| | 21" | 48" | DP3MB()2148 | 216. | 1,147. |

Ordering Information

Markerboard Tiles
1. Pattern Number

Order Code

Markerboard Tiles
Example: **DP3MB(1) 1436**
DP3MB(1) Pattern Number
1436

Included with:

Markerboard Tiles

Options

Markerboard Tiles
(1) = 1 Pack
(6) = 6 Pack

Markerboard Tiles

24" and 28" High and Markerboard Tray

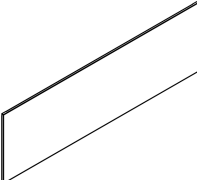
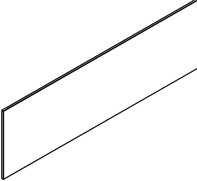
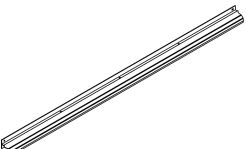
| description | height | width | pattern number | 1 pack | 2 pack | P1 | P2 | P3 |
|---|--------|-------|---------------------|--------|--------|------|------|------|
|  D3 24" Markerboard tile | 24" | 18" | DP3MB()2418 | \$137. | \$237. | | | |
| | 24" | 24" | DP3MB()2424 | 171. | 296. | | | |
| | 24" | 30" | DP3MB()2430 | 183. | 318. | | | |
| | 24" | 36" | DP3MB()2436 | 207. | 355. | | | |
| | 24" | 42" | DP3MB()2442 | 212. | 368. | | | |
| | 24" | 48" | DP3MB()2448 | 216. | 382. | | | |
|  D3 28" Markerboard tile | 28" | 18" | DP3MB()2818 | 149. | 259. | | | |
| | 28" | 24" | DP3MB()2824 | 173. | 301. | | | |
| | 28" | 30" | DP3MB()2830 | 184. | 324. | | | |
| | 28" | 36" | DP3MB()2836 | 207. | 361. | | | |
| | 28" | 42" | DP3MB()2842 | 212. | 371. | | | |
| | 28" | 48" | DP3MB()2848 | 216. | 384. | | | |
|  Markerboard Tray | | 24" | DP1MBT24 | | | 119. | 126. | 131. |
| | | 30" | DP1MBT30 | | | 122. | 128. | 134. |
| | | 36" | DP1MBT36 | | | 124. | 131. | 136. |
| | | 42" | DP1MBT42 | | | 127. | 133. | 138. |
| | | 48" | DP1MBT48 | | | 130. | 135. | 141. |

Ordering Information

Markerboard Tiles

1. Pattern Number

Markerboard Tray

1. Pattern Number
2. Paint Finish

Order Code

Markerboard Tiles

Example: **DP3MB(1) 1436**

DP3MB(1) Pattern Number
1436

Included with:

Markerboard Tiles

Options

Markerboard Tiles

(1) = 1 Pack
(2) = 2 Pack

Solid Steel Inserts

Solid steel tiles are painted solid steel formed inserts that may be inserted into any Dividends Horizon universal panel frame or attached to wall mount tracks.

Construction

Steel tiles are made of 20-gauge formed steel that is painted in any Dividends Horizon paint color.

Embossed Steel Inserts

Embossed steel tiles are painted embossed steel formed inserts that may be inserted into any Dividends Horizon universal panel frame or attached to wall mount tracks.

Construction

Embossed steel tiles are made of 18-gauge formed steel that is painted in any Dividends Horizon paint color

Perforated Steel Inserts

Perforated steel tiles are painted perforated steel formed inserts that may be inserted into any Dividends Horizon universal panel frame or attached to wall mount tracks.

Construction

Perforated steel tiles are made of 18-gauge formed steel that is painted in any Dividends Horizon paint color.

Available Sizes

- Height: 7", 10", 14", 21", 24" and 28"
- Widths: 15", 18", 24", 30", 36", 42" and 48"

Attachment

Steel tiles are installed on one side or both sides of a panel frame or attached to wall mount tracks. Individual D1 or D2 tile support rails must be ordered separately.

One-sided Attachment

For applications with perforated inserts on one side of panel only, specify sound transmission septums.

Tile-to-Floor Option

14" and 28" high steel tiles are available to be specified Tile-to-Floor.

Solid Steel Tile Insert

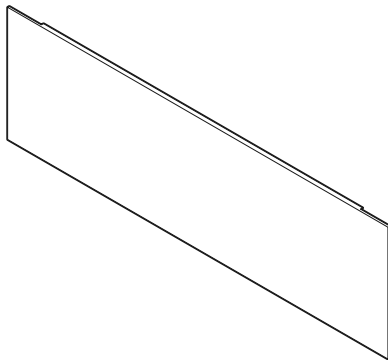

Perforated and Embossed Steel Tile Inserts

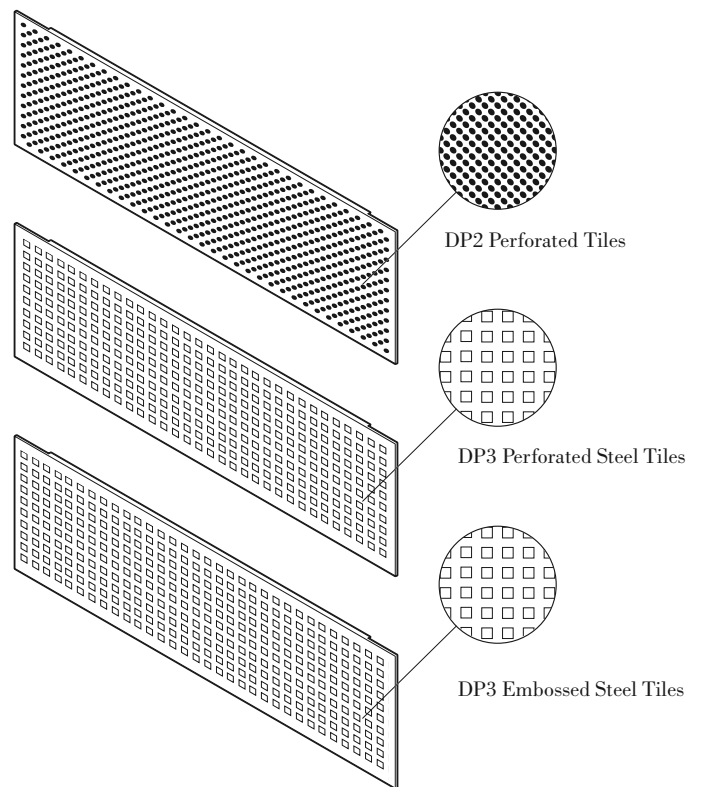

Lower of two DP7 stack frames

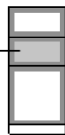

Top position of full view frames with stack frame above



DP7 Stack Frame/Steel Tile Planning Note

When planning steel or markerboard tiles in the lower of two stack frames, or the upper position of full view panels with stack frames above them, different attachment clips are required. Specify pattern number DP7 SSTK (\$10 list) for each steel or markerboard tile used in these applications. This hardware kit is not required for any other tiles, or for steel and markerboard tiles in other locations.

Steel Insert Kits

7", 10", 14" and 21" High Solid Steel Insert

Dividends Horizon

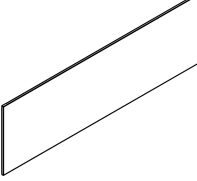
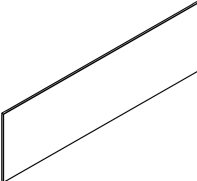
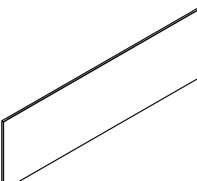
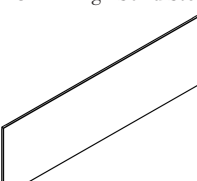
| description | w* | w | h | d | pattern no. | 1 pack P1 | 1 pack P2 | 1 pack P3 | 6 pack P1 | 6 pack P2 | 6 pack P3 |
|---|-----|---------|----------|-------|---------------------|-----------|-----------|-----------|-----------|-----------|-----------|
| D3 7" High Solid Steel Insert  | 15" | 14 5/8" | 7 3/16" | 7/16" | DP3SS()715 | \$59. | \$70. | \$81. | \$261. | \$303. | \$362. |
| | 18" | 17 5/8" | 7 3/16" | 7/16" | DP3SS()718 | 59. | 70. | 81. | 261. | 303. | 362. |
| | 24" | 23 5/8" | 7 3/16" | 7/16" | DP3SS()724 | 62. | 77. | 83. | 278. | 344. | 375. |
| | 30" | 29 5/8" | 7 3/16" | 7/16" | DP3SS()730 | 71. | 85. | 95. | 311. | 383. | 416. |
| | 36" | 35 5/8" | 7 3/16" | 7/16" | DP3SS()736 | 82. | 98. | 103. | 362. | 416. | 449. |
| | 42" | 41 5/8" | 7 3/16" | 7/16" | DP3SS()742 | 87. | 101. | 109. | 383. | 442. | 480. |
| | 48" | 47 5/8" | 7 3/16" | 7/16" | DP3SS()748 | 92. | 104. | 111. | 408. | 467. | 505. |
| D3 10" High Solid Steel Insert  | 15" | 14 5/8" | 10 3/16" | 7/16" | DP3SS()1015 | 82. | 96. | 99. | 368. | 416. | 435. |
| | 18" | 17 5/8" | 10 3/16" | 7/16" | DP3SS()1018 | 82. | 96. | 99. | 368. | 416. | 435. |
| | 24" | 23 5/8" | 10 3/16" | 7/16" | DP3SS()1024 | 87. | 100. | 103. | 394. | 449. | 467. |
| | 30" | 29 5/8" | 10 3/16" | 7/16" | DP3SS()1030 | 88. | 103. | 107. | 408. | 473. | 490. |
| | 36" | 35 5/8" | 10 3/16" | 7/16" | DP3SS()1036 | 99. | 111. | 119. | 435. | 499. | 523. |
| | 42" | 41 5/8" | 10 3/16" | 7/16" | DP3SS()1042 | 102. | 116. | 130. | 457. | 523. | 573. |
| | 48" | 47 5/8" | 10 3/16" | 7/16" | DP3SS()1048 | 107. | 131. | 135. | 490. | 588. | 613. |
| D3 14" High Solid Steel Insert  | 15" | 14 5/8" | 14 3/16" | 7/16" | DP3SS()1415 | 82. | 96. | 99. | 368. | 416. | 435. |
| | 18" | 17 5/8" | 14 3/16" | 7/16" | DP3SS()1418 | 82. | 96. | 99. | 368. | 416. | 435. |
| | 24" | 23 5/8" | 14 3/16" | 7/16" | DP3SS()1424 | 87. | 100. | 103. | 394. | 449. | 467. |
| | 30" | 29 5/8" | 14 3/16" | 7/16" | DP3SS()1430 | 88. | 103. | 107. | 408. | 473. | 490. |
| | 36" | 35 5/8" | 14 3/16" | 7/16" | DP3SS()1436 | 99. | 111. | 119. | 435. | 499. | 523. |
| | 42" | 41 5/8" | 14 3/16" | 7/16" | DP3SS()1442 | 102. | 116. | 130. | 457. | 523. | 573. |
| | 48" | 47 5/8" | 14 3/16" | 7/16" | DP3SS()1448 | 107. | 131. | 135. | 490. | 588. | 613. |
| D3 21" High Solid Steel Insert  | 15 | 14 5/8" | 21 3/16" | 7/16" | DP3SS()2115 | 105. | 127. | 136. | 548. | 646. | 703. |
| | 18" | 17 5/8" | 21 3/16" | 7/16" | DP3SS()2118 | 105. | 127. | 136. | 548. | 646. | 703. |
| | 24" | 23 5/8" | 21 3/16" | 7/16" | DP3SS()2124 | 132. | 150. | 164. | 686. | 782. | 858. |
| | 30" | 29 5/8" | 21 3/16" | 7/16" | DP3SS()2130 | 139. | 163. | 177. | 736. | 858. | 924. |
| | 36" | 35 5/8" | 21 3/16" | 7/16" | DP3SS()2136 | 156. | 178. | 198. | 817. | 924. | 1,031. |
| | 42" | 41 5/8" | 21 3/16" | 7/16" | DP3SS()2142 | 162. | 179. | 199. | 850. | 940. | 1,046. |
| | 48" | 47 5/8" | 21 3/16" | 7/16" | DP3SS()2148 | 166. | 189. | 208. | 882. | 1,004. | 1,095. |

Panels, Build-To-Spec

Ordering Information

Solid Steel Insert

1. Pattern number
2. Paint finish

Order Code

Solid Steel Insert

Example: **DP3SS()1418 115**

DP3 Pattern number

SS21418

115 Medium Grey paint

Included with:

Solid Steel Insert

Options

Insert pack quantity into parenthesis in pattern number

Tile to Floor Option:

Tile to Floor available in heights of 14", Worksurface Height, 24" and 28". To specify tile to floor, add an 'F' suffix to the pattern number and add \$17 for a single pack, \$33 for a double pack and \$99 for a 6 pack to the list price.

Worksurface Height and 28" High Solid Steel Insert

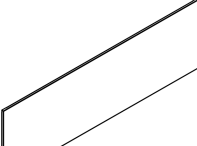
| description | w* | w | h | d | pattern no. | 1 pack P1 | 1 pack P2 | 1 pack P3 | 2 pack P1 | 2 pack P2 | 2 pack P3 |
|---|-----|---------|---------|-------|---------------------|-----------|-----------|-----------|-----------|-----------|-----------|
| D3 Worksurface Height Solid Steel Insert  | 15" | 14 5/8" | 22 1/2" | 7/16" | DP3SS()WH15 | \$105. | \$127. | \$136. | \$183. | \$215. | \$235. |
| | 18" | 17 5/8" | 22 1/2" | 7/16" | DP3SS()WH18 | 105. | 127. | 136. | 183. | 215. | 235. |
| | 24" | 23 5/8" | 22 1/2" | 7/16" | DP3SS()WH24 | 132. | 150. | 164. | 229. | 261. | 285. |
| | 30" | 29 5/8" | 22 1/2" | 7/16" | DP3SS()WH30 | 139. | 163. | 177. | 244. | 285. | 309. |
| | 36" | 35 5/8" | 22 1/2" | 7/16" | DP3SS()WH36 | 156. | 178. | 198. | 271. | 309. | 344. |
| | 42" | 41 5/8" | 22 1/2" | 7/16" | DP3SS()WH42 | 162. | 179. | 199. | 283. | 314. | 348. |
| | 48" | 47 5/8" | 22 1/2" | 7/16" | DP3SS()WH48 | 166. | 189. | 208. | 292. | 335. | 366. |

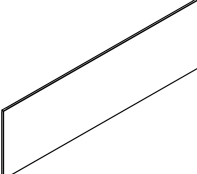
| D3 28" High Solid Steel Insert | w* | w | h | d | pattern no. | 1 pack P1 | 1 pack P2 | 1 pack P3 | 2 pack P1 | 2 pack P2 | 2 pack P3 |
|---|-----|---------|-----|-------|---------------------|-----------|-----------|-----------|-----------|-----------|-----------|
|  | 15" | 14 5/8" | 29" | 7/16" | DP3SS()2815 | 114. | 114. | 135. | 199. | 217. | 235. |
| | 18" | 17 5/8" | 29" | 7/16" | DP3SS()2818 | 114. | 114. | 135. | 199. | 217. | 235. |
| | 24" | 23 5/8" | 29" | 7/16" | DP3SS()2824 | 133. | 133. | 164. | 231. | 263. | 287. |
| | 30" | 29 5/8" | 29" | 7/16" | DP3SS()2830 | 141. | 163. | 178. | 251. | 287. | 314. |
| | 36" | 35 5/8" | 29" | 7/16" | DP3SS()2836 | 156. | 178. | 198. | 275. | 314. | 348. |
| | 42" | 41 5/8" | 29" | 7/16" | DP3SS()2842 | 162. | 180. | 198. | 285. | 316. | 352. |
| | 48" | 47 5/8" | 29" | 7/16" | DP3SS()2848 | 166. | 189. | 209. | 296. | 337. | 368. |

Ordering Information

Solid Steel Insert

1. Pattern number
2. Paint finish

Order Code

Solid Steel Insert

Example: **DP3SS()2118 115**

DP3 Pattern number

SS22118

115 Medium Grey paint

Included with:

Solid Steel Insert

Options

Solid Steel Insert

Insert pack quantity into parenthesis in pattern number

Tile to Floor Option:

Tile to Floor available in heights of 14", Worksurface Height, 24" and 28". To specify tile to floor, add an 'F' suffix to the pattern number and add \$17 for a single pack, \$33 for a double pack and \$99 for a 6 pack to the list price.

7", 10", 14" and 21" High Perforated Steel Insert

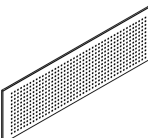
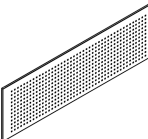
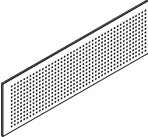
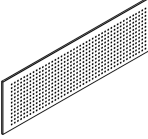
| description | w* | w | h | d | pattern no. | 1 pack P1 | 1 pack P2 | 1 pack P3 | 6 pack P1 | 6 pack P2 | 6 pack P3 |
|--|-----|----------------------------------|-----------------------------------|--------------------------------|----------------------|-----------|-----------|-----------|-----------|-----------|-----------|
| D3 7" High Perforated Steel Insert  | 15" | 14 ⁵ / ₈ " | 7 ³ / ₁₆ " | ⁷ / ₁₆ " | DP3PSB()715 | \$88. | \$102. | \$124. | \$394. | \$457. | \$539. |
| | 18" | 17 ⁵ / ₈ " | 7 ³ / ₁₆ " | ⁷ / ₁₆ " | DP3PSB()718 | 88. | 102. | 124. | 394. | 457. | 539. |
| | 24" | 23 ⁵ / ₈ " | 7 ³ / ₁₆ " | ⁷ / ₁₆ " | DP3PSB()724 | 96. | 116. | 128. | 416. | 514. | 564. |
| | 30" | 29 ⁵ / ₈ " | 7 ³ / ₁₆ " | ⁷ / ₁₆ " | DP3PSB()730 | 104. | 131. | 138. | 467. | 581. | 629. |
| | 36" | 35 ⁵ / ₈ " | 7 ³ / ₁₆ " | ⁷ / ₁₆ " | DP3PSB()736 | 127. | 146. | 155. | 539. | 629. | 678. |
| | 42" | 41 ⁵ / ₈ " | 7 ³ / ₁₆ " | ⁷ / ₁₆ " | DP3PSB()742 | 134. | 151. | 166. | 581. | 661. | 726. |
| | 48" | 47 ⁵ / ₈ " | 7 ³ / ₁₆ " | ⁷ / ₁₆ " | DP3PSB()748 | 137. | 157. | 171. | 613. | 703. | 758. |
| D3 10" High Perforated Steel Insert  | 15" | 14 ⁵ / ₈ " | 10 ³ / ₁₆ " | ⁷ / ₁₆ " | DP3PSB()1015 | 127. | 141. | 148. | 555. | 629. | 653. |
| | 18" | 17 ⁵ / ₈ " | 10 ³ / ₁₆ " | ⁷ / ₁₆ " | DP3PSB()1018 | 127. | 141. | 148. | 555. | 629. | 653. |
| | 24" | 23 ⁵ / ₈ " | 10 ³ / ₁₆ " | ⁷ / ₁₆ " | DP3PSB()1024 | 134. | 150. | 155. | 588. | 678. | 703. |
| | 30" | 29 ⁵ / ₈ " | 10 ³ / ₁₆ " | ⁷ / ₁₆ " | DP3PSB()1030 | 135. | 155. | 163. | 613. | 711. | 736. |
| | 36" | 35 ⁵ / ₈ " | 10 ³ / ₁₆ " | ⁷ / ₁₆ " | DP3PSB()1036 | 148. | 171. | 179. | 653. | 751. | 782. |
| | 42" | 41 ⁵ / ₈ " | 10 ³ / ₁₆ " | ⁷ / ₁₆ " | DP3PSB()1042 | 154. | 177. | 191. | 686. | 782. | 858. |
| | 48" | 47 ⁵ / ₈ " | 10 ³ / ₁₆ " | ⁷ / ₁₆ " | DP3PSB()1048 | 163. | 193. | 206. | 736. | 882. | 924. |
| D3 14" High Perforated Steel Insert  | 15" | 14 ⁵ / ₈ " | 14 ³ / ₁₆ " | ⁷ / ₁₆ " | DP3PSB()1415 | 127. | 141. | 148. | 555. | 629. | 653. |
| | 18" | 17 ⁵ / ₈ " | 14 ³ / ₁₆ " | ⁷ / ₁₆ " | DP3PSB()1418 | 127. | 141. | 148. | 555. | 629. | 653. |
| | 24" | 23 ⁵ / ₈ " | 14 ³ / ₁₆ " | ⁷ / ₁₆ " | DP3PSB()1424 | 134. | 150. | 155. | 588. | 678. | 703. |
| | 30" | 29 ⁵ / ₈ " | 14 ³ / ₁₆ " | ⁷ / ₁₆ " | DP3PSB()1430 | 135. | 155. | 163. | 613. | 711. | 736. |
| | 36" | 35 ⁵ / ₈ " | 14 ³ / ₁₆ " | ⁷ / ₁₆ " | DP3PSB()1436 | 148. | 171. | 179. | 653. | 751. | 782. |
| | 42" | 41 ⁵ / ₈ " | 14 ³ / ₁₆ " | ⁷ / ₁₆ " | DP3PSB()1442 | 154. | 177. | 191. | 686. | 782. | 858. |
| | 48" | 47 ⁵ / ₈ " | 14 ³ / ₁₆ " | ⁷ / ₁₆ " | DP3PSB()1448 | 163. | 193. | 206. | 736. | 882. | 924. |
| D3 21" High Perforated Steel Insert  | 15" | 14 ⁵ / ₈ " | 21 ³ / ₁₆ " | ⁷ / ₁₆ " | DP3PSB()2115 | 159. | 188. | 207. | 825. | 970. | 1,056. |
| | 18" | 17 ⁵ / ₈ " | 21 ³ / ₁₆ " | ⁷ / ₁₆ " | DP3PSB()2118 | 159. | 188. | 207. | 825. | 970. | 1,056. |
| | 24" | 23 ⁵ / ₈ " | 21 ³ / ₁₆ " | ⁷ / ₁₆ " | DP3PSB()2124 | 196. | 225. | 246. | 1,031. | 1,177. | 1,290. |
| | 30" | 29 ⁵ / ₈ " | 21 ³ / ₁₆ " | ⁷ / ₁₆ " | DP3PSB()2130 | 212. | 244. | 263. | 1,101. | 1,290. | 1,390. |
| | 36" | 35 ⁵ / ₈ " | 21 ³ / ₁₆ " | ⁷ / ₁₆ " | DP3PSB()2136 | 236. | 265. | 296. | 1,224. | 1,390. | 1,544. |
| | 42" | 41 ⁵ / ₈ " | 21 ³ / ₁₆ " | ⁷ / ₁₆ " | DP3PSB()2142 | 243. | 268. | 297. | 1,276. | 1,413. | 1,569. |
| | 48" | 47 ⁵ / ₈ " | 21 ³ / ₁₆ " | ⁷ / ₁₆ " | DP3PSB()2148 | 249. | 284. | 310. | 1,324. | 1,511. | 1,643. |

Panels, Build-To-Spec

Ordering Information

Perforated Steel Insert

1. Pattern number
2. Paint finish

Order Code

Perforated Steel Insert

Example: **DP3PBS21430 117**

DP3 Pattern number

PSB21430

117 Soft Grey paint

Included with:

Perforated Steel Insert

Options

Perforated Steel Insert

Insert pack quantity into parenthesis in pattern number

Tile to Floor Option:

Tile to Floor available in heights of 14", Worksurface Height, 24" and 28". To specify tile to floor, add an 'F' suffix to the pattern number and add \$17 for a single pack, \$33 for a double pack and \$99 for a 6 pack to the list price.

Tile to Floor Option not available on DP2 perforated steel tile insert.

14", Worksurface Height and 28" High Perforated Steel Insert

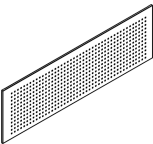
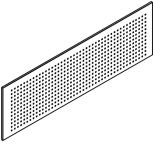
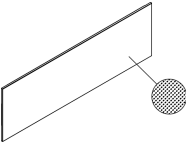
| description | w* | w | h | d | pattern no. | 1 pack P1 | 1 pack P2 | 1 pack P3 | 2 pack P1 | 2 pack P2 | 2 pack P3 |
|--|-----|---------|----------|-------|---------------|-----------|-----------|-----------|-----------|-----------|-----------|
| D3 Worksurface Height Perforated Steel Insert  | 15" | 14 5/8" | 22 1/2" | 7/16" | DP3PSB()WH15 | \$159. | \$188. | \$207. | \$275. | \$323. | \$352. |
| | 18" | 17 5/8" | 22 1/2" | 7/16" | DP3PSB()WH18 | 159. | 188. | 207. | 275. | 323. | 352. |
| | 24" | 23 5/8" | 22 1/2" | 7/16" | DP3PSB()WH24 | 196. | 225. | 246. | 344. | 394. | 431. |
| | 30" | 29 5/8" | 22 1/2" | 7/16" | DP3PSB()WH30 | 212. | 244. | 263. | 368. | 431. | 464. |
| | 36" | 35 5/8" | 22 1/2" | 7/16" | DP3PSB()WH36 | 236. | 265. | 296. | 408. | 464. | 514. |
| | 42" | 41 5/8" | 22 1/2" | 7/16" | DP3PSB()WH42 | 243. | 268. | 297. | 425. | 471. | 523. |
| | 48" | 47 5/8" | 22 1/2" | 7/16" | DP3PSB()WH48 | 249. | 284. | 310. | 442. | 503. | 548. |
| D3 28" High Perforated Steel Insert  | 15" | 14 5/8" | 29" | 7/16" | DP3PSB()2815 | 173. | 173. | 206. | 298. | 328. | 352. |
| | 18" | 17 5/8" | 29" | 7/16" | DP3PSB()2818 | 173. | 173. | 206. | 298. | 328. | 352. |
| | 24" | 24 5/8" | 29" | 7/16" | DP3PSB()2824 | 199. | 199. | 246. | 348. | 398. | 435. |
| | 30" | 29 5/8" | 29" | 7/16" | DP3PSB()2830 | 213. | 244. | 265. | 375. | 435. | 471. |
| | 36" | 35 5/8" | 29" | 7/16" | DP3PSB()2836 | 236. | 265. | 296. | 414. | 471. | 523. |
| | 42" | 41 5/8" | 29" | 7/16" | DP3PSB()2842 | 243. | 269. | 296. | 431. | 473. | 528. |
| | 48" | 47 5/8" | 29" | 7/16" | DP3PSB()2848 | 249. | 284. | 311. | 447. | 505. | 552. |
| D2 14" High Perforated Steel Insert  | 18" | 17 5/8" | 14 3/16" | 7/16" | DP2PS()1418 | 109. | 122. | 128. | 207. | 223. | 233. |
| | 24" | 23 5/8" | 14 3/16" | 7/16" | DP2PS()1424 | 146. | 157. | 168. | 272. | 303. | 316. |
| | 30" | 29 5/8" | 14 3/16" | 7/16" | DP2PS()1430 | 148. | 162. | 171. | 279. | 306. | 319. |
| | 36" | 35 5/8" | 14 3/16" | 7/16" | DP2PS()1436 | 150. | 164. | 175. | 282. | 310. | 321. |
| | 42" | 41 5/8" | 14 3/16" | 7/16" | DP2PS()1442 | 150. | 167. | 175. | 285. | 315. | 329. |
| | 48" | 47 5/8" | 14 3/16" | 7/16" | DP2PS()1448 | 154. | 171. | 178. | 290. | 319. | 334. |

Ordering Information

Perforated Steel Insert

1. Pattern number
2. Paint finish

Order Code

Perforated Steel Insert

Example: **DP3PBS21430 117**

DP3 Pattern number

PSB21430

117 Soft Grey paint

Included with:

Perforated Steel Insert

Options

Perforated Steel Insert

Insert pack quantity into parenthesis in pattern number

Tile to Floor Option:

Tile to Floor available in heights of 14", Worksurface Height, 24" and 28". To specify tile to floor, add an 'F' suffix to the pattern number and add \$17 for a single pack, \$33 for a double pack and \$99 for a 6 pack to the list price.

Tile to Floor Option not available on DP2 perforated steel tile insert.

7", 10", 14" and 21" High Embossed Steel Insert

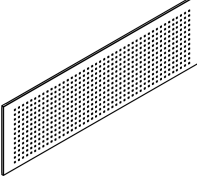
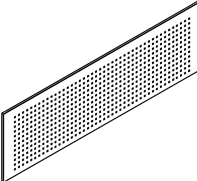
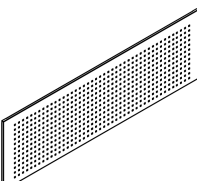
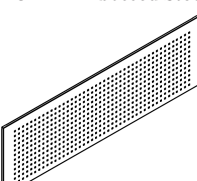
| description | w* | w | h | d | pattern no. | 1 pack P1 | 1 pack P2 | 1 pack P3 | 6 pack P1 | 6 pack P2 | 6 pack P3 |
|---|-----|----------------------------------|-----------------------------------|--------------------------------|----------------------|-----------|-----------|-----------|-----------|-----------|-----------|
|  D3 7" High Embossed Steel Insert | 15" | 14 ⁵ / ₈ " | 7 ³ / ₁₆ " | ⁷ / ₁₆ " | DP3ESB()715 | \$88. | \$102. | \$124. | \$394. | \$457. | \$539. |
| | 18" | 17 ⁵ / ₈ " | 7 ³ / ₁₆ " | ⁷ / ₁₆ " | DP3ESB()718 | 88. | 102. | 124. | 394. | 457. | 539. |
| | 24" | 23 ⁵ / ₈ " | 7 ³ / ₁₆ " | ⁷ / ₁₆ " | DP3ESB()724 | 96. | 116. | 128. | 416. | 514. | 564. |
| | 30" | 30 ⁵ / ₈ " | 7 ³ / ₁₆ " | ⁷ / ₁₆ " | DP3ESB()730 | 104. | 131. | 138. | 467. | 581. | 629. |
| | 36" | 35 ⁵ / ₈ " | 7 ³ / ₁₆ " | ⁷ / ₁₆ " | DP3ESB()736 | 127. | 146. | 155. | 539. | 629. | 678. |
| | 42" | 41 ⁵ / ₈ " | 7 ³ / ₁₆ " | ⁷ / ₁₆ " | DP3ESB()742 | 134. | 151. | 166. | 581. | 661. | 726. |
| | 48" | 47 ⁵ / ₈ " | 7 ³ / ₁₆ " | ⁷ / ₁₆ " | DP3ESB()748 | 137. | 157. | 171. | 613. | 703. | 758. |
|  D3 10" High Embossed Steel Insert | 15" | 14 ⁵ / ₈ " | 10 ³ / ₁₆ " | ⁷ / ₁₆ " | DP3ESB()1015 | 127. | 141. | 148. | 555. | 629. | 653. |
| | 18" | 17 ⁵ / ₈ " | 10 ³ / ₁₆ " | ⁷ / ₁₆ " | DP3ESB()1018 | 127. | 141. | 148. | 555. | 629. | 653. |
| | 24" | 23 ⁵ / ₈ " | 10 ³ / ₁₆ " | ⁷ / ₁₆ " | DP3ESB()1024 | 134. | 150. | 155. | 588. | 678. | 703. |
| | 30" | 29 ⁵ / ₈ " | 10 ³ / ₁₆ " | ⁷ / ₁₆ " | DP3ESB()1030 | 135. | 155. | 163. | 613. | 711. | 736. |
| | 36" | 35 ⁵ / ₈ " | 10 ³ / ₁₆ " | ⁷ / ₁₆ " | DP3ESB()1036 | 148. | 171. | 179. | 653. | 751. | 782. |
| | 42" | 41 ⁵ / ₈ " | 10 ³ / ₁₆ " | ⁷ / ₁₆ " | DP3ESB()1042 | 154. | 177. | 191. | 686. | 782. | 858. |
| | 48" | 47 ⁵ / ₈ " | 10 ³ / ₁₆ " | ⁷ / ₁₆ " | DP3ESB()1048 | 163. | 193. | 206. | 736. | 882. | 924. |
|  D3 14" High Embossed Steel Insert | 15" | 14 ⁵ / ₈ " | 14 ³ / ₁₆ " | ⁷ / ₁₆ " | DP3ESB()1415 | 127. | 141. | 148. | 555. | 629. | 653. |
| | 18" | 17 ⁵ / ₈ " | 14 ³ / ₁₆ " | ⁷ / ₁₆ " | DP3ESB()1418 | 127. | 141. | 148. | 555. | 629. | 653. |
| | 24" | 23 ⁵ / ₈ " | 14 ³ / ₁₆ " | ⁷ / ₁₆ " | DP3ESB()1424 | 134. | 150. | 155. | 588. | 678. | 703. |
| | 30" | 29 ⁵ / ₈ " | 14 ³ / ₁₆ " | ⁷ / ₁₆ " | DP3ESB()1430 | 135. | 155. | 163. | 613. | 711. | 736. |
| | 36" | 35 ⁵ / ₈ " | 14 ³ / ₁₆ " | ⁷ / ₁₆ " | DP3ESB()1436 | 148. | 171. | 179. | 653. | 751. | 782. |
| | 42" | 41 ⁵ / ₈ " | 14 ³ / ₁₆ " | ⁷ / ₁₆ " | DP3ESB()1442 | 154. | 177. | 191. | 686. | 782. | 858. |
| | 48" | 47 ⁵ / ₈ " | 14 ³ / ₁₆ " | ⁷ / ₁₆ " | DP3ESB()1448 | 163. | 193. | 206. | 736. | 882. | 924. |
|  D3 21" Embossed Steel Insert | 15" | 14 ⁵ / ₈ " | 21" | ⁷ / ₁₆ " | DP3ESB()2115 | 159. | 188. | 207. | 825. | 970. | 1,056. |
| | 18" | 17 ⁵ / ₈ " | 21" | ⁷ / ₁₆ " | DP3ESB()2118 | 159. | 188. | 207. | 825. | 970. | 1,056. |
| | 24" | 23 ⁵ / ₈ " | 21" | ⁷ / ₁₆ " | DP3ESB()2124 | 196. | 225. | 246. | 1,031. | 1,177. | 1,290. |
| | 30" | 29 ⁵ / ₈ " | 21" | ⁷ / ₁₆ " | DP3ESB()2130 | 212. | 244. | 263. | 1,101. | 1,290. | 1,390. |
| | 36" | 35 ⁵ / ₈ " | 21" | ⁷ / ₁₆ " | DP3ESB()2136 | 236. | 265. | 296. | 1,224. | 1,390. | 1,544. |
| | 42" | 41 ⁵ / ₈ " | 21" | ⁷ / ₁₆ " | DP3ESB()2142 | 243. | 268. | 297. | 1,276. | 1,413. | 1,569. |
| | 48" | 47 ⁵ / ₈ " | 21" | ⁷ / ₁₆ " | DP3ESB()2148 | 249. | 284. | 310. | 1,324. | 1,511. | 1,643. |

Panels, Build-To-Spec

Ordering Information

Embossed Steel Insert

1. Pattern number
2. Paint finish

Order Code

Embossed Steel Insert

Example: **DP3ESB21430 117**

DP3 Pattern number

ESB21430

117 Soft Grey paint

Included with:

Embossed Steel Insert

Options

Embossed Steel Insert

Insert pack quantity into parenthesis in pattern number

Tile to Floor Option:

Tile to Floor available in heights of 14", Worksurface Height, 24" and 28". To specify tile to floor, add an 'F' suffix to the pattern number and add \$17 for a single pack, \$33 for a double pack and \$99 for a 6 pack to the list price.

Worksurface Height and 28" High Embossed Steel Insert

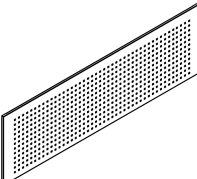
| description | w* | w | h | d | pattern no. | 1 pack P1 | 1 pack P2 | 1 pack P3 | 2 pack P1 | 2 pack P2 | 2 pack P3 |
|--|-----|---------|---------|-------|----------------------|--------------|--------------|--------------|--------------|--------------|--------------|
|  D3 Worksurface Height Embossed Steel Insert | 15" | 14 5/8" | 22 1/2" | 7/16" | DP3ESB()WH15 | \$159. | \$188. | \$207. | \$275. | \$323. | \$352. |
| | 18" | 17 5/8" | 22 1/2" | 7/16" | DP3ESB()WH18 | 159. | 188. | 207. | 275. | 323. | 352. |
| | 24" | 23 5/8" | 22 1/2" | 7/16" | DP3ESB()WH24 | 196. | 225. | 246. | 344. | 394. | 431. |
| | 30" | 39 5/8" | 22 1/2" | 7/16" | DP3ESB()WH30 | 212. | 244. | 263. | 368. | 431. | 464. |
| | 36" | 35 5/8" | 22 1/2" | 7/16" | DP3ESB()WH36 | 236. | 265. | 296. | 408. | 464. | 514. |
| | 42" | 41 5/8" | 22 1/2" | 7/16" | DP3ESB()WH42 | 243. | 268. | 297. | 425. | 471. | 523. |
| | 48" | 47 5/8" | 22 1/2" | 7/16" | DP3ESB()WH48 | 249. | 284. | 310. | 442. | 503. | 548. |

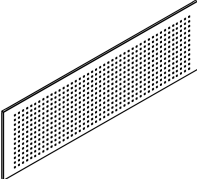
| description | w* | w | h | d | pattern no. | 1 pack P1 | 1 pack P2 | 1 pack P3 | 2 pack P1 | 2 pack P2 | 2 pack P3 |
|--|-----|---------|-----|-------|----------------------|--------------|--------------|--------------|--------------|--------------|--------------|
|  D3 28" High Embossed Steel Insert | 15" | 14 5/8" | 29" | 7/16" | DP3ESB()2815 | 173. | 173. | 206. | 298. | 328. | 352. |
| | 18" | 17 5/8" | 29" | 7/16" | DP3ESB()2818 | 173. | 173. | 206. | 298. | 328. | 352. |
| | 24" | 23 5/8" | 29" | 7/16" | DP3ESB()2824 | 199. | 199. | 246. | 348. | 398. | 435. |
| | 30" | 29 5/8" | 29" | 7/16" | DP3ESB()2830 | 213. | 244. | 265. | 375. | 435. | 471. |
| | 36" | 35 5/8" | 29" | 7/16" | DP3ESB()2836 | 236. | 265. | 296. | 414. | 471. | 523. |
| | 42" | 41 5/8" | 29" | 7/16" | DP3ESB()2842 | 243. | 269. | 296. | 431. | 473. | 528. |
| | 48" | 47 5/8" | 29" | 7/16" | DP3ESB()2848 | 249. | 284. | 311. | 447. | 505. | 552. |

Ordering Information

Embossed Steel Insert

1. Pattern number
2. Paint finish

Order Code

Embossed Steel Insert

Example: **DP3ESB22130 117**

DP3 Pattern number

ESB22130

117 Soft Grey paint

Included with:

Embossed Steel Insert

Options

Embossed Steel Insert

Insert pack quantity into parenthesis in pattern number

Tile to Floor Option:

Tile to Floor available in heights of 14", Worksurface Height, 24" and 28". To specify tile to floor, add an 'F' suffix to the pattern number and add \$17 for a single pack, \$33 for a double pack and \$99 for a 6 pack to the list price.

This page intentionally left blank

Slatwall Tiles

Slatwall tiles are designed to support KnollExtra Orchestra work tools. Slatwall tiles will support flat panel monitor arms with varying weight limitations based on mounting and application. Please refer to the KnollExtra price list for comprehensive mounting and weight limitation information by application. Slatwall kits include all mounting brackets and hardware for installation, and are fully assembled. SLATWALL TILES INCLUDE INTEGRAL TILE SUPPORT(S).

Slatwall tiles are field installed on Dividends Horizon DP7 panel frames or attached to wall mount tracks. To specify, select the slatwall width to match the width of the panel frame, in either top or middle position locations.

Specify slatwall tiles along with built-to-spec panel frames or wall mount tracks and other tiles for a complete installation. Slatwall tiles may not be specified directly above or below other slatwall tiles, beltway, stack frames, or stacking screens. Slatwall tiles may not be specified on stack frames.

Construction

Slatwall is constructed of heat treated extruded aluminum, powder coated in any Knoll Core paint color. 16 gauge steel reinforcements with integral hooks and tri-lobular screws on the back of slatwall provide reinforcement for heavy loads.

Note: Due to design improvements with the slatwall tile, monitor arm reinforcements are no longer required when hanging monitor arms from Dividends Horizon slatwall.

Top Position Slatwall Tiles

Top position slatwall tiles may be installed at the top of any Dividends Horizon DP7 panel frame or attached to wall mount tracks, and includes all required hardware. Top position slatwall is available in heights of 7, 14, 21 and 28 inches.

TOP POSITION SLATWALL TILES FEATURE AN INTEGRAL TILE SUPPORT AT THE BOTTOM, REPLACING THE SEPARATE D1 OR D2 TILE SUPPORT TYPICALLY REQUIRED BETWEEN TILES.

Middle Position Slatwall Tiles

Middle position slatwall tiles may be installed at the middle of any Dividends Horizon DP7 panel frame or attached to wall mount tracks, and includes all necessary hardware. Middle position slatwall is available in heights of 7, 14 and 21 inches.

MIDDLE POSITION SLATWALL TILES FEATURE AN INTEGRAL TILE SUPPORT AT THE TOP AND BOTTOM, REPLACING D1 OR D2 TILE SUPPORT TYPICALLY REQUIRED BETWEEN TILES.

Note: due to the canted design of the slatwall tile, a variable reveal exists in applications where slatwall tiles meet in a corner of a 90 degree configuration.

Top Position Slatwall

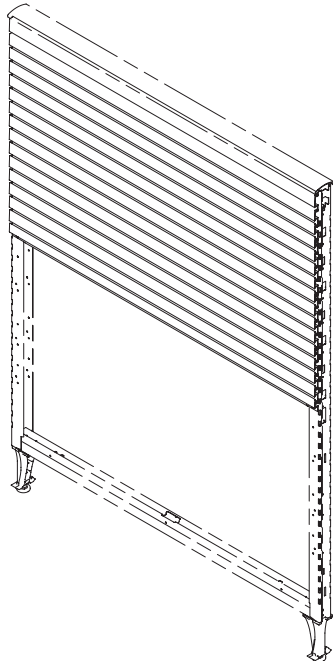

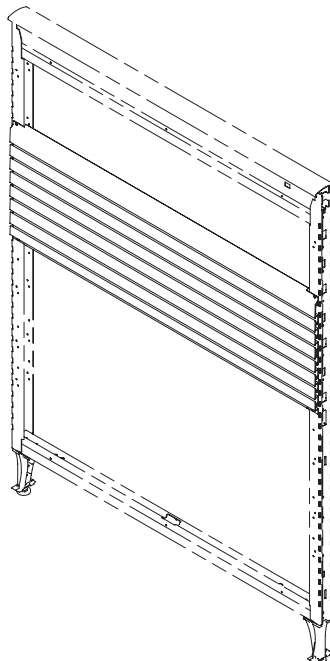

Middle Position Slatwall



Slatwall Tiles

7", 14", 21" and 28" High

Dividends Horizon

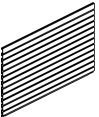
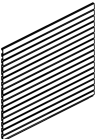
| description | w | h | d | pattern no. | P1 | P2 | P3 |
|---|-----|-----|-------|---------------------|--------|--------|--------|
| 7" High Slatwall Tile  | 24" | 7" | 7/16" | DP1SW0724() | \$220. | \$242. | \$253. |
| | 30" | 7" | 7/16" | DP1SW0730() | 235. | 260. | 270. |
| | 36" | 7" | 7/16" | DP1SW0736() | 253. | 278. | 288. |
| | 42" | 7" | 7/16" | DP1SW0742() | 266. | 292. | 306. |
| | 48" | 7" | 7/16" | DP1SW0748() | 282. | 310. | 322. |
| 14" High Slatwall Tile  | 24" | 14" | 7/16" | DP1SW1424() | 295. | 326. | 357. |
| | 30" | 14" | 7/16" | DP1SW1430() | 348. | 383. | 416. |
| | 36" | 14" | 7/16" | DP1SW1436() | 399. | 439. | 479. |
| | 42" | 14" | 7/16" | DP1SW1442() | 436. | 479. | 521. |
| | 48" | 14" | 7/16" | DP1SW1448() | 472. | 519. | 569. |
| 21" High Slatwall Tile  | 24" | 21" | 7/16" | DP1SW2124() | 392. | 431. | 470. |
| | 30" | 21" | 7/16" | DP1SW2130() | 471. | 516. | 564. |
| | 36" | 21" | 7/16" | DP1SW2136() | 549. | 605. | 659. |
| | 42" | 21" | 7/16" | DP1SW2142() | 607. | 668. | 728. |
| | 48" | 21" | 7/16" | DP1SW2148() | 662. | 729. | 797. |
| 28" Top Position Slatwall Tile  | 24" | 28" | 7/16" | DP1SW2824() | 487. | 537. | 584. |
| | 30" | 28" | 7/16" | DP1SW2830() | 593. | 651. | 710. |
| | 36" | 28" | 7/16" | DP1SW2836() | 699. | 766. | 837. |
| | 42" | 28" | 7/16" | DP1SW2842() | 775. | 851. | 928. |
| | 48" | 28" | 7/16" | DP1SW2848() | 850. | 935. | 1,020. |

Panels, Build-To-Spec

Ordering Information

- Post Assemblies**
1. Pattern Number
 2. Paint Finish

Order Code

Post Assemblies
Example: **DP1 S2824T, 111**
DP1 S2824Pattern Number
T
111 Jet Black Paint

Included with:

Note: Middle position slatwall tiles are able to be used on topway or full view panels.

Options

Panel Options:
(T) = for topway panel top position
(F) = for full view panel top position
(M) = for middle position

Technology Tile

Dividends Horizon technology tiles are 14", worksurface height or 28" high fabric or painted steel tiles with a factory installed technology port for above worksurface power and/or data access. Technology ports may be specified on the left, right, or both sides of technology tiles.

Each technology port has two openings: duplex power receptacles are positioned to the outside of the panel, while data ports may be positioned in either of the two positions. For applications where only one of the two openings is used, a knockout filler is included with each data port to fill this opening.

Technology tiles with one port accommodate one power and one data or two data outlets. Technology tiles with two ports accommodate up to two power receptacles and two data outlets, or four data outlets.

Specify vertical power modules, power receptacles, and data components separately.

Construction

Steel inserts are made of 20-gauge formed painted steel. Fabric inserts are made with a roll-coat adhesive, heat-cured to $\frac{7}{16}$ " thick tackable acoustical board.

Available Sizes

Heights: 14", worksurface height, 28"
Widths: 18", 24", 30", 42", 48" and 60"

Note: Steel technology tiles are only available in Knoll Core finishes

Note: Technology tiles are not able to be specified in the top position of 36" high topway panel.

14" High Technology Tile

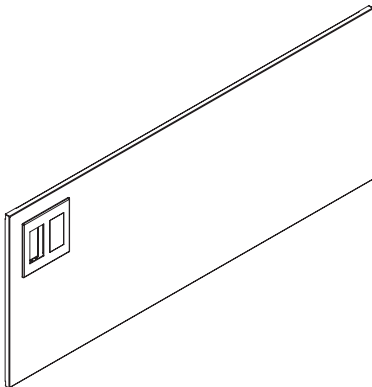

Worksurface Height Technology Tile

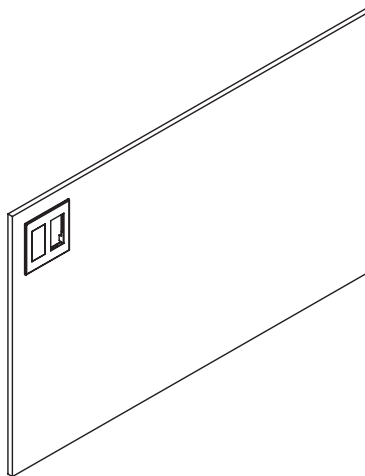

28" High Technology Tile

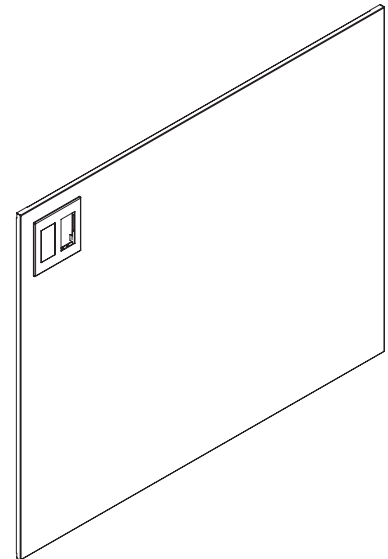

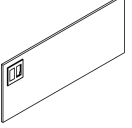
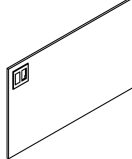
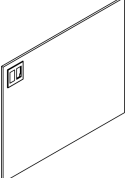
| description | h | w | pattern no. | grade | | | | | | | |
|--|---|---------|---------------------|---------------------|--------|--------|--------|--------|--------|--------|--------|
| | | | | 10 | 15 | 20 | 25 | 30 | 35 | 40 | 45 |
| 14" High, Technology Tile Fabric  | 14" | 18" | DP6TF()1418 | \$164. | \$168. | \$175. | \$176. | \$179. | \$182. | \$183. | \$187. |
| | 14" | 24" | DP6TF()1424 | 172. | 175. | 180. | 182. | 184. | 189. | 191. | 198. |
| | 14" | 30" | DP6TF()1430 | 175. | 177. | 183. | 187. | 190. | 193. | 198. | 202. |
| | 14" | 36" | DP6TF()1436 | 179. | 183. | 190. | 191. | 199. | 202. | 214. | 215. |
| | 14" | 42" | DP6TF()1442 | 183. | 187. | 198. | 199. | 211. | 215. | 218. | 222. |
| | 14" | 48" | DP6TF()1448 | 190. | 191. | 207. | 214. | 218. | 219. | 223. | 229. |
| | 14" | 60" | DP6TF()1460 | 198. | 200. | 208. | 209. | 212. | 214. | 216. | 219. |
| | Worksurface Height, Technology Tile Fabric  | 22 1/2" | 18" | DP6TF()WH18 | 215. | 222. | 226. | 234. | 237. | 243. | 252. |
| 22 1/2" | | 24" | DP6TF()WH24 | 235. | 243. | 258. | 265. | 275. | 279. | 285. | 298. |
| 22 1/2" | | 30" | DP6TF()WH30 | 251. | 258. | 275. | 282. | 290. | 298. | 306. | 318. |
| 22 1/2" | | 36" | DP6TF()WH36 | 263. | 275. | 290. | 301. | 315. | 322. | 329. | 336. |
| 22 1/2" | | 42" | DP6TF()WH42 | 271. | 280. | 292. | 303. | 317. | 324. | 333. | 346. |
| 22 1/2" | | 48" | DP6TF()WH48 | 280. | 290. | 306. | 318. | 326. | 334. | 347. | 365. |
| 22 1/2" | | 60" | DP6TF()WH60 | 295. | 307. | 320. | 334. | 336. | 348. | 364. | 393. |
| 28" High, Technology Tile Fabric  | | 28" | 18" | DP6TF()2818 | 215. | 222. | 226. | 234. | 237. | 243. | 252. |
| | 28" | 24" | DP6TF()2824 | 235. | 243. | 258. | 265. | 275. | 279. | 285. | 298. |
| | 28" | 30" | DP6TF()2830 | 251. | 258. | 275. | 282. | 290. | 298. | 306. | 318. |
| | 28" | 36" | DP6TF()2836 | 263. | 275. | 290. | 301. | 315. | 322. | 329. | 336. |
| | 28" | 42" | DP6TF()2842 | 271. | 280. | 292. | 303. | 317. | 324. | 333. | 346. |
| | 28" | 48" | DP6TF()2848 | 280. | 290. | 306. | 318. | 326. | 334. | 347. | 365. |
| | 28" | 60" | DP6TF()2860 | 315. | 321. | 332. | 336. | 344. | 350. | 356. | 362. |

Panels, Build-To-Spec

Ordering Information

Technology Tile Fabric:

1. Pattern Number
2. Fabric
3. Bezel location

Order Code

Technology Tile Fabric

Example: **DP3TFL1418/ W352-4**

DP3TF Technology Tile Fabric

L Left Hand Bezel Location

14 Height

18 Width

W352-4 Labrynth Sage Fabric

Included with:

Technology Tile Fabric

- Fabric Technology Tile
- Bezel

Options

Technology Tile Fabric

Bezel Location Options:

- (L)** = Left Hand Bezel
- (R)** = Right Hand Bezel
- (D)** = Double Bezel - add \$45

Tile to Floor Options:

Tile to Floor available in heights of 14", Worksurface Height, and 28". To specify tile to floor, add an "F" suffix to the pattern number and add \$11 to the list price.

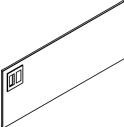
| description | h | w | pattern no. | P1 | P2 | P3 |
|--|-----|-----|---------------------|--------|--------|--------|
| 14" High, Technology Tile Steel  | 14" | 18" | DP6TS()1418 | \$144. | \$152. | \$155. |
| | 14" | 24" | DP6TS()1424 | 150. | 157. | 163. |
| | 14" | 30" | DP6TS()1430 | 151. | 159. | 164. |
| | 14" | 36" | DP6TS()1436 | 159. | 170. | 176. |
| | 14" | 42" | DP6TS()1442 | 163. | 175. | 179. |
| | 14" | 48" | DP6TS()1448 | 170. | 181. | 185. |
| | 14" | 60" | DP6TS()1460 | 180. | 190. | 194. |

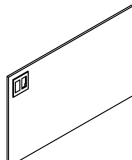
| Worksurface Height, Technology Tile Steel | h | w | pattern no. | P1 | P2 | P3 |
|---|---------|-----|---------------------|------|------|------|
|  | 22 1/2" | 18" | DP6TS()WH18 | 176. | 185. | 190. |
| | 22 1/2" | 24" | DP6TS()WH24 | 191. | 208. | 213. |
| | 22 1/2" | 30" | DP6TS()WH30 | 202. | 215. | 222. |
| | 22 1/2" | 36" | DP6TS()WH36 | 217. | 234. | 241. |
| | 22 1/2" | 42" | DP6TS()WH42 | 222. | 238. | 246. |
| | 22 1/2" | 48" | DP6TS()WH48 | 226. | 242. | 251. |
| | 22 1/2" | 60" | DP6TS()WH60 | 226. | 242. | 251. |

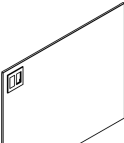
| 28" High, Technology Tile Steel | h | w | pattern no. | P1 | P2 | P3 |
|---|-----|-----|---------------------|------|------|------|
|  | 28" | 18" | DP6TS()2818 | 176. | 185. | 190. |
| | 28" | 24" | DP6TS()2824 | 191. | 208. | 213. |
| | 28" | 30" | DP6TS()2830 | 202. | 215. | 222. |
| | 28" | 36" | DP6TS()2836 | 217. | 234. | 241. |
| | 28" | 42" | DP6TS()2842 | 222. | 238. | 246. |
| | 28" | 48" | DP6TS()2848 | 226. | 242. | 251. |

Ordering Information

Technology Tile Steel

1. Pattern Number
2. Paint
3. Bezel location

Order Code

Technology Tile Steel

Example: **DP3TSL1418/ 113**

| | |
|--------------|--------------------------|
| DPSTS | Technology Tile Steel |
| L | Left Hand Bezel Location |
| 14 | Height |
| 18 | Width |
| 113 | Dark Grey Paint Finish |

Included with:

Technology Tile Steel

- Steel Technology Tile
- Bezel

Note: Steel technology tiles are only available in Knoll core finishes.

Options

Technology Tile Steel

Bezel Location Options:

- (L)** = Left Hand Bezel
- (R)** = Right Hand Bezel
- (D)** = Double Bezel - add \$45

Tile to Floor Options:

Tile to Floor available in heights of 14", Worksurface Height, and 28". To specify tile to floor, add an "F" suffix to the pattern number and add \$17 to the list price.

This page intentionally left blank

Dividends Horizon rolling doors were developed for clients desiring increased privacy for focused work.

Rolling doors are available in 57, 64 and 78" overall heights, and widths to accommodate panel openings of 36, 42 and 48 inches.

Planning

Rolling doors must be mounted to the end of an equal height Dividends Horizon panel or run of panels of equal or greater width. Doors may not be mounted to Dividends Horizon screens or universal posts.

Door jamb may be mounted directly to DP7 series universal posts – specify jamb to post attachment kit separately.

When fully open, the door will extend 2" beyond the end of the panel end trim on a panel of corresponding width.

Thresholds are included with door pattern number, and are required in all installations. The Dividends Horizon rolling door meets ADA 5 lb pull test requirements when used with the supplied threshold.

42" and 48" wide meet ADA access requirements with openings of 36.4"W and 42.4"W respectively.

Specifying 57" and 64" Rolling Doors

57" and 64" rolling doors include:

- Rolling door
- Mounting brackets
- Door jamb (for door side opposite to mounting brackets)
- Threshold

To complete the specification, specify an end trim for the panel to which the door is mounted, and a jamb-compatible top cap for the panel to which the door jamb is attached.

Specifying 78" Rolling Doors

78" rolling doors include:

- Rolling door
- Header
- Mounting brackets,
- Door jamb (for door side opposite to mounting brackets)
- Panel end trim
- Threshold

78" high doors include a header, with vertical clearance of 76 1/2" from height of finished floor. Specify a top cap for the header separately. Extended length top caps are recommended in this application.

No additional end trim is required for 78" high doors, as it is included in the door pattern number.

Construction

Rolling door and door jamb are constructed of extruded aluminum, powder coated in any Knoll Core paint finish. Threshold is anodized extruded aluminum.

Door inserts are available in clear, powder or bronze frosted glass.

Locks are optional, and engage with door jamb. Standard KnollKey system keying guidelines apply.

Opening Clearance

36"W door = 30.4"W

42"W door = 36.4"W

48"w door = 42.4W

42"W and 48"w doors are ADA compliant.

Rolling Door

57", 64" and 78" High

Dividends Horizon

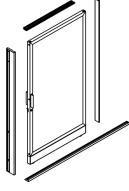
| description | type | w | d | h | pattern no. | Temp | GL13 | Plastic | Metal P1 | Metal P2 | Metal P3 |
|---|--------------------|-----|----|-----|------------------------|----------|----------|---------|----------|----------|----------|
| | | | | | | | GL25 | | | | |
|  <p>right hand shown</p> | 57" High with lock | 36" | 3" | 57" | DPRD15736(L/R)L | \$2,629. | \$2,708. | | | | |
| | | 42" | 3" | 57" | DPRD15742(L/R)L | 2,856. | 2,934. | | | | |
| | | 48" | 3" | 57" | DPRD15748(L/R)L | 3,142. | 3,227. | | | | |
| | 57" High no lock | 36" | 3" | 57" | DPRD15736(L/R)N | 2,546. | 2,625. | | | | |
| | | 42" | 3" | 57" | DPRD15742(L/R)N | 2,773. | 2,852. | | | | |
| | | 48" | 3" | 57" | DPRD15748(L/R)N | 3,049. | 3,137. | | | | |
| | 64" High with lock | 36" | 3" | 64" | DPRD16436(L/R)L | 2,736. | 2,833. | | | | |
| | | 42" | 3" | 64" | DPRD16442(L/R)L | 2,963. | 3,060. | | | | |
| | | 48" | 3" | 64" | DPRD16448(L/R)L | 3,259. | 3,365. | | | | |
| | 64" High no lock | 36" | 3" | 64" | DPRD16436(L/R)N | 2,653. | 2,751. | | | | |
| | | 42" | 3" | 64" | DPRD16442(L/R)N | 2,880. | 2,976. | | | | |
| | | 48" | 3" | 64" | DPRD16448(L/R)N | 3,168. | 3,275. | | | | |
| | 78" High with lock | 36" | 3" | 78" | DPRD17836(L/R)L | 3,180. | 3,313. | | | | |
| | | 42" | 3" | 78" | DPRD17842(L/R)L | 3,407. | 3,539. | | | | |
| | | 48" | 3" | 78" | DPRD17848(L/R)L | 3,748. | 3,893. | | | | |
| | 78" High no lock | 36" | 3" | 78" | DPRD17836(L/R)N | 3,098. | 3,230. | | | | |
| | | 42" | 3" | 78" | DPRD17842(L/R)N | 3,324. | 3,457. | | | | |
| | | 48" | 3" | 78" | DPRD17848(L/R)N | 3,656. | 3,803. | | | | |
| Panel Top Caps for Jamb Side | | 18" | | | DP()PT18RD | | | 36. | 66. | 68. | 70. |
| | | 24" | | | DP()PT24RD | | | 38. | 66. | 68. | 70. |
| | | 30" | | | DP()PT30RD | | | 43. | 66. | 68. | 70. |
| | | 36" | | | DP()PT36RD | | | 45. | 66. | 68. | 70. |
| | | 42" | | | DP()PT42RD | | | 45. | 66. | 68. | 70. |
| | | 48" | | | DP()PT48RD | | | 46. | 66. | 68. | 70. |
| | | 54" | | | DP()PT54RD | | | n/a | 70. | 72. | 74. |
| | | 60" | | | DP()PT60RD | | | 50. | 73. | 75. | 77. |
| | | 66" | | | DP()PT66RD | | | n/a | 77. | 80. | 83. |
| | | 72" | | | DP()PT72RD | | | n/a | 82. | 86. | 92. |
| | | 78" | | | DP()PT78RD | | | n/a | 90. | 95. | 98. |

Ordering Information

Rolling Door

1. Pattern Number
2. Glass type

Top Cap

1. Pattern Number
2. Paint finish

Application Notes:

Stacking screen header bracket is for use on 78" h doors (connection side) when connecting door header to top of 14" h stacking screen positioned on top of a 64" h panel.

Order Code

Rolling Door

Example: **DPRD1 5736 RL**

DPRD1 Rolling Door

57 Height

36 Width

R Right

L Lock

118T Bright White Textured

GL13 Frosted Glass

Included With:

Rolling Door

57" and 64" High

- Rolling Door
- Mounting Brackets
- Door jamb
- Threshold

78" High

- Rolling Door
- Header
- Mounting Brackets
- Door jamb
- Panel end trim
- Threshold

Top Cap

- Top Cap
- End Plug

Options

Rolling Door

Mounting Options:

- L** = Left Hand
R = Right Hand

Paint Finish:

All Core paint finishes

Glass Type:

Temp = Clear Glass
GL13 = Frosted Glass
GL25 = Bronze Glass
GL35 = Grey Glass

Top Cap

Top Cap Options:

- (2)** = Extruded Plastic (Smooth Radius)
(4) = Radius Metal
(5) = Flat Metal

Rolling Door

57", 64" and 78" High

Dividends Horizon

| description | type | w | d | h | pattern no. | Temp | GL13 | Plastic | Metal P1 | Metal P2 | Metal P3 |
|------------------------------------|------|-----|---|---|--------------------|------|------|---------|----------|----------|----------|
| | | | | | | | GL25 | | | | |
| Panel Top Caps for Jamb Side | | 84" | | | DP()PT84RD | | | n/a | \$97. | \$100. | \$104. |
| | | 90" | | | DP()PT90RD | | | n/a | 103. | 107. | 110. |
| | | 96" | | | DP()PT96RD | | | n/a | 108. | 113. | 118. |
| Door Jamb Kit to mount to DP7 Post | | | | | DPRD1JPM | | | 23. | 0. | 0. | 0. |
| Stacking screen header bracket | | | | | DPRD1SSB | | | 22. | 0. | 0. | 0. |

Ordering Information

Rolling Door

1. Pattern Number
2. Glass type

Top Cap

1. Pattern Number
2. Paint finish

Application Notes:

Stacking screen header bracket is for use on 78"h doors (connection side) when connecting door header to top of 14"h stacking screen positioned on top of a 64"h panel.

Order Code

Rolling Door

Example: **DPRD1 5736 RL**

DPRD1 Rolling Door

57 Height

36 Width

R Right

L Lock

118T Bright White Textured

GL13 Frosted Glass

Included With:

Rolling Door

57" and 64" High

- Rolling Door
- Mounting Brackets
- Door jamb
- Threshold

78" High

- Rolling Door
- Header
- Mounting Brackets
- Door jamb
- Panel end trim
- Threshold

Top Cap

- Top Cap
- End Plug

Options

Rolling Door

Mounting Options:

- L** = Left Hand
- R** = Right Hand

Paint Finish:

All Core paint finishes

Glass Type:

- Temp** = Clear Glass
- GL13** = Frosted Glass
- GL25** = Bronze Glass
- GL35** = Grey Glass

Top Cap

Top Cap Options:

- (2)** = Extruded Plastic (Smooth Radius)
- (4)** = Radius Metal
- (5)** = Flat Metal

This page intentionally left blank

Open Weave Screens

Open Weave screens are designed to allow light and transparency into the workstation, while providing limited visual privacy.

When combined with Dividends Horizon freestanding components, open weave screen provide a layered aesthetic to the office.

Open Weave Screen Construction

Open weave screens feature Warp Net, a new open textile structure designed by Suzanne Tick. Warp net is constructed of 100% Earthtex, made from Olefin. Earthtex has passed the prestigious McDonough Braungart Design Chemistry Sustainability Protocol, and is fully recyclable.

Open weave screens have a triangular profile frame, made from extruded aluminum frame members, powder coated in any Knoll Core paint finish.

Open Weave Screen Dimensions:

Widths: 24, 30, 36, 42, and 48 inches
Heights: 36, 42, 50, 57, and 64 inches
Thickness: 3 inches

Glass Screens

Glass Screens, available in both triangular and rectangular profile frames, provide territorial privacy, while transmitting light into the office.

Glass Screen Construction

Glass screens are available in both triangular and rectangular frame profiles, made from extruded aluminum frame members, powder coated in any Knoll Core paint finish. Glass is 4mm thick tempered glass.

Glass Screen Dimensions

Widths: 24, 30, 36, 42 and 48 inches
Heights: 42, 50, 57 and 64 inches
Thickness: 3 inches

Planning With Screens

Dividends Horizon open weave and glass screens are primarily designed to divide space and let light into the office. Screens do not have a slotted standard, and do not support overhead storage components. Screens feature slots to allow use of a mid-span worksurface support at the standard 28 1/2" H worksurface height.

Screens attach to Dividends Horizon panels or connecting posts of the same or greater height, or other screens of the same height. In a "high/low" situation, screens do not attach to higher or lower screens, or lower panels. Screens ship with attachment hardware and topcap, if specified.

Open Weave Screen with Triangular Frame and Open Base Option

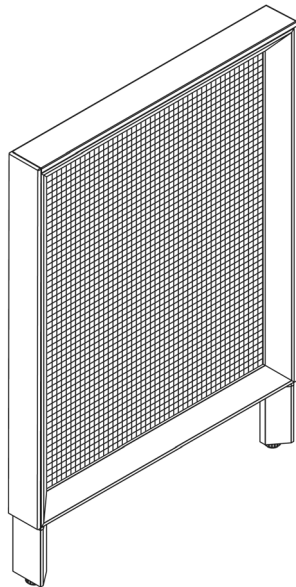

Glass Screen with Rectangular Frame and Open Base Option

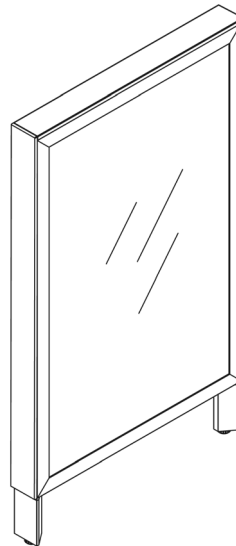

Screen Base Options

Open weave screens are available with three base options: base raceway, open base, or frame to floor. Triangular frame glass screens are available with three base options: base raceway, open base, or frame to floor. Rectangular frame glass screens are available with two base options: base raceway or open base. All bases feature leveling glides with 2" of vertical travel. Raceway covers are standard without knockouts. Screens support electrical pass-thru's, but do not support power modules or electrical receptacles.

Note: 36"H screen may not be connected to a Legacy post.

Note: 64" open weave screen "L" or "U" configurations require minimum 36" wide panel return(s).

Note: Raceway covers are not available with knockouts.

Note: Screens are only available in Knoll core finishes.

Freestanding Open Weave Screen Kits

When used with Open Weave Screens with frame-to-floor (FF) option, new Freestanding Open Weave Screen kits allow open weave screens to be used in freestanding applications, creating a sense of enclosure without the need for conventional panel or screen planning.

Freestanding Open Weave Screen Kits may be used with open weave screens only, and are not compatible with panels or glass screens.

A single open weave screen of any height or width may become freestanding by specifying the appropriately sized freestanding open weave screen kit. Freestanding open weave screen kits for single screen applications include (2) flat steel feet and (1) ballast plate. The width of the screen determines which freestanding open weave screen kit is specified. For example, a 48" wide open weave screen would use DP7SWTFK48.

Two open weave screens of the same height and width may be attached together to create a double freestanding open weave screen. There is a single pattern number (DP7SWTFKD) for the freestanding open weave screen kit that should be specified to create a double freestanding open weave screen. The double freestanding open weave screen kit includes (3) flat steel feet.

Note: Freestanding open weave screen kits are finished with textured paint, including 613 silver.

Freestanding Open Weave Screen Kit Dimensions

Flat Steel Feet

Width: 4 inches

Thickness: 7/16 inches

Depth: 20 inches

Freestanding Open Weave Screen (Double Screen)

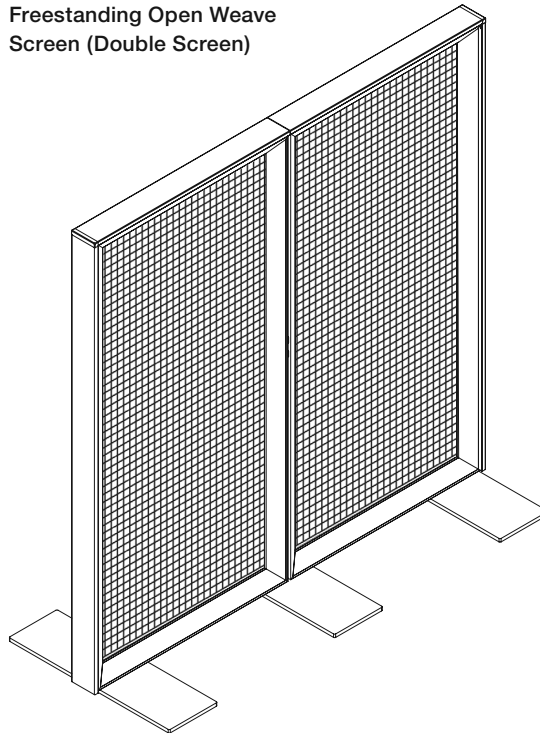

Open Weave and Glass Screens

Dividends Horizon

Open Weave Screens 36", 42", 50" and 57" High

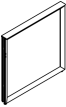
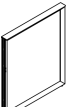
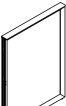
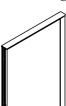
| description | h | w | t | pattern no. | P1 | P2 | P3 |
|--|-----|-----|----|----------------------|----------|----------|----------|
|  36" High Open Weave Screen | 36" | 24" | 3" | DP7SWT()3624 | \$1,025. | \$1,044. | \$1,066. |
| | 36" | 30" | 3" | DP7SWT()3630 | 1,128. | 1,149. | 1,173. |
| | 36" | 36" | 3" | DP7SWT()3636 | 1,129. | 1,150. | 1,174. |
| | 36" | 42" | 3" | DP7SWT()3642 | 1,180. | 1,203. | 1,227. |
| | 36" | 48" | 3" | DP7SWT()3648 | 1,230. | 1,257. | 1,282. |
|  42" High Open Weave Screen | 42" | 24" | 3" | DP7SWT()4224 | 1,106. | 1,128. | 1,149. |
| | 42" | 30" | 3" | DP7SWT()4230 | 1,177. | 1,201. | 1,224. |
| | 42" | 30" | 3" | DP7SWT()4236 | 1,252. | 1,275. | 1,300. |
| | 42" | 42" | 3" | DP7SWT()4242 | 1,262. | 1,288. | 1,314. |
| | 42" | 48" | 3" | DP7SWT()4248 | 1,274. | 1,299. | 1,324. |
|  50" High Open Weave Screen | 50" | 24" | 3" | DP7SWT()5024 | 1,187. | 1,210. | 1,234. |
| | 50" | 30" | 3" | DP7SWT()5030 | 1,227. | 1,254. | 1,279. |
| | 50" | 36" | 3" | DP7SWT()5036 | 1,270. | 1,294. | 1,320. |
| | 50" | 42" | 3" | DP7SWT()5042 | 1,346. | 1,370. | 1,398. |
| | 50" | 48" | 3" | DP7SWT()5048 | 1,419. | 1,447. | 1,475. |
|  57" High Open Weave Screen | 57" | 24" | 3" | DP7SWT()5724 | 1,210. | 1,234. | 1,258. |
| | 57" | 30" | 3" | DP7SWT()5730 | 1,286. | 1,314. | 1,336. |
| | 57" | 36" | 3" | DP7SWT()5736 | 1,362. | 1,390. | 1,418. |
| | 57" | 42" | 3" | DP7SWT()5742 | 1,390. | 1,419. | 1,445. |
| | 57" | 48" | 3" | DP7SWT()5748 | 1,419. | 1,447. | 1,475. |

*Note: Frame to the floor shown

| Ordering Information | Order Code | Included with: | Options |
|--|--|---|--|
| Open Weave Screen: 1. Pattern number 2. Frame finish 3. Top cap style 4. Top cap finish 5. Base finish 6. Fabric finish | Open Weave Screen: <i>Example:</i> DP7SWTFF3636 117/4/117/117/W1113-1 DP7SWT Triangular open weave screen FF Screen to Floor 117 Frame finish 4 Radius metal top cap 117 Top cap finish 117 Raceway finish W1113-1 Warp Net White | Open Weave Screen Note: 36" h screens are not compatible with Legacy post connectors. Note: Screens are only available in Knoll core finishes. | Open Weave Screen Top Cap Options: (2) = Extruded Plastic (Smooth Radius) (3) = No Top Cap (4) = Radius Metal, add \$40 P1, \$42 P2, \$44 P3 (5) = Flat Metal, add \$40 P1, \$42 P2, \$44 P3 paint grade Raceway Type: (FF) = Frame to the Floor both sides (RR) = Raceway covers no knockouts (LL) = Open base |

Note: Raceway covers are not available with knockouts.

Open Weave Screens

64" High and Freestanding Open Weave Screen Kits

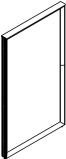
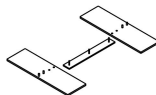
| description | type | h | w | d | pattern no. | P1 | P2 | P3 |
|--|---|-----|-----|----|----------------------|----------|----------|----------|
|  <p>64" High Open Weave Screen</p> | | 64" | 24" | 3" | DP7SWT()6424 | \$1,230. | \$1,257. | \$1,282. |
| | | 64" | 30" | 3" | DP7SWT()6430 | 1,347. | 1,371. | 1,399. |
| | | 64" | 36" | 3" | DP7SWT()6436 | 1,418. | 1,445. | 1,473. |
| | | 64" | 42" | 3" | DP7SWT()6442 | 1,436. | 1,464. | 1,494. |
| | | 64" | 48" | 3" | DP7SWT()6448 | 1,456. | 1,486. | 1,513. |
|  <p>Freestanding Open Weave Screen Kit</p> <p>(single screen kit shown)</p> | For use with 2 open weave screens | | | | DP7SWTFKD | 477. | 525. | 545. |
| | For use with 24" wide open weave screen | | | | DP7SWTFK24 | 445. | 490. | 509. |
| | For use with 30" wide open weave screen | | | | DP7SWTFK30 | 451. | 497. | 515. |
| | For use with 36" wide open weave screen | | | | DP7SWTFK36 | 463. | 509. | 529. |
| | For use with 42" wide open weave screen | | | | DP7SWTFK42 | 477. | 525. | 545. |
| | For use with 48" wide open weave screen | | | | DP7SWTFK48 | 477. | 525. | 545. |

Panels, Build-To-Spec

Ordering Information

Open Weave Screen:

1. Pattern number
2. Frame finish
3. Top cap style
4. Top cap finish
5. Base finish
6. Fabric finish

Freestanding Open Weave Screen Kits

1. Pattern number
2. Paint finish

Order Code

Open Weave Screen:

Example: **DP7SWTFF3636**
117/4/117/117/W1113-1

| | |
|----------------|------------------------------|
| DP7SWT | Triangular open weave screen |
| FF | Screen to Floor |
| 117 | Frame finish |
| 4 | Radius metal top cap |
| 117 | Top cap finish |
| 117 | Raceway finish |
| W1113-1 | Warp Net White |

Included with:

Open Weave Screen

Note: Freestanding open weave screen kits are finished with textured paint, including 613 Silver.

Note: Freestanding open weave screen kits only work with open weave screens with frame-to-floor (FF) base option.

Options:

Open Weave Screen

Top Cap Options:
(2) = Extruded Plastic (Smooth Radius)
(3) = No Top Cap
(4) = Radius Metal, add \$40 P1, \$42 P2, \$44 P3
(5) = Flat Metal, add \$40 P1, \$42 P2, \$44 P3 paint grade

Raceway Type:
(FF) = Frame to the Floor both sides
(RR) = Raceway covers no knockouts
(LL) = Open base

Note: Raceway covers are not available with knockouts.

Open Weave and Glass Screens

Triangular Frame Screen with Glass

42" and 50" High

Dividends Horizon

| description | h | w | t | pattern no. | P1 | P2 | P3 |
|--|-----|-----|----|------------------------|----------|----------|----------|
| 42" High Triangular Frame Screen with Glass  | 42" | 24" | 3" | DP7S()T()4224 | \$1,040. | \$1,062. | \$1,082. |
| | 42" | 30" | 3" | DP7S()T()4230 | 1,101. | 1,125. | 1,145. |
| | 42" | 36" | 3" | DP7S()T()4236 | 1,166. | 1,188. | 1,211. |
| | 42" | 42" | 3" | DP7S()T()4242 | 1,189. | 1,214. | 1,237. |
| | 42" | 48" | 3" | DP7S()T()4248 | 1,214. | 1,237. | 1,260. |

| | | | | | | | |
|--|-----|-----|----|------------------------|--------|--------|--------|
| 50" High Triangular Frame Screen with Glass  | 50" | 24" | 3" | DP7S()T()5024 | 1,118. | 1,141. | 1,165. |
| | 50" | 30" | 3" | DP7S()T()5030 | 1,147. | 1,171. | 1,192. |
| | 50" | 36" | 3" | DP7S()T()5036 | 1,176. | 1,199. | 1,222. |
| | 50" | 42" | 3" | DP7S()T()5042 | 1,275. | 1,299. | 1,324. |
| | 50" | 48" | 3" | DP7S()T()5048 | 1,368. | 1,397. | 1,424. |

*Note: Frame with raceway covers shown

| Ordering Information | Order Code | Included with: | Options |
|---|---|--|---|
| Triangular Frame Screen with Glass: 1. Pattern number 2. Frame finish 3. Glass type 4. Top cap style 5. Top cap finish 6. Raceway finish | Triangular Frame with Glass: <i>Example:</i> DP7SGTRR4236 117/4/117/117 <hr/> DP7SGT Triangular frame with clear glass <hr/> RR Raceway type <hr/> 117 Frame finish <hr/> 4 Radius metal top cap <hr/> 117 Top cap finish <hr/> 117 Raceway finish | Triangular Frame with Glass <ul style="list-style-type: none"> • Topcap (when specified) • Connecting hardware Note: Screens are only available in Knoll core finishes. | Glass Options: (G) = Clear Tempered Glass (F) = Powder Glass Top Cap Options: (2) = Extruded Plastic (Smooth Radius) (3) = No Top Cap (4) = Radius Metal, add \$40 P1, \$42 P2, \$44 P3 (5) = Flat Metal, add \$40 P1, \$42 P2, \$44 P3 paint grades Raceway Type: (FF) = Frame to the Floor both sides (RR) = Raceway covers no knockouts (LL) = Open base Frame to floor option not available on Triangular glass screens. Note: Raceway covers are not available with knockouts. |

Open Weave and Glass Screens

Triangular Frame Screen with Glass

57" and 64" High

| description | h | w | t | pattern no. | P1 | P2 | P3 |
|---|-----|-----|----|------------------------|----------|----------|----------|
| 57" High Triangular Frame Screen with Glass | 57" | 24" | 3" | DP7S()T()5724 | \$1,147. | \$1,171. | \$1,192. |
| | 57" | 30" | 3" | DP7S()T()5730 | 1,211. | 1,234. | 1,258. |
| | 57" | 36" | 3" | DP7S()T()5736 | 1,276. | 1,300. | 1,326. |
| | 57" | 42" | 3" | DP7S()T()5742 | 1,326. | 1,352. | 1,378. |
| | 57" | 48" | 3" | DP7S()T()5748 | 1,374. | 1,403. | 1,430. |

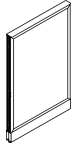

| | | | | | | | |
|---|-----|-----|----|------------------------|--------|--------|--------|
| 64" High Triangular Frame Screen with Glass | 64" | 24" | 3" | DP7S()T()6424 | 1,175. | 1,198. | 1,221. |
| | 64" | 30" | 3" | DP7S()T()6430 | 1,275. | 1,299. | 1,324. |
| | 64" | 36" | 3" | DP7S()T()6436 | 1,370. | 1,400. | 1,427. |
| | 64" | 42" | 3" | DP7S()T()6442 | 1,376. | 1,404. | 1,432. |
| | 64" | 48" | 3" | DP7S()T()6448 | 1,381. | 1,408. | 1,436. |

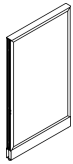

*Note: Frame to the floor shown

| Ordering Information | Order Code | Included with: | Options |
|---|---|--|---|
| Triangular Frame Screen with Glass: 1. Pattern number 2. Frame finish 3. Glass type 4. Top cap style 5. Top cap finish 6. Raceway finish | Triangular Frame with Glass: <i>Example:</i> DP7SGTRR5736 117/4/117/117 <hr/> DP7SGT Triangular frame with clear glass <hr/> RR Raceway type <hr/> 117 Frame finish <hr/> 4 Radius metal top cap <hr/> 117 Top cap finish <hr/> 117 Raceway finish | Triangular Frame with Glass <ul style="list-style-type: none"> • Topcap (when specified) • Connecting hardware Note: Screens are only available in Knoll core finishes. | Glass Options: (G) = Clear Tempered Glass (F) = Powder Glass Top Cap Options: (2) = Extruded Plastic (Smooth Radius) (3) = No Top Cap (4) = Radius Metal, add \$40 P1, \$42 P2, \$44 P3 (5) = Flat Metal, add \$40 P1, \$42 P2, \$44 P3 paint grades Raceway Type: (FF) = Frame to the Floor both sides (RR) = Raceway covers no knockouts (LL) = Open base Note: Raceway covers are not available with knockouts. |

Open Weave and Glass Screens

Rectangular Frame Screen with Glass

42" and 50" High

| description | h | w | t | pattern no. | P1 | P2 | P3 |
|--|-----|-----|----|------------------------|----------|----------|----------|
| 42" High Rectangular Frame Screen with Glass | 42" | 24" | 3" | DP7S()R()4224 | \$1,046. | \$1,067. | \$1,090. |
| | 42" | 30" | 3" | DP7S()R()4230 | 1,110. | 1,132. | 1,153. |
| | 42" | 36" | 3" | DP7S()R()4236 | 1,174. | 1,197. | 1,220. |
| | 42" | 42" | 3" | DP7S()R()4242 | 1,198. | 1,221. | 1,245. |
| | 42" | 48" | 3" | DP7S()R()4248 | 1,222. | 1,247. | 1,274. |

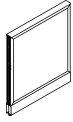

| | | | | | | | |
|--|-----|-----|----|------------------------|--------|--------|--------|
| 50" High Rectangular Frame Screen with Glass | 50" | 24" | 3" | DP7S()R()5024 | 1,128. | 1,150. | 1,174. |
| | 50" | 30" | 3" | DP7S()R()5030 | 1,156. | 1,181. | 1,205. |
| | 50" | 36" | 3" | DP7S()R()5036 | 1,187. | 1,211. | 1,234. |
| | 50" | 42" | 3" | DP7S()R()5042 | 1,285. | 1,312. | 1,335. |
| | 50" | 48" | 3" | DP7S()R()5048 | 1,383. | 1,411. | 1,438. |

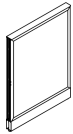

Ordering Information

Rectangular Frame Screen with Glass:

1. Pattern number
2. Frame finish
3. Glass type
4. Top cap style
5. Top cap finish
6. Raceway finish

Order Code

Rectangular Frame with Glass:

Example: **DP7SGRRR4236**
117/4/117/117

| | |
|---------------|---|
| DP7SGR | Rectangular frame screen with clear glass |
| RR | Raceway type |
| 117 | Frame finish |
| 4 | Radius metal top cap |
| 117 | Top cap finish |
| 117 | Raceway finish |

Included with:

Rectangular Frame Glass

- Topcap (when specified)
- Connecting hardware

Note: Screens are only available in Knoll core finishes.

Options

GlassOptions:

- (G)**= Clear Tempered Glass
- (F)** = Powder Glass

Top Cap Options:

- (2)** = Extruded Plastic (Smooth Radius)
- (3)** = No Top Cap
- (4)** = Radius Metal, add \$40 P1, \$42 P2, \$44 P3
- (5)** = Flat Metal, add \$40 P1, \$42 P2, \$44 P3 paint grades

Raceway Type:

- (RR)** = Raceway covers no knockouts
- (LL)** = Open base

Frame to floor option not available on Rectangular glass screens.

Note: Raceway covers are not available with knockouts.

Open Weave and Glass Screens

Rectangular Frame Screen with Glass

57" and 64" High

| description | h | w | t | pattern no. | P1 | P2 | P3 |
|--|-----|-----|----|------------------------|----------|----------|----------|
| 57" High Rectangular Frame Screen with Glass | 57" | 24" | 3" | DP7S()R()5724 | \$1,154. | \$1,179. | \$1,202. |
| | 57" | 30" | 3" | DP7S()R()5730 | 1,221. | 1,246. | 1,273. |
| | 57" | 36" | 3" | DP7S()R()5736 | 1,286. | 1,314. | 1,336. |
| | 57" | 42" | 3" | DP7S()R()5742 | 1,336. | 1,363. | 1,393. |
| | 57" | 48" | 3" | DP7S()R()5748 | 1,390. | 1,415. | 1,444. |

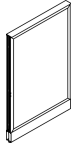

| | | | | | | | |
|--|-----|-----|----|------------------------|--------|--------|--------|
| 64" High Rectangular Frame Screen with Glass | 64" | 24" | 3" | DP7S()R()6424 | 1,182. | 1,207. | 1,228. |
| | 64" | 30" | 3" | DP7S()R()6430 | 1,284. | 1,311. | 1,334. |
| | 64" | 36" | 3" | DP7S()R()6436 | 1,384. | 1,412. | 1,439. |
| | 64" | 42" | 3" | DP7S()R()6442 | 1,390. | 1,415. | 1,444. |
| | 64" | 48" | 3" | DP7S()R()6448 | 1,394. | 1,421. | 1,448. |

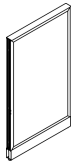

Ordering Information

Rectangular Frame Screen with Glass:

1. Pattern number
2. Frame finish
3. Glass type
4. Top cap style
5. Top cap finish
6. Raceway finish

Order Code

Rectangular Frame with Glass:

Example: **DP7SGRRR5736**
117/4/117/117

| | |
|---------------|---|
| DP7SGR | Rectangular frame screen with clear glass |
| RR | Raceway type |
| 117 | Frame finish |
| 4 | Radius metal top cap |
| 117 | Top cap finish |
| 117 | Raceway finish |

Included with:

Rectangular Frame Glass

- Topcap (when specified)
- Connecting hardware

Note: Screens are only available in Knoll core finishes.

Options

GlassOptions:

(G)= Clear Tempered Glass
(F) = Powder Glass

Top Cap Options:

(2) = Extruded Plastic (Smooth Radius)
(3) = No Top Cap
(4) = Radius Metal, add \$40 P1, \$42 P2, \$44 P3
(5) = Flat Metal, add \$40 P1, \$42 P2, \$44 P3 paint grades

Raceway Type:

(RR) = Raceway covers no knockouts
(LL) = Open base

Frame to floor option not available on Rectangular glass screens.

Note: Raceway covers are not available with knockouts.

Stacking Open Weave Screens

Stacking open weave screens are designed to allow light and transparency into the workstation, while providing limited visual privacy. When combined with Dividends Horizon freestanding components, open weave screens provide a layered aesthetic to the office.

Stacking Open Weave Screen Construction

Open weave screens feature Warp Net, a new open textile structure designed by Suzanne Tick. Warp Net is constructed of 100% Earthtex, made from Olefin. Earthtex has passed the prestigious McDonough Braungart Design Chemistry Sustainability Protocol, and is fully recyclable.

Open weave screens have a triangular profile frame, made from extruded aluminum frame members, powder coated in any Knoll Core paint finish.

Stacking Glass Screens

Stacking glass screens, available in both triangular and rectangular profile frames, provide territorial privacy, while transmitting light into the office.

Stacking Glass Screen Construction

Stacking glass screens are constructed of extruded aluminum frame members, powder coated in any Knoll Core paint finish. Clear glass is 4mm tempered glass.

Stacking Screen Dimensions:

Widths: 24, 30, 36, 42, and 48 inches

Heights: 14, 21 and 28 inches

Thickness: 3 inches

Planning With Stacking Screens

Dividends Horizon open weave and glass screens are primarily designed to divide space and let light into the office. Screens do not have a slotted standard, and do not support overhead storage components.

Stacking screens attach to any Dividends Horizon DP7V series full view panel frame, and may be stacked one tier high. Stacking screens do not stack on topway panel frames.

Stacking screens attach to Dividends Horizon DP7V panels or connecting posts of the same or greater height, or other screens of the same height.

Note: Stacking screens may be used with DP7 full view panel frames only.

Note: Screens are only available in Knoll core finishes.

Note: Knoll's three window types are aesthetically and functionally different, and are not designed to be mixed together within a single installation.

Triangular Stack Panel Screen with Open Weave Fabric insert

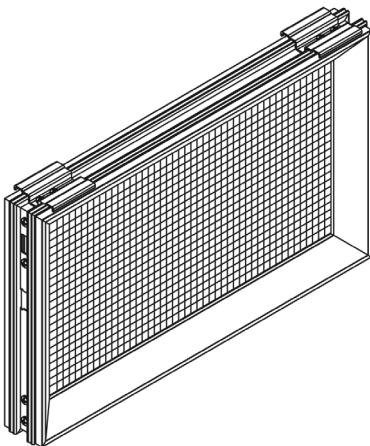

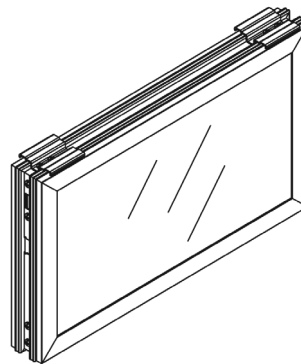

Rectangular Stack Panel Screen with Glass insert



Open Weave and Glass Stacking Screens

Triangular Frame Stacking Screen with Open Weave Fabric

Dividends Horizon

| description | h | w | t | pattern no. | P1 | P2 | P3 |
|---|-----|-----|----|--------------------|--------|--------|--------|
| 14" High Triangular Frame Stacking Screen with Open Weave Fabric  | 14" | 24" | 3" | DP7SSWT1424 | \$593. | \$604. | \$617. |
| | 14" | 30" | 3" | DP7SSWT1430 | 627. | 640. | 651. |
| | 14" | 36" | 3" | DP7SSWT1436 | 662. | 675. | 687. |
| | 14" | 42" | 3" | DP7SSWT1442 | 687. | 702. | 714. |
| | 14" | 48" | 3" | DP7SSWT1448 | 712. | 726. | 740. |
| 21" High Triangular Frame Stacking Screen with Open Weave Fabric  | 21" | 24" | 3" | DP7SSWT2124 | 635. | 648. | 661. |
| | 21" | 30" | 3" | DP7SSWT2130 | 676. | 688. | 703. |
| | 21" | 36" | 3" | DP7SSWT2136 | 718. | 731. | 745. |
| | 21" | 42" | 3" | DP7SSWT2142 | 745. | 762. | 776. |
| | 21" | 48" | 3" | DP7SSWT2148 | 773. | 787. | 806. |
| 28" High Triangular Frame Stacking Screen with Open Weave Fabric  | 28" | 24" | 3" | DP7SSWT2824 | 677. | 690. | 705. |
| | 28" | 30" | 3" | DP7SSWT2830 | 725. | 739. | 753. |
| | 28" | 36" | 3" | DP7SSWT2836 | 773. | 787. | 806. |
| | 28" | 42" | 3" | DP7SSWT2842 | 806. | 820. | 836. |
| | 28" | 48" | 3" | DP7SSWT2848 | 834. | 851. | 868. |

Panels, Build-To-Spec

Ordering Information

Triangular Frame Stacking Screen with Open Weave Fabric:

1. Pattern number
2. Frame finish
3. Fabric finish

Order Code

Triangular Frame Stacking Screen with Open Weave Fabric:

Example: **DP7SSWT1436**
117/W1113-1

DP7SSWT Stack, triangular frame, open weave

117 Frame finish

W1113-1 Fabric finish

Included with:

Triangular Frame Stacking Screen with Open Weave Fabric

- Attachment hardware



Note: Screens are only available in Knoll core finishes.

NOTE: Stacking screens are compatible with DP7 Full View panels only.

Open Weave and Glass Stacking Screens

Triangular Frame Stacking Screen with Glass

Dividends Horizon

| description | h | w | t | pattern no. | P1 | P2 | P3 |
|---|-----|-----|---------------|---------------|--------|--------|--------|
| 14" High Triangular Frame Stacking Screen with Glass  | 14" | 24" | 3" | DP7SS()T1424 | \$594. | \$605. | \$618. |
| | 14" | 30" | 3" | DP7SS()T1430 | 623. | 635. | 648. |
| | 14" | 36" | 3" | DP7SS()T1436 | 653. | 667. | 681. |
| | 14" | 42" | 3" | DP7SS()T1442 | 684. | 697. | 711. |
| | 14" | 48" | 3" | DP7SS()T1448 | 713. | 726. | 742. |
| | 14" | 54" | 3" | DP7SS()T1454 | 749. | 772. | 794. |
| | 14" | 60" | 3" | DP7SS()T1460 | 786. | 810. | 833. |
| | 14" | 66" | 3" | DP7SS()T1466 | 829. | 851. | 879. |
| | 14" | 72" | 3" | DP7SS()T1472 | 867. | 893. | 920. |
| | 14" | 78" | 3" | DP7SS()T1478 | 912. | 939. | 966. |
| | 14" | 84" | 3" | DP7SS()T1484 | 958. | 987. | 1,015. |
| | 14" | 90" | 3" | DP7SS()T1490 | 1,006. | 1,036. | 1,066. |
| 14" | 96" | 3" | DP7SS()T1496 | 1,057. | 1,088. | 1,119. | |
| 21" High Triangular Frame Stacking Screen with Glass  | 21" | 24" | 3" | DP7SS()T2124 | 641. | 653. | 668. |
| | 21" | 30" | 3" | DP7SS()T2130 | 677. | 691. | 705. |
| | 21" | 36" | 3" | DP7SS()T2136 | 712. | 725. | 740. |
| | 21" | 42" | 3" | DP7SS()T2142 | 747. | 762. | 777. |
| | 21" | 48" | 3" | DP7SS()T2148 | 782. | 802. | 816. |
| | 21" | 54" | 3" | DP7SS()T2154 | 822. | 846. | 869. |
| | 21" | 60" | 3" | DP7SS()T2160 | 862. | 888. | 914. |
| | 21" | 66" | 3" | DP7SS()T2166 | 905. | 932. | 960. |
| | 21" | 72" | 3" | DP7SS()T2172 | 951. | 979. | 1,008. |
| | 21" | 78" | 3" | DP7SS()T2178 | 998. | 1,029. | 1,059. |
| | 21" | 84" | 3" | DP7SS()T2184 | 1,047. | 1,080. | 1,111. |
| | 21" | 90" | 3" | DP7SS()T2190 | 1,100. | 1,134. | 1,167. |
| 21" | 96" | 3" | DP7SS()T2196 | 1,155. | 1,190. | 1,224. | |
| 28" High Triangular Frame Stacking Screen with Glass  | 28" | 24" | 3" | DP7SS()T2824 | 688. | 702. | 716. |
| | 28" | 30" | 3" | DP7SS()T2830 | 729. | 745. | 758. |
| | 28" | 36" | 3" | DP7SS()T2836 | 771. | 783. | 804. |
| | 28" | 42" | 3" | DP7SS()T2842 | 814. | 830. | 847. |
| | 28" | 48" | 3" | DP7SS()T2848 | 855. | 873. | 889. |
| | 28" | 54" | 3" | DP7SS()T2854 | 898. | 925. | 952. |
| | 28" | 60" | 3" | DP7SS()T2860 | 942. | 970. | 999. |
| | 28" | 66" | 3" | DP7SS()T2866 | 990. | 1,019. | 1,048. |
| | 28" | 72" | 3" | DP7SS()T2872 | 1,039. | 1,070. | 1,101. |
| | 28" | 78" | 3" | DP7SS()T2878 | 1,091. | 1,123. | 1,156. |
| | 28" | 84" | 3" | DP7SS()T2884 | 1,145. | 1,179. | 1,215. |
| | 28" | 90" | 3" | DP7SS()T2890 | 1,203. | 1,240. | 1,275. |
| 28" | 96" | 3" | DP7SS()T2896 | 1,263. | 1,300. | 1,340. | |

Ordering Information

Triangular Frame Stacking Screen

1. Pattern number
2. Frame finish
3. Glass

Order Code

Triangular Frame Stacking Screen

Example: DP7SSGT1424 / 117
 DP7SSGT Stack, Triangular Frame, w/ clear tempered glass
 117 Frame finish

Included with:

Triangular Frame Stacking Screen

- Attachment hardware
- Note:** Screens are only available in Knoll core finishes.

Options

NOTE: Stacking screens are compatible with DP7 Full View panels only.



Glass Options:

(G) = Clear Tempered Glass
 (F) = Powder Glass

Open Weave and Glass Stacking Screens

Rectangular Frame Stacking Screen with Glass

Dividends Horizon

| description | h* | w | t | pattern no. | P1 | P2 | P3 |
|--|-----|-----|---------------|---------------|--------|--------|--------|
| 14" High Rectangular Frame Stacking Screen with Glass  | 14" | 24" | 3" | DP7SS()R1424 | \$584. | \$595. | \$607. |
| | 14" | 30" | 3" | DP7SS()R1430 | 616. | 628. | 640. |
| | 14" | 36" | 3" | DP7SS()R1436 | 645. | 656. | 672. |
| | 14" | 42" | 3" | DP7SS()R1442 | 676. | 690. | 703. |
| | 14" | 48" | 3" | DP7SS()R1448 | 707. | 720. | 735. |
| | 14" | 54" | 3" | DP7SS()R1454 | 743. | 764. | 787. |
| | 14" | 60" | 3" | DP7SS()R1460 | 780. | 802. | 826. |
| | 14" | 66" | 3" | DP7SS()R1466 | 818. | 843. | 867. |
| | 14" | 72" | 3" | DP7SS()R1472 | 859. | 885. | 911. |
| | 14" | 78" | 3" | DP7SS()R1478 | 902. | 930. | 957. |
| | 14" | 84" | 3" | DP7SS()R1484 | 947. | 976. | 1,005. |
| | 14" | 90" | 3" | DP7SS()R1490 | 995. | 1,025. | 1,055. |
| | 14" | 96" | 3" | DP7SS()R1496 | 1,044. | 1,075. | 1,108. |
| 21" High Rectangular Frame Stacking Screen with Glass  | 21" | 24" | 3" | DP7SS()R2124 | 632. | 645. | 656. |
| | 21" | 30" | 3" | DP7SS()R2130 | 669. | 683. | 694. |
| | 21" | 36" | 3" | DP7SS()R2136 | 705. | 719. | 734. |
| | 21" | 42" | 3" | DP7SS()R2142 | 742. | 756. | 772. |
| | 21" | 48" | 3" | DP7SS()R2148 | 777. | 792. | 810. |
| | 21" | 54" | 3" | DP7SS()R2154 | 815. | 840. | 864. |
| | 21" | 60" | 3" | DP7SS()R2160 | 856. | 882. | 907. |
| | 21" | 66" | 3" | DP7SS()R2166 | 899. | 926. | 954. |
| | 21" | 72" | 3" | DP7SS()R2172 | 943. | 972. | 1,000. |
| | 21" | 78" | 3" | DP7SS()R2178 | 991. | 1,021. | 1,050. |
| | 21" | 84" | 3" | DP7SS()R2184 | 1,041. | 1,072. | 1,103. |
| 21" | 90" | 3" | DP7SS()R2190 | 1,093. | 1,126. | 1,158. | |
| 21" | 96" | 3" | DP7SS()R2196 | 1,147. | 1,181. | 1,216. | |
| 28" High Rectangular Frame Stacking Screen with Glass  | 28" | 24" | 3" | DP7SS()R2824 | 682. | 694. | 709. |
| | 28" | 30" | 3" | DP7SS()R2830 | 722. | 737. | 750. |
| | 28" | 36" | 3" | DP7SS()R2836 | 764. | 778. | 798. |
| | 28" | 42" | 3" | DP7SS()R2842 | 809. | 824. | 842. |
| | 28" | 48" | 3" | DP7SS()R2848 | 851. | 868. | 883. |
| | 28" | 54" | 3" | DP7SS()R2854 | 893. | 920. | 947. |
| | 28" | 60" | 3" | DP7SS()R2860 | 937. | 966. | 994. |
| | 28" | 66" | 3" | DP7SS()R2866 | 985. | 1,014. | 1,043. |
| | 28" | 72" | 3" | DP7SS()R2872 | 1,034. | 1,065. | 1,096. |
| | 28" | 78" | 3" | DP7SS()R2878 | 1,085. | 1,118. | 1,150. |
| | 28" | 84" | 3" | DP7SS()R2884 | 1,140. | 1,174. | 1,208. |
| 28" | 90" | 3" | DP7SS()R2890 | 1,197. | 1,233. | 1,269. | |
| 28" | 96" | 3" | DP7SS()R2896 | 1,256. | 1,294. | 1,331. | |

Panels, Build-To-Spec

Ordering Information

Rectangular Frame Stacking Screen:

1. Pattern number
2. Frame finish
3. Glass

Order Code

Rectangular Frame Stacking Screen:

Example: DP7SSGR1424/117

DP7SSGR Stack, Rectangular Frame, w/clear tempered glass

117 Raceway finish

Included with:

Rectangular Frame Stacking Screen:

- Attachment hardware

Note: Screens are only available in Knoll core finishes.

Options

NOTE: Stacking screens are compatible with DP7 Full View panels only.

Glass Options:

(G)= Clear Tempered Glass
(F) = Powder Glass

Frameless Add Up

Frameless add ups provide additional privacy between workstations, while creating a lighter and more transparent space. Combining frameless glass add ups with Dividends Horizon panels provides a clean, light aesthetic.

Frameless add ups are available in clear or powder glass. 7" and 14" heights are available, which is consistent with Dividends Horizon panel frame height increments.

Frameless add ups replace flat top caps on panels, bolting onto the panel frame. Add ups are not available in radius profile.

Frameless Glass Add Up Construction

Frameless glass add ups feature an extruded aluminum base and are available in any Knoll Core paint finish. Legacy finishes are not available.

Clear tempered or powder glass is ½" thick with polished edge.

Frameless Glass Add Up Dimensions

- Widths: 15, 18, 24, 30, 36, 42, 48, 54, 60, 66, and 72 inches
- Heights: 7 and 14 inches
- Thickness: 3 inches

Planning with Frameless Add Ups

Frameless add ups attach to the top of any height Dividends or Dividends Horizon topway or full view panel frame or stack frame, regardless of production date.

Frameless add ups replace the panel top cap and can span over one or more panels up to 72" wide.

Dividends Horizon frameless add ups are designed for use in same-height panel applications, and also support change of height applications involving a post connection.

Use shortened frameless add ups in change of height applications with DP5 end trims. Frameless add ups are not compatible with DP6 thin profile end trims.

End caps are specified for each end of a run of add ups. End caps must be specified separately and are available in packages of ten.

Frameless Add Up Alignment Clip

A clear polycarbonate alignment clip maintains alignment between frameless add up inserts. One alignment clip is included with every frameless add up. Alignment clips do not need to be specified separately.

14" High Frameless Add Up

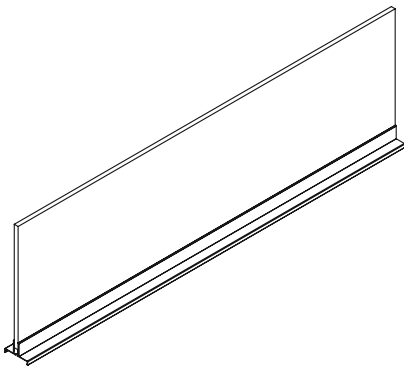

7" High Frameless Add Up

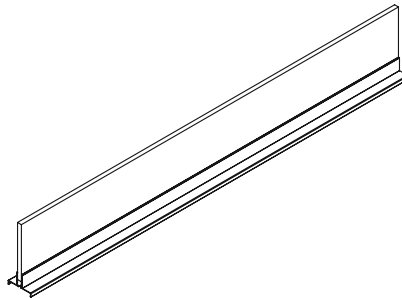

Frameless Add Up End Cap

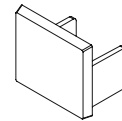

Frameless Add Up

Clear, Powder, Bronze and Grey Glass

Dividends Horizon

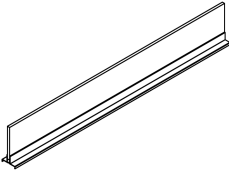
| description | w | d | h | pattern no. | list | Clear (TEMP) | Powder (GL13) Bronze (GL25) Grey (GL35) |
|--|-----|------|----|---------------|------|--------------|---|
| Frameless Add Up, 7" High  | 15" | 1/2" | 7" | DP1AU0715()G | | \$220. | \$236. |
| | 18" | 1/2" | 7" | DP1AU0718()G | | 245. | 265. |
| | 24" | 1/2" | 7" | DP1AU0724()G | | 269. | 296. |
| | 30" | 1/2" | 7" | DP1AU0730()G | | 293. | 326. |
| | 36" | 1/2" | 7" | DP1AU0736()G | | 332. | 370. |
| | 42" | 1/2" | 7" | DP1AU0742()G | | 370. | 415. |
| | 48" | 1/2" | 7" | DP1AU0748()G | | 409. | 459. |
| | 54" | 1/2" | 7" | DP1AU0754()G | | 444. | 501. |
| | 60" | 1/2" | 7" | DP1AU0760()G | | 480. | 542. |
| | 66" | 1/2" | 7" | DP1AU0766()G | | 515. | 584. |
| | 72" | 1/2" | 7" | DP1AU0772()G | | 550. | 627. |
| | 78" | 1/2" | 7" | DP1AU0778()G | | 595. | 677. |
| | 84" | 1/2" | 7" | DP1AU0784()G | | 642. | 731. |
| | 90" | 1/2" | 7" | DP1AU0790()G | | 693. | 790. |
| | 96" | 1/2" | 7" | DP1AU0796()G | | 749. | 854. |

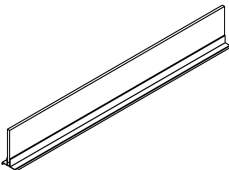
| description | w | d | h | pattern no. | list | Clear (TEMP) | Powder (GL13) Bronze (GL25) Grey (GL35) |
|---|-----|------|----|---------------|------|--------------|---|
| Shortened Frameless Add Up, 7" High  | 14" | 1/2" | 7" | DP1AU0714()G | | 220. | 236. |
| | 17" | 1/2" | 7" | DP1AU0717()G | | 245. | 265. |
| | 23" | 1/2" | 7" | DP1AU0723()G | | 269. | 296. |
| | 29" | 1/2" | 7" | DP1AU0729()G | | 293. | 326. |
| | 35" | 1/2" | 7" | DP1AU0735()G | | 332. | 370. |
| | 41" | 1/2" | 7" | DP1AU0741()G | | 370. | 415. |
| | 47" | 1/2" | 7" | DP1AU0747()G | | 409. | 459. |
| | 53" | 1/2" | 7" | DP1AU0753()G | | 444. | 501. |
| | 59" | 1/2" | 7" | DP1AU0759()G | | 480. | 542. |
| | 65" | 1/2" | 7" | DP1AU0765()G | | 515. | 584. |
| | 71" | 1/2" | 7" | DP1AU0771()G | | 550. | 627. |
| | 77" | 1/2" | 7" | DP1AU0777()G | | 595. | 677. |
| | 83" | 1/2" | 7" | DP1AU0783()G | | 642. | 731. |
| | 89" | 1/2" | 7" | DP1AU0789()G | | 693. | 790. |
| | 95" | 1/2" | 7" | DP1AU0795()G | | 749. | 854. |

Ordering Information

Frameless Add Up with Clear Glass

1. Pattern number
2. Frame finish
3. Glass finish

End Cap

1. Pattern number
2. Paint finish

Order Code

Frameless Add Up with Clear Glass

Example: **DP1AU0736VG**

DP1AU Frameless Add Up

07 7" High

36 36" Wide

V Full view

G Glass

117 Frame finish

TEMP Clear glass finish

Included with:

Frameless Add Up with Clear Glass

- Attachment hardware
- Topway Trough Spacer (Topway only)
- Alignment Clip

Options

Frame Options:
(V) = Full view
(C) = Topway

Glass Options:
(TEMP) = Clear
(GL13) = Powder
(GL25) = Bronze
(GL35) = Grey

Frameless Add Up

Clear, Powder, Bronze and Grey Glass

Dividends Horizon

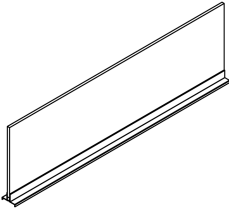
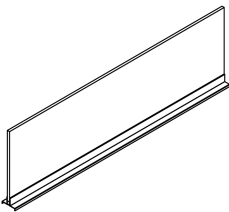
| description | w | d | h | pattern no. | list | Clear (TEMP) | Powder (GL13) Bronze (GL25) Grey (GL35) |
|---|------|------|----------------------|----------------------|--------|--------------|---|
|  Frameless Add Up, 14" High | 15" | 1/2" | 14" | DP1AU1415()G | | \$272. | \$303. |
| | 18" | 1/2" | 14" | DP1AU1418()G | | 315. | 357. |
| | 24" | 1/2" | 14" | DP1AU1424()G | | 358. | 409. |
| | 30" | 1/2" | 14" | DP1AU1430()G | | 399. | 462. |
| | 36" | 1/2" | 14" | DP1AU1436()G | | 458. | 532. |
| | 42" | 1/2" | 14" | DP1AU1442()G | | 515. | 603. |
| | 48" | 1/2" | 14" | DP1AU1448()G | | 576. | 675. |
| | 54" | 1/2" | 14" | DP1AU1454()G | | 632. | 743. |
| | 60" | 1/2" | 14" | DP1AU1460()G | | 687. | 813. |
| | 66" | 1/2" | 14" | DP1AU1466()G | | 744. | 881. |
| | 72" | 1/2" | 14" | DP1AU1472()G | | 801. | 951. |
| | 78" | 1/2" | 14" | DP1AU1478()G | | 865. | 1,026. |
| | 84" | 1/2" | 14" | DP1AU1484()G | | 935. | 1,109. |
| | 90" | 1/2" | 14" | DP1AU1490()G | | 1,010. | 1,198. |
| 96" | 1/2" | 14" | DP1AU1496()G | | 1,091. | 1,293. | |
|  Shortened Frameless Add Up, 14" High | 14" | 1/2" | 14" | DP1AU1414()G | | 272. | 303. |
| | 17" | 1/2" | 14" | DP1AU1417()G | | 315. | 357. |
| | 23" | 1/2" | 14" | DP1AU1423()G | | 358. | 409. |
| | 29" | 1/2" | 14" | DP1AU1429()G | | 399. | 462. |
| | 35" | 1/2" | 14" | DP1AU1435()G | | 458. | 532. |
| | 41" | 1/2" | 14" | DP1AU1441()G | | 515. | 603. |
| | 47" | 1/2" | 14" | DP1AU1447()G | | 576. | 675. |
| | 53" | 1/2" | 14" | DP1AU1453()G | | 632. | 743. |
| | 59" | 1/2" | 14" | DP1AU1459()G | | 687. | 813. |
| | 65" | 1/2" | 14" | DP1AU1465()G | | 744. | 881. |
| | 71" | 1/2" | 14" | DP1AU1471()G | | 801. | 951. |
| | 77" | 1/2" | 14" | DP1AU1477()G | | 865. | 1,026. |
| | 83" | 1/2" | 14" | DP1AU1483()G | | 935. | 1,109. |
| | 89" | 1/2" | 14" | DP1AU1489()G | | 1,010. | 1,198. |
| 95" | 1/2" | 14" | DP1AU1495()G | | 1,091. | 1,293. | |
| End Cap | | | | DP1AUECTP | 38. | | |



Ordering Information

Frameless Add Up with Clear Glass

1. Pattern number
2. Frame finish
3. Glass finish

End Cap

1. Pattern number
2. Paint finish

Order Code

Frameless Add Up with Clear Glass

Example: **DP1AU0736VG**

DP1AU Frameless Add Up

07 7" High

36 36" Wide

V Full view

G Glass

117 Frame finish

TEMP Clear glass finish

Included with:

Frameless Add Up with Clear Glass

- Attachment hardware
- Topway Trough Spacer (Topway only)
- Alignment Clip

Options

Frame Options:
(V) = Full view
(C) = Topway

Glass Options:
(TEMP) = Clear
(GL13) = Powder
(GL25) = Bronze
(GL35) = Grey

This page intentionally left blank

Dividends Horizon DP7 Post Assemblies

Post assemblies are required for all "L", "T", and "X" applications involving same-height panels. Included with post assemblies are the appropriate post, post cover, top cap and inside corner raceway filler.

Posts use the universal panel connection hardware, which is included with the post, for attachment.

For high-low and post-to-panel applications, posts and covers must be ordered separately by component.

Dividends Horizon Post and Trim Construction

Posts are 3" square extruded aluminum construction. Post covers are powder-coated 20 gauge steel.

Posts have cut-outs for electrical and data access that match the wire and cable channels provided by panel frames. This allows cables to be routed through the post at the topway and base raceway. Refer to the Beltway Electrical Specification page for cable routing information.

The illustrations that follow are common same-height post assembly configurations. Choose the post assembly that matches the required application.

Note: Worksurface height panels do not attach to any other panel height.

Post "L" Configuration

"L" post assembly includes:

- Universal post
- Two-way top cap
- Corner post cover
- Inside corner raceway filler

Post "T" Configuration

"T" post assembly includes:

- Universal post
- Three-way top cap
- Straight post cover
- Inside corner raceway filler

Post "X" Configuration

"X" post assembly includes:

- Universal post
- Four-way top cap
- Inside corner raceway filler

Post "X" Configuration

Trim options available:

- Radius
- Flat

Two-way Post Connection

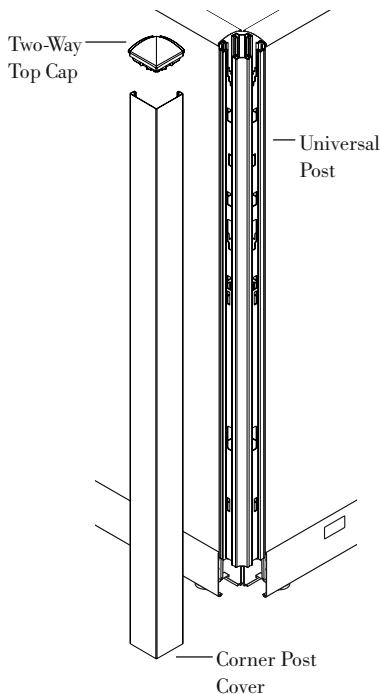

Post and Cover Plan Views

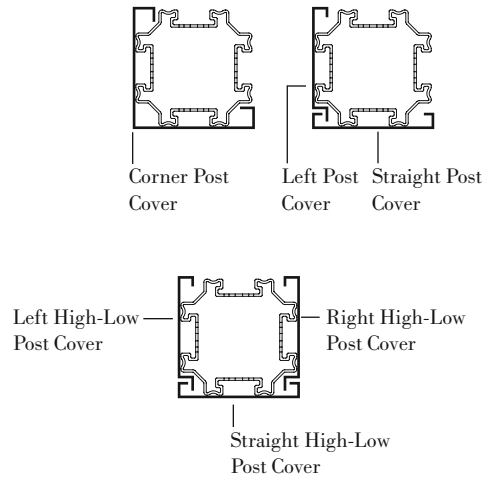

Post "L" Configuration

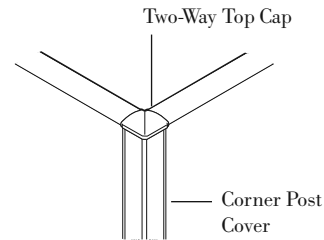

Post "T" Configuration

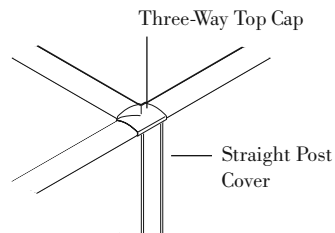

Post "X" Configuration

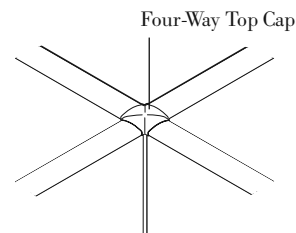



Dividends Horizon DP7 Post Assemblies

L, T and X Configurations

Dividends Horizon

| description | h | w | d | pattern no. | Metal P1 | Metal P2 | Metal P3 | Veneer |
|---|---------|----|----|-------------------|----------|----------|----------|--------|
| Dividends Horizon Two-Way Post Assembly ("L") | 28 1/2" | 3" | 3" | DP7PAWH2() | \$154. | \$163. | \$173. | \$493. |
|  | 36" | 3" | 3" | DP7PA362() | 154. | 163. | 173. | 495. |
| | 42" | 3" | 3" | DP7PA422() | 154. | 163. | 173. | 510. |
| | 50" | 3" | 3" | DP7PA502() | 168. | 178. | 185. | 556. |
| | 57" | 3" | 3" | DP7PA572() | 198. | 210. | 217. | 646. |
| | 64" | 3" | 3" | DP7PA642() | 198. | 210. | 217. | 671. |
| | 78" | 3" | 3" | DP7PA782() | 286. | 303. | 317. | 806. |

| | | | | | | | | |
|---|---------|----|----|-------------------|------|------|------|------|
| Dividends Horizon Three-Way Post Assembly ("T") | 28 1/2" | 3" | 3" | DP7PAWH3() | 161. | 171. | 178. | 468. |
|  | 36" | 3" | 3" | DP7PA363() | 161. | 171. | 178. | 498. |
| | 42" | 3" | 3" | DP7PA423() | 161. | 171. | 178. | 508. |
| | 50" | 3" | 3" | DP7PA503() | 173. | 180. | 188. | 531. |
| | 57" | 3" | 3" | DP7PA573() | 198. | 211. | 217. | 574. |
| | 64" | 3" | 3" | DP7PA643() | 198. | 211. | 217. | 627. |
| | 78" | 3" | 3" | DP7PA783() | 284. | 297. | 315. | 721. |

| | | | | | | | | |
|--|---------|----|----|-------------------|------|------|------|------|
| Dividends Horizon Four-Way Post Assembly ("X") | 28 1/2" | 3" | 3" | DP7PAWH4() | 149. | 156. | 164. | 274. |
|  | 36" | 3" | 3" | DP7PA364() | 149. | 156. | 164. | 278. |
| | 42" | 3" | 3" | DP7PA424() | 149. | 156. | 164. | 279. |
| | 50" | 3" | 3" | DP7PA504() | 156. | 167. | 176. | 291. |
| | 57" | 3" | 3" | DP7PA574() | 180. | 189. | 199. | 306. |
| | 64" | 3" | 3" | DP7PA644() | 180. | 189. | 199. | 317. |
| | 78" | 3" | 3" | DP7PA784() | 260. | 272. | 286. | 369. |

Post Connectors/End Trim

Ordering Information

Post Assemblies

1. Pattern Number
2. Finish

Order Code

Post Assemblies

Example: **DP7PA362,5,113**
 613 Silver Paint Finish

Included with:

Post Assemblies

- Post
- Post top cap
- Post cover
- Connecting hardware
- Base inside corner fillers

Options

Post Assemblies

- (4)** = Radius Metal
- (5)** = Flat Metal
- (V4)** = Radius Veneer
- (V5)** = Flat Veneer

Note: Plastic versions not available.

High-Low Post Components

High-Low panel-to-post configurations require ordering the post covers by components.

Shown are common high-low panel-to-post configurations. Choose the high-low panel-to-post configuration that matches the required application.

Posts use the universal panel connection hardware for attachment, which is included with the post.

NOTE: 28½"H panels do not attach to 36"H posts in a high-low application. Panel-to-panel high-low applications are not affected.

High-Low "L" Post Connector Configuration (see Figure 1)

High-Low "L" components required:

- 1 One, universal post that matches height of tallest panel DP7PO(64)
- 2 One, "one-way" post top cap DP7PT1(5)
- 3 One corner post covers that match height of tallest panel. DP7PC(64)2
- 4 One, high-low right hand post cover that matches high-low panel-to-post dimension. DP7PC(14)(R)H - Mirrored configuration would require left hand cover DP7PC(14)(L)H

High-Low "T" Post Connector Configuration A (see Figure 2)

High-Low "T" components required:

- 1 One, universal post that matches height of tallest panel DP7PO(64)
- 2 One, "two-way" top cap DP7PT2(5)
- 3 One, straight post cover that matches height of tallest panel DP7PC(64)
- 4 One, high-low right hand post cover that matches high-low panel-to-post dimension DP7PC(14)(R)H - Mirrored configuration would require a left hand cover DP7PC(14)(L)H

High-Low "T" Post Connector Configuration B (see Figure 3)

High-Low "T" components required:

- 1 One, universal post that matches height of tallest panel DP7PO(64)
- 2 One, "in-line" top cap DP7PTS(5)
- 3 One, straight post cover that matches height of tallest panel DP7PC(64)
- 4 One, high-low straight post cover that matches high-low panel-to-post dimension DP7PC(14)H

Hi-Low "T" Post Connector Configuration C (see Figure 4)

High-Low "T" components required:

- 1 One, universal post that matches height of tallest panel DP7PO(64)
- 2 One, "one-way" top cap DP7PT1(5)
- 3 One, straight post cover that matches height of tallest panel DP7PC(64)
- 4 Two, high-low right hand post covers that match high-low panel-to-post dimension DP7PC(14)(R)H - Mirrored configuration would require left hand covers DP7PC(14)(L)H

Figure 1

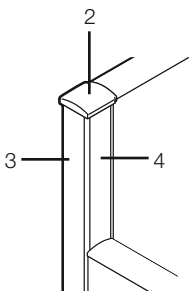

Figure 2

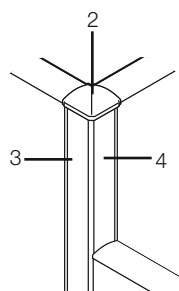

Figure 3

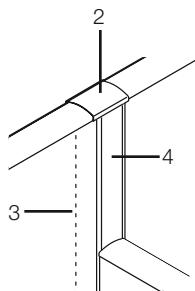
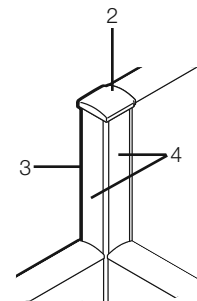

Figure 4



Post Top Caps



High-Low "X" Post Connector Configuration A (see Figure 5)

High-Low "X" components required (best method of various options):

- 1 One universal post that matches height of tallest panel DP7PO(64)
- 2 One, "one-way" top cap DP7PT1(5)
- 3 One, high-low straight post cover that matches high-low panel-to-post dimensions DP7PC(14)H
- 4 Two, high-low right hand post covers that match high-low panel-to-post dimensions DP7PC(14)(R)H - Mirrored configuration would require left hand covers DP7PC(14)(L)H

High-Low "X" Post Connector Configuration B (see Figure 6)

High-Low "X" components required:

- 1 One, universal post that matches height of tallest panel DP7PO(64)
- 2 One, "in-line" top cap DP7PTS(5)
- 3 Two, high-low straight post covers that match high-low panel-to-post dimensions DP7PC(14)H

High-Low "X" Post Connector Configuration C (see Figure 7)

High-Low "X" components required:

- 1 One, universal post that matches height of tallest panel DP7PO(64)
- 2 One, "two-way" top cap DP7PT2(5)
- 3 One, high-low straight post cover that matches high-low panel-to-post dimension. DP7PC(14)H
- 4 One, high-low right hand post cover that matches high-low panel-to-post dimension. DP7PC(14)(R)H - Mirrored configuration would require left hand cover DP7PC(14)(L)H

High-Low "X" Post Connector Configuration D (see Figure 8)

High-Low "X" components required:

- 1 One, universal post that matches height of tallest panel DP7PO(64)
- 2 One, "three-way" top cap DP7PT3(5)
- 3 One, high-low straight post cover that matches high-low panel-to-post dimension DP7PC(14)H

Figure 5

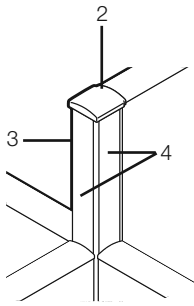

Figure 6

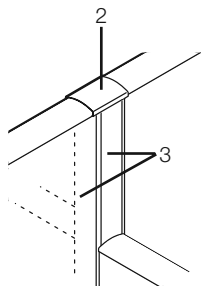

Figure 7

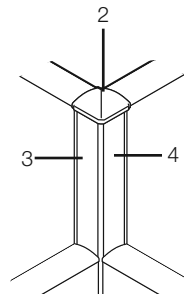
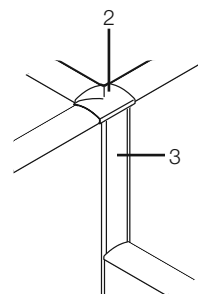
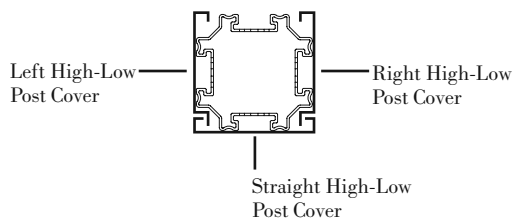

Figure 8



Post Plan View



Dividends Horizon DP7 Post Components

Dividends Horizon

Post, Stack Panel Post, Post Top Caps and Inside Corner Raceway Filler

| description | type | h | w | d | pattern no. | list price | P1 | P2 | P3 | Veneer |
|---|------------------------------|------------------------------------|----|----|------------------|--------------|-----|-----|------|--------|
| <div style="display: flex; align-items: center;"> <div> Dividends Horizon Universal Post </div> </div> | | 28 ¹ / ₂ " | 3" | 3" | DP7POWH | \$82. | | | | |
| | | 36" | 3" | 3" | DP7PO36 | 82. | | | | |
| | | 42" | 3" | 3" | DP7PO42 | 82. | | | | |
| | | 42" | 3" | 3" | DP7PO50 | 96. | | | | |
| | | 57" | 3" | 3" | DP7PO57 | 114. | | | | |
| | | 64" | 3" | 3" | DP7PO64 | 114. | | | | |
| | | 78" | 3" | 3" | DP7PO78 | 196. | | | | |
| 14" High Dividends Horizon Stack Panel Post | | 14 ⁵ / ₈ " | 3" | 3" | DP7SPO14 | 85. | | | | |
| 21" High Dividends Horizon Stack Panel Post | | 21 ¹⁵ / ₁₆ " | 3" | 3" | DP7SPO21 | 86. | | | | |
| 28" High Dividends Horizon Stack Panel Post | | 29 ¹ / ₄ " | 3" | 3" | DP7SPO28 | 99. | | | | |
| Worksurface Height Panel Change of Height Kit | | | | | DP7HLCWH | | 32. | 35. | 36. | |
| <div style="display: flex; align-items: center;"> <div style="margin-right: 10px;"> Four-way </div> <div style="margin-right: 10px;"> In-line </div> </div> <div style="display: flex; align-items: center; margin-top: 5px;"> <div style="margin-right: 10px;"> One-way </div> <div style="margin-right: 10px;"> Two-way </div> </div> <div style="display: flex; align-items: center; margin-top: 5px;"> <div style="margin-right: 10px;"> Three-way </div> </div> | Four-Way | 1/2" | 3" | 3" | DP7PT4() | 8. | 9. | 9. | 108. | |
| | In-line Straght | 1/2" | 3" | 3" | DP7PTS() | 8. | 9. | 9. | 104. | |
| | One-Way | 1/2" | 3" | 3" | DP7PT1() | 8. | 9. | 9. | 94. | |
| | Three-Way | 1/2" | 3" | 3" | DP7PT3() | 8. | 9. | 9. | 105. | |
| | Two-Way | 1/2" | 3" | 3" | DP7PT2() | 8. | 9. | 9. | 106. | |
| | Inside Corner Raceway Filler | | | | | DP7BF | 10. | | | |

Ordering Information

Post Top Cap

1. Pattern number
2. Finish

Order Code

Post Top Caps

Example: **DP7PT45**
 613 Silver Paint Finish

Included with:

Options

Post Top Caps Options



- (4)** = Radius Metal
- (5)** = Flat Metal
- (V4)** = Radius Veneer
- (V5)** = Flat Veneer

An inside corner raceway filler is used to block the light leak created when two raceway covers meet at a 90° connection.

Dividends Horizon DP7 Post Components

Post Covers and High Low Post Covers

Dividends Horizon

| description | h | pattern no. | Metal P1 | Metal P2 | Metal P3 | Veneer |
|---|---------------|--------------------|----------|----------|----------|--------|
| Dividends Horizon Post Covers Full Height "T"  | 28 1/2" + 14" | DP7PCWHS14 | \$109. | \$122. | \$127. | n/a |
| | 28 1/2" + 21" | DP7PCWHS21 | 121. | 134. | 139. | n/a |
| | 28 1/2" + 28" | DP7PCWHS28 | 128. | 140. | 146. | n/a |
| | 28 1/2" | DP7PCWH | 48. | 51. | 66. | 190. |
| | 42" | DP7PC42 | 48. | 51. | 66. | 226. |
| | 50" | DP7PC50 | 49. | 54. | 58. | 236. |
| | 57" | DP7PC57 | 57. | 59. | 62. | 264. |
| | 64" | DP7PC64 | 57. | 59. | 62. | 306. |
| | 78" | DP7PC78 | 62. | 69. | 71. | 347. |
| Dividends Horizon Post Covers Full Height "L"  | 28 1/2" + 14" | DP7PCWHS142 | 115. | 127. | 132. | n/a |
| | 28 1/2" + 21" | DP7PCWHS212 | 123. | 136. | 141. | n/a |
| | 28 1/2" + 28" | DP7PCWHS282 | 130. | 141. | 147. | n/a |
| | 28 1/2" | DP7PCWH2 | 74. | 77. | 80. | 261. |
| | 36" | DP7PC362 | 74. | 77. | 80. | 260. |
| | 42" | DP7PC422 | 74. | 77. | 80. | 274. |
| | 50" | DP7PC502 | 77. | 81. | 85. | 308. |
| | 57" | DP7PC572 | 83. | 88. | 97. | 383. |
| | 64" | DP7PC642 | 83. | 88. | 97. | 396. |
| Dividends Horizon High Low Post Covers  | 28 1/2" - 42" | DP7PCWH42() | 95. | 103. | 107. | n/a |
| | 28 1/2" - 50" | DP7PCWH50() | 107. | 120. | 124. | n/a |
| | 28 1/2" - 57" | DP7PCWH57() | 108. | 121. | 126. | n/a |
| | 28 1/2" - 64" | DP7PCWH64() | 109. | 122. | 127. | n/a |
| | 28 1/2" - 78" | DP7PCWH78() | 114. | 126. | 131. | n/a |
| | 36" - 42" | DP7PC07() | 9. | 11. | 11. | 148. |
| | 36" - 50" | DP7PC14() | 16. | 22. | 24. | 168. |
| | 36" - 57" | DP7PC21() | 25. | 26. | 27. | 182. |
| | 36" - 64" | DP7PC28() | 38. | 42. | 43. | 200. |
| | 36" - 78" | DP7PC42() | 58. | 61. | 63. | 260. |
| | 42" - 50" | DP7PC07() | 9. | 11. | 11. | 148. |
| | 42" - 57" | DP7PC14() | 16. | 22. | 24. | 168. |
| | 42" - 64" | DP7PC21() | 25. | 26. | 27. | 182. |
| | 42" - 78" | DP7PC36() | 51. | 57. | 59. | 238. |
| | 50" - 57" | DP7PC07() | 9. | 11. | 11. | 148. |
| | 50" - 64" | DP7PC14() | 16. | 22. | 24. | 168. |
| | 50" - 78" | DP7PC28() | 38. | 42. | 43. | 200. |
| | 57" - 64" | DP7PC07() | 9. | 11. | 11. | 148. |
| | 57" - 78" | DP7PC21() | 25. | 26. | 27. | 182. |

Post Connectors/End Trim

Ordering Information

Post Covers

1. Pattern number
2. Finish

Order Code

Post Top Caps

Example: **DP7PT45**

613 Silver Paint Finish

Included with:

Options

Post Covers

Add a "V" suffix to the base pattern number for a veneer finish.

High Low Post Covers Options

(H) = Straight Condition
(RH) = Right Hand Condition
(LH) = Left Hand Condition

Dividends Horizon DP7 Post Components

Post Covers and High Low Post Covers

Dividends Horizon

| description | h | pattern no. | Metal P1 | Metal P2 | Metal P3 | Veneer |
|---|-----------|-------------------|-------------|-------------|-------------|--------|
| Dividends Horizon High Low Post Covers | 64" - 78" | DP7PC14() | \$16. | \$22. | \$24. | \$168. |
|  | | | | | | |
| Dividends Horizon Post Covers Full Height | 28 1/2" | DP7PCWHU | 121. | 134. | 139. | 246. |
| Double Underlap | 36" | DP7PC36U | 127. | 139. | 145. | 266. |
| | 42" | DP7PC42U | 131. | 142. | 148. | 290. |
| | 50" | DP7PC50U | 144. | 157. | 166. | 330. |
| | 57" | DP7PC57U | 145. | 159. | 167. | 357. |
| | 64" | DP7PC64U | 157. | 175. | 181. | 397. |
| | 78" | DP7PC78U | 217. | 238. | 248. | 506. |
| Dividends Horizon High Low Post Covers Double Underlap | 36"-42" | DP7PC07UH | 95. | 103. | 107. | 187. |
| | 36"-50" | DP7PC14UH | 99. | 108. | 114. | 201. |
| | 36"-57" | DP7PC21UH | 98. | 107. | 111. | 194. |
| | 36"-64" | DP7PC28UH | 105. | 116. | 121. | 212. |
| | 42"-50" | DP7PC07UH | 95. | 103. | 107. | 187. |
| | 42"-57" | DP7PC14UH | 99. | 108. | 114. | 201. |
| | 42"-64" | DP7PC28UH | 105. | 116. | 121. | 212. |
| | 42"-78" | DP7PC36UH | 115. | 127. | 132. | 266. |
| | 50"-57" | DP7PC07UH | 95. | 103. | 107. | 187. |
| | 50"-64" | DP7PC14UH | 99. | 108. | 114. | 201. |
| | 50"-78" | DP7PC28UH | 105. | 116. | 121. | 212. |
| | 57"-64" | DP7PC07UH | 95. | 103. | 107. | 187. |
| | 57"-78" | DP7PC21UH | 98. | 107. | 111. | 194. |
| | 64"-78" | DP7PC14UH | 99. | 108. | 114. | 201. |

Ordering Information

Post Covers

1. Pattern number
2. Finish

Order Code

Post Top Caps

Example: **DP7PT45**
613 Silver Paint Finish

Included with:

Options

Post Covers

Add a "V" suffix to the base pattern number for a veneer finish.

High Low Post Covers Options

(H) = Straight Condition
(RH) = Right Hand Condition
(LH) = Left Hand Condition

This page intentionally left blank

Legacy Post Assemblies

Post assemblies are required for all "L", "T", and "X" applications involving same-height panels. Included with post assemblies are the appropriate post, post cover and top cap.

Post connectors use the universal panel connection hardware for attachment, which is included with the post.

For high-low and post-to-panel applications, posts and covers must be ordered separately by component.

NOTE: LEGACY POSTS ARE FOR EXISTING CUSTOMERS ONLY.

Legacy Post and Trim Construction

Posts are 3" square extruded aluminum construction. Post covers are flat or radius profile, metal or smooth textured plastic extrusion with softly-radiused molded plastic top cap. Metal post covers are powder-coated 20 ga. steel.

Posts have cut-outs for electrical and data access that match the wire and cable channels provided by panel frames. This allows cables to be routed through the post at the topway and base raceway. Refer to the Beltway Electrical Specification page for cable routing information.

The illustrations that follow are common same-height post assembly configurations. Choose the post assembly that matches the required application.

Post "L" Configuration

"L" assembly includes:

- Universal post
- Two-way top cap
- Corner post cover

Post "L" Configuration

"L" post assembly includes:

- Universal post
- Two-way top cap
- Corner post cover

Post "T" Configuration

"T" post assembly includes:

- Universal post
- Three-way top cap
- Straight post cover

Trim options available:

- Smooth Radius Plastic
- Radius Metal
- Flat Metal

Note: Not available with fabric covered post covers.

Through-Post Access for Power and Data

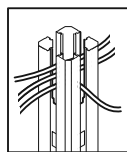

Topway Cable Access

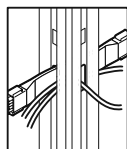

Beltway Power and Cable

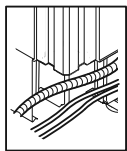

Base Raceway Power and Cable

Two-Way Post Connection

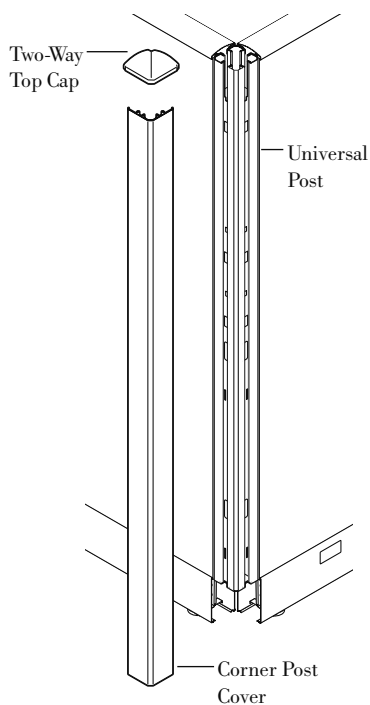

Post Top Cap for Enhanced Smooth Trim

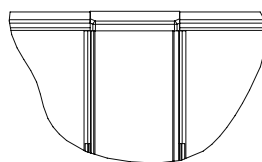

Post and Cover Top Views

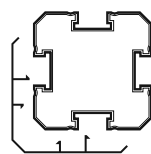

Corner Post Cover

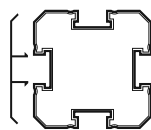

Straight Post Cover

Post "L" Configurations

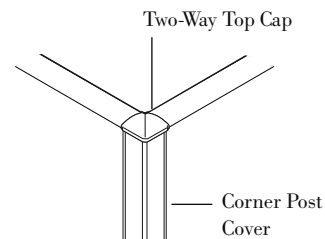

Post "T" Configurations

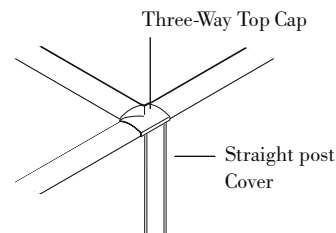

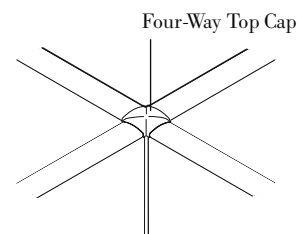

Post "X" Configurations



Legacy Post Assemblies

L, T and X Configurations

Dividends Horizon

| description | h * | w | d | pattern no. | Plastic list | Metal P1 | Metal P2 | Metal P3 |
|---|-----|----|----|-------------------|--------------|----------|----------|----------|
|  Two-Way Post Assembly ("L") | 36" | 3" | 3" | DP()PA362 | \$131. | \$167. | \$176. | \$186. |
| | 42" | 3" | 3" | DP()PA422 | 131. | 167. | 176. | 186. |
| | 50" | 3" | 3" | DP()PA502 | 147. | 181. | 190. | 199. |
| | 57" | 3" | 3" | DP()PA572 | 180. | 214. | 224. | 234. |
| | 64" | 3" | 3" | DP()PA642 | 180. | 214. | 224. | 234. |
| | 78" | 3" | 3" | DP()PA782 | 288. | 308. | 327. | 341. |
|  Three-Way Post Assembly ("T") | 36" | 3" | 3" | DP()PA363 | 120. | 174. | 183. | 190. |
| | 42" | 3" | 3" | DP()PA423 | 120. | 174. | 183. | 190. |
| | 50" | 3" | 3" | DP()PA503 | 133. | 186. | 192. | 204. |
| | 57" | 3" | 3" | DP()PA573 | 163. | 214. | 224. | 234. |
| | 64" | 3" | 3" | DP()PA643 | 163. | 214. | 224. | 234. |
| | 78" | 3" | 3" | DP()PA783 | 266. | 306. | 321. | 338. |
|  Four-Way Post Assembly ("X") | 36" | 3" | 3" | DP()PA364 | 106. | 161. | 170. | 178. |
| | 42" | 3" | 3" | DP()PA424 | 106. | 161. | 170. | 178. |
| | 50" | 3" | 3" | DP()PA504 | 118. | 170. | 180. | 188. |
| | 57" | 3" | 3" | DP()PA574 | 142. | 192. | 205. | 215. |
| | 64" | 3" | 3" | DP()PA644 | 142. | 192. | 205. | 215. |
| | 78" | 3" | 3" | DP()PA784 | 238. | 281. | 293. | 308. |

Post Connectors/End Trim

h = nominal height

Ordering Information

Post Assemblies

1. Pattern Number
2. Trim Finish

Order Code

Post Assemblies

Example: **DP(2A)PA 642, 113**
DP(2A)PA Pattern Number
642
113 Dark grey trim finish

Included with:

Post Assemblies

- Post assemblies
- Post top cap
- Post cover
- Connecting hardware

Options

Post Assemblies

Post Assembly Trim Options
(2A) = Plastic, Enhanced Smooth Radius
(4) = Metal, Radius
(5) = Metal, Flat

High-Low Post Components

High-Low panel-to-post configurations require ordering the post covers by components.

Shown are common high-low panel-to-post configurations. Choose the high-low panel-to-post configuration that matches the required application.

Post connectors use the universal panel connection hardware for attachment, which is included with the post.

Universal Post and High-Low Trim Construction

- Posts: 3" square extruded aluminum.
- Post covers: Flat-profile, plastic extrusion with a smooth finish
- Top cap: Softly-radiused injection molded plastic

High-Low "L" Post Connector Configuration (see Figure 1)

High-Low "L" components required:

- 1 One, universal post that matches height of tallest panel
- 2 One, "one-way" post top cap

- 3 Two straight post covers that match height of tallest panel

- 4 One, high-low straight post cover that matches high-low panel-to-post dimension

High-Low "T" Post Connector Configuration A (see Figure 2)

High-Low "T" components required:

- 1 One, universal post that matches height of tallest panel
- 2 One, "two-way" top cap
- 3 One, straight post cover that matches height of tallest panel
- 4 One, high-low straight post cover that matches high-low panel-to-post dimension

High-Low "T" Post Connector Configuration B (see Figure 3)

High-Low "T" components required:

- 1 One, universal post that matches height of tallest panel
- 2 One, "in-line" top cap
- 3 One, straight post cover that matches height of tallest panel

- 4 One, high-low straight post cover that matches high-low panel-to-post dimension

Hi-Lo "T" Post Connector Configuration C (see Figure 4)

High-Low "T" components required:

- 1 One, universal post that matches height of tallest panel
- 2 One, "one-way" top cap
- 3 One, straight post cover that matches height of tallest panel
- 4 Two, high-low straight post covers that match high-low panel-to-post dimensions

High-Low "X" Post Connector Configuration A (see Figure 5)

High-Low "X" components required:

- 1 One universal post that matches height of tallest panel
- 2 One, "one-way" top cap
- 3 Three, high-low straight post covers that match high-low panel-to-post dimensions

High-Low "X" Post Connector Configuration B (see Figure 6)

High-Low "X" components required:

- 1 One, universal post that matches height of tallest panel
- 2 One, "in-line" top cap
- 3 Two, high-low straight post covers that match high-low panel-to-post dimensions

High-Low "X" Post Connector Configuration C (see Figure 7)

High-Low "X" components required:

- 1 One, universal post that matches height of tallest panel
- 2 One, "two-way" top cap
- 3 Two, high-low straight post covers that match high-low panel-to-post dimensions

High-Low "X" Post Connector Configuration D (see Figure 8)

High-Low "X" components required:

- 1 One, universal post that matches height of tallest panel
- 2 One, "three-way" top cap
- 3 One, high-low straight post cover that matches high-low panel to-post dimension

Figure 1

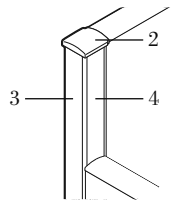

Figure 2

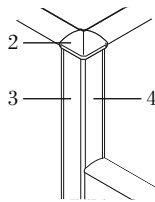

Figure 3

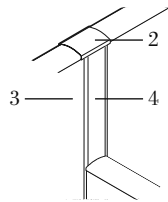

Figure 4

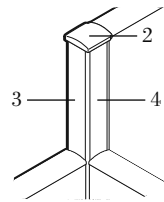

Figure 5

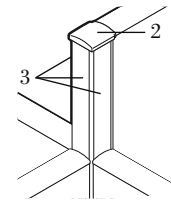

Figure 6

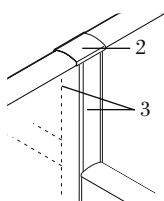

Figure 7

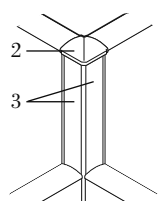
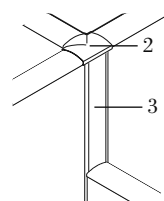

Figure 8







Post Top Caps

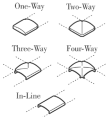

Legacy Post Components

Post, Post Top Caps and Post Covers

Dividends Horizon



| description | type | h | w | d | pattern no. | Price list | Metal P1 | Metal P2 | Metal P3 |
|--|--------------------|------|----|----|-------------|------------|----------|----------|----------|
|  Universal Post (Post Only) | | 36" | 3" | 3" | DP2APO36 | \$99. | | | |
| | | 42" | 3" | 3" | DP2APO42 | 99. | | | |
| | | 50" | 3" | 3" | DP2APO50 | 112. | | | |
| | | 57" | 3" | 3" | DP2APO57 | 135. | | | |
| | | 64" | 3" | 3" | DP2APO64 | 135. | | | |
| | | 78" | 3" | 3" | DP2APO78 | 233. | | | |
|  Post Top Caps | One-Way | 1/2" | 3" | 3" | DP()PT1 | 5. | 10. | 11. | 11. |
| | Two-Way | 1/2" | 3" | 3" | DP()PT2 | 5. | 10. | 11. | 11. |
| | Three-Way | 1/2" | 3" | 3" | DP()PT3 | 5. | 10. | 11. | 11. |
| | Four-Way | 1/2" | 3" | 3" | DP()PT4 | 5. | 10. | 11. | 11. |
| | In-Line (Straight) | 1/2" | 3" | 3" | DP()PTS | 5. | 10. | 11. | 11. |
|  Post Covers (Straight) | | 36" | | | DP()PC36SF | 11. | 52. | 57. | 63. |
| | | 42" | | | DP()PC42S | 11. | 52. | 57. | 63. |
| | | 50" | | | DP()PC50S | 12. | 54. | 60. | 64. |
| | | 57" | | | DP()PC57S | 21. | 63. | 66. | 68. |
| | | 64" | | | DP()PC64S | 21. | 63. | 66. | 68. |
| | | 78" | | | DP()PC78S | 30. | 68. | 72. | 74. |
|  Post Covers (Corner) | | 36" | | | DP()PC36L | 28. | 79. | 82. | 85. |
| | | 42" | | | DP()PC42L | 28. | 79. | 82. | 85. |
| | | 50" | | | DP()PC50L | 31. | 82. | 86. | 95. |
| | | 57" | | | DP()PC57L | 37. | 90. | 98. | 104. |
| | | 64" | | | DP()PC64L | 37. | 90. | 98. | 104. |
| | | 78" | | | DP()PC78L | 48. | 104. | 108. | 112. |
|  Post Covers (Straight) High-Low Connection | 36" - 42" | 8" | | | DP()PC08S | 4. | 11. | 14. | 14. |
| | 42" - 50" | 8" | | | DP()PC08S | 4. | 11. | 14. | 14. |
| | 36" - 50" | 14" | | | DP()PC14S | 5. | 17. | 24. | 25. |
| | 64" - 78" | 14" | | | DP()PC14S | 5. | 17. | 24. | 25. |
| | 50" - 64" | 14" | | | DP()PC14S | 5. | 17. | 24. | 25. |
| | 42" - 64" | 22" | | | DP()PC22S | 6. | 27. | 28. | 29. |
| | 50" - 78" | 28" | | | DP()PC28S | 12. | 43. | 45. | 46. |
| | 36" - 64" | 28" | | | DP()PC28S | 12. | 43. | 45. | 46. |
| | 42" - 78" | 36" | | | DP()PC36S | 21. | 57. | 63. | 66. |
| | 36" - 78" | 42" | | | DP()PC42SH | 27. | 64. | 67. | 69. |

Post Connectors/End Trim

| Ordering Information | Order Code | Included with: | Options |
|--|--|--|--|
| Universal Post 1. Pattern Number | Universal Post <i>Example:</i> DP2A P050 DP2A Pattern Number P050 | Universal Post Connecting hardware | Universal Post Panel Top Cap and Post Cover Options: (2A)= Plastic, Enhanced Smooth Radius (4) = Metal, Radius (5) = Metal, Flat |
| Post Top Cap 1. Pattern Number 2. Trim finish | Post Top Cap <i>Example:</i> DP2A PT4, V04 DP2A PT4 Pattern Number 117 Soft grey | Panel Top Cap Post Covers | |
| Post Covers 1. Pattern Number 2. Trim finish | Post Covers <i>Example:</i> DP2A PC50S, 117 DP(2A) Pattern Number PC50S 117 Soft grey | | |

Legacy Post Components

Stack Panel Posts

| description | h | w | d | pattern no. | List Price |
|---|------------------------------------|----|----|-------------------|------------|
| 14" High Stack Panel Posts | 14 ⁵ / ₈ " | 3" | 3" | DP2ASPO 14 | \$95. |
|  | | | | | |
| 21" High Stack Panel Posts | 21 ¹⁵ / ₁₆ " | 3" | 3" | DP2ASPO 21 | 96. |
|  | | | | | |
| 28" High Stack Panel Posts | 29 ¹ / ₄ " | 3" | 3" | DP2ASPO 28 | 106. |
|  | | | | | |

| Ordering Information | Order Code | Included with: | Options |
|--------------------------|---|--------------------------|-------------------------|
| Stack Panel Frame | Stack Panel Frame | Stack Panel Frame | Stack Panel Post |
| 1. Pattern Number | <i>Example:</i> DP2STF 1448, 113 | Stack Panel Post | |
| 2. Trim Finish | DP1STF Pattern Number | | |
| Stack Panel Post | 1448 | | |
| 1. Pattern Number | 113 Dark grey paint finish | | |
| | Stack Panel Post | | |
| | <i>Example:</i> DP2ASPO 14 | | |
| | DP2ASPO Pattern Number | | |
| | 14 | | |

This page intentionally left blank

Panel End Trim

Panel end trim in one of three trim types ends a panel run.

Trim options available:

- Smooth Radius Plastic
- Metal Radius
- Metal Flat

Metal trim is constructed of extruded aluminum, powder coated.

End trim includes the appropriate attachment hardware and the panel end cap for transition to panel top cap.

Thin Profile Panel End Trim

The thin profile panel end trim is an extruded aluminum end cover that is designed to attach to panel ends to provide a smooth end condition for the end of panel runs. The thin profile end trim and high low end trims are constructed of extruded aluminum with a powder coated finish. Thin profile panel end trim may only be used with panels that have been selected with the number 5 (flat metal) trim option.

High-Low Panel-to-Panel End Trim

High-low panel-to-panel end trim is used to complete straight, high-low panel-to-panel connections.

Construction and attachment is identical to panel end trim and includes attachment hardware and top/bottom end caps.

Up to ten, category 5 cables can be laid-in to carry data from the upper panel topway to the lower panel topway.

High-Low Thin Profile End Trim

High-low panel to panel end trim is used to complete straight, high-low panel to panel connections. Construction and attachment is identical to the thin profile panel end trim and includes attachment hardware. High-low thin profile end trim may only be used with panels that have been selected with the number 5 (flat metal) trim option.

Note: When using the high-low thin profile end trim, the higher and lower panels continue to use the standard full-width top cap.

Panel Top Caps

Smooth plastic and metal panel top caps are available in all panel widths.

Construction: Plastic top caps are constructed of injection molded colored plastic. Metal caps are powder coated steel.

Top caps with retainer clips must be ordered when using top caps on full view panels.

Shortened High-Low Panel Top Caps

When specifying the enhanced smooth or metal panel trim for a high-low panel end trim condition, the top cap on the lower panel must be shortened by 1 inch. Panel top caps can be field cut to the new length, or shortened top caps may be ordered separately.

Note: Thin profile end trim and high low end trim are available in Knoll core finishes only.

Panel End Trim

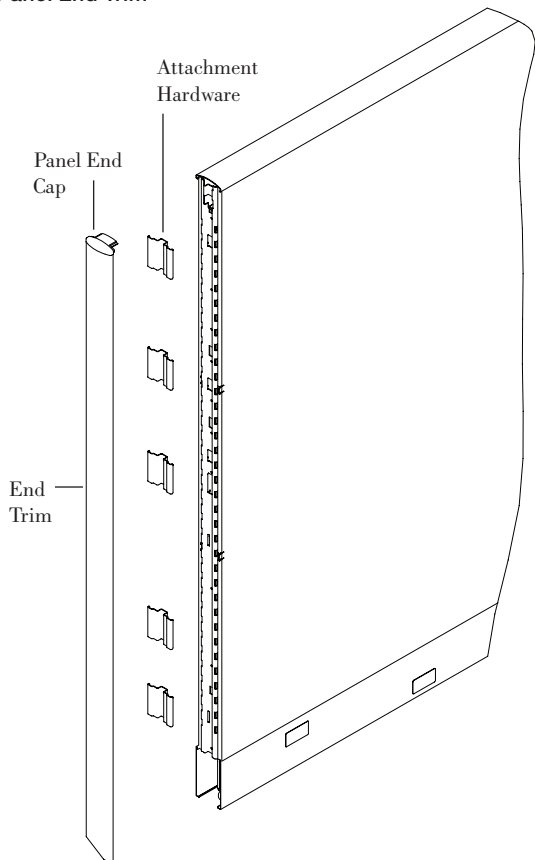

Enhanced High-Low Panel End Trim

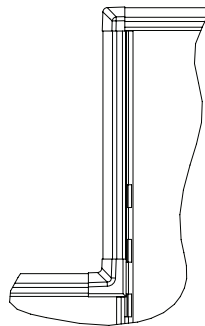

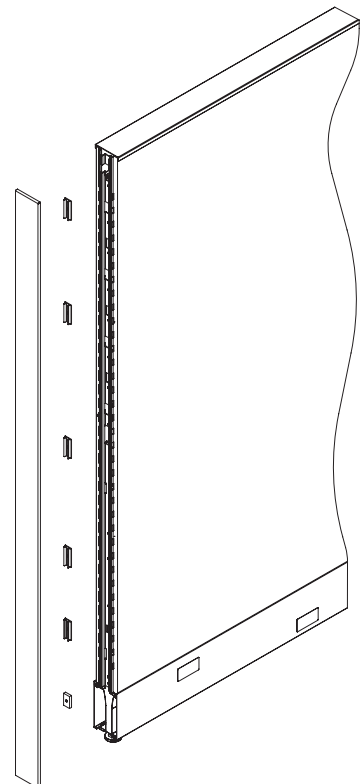

Thin Profile End Trim



Panel End Trim and Panel Top Caps

Panel End and High-Low Panel End

Dividends Horizon



| description | type | h * | w | d | pattern no. | Plastic | Metal P1 | Metal P2 | Metal P3 | Veneer |
|--|---------------|---------|------|-----------|--------------|---------|----------|----------|----------|--------|
|  Panel End | 28 1/2" | 28 1/2" | 3" | 5/8" | DP()PEWH | \$22. | \$63. | \$70. | \$72. | \$219. |
| | 28 1/2" + 14" | 42 1/2" | 3" | 5/8" | DP()PEWHS14 | 0. | 72. | 78. | 81. | n/a |
| | 28 1/2" + 21" | 49 1/2" | 3" | 5/8" | DP()PEWHS21 | 0. | 75. | 82. | 85. | n/a |
| | 28 1/2" + 28" | 56 1/2" | 3" | 5/8" | DP()PEWHS28 | 0. | 77. | 84. | 87. | n/a |
| | 36" | 36" | 3" | 5/8" | DP()PE36F | 22. | 63. | 70. | 72. | 230. |
| | 42" | 42" | 3" | 5/8" | DP()PE42 | 24. | 66. | 71. | 73. | 246. |
| | 50" | 50" | 3" | 5/8" | DP()PE50 | 25. | 69. | 72. | 74. | 277. |
| | 57" | 57" | 3" | 5/8" | DP()PE57 | 27. | 71. | 74. | 76. | 309. |
| | 64" | 64" | 3" | 5/8" | DP()PE64 | 27. | 71. | 74. | 76. | 334. |
| | 78" | 78" | 3" | 5/8" | DP()PE78 | 32. | 76. | 80. | 83. | 365. |
|  Panel End, High-Low | 28 1/2" - 36" | 7 1/2" | 3" | 3/8" | DP()PEWH36 | 0. | 52. | 59. | 61. | n/a |
| | 28 1/2" - 42" | 13 1/2" | 3" | 3/8" | DP()PEWH42 | 0. | 57. | 62. | 64. | n/a |
| | 28 1/2" - 50" | 21 1/2" | 3" | 3/8" | DP()PEWH50 | 0. | 60. | 66. | 69. | n/a |
| | 28 1/2" - 57" | 28 1/2" | 3" | 3/8" | DP()PEWH57 | 0. | 63. | 71. | 73. | n/a |
| | 28 1/2" - 64" | 35 1/2" | 3" | 3/8" | DP()PEWH64 | 0. | 66. | 73. | 76. | n/a |
| | 28 1/2" - 78" | 49 1/2" | 3" | 3/8" | DP()PEWH78 | 0. | 73. | 79. | 82. | n/a |
| | 36" - 42" | 6" | 3" | 3/8" | DP()PE08 | 7. | 38. | 42. | 43. | 171. |
| | 36" - 50" | 14" | 3" | 3/8" | DP()PE14 | 9. | 42. | 44. | 45. | 196. |
| | 36" - 57" | 21" | 3" | 3/8" | DP()PE22 | 14. | 44. | 47. | 49. | 209. |
| | 36" - 64" | 28" | 3" | 3/8" | DP()PE28 | 27. | 54. | 58. | 61. | 217. |
| | 36" - 78" | 42" | 3" | 3/8" | DP()PE42H | 34. | 66. | 71. | 73. | 251. |
| | 42" - 50" | 8" | 3" | 3/8" | DP()PE08 | 7. | 38. | 42. | 43. | 171. |
| | 42" - 57" | 15" | 3" | 3/8" | DP()PE14 | 9. | 42. | 44. | 45. | 196. |
| | 42" - 64" | 22" | 3" | 3/8" | DP()PE22 | 14. | 44. | 47. | 49. | 209. |
| | 42" - 78" | 36" | 3" | 3/8" | DP()PE36 | 33. | 63. | 70. | 72. | 233. |
| | 50" - 57" | 7" | 3" | 3/8" | DP()PE08 | 7. | 38. | 42. | 43. | 171. |
| | 50" - 64" | 14" | 3" | 3/8" | DP()PE14 | 9. | 42. | 44. | 45. | 196. |
| | 50" - 78" | 28" | 3" | 3/8" | DP()PE28 | 27. | 54. | 58. | 61. | 217. |
| | 57" - 64" | 7" | 3" | 3/8" | DP()PE08 | 7. | 38. | 42. | 43. | 171. |
| | 57" - 78" | 21" | 3" | 3/8" | DP()PE22 | 14. | 44. | 47. | 49. | 209. |
| 64" - 78" | 14" | 3" | 3/8" | DP()PE14 | 9. | 42. | 44. | 45. | 196. | |

Post Connectors/End Trim

h* = Nominal height
 Dimensions listed under h w d are actual to the nearest 1/16"

| Ordering Information | Order Code | Included with: | Options |
|--|--|---|---|
| Panel End 1. Pattern Number 2. Trim Finish | Panel End <i>Example:</i> DP2A PE42, 117 DP2A Pattern Number PE42 117 Soft grey | Panel End <ul style="list-style-type: none"> Panel end cover Connecting hardware | Panel End, High-Low Panel End and Top Caps Trim options (2A) = Enhanced Smooth Radius Plastic (4) = Radius Metal (5) = Flat Metal (V4) = Radius Veneer (V5) = Flat Veneer |
| High-Low Panel End 1. Pattern Number 2. Trim Finish | High-Low Panel End <i>Example:</i> DP2A PE42 117 DP2A Pattern Number PE42 117 Soft Grey | High-Low Panel End <ul style="list-style-type: none"> Panel end cover Connecting hardware Lower transition cap | |

Thin Profile Panel End Trim and High-Low Panel End

| description | type | h* | w | d | pattern no. | P1 | P2 | P3 |
|--|---------------|---------|------|----------------|-------------------|-------|-------|-------|
| Thin Profile Panel End  | 28 1/2" | 28 1/2" | 3" | 5/8" | DP6PEWH | \$99. | \$99. | \$99. |
| | 28 1/2" + 14" | 42 1/2" | 3" | 5/8" | DP6PEWHS14 | 116. | 128. | 133. |
| | 28 1/2" + 21" | 49 1/2" | 3" | 5/8" | DP6PEWHS21 | 126. | 138. | 144. |
| | 28 1/2" + 28" | 56 1/2" | 3" | 5/8" | DP6PEWHS28 | 135. | 148. | 153. |
| | 36" | 36" | 3" | 5/8" | DP6PE36F | 99. | 99. | 99. |
| | 42" | 42" | 3" | 5/8" | DP6PE42 | 106. | 106. | 106. |
| | 50" | 50" | 3" | 5/8" | DP6PE50 | 118. | 118. | 118. |
| | 57" | 57" | 3" | 5/8" | DP6PE57 | 128. | 128. | 128. |
| | 64" | 64" | 3" | 5/8" | DP6PE64 | 138. | 138. | 138. |
| | 78" | 78" | 3" | 5/8" | DP6PE78 | 161. | 161. | 161. |
| Thin Profile Panel End High-Low  | 28 1/2"-36" | 36" | 3" | 5/8" | DP6PEWH36 | 69. | 75. | 78. |
| | 28 1/2"-42" | 42" | 3" | 5/8" | DP6PEWH42 | 77. | 84. | 87. |
| | 28 1/2"-50" | 50" | 3" | 5/8" | DP6PEWH50 | 84. | 95. | 98. |
| | 28 1/2"-57" | 57" | 3" | 5/8" | DP6PEWH57 | 94. | 102. | 106. |
| | 28 1/2"-64" | 64" | 3" | 5/8" | DP6PEWH64 | 103. | 114. | 119. |
| | 28 1/2"-78" | 78" | 3" | 5/8" | DP6PEWH78 | 124. | 137. | 142. |
| | 36"-42" | 6" | 3" | 5/8" | DP6PE08 | 49. | 51. | 51. |
| | 36"-50" | 14" | 3" | 5/8" | DP6PE14 | 62. | 66. | 66. |
| | 36"-57" | 21" | 3" | 5/8" | DP6PE22 | 75. | 79. | 79. |
| | 36"-64" | 28" | 3" | 5/8" | DP6PE28 | 86. | 92. | 92. |
| | 36"-78" | 42" | 3" | 5/8" | DP6PE42H | 106. | 114. | 114. |
| | 42"-50" | 8" | 3" | 5/8" | DP6PE08 | 49. | 51. | 51. |
| | 42"-57" | 15" | 3" | 5/8" | DP6PE14 | 62. | 66. | 66. |
| | 42"-64" | 22" | 3" | 5/8" | DP6PE22 | 75. | 79. | 79. |
| | 42"-78" | 36" | 3" | 5/8" | DP6PE36 | 99. | 103. | 103. |
| | 50"-57" | 7" | 3" | 5/8" | DP6PE08 | 49. | 51. | 51. |
| | 50"-64" | 14" | 3" | 5/8" | DP6PE14 | 62. | 66. | 66. |
| | 50"-78" | 28" | 3" | 5/8" | DP6PE28 | 86. | 92. | 92. |
| | 57"-64" | 7" | 3" | 5/8" | DP6PE08 | 49. | 51. | 51. |
| | 57"-78" | 21" | 3" | 5/8" | DP6PE22 | 75. | 79. | 79. |
| 64"-78" | 14" | 3" | 5/8" | DP6PE14 | 62. | 66. | 66. | |

h* = Nominal height
 Dimensions listed under h w d are actual to the nearest 1/16"

| Ordering Information | Order Code | Included with: | Options |
|------------------------------|------------------------------------|--|---------|
| Thin Profile End Trim | Thin Profile End Trim | Thin Panel End Trim | |
| 1. Pattern Number | <i>Example:</i> DP6PE42 117 | Attachment hardware | |
| 2. Finish | DP Dividends Panel | Note: Thin profile end trim is only available in Knoll core paint finishes. | |
| | 6 Thin Profile | | |
| | PE Panel End | | |
| | 42 Height | | |
| | 117 Finish | | |

Panel End Trim and Panel Top Caps

Topway and Full View Frame Top Caps

Dividends Horizon

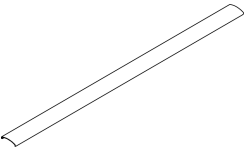
| description | w | pattern no. | Plastic | Metal P1 | Metal P2 | Metal P3 | Veneer |
|---|-----|------------------|---------|----------|----------|----------|--------|
| Panel Top Caps  | 15" | DP()PT15 | \$14. | \$43. | \$45. | \$47. | \$88. |
| | 18" | DP()PT18 | 14. | 43. | 45. | 47. | 98. |
| | 24" | DP()PT24 | 16. | 43. | 45. | 47. | 111. |
| | 30" | DP()PT30 | 22. | 43. | 45. | 47. | 127. |
| | 36" | DP()PT36 | 24. | 43. | 45. | 47. | 142. |
| | 42" | DP()PT42 | 24. | 43. | 45. | 47. | 159. |
| | 48" | DP()PT48 | 25. | 43. | 45. | 47. | 180. |
| | 54" | DP()PT54 | n/a | 47. | 49. | 51. | 201. |
| | 60" | DP()PT60 | 29. | 50. | 52. | 56. | 225. |
| | 66" | DP()PT66 | n/a | 56. | 59. | 62. | 248. |
| | 72" | DP()PT72 | n/a | 61. | 66. | 70. | 261. |
| | 78" | DP()PT78 | n/a | 69. | 72. | 75. | 277. |
| | 84" | DP()PT84 | n/a | 74. | 77. | 81. | 291. |
| | 90" | DP()PT90 | n/a | 80. | 84. | 87. | 309. |
| | 96" | DP()PT96 | n/a | 85. | 92. | 97. | 328. |

Post Connectors/End Trim

Ordering Information

1. Pattern Number
2. Trim Finish

Order Code

Panel Top Cap
Example: **DP5PT18, 117**
DP5PT18 Pattern number
117 Soft Grey trim finish

Included with:

- Panel Top Cap**
- Panel Top Cap

Options

Panel Top Caps

Trim options
(2A) = Enhanced Smooth Radius Plastic
(4) = Radius Metal
(5) = Flat Metal
(V4) = Radius Veneer
(V5) = Flat Veneer

Panel End Trim and Panel Top Caps

Shortened Panel Top Caps

Dividends Horizon

| description | w | pattern no. | Plastic | Metal P1 | Metal P2 | Metal P3 | Veneer |
|--|------------------|------------------|---------|----------|----------|----------|--------|
| Shortened Panel Top Caps (for lower panel on high-low panel to panel application) Not for use with DP6 Thin profile panel ends | 14" | DP()PT14 | \$14. | \$43. | \$45. | \$47. | \$88. |
| | 17" | DP()PT17 | 14. | 43. | 45. | 47. | 98. |
| | 23" | DP()PT23 | 16. | 43. | 45. | 47. | 111. |
| | 29" | DP()PT29 | 22. | 43. | 45. | 47. | 127. |
| | 35" | DP()PT35 | 24. | 43. | 45. | 47. | 142. |
| | 41" | DP()PT41 | 24. | 43. | 45. | 47. | 159. |
| | 47" | DP()PT47 | 25. | 43. | 45. | 47. | 180. |
| | 53" | DP()PT53 | n/a | 47. | 49. | 51. | 201. |
| | 59" | DP()PT59 | 29. | 50. | 52. | 56. | 225. |
| | 65" | DP()PT65 | n/a | 56. | 59. | 62. | 248. |
| | 71" | DP()PT71 | n/a | 61. | 66. | 70. | 261. |
| | 77" | DP()PT77 | n/a | 69. | 72. | 75. | 277. |
| | 83" | DP()PT83 | n/a | 74. | 77. | 81. | 291. |
| | 89" | DP()PT89 | n/a | 80. | 84. | 87. | 309. |
| 95" | DP()PT95 | n/a | 85. | 92. | 97. | 328. | |

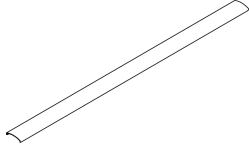

h* = Nominal height
Dimensions listed under h w d are actual to the nearest 1/16"

| Ordering Information | Order Code | Included with: | Options |
|---|--|---|--|
| Panel Top Cap 1. Pattern Number 2. Trim Finish | Panel Top Cap <i>Example:</i> DP5PT18, 117 DP5PT18 Pattern number | Panel Top Cap • Panel Top Cap | Panel Top Caps Trim options (2A) = Enhanced Smooth Radius Plastic (4) = Radius Metal (5) = Flat Metal (V4) = Radius Veneer (V5) = Flat Veneer |
| Panel-to-Panel Top Cap Transition 1. Pattern Number 2. Trim Finish | 117 Soft Grey trim finish | | |

This page intentionally left blank

Panel Wall Starter, Panel-to-Panel Top Cap Transition

Off-Module Panel Connector

Specifications

Panel Wall Starter

Panel wall starters mount to reinforced building walls to begin a perpendicular topway or full view panel run. Wall starters consist of a wall bracket and upper and lower panel-mounting brackets. Wall fasteners are not included or supplied by Knoll. Choice of wall fasteners is critical and must be selected to match the wall construction, wall surface and loading conditions.

Wall starters are available in all Dividends Horizon panel heights. Black finish only.

NOTE: KNOLL, INC. ASSUMES NO RESPONSIBILITY FOR WALL CONSTRUCTION OR PERFORMANCE OF FASTENERS USED.

Off-Module Panel Connector

The off-module connector allows for panel attachment anywhere along the width of the perpendicular panel. The off-module connector can be used with same height topway or full view panels only. The connector consists of a height specific connector and attaching hardware. The 3-way (DP1PT3) or 4-way (DP1PT4) post top cap must be ordered separately when radius metal top caps are being used. Specify connector height to match panel height. Black finish only.

When using the off-module panel connector, the attached connector will deface the perpendicular fabric panel insert.

Electrical components and data cables cannot be routed through the off-module panel.

Panel-to-Panel Top Cap Transition

Top cap transitions fill the gap between panel top cap sections in straight panel-to-panel configurations.

- Construction: Trim-colored, softly-radiused molded plastic
- Size: 1" wide by 3" deep
- Attachment: Snaps between top cap sections in straight, same-height panel configurations

NOTE: PANEL-TO-PANEL TOP CAP TRANSITIONS ARE ORDERED SEPARATELY FROM PANELS.

Panel Wall Starter Connection

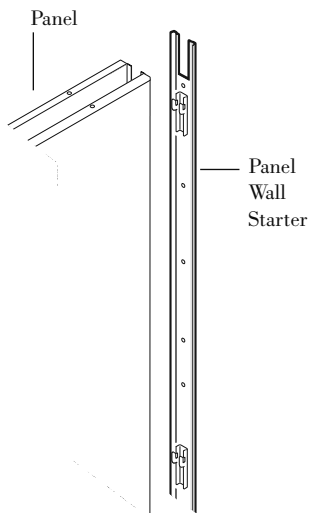

Off-Module Panel Connector

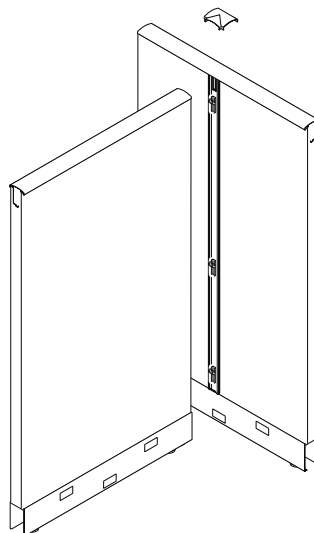

Panel-To-Panel Transition for Enhanced Smooth Panel Trim

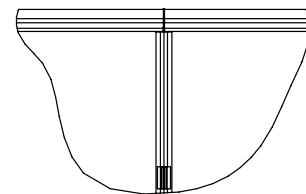

Panel Wall Starter, Panel-to-Panel Top Cap Transition and Off-Module Panel Connector

Dividends Horizon

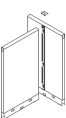
| description | type | h * | h | w | d | pattern no. | Single pack list | 10 pack list |
|--|-----------|------|-----------|----|------|---------------------|------------------|--------------|
|  Panel/Screen Wall Starter | | 36" | 28" | 2" | 3/4" | DP3PWS36 | \$101. | n/a |
| | | 42" | 35 3/8" | 2" | 3/4" | DP3PWS42 | 105. | n/a |
| | | 50" | 42 11/16" | 2" | 3/4" | DP3PWS50 | 109. | n/a |
| | | 57" | 50" | 2" | 3/4" | DP3PWS57 | 112. | n/a |
| | | 64" | 57 1/4" | 2" | 3/4" | DP3PWS64 | 119. | n/a |
| | | 78" | 71 7/8" | 2" | 3/4" | DP3PWS78 | 124. | n/a |
| Panel-to-Panel Top Cap Transition | | 3/4" | 1" | 3" | | DP() TCT() | 3. | 27. |
|  Off-Module Panel Connector | | 36" | 28" | 2" | 3/4" | DP2PMS36 | 66. | n/a |
| | | 42" | 35 3/8" | 2" | 3/4" | DP2PMS42 | 66. | n/a |
| | | 50" | 42 11/16" | 2" | 3/4" | DP2PMS50 | 74. | n/a |
| | | 57" | 50" | 2" | 3/4" | DP2PMS57 | 77. | n/a |
| | | 64" | 57 1/4" | 2" | 3/4" | DP2PMS64 | 79. | n/a |
| | | 78" | 71 7/8" | 2" | 3/4" | DP2PMS78 | 96. | n/a |
| Radius Post Top Cap (for use with off-module panel connector when radius metal top caps are used) | three-way | | 1/2" | 3" | 3" | DP1PT3 | 5. | n/a |
| | four-way | | 1/2" | 3" | 3" | DP1PT4 | 5. | n/a |

Post Connectors/End Trim

h* = nominal height
Dimensions listed under h w d are actual to the nearest 1/16"

| Ordering Information | Order Code | Included with: | Options |
|---|--|---|--|
| Panel Wall Starter 1. Pattern Number | Panel Wall Starter <i>Example:</i> DP1 PWS 64 | Panel Wall Starter | Panel Wall Starter |
| Off-Module Panel Connector 1. Pattern Number | DP1 PW Pattern Number 64 | Off-Module Panel Connector | Off-Module Panel Connector |
| Panel-to-Panel Top Cap Transition 1. Pattern Number 2. Trim Finish | Off-Module Panel Connector <i>Example:</i> DP1 PMS50 DP1 Pattern Number PMS50 Panel-to-Panel Top Cap Transition <i>Example:</i> DP1 TCT, 117 DP1 TCT Pattern Number 117 Soft Grey | Panel-to-Panel Top Cap Transition Note: Three-way or four-way post top cap must be ordered separately when radius metal panel top caps are being used. | Panel-to-Panel Top Cap Transition Trim Option: (2A) = Enhanced Smooth Radius Plastic (4) = Radius Metal (5) = Flat Metal (V4) = Radius Veneer (V5) = Flat Veneer Panel-to-Panel Top Cap Transition Add an 'SP' suffix to the base pattern number for single pack or 'TP' suffix for a 10 pack. |

Dividends Horizon Wall System

The Dividends Horizon Wall System allows designers to transform the aesthetic and function of private offices.

With the use of vertical wall tracks, building walls can support worksurfaces and storage, while fabric, slatwall, and marker board tiles improve aesthetic and function.

Wall System Dimensions

The Dividends Horizon wall system is available in heights of 57, 64, 71 and 78" from the finished floor. Wall tracks are designed to be positioned 5" from top of finished floor to accommodate building base molding and uneven floors.

Horizontal elements like bottom trim channels and top trims are available on 6" increments, from 24" to 48" wide. The maximum distance between wall tracks is 48".

Wall Tracks

Wall tracks work like the vertical elements of a Dividends Horizon panel frame, and are shipped in pairs which include a left and right track. Tracks feature slotted standards on the standard Dividends Horizon 1 1/2" increment.

Wall tracks are attached to building walls at 7" height increments. Available in all Knoll Core paint finishes.

End Trim

While wall tracks are painted, end trims are available for applications where a finished end is desired. Match end trim height to wall track height.

Top Cap

Top caps are available for applications with a lower horizon height, and are optional. Top caps conceal the space between tiles and the finished wall, and the top of the wall tracks.

Bottom Channel

The bottom channel is a "J" shaped channel that supports the bottom of the lowest tile. Bottom channels are also used during the installation process to accurately set the width between left and right wall tracks.

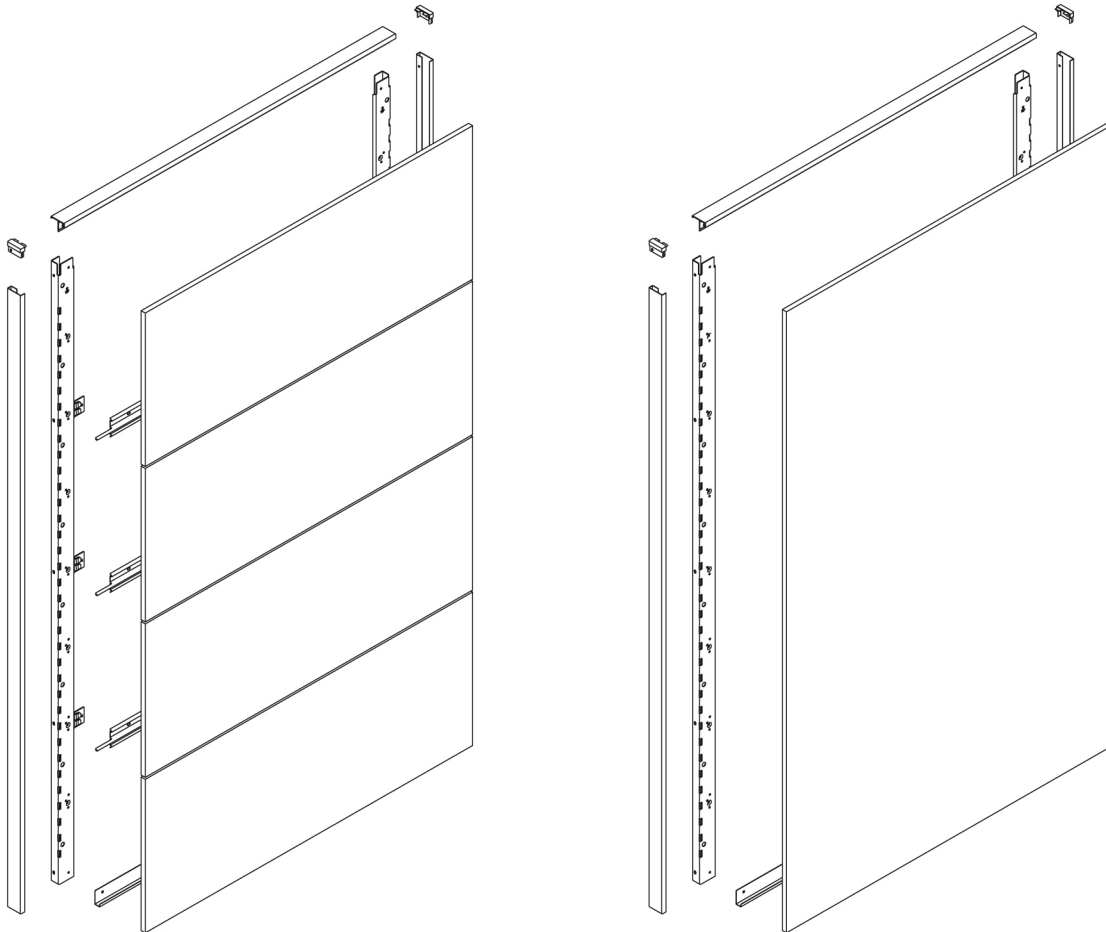

Tile Supports

Tile supports are specified in the same manner as with Dividends Horizon panels, and are not required at the top or bottom of wall tracks, or with Slatwall. Specify Wall Track tile support mounting brackets for each tile support.

Tiles

Standard Dividends Horizon tiles are specified with Wall Tracks.

Wall tracks support monolithic or tiled applications, using standard fabric, steel, or Slatwall tiles. Specify bottom channels at the bottom of the lowest tile.

Unlike panels, Wall Tracks accommodate tile supports at 7" inch increments, increasing design flexibility. Both D1 and D2 tile supports may be used with Wall Tracks.

For tiled applications, specify standard tile supports, and DP1WTTSB tile support mounting brackets for D2 tile supports.

Worksurface Planning

Dividends Horizon worksurfaces up to 24" deep may be mounted to wall tracks, using the same cantilevers, end supports and end panels used in panel planning, and follow the same planning rules.

Wall Track Planning

Wall tracks may be positioned on 6" width increments, from 24" to a maximum of 48".

Worksurfaces are supported with standard supports, including cantilevers, end supports, and end panels. Maximum worksurface depth when cantilever supported is 24".

One overhead may be mounted on each wall track section.

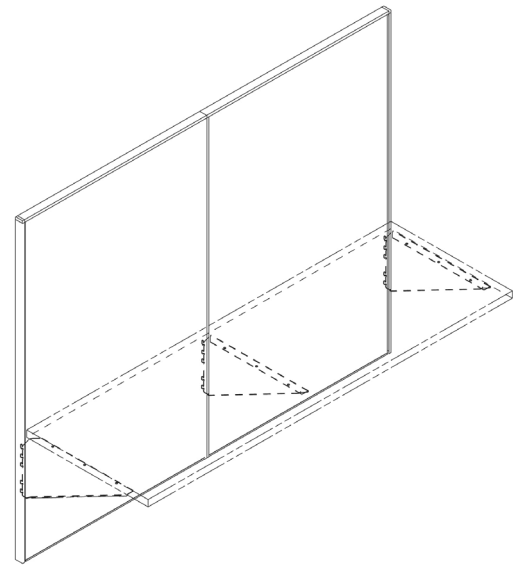



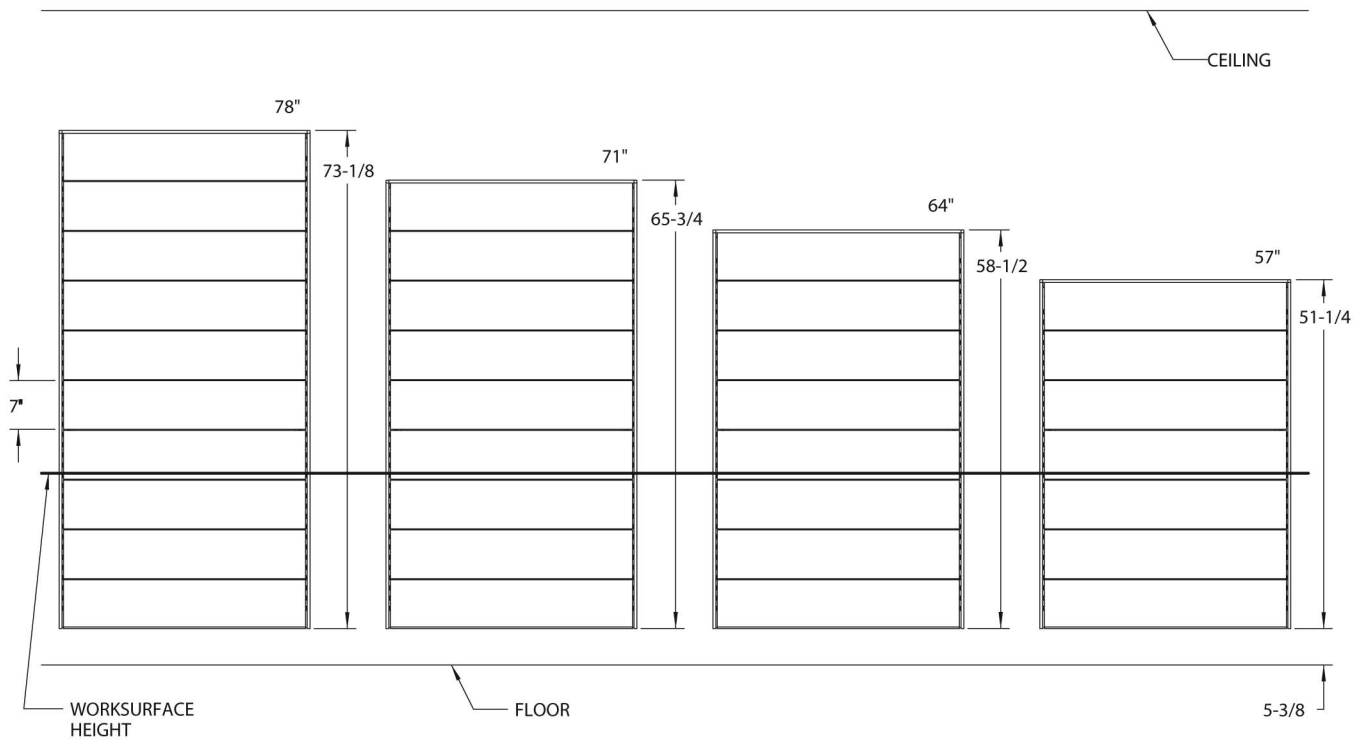

Post Connectors/End Trim



Wall Mount Tracks and Components

57", 64", 71" and 78" High

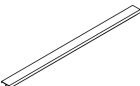
Dividends Horizon

| description | w | h | d | pattern no. | NA Black | P1 | P2 | P3 |
|---|--------|--------|-------------------|-------------------|----------|--------|--------|--------|
|  Wall Mount Tracks (pair) | 1 1/2" | 57" | 1 1/2" | DP1WT57 | \$228. | \$228. | \$252. | \$261. |
| | 1 1/2" | 64" | 1 1/2" | DP1WT64 | 237. | 237. | 261. | 271. |
| | 1 1/2" | 71" | 1 1/2" | DP1WT71 | 246. | 246. | 271. | 283. |
| | 1 1/2" | 78" | 1 1/2" | DP1WT78 | 256. | 256. | 282. | 292. |
|  End Trim for Wall Mount Tracks | 1 1/2" | 57" | 5/8" | DP1WTET57 | n/a | 83. | 92. | 96. |
| | 1 1/2" | 64" | 5/8" | DP1WTET64 | n/a | 92. | 101. | 105. |
| | 1 1/2" | 71" | 5/8" | DP1WTET71 | n/a | 92. | 101. | 105. |
| | 1 1/2" | 78" | 5/8" | DP1WTET78 | n/a | 92. | 101. | 105. |
|  Top Cap for Wall Mount Tracks | 15" | 3/4" | 1 1/2" | DP1WTTC15 | n/a | 67. | 74. | 77. |
| | 18" | 3/4" | 1 1/2" | DP1WTTC18 | n/a | 71. | 77. | 80. |
| | 24" | 3/4" | 1 1/2" | DP1WTTC24 | n/a | 74. | 81. | 84. |
| | 30" | 3/4" | 1 1/2" | DP1WTTC30 | n/a | 82. | 90. | 95. |
| | 36" | 3/4" | 1 1/2" | DP1WTTC36 | n/a | 94. | 102. | 106. |
| | 42" | 3/4" | 1 1/2" | DP1WTTC42 | n/a | 101. | 110. | 116. |
| | 48" | 3/4" | 1 1/2" | DP1WTTC48 | n/a | 101. | 110. | 116. |
| | 54" | 3/4" | 1 1/2" | DP1WTTC54 | n/a | 120. | 133. | 138. |
| | 60" | 3/4" | 1 1/2" | DP1WTTC60 | n/a | 121. | 134. | 139. |
| | 66" | 3/4" | 1 1/2" | DP1WTTC66 | n/a | 121. | 134. | 139. |
| | 72" | 3/4" | 1 1/2" | DP1WTTC72 | n/a | 121. | 134. | 139. |
| | 78" | 3/4" | 1 1/2" | DP1WTTC78 | n/a | 127. | 139. | 145. |
| | 84" | 3/4" | 1 1/2" | DP1WTTC84 | n/a | 171. | 186. | 193. |
| 90" | 3/4" | 1 1/2" | DP1WTTC90 | n/a | 175. | 190. | 199. | |
| 96" | 3/4" | 1 1/2" | DP1WTTC96 | n/a | 179. | 196. | 206. | |
|  Bottom Tile Channel for Wall Mount Tracks | 15" | | | DP1WTBTC15 | n/a | 48. | 52. | 56. |
| | 18" | | | DP1WTBTC18 | n/a | 49. | 54. | 57. |
| | 24" | | | DP1WTBTC24 | n/a | 52. | 59. | 61. |
| | 30" | | | DP1WTBTC30 | n/a | 56. | 61. | 63. |
| | 36" | | | DP1WTBTC36 | n/a | 67. | 74. | 77. |
| | 42" | | | DP1WTBTC42 | n/a | 76. | 83. | 86. |
| 48" | | | DP1WTBTC48 | n/a | 86. | 97. | 100. | |

Ordering Information

Wall Mount Tracks

1. Pattern Number
2. Paint Finish

End Trim for Wall Mount Tracks

1. Pattern Number
2. Paint Finish

Top Cap for Wall Mount Tracks

1. Pattern Number
2. Paint Finish

Bottom Tile Channel for Wall Mount Tracks

1. Pattern Number
2. Paint Finish

Tile Support Brackets

1. Pattern Number

Order Code

Wall Mount Tracks

Example: **DP1WT57613**

DP1WT57 Pattern Number

613 Paint Finish

Tile Support Brackets

Example: **DP1WTTSB**

DP1WT Pattern Number

TSB

Included with:

Wall Mount Tracks

Wall fasteners are not included or supplied by Knoll.

Bottom Tile Channel for Wall Mount Tracks

- Hardware

Tile Support Brackets for Wall Mount Tracks

- Hardware

Options

Wall Mount Tracks and Components

57", 64", 71" and 78" High

Dividends Horizon

| description | w | h | d | pattern no. | NA Black | P1 | P2 | P3 |
|--|---|---|---|-----------------|----------|-----|-----|-----|
| Tile Support Brackets for Wall Mount Tracks (pair) | | | | DP1WTTSB | \$11. | n/a | n/a | n/a |



Post Connectors/End Trim

| Ordering Information | Order Code | Included with: | Options |
|--|--|---|---------|
| Wall Mount Tracks 1. Pattern Number 2. Paint Finish | Wall Mount Tracks <i>Example:</i> DP1WT57613 DP1WT57 Pattern Number | Wall Mount Tracks Wall fasteners are not included or supplied by Knoll. | |
| End Trim for Wall Mount Tracks 1. Pattern Number 2. Paint Finish | 613 Paint Finish Tile Support Brackets <i>Example:</i> DP1WTTSB | Bottom Tile Channel for Wall Mount Tracks • Hardware | |
| Top Cap for Wall Mount Tracks 1. Pattern Number 2. Paint Finish | DP1WT Pattern Number TSB | Tile Support Brackets for Wall Mount Tracks • Hardware | |
| Bottom Tile Channel for Wall Mount Tracks 1. Pattern Number 2. Paint Finish | | | |
| Tile Support Brackets 1. Pattern Number | | | |

Panel Rigidizer Brackets

Panel rigidizer brackets are used to reduce panel connection flex where panel to worksurface brackets cannot be used.

Panel rigidizer brackets are unnecessary if a panel can be properly secured with the use of a panel to worksurface bracket.

Rigidizer brackets are available for inline (straight), 2-way (L), 3-way (T) and 4-way (X) panel conditions.

High-low panel to post conditions cannot accommodate the panel rigidizer brackets. Full view panel frames without a topway cannot accommodate a panel rigidizer bracket.

Carpet grippers are recommended for use with panel rigidizer brackets.

Specify panel rigidizer brackets for appropriate panel attachment condition.

- 2-way (L) for panels of the same height in a 90 degree application

- 3-way (T) for 3 panels of the same height attached to a universal post.
- 4-way (X) for 4 panels of the same height attached to a universal post.

Carpet Grippers

Carpet grippers should be specified to increase rigidity of unsupported panel runs. The carpet grippers snap onto leveling glides to prevent panel runs from shifting on carpet. The glides rotate in carpet grippers to permit leveling. Available in black finish only.

Panel-Mounted Coat Hook

The Dividends Horizon panel-mounted coat hook is made of extruded aluminum and is available in an anodized black finish or matte aluminum finish. The coat hook attaches to any Dividends Horizon panel by connecting over the top of the Dividends Horizon radius plastic and metal panel top caps only.

Slotted Standard Coat Hook

Independent of the top cap, the slotted standard coat hook attaches to the left or right vertical slotted standard of any Dividends Horizon panel. The die cast slotted standard

coat hook is available in any of the Knoll Core paint finishes. The slotted standard coat hook is sold in packages of ten and is not compatible with laminate tiles or screens.

Panel Reveal Fillers

Panel reveal filler strips are used to cover unused vertical panel slots. Panel reveal fillers are designed to only be used with Legacy post panel applications. Panel reveal fillers should not be used with panel applications that are using DP7 posts. Panel reveal fillers are available in two thickness:

- 1/2" for panel-to-panel and panel to end trim attachment.
- 1/4" for panel-to-post attachment.

Panel reveal fillers are offered in a 74" length and are field cut to install into any Dividends Horizon panel height.

To determine the correct amount of reveal fillers to be specified, use the following formulas: For panels and end trim-2 x the number of straight panel connections plus the number of panel end trims. For panel to post connections, 4x the number of posts.

Panel Rigidizer Brackets

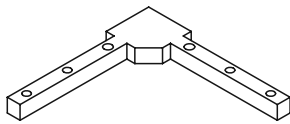

Two-way "L"

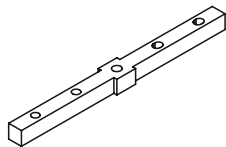

Inline (straight)

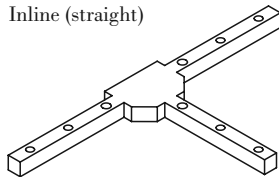

Three-way "T"

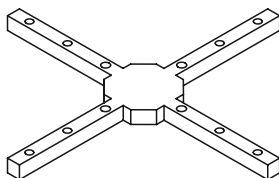

Four-way "X"

Carpet Gripper



Panel-Mounted Coat Hook (for radius plastic and metal trim only)

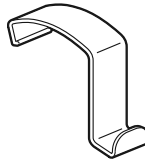

Slotted Standard Coat Hook

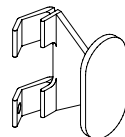

Panel Reveal Fillers

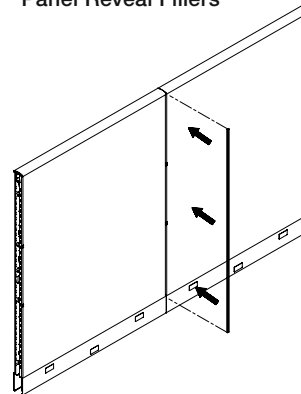

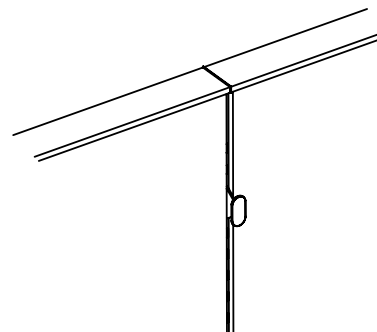

Slotted Standard Coat Hook Application



Panel Rigidizer Brackets, Coat Hooks and Reveal Fillers

Carpet Grippers

Dividends Horizon

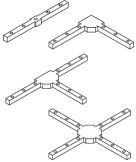
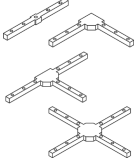
| description | type | h | w | d | pattern no. | list | P1 | P2 | P3 |
|---|-----------------------|------|--------|--------|-----------------|-------|------|------|------|
| Carpet Grippers  | Package of 10 | | | | DP1 CG | \$14. | | | |
| Coat Hook (For Panel Slotted Standard)  | Package of 10 | | | | DP2CHTP | | 149. | 149. | 149. |
| Coat Hook (For radius metal and plastic trim only) (Package of 4)  | Anodized Black Finish | | | | DP1 CHB | 130. | | | |
| | Matte Aluminum Finish | | | | DP1 CHP | 123. | | | |
| Panel Rigidizer Brackets for topway panel frames  | 2-way-L | 1/2" | 5 1/2" | 5 1/2" | DP1PRBL | 96. | | | |
| | 3-way-T | 1/2" | 5 1/2" | 5 1/2" | DP1PRBT | 114. | | | |
| | 4-way-X | 1/2" | 5 1/2" | 5 1/2" | DP1PRBX | 190. | | | |
| | Straight | 1/2" | 5 1/2" | 5/8" | DP1PRBS | 81. | | | |
| Panel Rigidizer Brackets for full view panel frames  | 2-way-L | 1/2" | 5 1/2" | 5 1/2" | DP1FPRBL | 27. | | | |
| | 3-way-T | 1/2" | 5 1/2" | 5 1/2" | DP1FPRBT | 46. | | | |
| | 4-way-X | 1/2" | 5 1/2" | 5 1/2" | DP1FPRBX | 68. | | | |
| | Straight | 1/2" | 5 1/2" | 5 1/2" | DP1FPRBS | 32. | | | |

Post Connectors/End Trim

Ordering Information

Panel Rigidizer Bracket

1. Pattern Number

Panel Reveal Filler

1. Pattern Number

Slotted Standard Coat Hook

1. Pattern Number
2. Paint Finish

Order Code

Panel Rigidizer Bracket

Example: **DP1 PRBL**

Panel Reveal Filler

Example: **DP1PRF N15**

Slotted Standard Coat Hook

Example: **DP2CH**

118 Bright White

Included with:

Panel Rigidizer Bracket

- Rigidizer Bracket
- Set Screws

Panel Reveal Filler

- Reveal Fillers (15 qty)

Options

Panel Rigidizer Bracket

Panel Reveal Filler

Note: Two narrow panel reveal fillers are required for inside corner on DP2/4/5 posts. They are used only on the outside of DP7 posts.

Panel Rigidizer Brackets, Coat Hooks and Reveal Fillers

Carpet Grippers

Dividends Horizon

| description | type | h | w | d | pattern no. | list | P1 | P2 | P3 |
|--|-------------|-----|---|---|-------------------|-------|----|----|----|
| Panel Reveal Filler (for panel-to-post attachment) for pre-DP7 panels/posts | 15 Fillers | 74" | | | DP1PRFN15 | \$47. | | | |
| | 250 Fillers | 74" | | | DP1PRFN250 | 347. | | | |
| | 70 Fillers | 74" | | | DP1PRFN70 | 124. | | | |
| Wide Panel Reveal Filler (for panel-to-panel and panel-to-DP2/4/5 end trim) | 15 Fillers | 74" | | | DP2PRFW15 | 61. | | | |
| | 70 Fillers | 74" | | | DP2PRFW70 | 177. | | | |
| Narrow Panel Reveal Filler (for panel-to-post attachment and panel-to-DP6 end trim) | 15 Fillers | 74" | | | DP2PRFN15 | 47. | | | |
| | 70 Fillers | 74" | | | DP2PRFN70 | 124. | | | |
| Corner Panel Reveal Filler (for inside corner of DP7 post) | 15 Fillers | 74" | | | DP2PRFIC15 | 177. | | | |
| | 70 Fillers | 74" | | | DP2PRFIC70 | 792. | | | |

Ordering Information

Panel Rigidizer Bracket

1. Pattern Number

Panel Reveal Filler

1. Pattern Number

Slotted Standard Coat Hook

1. Pattern Number
2. Paint Finish

Order Code

Panel Rigidizer Bracket

Example: **DP1 PRBL**

Panel Reveal Filler

Example: **DP1PRF N15**

Slotted Standard Coat Hook

Example: **DP2CH**

118 Bright White

Included with:

Panel Rigidizer Bracket

- Rigidizer Bracket
- Set Screws

Panel Reveal Filler

- Reveal Fillers (15 qty)

Options

Panel Rigidizer Bracket

Panel Reveal Filler

Note: Two narrow panel reveal fillers are required for inside corner on DP2/4/5 posts. They are used only on the outside of DP7 posts.

This page intentionally left blank

Concealed Post Planning Guidelines Specifications

Concealed Post

Concealed posts eliminate visible post covers, creating a seamless aesthetic at three-way post connections. Larger widths of fabric or laminate tile-to-floor tiles are used to hide the concealed post. Panel top caps, up to 99" long, span concealed posts, which eliminate the need for post top caps. Concealed post applications are specified by individual components through "Build-to-Spec".

Planning with Concealed Posts

Concealed posts are to be used in three-way post conditions where straight post covers want to be eliminated. The concealed post should be specified in place of a standard Dividends Horizon DP7 or Legacy post. Concealed post fabric or laminate tiles must be specified in the tile location that is covering the post. (See illustration below) Concealed post, half post or centered fabric and laminate tiles are designed to cover the concealed post with the edge

of the tile ending in the center of the concealed post. Only concealed post fabric and laminate tile sizes are compatible with concealed posts.

A high low condition may be created by having a perpendicular panel at a lower height than the concealed post. Specify the height of the concealed post to be at the same height as the higher panels. A concealed post high low top cap must be specified in this situation. Panel top caps that span concealed posts are not designed for use in high-low concealed post applications, standard width panel top caps and a concealed post high low top cap should be used instead. A DP7 straight high low post cover should be specified in a concealed post high low application.

The two panels on the straight side of the three-way concealed post intersection must always be the same height. The concealed post is not designed to change height on the concealed post side of the three-way connection.

Concealed post panel top caps and frameless add ups are 3" wider than standard sizes, for applications wanting to span the concealed post. Panel top caps are available in lengths up to 99". Any concealed post application requiring panel top caps longer than 99" must specify panel top caps equal to the width of a panel or combination of panels and a concealed post same height top cap. Concealed post fabric and laminate tiles, post top caps, panel top caps, and frameless add ups are designed for use with the concealed post only.

Note: Concealed posts and corresponding components are not compatible with Dividends Horizon DP7 posts, Legacy posts, standard post top caps, or standard fabric or laminate tile sizes.

Concealed Post Connection Plan View

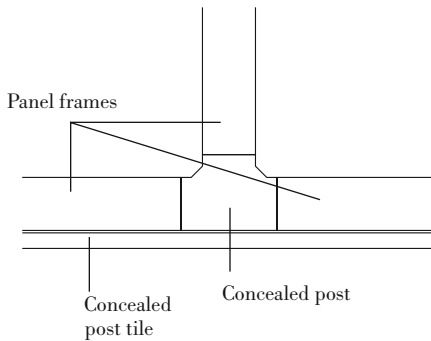

Concealed Post Application

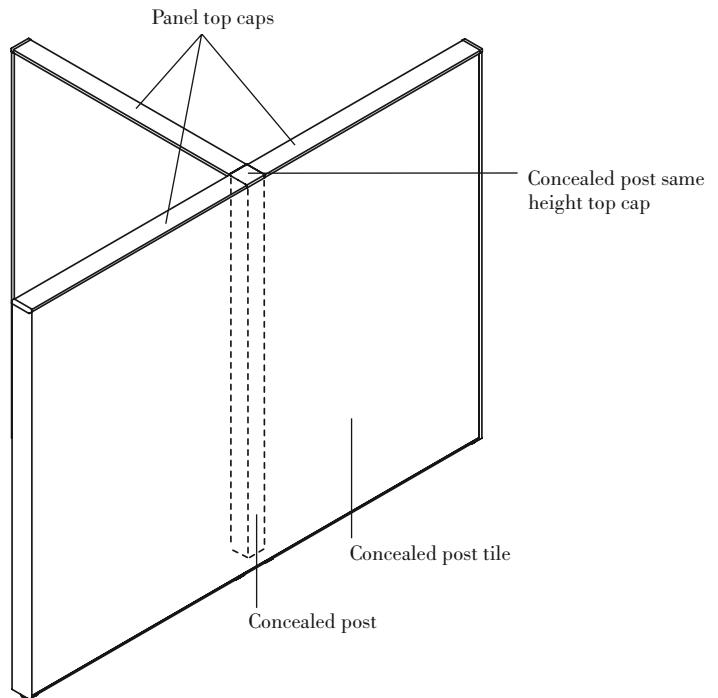

Concealed Post Construction

Concealed posts are a square extruded aluminum construction. They have cut-outs for electrical and data access that match the wire and cable channels provided by panel frames. This allows cables to be routed through the post at the topway and base raceway.

Concealed Post Same Height Top Cap

When all three panels in a concealed post application are the same height and standard length panel top caps are used, a concealed post same height top cap must be specified. A concealed post same height top cap covers the top of a concealed post and connects three panel top caps at the same height. (See illustration below)

Concealed Post High Low Top Cap

When the perpendicular panel in a three-way concealed post application is a lower height than the concealed post, a concealed post high low top cap must be specified. A concealed post high low top

cap covers the top of the concealed post and connects the two same height panel top caps. (See illustration below) A DP7 high low straight post cover should be specified in a concealed post high low application.

Concealed Post Top Cap Construction

Concealed post flat and radius profile top caps are constructed of injection molded colored plastic.

Concealed Post Panel Top Caps

Concealed post panel top caps are 3" longer than standard panel top cap widths, so they can span over a concealed post. Panel top caps must be specified according to the panel type, either full view or topway, they are attaching to. Concealed post panel top caps are available in flat profile metal. Concealed post panel top caps are not compatible with a Dividends Horizon DP7 or Legacy post. Concealed post panel top caps that span a concealed post must be used in same height applications only. High low concealed post conditions must use concealed post high low top caps. (See illustration below)

Concealed Post Shortened Panel Top Caps

Concealed post shortened panel tops are 3" longer than standard shortened panel top cap widths, so they can span over a concealed post. A concealed post shortened panel top cap must be specified for the lower panel in a high low panel-to-panel condition when the panel top cap of the lower panel is spanning over the concealed post. (See illustration below) When the lower panel top cap is not spanning over the concealed post because a concealed post top cap is being used, specify standard shortened panel top cap widths. Standard DP5 high low panel end trim should be specified with concealed post shortened panel top caps in high low panel-to-panel applications.

Concealed Post Panel Top Cap Construction

Concealed post panel top caps are constructed of roll-formed steel.

Concealed Post



Concealed Post Same Height Top Cap

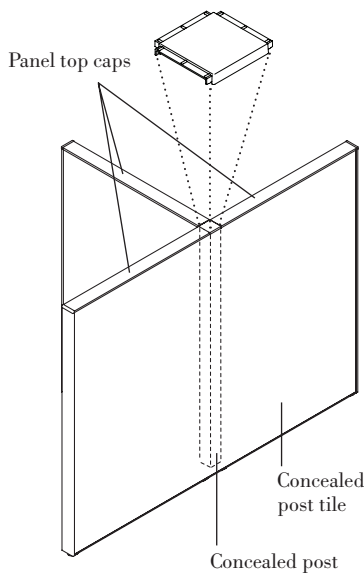

Concealed Post High Low Top Cap

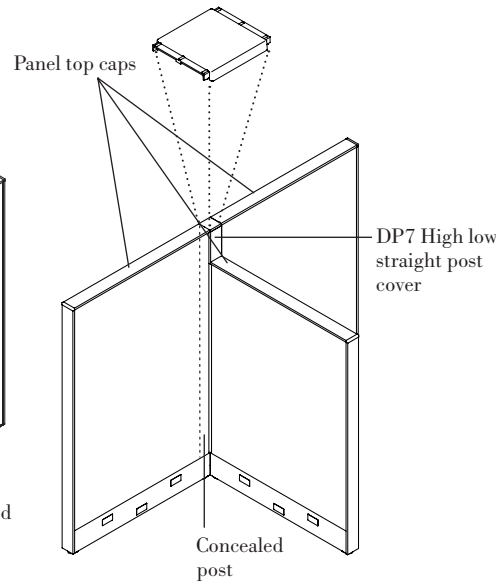

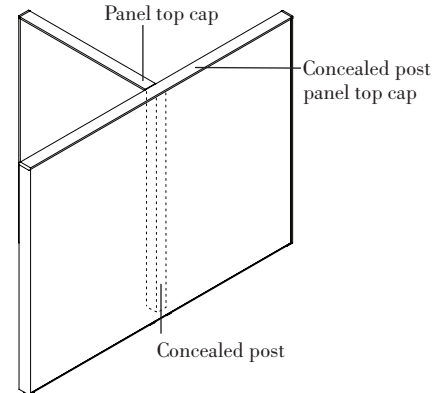

Concealed Post Panel Top Cap

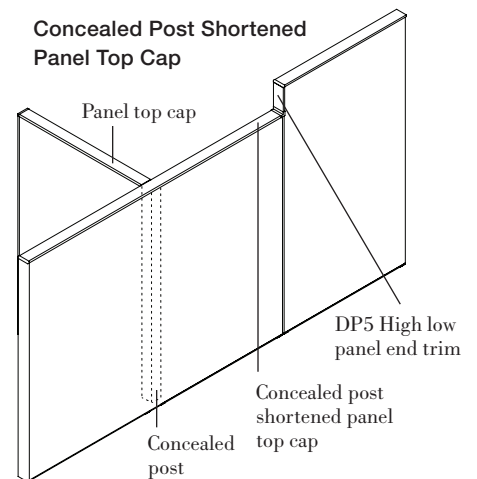

Concealed Post Shortened Panel Top Cap



Concealed Post
 Post Components
 Post and Post Top Caps

| description | w | h | d | pattern no. | list | P1 | P2 | P3 |
|---|----|---------|----|-------------------|--------|-----|-----|-----|
| Concealed Post  | 3" | 28 1/2" | 3" | DP7POWHCPF | \$135. | | | |
| | 3" | 36" | 3" | DP7PO36CPF | 152. | | | |
| | 3" | 42" | 3" | DP7PO42CPF | 164. | | | |
| | 3" | 50" | 3" | DP7PO50CPF | 178. | | | |
| | 3" | 57" | 3" | DP7PO57CPF | 191. | | | |
| | 3" | 64" | 3" | DP7PO64CPF | 214. | | | |
| Concealed Post Same Height Top Caps  | 3" | 1/2" | 3" | DP7PTCP() | | 12. | 14. | 15. |
| Concealed Post High Low Top Caps  | 3" | 1/2" | 3" | DP7PTCPH() | | 12. | 14. | 15. |

Ordering Information

Concealed Post

1. Pattern Number
2. Paint Finish Code

Concealed Post Top Caps

1. Pattern Number
2. Paint Finish Code

Order Code

Concealed Post

Example: **DP7PO42CPF**
DP7PO42 Pattern Number
CPF

Concealed Post Top Caps

Example: **DP7PTCP5**
DP7PTCP Pattern Number
5 Flat profile
613 Silver paint finish

Included with:

- Concealed Post**
- Tile to floor filler
- Concealed Post Top Caps**

Options:

Post Top Cap Option:

- (4)** = Radius Profile
- (5)** = Flat Profile

Concealed Post
 Post Components
 Panel Top Caps

Dividends Horizon

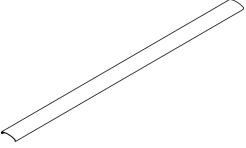
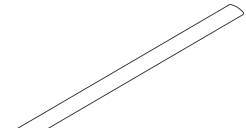
| description | w | h | d | pattern no. | P1 | P2 | P3 |
|---|-----|------|----|--------------------|-------|-------|-------|
| Concealed Post Panel Top Caps for use with Topway Frames  | 33" | 1/2" | 3" | DP()PT30CP | \$66. | \$73. | \$76. |
| | 39" | 1/2" | 3" | DP()PT36CP | 67. | 74. | 77. |
| | 51" | 1/2" | 3" | DP()PT48CP | 69. | 75. | 78. |
| | 63" | 1/2" | 3" | DP()PT60CP | 70. | 76. | 79. |
| | 75" | 1/2" | 3" | DP()PT72CP | 72. | 78. | 81. |
| | 87" | 1/2" | 3" | DP()PT84CP | 74. | 81. | 84. |
| | 99" | 1/2" | 3" | DP()PT96CP | 75. | 82. | 85. |
| Concealed Post Shortened Panel Top Caps for use with Topway Frames  | 32" | 1/2" | 3" | DP()PT29CP | 66. | 73. | 76. |
| | 38" | 1/2" | 3" | DP()PT35CP | 67. | 74. | 77. |
| | 50" | 1/2" | 3" | DP()PT47CP | 69. | 75. | 78. |
| | 62" | 1/2" | 3" | DP()PT59CP | 70. | 76. | 79. |
| | 74" | 1/2" | 3" | DP()PT71CP | 72. | 78. | 81. |
| | 86" | 1/2" | 3" | DP()PT83CP | 74. | 81. | 84. |
| | 98" | 1/2" | 3" | DP()PT95CP | 75. | 82. | 85. |

Alternative Planning

Ordering Information

Concealed Post Panel Top Caps

1. Pattern Number
2. Paint Finish Code

Order Code

Concealed Post Panel Top Caps

Example: **DP5PT48CP**

DP5PT48 Pattern Number
CP

117 Soft Grey paint finish

Included with:

Concealed Post Panel Top Caps

- Panel Top Caps

Options:

Trim Option:

- (5) = Metal, Flat

Concealed Post Monolithic Panel Inserts Specifications

Concealed Post Monolithic Inserts

Concealed post monolithic inserts are designed to cover a concealed post and eliminate the need for a post cover. Concealed post monolithic tile-to-floor fabric inserts create a seamless aesthetic at a three-way connection. There are three types of concealed post monolithic tiles: half post, centered, and double with post. Concealed post monolithic inserts can be fabric or laminate and are only available tile-to-floor. Concealed post applications are specified by individual components through "Build-to-Spec".

Concealed Post Monolithic Insert Construction

Fabric Tiles

Fabric laminated with adhesive and heat-cured to 7/18" thick acoustical board.

Laminate Tiles

The surface material is laminate on the front and back of a particle board core. Overall thickness is 7/16" with a 0.5 edgeband.

Concealed Post Monolithic Insert Attachment

Fabric Tiles

Panel inserts flex to attach to the troughs in the upper and lower horizontal frame supports. Mounting clips are attached to panel inserts for connection to the vertical frame for additional support. No tools are required for insert attachment.

Laminate Tiles

Laminate tiles are installed one side or both sides of a panel frame. Mounting clips are attached to laminate inserts for connection to the panel frame.

Planning with Concealed Post Half Post Tiles

Half post tiles attach to a panel frame or combination of panel frames that are connected to a concealed post. This type of tile covers the entire width of the panel frame(s) and half of the concealed post. Half post tiles are 1-1/2" wider than standard tile widths

to cover half of the concealed post. Half post tiles are handed, either left or right.

The left edge of a left half post tile ends in the middle of a concealed post and the right edge of the tile ends on the furthest right edge of the panel(s). The right edge of a right half post tile ends in the middle of a concealed post and the left edge of the tile ends on the left side of the panel(s). (See illustration below) A half post tile must be used with either another half post tile or a centered tile, so the other half of the post is concealed by a tile.

Half Post Tile Application

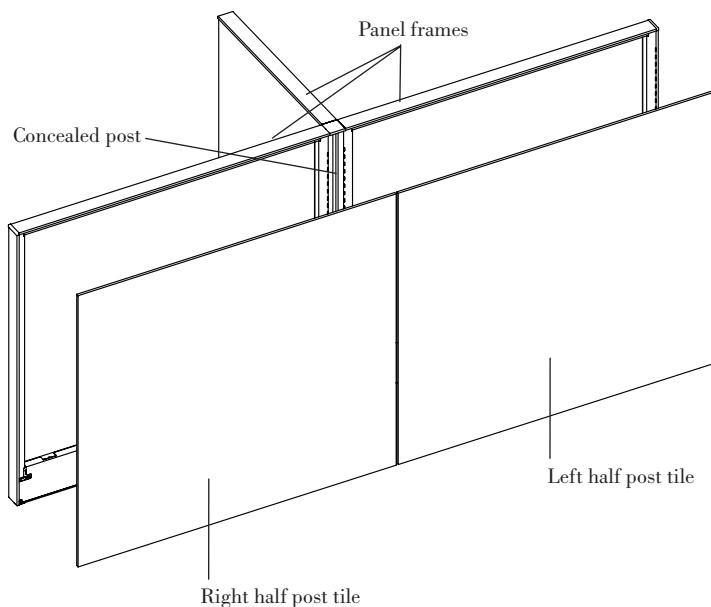

Half Post Tile Plan View

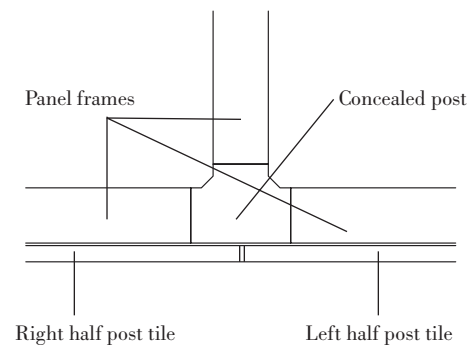

Concealed Post Monolithic Panel Inserts and Frameless Add Ups Specifications

Planning with Concealed Post Centered Tiles

Centered tiles attach to a panel frame or combination of panel frames that are connected to concealed posts. Centered tiles are centered on a panel frame(s) between two concealed posts. The left and right edge of the tile ends in the center of a concealed post. A centered tile is 3" wider than standard tile widths. Centered tiles must be centered on the panel frame(s) between the concealed posts. Neither the right nor left edge of a centered tile is able to end anywhere other than the center of a concealed post. (See illustration below) A centered tile must be used with either a half post tile or another centered tile, so the other half of the post is concealed by a tile.

Planning with Concealed Post Double with Post Tiles

A double with post tile attaches to two panel frames that are connected by a concealed post. The tile attaches to the panels and hides the concealed post connection. The concealed post must be between the panel frames. Double with post tiles are 3" wider than standard tile widths, so that they are able to cover a concealed post. (See illustration below) Neither the right nor left edge of a double with post tile is able to end anywhere other than the right or left edge of a panel frame.

Concealed Post Frameless Add Ups

Concealed post frameless add ups are 3" longer than standard frameless add up lengths, so they can span over a concealed post. Concealed post frameless add ups are not compatible with Dividends Horizon DP7 or Legacy posts.

Note: Concealed posts and corresponding components are not compatible with Dividends Horizon DP7 posts, Legacy posts, standard post top caps, or standard fabric or laminate tile sizes.

Double With Post Tile Application

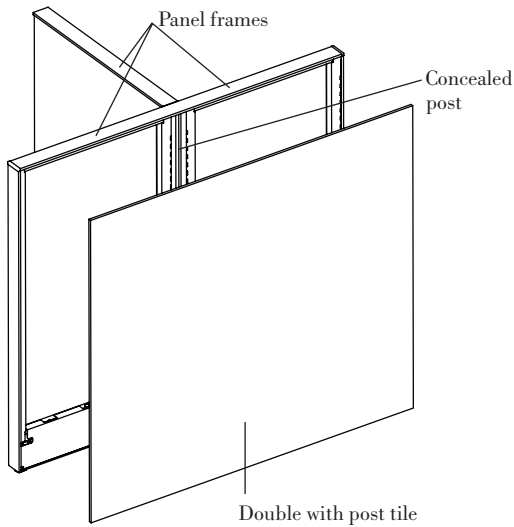

Centered Tile Application

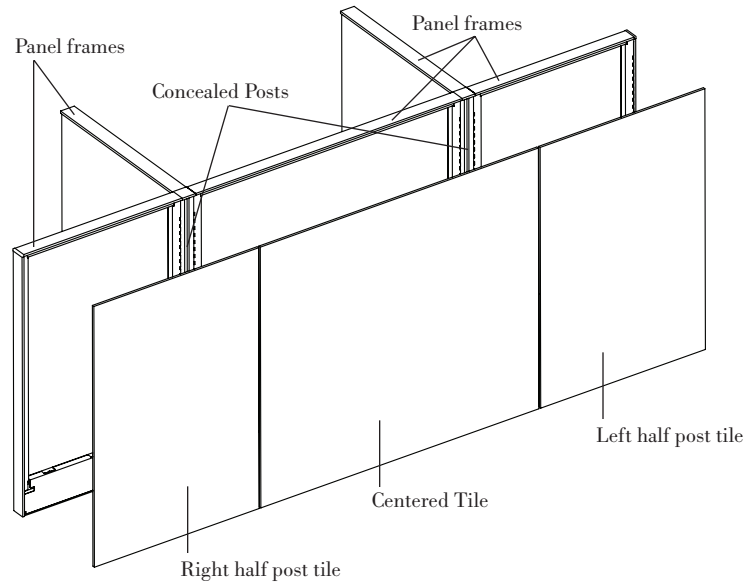

Double With Post Tile Plan View

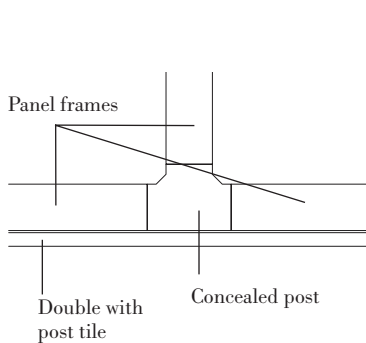

Centered Tile Plan View

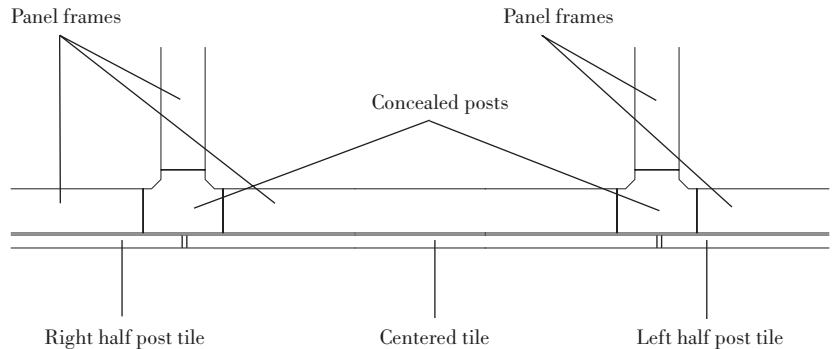



Concealed Post

Monolithic Panel Half Post Fabric Inserts

Worksurface Height, 28" and 42" High

Dividends Horizon

| description | w* | w | h | d | pattern no. | 10 | 15 | 20 | 25 | 30 | 35 | 40 | 45 |
|--|---------|-----------|-----------|----------------------|----------------------|--------|--------|--------|--------|--------|--------|--------|--------|
| Worksurface Height Concealed Post Monolithic Panel Half Post Fabric Inserts  | 15" | 16 1/2" | 27 1/4" | 7/16" | DP1SOWH15()F | \$106. | \$109. | \$115. | \$119. | \$120. | \$123. | \$124. | \$128. |
| | 18" | 19 1/2" | 27 1/4" | 7/16" | DP1SOWH18()F | 120. | 123. | 130. | 133. | 134. | 137. | 139. | 142. |
| | 24" | 25 1/2" | 27 1/4" | 7/16" | DP1SOWH24()F | 132. | 136. | 141. | 145. | 148. | 151. | 152. | 156. |
| | 30" | 31 1/2" | 27 1/4" | 7/16" | DP1SOWH30()F | 144. | 148. | 154. | 157. | 162. | 166. | 168. | 173. |
| | 36" | 37 1/2" | 27 1/4" | 7/16" | DP1SOWH36()F | 155. | 161. | 170. | 173. | 176. | 179. | 182. | 186. |
| | 42" | 43 1/2" | 27 1/4" | 7/16" | DP1SOWH42()F | 168. | 174. | 181. | 184. | 189. | 192. | 194. | 201. |
| | 48" | 49 1/2" | 27 1/4" | 7/16" | DP1SOWH48()F | 180. | 185. | 193. | 198. | 204. | 208. | 211. | 216. |
| 60" | 61 1/2" | 27 1/4" | 7/16" | DP1SOWH60()F | 189. | 194. | 206. | 210. | 215. | 218. | 222. | 227. | |
| 28" High Concealed Post Monolithic Panel Half Post Fabric Inserts (For 36"H Panel Frame)  | 15" | 16 1/2" | 33 13/16" | 7/16" | DP1SO2815()F | 107. | 110. | 94. | 96. | 99. | 101. | 101. | 103. |
| | 18" | 19 1/2" | 33 13/16" | 7/16" | DP1SO2818()F | 123. | 128. | 118. | 121. | 124. | 127. | 128. | 132. |
| | 24" | 25 1/2" | 33 13/16" | 7/16" | DP1SO2824()F | 139. | 142. | 142. | 145. | 149. | 152. | 153. | 156. |
| | 30" | 31 1/2" | 33 13/16" | 7/16" | DP1SO2830()F | 153. | 157. | 167. | 171. | 175. | 178. | 180. | 184. |
| | 36" | 37 1/2" | 33 13/16" | 7/16" | DP1SO2836()F | 170. | 175. | 189. | 193. | 199. | 202. | 207. | 212. |
| | 42" | 43 1/2" | 33 13/16" | 7/16" | DP1SO2842()F | 184. | 188. | 215. | 218. | 224. | 228. | 231. | 237. |
| | 48" | 49 1/2" | 33 13/16" | 7/16" | DP1SO2848()F | 199. | 206. | 215. | 219. | 225. | 228. | 233. | 238. |
| 60" | 61 1/2" | 33 13/16" | 7/16" | DP1SO2860()F | 212. | 217. | 228. | 231. | 238. | 243. | 246. | 254. | |
| 42" High Concealed Post Monolithic Panel Half Post Fabric Inserts  | 15" | 16 1/2" | 41 3/16" | 7/16" | DP1SO4215()F | 110. | 114. | 121. | 121. | 127. | 130. | 132. | 134. |
| | 18" | 19 1/2" | 41 3/16" | 7/16" | DP1SO4218()F | 131. | 134. | 140. | 141. | 147. | 149. | 152. | 154. |
| | 24" | 25 1/2" | 41 3/16" | 7/16" | DP1SO4224()F | 148. | 151. | 161. | 162. | 168. | 172. | 174. | 178. |
| | 30" | 31 1/2" | 41 3/16" | 7/16" | DP1SO4230()F | 167. | 172. | 180. | 182. | 187. | 190. | 193. | 199. |
| | 36" | 37 1/2" | 41 3/16" | 7/16" | DP1SO4236()F | 184. | 189. | 199. | 202. | 209. | 212. | 216. | 220. |
| | 42" | 43 1/2" | 41 3/16" | 7/16" | DP1SO4242()F | 202. | 209. | 219. | 223. | 228. | 233. | 236. | 243. |
| | 48" | 49 1/2" | 41 3/16" | 7/16" | DP1SO4248()F | 220. | 227. | 238. | 243. | 249. | 254. | 258. | 264. |
| 60" | 61 1/2" | 41 3/16" | 7/16" | DP1SO4260()F | 235. | 243. | 255. | 259. | 265. | 271. | 277. | 283. | |

w* = nominal width
 Dimensions listed under w h d are actual to the nearest 1/16"



| Ordering Information | Order Code | Included with: | Options |
|---|---|---|---|
| Concealed Post Monolithic Panel Fabric Inserts 1. Pattern Number 2. Fabric | Concealed Post Monolithic Panel Fabric Inserts <i>Example:</i> DP1SO2818CEF <hr/> DP1SO Pattern Number <hr/> 2818 <hr/> CE Center left, End Right <hr/> F Tile to Floor <hr/> W351-3 Foundation Corn Silk Fabric | Concealed Post Monolithic Panel Fabric Inserts • Attachment Clips | Concealed Post Monolithic Panel Fabric Inserts Configuration: (CE) = Left Half Post: Tile ends in the center of the post on the left and at the right side of the panel frame. (EC) = Right Half Post: Tile ends in the center of the post on the right and at the left side of the panel frame. |

Concealed Post

Monolithic Panel Half Post Fabric Inserts

50", 57" and 64" High

Dividends Horizon



| description | w* | w | h | d | pattern no. | 10 | 15 | 20 | 25 | 30 | 35 | 40 | 45 |
|---|---------|----------|----------|---------------|---------------|--------|--------|--------|--------|--------|--------|--------|--------|
| 50" High Concealed Post Monolithic Panel Half Post Fabric Inserts  | 15" | 16 1/2" | 48 1/2" | 7/16" | DP1SO5015()F | \$115. | \$118. | \$123. | \$126. | \$130. | \$132. | \$134. | \$137. |
| | 18" | 19 1/2" | 48 1/2" | 7/16" | DP1SO5018()F | 137. | 139. | 146. | 149. | 152. | 155. | 157. | 163. |
| | 24" | 25 1/2" | 48 1/2" | 7/16" | DP1SO5024()F | 156. | 162. | 171. | 173. | 178. | 180. | 183. | 187. |
| | 30" | 31 1/2" | 48 1/2" | 7/16" | DP1SO5030()F | 179. | 183. | 191. | 194. | 201. | 206. | 209. | 214. |
| | 36" | 37 1/2" | 48 1/2" | 7/16" | DP1SO5036()F | 200. | 206. | 215. | 219. | 225. | 229. | 233. | 240. |
| | 42" | 43 1/2" | 48 1/2" | 7/16" | DP1SO5042()F | 220. | 227. | 238. | 242. | 251. | 254. | 258. | 264. |
| | 48" | 49 1/2" | 48 1/2" | 7/16" | DP1SO5048()F | 242. | 249. | 261. | 265. | 274. | 279. | 283. | 290. |
| 60" | 61 1/2" | 48 1/2" | 7/16" | DP1SO5060()F | 260. | 266. | 281. | 285. | 292. | 298. | 303. | 311. | |
| 57" High Concealed Post Monolithic Panel Half Post Fabric Inserts  | 15" | 16 1/2" | 55 3/8" | 7/16" | DP1SO5715()F | 119. | 122. | 128. | 130. | 133. | 136. | 138. | 141. |
| | 18" | 19 1/2" | 55 3/8" | 7/16" | DP1SO5718()F | 142. | 147. | 153. | 155. | 159. | 164. | 167. | 172. |
| | 24" | 25 1/2" | 55 3/8" | 7/16" | DP1SO5724()F | 168. | 173. | 180. | 182. | 187. | 190. | 193. | 199. |
| | 30" | 31 1/2" | 55 3/8" | 7/16" | DP1SO5730()F | 190. | 196. | 207. | 210. | 215. | 219. | 223. | 228. |
| | 36" | 37 1/2" | 55 3/8" | 7/16" | DP1SO5736()F | 215. | 222. | 231. | 236. | 242. | 248. | 252. | 258. |
| | 42" | 43 1/2" | 55 3/8" | 7/16" | DP1SO5742()F | 240. | 246. | 258. | 262. | 270. | 275. | 280. | 286. |
| | 48" | 49 1/2" | 55 3/8" | 7/16" | DP1SO5748()F | 263. | 271. | 284. | 289. | 297. | 303. | 308. | 316. |
| 60" | 61 1/2" | 55 3/8" | 7/16" | DP1SO5760()F | 284. | 291. | 307. | 312. | 320. | 326. | 331. | 342. | |
| 64" High Concealed Post Monolithic Panel Half Post Fabric Inserts  | 15" | 16 1/2" | 63 1/16" | 7/16" | DP1SO6415()F | 120. | 122. | 130. | 133. | 135. | 138. | 139. | 145. |
| | 18" | 19 1/2" | 63 1/16" | 7/16" | DP1SO6418()F | 147. | 150. | 157. | 163. | 167. | 171. | 173. | 178. |
| | 24" | 25 1/2" | 63 1/16" | 7/16" | DP1SO6424()F | 176. | 180. | 188. | 191. | 196. | 201. | 204. | 211. |
| | 30" | 31 1/2" | 63 1/16" | 7/16" | DP1SO6430()F | 202. | 209. | 218. | 223. | 228. | 233. | 236. | 243. |
| | 36" | 37 1/2" | 63 1/16" | 7/16" | DP1SO6436()F | 229. | 236. | 248. | 254. | 260. | 264. | 269. | 277. |
| | 42" | 43 1/2" | 63 1/16" | 7/16" | DP1SO6442()F | 258. | 265. | 279. | 283. | 290. | 296. | 301. | 309. |
| | 48" | 49 1/2" | 63 1/16" | 7/16" | DP1SO6448()F | 285. | 293. | 308. | 314. | 322. | 328. | 333. | 343. |
| 60" | 61 1/2" | 63 1/16" | 7/16" | DP1SO6460()F | 309. | 318. | 332. | 338. | 350. | 356. | 362. | 370. | |

w* = nominal width
Dimensions listed under w h d are actual to the nearest 1/16"

| Ordering Information | Order Code | Included with: | Options |
|---|--|---|---|
| Concealed Post Monolithic Panel Fabric Inserts 1. Pattern Number 2. Fabric | Concealed Post Monolithic Panel Fabric Inserts <i>Example:</i> DP1SO5718CEF | Concealed Post Monolithic Panel Fabric Inserts • Attachment Clips | Concealed Post Monolithic Panel Fabric Inserts Configuration: (CE) = Left Half Post: Tile ends in the center of the post on the left and at the right side of the panel frame. (EC) = Right Half Post: Tile ends in the center of the post on the right and at the left side of the panel frame. |
| | DP1SO Pattern Number | | |
| | 5718 | | |
| | CE Center left, End Right | | |
| | F Tile to Floor | | |
| | W351-3 Foundation Corn Silk Fabric | | |

Alternative Planning

Monolithic Panel Half Post Laminate Inserts
Worksurface Height, 28" and 42" High

| description | w* | w | h | d | pattern no. | list |
|---|-----|---------|-----------|-------|---------------|--------|
| Worksurface Height Concealed Post | 15" | 16 1/2" | 27 1/4" | 7/16" | DP3L1WH15()F | \$181. |
| Monolithic Panel Half Post | 18" | 19 1/2" | 27 1/4" | 7/16" | DP3L1WH18()F | 208. |
| Laminate Inserts | 24" | 25 1/2" | 27 1/4" | 7/16" | DP3L1WH24()F | 242. |
|  | 30" | 31 1/2" | 27 1/4" | 7/16" | DP3L1WH30()F | 261. |
| | 36" | 37 1/2" | 27 1/4" | 7/16" | DP3L1WH36()F | 312. |
| | 42" | 43 1/2" | 27 1/4" | 7/16" | DP3L1WH42()F | 317. |
| | 48" | 49 1/2" | 27 1/4" | 7/16" | DP3L1WH48()F | 418. |
| <hr/> | | | | | | |
| 28" High Concealed Post | 15" | 16 1/2" | 33 13/16" | 7/16" | DP3L12815()F | 181. |
| Monolithic Panel Half Post | 18" | 19 1/2" | 33 13/16" | 7/16" | DP3L12818()F | 208. |
| Laminate Inserts | 24" | 25 1/2" | 33 13/16" | 7/16" | DP3L12824()F | 242. |
| (For 36"H Panel Frame) | 30" | 31 1/2" | 33 13/16" | 7/16" | DP3L12830()F | 261. |
|  | 36" | 37 1/2" | 33 13/16" | 7/16" | DP3L12836()F | 312. |
| | 42" | 43 1/2" | 33 13/16" | 7/16" | DP3L12842()F | 317. |
| | 48" | 49 1/2" | 33 13/16" | 7/16" | DP3L12848()F | 418. |
| <hr/> | | | | | | |
| 42" High Concealed Post | 15" | 16 1/2" | 41 3/16" | 7/16" | DP3L14215()F | 242. |
| Monolithic Panel Half Post | 18" | 19 1/2" | 41 3/16" | 7/16" | DP3L14218()F | 270. |
| Laminate Inserts | 24" | 25 1/2" | 41 3/16" | 7/16" | DP3L14224()F | 312. |
|  | 30" | 31 1/2" | 41 3/16" | 7/16" | DP3L14230()F | 422. |
| | 36" | 37 1/2" | 41 3/16" | 7/16" | DP3L14236()F | 445. |
| | 42" | 43 1/2" | 41 3/16" | 7/16" | DP3L14242()F | 449. |
| | 48" | 49 1/2" | 41 3/16" | 7/16" | DP3L14248()F | 494. |

w* = nominal width



Dimensions listed under w h d are actual to the nearest 1/16"

| Ordering Information | Order Code | Included with: | Options |
|---|---|---|--|
| Concealed Post Monolithic Panel Laminate Inserts | Concealed Post Monolithic Panel Laminate Inserts | Concealed Post Monolithic Panel Laminate Inserts | Concealed Post Monolithic Panel Laminate Inserts |
| 1. Pattern Number | <i>Example:</i> DP3L14236CEF | • Attachment Clips | Finish Options: |
| 2. Laminate Finish | DP3L1 Pattern Number | | 114 Folkstone Grey |
| 3. Edgeband Finish | 4236 | | 117 Soft Grey |
| | CE Center left, End Right | | 118 Bright White |
| | F Tile to Floor | | 119 Pumice |
| | 118 Bright White Laminate | | Configuration: |
| | 118 Bright White Edgeband | | (CE) = Left Half Post: Tile ends in the center of the post on the left and at the right side of the panel frame. |
| | | | (EC) = Right Half Post: Tile ends in the center of the post on the right and at the left side of the panel frame. |

Concealed Post

Monolithic Panel Half Post Laminate Inserts

50" and 57" High

| description | w* | w | h | d | pattern no. | list |
|---|-----|---------|---------|-------|---------------|--------|
|  50" High Concealed Post Monolithic Panel Half Post Laminate Inserts | 15" | 16 1/2" | 48 1/2" | 7/16" | DP3L15015()F | \$262. |
| | 18" | 19 1/2" | 48 1/2" | 7/16" | DP3L15018()F | 314. |
| | 24" | 25 1/2" | 48 1/2" | 7/16" | DP3L15024()F | 394. |
| | 30" | 31 1/2" | 48 1/2" | 7/16" | DP3L15030()F | 427. |
| | 36" | 37 1/2" | 48 1/2" | 7/16" | DP3L15036()F | 523. |
| | 42" | 43 1/2" | 48 1/2" | 7/16" | DP3L15042()F | 527. |
| | 48" | 49 1/2" | 48 1/2" | 7/16" | DP3L15048()F | 682. |
|  57" High Concealed Post Monolithic Panel Half Post Laminate Inserts | 15" | 16 1/2" | 55 3/8" | 7/16" | DP3L15715()F | 268. |
| | 18" | 19 1/2" | 55 3/8" | 7/16" | DP3L15718()F | 319. |
| | 24" | 25 1/2" | 55 3/8" | 7/16" | DP3L15724()F | 399. |
| | 30" | 31 1/2" | 55 3/8" | 7/16" | DP3L15730()F | 434. |
| | 36" | 37 1/2" | 55 3/8" | 7/16" | DP3L15736()F | 528. |
| | 42" | 43 1/2" | 55 3/8" | 7/16" | DP3L15742()F | 532. |
| | 48" | 49 1/2" | 55 3/8" | 7/16" | DP3L15748()F | 686. |

w* = nominal width
 Dimensions listed under w h d are actual to the nearest 1/16"



| Ordering Information | Order Code | Included with: | Options |
|--|--|---|--|
| Concealed Post Monolithic Panel Laminate Inserts 1. Pattern Number 2. Laminate Finish 3. Edgeband Finish | Concealed Post Monolithic Panel Laminate Inserts <i>Example:</i> DP3L15736CEF DP3L1 Pattern Number 5736 CE Center left, End Right F Tile to Floor 118 Bright White Laminate 118 Bright White Edgeband | Concealed Post Monolithic Panel Laminate Inserts <ul style="list-style-type: none"> Attachment Clips | Concealed Post Monolithic Panel Fabric Inserts Finish Options: 114 Folkstone Grey 117 Soft Grey 118 Bright White 119 Pumice Configuration: (CE) = Left Half Post: Tile ends in the center of the post on the left and at the right side of the panel frame. (EC) = Right Half Post: Tile ends in the center of the post on the right and at the left side of the panel frame. |

Concealed Post

Monolithic Panel Centered Fabric Inserts

Worksurface Height, 28" and 42" High

Dividends Horizon

| description | w* | w | d | h | pattern no. | 10 | 15 | 20 | 25 | 30 | 35 | 40 | 45 |
|---|-----|-----|-------|----------|---------------------|--------|--------|--------|--------|--------|--------|--------|--------|
| Worksurface Height Concealed Post | 15" | 18" | 7/16" | 27 1/4" | DP1SOWH15CCF | \$149. | \$152. | \$162. | \$163. | \$171. | \$173. | \$176. | \$180. |
| Monolithic Panel Centered Fabric Insert | 18" | 21" | 7/16" | 27 1/4" | DP1SOWH18CCF | 153. | 157. | 168. | 170. | 176. | 178. | 191. | 185. |
|  | 24" | 27" | 7/16" | 27 1/4" | DP1SOWH24CCF | 159. | 163. | 173. | 175. | 180. | 183. | 186. | 190. |
| | 30" | 33" | 7/16" | 27 1/4" | DP1SOWH30CCF | 164. | 170. | 178. | 180. | 185. | 188. | 191. | 196. |
| | 36" | 39" | 7/16" | 27 1/4" | DP1SOWH36CCF | 170. | 175. | 183. | 185. | 190. | 193. | 198. | 202. |
| | 42" | 45" | 7/16" | 27 1/4" | DP1SOWH42CCF | 175. | 179. | 187. | 190. | 194. | 200. | 204. | 209. |
| | 48" | 51" | 7/16" | 27 1/4" | DP1SOWH48CCF | 179. | 184. | 192. | 196. | 201. | 207. | 210. | 214. |
| | 60" | 63" | 7/16" | 27 1/4" | DP1SOWH60CCF | 188. | 193. | 204. | 209. | 214. | 217. | 220. | 226. |
| 28" High Concealed Post | 15" | 18" | 7/16" | 33 3/16" | DP1SO2815CCF | 161. | 167. | 176. | 178. | 183. | 185. | 188. | 193. |
| Monolithic Panel Centered Fabric Insert | 18" | 21" | 7/16" | 33 3/16" | DP1SO2818CCF | 168. | 174. | 182. | 184. | 189. | 191. | 194. | 201. |
| (For 36"H Panel Frame) | 24" | 27" | 7/16" | 33 3/16" | DP1SO2824CCF | 174. | 179. | 187. | 190. | 196. | 200. | 204. | 210. |
|  | 30" | 33" | 7/16" | 33 3/16" | DP1SO2830CCF | 180. | 185. | 193. | 198. | 204. | 208. | 211. | 216. |
| | 36" | 39" | 7/16" | 33 3/16" | DP1SO2836CCF | 186. | 191. | 201. | 206. | 211. | 214. | 217. | 223. |
| | 42" | 45" | 7/16" | 33 3/16" | DP1SO2842CCF | 191. | 198. | 208. | 212. | 217. | 222. | 225. | 230. |
| | 48" | 51" | 7/16" | 33 3/16" | DP1SO2848CCF | 199. | 206. | 214. | 218. | 224. | 228. | 231. | 237. |
| | 60" | 63" | 7/16" | 33 3/16" | DP1SO2860CCF | 211. | 217. | 227. | 231. | 237. | 242. | 246. | 253. |
| 42" High Concealed Post | 15" | 18" | 7/16" | 41 3/16" | DP1SO4215CCF | 176. | 180. | 188. | 190. | 196. | 201. | 204. | 211. |
| Monolithic Panel Centered Fabric Insert | 18" | 21" | 7/16" | 41 3/16" | DP1SO4218CCF | 183. | 187. | 196. | 200. | 207. | 211. | 213. | 219. |
|  | 24" | 27" | 7/16" | 41 3/16" | DP1SO4224CCF | 189. | 194. | 207. | 209. | 214. | 218. | 222. | 228. |
| | 30" | 33" | 7/16" | 41 3/16" | DP1SO4230CCF | 198. | 204. | 214. | 217. | 223. | 227. | 230. | 237. |
| | 36" | 39" | 7/16" | 41 3/16" | DP1SO4236CCF | 207. | 212. | 222. | 226. | 231. | 236. | 240. | 246. |
| | 42" | 45" | 7/16" | 41 3/16" | DP1SO4242CCF | 213. | 219. | 230. | 234. | 240. | 244. | 249. | 256. |
| | 48" | 51" | 7/16" | 41 3/16" | DP1SO4248CCF | 220. | 227. | 238. | 243. | 249. | 254. | 258. | 264. |
| | 60" | 63" | 7/16" | 41 3/16" | DP1SO4260CCF | 235. | 243. | 255. | 259. | 265. | 271. | 277. | 283. |

w* = nominal width



Dimensions listed under w h d are actual to the nearest 1/16"

| Ordering Information | Order Code | Included with: | Options |
|---|---|---|---|
| Concealed Post Monolithic Panel Fabric Inserts | Concealed Post Monolithic Panel Fabric Inserts | Concealed Post Monolithic Panel Fabric Inserts | Concealed Post Monolithic Panel Fabric Inserts |
| 1. Pattern Number | <i>Example:</i> DP1SO2818CCF | • Attachment Clips | |
| 2. Fabric | DP1SO Pattern Number 2818 | | |
| | CC Center Left, Center Right | | |
| | F Tile to Floor | | |
| | W351-3 Foundation Corn Silk Fabric | | |

Concealed Post

Monolithic Panel Centered Fabric Inserts

50", 57" and 64" High

| description | w* | w | h | d | pattern no. | 10 | 15 | 20 | 25 | 30 | 35 | 40 | 45 |
|---|-----|-----|----------|-------|---------------------|--------|--------|--------|--------|--------|--------|--------|--------|
| 50" High Concealed Post | 15" | 18" | 48 1/2" | 7/16" | DP1SO5015CCF | \$189. | \$192. | \$206. | \$209. | \$213. | \$217. | \$220. | \$227. |
| Monolithic Panel Centered Fabric Insert | 18" | 21" | 48 1/2" | 7/16" | DP1SO5018CCF | 199. | 202. | 214. | 218. | 223. | 227. | 230. | 237. |
|  | 24" | 27" | 48 1/2" | 7/16" | DP1SO5024CCF | 208. | 213. | 224. | 227. | 233. | 237. | 242. | 249. |
| | 30" | 33" | 48 1/2" | 7/16" | DP1SO5030CCF | 216. | 222. | 233. | 237. | 243. | 248. | 253. | 259. |
| | 36" | 39" | 48 1/2" | 7/16" | DP1SO5036CCF | 225. | 230. | 242. | 248. | 254. | 258. | 262. | 269. |
| | 42" | 45" | 48 1/2" | 7/16" | DP1SO5042CCF | 233. | 241. | 253. | 257. | 263. | 268. | 274. | 281. |
| | 48" | 45" | 48 1/2" | 7/16" | DP1SO5048CCF | 242. | 251. | 261. | 266. | 274. | 279. | 284. | 290. |
| | 60" | 63" | 48 1/2" | 7/16" | DP1SO5060CCF | 260. | 268. | 281. | 286. | 293. | 298. | 305. | 312. |
| 57" High Concealed Post | 15" | 18" | 55 3/8" | 7/16" | DP1SO5715CCF | 201. | 209. | 219. | 223. | 228. | 233. | 236. | 242. |
| Monolithic Panel Centered Fabric Insert | 18" | 21" | 55 3/8" | 7/16" | DP1SO5718CCF | 212. | 218. | 230. | 234. | 240. | 244. | 249. | 255. |
|  | 24" | 27" | 55 3/8" | 7/16" | DP1SO5724CCF | 223. | 229. | 241. | 245. | 253. | 257. | 260. | 266. |
| | 30" | 33" | 55 3/8" | 7/16" | DP1SO5730CCF | 233. | 240. | 253. | 257. | 263. | 268. | 272. | 280. |
| | 36" | 39" | 55 3/8" | 7/16" | DP1SO5736CCF | 243. | 251. | 263. | 268. | 275. | 280. | 285. | 291. |
| | 42" | 45" | 55 3/8" | 7/16" | DP1SO5742CCF | 255. | 261. | 274. | 280. | 287. | 291. | 296. | 305. |
| | 48" | 51" | 55 3/8" | 7/16" | DP1SO5748CCF | 264. | 271. | 285. | 290. | 298. | 303. | 309. | 317. |
| | 60" | 63" | 55 3/8" | 7/16" | DP1SO5760CCF | 285. | 292. | 308. | 314. | 321. | 327. | 332. | 343. |
| 64" High Concealed Post | 15" | 18" | 63 1/16" | 7/16" | DP1SO6415CCF | 218. | 223. | 234. | 240. | 244. | 251. | 254. | 261. |
| Monolithic Panel Centered Fabric Insert | 18" | 21" | 63 1/16" | 7/16" | DP1SO6418CCF | 229. | 235. | 246. | 253. | 258. | 263. | 266. | 275. |
|  | 24" | 27" | 63 1/16" | 7/16" | DP1SO6424CCF | 241. | 246. | 259. | 264. | 270. | 277. | 281. | 288. |
| | 30" | 33" | 63 1/16" | 7/16" | DP1SO6430CCF | 253. | 259. | 271. | 278. | 284. | 289. | 293. | 302. |
| | 36" | 39" | 63 1/16" | 7/16" | DP1SO6436CCF | 263. | 271. | 284. | 289. | 297. | 303. | 308. | 316. |
| | 42" | 45" | 63 1/16" | 7/16" | DP1SO6442CCF | 275. | 283. | 296. | 302. | 310. | 316. | 321. | 329. |
| | 48" | 51" | 63 1/16" | 7/16" | DP1SO6448CCF | 286. | 295. | 309. | 315. | 323. | 329. | 334. | 344. |
| | 60" | 63" | 63 1/16" | 7/16" | DP1SO6460CCF | 309. | 319. | 333. | 342. | 352. | 357. | 363. | 371. |



w* = nominal width
Dimensions listed under w h d are actual to the nearest 1/16"

| Ordering Information | Order Code | Included with: | Options |
|---|---|---|---|
| Concealed Post Monolithic Panel Fabric Inserts | Concealed Post Monolithic Panel Fabric Inserts | Concealed Post Monolithic Panel Fabric Inserts | Concealed Post Monolithic Panel Fabric Inserts |
| 1. Pattern Number | <i>Example:</i> DP1SO5718CCF | • Attachment Clips | |
| 2. Fabric | DP1SO Pattern Number | | |
| | 5718 | | |
| | CC Center Left, Center Right | | |
| | F Tile to Floor | | |
| | W351-3 Foundation Corn Silk Fabric | | |

Concealed Post

Monolithic Panel Centered Laminate Inserts



Worksurface Height, 28" and 42" High

| description | w* | w | h | d | pattern no. | list |
|---|-----|-----|-----------|-------|---------------------|--------|
| Worksurface Height Concealed Post | 15" | 18" | 27 1/4" | 7/16" | DP3L1WH15CCF | \$181. |
| Monolithic Panel Centered Laminate Insert | 18" | 21" | 27 1/4" | 7/16" | DP3L1WH18CCF | 208. |
|  | 24" | 27" | 27 1/4" | 7/16" | DP3L1WH24CCF | 242. |
| | 30" | 33" | 27 1/4" | 7/16" | DP3L1WH30CCF | 261. |
| | 36" | 39" | 27 1/4" | 7/16" | DP3L1WH36CCF | 312. |
| | 42" | 45" | 27 1/4" | 7/16" | DP3L1WH42CCF | 317. |
| | 48" | 51" | 27 1/4" | 7/16" | DP3L1WH48CCF | 418. |
| 28" High Concealed Post | 15" | 18" | 33 13/16" | 7/16" | DP3L12815CCF | 181. |
| Monolithic Panel Centered Laminate Insert | 18" | 21" | 33 13/16" | 7/16" | DP3L12818CCF | 208. |
| (For 36"H Panel Frame) | 24" | 27" | 33 13/16" | 7/16" | DP3L12824CCF | 242. |
|  | 30" | 33" | 33 13/16" | 7/16" | DP3L12830CCF | 261. |
| | 36" | 39" | 33 13/16" | 7/16" | DP3L12836CCF | 312. |
| | 42" | 45" | 33 13/16" | 7/16" | DP3L12842CCF | 317. |
| | 48" | 51" | 33 13/16" | 7/16" | DP3L12848CCF | 418. |
| 42" High Concealed Post | 15" | 18" | 41 3/16" | 7/16" | DP3L14215CCF | 242. |
| Monolithic Panel Centered Laminate Insert | 18" | 21" | 41 3/16" | 7/16" | DP3L14218CCF | 270. |
|  | 24" | 27" | 41 3/16" | 7/16" | DP3L14224CCF | 312. |
| | 30" | 33" | 41 3/16" | 7/16" | DP3L14230CCF | 422. |
| | 36" | 39" | 41 3/16" | 7/16" | DP3L14236CCF | 445. |
| | 42" | 45" | 41 3/16" | 7/16" | DP3L14242CCF | 449. |
| | 48" | 51" | 41 3/16" | 7/16" | DP3L14248CCF | 494. |

w* = nominal width
 Dimensions listed under w h d are actual to the nearest 1/16"

| Ordering Information | Order Code | Included with: | Options |
|---|---|---|---|
| Concealed Post Monolithic Panel Laminate Inserts | Concealed Post Monolithic Panel Laminate Inserts | Concealed Post Monolithic Panel Laminate Inserts | Concealed Post Monolithic Panel Laminate Inserts |
| 1. Pattern Number | <i>Example:</i> DP3L14236CCF | • Attachment Clips | Finish Options: |
| 2. Laminate Finish | DP3L1 Pattern Number | | 114 Folkstone Grey |
| 3. Edgeband Finish | 4236 | | 117 Soft Grey |
| | CC Center Left, Center Right | | 118 Bright White |
| | F Tile to Floor | | 119 Pumice |
| | 118 Bright White Laminate | | |
| | 118 Bright White Edgeband | | |

Concealed Post
Monolithic Panel Centered Laminate Inserts
 50" and 57" High

| description | w * | w | h | d | pattern no. | list |
|---|-----|-----|---------|-------|--------------|--------|
| 50" High Concealed Post Monolithic Panel Centered Laminate Insert  | 15" | 18" | 48 1/2" | 7/16" | DP3L15015CCF | \$262. |
| | 18" | 21" | 48 1/2" | 7/16" | DP3L15018CCF | 314. |
| | 24" | 27" | 48 1/2" | 7/16" | DP3L15024CCF | 394. |
| | 30" | 33" | 48 1/2" | 7/16" | DP3L15030CCF | 427. |
| | 36" | 39" | 48 1/2" | 7/16" | DP3L15036CCF | 523. |
| | 42" | 45" | 48 1/2" | 7/16" | DP3L15042CCF | 527. |
| | 48" | 51" | 48 1/2" | 7/16" | DP3L15048CCF | 682. |
| 57" High Concealed Post Monolithic Panel Centered Laminate Insert  | 15" | 18" | 55 3/8" | 7/16" | DP3L15715CCF | 268. |
| | 18" | 21" | 55 3/8" | 7/16" | DP3L15718CCF | 319. |
| | 24" | 27" | 55 3/8" | 7/16" | DP3L15724CCF | 399. |
| | 30" | 33" | 55 3/8" | 7/16" | DP3L15730CCF | 434. |
| | 36" | 39" | 55 3/8" | 7/16" | DP3L15736CCF | 528. |
| | 42" | 45" | 55 3/8" | 7/16" | DP3L15742CCF | 532. |
| | 48" | 51" | 55 3/8" | 7/16" | DP3L15748CCF | 686. |

w* = nominal width
 Dimensions listed under w h d are actual to the nearest 1/16"

| Ordering Information | Order Code | Included with: | Options |
|--|---|---|--|
| Concealed Post Monolithic Panel Laminate Inserts 1. Pattern Number 2. Laminate Finish 3. Edgeband Finish | Concealed Post Monolithic Panel Laminate Inserts <i>Example:</i> DP3L15736CCF DP3L1 Pattern Number 5736 CC Center Left, Center Right F Tile to Floor 118 Bright White Laminate 118 Bright White Edgeband | Concealed Post Monolithic Panel Laminate Inserts • Attachment Clips | Concealed Post Monolithic Panel Laminate Inserts Finish Options: 114 Folkstone Grey 117 Soft Grey 118 Bright White 119 Pumice |

Monolithic Panel Double with Post Fabric Inserts
Worksurface Height, 28" and 42" High

| description | w* | w | h | d | pattern no. | 10 | 15 | 20 | 25 | 30 | 35 | 40 | 45 |
|-----------------------------------|-----|-----|---------|-------|----------------------|--------|--------|--------|--------|--------|--------|--------|--------|
| Worksurface Height Concealed Post | 30" | 33" | 27 1/4" | 7/16" | DP1SOWH30EPEF | \$149. | \$154. | \$162. | \$164. | \$171. | \$173. | \$175. | \$179. |
| Monolithic Panel Double with | 36" | 39" | 27 1/4" | 7/16" | DP1SOWH36EPEF | 167. | 173. | 180. | 182. | 187. | 190. | 192. | 199. |
| Post Fabric Insert | 48" | 51" | 27 1/4" | 7/16" | DP1SOWH48EPEF | 182. | 187. | 196. | 200. | 207. | 210. | 213. | 218. |
| | 60" | 63" | 27 1/4" | 7/16" | DP1SOWH60EPEF | 199. | 206. | 215. | 218. | 224. | 228. | 231. | 238. |



| | | | | | | | | | | | | | |
|------------------------------|-----|-----|-----------|-------|----------------------|------|------|------|------|------|------|------|------|
| 28" High Concealed Post | 30" | 33" | 33 13/16" | 7/16" | DP1SO2830EPEF | 118. | 120. | 127. | 131. | 133. | 136. | 137. | 140. |
| Monolithic Panel Double with | 36" | 39" | 33 13/16" | 7/16" | DP1SO2836EPEF | 159. | 163. | 173. | 176. | 180. | 183. | 185. | 189. |
| Post Fabric Insert | 48" | 51" | 33 13/16" | 7/16" | DP1SO2848EPEF | 200. | 207. | 216. | 220. | 226. | 230. | 234. | 240. |
| (For 36" h panel frame) | 60" | 63" | 33 13/16" | 7/16" | DP1SO2860EPEF | 242. | 249. | 261. | 265. | 274. | 279. | 283. | 289. |



| | | | | | | | | | | | | | |
|------------------------------|-----|-----|----------|-------|----------------------|------|------|------|------|------|------|------|------|
| 42" High Concealed Post | 30" | 33" | 41 3/16" | 7/16" | DP1SO4230EPEF | 146. | 150. | 157. | 162. | 164. | 168. | 171. | 175. |
| Monolithic Panel Double with | 36" | 39" | 41 3/16" | 7/16" | DP1SO4236EPEF | 185. | 190. | 200. | 206. | 209. | 213. | 216. | 222. |
| Post Fabric Insert | 48" | 51" | 41 3/16" | 7/16" | DP1SO4248EPEF | 224. | 230. | 242. | 246. | 253. | 257. | 261. | 268. |
| | 60" | 63" | 41 3/16" | 7/16" | DP1SO4260EPEF | 263. | 271. | 284. | 289. | 296. | 302. | 308. | 316. |



w* = nominal width

Dimensions listed under w h d are actual to the nearest 1/16"

| Ordering Information | Order Code | Included with: | Options |
|---|---|---|---|
| Concealed Post Monolithic Panel Fabric Inserts | Concealed Post Monolithic Panel Fabric Inserts | Concealed Post Monolithic Panel Fabric Inserts | Concealed Post Monolithic Panel Fabric Inserts |
| 1. Pattern Number | <i>Example:</i> DP1SO2836EPEF | • Attachment Clips | |
| 2. Fabric | DP1SO Pattern Number | | |
| | 2836 | | |
| | EPE End, Post, End | | |
| | F Tile to Floor | | |
| | W351-3 Foundation Corn Silk Fabric | | |

Concealed Post

Monolithic Panel Double with Post Fabric Inserts

50", 57" and 64" High

| description | w* | w | h | d | pattern no. | 10 | 15 | 20 | 25 | 30 | 35 | 40 | 45 |
|---|-----|-----|---------|-------|----------------------|--------|--------|--------|--------|--------|--------|--------|--------|
| 50" High Concealed Post | 30" | 33" | 48 1/2" | 7/16" | DP1SO5030EPEF | \$174. | \$177. | \$185. | \$190. | \$193. | \$198. | \$202. | \$208. |
| Monolithic Panel Double with Post Fabric Insert | 36" | 39" | 48 1/2" | 7/16" | DP1SO5036EPEF | 210. | 215. | 225. | 230. | 236. | 240. | 245. | 252. |
| | 48" | 51" | 48 1/2" | 7/16" | DP1SO5048EPEF | 245. | 253. | 264. | 270. | 278. | 282. | 287. | 293. |
| | 60" | 63" | 48 1/2" | 7/16" | DP1SO5060EPEF | 282. | 290. | 305. | 310. | 319. | 323. | 330. | 337. |



| | | | | | | | | | | | | | |
|---|-----|-----|---------|-------|----------------------|------|------|------|------|------|------|------|------|
| 57" High Concealed Post | 30" | 33" | 55 3/8" | 7/16" | DP1SO5730EPEF | 200. | 207. | 216. | 220. | 226. | 228. | 234. | 240. |
| Monolithic Panel Double with Post Fabric Insert | 36" | 39" | 55 3/8" | 7/16" | DP1SO5736EPEF | 234. | 241. | 253. | 258. | 264. | 268. | 274. | 281. |
| | 48" | 51" | 55 3/8" | 7/16" | DP1SO5748EPEF | 266. | 275. | 288. | 293. | 302. | 307. | 312. | 320. |
| | 60" | 63" | 55 3/8" | 7/16" | DP1SO5760EPEF | 301. | 310. | 324. | 331. | 342. | 347. | 354. | 362. |



| | | | | | | | | | | | | | |
|---|-----|-----|----------|-------|----------------------|------|------|------|------|------|------|------|------|
| 64" High Concealed Post | 30" | 33" | 63 1/16" | 7/16" | DP1SO6430EPEF | 255. | 261. | 275. | 280. | 287. | 291. | 297. | 305. |
| Monolithic Panel Double with Post Fabric Insert | 36" | 39" | 63 1/16" | 7/16" | DP1SO6436EPEF | 271. | 280. | 293. | 298. | 308. | 312. | 318. | 326. |
| | 48" | 51" | 63 1/16" | 7/16" | DP1SO6448EPEF | 288. | 297. | 312. | 318. | 327. | 332. | 337. | 347. |





w* = nominal width

Dimensions listed under w h d are actual to the nearest 1/16"

| Ordering Information | Order Code | Included with: | Options |
|---|---|---|---|
| Concealed Post Monolithic Panel Fabric Inserts | Concealed Post Monolithic Panel Fabric Inserts | Concealed Post Monolithic Panel Fabric Inserts | Concealed Post Monolithic Panel Fabric Inserts |
| 1. Pattern Number | <i>Example:</i> DP1SO5736EPEF | • Attachment Clips | |
| 2. Fabric | DP1SO Pattern Number | | |
| | 5736 | | |
| | EPE End, Post, End | | |
| | F Tile to Floor | | |
| | W351-3 Foundation Corn Silk Fabric | | |

Monolithic Panel Double with Post Laminate Inserts
Worksurface Height, 28" and 42" High

| description | w* | w | h | d | pattern no. | list |
|---|-----|-----|---------|-------|----------------------|--------|
| Worksurface Height Concealed Post | 30" | 33" | 27 1/4" | 7/16" | DP3L1WH30EPEF | \$261. |
|  Monolithic Panel Double with Post Laminate Insert | 36" | 39" | 27 1/4" | 7/16" | DP3L1WH36EPEF | 312. |
| | 48" | 51" | 27 1/4" | 7/16" | DP3L1WH48EPEF | 321. |
| | 60" | 63" | 27 1/4" | 7/16" | DP3L1WH60EPEF | 421. |
| | 72" | 75" | 27 1/4" | 7/16" | DP3L1WH72EPEF | 431. |
| | 84" | 87" | 27 1/4" | 7/16" | DP3L1WH84EPEF | 439. |

| | | | | | | |
|--|-----|-----|-----------|-------|----------------------|------|
| 28" High Concealed Post | 30" | 33" | 33 13/16" | 7/16" | DP3L12830EPEF | 391. |
|  Monolithic Panel Double with Post Laminate Insert (For 36"h panel frame) | 36" | 39" | 33 13/16" | 7/16" | DP3L12836EPEF | 395. |
| | 48" | 51" | 33 13/16" | 7/16" | DP3L12848EPEF | 418. |
| | 60" | 63" | 33 13/16" | 7/16" | DP3L12860EPEF | 679. |
| | 72" | 75" | 33 13/16" | 7/16" | DP3L12872EPEF | 688. |
| | 84" | 87" | 33 13/16" | 7/16" | DP3L12884EPEF | 697. |

| | | | | | | |
|---|-----|-----|----------|-------|----------------------|------|
| 42" High Concealed Post | 30" | 33" | 41 3/16" | 7/16" | DP3L14230EPEF | 422. |
|  Monolithic Panel Double with Post Laminate Insert | 36" | 39" | 41 3/16" | 7/16" | DP3L14236EPEF | 445. |
| | 48" | 51" | 41 3/16" | 7/16" | DP3L14248EPEF | 461. |
| | 60" | 63" | 41 3/16" | 7/16" | DP3L14260EPEF | 685. |
| | 72" | 75" | 41 3/16" | 7/16" | DP3L14272EPEF | 693. |
| | 84" | 87" | 41 3/16" | 7/16" | DP3L14284EPEF | 702. |

w* = nominal width

Dimensions listed under w h d are actual to the nearest 1/16"

| Ordering Information | Order Code | Included with: | Options |
|--|--|---|--|
| Concealed Post Monolithic Panel Laminate Inserts 1. Pattern Number 2. Laminate Finish 3. Edgeband Finish | Concealed Post Monolithic Panel Laminate Inserts <i>Example:</i> DP3L14236EPEF <hr/> DP3L1 Pattern Number 4236 <hr/> EPE End, Post, End <hr/> F Tile to Floor <hr/> 118 Bright White Laminate <hr/> 118 Bright White Edgeband | Concealed Post Monolithic Panel Laminate Inserts <ul style="list-style-type: none"> Attachment Clips | Concealed Post Monolithic Panel Laminate Inserts Finish Options: 114 Folkstone Grey 117 Soft Grey 118 Bright White 119 Pumice |

Concealed Post

Monolithic Panel Double with Post Laminate Inserts

50" and 57" High

| description | w * | w | h | d | pattern no. | list |
|--|-----|-----|---------|-------|----------------------|--------|
| 50" High Concealed Post Monolithic Panel Double with Post Laminate Insert  | 30" | 33" | 48 1/2" | 7/16" | DP3L15030EPEF | \$427. |
| | 36" | 39" | 48 1/2" | 7/16" | DP3L15036EPEF | 523. |
| | 48" | 51" | 48 1/2" | 7/16" | DP3L15048EPEF | 682. |
| | 60" | 63" | 48 1/2" | 7/16" | DP3L15060EPEF | 690. |
| | 72" | 75" | 48 1/2" | 7/16" | DP3L15072EPEF | 699. |
| | 84" | 87" | 48 1/2" | 7/16" | DP3L15084EPEF | 707. |

| | | | | | | |
|--|-----|-----|---------|-------|----------------------|------|
| 57" High Concealed Post Monolithic Panel Double with Post Laminate Insert  | 30" | 33" | 55 3/8" | 7/16" | DP3L15730EPEF | 434. |
| | 36" | 39" | 55 3/8" | 7/16" | DP3L15736EPEF | 528. |
| | 48" | 51" | 55 3/8" | 7/16" | DP3L15748EPEF | 686. |
| | 60" | 63" | 55 3/8" | 7/16" | DP3L15760EPEF | 695. |
| | 72" | 75" | 55 3/8" | 7/16" | DP3L15772EPEF | 703. |
| | 84" | 87" | 55 3/8" | 7/16" | DP3L15784EPEF | 712. |

w* = nominal width
 Dimensions listed under w h d are actual to the nearest 1/16"

| Ordering Information | Order Code | Included with: | Options |
|--|---|---|--|
| Concealed Post Monolithic Panel Laminate Inserts 1. Pattern Number 2. Laminate Finish 3. Edgeband Finish | Concealed Post Monolithic Panel Laminate Inserts Example: DP3L15736EPEF <hr/> DP3L1 Pattern Number <hr/> 5736 <hr/> EPE End, Post, End <hr/> F Tile to Floor <hr/> 118 Bright White Laminate <hr/> 118 Bright White Edgeband | Concealed Post Monolithic Panel Laminate Inserts • Attachment Clips | Concealed Post Monolithic Panel Laminate Inserts Finish Options: 114 Folkstone Grey 117 Soft Grey 118 Bright White 119 Pumice |

Concealed Post
 Frameless Add Up
 Clear, Powder, Bronze and Grey Glass

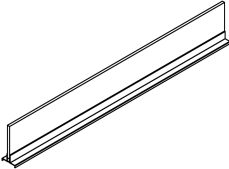
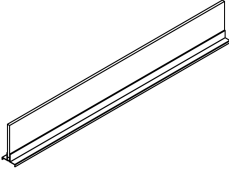
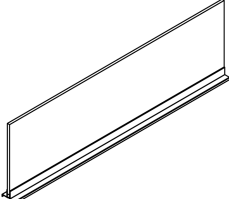
| description | w | d | h | pattern no. | list | Clear (TEMP) | Powder (GL13) Bronze (GL25) Grey (GL35) |
|---|---|------|------|---------------|---------------|--------------|---|
| Frameless Add Up, 7" High (For use with concealed post only)  | 51" | 3/4" | 7" | DP1AU0751()G | \$427. | \$479. | |
| | 57" | 3/4" | 7" | DP1AU0757()G | 463. | 521. | |
| | 63" | 3/4" | 7" | DP1AU0763()G | 498. | 563. | |
| | 69" | 3/4" | 7" | DP1AU0769()G | 535. | 604. | |
| | 75" | 3/4" | 7" | DP1AU0775()G | 571. | 647. | |
| | 81" | 3/4" | 7" | DP1AU0781()G | 618. | 704. | |
| | 87" | 3/4" | 7" | DP1AU0787()G | 668. | 760. | |
| | 93" | 3/4" | 7" | DP1AU0793()G | 721. | 823. | |
| | 99" | 3/4" | 7" | DP1AU0799()G | 779. | 888. | |
| | Shortened Frameless Add Up, 7" High (For use with concealed post only)  | 50" | 3/4" | 7" | DP1AU0750()G | 427. | 479. |
| 56" | | 3/4" | 7" | DP1AU0756()G | 463. | 521. | |
| 62" | | 3/4" | 7" | DP1AU0762()G | 498. | 563. | |
| 68" | | 3/4" | 7" | DP1AU0768()G | 535. | 604. | |
| 74" | | 3/4" | 7" | DP1AU0774()G | 571. | 647. | |
| 80" | | 3/4" | 7" | DP1AU0780()G | 565. | 704. | |
| 86" | | 3/4" | 7" | DP1AU0786()G | 668. | 760. | |
| 92" | | 3/4" | 7" | DP1AU0792()G | 721. | 823. | |
| 98" | | 3/4" | 7" | DP1AU0798()G | 779. | 888. | |
| Frameless Add Up, 14" High (For use with concealed post only)  | | 51" | 3/4" | 14" | DP1AU1451()G | 603. | 709. |
| | 57" | 3/4" | 14" | DP1AU1457()G | 659. | 778. | |
| | 63" | 3/4" | 14" | DP1AU1463()G | 716. | 848. | |
| | 69" | 3/4" | 14" | DP1AU1469()G | 772. | 916. | |
| | 75" | 3/4" | 14" | DP1AU1475()G | 829. | 985. | |
| | 81" | 3/4" | 14" | DP1AU1481()G | 900. | 960. | |
| | 87" | 3/4" | 14" | DP1AU1487()G | 972. | 1,154. | |
| | 93" | 3/4" | 14" | DP1AU1493()G | 1,050. | 1,246. | |
| | 99" | 3/4" | 14" | DP1AU1499()G | 1,135. | 1,345. | |

Ordering Information

Frameless Add Up with Glass

1. Pattern number
2. Frame finish
3. Glass finish

End Cap

1. Pattern number
2. Paint finish

Order Code

Frameless Add Up with Glass

Example: **DP1AU0757VG**

DP1AU Frameless Add Up

07 7" High

57 57" Wide

V Full view

G Glass

117 Frame finish

TEMP Clear glass finish

Included with:

Frameless Add Up with Glass

- Attachment hardware
- Topway Trough Spacer (Topway only)
- Alignment Clip

Options

Frame Options:

- (V)= Full view
- (C) = Topway

Glass Options:

- (TEMP)= Clear
- (GL13) = Powder
- (GL25) = Bronze
- (GL35) = Grey

Concealed Post
 Frameless Add Up
 Clear, Powder, Bronze and Grey Glass

| description | w | d | h | pattern no. | list | Clear (TEMP) | Powder (GL13) Bronze (GL25) Grey (GL35) |
|--|-----|------|-----|----------------------|------|-----------------|---|
| Shortened Frameless Add Up, 14" High (For use with concealed post only) | 50" | 3/4" | 14" | DP1AU1450()G | | \$603. | \$709. |
| | 56" | 3/4" | 14" | DP1AU1456()G | | 659. | 778. |
| | 62" | 3/4" | 14" | DP1AU1462()G | | 716. | 848. |
| | 68" | 3/4" | 14" | DP1AU1468()G | | 772. | 916. |
| | 74" | 3/4" | 14" | DP1AU1474()G | | 829. | 985. |
| | 80" | 3/4" | 14" | DP1AU1480()G | | 900. | 1,067. |
| | 86" | 3/4" | 14" | DP1AU1486()G | | 972. | 1,152. |
| | 92" | 3/4" | 14" | DP1AU1492()G | | 1,050. | 1,246. |
| | 98" | 3/4" | 14" | DP1AU1498()G | | 1,135. | 1,345. |

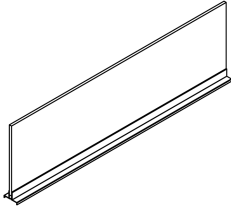

| | | |
|---------|------------------|-----|
| End Cap | DP1AUECTP | 38. |
|---------|------------------|-----|



| Ordering Information | Order Code | Included with: | Options |
|---|---|---|--|
| Frameless Add Up with Glass 1. Pattern number 2. Frame finish 3. Glass finish End Cap 1. Pattern number 2. Paint finish | Frameless Add Up with Glass <i>Example:</i> DP1AU0757VG DP1AU Frameless Add Up 07 7" High 57 57" Wide V Full view G Glass 117 Frame finish TEMP Clear glass finish | Frameless Add Up with Glass <ul style="list-style-type: none"> Attachment hardware Topway Trough Spacer (Topway only) Alignment Clip | Frame Options: (V) = Full view (C) = Topway Glass Options: (TEMP) = Clear (GL13) = Powder (GL25) = Bronze (GL35) = Grey |

The 120-degree planning model provides comparable or greater square footage per workstation than typical cubicle layouts (comparisons are illustrated on this page). At the same time, Dividends Horizon 120° allows for a more natural space, creating a more comfortable place to work. Maintaining a consistent 48" module promotes improved asset management and a reduction of reconfiguration costs.

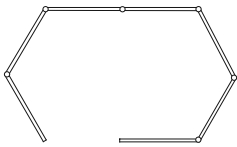

Big House
Sq. Feet = 69.8'
7 Panels

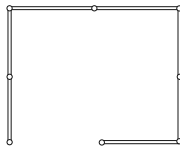

8' x 8'
Sq. Feet = 64'
7 Panels

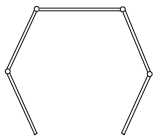

Full House
Sq. Feet = 42.1'
5 Panels

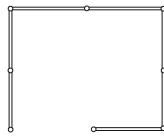

6' x 7'
Sq. Feet = 42'
7 Panels

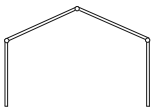

Open House
Sq. Feet = 35.5'
4 Panels

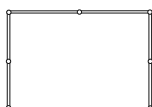

6' x 6'
Sq. Feet = 36'
6 Panels

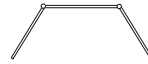

Townhouse
Sq. Feet = 34.1'
3 Panels

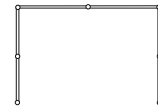

6' x 6'
Sq. Feet = 36'
6 Panels

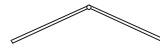

Apartment
Sq. Feet = 32.1'
2 Panels

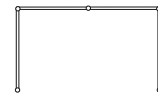

4' x 6'
Sq. Feet = 24'
4 Panels

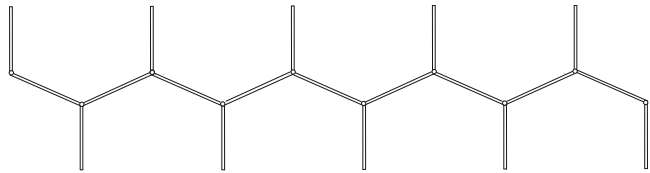

8 Open House Stations
Sq. Feet = 284'
19 Panels

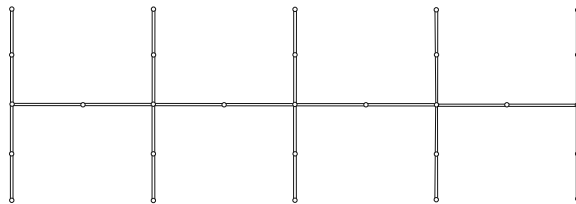

8 Station Cluster
Each station 6' x 6'
Sq. Feet = 288'
28 Panels

These worksurfaces are designed specifically for Dividends Horizon 120. The (L/R) suffix at the end of a pattern number indicates a defined pedestal location. If the worksurface has no defined pedestal location, the (L/R) represents the curved side of the top. All tops and tables are available with 2mm edge band or a 1" ergonomic edge.

Worksurface: W3

This worksurface, combined with the T3 Transition top, works best with the "apartment" layout. This application allows for stations on both sides of the spine, and is ideal for high density layouts. Available in extended versions for placement directly next to another worksurface.

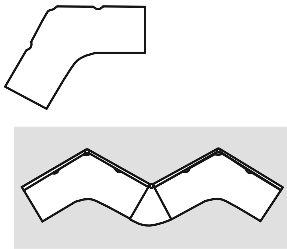

Worksurface: W3

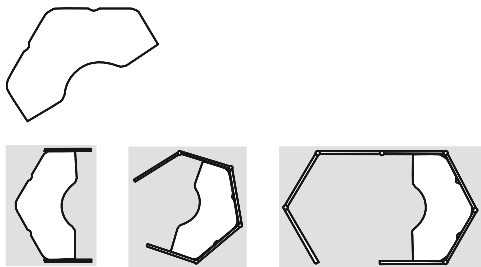

Worksurface: W4

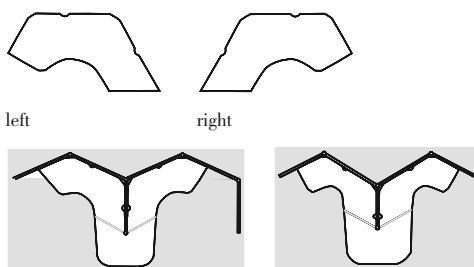

Worksurface: W5 (L/R)

Worksurface: W4

This top works well in the "open house," "full house," and "big house" layouts for call center, professional, and managerial applications.

Worksurface: W5 (L/R)

With transition top T5 and this worksurface, teaming is made easy using the "townhouse" or "open house" layout. The shared space allows for call center, professional, or technical applications.

Worksurface: W6 (L/R)

In the "big house," "full house" or "open house", this worksurface allows for a pedestal on one side (determined by the L/R). Applications for this top include a call center with the "open house," technical applications with the "full house," and managerial layouts with the "big house."

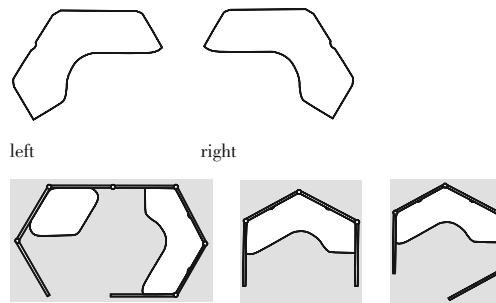

Worksurface: W6 (L/R)

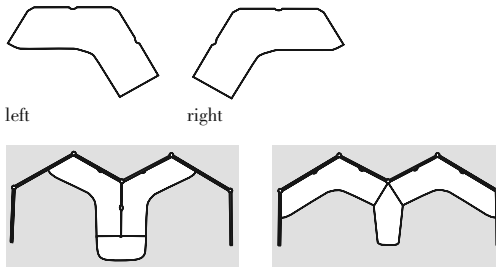

Worksurface: W7 (L/R)

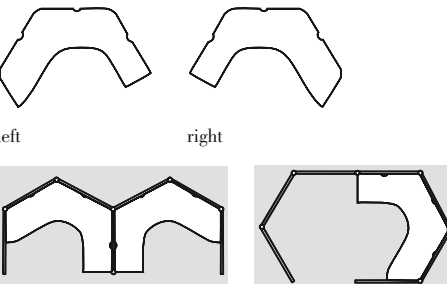

Worksurface: W11 / W1118 (L/R)

Worksurface: W7 (L/R)

Used in conjunction with a T4 transition top, the W7 worksurface provides a great teaming space when the "townhouse" layout is used. The "open house" layout incorporates the T2 transition top for professional or technical stations with shared space for conferencing. Available in extended versions for placement directly next to another worksurface.

Worksurface: W11 / W1118 (L/R)

This top is a spacious option for a technical station in the "open house" layout. Adding a T2 transition top provides additional teaming space. The W11 surface also fits nicely in a private managerial office or a "full house" professional application.

Worksurface: W12 / W1218 (L/R)

This top, with the T5/T518 transition top provides a technical office with shared conferencing space in the “open house” layout. The 18” return allows ample space in the supervisory application of the “full house.”

Worksurface: W13 / W1318 (L/R)

This surface provides a teaming space with the T2/T218 transition in the “open house” layout. The W13/W1318 creates generous worksurface space in the “full house” as well as the management layout of the “big house.”

Transition Tops

Transition tops require columns (not included) for support. Flat brackets (not included) are required to attach transition tops to adjacent worksurfaces.

Application Notes

Dividends Horizon 120° worksurfaces use cantilevers as their main form of support. A cantilever must be used at each post location to support worksurfaces properly. A pedestal may be used for support, where applicable, in conjunction with cantilevers.

Worksurface: W12 / W1218 (L/R)

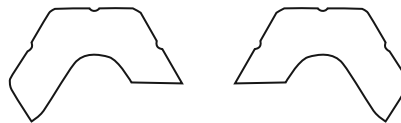

left

right

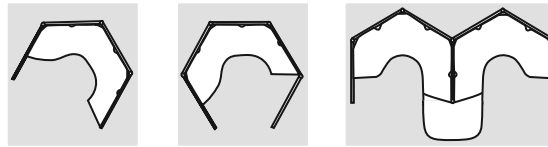

Worksurface: W13 / W1318 (L/R)

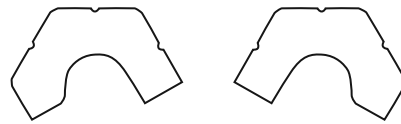

left

right

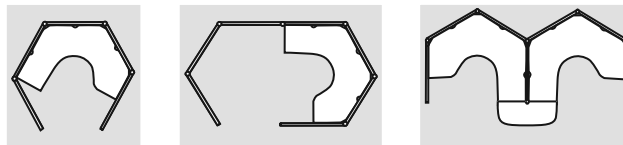

Transition Tops



Transition top: T2



Transition top: T218

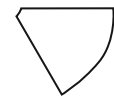

Transition top: T3



Transition top: T4







Transition top: T5



Transition top: T518

120° Planning

120° Post Assemblies

| description | h* | w | d | pattern no. | Black | Metal P1 | Metal P2 | Metal P3 |
|---|-----------------------|----|----|---------------|-------|----------|----------|----------|
|  120° Two-Way Post Assembly | 36" | 3" | 3" | DP()120PA362 | | \$279. | \$287. | \$296. |
| | 42" | 3" | 3" | DP()120PA422 | | 279. | 287. | 296. |
| | 50" | 3" | 3" | DP()120PA502 | | 291. | 301. | 310. |
| | 57" | 3" | 3" | DP()120PA572 | | 322. | 333. | 343. |
| | 64" | 3" | 3" | DP()120PA642 | | 322. | 333. | 343. |
| | 78" | 3" | 3" | DP()120PA782 | | 410. | 428. | 442. |
|  120° Three-Way Post Assembly | 36" | 3" | 3" | DP()120PA363 | | 285. | 293. | 301. |
| | 42" | 3" | 3" | DP()120PA423 | | 285. | 293. | 301. |
| | 50" | 3" | 3" | DP()120PA503 | | 296. | 305. | 314. |
| | 57" | 3" | 3" | DP()120PA573 | | 322. | 333. | 343. |
| | 64" | 3" | 3" | DP()120PA643 | | 322. | 333. | 343. |
| | 78" | 3" | 3" | DP()120PA783 | | 408. | 424. | 439. |
|  14" High 120° Stack Panel Posts | 14 ^{5/8} " | 3" | 3" | DP120SPO 14 | 85. | | | |
|  21" High 120° Stack Panel Posts | 21 ^{15/16} " | 3" | 3" | DP120SPO 21 | 86. | | | |
|  28" High 120° Stack Panel Posts | 29 ^{1/4} " | 3" | 3" | DP120SPO 28 | 99. | | | |

h = nominal height

Ordering Information

- Post Assemblies**
1. Pattern Number
 2. Trim Finish

Order Code

Post Assemblies
Example: **DP(4)120PA 642, 113**
DP(4)120 Pattern Number
PA 642
113 Dark grey trim finish

Included with:

- Post Assemblies**
- Post assemblies
 - Post top cap
 - Post cover
 - Connecting hardware





Options

- Post assembly trim options**
- (4)** = Metal, Radius
 - (5)** = Metal, Flat

120° Planning

120° Post Components

Dividends Horizon

| description | type | h | w | d | pattern no. | Metal P1 | Metal P2 | Metal P3 |
|---|-----------|------|----|----|--------------------|----------|----------|----------|
| Post Covers (Straight) High-Low Connection  | 36" - 42" | 8" | | | DP120PC08S | \$9. | \$11. | \$11. |
| | 36" - 50" | 14" | | | DP120PC14S | 16. | 22. | 24. |
| | 36" - 64" | 28" | | | DP120PC28S | 38. | 42. | 43. |
| | 36" - 78" | 42" | | | DP120PC42SH | 58. | 61. | 63. |
| | 42" - 50" | 8" | | | DP120PC08S | 9. | 11. | 11. |
| | 42" - 64" | 22" | | | DP120PC22S | 25. | 26. | 27. |
| | 42" - 78" | 36" | | | DP120PC36S | 51. | 57. | 59. |
| | 50" - 64" | 14" | | | DP120PC14S | 16. | 22. | 24. |
| | 50" - 78" | 28" | | | DP120PC28S | 38. | 42. | 43. |
| | 64" - 78" | 14" | | | DP120PC14S | 16. | 22. | 24. |
| Post Top Caps  | One-Way | 1/2" | 3" | 3" | DP()120PT1 | 8. | 9. | 9. |
| | Three-Way | 1/2" | 3" | 3" | DP()120PT3 | 8. | 9. | 9. |
| | Two-Way | 1/2" | 3" | 3" | DP()120PT2 | 8. | 9. | 9. |
| Post Covers (Straight)  | 36" | | | | DP120PC36SF | 48. | 51. | 57. |
| | 42" | | | | DP120PC42S | 48. | 51. | 57. |
| | 50" | | | | DP120PC50S | 49. | 54. | 58. |
| | 57" | | | | DP120PC57S | 57. | 59. | 62. |
| | 64" | | | | DP120PC64S | 57. | 59. | 62. |
| | 78" | | | | DP120PC78S | 62. | 69. | 71. |
| Universal Post (Post Only)  | 36" | 3" | 3" | | DP120PO36 | 209. | | |
| | 42" | 3" | 3" | | DP120PO42 | 209. | | |
| | 50" | 3" | 3" | | DP120PO50 | 219. | | |
| | 57" | 3" | 3" | | DP120PO57 | 238. | | |
| | 64" | 3" | 3" | | DP120PO64 | 238. | | |
| | 78" | 3" | 3" | | DP120PO78 | 321. | | |
| Inside Panel Shroud for 120° posts  | 5" | | | | DP120S | 10. | 14. | 16. |

| Ordering Information | Order Code | Included with: | Options |
|---|--|--|--|
| Universal Post 1. Pattern Number | Universal Post <i>Example:</i> DP2A P050 DP2A Pattern Number P050 | Universal Post Connecting hardware | 120° Post Panel Top Cap and Post Covers (4) = Metal, Radius (5) = Metal, Flat |
| Panel Top Cap 1. Pattern Number 2. Trim finish | Panel Top Cap <i>Example:</i> DPV1 PT4, V04 DPV1 PT4 Pattern Number V04 Maple trim finish | Panel Top Cap Post Covers | |
| Post Covers 1. Pattern Number 2. Trim finish | Post Covers <i>Example:</i> DP2A PC50S, 117 DP(2A) Pattern Number PC50S 117 Soft grey trim finish | | |

This page intentionally left blank

Grain Direction

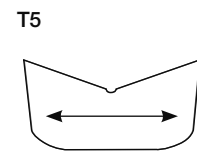
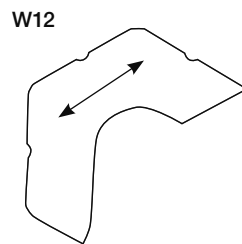
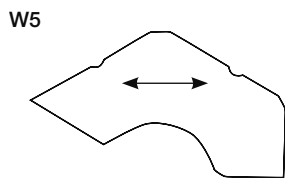
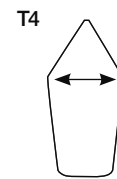
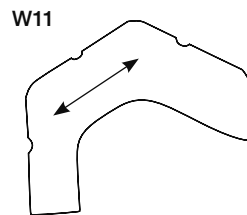
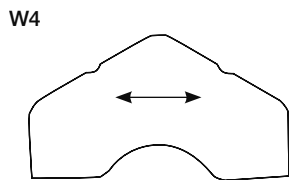
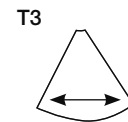
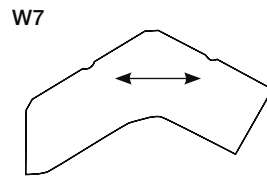
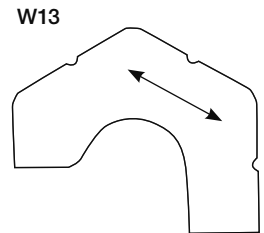
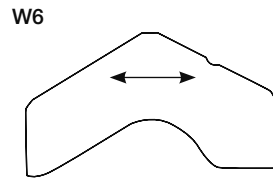
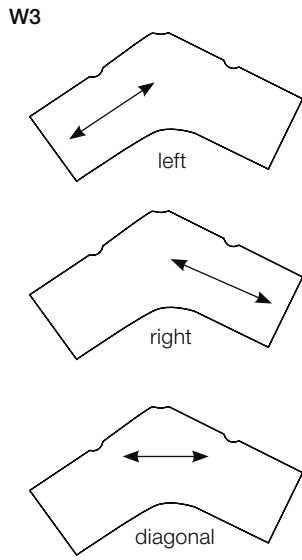

120° Planning

120° Worksurface and Transition Tops

Dividends Horizon

| description | top name | w | return depth | d | pattern no. | 2 mm | woodgrain edge | metal edge |
|-----------------|----------|---------|--------------|---|---------------------|----------|----------------|------------|
| Worksurface | W11L | 48" | 18"L-24"R | | D1WW11481824 | \$1,109. | \$1,218. | \$1,329. |
| | W11R | 48" | 24"L-18"R | | D1WW11482418 | 1,109. | 1,218. | 1,329. |
| | W12L | 48" | 24" | | D1WW124824L | 1,156. | 1,276. | 1,390. |
| | W12R | 48" | 24" | | D1WW124824R | 1,156. | 1,276. | 1,390. |
| | W1318L | 48" | 24"L-18"R | | D1WW13482418 | 1,109. | 1,218. | 1,329. |
| | W1318R | 48" | 18"L-24"R | | D1WW13481824 | 1,109. | 1,218. | 1,329. |
| | W13L | 48" | 24" | | D1WW134824L | 1,109. | 1,218. | 1,329. |
| | W13R | 48" | 24" | | D1WW134824R | 1,109. | 1,218. | 1,329. |
| | W218L | 48" | 24"L-18"R | | D1WW12482418 | 1,156. | 1,276. | 1,390. |
| | W218R | 48" | 18"L-24"R | | D1WW12481824 | 1,156. | 1,276. | 1,390. |
| | W3 | 48" | 24" | | D1WW34824 | 846. | 928. | 1,010. |
| | W4 | 48" | 24" | | D1WW44824 | 868. | 956. | 1,042. |
| | W5L | 48" | 24" | | D1WW54824L | 699. | 770. | 842. |
| | W5R | 48" | 24" | | D1WW54824R | 699. | 770. | 842. |
| | W6L | 48" | 24" | | D1WW64824L | 939. | 1,033. | 1,126. |
| | W6R | 48" | 24" | | D1WW64824R | 939. | 1,033. | 1,126. |
| | W7L | 48" | 24" | | D1WW74824L | 935. | 1,031. | 1,122. |
| | W7R | 48" | 24" | | D1WW74824R | 935. | 1,031. | 1,122. |
| Transition tops | T2 | 50" | 24" | | D1WT224 | 563. | 620. | 677. |
| | T218 | 37 1/2" | 18" | | D1WT218 | 527. | 582. | 633. |
| | T3 | 26" | 24" | | D1WT324 | 537. | 593. | 647. |
| | T4 | 26" | 24" | | D1WT424 | 646. | 710. | 774. |
| | T5 | 50" | 24" | | D1WT524 | 653. | 720. | 781. |
| | T518 | 37 1/2" | 18" | | D1WT518 | 586. | 643. | 700. |

Alternative Planning

Ordering Information

Worksurface

1. Pattern number
2. Finish

Order Code

| | |
|-------------|------------------------------|
| Example: | D1WW134824L, 118, 118 |
| D1W | Dividends 120 w/s 2mm edge |
| W13 | Worksurface #13 |
| 4824 | Side width/return depth |
| L | Pedestal on left side |
| 118 | Bright White laminate |
| 118 | Bright White edge |

Included with:

Worksurface

- Worksurface

Worksurface supports must be ordered separately.

For all tops, specify laminate and edge color.

Transition and peninsula tops require a column base for support.

Note: An upcharge applies when specifying Legacy laminates. See Legacy finish page.

Options

Refer to the worksurface planning page for worksurface drawings and applications.

Note: W3 worksurfaces have a grain direction option. Specify left, right or diagonal. Add \$26 to the list price when specifying diagonal.

3+1 Circuit Electrical

The Dividends Horizon 3+1 electrical system is designed for areas where power usage is significant and sensitive electronic equipment requiring a single isolated circuit is required.

The wire configuration of the 8-wire/4 circuit electrical system is (see chart):

- Hot "A" (black)
- Hot "B" (red)
- Hot "C" (blue)
- Shared neutral "N1" (white/black) for circuits #1, 2 and 3
- Shared ground "G1" (green) for circuits #1, 2 and 3
- Hot "X" (pink)
- Isolated neutral "N2" (white/ red) for circuit 4
- Isolated ground "G2" (green/ yellow) for circuit 4

Circuits 1, 2 and 3 have shared neutral and grounds for convenience power while circuit 4 has a separate ground and neutral for designated/isolated power or to support uninterrupted power supply (UPS).

Compatibility

All Dividends Horizon power systems use components that appear similar. However, components from the three different power systems are not functionally, fully interchangeable. 3+1 components can be connected to 3+3 wire systems, however only 3+1 will function.

3+1 Duplex Receptacles

Duplex receptacles used in 3+1 electrical systems are:

- Convenience duplex circuit number 1 (pattern number DE1DR1)
- Convenience duplex circuit number 2 (pattern number DE1DR2)
- Convenience duplex circuit number 3 (pattern number DE1DR3)
- Isolated duplex circuit number 4 (pattern number DE1DR4)

Isolated duplex receptacle number 4 has an orange-colored triangle on black background to identify an isolated duplex.

An optional orange-colored isolated duplex is also available. It has the isolated identifying triangle outlined in black.

- Isolated orange-colored duplex circuit number 4 (pattern number DE1DOR4)

3+1 Electrical System Technical Specifications

The 3+1 electrical system consists of four 20 amp, 120 volt, 60-Hertz circuits. The circuits will accommodate 120 volt single phase, 120/240 volt split phase and 120/208 volt three phase power. System components are 20 amp capacity. The National Electric Code (NEC) limits continuous loads to 80% of capacity or 16 amps.

Typically, each circuit can power 8-10 duplex convenience outlets with normal loads. In heavier load situations, such as computer systems, each circuit will power 3-5 duplex outlets. If each workstation has two convenience duplex outlets and one protected duplex, the 8-wire (4-circuit) system can supply a cluster of 6 -10 workstations from each infeed.

Surge Suppressors

Dividends Horizon surge suppressors (pattern number DE1SS) plug into any terminal block position to provide surge protection for all duplexes on that circuit.

Note: When connected, surge suppressors take the place of a duplex receptacle resulting in the elimination of one duplex position from the circuit.

Independent Neutral Electrical Systems

Dividends Horizon offers a 2+1 electrical system with independent neutrals as a standard special. It is our belief that independent neutrals are not required. However, if a customer desires an independent neutral electrical system, a Dividends Horizon solution can be provided. For further information, list pricing and schematic drawings, contact Knoll Customer Service.

SPECIFYING ELECTRICAL COMPONENTS

Panel Power Module

Specify one panel power module per panel that matches the width of the panel where duplexes or infeeds are required.

Power Connector

Specify one power connector (with or without post) to connect panel power modules in adjacent panels.

Power Jumper

Specify one power jumper that matches the width of the panel(s) being passed through to connect to panel power modules in nonadjacent panels.

Wiring Diagram (3+1)

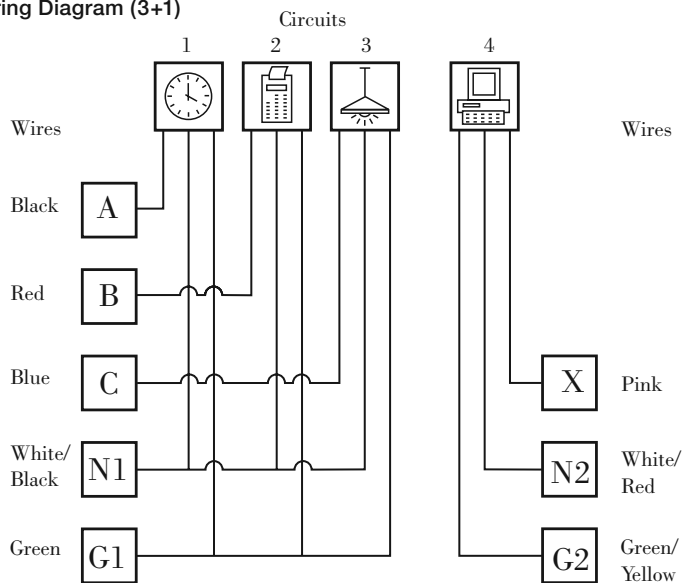

2+2 Electrical System

The Dividends Horizon 2+2 electrical system is designed for areas where power usage is significant and sensitive electronic equipment requiring two isolated circuits are required.

The wiring configuration of the (2+2) electrical system is (see chart):

- Hot "A" (black)
- Hot "B" (red)
- Shared neutral "N1" (white/black) for circuits #1 and 2
- Shared ground "G1" (green) for circuits #1 and 2
- Hot "Y" (tan)
- Hot "X" (pink)
- Isolated Shared Neutral "N2" (white/red) for circuits #4 and 5
- Isolated Shared ground "G2" (green/yellow) for circuits #4 and 5

Circuits 1 and 2 share common neutral and ground. Circuits 4 and 5 share a separate common neutral and ground.

Compatibility

All Dividends Horizon power systems use components that appear similar. However, components from the three different power systems are not functionally, fully interchangeable.

2+2 Duplex Receptacles

Duplex receptacles used in 8-wire (2+2) electrical systems are:

- Convenience duplex circuit number 1 (pattern number DE1DR1)
- Convenience duplex circuit number 2 (pattern number DE1DR2)
- Isolated duplex circuit number 4 (pattern number DE1DR4)
- Isolated duplex circuit number 5 (pattern number DE1DR5)

2+2 Electrical System Technical Specifications

The 2+2 electrical system consists of four 20 amp, 120 volt, 60-Hertz circuits. The circuits will accommodate 120 volt single phase, 120/240 volt split phase, and 120/208 volt three phase power. System components are 20 amp capacity. The National Electric Code (NEC) limits continuous loads up to 80% of capacity or 16 amps. Typically, each circuit can power 8-10 duplex convenience outlets with normal loads. In heavier load situations, such as computer systems, each circuit will power 3-5 duplex outlets.

SPECIFYING ELECTRICAL COMPONENTS

Panel Power Module

Specify one panel power module per panel that matches the width of the panel where duplexes or infeeds are required.

Power Connector

Specify one power connector (with or without post) to connect power modules in adjacent panels.

Power Jumper

Specify one power jumper that matches the width of the panel(s) being passed through to connect to panel power modules in nonadjacent panels.

Wiring Diagram (2+2)

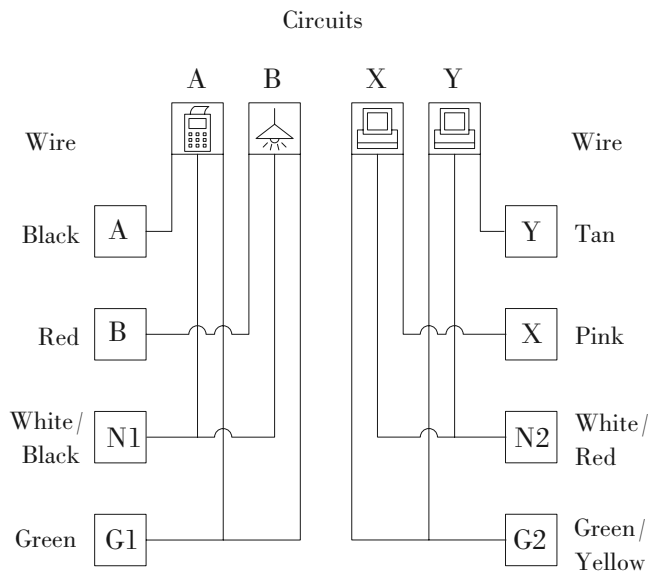

3+3 Electrical System

The Dividends Horizon 3+3 electrical system is designed for areas where power usage is significant and sensitive electronic equipment requiring multiple isolated circuits is required.

The wiring configuration of the 3+3 electrical system is (see chart):

- Hot "A" (black)
- Hot "B" (red)
- Hot "C" (blue)
- Shared neutral "N1" (white/black) for circuits #1, 2 and 3
- Shared ground "G1" (green) for circuits #1, 2 and 3
- Hot "Z" (orange)
- Hot "Y" (tan)
- Hot "X" (pink)
- Hot "Y" (tan)
- Isolated neutral "N2" (white/ red for circuits 4, 5 and 6
- Isolated ground "G2" (green/yellow) for circuits 4, 5 and 6

Circuits 1, 2 and 3 are for convenience power while circuits 4, 5 and 6 are for designated/ isolated power or for supporting uninterrupted power supply (UPS).

Compatibility

All Dividends Horizon power systems use components that appear similar. However, components from the three different power systems are not functionally, fully interchangeable. 3+3 components can be connected to 3+1 systems, however only 8-wires will function.

Wiring Diagram (3+3)

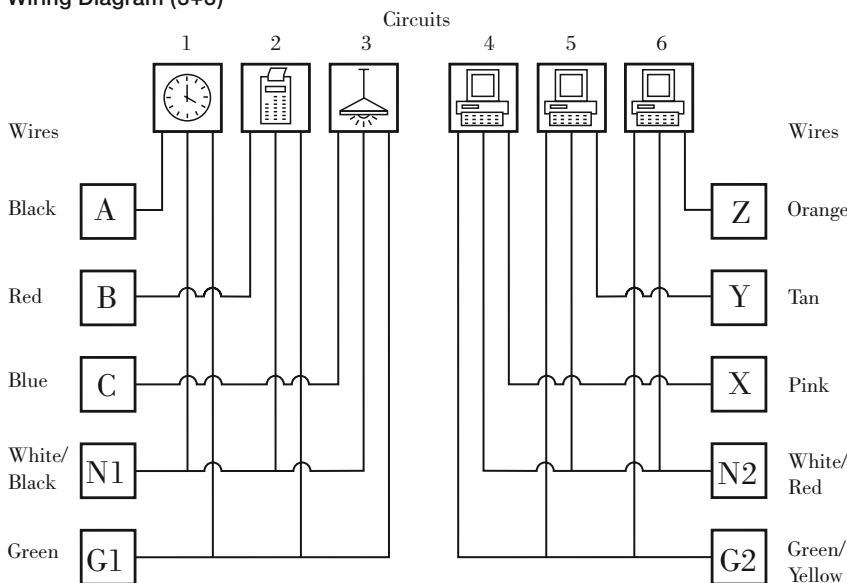

3+3 Duplex Receptacles

Duplex receptacles used in 3+3 electrical systems are:

- Convenience duplex circuit number 1 (pattern number DE1DR1)
- Convenience duplex circuit number 2 (pattern number DE1DR2)
- Convenience duplex circuit number 3 (pattern number DE1DR3)
- Isolated duplex circuit number 4 (pattern number DE1DR4)
- Isolated duplex circuit number 5 (pattern number DE1DR5)
- Isolated duplex circuit number 6 (pattern number DE1DR6)

Isolated duplex receptacles number 4, 5 and 6 have an orange-colored triangle on black background to signify as an isolated duplex.

Optional orange-colored isolated duplexes are also available. They have the isolated identifying triangle outlined in black.

- Isolated orange-colored duplex circuit number 4 (pattern number DE1DOR4)
- Isolated orange-colored duplex circuit number 5 (pattern number DE1DOR5)
- Isolated orange-colored duplex circuit number 6 (pattern number DE1DOR6)

3+3 Electrical System Technical Specifications

The 3+3 electrical system consists of six 20 amp, 120 volt, 60-Hertz circuits. The circuits will accommodate 120 volt single phase, 120/240 volt split phase and 120/208 volt three phase power. System components are 20 amp capacity. The National Electric Code (NEC) limits continuous loads to 80% of capacity or 16 amps. Typically, each circuit can power 8-10 duplex convenience outlets with normal loads. In heavier load situations, such as computer systems, each circuit will power 3-5 duplex outlets. If each workstation has two convenience duplex outlets and one protected duplex, the 10-wire (6-circuit) system can supply a cluster of 9 - 15 workstations from each infeed.

Surge Suppressors

Dividends Horizon surge suppressors (pattern number DE1SS) plug into any terminal block position to provide surge protection for all duplexes on that circuit.

Note: When connected, surge suppressors take the place of a duplex receptacle resulting in the elimination of one duplex position from the circuit.

Independent Neutral Electrical Systems

Dividends Horizon offers a 10-wire/2+2 electrical system with independent neutrals as a standard special. It is our belief that independent neutrals are not required. However, if a customer desires an independent neutral electrical system, a Dividends Horizon solution can be provided. For further information, list pricing and schematic drawings, contact Knoll Customer Service.

SPECIFYING ELECTRICAL COMPONENTS

Panel Power Module

Specify one panel power module per panel that matches the width of the panel where duplexes or infeeds are required.

Power Connector

Specify one power connector (with or without post) to connect panel power modules in adjacent panels.

Power Jumper

Specify one power jumper that matches the width of the panel(s) being passed through to connect to panel power modules in nonadjacent panels.

Base Raceway Electrical

Power Modules, Power Jumpers

Specifications

Base Raceway Electrical

Power can be distributed through the base raceway.

Three systems are available:

- 3 + 1
- 2 + 2
- 3 + 3

Modular components are used to distribute power through the base raceway and consist of:

- Power modules
- Power connectors
- Power jumpers
- Duplex receptacles
- Power infeeds

All electrical components and data cables are field-installed.

CAUTION: DO NOT CONNECT POWER UNTIL INSTALLATION IS COMPLETE. CONNECTION TO THE BUILDING POWER SOURCE MUST BE PERFORMED BY A LICENSED ELECTRICIAN.

Power Modules

Power modules are the primary electrical components for distributing electrical within panels. They are also the only components that accept duplex receptacles and power infeeds for access.

Panels 24" and wider can accept power modules. 18" wide panels only accept power jumpers.

Power modules consist of terminal blocks at each end connected by a hard-wired metal conduit. The terminal blocks accept duplex receptacles or power infeeds. Power modules snap into integral channels in base raceways and can be accessed on one or both panel sides.

Power Jumpers

Power jumpers connect between power modules in non-adjacent panels. Power jumpers take the place of power modules in panels not requiring duplexes to provide pass-through power.

Three versions are available:

- Single panel power jumpers
- Single panel power jumpers with post
- Multiple panel power jumpers

Single panel power jumpers carry power from a panel with a power module through a single non-electrified panel to an adjacent panel with a power module when a post connector is not involved.

Single panel power jumpers with post carry power from a panel with a power module through a single non-electrified panel and post connector to an adjacent panel with a power module.

Multiple panel power jumpers carry power from a panel with a power module through multiple panels with or without a post to the next available power module.

Base Raceway Electrical

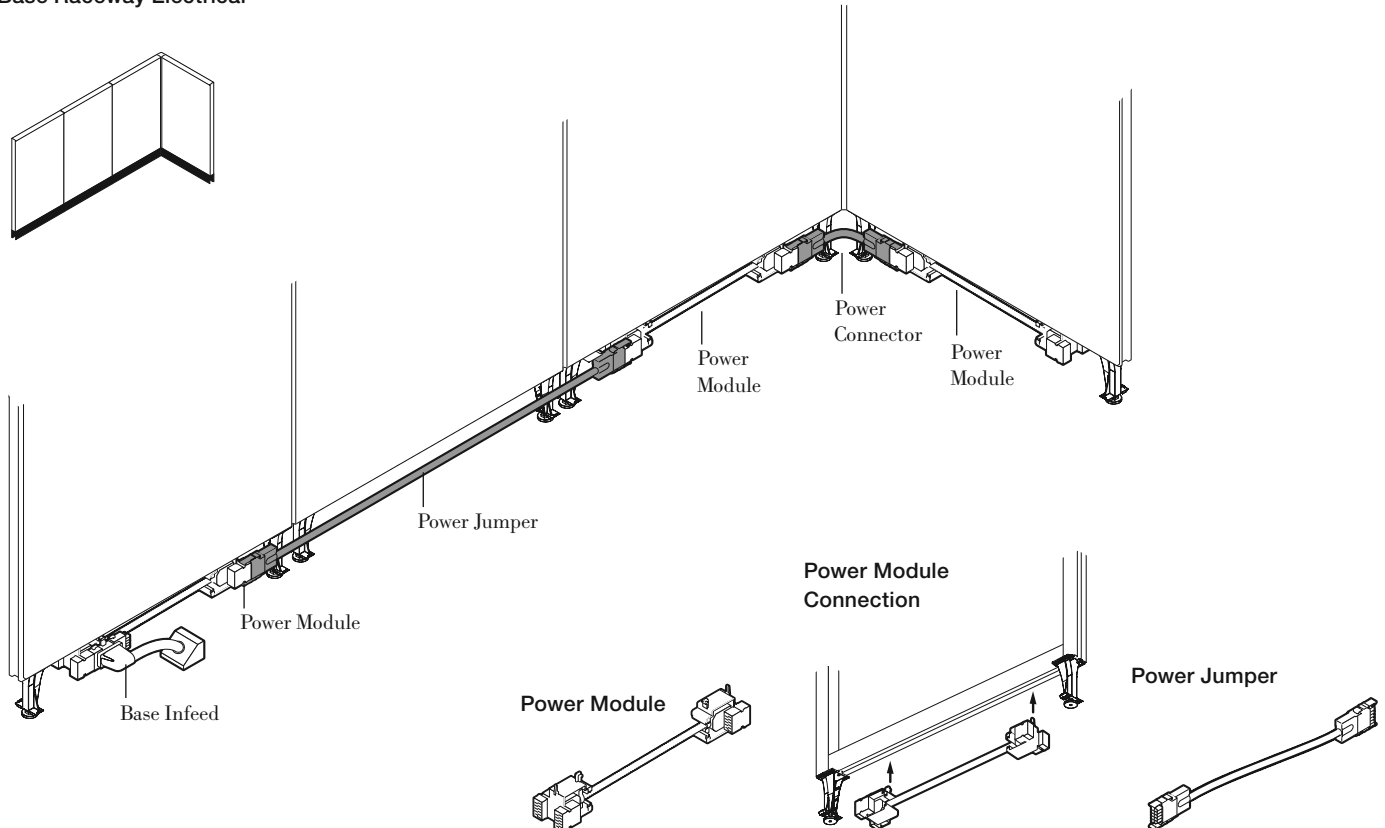

Base Raceway Electrical 3+1, 2+2 and 3+3 Systems Specifications

Power Connectors

Power connectors carry power from power module to power module in adjacent panels.

Two versions are available:

- 12" no post
- 15" with post

12" power connectors connect adjacent power modules in straight configurations when no post connector is involved.

15" power connectors are used in applications involving adjacent power modules separated by post connectors.

Duplex Receptacles

Duplex receptacles provide access to power along the base raceway.

Two duplex receptacles can be installed per panel side in base raceways 24" and wider. 18" wide panels cannot accept duplex receptacles.

Receptacles insert into terminal blocks in outlet positions at either end of power modules and attach with a single screw.

Duplexes are available in (3+1), (2+2) and (3+3) systems. Each system engages a different combination of circuit wiring within the power module. For detailed wiring diagrams, refer to the electrical system required:

- 3 + 1
- 2 + 2
- 3 + 3

3+1, 2+2 and 3+3 Electrical Systems

Each electrical system is designed for different usage.

The (2+2) electrical system is for areas requiring 2 circuits for standard power usage and 2 circuits for isolated power usage.

The (3+1) electrical system is for areas requiring significant power usage and an isolated circuit.

The (3+3) electrical system is for areas with significant power usage and a need for multiple isolated circuits.

Base Power Infeeds

Base power infeeds route power from the building's electrical source to the panel base raceway.

Power infeeds plug into any terminal block position on panel power modules.

Power Connector

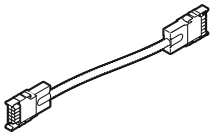

Duplex Receptacle

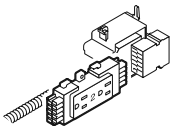

Base Infeed

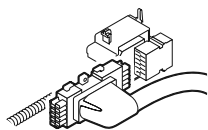

Legend

- Power Module
- ⋯ Power Jumper
- Power Connector

Note: Power connectors or power jumpers can only plug into power modules

Power Connectors

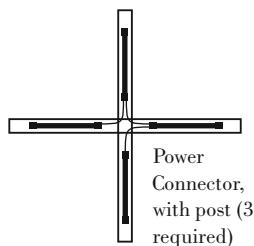
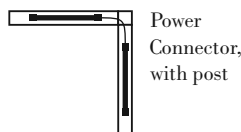
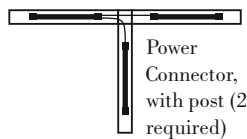
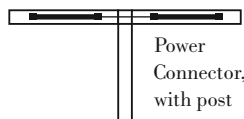

Single Panel Power Jumpers

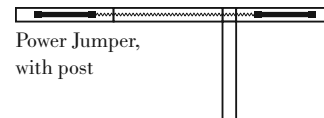
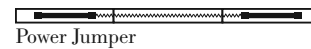

Multiple Panel Power Jumpers

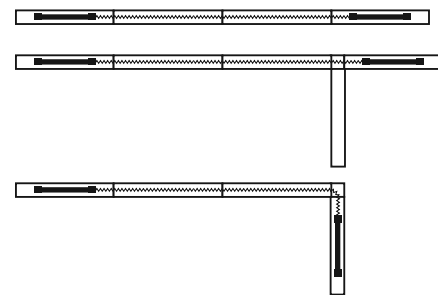

Multiple Panel Power Jumper and Power Connector

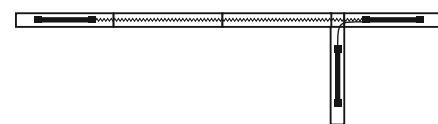





Base Raceway Electrical

Power Modules, Connectors and Jumpers

(3+1), (2+2) and (3+3)

Dividends Horizon

| description | type | pattern no. | E | 8 | T |
|--|------------------|--------------------------|--------|--------|--------|
| Power Module - Double sided for raceway on both sides  | 24" W Panel | DE1(E,8,T) PM24 | \$115. | \$128. | \$132. |
| | 30" W Panel | DE1(E,8,T) PM30 | 123. | 136. | 136. |
| | 36" W Panel | DE1(E,8,T) PM36 | 128. | 139. | 142. |
| | 42" W Panel | DE1(E,8,T) PM42 | 137. | 150. | 149. |
| | 48" W Panel | DE1(E,8,T) PM48 | 145. | 157. | 156. |
| | 60" W Panel | DE1(E,8,T) PM60 | 162. | 178. | 178. |
| Power Module - Single sided for raceway on one side  | 24" W Panel | DE1(E,8,T) PMS24 | 115. | 128. | 132. |
| | 30" W Panel | DE1(E,8,T) PMS30 | 123. | 136. | 136. |
| | 36" W Panel | DE1(E,8,T) PMS36 | 128. | 139. | 142. |
| | 42" W Panel | DE1(E,8,T) PMS42 | 137. | 150. | 149. |
| | 48" W Panel | DE1(E,8,T) PMS48 | 145. | 157. | 156. |
| | 60" W Panel | DE1(E,8,T) PMS60 | 162. | 178. | 178. |
| Power Connector - (power module-to-power module)  | 12" no post | DE1(E,8,T) PCNP | 75. | 81. | 92. |
| | 15" with post | DE1(E,8,T) PCWP | 77. | 83. | 99. |
| Power Jumper  | 15" Panel | DE1(E,8,T) PJ15NP | 86. | 101. | 128. |
| | 18" Panel | DE1(E,8,T) PJ18NP | 86. | 101. | 128. |
| | 24" Panel | DE1(E,8,T) PJ24NP | 100. | 106. | 134. |
| | 30" Panel | DE1(E,8,T) PJ30NP | 103. | 111. | 138. |
| | 36" Panel | DE1(E,8,T) PJ36NP | 106. | 116. | 146. |
| | 42" Panel | DE1(E,8,T) PJ42NP | 111. | 124. | 150. |
| | 48" Panel | DE1(E,8,T) PJ48NP | 119. | 133. | 156. |
| Power Jumper (with post)  | 15" Panel + Post | DE1(E,8,T) PJ15WP | 97. | 104. | 132. |
| | 18" Panel + Post | DE1(E,8,T) PJ18WP | 97. | 104. | 132. |
| | 24" Panel + Post | DE1(E,8,T) PJ24WP | 101. | 109. | 137. |
| | 30" Panel + Post | DE1(E,8,T) PJ30WP | 104. | 114. | 141. |
| | 36" Panel + Post | DE1(E,8,T) PJ36WP | 109. | 122. | 149. |
| | 42" Panel + Post | DE1(E,8,T) PJ42WP | 115. | 128. | 152. |
| | 48" Panel + Post | DE1(E,8,T) PJ48WP | 123. | 136. | 161. |

Ordering Information

Power Jumper
1. Pattern Number

Order Code

Power Jumper
Example: **DE1E PJ42NP**
DE1E Pattern Number
PJ42NP

Included with:

Power Jumper

Options

Power Jumper

Options
(E) = 3+1
(8) = 2+2
(T) = 3+3

Note: Double-sided power module will not fit in a panel base raceway with tile to the floor on one side.

Base Raceway Electrical
Power Modules, Connectors and Jumpers
(3+1), (2+2) and (3+3)

Dividends Horizon

| description | type | pattern no. | E | 8 | T |
|---|---------------|--------------------------|--------|--------|--------|
| Multiple Panel Power Jumper (with or without post)  | 54" Panel Run | DE1(E,8,T) PJ54WP | \$130. | \$141. | \$167. |
| | 60" Panel Run | DE1(E,8,T) PJ60WP | 133. | 146. | 167. |
| | 66" Panel Run | DE1(E,8,T) PJ66WP | 139. | 152. | 179. |
| | 72" Panel Run | DE1(E,8,T) PJ72WP | 142. | 156. | 184. |
| | 78" Panel Run | DE1(E,8,T) PJ78WP | 149. | 164. | 188. |
| | 84" Panel Run | DE1(E,8,T) PJ84WP | 154. | 173. | 192. |
| | 96" Panel Run | DE1(E,8,T) PJ96WP | 163. | 180. | 208. |

Ordering Information

Power Jumper

1. Pattern Number

Order Code

Power Jumper

Example: **DE1E PJ42NP**

DE1E Pattern Number

PJ42NP

Included with:

Power Jumper

Options

Power Jumper

Options

(E) = 3+1

(8) = 2+2

(T) = 3+3

Note: Double-sided power module will not fit in a panel base raceway with tile to the floor on one side.

This page intentionally left blank

Duplex Receptacles

Duplexes are field-installed into power modules within beltway and base raceways. Duplex receptacles insert into panel power module terminal block positions and attach with a single screw.

Identification of Duplexes

Duplexes are clearly marked to indicate which circuits they access. Convenience duplex receptacles are black in color with the circuit identification in white.

Isolated duplexes are black in color with the circuit identification in white and an orange triangle located in the lower right corner.

Orange isolated duplexes are also available for ease of identification. In orange-colored duplexes the identifying triangle is outlined in black.

Types of Duplex Receptacles

Several types of duplex outlets are available. Each is specific to the circuit it accesses and is listed by power system.

Specify the duplex receptacle related to the power system being used (example: 8-wire) and circuit accessed (example: circuit 4). Black or orange finish.

3+1 Duplex Receptacles

Receptacles in a 3+1 electrical system can access circuits 1, 2 and 3 (convenience power) and circuit 4 (isolated power)

2+2 Duplex Receptacles

Receptacles in a 2+2 electrical system can access circuits 1 and 2 (convenience power) and circuits 4 and 5 (isolated power)

Please note that circuit 3 is not available in a 2+2 electrical system.

3+3 Duplex Receptacles

Receptacles in a 3+3 electrical system can access circuits 1, 2 and 3 (convenience power) and circuits 4, 5 and 6 (isolated power)

Power Capacity

Each duplex circuit has a capacity of 20 amps. The National Electrical Code (NEC) requires that each circuit does not exceed 80% of capacity or 16 amps continuous use on each 20 amp circuit.

Duplex Receptacle Dimensions

- Overall dimensions: 4 ⁵/₈" wide, 2 ¹/₁₆" high, 1" deep
- Face dimensions: 2 ⁵/₈" wide, 1 ¹/₄" high

Access

Non-electrified panels can accept data ports in any raceway cover knockout. Panels with power modules can only accept data ports in the center knockout due to the location of the terminal block.

Typical Power Requirements of Various Equipment

| Equipment | Amp (approx.) |
|-------------------|---------------|
| Calculator | .25 |
| Coffee maker* | 8.5-15 |
| Desktop copier* | 10-15 |
| Fan | 1 |
| Fax (plain paper) | 5-8 |
| Heater* | 8.5-15 |
| Laser printer | 6-10 |
| Lighting | .5-1.5 |
| Microwave* | 10-20 |
| PC | 4-8 |
| Refrigerator* | 10-15 |
| Terminal | 1-3 |
| Typewriter | 1-2 |
| Scanner | .25-.5 |

*Requires separate circuit

Note: The above amperage chart is based on the estimated average amount of power required and is intended as a general guide only. For precise amperage requirements, refer to the equipment manufacturer's amperage specifications and compare to the available amperage on each circuit.

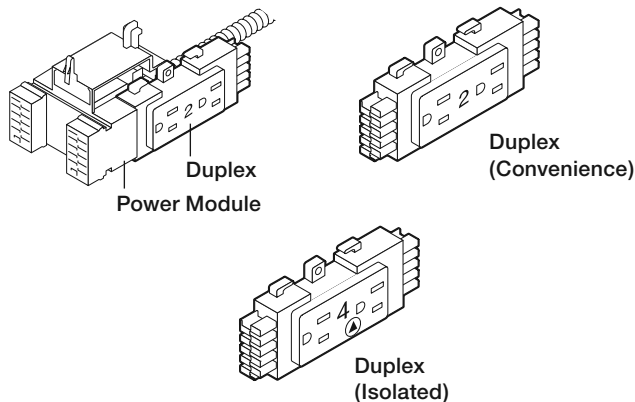

Base Raceway Covers (knockout locations)

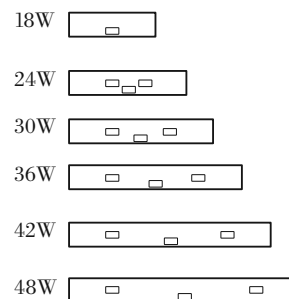



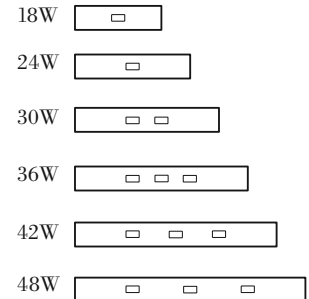

Beltway Covers (knockout locations)



Receptacles

Knockout Replacement Covers

Dividends Horizon

| description | type | pattern no. | Single pack list | Ten pack list |
|--|------------------|-------------------|------------------|---------------|
|  Receptacle, (3+1)(Black) | Duplex circuit 1 | DE1DR1 () | \$40. | \$319. |
| | Duplex circuit 2 | DE1DR2 () | 40. | 319. |
| | Duplex circuit 3 | DE1DR3 () | 40. | 319. |
| | Duplex circuit 4 | DE1DR4 () | 40. | 319. |
|  Receptacle, (2+2)(Black) | Duplex circuit 1 | DE1DR1 () | 40. | 319. |
| | Duplex circuit 2 | DE1DR2 () | 40. | 319. |
| | Duplex circuit 4 | DE1DR4 () | 40. | 319. |
| | Duplex circuit 5 | DE1DR5 () | 40. | 319. |
|  Receptacle, (3+3)(Black) | Duplex circuit 1 | DE1DR1 () | 40. | 319. |
| | Duplex circuit 2 | DE1DR2 () | 40. | 319. |
| | Duplex circuit 3 | DE1DR3 () | 40. | 319. |
| | Duplex circuit 4 | DE1DR4 () | 40. | 319. |
| | Duplex circuit 5 | DE1DR5 () | 40. | 319. |
| | Duplex circuit 6 | DE1DR6 () | 40. | 319. |
|  Receptacle, (Orange) | Duplex circuit 4 | DE1DOR4() | 40. | 319. |
| | Duplex circuit 5 | DE1DOR5() | 40. | 319. |
| | Duplex circuit 6 | DE1DOR6() | 40. | 319. |
|  Base Raceway Knockout Replacement Cover (for electrical or data) | Package of 10 | DE2KC10 | n/a | 74. |

Ordering Information

Receptacle
1. Pattern Number

Order Code

Receptacle
Example: **DE1 DR4**
DE1 DR4 Pattern Number

Included with:

Receptacle

Options

Receptacle
Quantity Option:
(SP) = Single Pack
(TP) = Ten Pack

Vertical Electrical

Power Module, Electrical Receptacle and Trim Plate Specifications

Vertical Power Module

A vertical power module is an alternative to using beltway electrical. The use of a vertical power module allows for electrical access within a panel without having to order a beltway panel. Vertical power modules can be installed below a worksurface, at desk height or even within a panel-mounted overhead cabinet.

A panel's left-hand or right-hand vertical rail (see below) allows for installation of a vertical power module. Vertical power modules may be installed with 1-sided or 2-sided access, allowing users of both panel faces access to an electrical receptacle.

Base Power Jumpers

Base raceway power jumpers are used to connect the adjacent panel's base power module to the vertical power module.

Additional vertical power modules may be "daisy-chained" together with base power jumpers. If one vertical power module is installed, an additional vertical power module may be added within the same panel. A base power jumper connects between the two vertical power modules.

Vertical power modules can also be daisy-chained in adjacent panels. A base power jumper passes through the beltway panel frame opening to connect to the additional vertical power module.

Vertical Electrical Receptacle

Please note that base raceway receptacles are not compatible with vertical power modules.

Vertical electrical receptacles must be ordered separately from the vertical power module. Vertical electrical receptacles consist of one vertical receptacle. One vertical power module can also accommodate back-to-back vertical electrical receptacles.

To provide back-to-back vertical electrical power, two vertical receptacles must be specified. Vertical electrical receptacles must be ordered separately.

Specify the vertical receptacle that relates to the circuit specified.

Desktop Power module

Desktop power modules (DE3WSME) provide two low-profile outlets at worksurface height. The desktop power module also helps meet ADA requirements regarding power access at worksurface height.

A mounting bracket and attachment screw allow the desktop power module to be installed at any point along the rear of a worksurface without tools or the removal of the worksurface. An 8½' power cord plugs into any duplex receptacle in the base raceway and accesses the circuit it is connected to. Desktop power module dimensions are 3¾" wide and 4½" high.

Base Raceway Power Jumpers

To specify a base power jumper that connects a desk height vertical power module to an adjacent panel's base power module, specify a 48" base power jumper for panel widths of 36" or less. Use a 54" base power jumper for panel widths of 42" or 48". If a vertical power module is to be installed higher than worksurface height within a 64" high panel, a 66" base power jumper is required and an 84" base power jumper is required for 78" high panels.

To specify a base power jumper to span the width of two vertical power modules within two adjacent panels, identify the base power jumper length by combining the panel widths and height differences between the two vertical power modules.

Note: The base power jumper passes through the panel's beltway opening that is at a height of 33".

The panel's beltway opening (at 33" high) must not be obstructed as to allow for the base power jumper to pass through.

Note: 36" high panel frames do not have beltway openings and do not support horizontal power pass through at 33".

Note: Vertical electrical components can be used with a technology tile or field installed into a fabric tile.

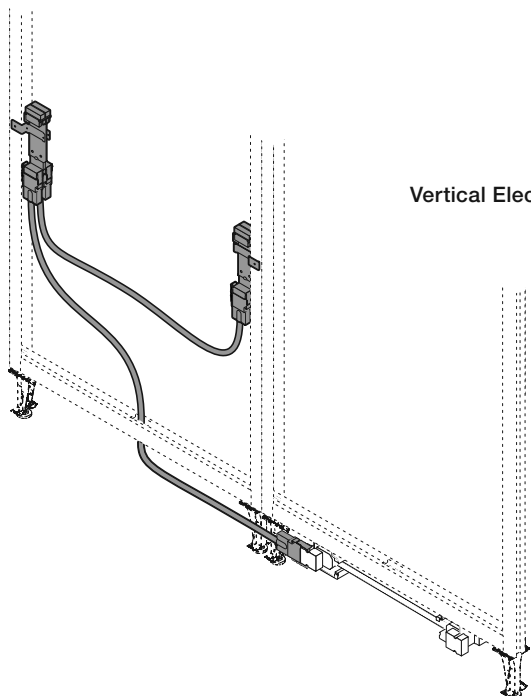

Vertical Electrical Power Jumpers

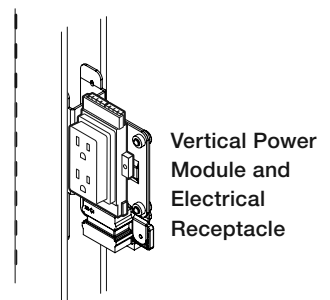
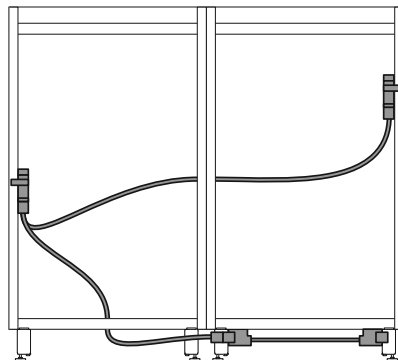

Vertical Power Module and Electrical Receptacle

Vertical Electrical

Power Module, Electrical Receptacle and Trim Plate Specifications

Communications and Data Distribution

Dividends Horizon panels can accommodate communications and data cables horizontally in three ways:

- Along the top cableway
- Along the beltway (with optional cable tray)
- Along the base raceway (with optional cable tray)

Vertical cable distribution is through the panel's internal panel cavity which is accessed by cable slots located in both the upper and lower horizontal panel frame. Since cables are distributed internally within Dividends Horizon panels, no external cable managers are required.

Raceway cover data knockouts have an opening of 1³/₈" high x 2¹¹/₁₆" wide. Data port covers are no longer available from Knoll and must be supplied from a communications vendor.

Data Port Access

Non-electrified panels can accept data ports in any raceway cover knockout.

Panels with power modules can only accept data ports in the center knockout due to the location of the terminal blocks.

Single Floating Data Port

Dividends Horizon floating data ports allow data and communications to be mounted in any location on the panel surface.

Floating data ports include front and back mounting plates and attachment screws. All data port kits must be specified separately for floating data ports. Floating data ports involve field-cutting the panel insert for installation.

Includes front and back mounting plates and two mounting screws. Data ports kits or data port components must be specified separately from a communications vendor. Black finish.

Desktop Modules

The desktop data module provides up to two data/communication ports at worksurface height. The desktop power module provides two convenient electrical outlets at worksurface height. The desktop power and data module includes two data/communication ports and two electrical outlets at worksurface height. The thumbscrew on the bracket allows user adjustability if desired. Black finish.

Data modules do not include data jacks. Data jacks need to be purchased separately. This data module has two openings that can accept most standard jack sizes. The data module comes with adapter pieces that can accommodate most standard data jacks.

Topway Panel Cable Routing

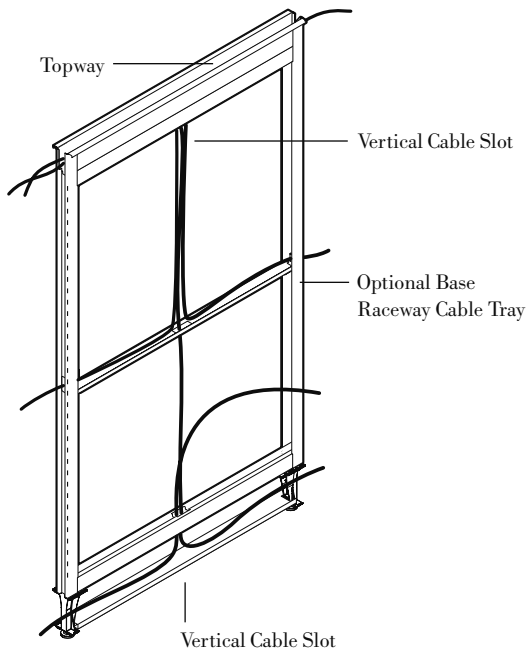

Floating Data Port

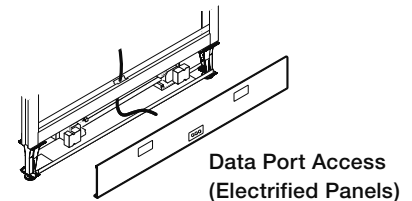
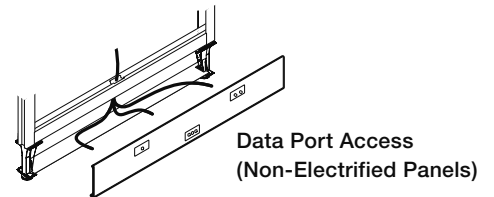
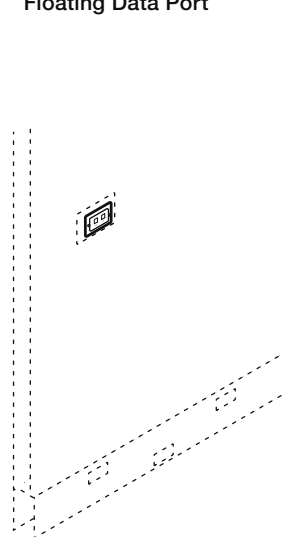

Desktop Data Module

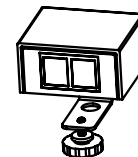

Desktop Power and Data Module

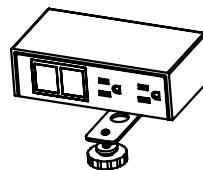

Desktop Power Module

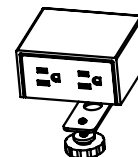

Vertical Electrical

Power Module, Electrical Receptacle and Trim Plate

Double and Single Ports

| description | type | pattern no. | Single pack | Ten pack | 3+1 | 2+2 | 3+3 |
|-----------------------|-----------------------|----------------|-------------|----------|-----|-----|-----|
| Vertical Power Module | Vertical Power Module | DE6 VPM | \$209. | n/a | | | |

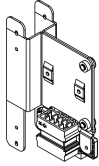

| | | | | |
|--|------------------|-------------------|-----|------|
| Vertical Electrical Receptacle (3+1)(Black) | Duplex circuit 1 | DE6 VDR1() | 40. | 319. |
| | Duplex circuit 2 | DE6 VDR2() | 40. | 319. |
| | Duplex circuit 3 | DE6 VDR3() | 40. | 319. |
| | Duplex circuit 4 | DE6 VDR4() | 40. | 319. |

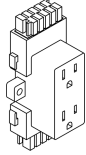

| | | | | |
|--|------------------|-------------------|-----|------|
| Vertical Electrical Receptacle (2+2)(Black) | Duplex circuit 1 | DE6 VDR1() | 40. | 319. |
| | Duplex circuit 2 | DE6 VDR2() | 40. | 319. |
| | Duplex circuit 4 | DE6 VDR4() | 40. | 319. |
| | Duplex circuit 5 | DE6 VDR5() | 40. | 319. |

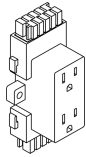

| | | | | |
|--|------------------|-------------------|-----|------|
| Vertical Electrical Receptacle (3+3)(Black) | Duplex circuit 1 | DE6 VDR1() | 40. | 319. |
| | Duplex circuit 2 | DE6 VDR2() | 40. | 319. |
| | Duplex circuit 3 | DE6 VDR3() | 40. | 319. |
| | Duplex circuit 4 | DE6 VDR4() | 40. | 319. |
| | Duplex circuit 5 | DE6 VDR5() | 40. | 319. |
| | Duplex circuit 6 | DE6 VDR6() | 40. | 319. |

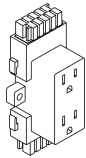

| Ordering Information | Order Code | Included with: | Options |
|---|---|----------------------------------|---|
| Vertical Power Module 1. Pattern Number | Vertical Power Module <i>Example:</i> DE5 VPM DE5 VPM Pattern Number | Vertical Power Module | Vertical Power Module |
| Base Raceway Power Jumper 1. Pattern Number | Base Raceway Power Jumper <i>Example:</i> DE1(E) BPJ30 DE1(E) Pattern Number BPJ30 | Base Raceway Power Jumper | Base Raceway Power Jumper Insert appropriate letter for type of wiring required within the parentheses of the pattern number. (E) = 3+1 (8) = 2+2 (T) = 3+3 |

Receptacle Quantity Option:

(SP) = Single Pack
(TP) = Ten Pack

Note: Trim plate filler for use with technology tile trim plate only.

Vertical Electrical

Power Module, Electrical Receptacle and Trim Plate

Double and Single Ports

| description | type | pattern no. | Single pack | Ten pack | 3+1 | 2+2 | 3+3 |
|-------------------|---------------|-----------------|-------------|----------|-----|-----|-----|
| Trim Plate Filler | Package of 10 | DE6 FDPF | n/a | \$42. | | | |

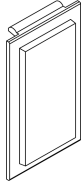

| | | | | | | | |
|--|-----------------------------------|----------------|-----|-----|--|--|--|
| Single Floating Data Port Trim Plate (field install kit) | Faceplate, backplate and hardware | DE1 FDP | 49. | n/a | | | |
|--|-----------------------------------|----------------|-----|-----|--|--|--|

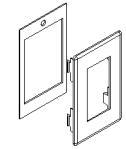

| | | | | | | | |
|--|--|----------------|-----|-----|--|--|--|
| Technology Tile Trim Plate (field install kit) | Faceplate, backplate filler and hardware | DE6 FDP | 54. | n/a | | | |
|--|--|----------------|-----|-----|--|--|--|

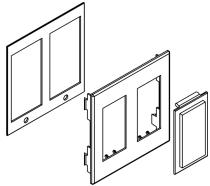

| | | | | | | |
|----------------------------|------------|--------------------------|--|------|------|------|
| Base Raceway Power Jumpers | 48" Jumper | DE1(E,8,T) PJ48WP | | 123. | 136. | 161. |
| | 54" Jumper | DE1(E,8,T) PJ54WP | | 130. | 141. | 167. |
| | 60" Jumper | DE1(E,8,T) PJ60WP | | 133. | 146. | 167. |
| | 66" Jumper | DE1(E,8,T) PJ66WP | | 139. | 152. | 179. |
| | 72" Jumper | DE1(E,8,T) PJ72WP | | 142. | 156. | 184. |
| | 78" Jumper | DE1(E,8,T) PJ78WP | | 149. | 164. | 188. |
| | 84" Jumper | DE1(E,8,T) PJ84WP | | 154. | 173. | 192. |



| Ordering Information | Order Code | Included with: | Options |
|---|---|----------------------------------|--|
| Vertical Power Module 1. Pattern Number | Vertical Power Module <i>Example:</i> DE5 VPM DE5 VPM Pattern Number | Vertical Power Module | Vertical Power Module |
| Base Raceway Power Jumper 1. Pattern Number | Base Raceway Power Jumper <i>Example:</i> DE1(E) BPJ30 DE1(E) Pattern Number BPJ30 | Base Raceway Power Jumper | Base Raceway Power Jumper Insert appropriate letter for type of wiring required within the parentheses of the pattern number. (E) = 3+1 (8) = 2+2 (T) = 3+3 Receptacle Quantity Option: (SP) = Single Pack (TP) = Ten Pack Note: Trim plate filler for use with technology tile trim plate only. |

| description | type | w | d | h | pattern no. | list |
|--------------------------------------|----------------|--------|--------|--------|-------------------|--------|
| Desktop Power Module, clamp mount | With 108" Cord | 3 3/4" | 4 1/2" | 2 1/2" | DE4WSME108 | \$145. |
| | With 72" Cord | 3 3/4" | 4 1/2" | 2 1/2" | DE4WSME72 | 116. |



| | | | | | | |
|---|----------------|--------|--------|--------|--------------------|------|
| Desktop Power + Data Module, clamp mount | With 108" Cord | 6 1/8" | 4 1/2" | 2 1/2" | DE4WSMED108 | 310. |
| | With 72" Cord | 6 1/8" | 4 1/2" | 2 1/2" | DE4WSMED72 | 281. |



| | | | | | | |
|-------------------------------------|--|--------|--------|--------|----------------|------|
| Desktop Data Module, clamp mount | | 3 3/4" | 4 1/2" | 2 1/2" | DE4WSMC | 102. |
|-------------------------------------|--|--------|--------|--------|----------------|------|



| Ordering Information | Order Code | Included with | Options |
|----------------------|------------------------------------|---------------|---------|
| Desktop Power Module | Desktop Power Module | | |
| 1. Pattern Number | <i>Example:</i> DE4 WSME108 | | |

This page intentionally left blank

Beltway Electrical

Power can be distributed through the beltway

Three systems are available:

- 3+1
- 2+2
- 3+3

Modular components are used to distribute power within beltways and consist of:

- Beltway power modules
- Beltway power connectors
- Beltway power jumpers
- Beltway vertical power jumpers
- Duplex receptacles

All electrical components and data cables are field-installed.

WARNING: DO NOT CONNECT POWER UNTIL INSTALLATION IS COMPLETE. CONNECTING TO THE BUILDING POWER SOURCE MUST BE PERFORMED BY A LICENSED ELECTRICIAN.

Beltway modules accept duplex receptacles and vertical power jumpers for bringing the power to the beltway from the base raceway. Another alternative for desk height electrical is a vertical power module.

Depending on the number of desk height receptacles required in each panel, consider the list price of both beltway electrical and vertical power module in each application.

Beltway Power Modules

Power modules are the primary electrical components for distributing power within beltways. Beltway power modules are also components that accept duplex receptacles and vertical power jumpers for bringing the power to the beltway from the base raceway.

Beltway raceways 30" and wider can accept beltway power modules while 18" and 24" wide panels can accept power jumpers for pass-through power only.

Beltway power modules screw into the vertical channels of panel frames and include a steel horizontal mounting support.

Specify one beltway power module per panel that matches the width of the panel where duplexes are required. Available one- or two-sided.

Just like base raceway power modules, beltway power modules consist of a terminal block at each end connected by a hard-wired metal conduit.

Beltway power modules are one- or two-sided. This allows planning options such as beltway one side and monolithic or tiled inserts on the other, or beltway one side and no inserts on the other for against-the-wall applications. The terminal blocks accept either duplex receptacles or vertical power jumpers.

Beltway Power Connectors

Beltway power connectors carry power from power module to power module in adjacent panels.

Two versions are available:

- no post
- with post.

Beltway power connectors, no post, connect adjacent power modules in straight configurations when a post connector is not involved.

Beltway power connectors, with post, are used in applications involving adjacent power modules separated by post connectors in straight through post configurations only.

Specify one beltway power connector (with or without post) to connect beltway power module or beltway power jumper in adjacent panels. In straight line configurations only.

Beltway Electrical

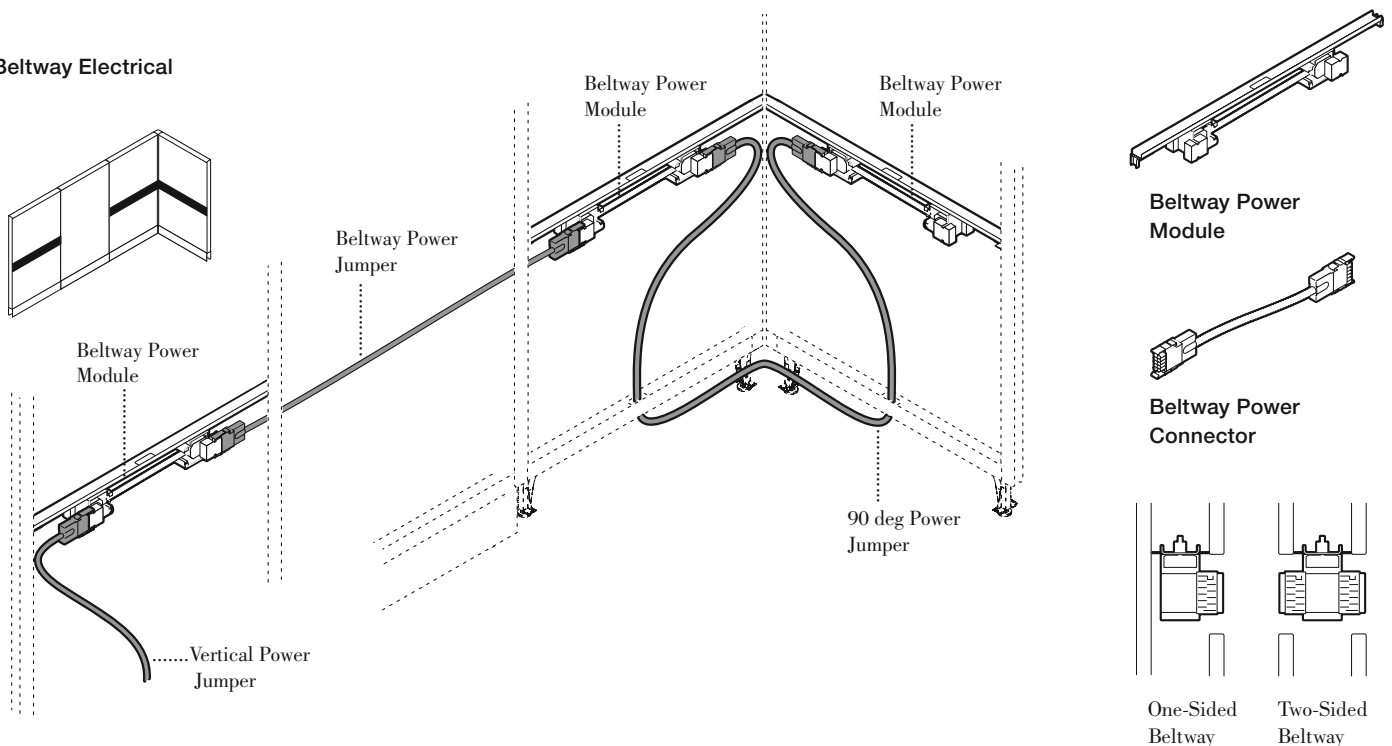

Beltway Profiles

Beltway Power Jumpers

Beltway power jumpers connect between power modules in nonadjacent panels. Beltway power jumpers take the place of power modules in panels not requiring duplexes to provide pass-through power.

Three versions are available:

- Single panel jumpers
- Single panel jumpers with post
- Multiple panel jumpers

Single panel beltway jumpers carry power from a panel with a beltway power module through a single non-electrified panel to an adjacent panel with a beltway power module when a post is not involved in straight line configurations only.

Single beltway panel jumpers with post carry power from a panel with a power module through a single non-electrified panel and post connector to an adjacent panel with a beltway power module in straight through post configurations only.

Multiple beltway panel jumpers carry power from a panel with a power module through multiple panels with or without a post to the next available beltway power module in straight line configurations only.

Specify one beltway power jumper per panel that matches the width of the panel for pass-through electrical where duplexes are not required for straight line configurations only.

90° Beltway Power Jumper

A 90° beltway power jumper connects adjacent beltway power modules at a 90° “L” panel connection.

The following illustrations outline the various components required for beltway applications with a post.

Note: A 90° beltway power jumper can only be used with adjacent panels in a “X”, “T” or “L” conditions. The 90° jumper cannot be used to span multiple panels.

To specify correct jumper length, determine the largest panel width between the two adjacent corner panels in which jumper is to be installed.

Vertical Power Jumpers

To carry power from the base raceway to the beltway located in the same panel requires a vertical power jumper. Vertical power jumpers function as an extension of the base raceway power system.

Attachment is from any unused outlet position in the base raceway to the end terminal block connection in the beltway power module. The vertical power jumper cable is concealed in the cavity of the panel frame.

Power can also be carried to a beltway run from the base raceway of an adjacent panel with a power module. This is accomplished by using a panel power jumper.

Specify one vertical power jumper per beltway electrical run not to exceed the electrical systems capacity. See the technical specifications for the electrical system being utilized.

Note: Length of power jumper allows for connections with or without post conditions.

Power Infeeds

A ceiling infeed may also be used to bring power directly to the beltway power module without having to go directly to a base raceway power module.

Duplex Receptacles

Duplex receptacles provide access to power along the beltway. Duplexes used in the beltway are the same as the duplexes used in the base raceway.

Two duplex receptacles can be installed per panel side in beltway raceways 30" and wider. 24"W panels will accept beltway power jumpers for pass-through power only.



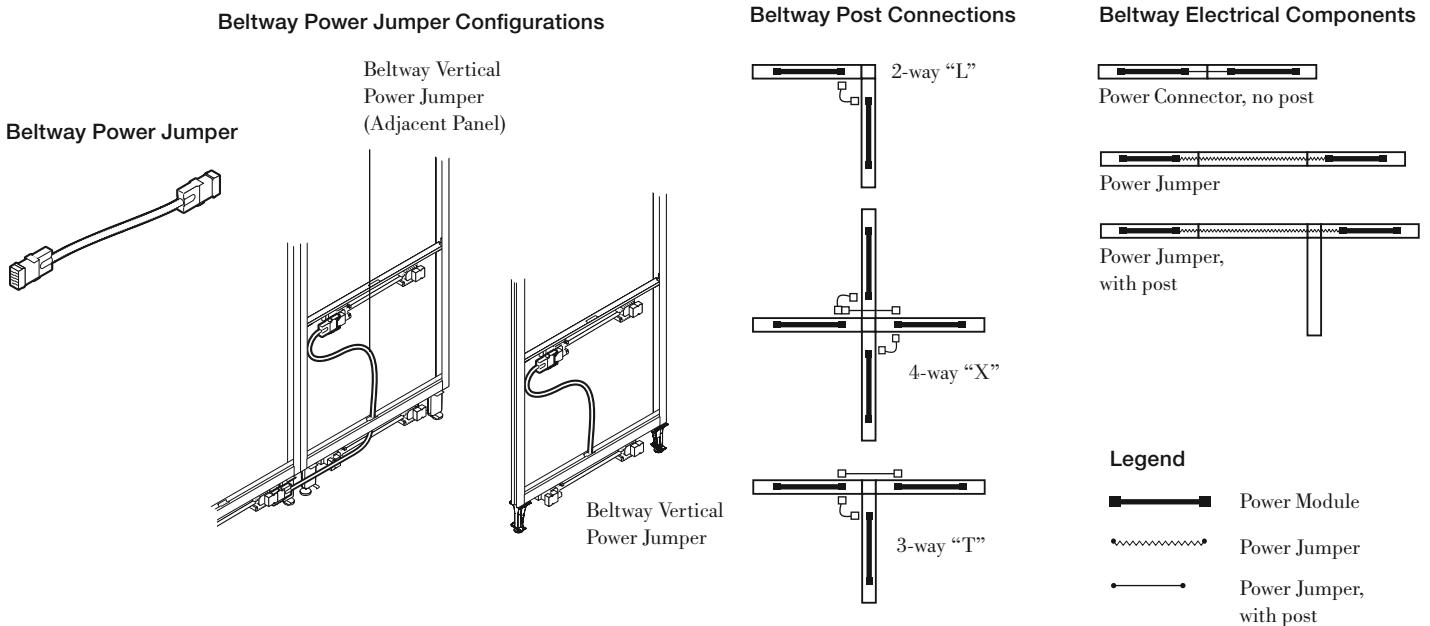

Receptacles insert into terminal blocks in outlet positions at either end of power modules and attach with a single screw.

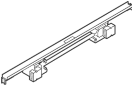
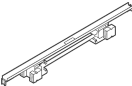

Beltway Electrical

Power Modules, Power Connectors and Power Jumpers

Dividends Horizon



| description | type | length | pattern no. | 3+1 | 2+2 | 3+3 |
|---|---------------|----------------------|----------------------|--------|--------|--------|
|  Beltway Power Module - 1-Side | | 30" | DE1() BPM301 | \$162. | \$179. | \$179. |
| | | 36" | DE1() BPM361 | 171. | 186. | 182. |
| | | 42" | DE1() BPM421 | 179. | 192. | 190. |
| | | 48" | DE1() BPM481 | 186. | 208. | 199. |
| | | 60" | DE1() BPM601 | 211. | 216. | 216. |
|  Beltway Power Module - 2-Side | | 30" | DE1() BPM302 | 162. | 179. | 179. |
| | | 36" | DE1() BPM362 | 171. | 186. | 182. |
| | | 42" | DE1() BPM422 | 179. | 192. | 190. |
| | | 48" | DE1() BPM482 | 186. | 208. | 199. |
| | | 60" | DE1() BPM602 | 211. | 216. | 216. |
|  Beltway Power Connector | 17" No Post | | DE2() BPCNP | 80. | 86. | 100. |
| | 20" With Post | | DE2() BPCWP | 82. | 96. | 103. |
|  Beltway Power Jumper (No post) | | 18" | DE2() BPJ18NP | 100. | 106. | 134. |
| | | 24" | DE2() BPJ24NP | 103. | 111. | 138. |
| | | 30" | DE2() BPJ30NP | 106. | 116. | 146. |
| | | 36" | DE2() BPJ36NP | 111. | 124. | 150. |
| | | 48" | DE2() BPJ48NP | 123. | 136. | 161. |
|  Beltway Power Jumper (With post) | | 18" | DE2() BPJ18WP | 101. | 109. | 137. |
| | | 24" | DE2() BPJ24WP | 104. | 114. | 141. |
| | | 30" | DE2() BPJ30WP | 109. | 122. | 149. |
| | | 36" | DE2() BPJ36WP | 115. | 130. | 152. |
| | | 48" | DE2() BPJ48WP | 133. | 138. | 163. |
|  Multiple Panel Power Jumper (with or without post) | | 54" Panel Run | DE2() BPJ54WP | 133. | 146. | 167. |
| | | 60" Panel Run | DE2() BPJ60WP | 139. | 152. | 179. |
| | | 66" Panel Run | DE2() BPJ66WP | 142. | 155. | 184. |
| | | 72" Panel Run | DE2() BPJ72WP | 149. | 163. | 188. |
| | | 78" Panel Run | DE2() BPJ78WP | 154. | 171. | 192. |
| | | 84" Panel Run | DE2() BPJ84WP | 163. | 182. | 208. |
| | 96" Panel Run | DE2() BPJ96WP | 176. | 189. | 215. | |

| Ordering Information | Order Code | Included with: | Options |
|---|--|-----------------------------|---|
| Beltway Power Jumper 1. Pattern Number Note: Insert appropriate letter for type of wiring required within the parentheses of the pattern number. | Beltway Power Jumper <i>Example:</i> DE1(E) BPJ30 DE1(E) Pattern Number BPJ30 | Beltway Power Jumper | Beltway Power Jumper Insert appropriate letter for type of wiring required within the parentheses of the pattern number. <ul style="list-style-type: none"> • E= 3+1 • 8= 2+2 • T= 3+3 |

Beltway Electrical

Power Modules, Power Connectors and Power Jumpers

Dividends Horizon

| description | type | length | pattern no. | 3+1 | 2+2 | 3+3 |
|--|------|-------------------|--------------------------|--------|--------|--------|
| 90° Beltway Power Jumper  | | 30" Beltway Panel | DE1() PJ120WP | \$213. | \$233. | \$266. |
| | | 36" Beltway Panel | DE1() PJ126WP | 219. | 242. | 278. |
| | | 42" Beltway Panel | DE1() PJ138WP | 229. | 253. | 287. |
| | | 48" Beltway Panel | DE1() PJ144WP | 237. | 261. | 297. |
| Vertical Power Jumper (Within Same Panel) | | | DE1() VPJ | 182. | 199. | 188. |
| Vertical Power Jumper (From Adjacent Panel)  | | 30" Beltway Panel | DE1(E,8,T) PJ48WP | 123. | 136. | 161. |
| | | 36" Beltway Panel | DE1(E,8,T) PJ54WP | 130. | 141. | 167. |
| | | 42" Beltway Panel | DE1(E,8,T) PJ54WP | 130. | 141. | 167. |
| | | 48" Beltway Panel | DE1(E,8,T) PJ60WP | 133. | 146. | 167. |

| Ordering Information | Order Code | Included with: | Options |
|---|--|-----------------------------|---|
| Beltway Power Jumper 1. Pattern Number Note: Insert appropriate letter for type of wiring required within the parentheses of the pattern number. | Beltway Power Jumper <i>Example:</i> DE1(E) BPJ30 DE1(E) Pattern Number BPJ30 | Beltway Power Jumper | Beltway Power Jumper Insert appropriate letter for type of wiring required within the parentheses of the pattern number. <ul style="list-style-type: none"> • E= 3+1 • 8= 2+2 • T= 3+3 |

Power Infeeds

Power infeeds carry power from the building's electrical source to the panel system's base raceway. Two styles are available:

- Base power infeeds
- Ceiling infeeds

Base Power Infeed

Dividends Horizon base power infeeds route power from floor monuments or electrical boxes to any terminal block duplex position on base raceway power modules. Two screws secure the base power infeed to the power module.

Note: When connected, a base power infeed takes the place of one duplex outlet.

Base power infeeds have a 56" long liquid tight conduit and pigtail for connection to the building's power supply.

Infeeds are specified either right- or left-handed. This allows the conduit to enter the outlet position from either the left or right side.

In addition to right- or left handed base power infeeds is a reversible base power infeed with a 56" long liquid tight conduit. The reversible infeed rotates to provide either a right- or left-hand power entry.

Specify the base infeed that matches the power system accessed and left or right cable entry (example: (3+1), left-hand entry).

Ceiling Infeeds

Raceway-to-ceiling infeeds route power from a ceiling-located power source to the panel system's base raceway. Unlike base infeeds which plug into any terminal block outlet position, ceiling infeeds must plug into the end of a base raceway power module. Ceiling infeeds have a 19 1/2' long metal conduit and pigtail.

Two components are required for installation:

- Raceway to ceiling infeed
- Power pole

Ceiling infeed may be installed directly into a beltway power module for beltway electrical only.

Specify the ceiling infeed that matches the power system accessed.

Power Poles

Power poles can accommodate one raceway-to-ceiling infeed along with data cables. The power pole can also be used to route data cables only, if required. Cable capacity for power poles with the electrical conduit installed is 30, category 5 cables and without an electrical conduit is 40, category 5 cables.

Power poles integrate within the panel system footprint by mounting atop existing post connectors in "L", "T" or "X" configurations.

Power poles are available in three lengths in order to accommodate all three heights of post connectors. All power poles measure 126" or 144" when added to the height of the post connector. For ceilings less than 126" or 144" high, field-cut the power pole to the required height. Power poles include ceiling trim plate, connecting hardware and post/power pole trim covers.

Legacy Power Pole Construction

Power pole is extruded aluminum powder coated, with four PVC trim covers.

Dividends Horizon DP7 Power Pole Construction

Power pole is extruded aluminum, with removable cover, powder coated in any Knoll Core or Dividends Horizon Legacy finish. One side of the power pole is open, allowing cables to be inserted or removed when the cover is removed.

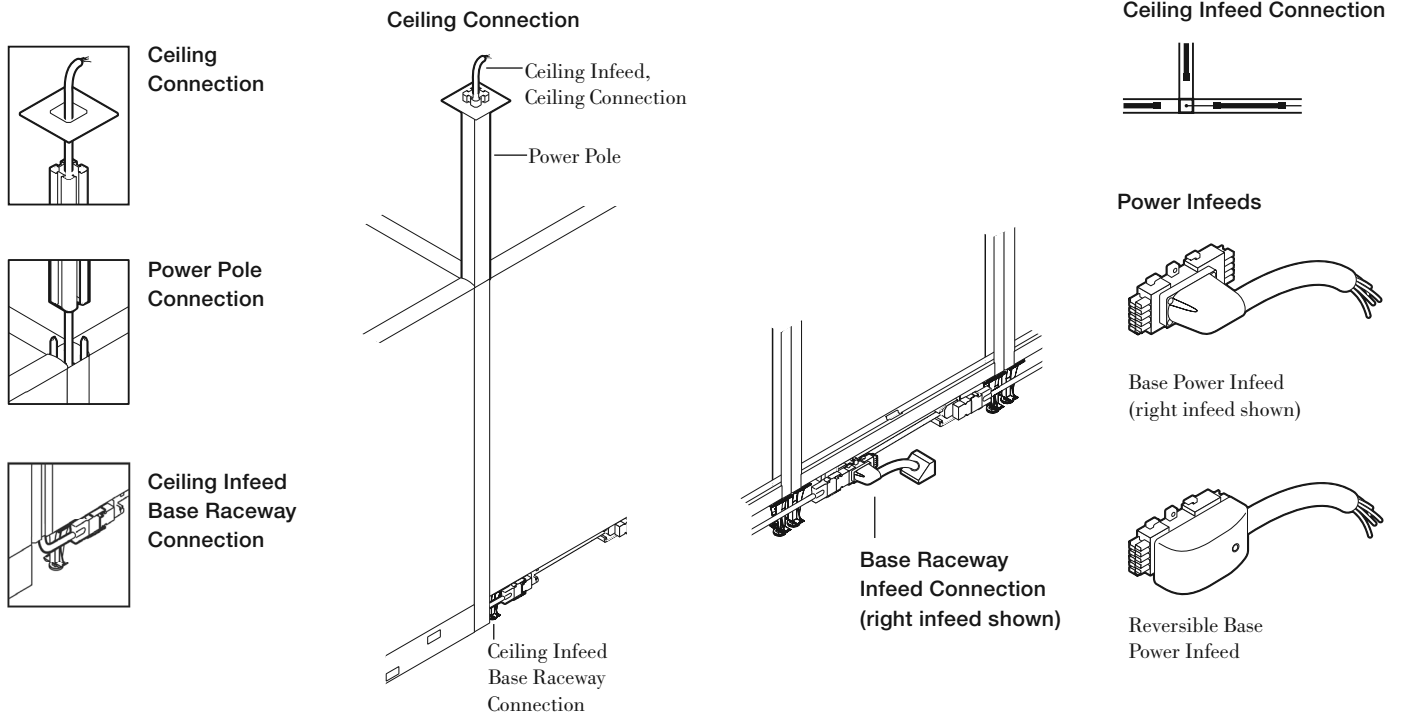

CAUTION: DO NOT CONNECT POWER UNTIL INSTALLATION IS COMPLETE. CONNECTION TO BUILDING POWER SOURCE MUST BE PERFORMED BY A LICENSED ELECTRICIAN.



Electrical Infeeds and Power Poles

Base Power and Raceway-to-Ceiling Infeeds

Dividends Horizon

| description | type | length | pattern no. | list | P1 | P2 | P3 |
|--|------|---------|-----------------------|--------|----|----|----|
| Base Power Infeed (specify left or right) (right shown)  | 2+2 | 56" | DE18 BI56(L/R) | \$227. | | | |
| | 3+1 | 56" | DE1E BI56(L/R) | 208. | | | |
| | 3+3 | 56" | DE1T BI56(L/R) | 266. | | | |
| Base Power Infeed (reversible)  | 2+2 | 56" | DE18 RBI56 | 275. | | | |
| | 3+1 | 56" | DE1E RBI56 | 252. | | | |
| | 3+3 | 56" | DE1T RBI56 | 330. | | | |
| Raceway-to-Ceiling Infeed  | 2+2 | 19 1/2' | DE18 CI144 | 333. | | | |
| | 3+1 | 19 1/2' | DE1E CI144 | 302. | | | |
| | 3+3 | 19 1/2' | DE1T CI144 | 384. | | | |

| Ordering Information | Order Code | Included with: | Options |
|---|--|---|--|
| <p>Base Power Infeed (L/R)</p> <p>1. Pattern Number</p> <p>Power Pole</p> <p>1. Pattern Number 2. Trim Finish</p> <p>Note: Power poles mount atop existing post connectors in "L", "T" and "X" configurations</p> | <p>Base Power Infeed (L/R)</p> <p><i>Example:</i> DE18 BI56(L)</p> <hr/> <p>DE18 Pattern Number (left entry)</p> <p>BI56(L)</p> <p>Power Pole</p> <p><i>Example:</i> DE(1) PP64S, 117</p> <hr/> <p>DE(1) Pattern Number</p> <p>PP64S</p> <hr/> <p>117 Soft Grey trim finish</p> | <p>Base Power Infeed (L/R)</p> <p>Power Pole</p> <ul style="list-style-type: none"> Power pole Ceiling trim plate Connecting hardware Post/power pole trim cover <p>Note: Power pole does not include raceway-to-ceiling infeed which must be ordered separately.</p> | <p>Base Power Infeed (L/R)</p> <ul style="list-style-type: none"> To specify direction of entry, add either an "L" or "R" suffix to the pattern number. <p>Legacy Power Pole</p> <ul style="list-style-type: none"> Post cover <p>(1)= Grooved (2)= Smooth</p> <p>Insert appropriate number for post cover option within the parentheses of the pattern number</p> <p>Dividends Horizon Power Pole</p> <ul style="list-style-type: none"> Post cover |

Electrical Infeeds and Power Poles

DP7 and Legacy Power Poles

Dividends Horizon

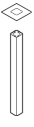
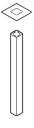
| description | type | length | pattern no. | list | P1 | P2 | P3 |
|---|-------------------|--------|-----------------|------|--------|--------|--------|
| Dividends Horizon Power Pole for use with DP7 Series Posts only (does not include Raceway-to-Ceiling Infeed) For 126" ceiling height  | For 36"H DP7 Post | 90" | DP7PP36S | | \$428. | \$450. | \$471. |
| | For 42"H DP7 Post | 84" | DP7PP42S | | 394. | 412. | 434. |
| | For 50"H DP7 Post | 76" | DP7PP50S | | 363. | 380. | 398. |
| | For 57"H DP7 Post | 69" | DP7PP57S | | 320. | 336. | 354. |
| | For 64"H DP7 Post | 62" | DP7PP64S | | 315. | 330. | 347. |
| | For 78"H DP7 Post | 48" | DP7PP78S | | 315. | 330. | 347. |
| Dividends Horizon Power Pole for use with DP7 Series Posts only (does not include Raceway-to-Ceiling Infeed) For 144" ceiling height | For 36"H DP7 Post | 108" | DP7PP36T | | 437. | 459. | 479. |
| | For 42"H DP7 Post | 102" | DP7PP42T | | 400. | 421. | 442. |
| | For 50"H DP7 Post | 94" | DP7PP50T | | 363. | 380. | 398. |
| | For 57"H DP7 Post | 86" | DP7PP57T | | 320. | 336. | 354. |
| | For 64"H DP7 Post | 80" | DP7PP64T | | 315. | 330. | 347. |
| | For 78"H DP7 Post | 66" | DP7PP78T | | 315. | 330. | 347. |
| Legacy Power Pole for use with Legacy Posts only (does not include Raceway-to-Ceiling Infeed) For 126" ceiling height  | For 36"H Post | 90" | DE2PP36S | 428. | | | |
| | For 42"H Post | 84" | DE2PP42S | 394. | | | |
| | For 50"H Post | 76" | DE2PP50S | 363. | | | |
| | For 64"H Post | 62" | DE2PP64S | 320. | | | |
| | For 78"H Post | 48" | DE2PP78S | 315. | | | |
| Legacy Power Pole for use with Legacy Posts only (does not include Raceway-to-Ceiling Infeed) For 144" ceiling height | For 36"H Post | 108" | DE2PP36T | 322. | | | |
| | For 42"H Post | 102" | DE2PP42T | 286. | | | |
| | For 50"H Post | 94" | DE2PP50T | 370. | | | |
| | For 64"H Post | 80" | DE2PP64T | 330. | | | |
| | For 78"H Post | 66" | DE2PP78T | 320. | | | |

Ordering Information

Base Power Infeed (L/R)

1. Pattern Number

Power Pole

1. Pattern Number
2. Trim Finish

Order Code

Base Power Infeed (L/R)

Example: **DE18 BI56(L)**

DE18 Pattern Number (left entry)
BI56(L)

Power Pole

Example: **DE2 PP64S, 117**

DE2 Pattern Number

PP64S

117 Soft Grey trim finish

Included with:

Base Power Infeed (L/R)

Power Pole

- Power pole
- Ceiling trim plate
- Connecting hardware
- Post/power pole trim cover

Note: Power pole does not include raceway-to-ceiling infeed which must be ordered separately.

Note: Power poles mount atop existing post connectors in "L", "T" and "X" configurations

Options

Base Power Infeed (L/R)

- To specify direction of entry, add either an "L" or "R" suffix to the pattern number.

Legacy Power Pole

- Post cover has a smooth finish

Dividends Horizon Power Pole

This page intentionally left blank

New York City Hardwire Infeeds

The New York City hardwire infeed is comprised of a junction box and a power connector exiting from one side.

New York City infeeds are available in one size which mount within any base raceway 24" or wider.

The New York City infeed takes the place of a power module and prevents the installation of duplex receptacles in the panel housing the infeed. The hardwire infeed's power connector plugs into a power module which must be located in the adjacent panel.

The New York City infeed can be rotated to either the right or left side of the base raceway to provide power to either the adjacent left or right panel.

If power is required in both directions, specify a separate power jumper the length of the panel containing the infeed. The power jumper connects panel power modules located at either side of the panel containing the NYC hardwire infeed and is routed within the same raceway as the NYC hardwire infeed.

The power jumper is then routed in the opposite direction and connects to a power module located in the adjacent panel on the panel's other side (refer to the diagram below).

The panel containing the NYC hardwire infeed must be specified without base raceway cover knockouts.

A template for drilling the base raceway cover to accept the NYC hardwire infeed conduit is included.

Chicago Hardwire

Pre-wired modular electrical systems are not permitted in the City of Chicago. All electrical must be hard-wired by a qualified electrician.

In order to conform to City of Chicago electrical codes, a hardwire receptacle raceway kit(s) must be installed in all panel base raceways that require duplex receptacles. In order to conform to the City of Chicago electrical code for base power infeed, the hardwire infeed raceway kit must be installed within the panel base raceway. Hardwire receptacle raceway kit(s) and hardwire infeed raceway kit(s) mount in the base raceway between the panel feet and are available in 24" to 48" widths.

Hardwire receptacle raceway kits are secured by four screws. In addition, the base raceway covers on both sides of a panel with hardwire receptacle raceway kits must be secured with two screws each. A template for drilling attachment holes in base raceway covers is included with the hardwire receptacle raceway kit.

Optional Chicago base raceway covers can be ordered separately to replace existing covers if pre-drilled covers are desired.

When passing (jumping) hardwired power through panels, panels must be specified without knockouts in the base raceway to conform to the City of Chicago electrical code. All panels containing hardwire receptacle raceway kits must be specified with base raceway knockouts.

Note: Dividends Horizon beltway electrical is not available with Chicago hardware.

New York Electrical Configurations

NYC Infeeds are reversible and one direction

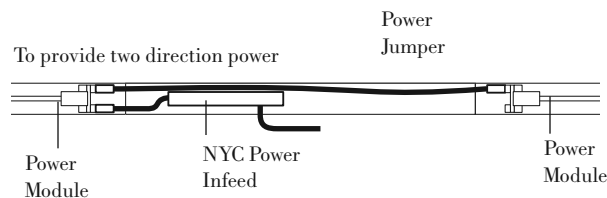
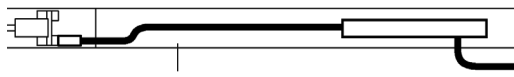

New York Electrical

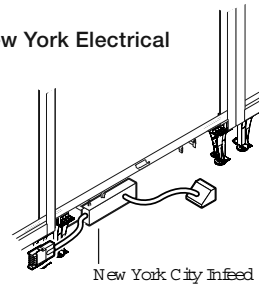

Chicago Electrical

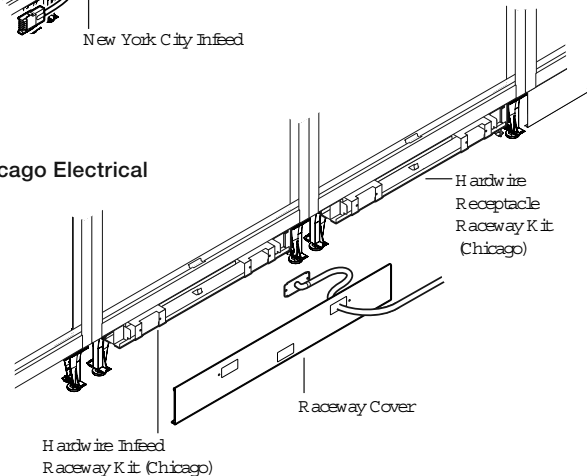

New York City, San Francisco and Chicago Electrical Infeeds and Retrofit Kit

Dividends Horizon

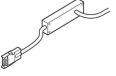
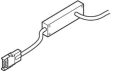
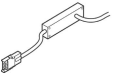
| description | type | l | pattern no. | list |
|--|------|-----|-----------------------|--------|
|  Hardwire Infeed (NYC) - 1 Direction | 2+2 | | DE18 B1NY1 | \$628. |
| | 3+1 | | DE1E B1NY1 | 545. |
| | 3+3 | | DE1T B1NY1 | 702. |
|  Base Power Infeed (San Francisco) | 2+2 | 56" | DE18 BI56()SF | 215. |
| | 3+1 | 56" | DE1E BI56()SF | 194. |
| | 3+3 | 56" | DE1T BI56()SF | 254. |
|  Reversible Base Power Infeed (San Francisco) | 2+2 | 56" | DE18 RBI56SF | 261. |
| | 3+1 | 56" | DE1E RBI56SF | 238. |
| | 3+3 | 56" | DE1T RBI56SF | 314. |
| Electrical Retrofit Kit (Chicago) (for electrical on new panel base raceway) | | | DP7CERK | 69. |

Ordering Information

Hardwire Infeed (NYC)

1. Pattern Number

Order Code

Hardwire Infeed (NYC)

Example: DE1E B1NY1

DE1E **Pattern Number**
B1NY1

Included with:

Hardwire Infeed (NYC)

- Junction box with power connector and infeed
- Ceiling trim plate
- Attachment screws

Options

Hardwire Infeed (NYC)

Power System

- 3+1
- 2+2
- 3+3

San Francisco Infeed direction option

(L) = Left
(R) = Right

Note: The electrical retrofit kit provides brackets that connect Chicago Electrical components that were manufactured prior to June 2008 to DP7 panel base raceways.

New York City, San Francisco and Chicago Electrical Infeeds, Receptacle Kits and Replacement Kits

Dividends Horizon

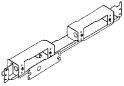
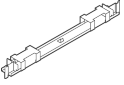
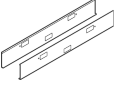
| description | type | l | pattern no. | list |
|--|----------------|-------------------|-------------------|--------|
|  Hardwire Infeed Raceway Kit (Chicago) | Double Sided | 24" | DP7HIRKD24 | \$385. |
| | Double Sided | 30" | DP7HIRKD30 | 653. |
| | Double Sided | 36" | DP7HIRKD36 | 659. |
| | Double Sided | 42" | DP7HIRKD42 | 664. |
| | Double Sided | 48" | DP7HIRKD48 | 668. |
| | Double Sided | 60" | DP7HIRKD60 | 679. |
| | Single Sided | 24" | DP7HIRKS24 | 542. |
| | Single Sided | 30" | DP7HIRKS30 | 771. |
| | Single Sided | 36" | DP7HIRKS36 | 776. |
| | Single Sided | 42" | DP7HIRKS42 | 779. |
| | Single Sided | 48" | DP7HIRKS48 | 783. |
| Single Sided | 60" | DP7HIRKS60 | 797. | |
|  Hardwire Receptacle Raceway Kit (Chicago) | Double Sided | 24" | DP7HRRKD24 | 296. |
| | Double Sided | 30" | DP7HRRKD30 | 497. |
| | Double Sided | 36" | DP7HRRKD36 | 502. |
| | Double Sided | 42" | DP7HRRKD42 | 505. |
| | Double Sided | 48" | DP7HRRKD48 | 511. |
| | Double Sided | 60" | DP7HRRKD60 | 524. |
| | Single Sided | 24" | DP7HRRKS24 | 343. |
| | Single Sided | 30" | DP7HRRKS30 | 484. |
| | Single Sided | 36" | DP7HRRKS36 | 489. |
| | Single Sided | 42" | DP7HRRKS42 | 489. |
| | Single Sided | 48" | DP7HRRKS48 | 494. |
| Single Sided | 60" | DP7HRRKS60 | 504. | |
|  Pre-Drilled Replacement Covers, Pair (Chicago) | 24" Wide Panel | 24" | DP7RCCH24 | 42. |
| | 30" Wide Panel | 30" | DP7RCCH30 | 46. |
| | 36" Wide Panel | 36" | DP7RCCH36 | 49. |
| | 42" Wide Panel | 42" | DP7RCCH42 | 57. |
| | 48" Wide Panel | 48" | DP7RCCH48 | 59. |
| | 60" Wide Panel | 60" | DP7RCCH60 | 69. |

Ordering Information

Hardwire Infeed (NYC)

1. Pattern Number

Order Code

Hardwire Infeed (NYC)

Example: DE1E B1NY1

DE1E **Pattern Number**
B1NY1

Included with:

Hardwire Infeed (NYC)

- Junction box with power connector and infeed
- Ceiling trim plate
- Attachment screws

Options

Hardwire Infeed (NYC)

Power System

- 3+1
- 2+2
- 3+3

San Francisco Infeed direction option

(L) = Left
(R) = Right

Note: The electrical retrofit kit provides brackets that connect Chicago Electrical components that were manufactured prior to June 2008 to DP7 panel base raceways.

This page intentionally left blank

Base Raceway Cable Tray

Optional steel cable trays are available for installations requiring the use of data and communications cables within the base raceway. The cable tray mounts between the panel feet.

Cable trays are field-installed and accessible from either side of the base raceway. A single sided base raceway cable tray should be specified when attaching to a tile-to-floor panel base.

Note: Cables should not be installed in base raceways without cable trays.

Beltway Cable Tray

An optional cable tray is available for data and communications cables within the beltway. Beltway cable trays should be used when wires are being routed horizontally from panel-to-panel at the beltway. The cable tray mounts into slots located on the vertical panel frame.

Cable trays are 1¹/₄" high, 1⁵/₁₆" deep and are field-installed. Construction is 20-gauge steel with black finish.

Note: Beltway cable trays can be installed in monolithic panels to provide additional mid span insert support when required.

Worksurface Cable Management Basket

Constructed of black finished steel wire, the worksurface cable management basket mounts to the underside of worksurfaces to provide management of excess cords and cables. Once installed, the cable management basket slides forward to a position abutting the panel face to allow the passage of cords and cables.

Specify by width available between worksurface supports. Black finish.

Worksurface cable management baskets are 1¹/₂" high, 3¹/₂" deep and 19¹/₂" to 41¹/₂" wide.

Vertical Wire Pathway Grommet

An optional plastic grommet that snaps into the vertical wire pathway on the horizontal panel frame to separate cables from the panel frame. Located in center of topway and base raceway.

Topway Cable Grommet

The primary location for cable management for Dividends Horizon is in the topway. In order to utilize the topway channel effectively, the outside knockouts must be removed by using pliers. When the knockouts are removed the cables can be easily managed in the channel.

If required, a topway knockout grommet may be installed inside of the topway channel. Four grommets would be required per panel topway.





Worksurface Cable Management Clip

An optional cable management clip. 3/4" x 1/2" (internal dimension) plastic clip manages cables on the underside of worksurfaces.

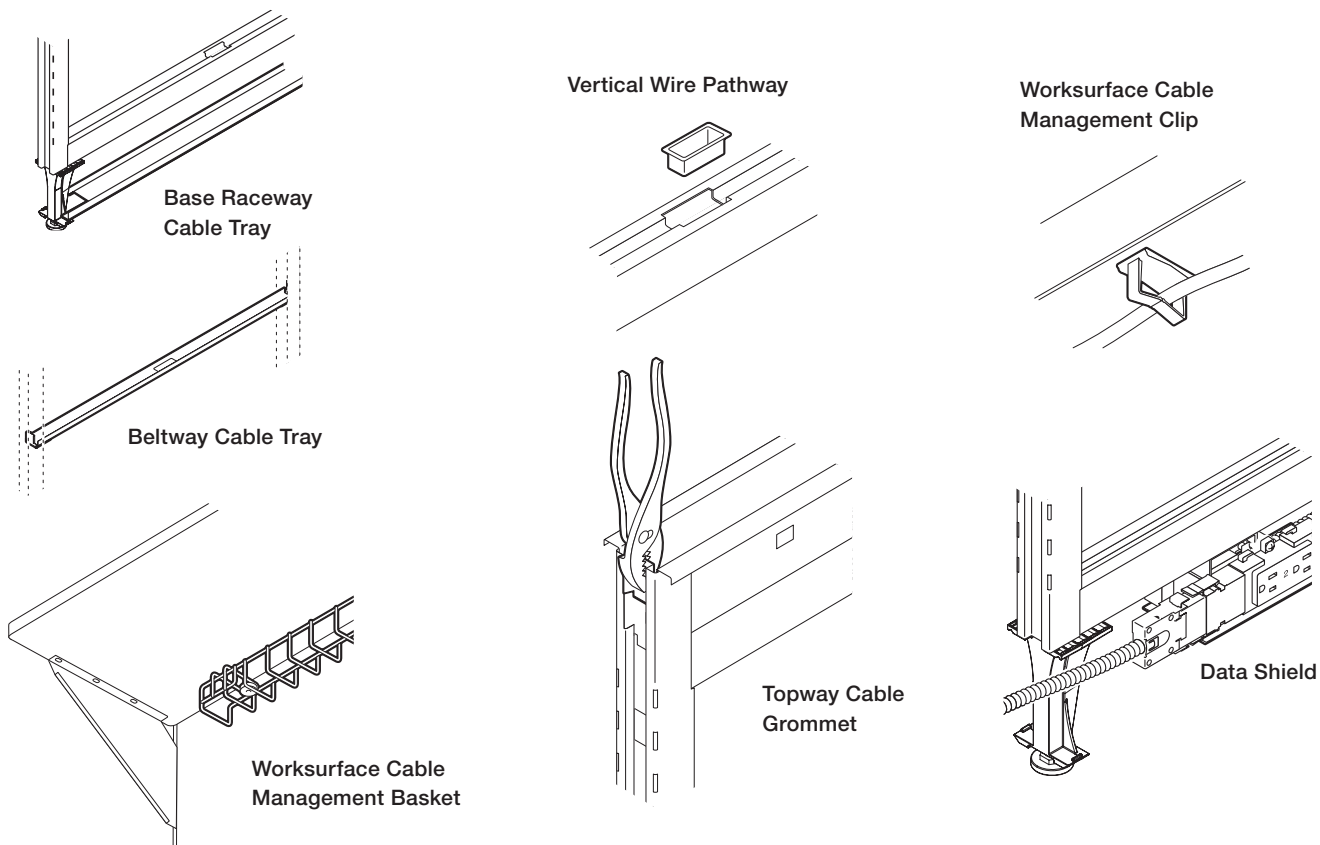
Data Shield

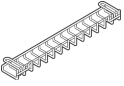
If separation of cabling and electrical wires is required within the base raceway, a data shield can be attached below a base raceway power module at either end. Data shields are field-installed. The data shield should be used with base raceway panels or tile to floor panels only.

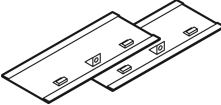

| description | type | pattern no. | list |
|---|-----------------------------------|-------------------|-------|
|  Worksurface Cable Management Basket | 19 1/2" wide | D1WB20 | \$43. |
| | 25 1/2" wide | D1WB26 | 45. |
| | 31 1/2" wide | D1WB32 | 57. |
| | 35" wide | D1WB36 | 62. |
| | 41" wide | D1WB42 | 66. |
|  Vertical Wire Pathway Grommet (optional) | Package of 10 | DP1 VWG | 182. |
|  Topway Cable Grommet | Package of 40 | DP1 TKC | 63. |
|  Worksurface Cable Management Clip | Package of 10 | D1WC | 41. |
|  Data Shield | 1 Pair for use with base raceway | DE1DATSHD | 32. |
| | 1 Pair for use with tile to floor | DE1DATSHDF | 32. |

Ordering Information

Base Raceway Cable Tray

1. Pattern Number

Order Code

Base Raceway Cable Tray

Example: **DP1 RCT24**

DP1 Pattern Number
RCT24

Included with:

Base Raceway Cable Tray

Options

Base Raceway Cable Tray



Note: DP7 cable trays are for use with all DP7 series panels and all panels produced prior to November 2007.

Note: Data Shield is not compatible with open base panels.

Cable Management

Base Raceway and Beltway Cable Trays

Dividends Horizon

| description | type | pattern no. | list |
|--|-----------------|------------------|-------|
| Base Raceway Cable Tray - double sided for use with raceway on both sides (optional)  | 18" Panel Width | DP72RCT18 | \$26. |
| | 24" Panel Width | DP72RCT24 | 28. |
| | 30" Panel Width | DP72RCT30 | 32. |
| | 36" Panel Width | DP72RCT36 | 34. |
| | 42" Panel Width | DP72RCT42 | 36. |
| | 48" Panel Width | DP72RCT48 | 41. |
| | 60" Panel Width | DP72RCT60 | 44. |
| Base Raceway Cable Tray - single sided for use with raceway on one side (optional)  | 18" Panel Width | DP71RCT18 | 26. |
| | 24" Panel Width | DP71RCT24 | 28. |
| | 30" Panel Width | DP71RCT30 | 32. |
| | 36" Panel Width | DP71RCT36 | 34. |
| | 42" Panel Width | DP71RCT42 | 36. |
| | 48" Panel Width | DP71RCT48 | 41. |
| | 60" Panel Width | DP71RCT60 | 44. |
| Beltway Cable Tray (optional)  | 18" Panel Width | DP1BCT18 | 28. |
| | 24" Panel Width | DP1BCT24 | 29. |
| | 30" Panel Width | DP1BCT30 | 33. |
| | 36" Panel Width | DP1BCT36 | 35. |
| | 42" Panel Width | DP1BCT42 | 38. |
| | 48" Panel Width | DP1BCT48 | 42. |
| | 60" Panel Width | DP1BCT60 | 61. |

Ordering Information

Base Raceway Cable Tray
1. Pattern Number

Order Code

Base Raceway Cable Tray
Example: **DP1 RCT24**
DP1 Pattern Number
RCT24

Included with:

Base Raceway Cable Tray

Options

Base Raceway Cable Tray
Note: DP7 cable trays are for use with all DP7 series panels and all panels produced prior to November 2007.

This page intentionally left blank

Flip-Up Door Overheads

Panel- and Wall-Mounted

Dividends Series 1, Series 2 and Series 3 Overheads - Specifications

Flip-Up Door Overheads

Flip-up overheads mount to the integral vertical channels on Dividends Horizon panels or wall mount tracks to provide overhead storage within workstations or private offices.

Flip-up overhead cabinets consist of a top, shelf, end panels, overhead door with or without lock and required assembly screws. 30" to 48" wide cabinets have single doors while cabinets 54", 60", 66" and 72" wide have double doors. 54" wide overhead cabinets will ship with one 24" and one 30" door. 66" wide overhead cabinets will ship with one 30" and one 36" door. 54" and 66" overhead doors may be removed and reversed.

Overheads must match the width of single or multiple panels and cannot be mounted off-module. All cabinets are shipped knocked-down.

Series 1 Flip-up Door Overhead

Series 1 flip-up overhead cabinets match the aesthetics of the original Dividends Horizon system. The radiused fronts and molded plastic end trim match the radiused profile trim used on panel topcaps and end trim. Series 1 cabinets are offered with steel doors.

Series 2 Flip-up Door Overhead

Series 2 overhead cabinets offer an alternative aesthetic to the original Dividends Horizon Series 1 overhead. Unlike the radiused door profile of the Series 1 overhead door, the Series 2 door profile is rectilinear with soft radiused corners (see door profile drawing below). The Series 2 overhead offers a painted steel or veneer overhead door front.

Series 3 Flip-up Door Overhead

Series 3 cabinets offer a third aesthetic choice for flip-up overhead cabinets. The series 3 door profile is similar to the rectilinear door of the Series 2 cabinet, but the corners have a sharper radius to complement Dividends Horizon flat profile trim. Series 3 cabinets are offered with steel, laminate or veneer doors.

Note: Horizon Series 3 overheads are designed to complement and work next to other Series 3 overheads only.

Available Sizes

- Height: 15"
- Depth: 14¹/₈"
- Widths: 24", 30", 36", 42", 48", 54" 60", 66" and 72"

Construction:

- **Horizontal top and shelf:** 18-gauge (30" to 48" wide), 16-gauge (60" to 72" wide) painted roll-formed steel
- **Overhead door:**
 - Steel: 20-gauge painted steel
 - Laminate: 3/4" particle board with high pressure laminate on the outside and a paper backer on the inside. 1mm edgeband.
 - Veneer: 3/4" thick particle board with 0.6mm thick veneer on the top and edge.
- **Overhead door end trim:** Color injected, molded plastic (on Series 1 only)
- **End panels:** 16-gauge painted steel with integral mounting hooks
- **Overhead door suspension:** Steel ball bearing

Interior Dimensions

The interior dimensions of overhead cabinets and shelves are:

- Depth: 12"
- Usable interior height: 12⁵/₈"
- Width: 1/8" shorter than the exterior width

Cabinet Door Clearance

Cabinet doors open over the tops of cabinets. Required clearance is 16¹/₄" total height (height of cabinet plus top clearance required).

Touchdown Overhead Cabinets

Touchdown overhead cabinets are equipped with hydraulic assist cylinders that allow the overhead cabinet front to gently fall to a closed position.

Retrofit mechanisms may be field added to any flip-up overhead cabinet with a steel door.

Note: Touchdown mechanisms are not available with laminate or veneer doors.

Task Lights

All Dividends cabinets and shelves will accept task lights. Task lights must be specified separately.

Locks

Locks are standard on overhead cabinets and keyed randomly unless otherwise specified. Other keying options include keyed alike or keyed with lock cores K001-K250. All locks are factory-installed and are black finish. Cabinets can also be specified without locks if required. When locks are not specified on Series 1 and Series 2 overheads, a plug is located in the lock position. Lock retrofit kits are available for field installation at a later date for Series 1 and Series 2 overheads only.

Note: Horizon Series 3 flip-up overheads are only available in Knoll Core finishes.

Flip-up Door Overhead Configurations

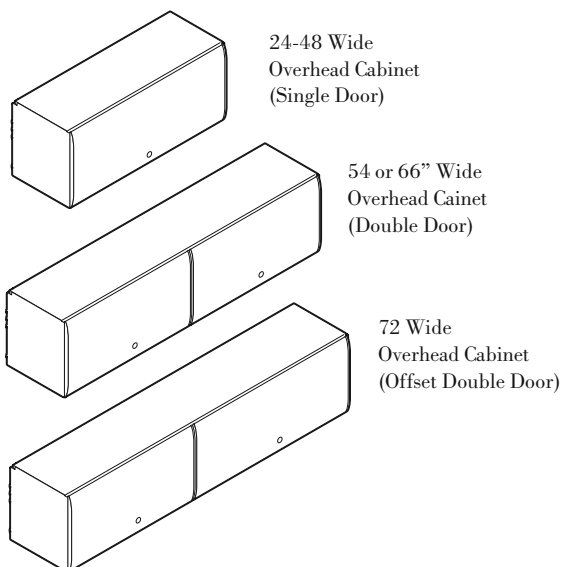

Interior Dimensions

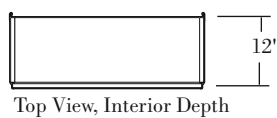
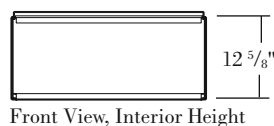

Cabinet Door Clearance

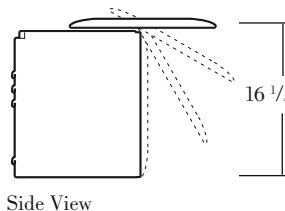

Flip-up Door Overhead Profiles

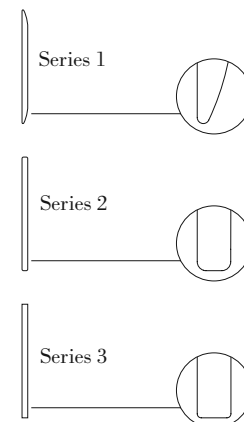

Flip-Up Door Overheads

Panel- and Wall-Mounted

Dividends Series 1, Series 2 and Horizon Series 3

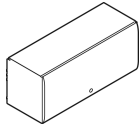
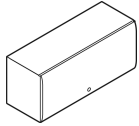
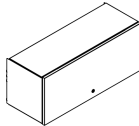
| description | w* | w | d | h | pattern no. | P1 | P2 | P3 | V1-P1 | V1-P2 | V1-P3 |
|--|-----|---------|---------|-----|------------------|--------|--------|--------|--------|--------|--------|
| Dividends Series 1 Flip-Up Overhead w/Steel Door  | 24" | 23 7/8" | 14 1/8" | 15" | DS1O24L | \$395. | \$434. | \$451. | n/a | n/a | n/a |
| | 30" | 29 7/8" | 14 1/8" | 15" | DS1O30L | 395. | 434. | 451. | n/a | n/a | n/a |
| | 36" | 35 7/8" | 14 1/8" | 15" | DS1O36L | 416. | 456. | 477. | n/a | n/a | n/a |
| | 42" | 41 7/8" | 14 1/8" | 15" | DS1O42L | 440. | 486. | 506. | n/a | n/a | n/a |
| | 48" | 47 7/8" | 14 1/8" | 15" | DS1O48L | 454. | 503. | 524. | n/a | n/a | n/a |
| | 54" | 53 7/8" | 14 1/8" | 15" | DS1O54L | 671. | 736. | 771. | n/a | n/a | n/a |
| | 60" | 59 7/8" | 14 1/8" | 15" | DS1O60L | 671. | 736. | 771. | n/a | n/a | n/a |
| | 66" | 65 7/8" | 14 1/8" | 15" | DS1O66L | 692. | 762. | 797. | n/a | n/a | n/a |
| | 72" | 71 7/8" | 14 1/8" | 15" | DS1O72L | 692. | 762. | 797. | n/a | n/a | n/a |
| Series 2 Flip-Up Overhead w/ Steel or Veneer Door  | 24" | 23 7/8" | 14 1/8" | 15" | DS2PM24L | 511. | 591. | 617. | 802. | 881. | 904. |
| | 30" | 29 7/8" | 14 1/8" | 15" | DS2PM30L | 511. | 591. | 617. | 802. | 881. | 904. |
| | 36" | 35 7/8" | 14 1/8" | 15" | DS2PM36L | 556. | 641. | 668. | 811. | 893. | 922. |
| | 42" | 41 7/8" | 14 1/8" | 15" | DS2PM42L | 608. | 698. | 726. | 830. | 924. | 954. |
| | 48" | 47 7/8" | 14 1/8" | 15" | DS2PM48L | 668. | 766. | 802. | 891. | 991. | 1,026. |
| | 54" | 53 7/8" | 14 1/8" | 15" | DS2PM54L | 792. | 913. | 954. | 1,270. | 1,387. | 1,428. |
| | 60" | 59 7/8" | 14 1/8" | 15" | DS2PM60L | 792. | 913. | 954. | 1,270. | 1,387. | 1,428. |
| | 66" | 65 7/8" | 14 1/8" | 15" | DS2PM66L | 884. | 1,016. | 1,061. | 1,328. | 1,461. | 1,506. |
| | 72" | 71 7/8" | 14 1/8" | 15" | DS2PM72L | 884. | 1,016. | 1,061. | 1,328. | 1,461. | 1,506. |
| Dividends "touchdown" retro-fit (two kits required for 54"w - 72"w) | | | | | DS1EAKIT | 270. | | | | | |
| Series 3 Flip-Up Overhead w/ Steel Door  | 30" | 29 7/8" | 14 1/2" | 15" | DS3PMS30L | 504. | 556. | 582. | | | |
| | 36" | 35 7/8" | 14 1/2" | 15" | DS3PMS36L | 520. | 573. | 598. | | | |
| | 42" | 41 7/8" | 14 1/2" | 15" | DS3PMS42L | 536. | 591. | 618. | | | |
| | 48" | 47 7/8" | 14 1/2" | 15" | DS3PMS48L | 554. | 609. | 636. | | | |
| | 60" | 59 7/8" | 14 1/2" | 15" | DS3PMS60L | 698. | 769. | 805. | | | |
| | 66" | 65 7/8" | 14 1/2" | 15" | DS3PMS66L | 760. | 836. | 876. | | | |
| | 72" | 71 7/8" | 14 1/2" | 15" | DS3PMS72L | 760. | 836. | 876. | | | |

w* = nominal width
 Dimensions listed under w h d are actual to the nearest 1/16"

| Ordering Information | Order Code | Included with: | Options |
|---|---|---|--|
| Dividends Series 1 Flip-Up Door Overhead 1. Pattern Number 2. Paint Finish 3. Door End Cap Finish Series 2 Flip-Up Door Overhead 1. Pattern Number 2. Paint Finish 3. Door Finish (veneer door only) Series 3 Flip-Up Door Overhead 1. Pattern Number 2. Paint Finish case 3. Door Finish (laminated and veneer door only) 4. Door Edge Finish (laminated door only) | Dividends Series 1 Flip-Up Door Overhead <i>Example:</i> DS1O 30L, 113, 113 DS1O 30L Pattern Number 113 Dark grey paint finish 113 Dark grey End cap finish Series 2 Flip-Up Overhead w/ Steel Door <i>Example:</i> DS2PM 30L, 115 DS2PM Pattern Number 30L 115 Medium grey paint finish | Dividends Series 1 Flip-Up Door Overhead Series 2 Flip-Up Overhead Series 3 Flip-Up Overhead Note: Touchdown mechanism not available on veneer or laminate front Flip-Up overheads. Note: Series 3 Horizon overheads are only available in Knoll core finishes. Wallmount bracket specified separately. | Flip-Up Door Door Overhead To specify overhead cabinet without locks replace the "L" suffix from the pattern number with "N" Deduct \$20. For 54", 60", 66" and 72" overhead cabinets Deduct \$40 To specify Touchdown overhead cabinet, add "E" as the 2nd to last digit of the pattern number <i>Example:</i> DS3PML48EL (Add \$163 for cabinet widths of 48" or less. Add \$327 for cabinet widths of 54" or greater). Series 2 and Series 3 Flip-Up Door Overhead Finish Option: Add a "Y" to the end of the pattern number to specify a different finish for the door versus the case. Use P3 pricing for this dual finish option. |

Storage Components

Flip-Up Door Overheads

Panel- and Wall-Mounted

Dividends Series 1, Series 2 and Horizon Series 3

Dividends Horizon

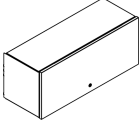
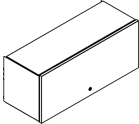
| description | w* | w | d | h | pattern no. | P1 | P2 | P3 | V1-P1 | V1-P2 | V1-P3 |
|--|-----|----------------------------------|----------------------------------|-----|------------------|--------|--------|--------|-------|-------|-------|
| Series 3 Flip-Up Overhead w/ Laminate Door  | 30" | 29 ⁷ / ₈ " | 14 ¹ / ₂ " | 15" | DS3PML30L | \$762. | \$851. | \$887. | | | |
| | 36" | 35 ⁷ / ₈ " | 14 ¹ / ₂ " | 15" | DS3PML36L | 798. | 873. | 912. | | | |
| | 42" | 41 ⁷ / ₈ " | 14 ¹ / ₂ " | 15" | DS3PML42L | 821. | 899. | 939. | | | |
| | 48" | 47 ⁷ / ₈ " | 14 ¹ / ₂ " | 15" | DS3PML48L | 870. | 955. | 996. | | | |
| | 60" | 59 ⁷ / ₈ " | 14 ¹ / ₂ " | 15" | DS3PML60L | 1,302. | 1,427. | 1,490. | | | |
| | 66" | 65 ⁷ / ₈ " | 14 ¹ / ₂ " | 15" | DS3PML66L | 1,321. | 1,451. | 1,526. | | | |
| | 72" | 71 ⁷ / ₈ " | 14 ¹ / ₂ " | 15" | DS3PML72L | 1,359. | 1,496. | 1,561. | | | |
| Series 3 Flip-Up Overhead w/ Veneer Door  | 30" | 29 ⁷ / ₈ " | 14 ¹ / ₂ " | 15" | DS3PMV30L | 1,055. | 1,154. | 1,207. | | | |
| | 36" | 35 ⁷ / ₈ " | 14 ¹ / ₂ " | 15" | DS3PMV36L | 1,077. | 1,182. | 1,236. | | | |
| | 42" | 41 ⁷ / ₈ " | 14 ¹ / ₂ " | 15" | DS3PMV42L | 1,103. | 1,212. | 1,266. | | | |
| | 48" | 47 ⁷ / ₈ " | 14 ¹ / ₂ " | 15" | DS3PMV48L | 1,151. | 1,252. | 1,308. | | | |
| | 60" | 59 ⁷ / ₈ " | 14 ¹ / ₂ " | 15" | DS3PMV60L | 1,856. | 2,038. | 2,129. | | | |
| | 66" | 65 ⁷ / ₈ " | 14 ¹ / ₂ " | 15" | DS3PMV66L | 1,906. | 2,097. | 2,202. | | | |
| | 72" | 71 ⁷ / ₈ " | 14 ¹ / ₂ " | 15" | DS3PMV72L | 1,923. | 2,109. | 2,206. | | | |

w* = nominal width

Dimensions listed under w h d are actual to the nearest 1/16"

| Ordering Information | Order Code | Included with: | Options |
|--|---|---|--|
| Dividends Series 1 Flip-Up Door Overhead 1. Pattern Number 2. Paint Finish 3. Door End Cap Finish Series 2 Flip-Up Door Overhead 1. Pattern Number 2. Paint Finish 3. Door Finish (veneer door only) Series 3 Flip-Up Door Overhead 1. Pattern Number 2. Paint Finish case 3. Door Finish (laminated and veneer door only) 4. Door Edge Finish (laminated door only) | Dividends Series 1 Flip-Up Door Overhead <i>Example:</i> DS10 30L, 113, 113 DS10 30L Pattern Number 113 Dark grey paint finish 113 Dark grey End cap finish Series 2 Flip-Up Overhead w/ Steel Door <i>Example:</i> DS2PM 30L, 115 DS2PM Pattern Number 30L 115 Medium grey paint finish | Dividends Series 1 Flip-Up Door Overhead Series 2 Flip-Up Overhead Series 3 Flip-Up Overhead Note: Touchdown mechanism not available on veneer or laminate front Flip-Up overheads. Note: Series 3 Horizon overheads are only available in Knoll core finishes. Wallmount bracket specified separately. | Flip-Up Door Door Overhead To specify overhead cabinet without locks replace the "L" suffix from the pattern number with "N" Deduct \$20. For 54", 60", 66" and 72" overhead cabinets Deduct \$40 To specify Touchdown overhead cabinet, add "E" as the 2nd to last digit of the pattern number <i>Example:</i> DS3PML48EL (Add \$163 for cabinet widths of 48" or less. Add \$327 for cabinet widths of 54" or greater). Series 2 and Series 3 Flip-Up Door Overhead Finish Option: Add a "Y" to the end of the pattern number to specify a different finish for the door versus the case. Use P3 pricing for this dual finish option. |

This page intentionally left blank

Sliding Door Overheads

Panel-, Center- and Wall-Mounted Specifications

Sliding Door Overheads

Sliding door overheads complement the aesthetic of the Dividends Horizon system. The rectilinear door profile was designed to match Dividends Horizon flat profile trim details.

Dividends Horizon sliding door overhead cabinets mount to integral vertical channels on Dividends Horizon panels or wall mount tracks to provide overhead storage within workstations or private offices.

Sliding door overhead cabinets consist of a top, shelf, mid cabinet septum, end panels and a door with handle. Units are available with or without locks.

Overheads must match the width of single or multiple panels and cannot be mounted off-module. All cabinets are shipped knocked-down.

Note: Series 3 overheads are designed to complement and work next to other Series 3 overheads only.

Available Sizes

- Height: 14" and 21"
- Depth: 13¹/₂"
- Widths: 30", 36", 42", 48", 54", 60", 66" and 72"

Construction:

- **Horizontal top and shelf:** 18-gauge (30" to 48" wide), 16-gauge (60" to 72" wide) painted roll-formed steel
- **Sliding door:**
 - Steel: 20-gauge painted steel
 - Laminate: 3/4" particle board with high pressure laminate on the outside and a paper backer on the inside. 1mm edgeband.
 - Veneer: 3/4" thick particle board with 0.6mm thick veneer on the top and edge.
- **Fixed shelf:** 16-gauge painted steel
- **End panels:** 16-gauge painted steel with integral mounting hooks
- **Sliding door mechanism:** Integral track in top and bottom shelves with full length abs plastic extrusion. Door brackets are injection molded nylon.
- **Door handle:** painted aluminum (same color as case)

Interior Dimensions

The interior dimensions of overhead cabinets and shelves are:

- Depth: 12¹/₄"
- Usable interior height: 12⁵/₈"
- Width: 1/8" shorter than the exterior width

Task Lights

All Dividends Horizon cabinets and shelves will accept task lights. Task lights must be ordered separately.

Locks

Locks are standard on overhead cabinets and keyed randomly unless otherwise specified. All locks are factory-installed and are black finish. Cabinets can also be specified without locks if required.

Note: Horizon sliding door overheads are only available in Knoll Core finishes.

Sliding Door Overhead Configurations

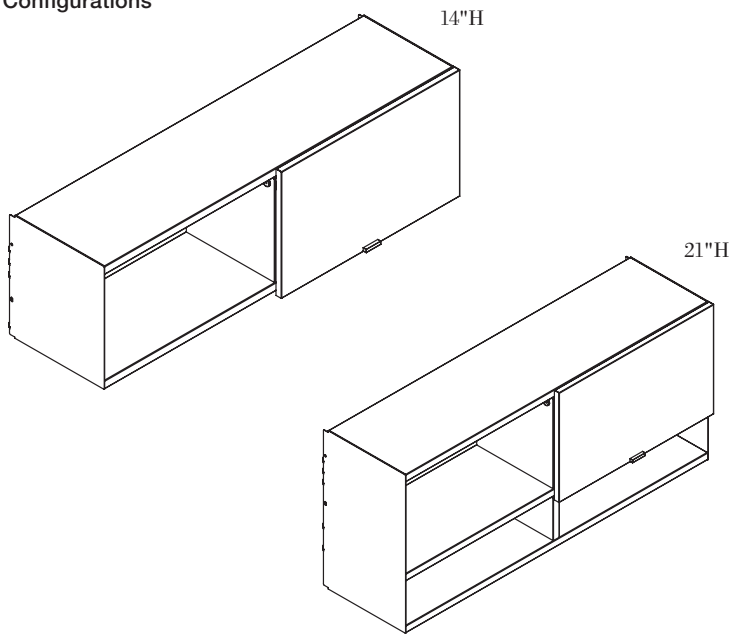

Interior Dimensions for 14"H Overhead

Front View, Interior Height

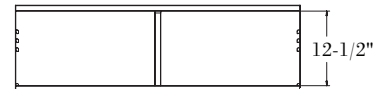

Top View, Interior Height

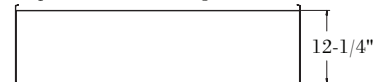

Interior Dimensions for 21"H Overhead

Front View, Interior Height

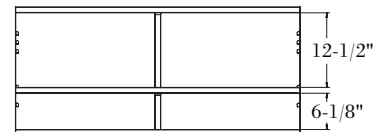

Top View, Interior Height

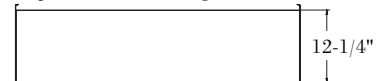

Sliding Door Overheads

14" High Panel-Mounted

Dividends Horizon and Template Doors

Dividends Horizon

| description | w * | w | d | h | pattern no. | P1 | P2 | P3 |
|---|----------------------------------|-----|----------------------------------|-----|--------------------|--------|--------|--------|
| Dividends Horizon Panel-Mounted Overhead without Door | 29 ⁷ / ₈ " | 30" | 12 ¹ / ₂ " | 14" | DS3PMNS3014 | \$300. | \$330. | \$346. |
| | 35 ⁷ / ₈ " | 36" | 12 ¹ / ₂ " | 14" | DS3PMNS3614 | 312. | 344. | 361. |
| | 41 ⁷ / ₈ " | 42" | 12 ¹ / ₂ " | 14" | DS3PMNS4214 | 321. | 355. | 370. |
| | 47 ⁷ / ₈ " | 48" | 12 ¹ / ₂ " | 14" | DS3PMNS4814 | 333. | 367. | 382. |
| | 59 ⁷ / ₈ " | 60" | 12 ¹ / ₂ " | 14" | DS3PMNS6014 | 380. | 418. | 438. |
| | 65 ⁷ / ₈ " | 66" | 12 ¹ / ₂ " | 14" | DS3PMNS6614 | 393. | 431. | 450. |
| | 71 ⁷ / ₈ " | 72" | 12 ¹ / ₂ " | 14" | DS3PMNS7214 | 402. | 443. | 463. |

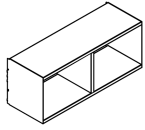

| | | | | | | | | |
|---|----------------------------------|-----|-----|-----|-------------------------|--------|--------|--------|
| Template Panel-Mounted Sliding Door Overhead with Steel Doors | 35 ⁷ / ₈ " | 36" | 15" | 14" | DS3PMT(S/G)3614L | 652. | 718. | 750. |
| | 41 ⁷ / ₈ " | 42" | 15" | 14" | DS3PMT(S/G)4214L | 676. | 744. | 777. |
| | 47 ⁷ / ₈ " | 48" | 15" | 14" | DS3PMT(S/G)4814L | 697. | 765. | 801. |
| | 59 ⁷ / ₈ " | 60" | 15" | 14" | DS3PMT(S/G)6014L | 994. | 1,095. | 1,143. |
| | 71 ⁷ / ₈ " | 72" | 15" | 14" | DS3PMT(S/G)7214L | 1,052. | 1,156. | 1,211. |

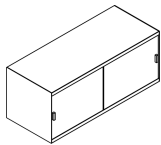

| | | | | | | | | |
|--|----------------------------------|-----|----------------------------------|-----|---------------------|------|------|------|
| Dividends Horizon Panel-Mounted Sliding Door Overhead w/Steel Door | 29 ⁷ / ₈ " | 30" | 13 ¹ / ₂ " | 14" | DS3PMSS3014L | 497. | 547. | 572. |
| | 35 ⁷ / ₈ " | 36" | 13 ¹ / ₂ " | 14" | DS3PMSS3614L | 510. | 562. | 590. |
| | 41 ⁷ / ₈ " | 42" | 13 ¹ / ₂ " | 14" | DS3PMSS4214L | 527. | 581. | 605. |
| | 47 ⁷ / ₈ " | 48" | 13 ¹ / ₂ " | 14" | DS3PMSS4814L | 536. | 591. | 618. |
| | 59 ⁷ / ₈ " | 60" | 13 ¹ / ₂ " | 14" | DS3PMSS6014L | 605. | 668. | 697. |
| | 65 ⁷ / ₈ " | 66" | 13 ¹ / ₂ " | 14" | DS3PMSS6614L | 622. | 685. | 716. |
| | 71 ⁷ / ₈ " | 72" | 13 ¹ / ₂ " | 14" | DS3PMSS7214L | 632. | 695. | 726. |

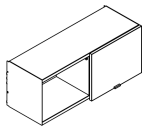

| | | | | | | | | |
|--|----------------------------------|-----|----------------------------------|-----|---------------------|--------|--------|--------|
| Dividends Horizon Panel-Mounted Sliding Door Overhead w/ Laminate Door | 29 ⁷ / ₈ " | 30" | 13 ¹ / ₂ " | 14" | DS3PMSL3014L | 858. | 942. | 985. |
| | 35 ⁷ / ₈ " | 36" | 13 ¹ / ₂ " | 14" | DS3PMSL3614L | 882. | 967. | 1,010. |
| | 41 ⁷ / ₈ " | 42" | 13 ¹ / ₂ " | 14" | DS3PMSL4214L | 907. | 994. | 1,040. |
| | 47 ⁷ / ₈ " | 48" | 13 ¹ / ₂ " | 14" | DS3PMSL4814L | 930. | 1,020. | 1,066. |
| | 59 ⁷ / ₈ " | 60" | 13 ¹ / ₂ " | 14" | DS3PMSL6014L | 955. | 1,048. | 1,094. |
| | 65 ⁷ / ₈ " | 66" | 13 ¹ / ₂ " | 14" | DS3PMSL6614L | 979. | 1,074. | 1,120. |
| | 71 ⁷ / ₈ " | 72" | 13 ¹ / ₂ " | 14" | DS3PMSL7214L | 1,002. | 1,099. | 1,148. |

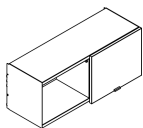

w* = nominal width
Dimensions listed under w h d are actual to the nearest 1/16"

| Ordering Information | Order Code | Included With | Options |
|---|---|---|---|
| Sliding Door Overheads: 1. Pattern number 2. Paint finish case 3. Door finish (laminated and veneer door only) 4. Door edge finish (laminated door only) | Sliding Door Overhead w/ Steel Door <i>Example:</i> DS3PMSS3014L /117/117 DS3PMSS Pattern Number 3014L 117 Dark grey paint finish case | Sliding Door Overhead Note: Sliding door overheads are only available in Knoll core finishes. Specify one of the following for Template Glass door option: (Temp) = Clear (GL13) = Powder (GL25) = Bronze (GL35) = Grey | Sliding Door Overhead Lock/No lock For non-locking units substitute the "L" suffix with a "N" and deduct \$20.00 from the list price. Paint Configuration Option: Add "Y" at the end of the pattern number to specify a different paint finish on the case and sliding door. P3 pricing applies to all products with dual paint finishes. |

Overheads with Template style doors only accept LED task light. T5 task light mounting brackets are not compatible.

Sliding Door Overheads

14" High Panel-Mounted

Dividends Horizon and Template Doors

Dividends Horizon

| description | w* | w | d | h | pattern no. | P1 | P2 | P3 |
|--------------------------------------|----------------------------------|-----|----------------------------------|-----|---------------------|--------|----------|----------|
| Dividends Horizon Panel-Mounted | 29 ⁷ / ₈ " | 30" | 13 ¹ / ₂ " | 14" | DS3PMSV3014L | \$948. | \$1,040. | \$1,087. |
| Sliding Door Overhead w/ Veneer Door | 35 ⁷ / ₈ " | 36" | 13 ¹ / ₂ " | 14" | DS3PMSV3614L | 979. | 1,073. | 1,120. |
| | 41 ⁷ / ₈ " | 42" | 13 ¹ / ₂ " | 14" | DS3PMSV4214L | 1,007. | 1,107. | 1,154. |
| | 47 ⁷ / ₈ " | 48" | 13 ¹ / ₂ " | 14" | DS3PMSV4814L | 1,039. | 1,140. | 1,190. |
| | 59 ⁷ / ₈ " | 60" | 13 ¹ / ₂ " | 14" | DS3PMSV6014L | 1,070. | 1,174. | 1,225. |
| | 65 ⁷ / ₈ " | 66" | 13 ¹ / ₂ " | 14" | DS3PMSV6614L | 1,099. | 1,207. | 1,260. |
| | 71 ⁷ / ₈ " | 72" | 13 ¹ / ₂ " | 14" | DS3PMSV7214L | 1,130. | 1,241. | 1,297. |

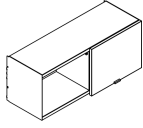

w* = nominal width
 Dimensions listed under w h d are actual to the nearest 1/16"

| Ordering Information | Order Code | Included With | Options |
|---|---|---|--|
| Sliding Door Overheads: 1. Pattern number 2. Paint finish case 3. Door finish (laminate and veneer door only) 4. Door edge finish (laminate door only) | Sliding Door Overhead w/ Steel Door <i>Example:</i> DS3PMSS3014L /117/117 DS3PMSS Pattern Number 3014L 117 Dark grey paint finish case | Sliding Door Overhead Note: Sliding door overheads are only available in Knoll core finishes. Specify one of the following for Template Glass door option: (Temp) = Clear (GL13) = Powder (GL25) = Bronze (GL35) = Grey | Sliding Door Overhead Lock/No lock For non-locking units substitute the "L" suffix with a "N" and deduct \$20.00 from the list price. Paint Configuration Option: Add "Y" at the end of the pattern number to specify a different paint finish on the case and sliding door. P3 pricing applies to all products with dual paint finishes. Overheads with Template style doors only accept LED task light. T5 task light mounting brackets are not compatible. |

Sliding Door Overheads

21" High Panel-Mounted

Dividends Horizon Full Height Door

Dividends Horizon

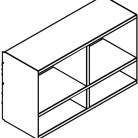
| description | w* | w | d | h | pattern no. | P1 | P2 | P3 |
|---|----------------------------------|-----|----------------------------------|-----|--------------------|--------|--------|--------|
|  Dividends Horizon Panel-Mounted Overhead without Door | 29 ⁷ / ₈ " | 30" | 12 ¹ / ₂ " | 21" | DS3PMNS3021 | \$415. | \$457. | \$477. |
| | 35 ⁷ / ₈ " | 36" | 12 ¹ / ₂ " | 21" | DS3PMNS3621 | 433. | 474. | 497. |
| | 41 ⁷ / ₈ " | 42" | 12 ¹ / ₂ " | 21" | DS3PMNS4221 | 447. | 491. | 512. |
| | 47 ⁷ / ₈ " | 48" | 12 ¹ / ₂ " | 21" | DS3PMNS4821 | 463. | 508. | 531. |
| | 59 ⁷ / ₈ " | 60" | 12 ¹ / ₂ " | 21" | DS3PMNS6021 | 527. | 581. | 605. |
| | 65 ⁷ / ₈ " | 66" | 12 ¹ / ₂ " | 21" | DS3PMNS6621 | 431. | 473. | 495. |
| | 71 ⁷ / ₈ " | 72" | 12 ¹ / ₂ " | 21" | DS3PMNS7221 | 558. | 616. | 642. |

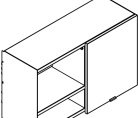
| | | | | | | | | |
|---|----------------------------------|-----|----------------------------------|-----|----------------------|------|------|------|
|  Dividends Horizon Panel-Mounted Sliding Door Overhead w/ Steel Door | 29 ⁷ / ₈ " | 30" | 13 ¹ / ₂ " | 21" | DS3PMSS3021FL | 646. | 711. | 743. |
| | 35 ⁷ / ₈ " | 36" | 13 ¹ / ₂ " | 21" | DS3PMSS3621FL | 668. | 735. | 766. |
| | 41 ⁷ / ₈ " | 42" | 13 ¹ / ₂ " | 21" | DS3PMSS4221FL | 690. | 757. | 792. |
| | 47 ⁷ / ₈ " | 48" | 13 ¹ / ₂ " | 21" | DS3PMSS4821FL | 708. | 777. | 814. |
| | 59 ⁷ / ₈ " | 60" | 13 ¹ / ₂ " | 21" | DS3PMSS6021FL | 811. | 891. | 933. |
| | 65 ⁷ / ₈ " | 66" | 13 ¹ / ₂ " | 21" | DS3PMSS6621FL | 833. | 916. | 958. |
| | 71 ⁷ / ₈ " | 72" | 13 ¹ / ₂ " | 21" | DS3PMSS7221FL | 850. | 934. | 976. |

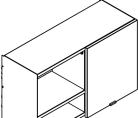
| | | | | | | | | |
|---|----------------------------------|-----|----------------------------------|-----|----------------------|--------|--------|--------|
|  Dividends Horizon Panel-Mounted Sliding Door Overhead w/ Laminate Door | 29 ⁷ / ₈ " | 30" | 13 ¹ / ₂ " | 21" | DS3PMSL3021FL | 1,070. | 1,174. | 1,224. |
| | 35 ⁷ / ₈ " | 36" | 13 ¹ / ₂ " | 21" | DS3PMSL3621FL | 1,100. | 1,208. | 1,262. |
| | 41 ⁷ / ₈ " | 42" | 13 ¹ / ₂ " | 21" | DS3PMSL4221FL | 1,134. | 1,243. | 1,300. |
| | 47 ⁷ / ₈ " | 48" | 13 ¹ / ₂ " | 21" | DS3PMSL4821FL | 1,167. | 1,280. | 1,334. |
| | 59 ⁷ / ₈ " | 60" | 13 ¹ / ₂ " | 21" | DS3PMSL6021FL | 1,197. | 1,315. | 1,372. |
| | 65 ⁷ / ₈ " | 66" | 13 ¹ / ₂ " | 21" | DS3PMSL6621FL | 1,227. | 1,350. | 1,409. |
| | 71 ⁷ / ₈ " | 72" | 13 ¹ / ₂ " | 21" | DS3PMSL7221FL | 1,260. | 1,384. | 1,445. |

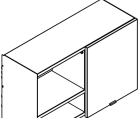
| | | | | | | | | |
|--|----------------------------------|-----|----------------------------------|-----|----------------------|--------|--------|--------|
|  Dividends Horizon Panel-Mounted Sliding Door Overhead w/ Veneer Door | 29 ⁷ / ₈ " | 30" | 13 ¹ / ₂ " | 21" | DS3PMSV3021FL | 1,165. | 1,278. | 1,333. |
| | 35 ⁷ / ₈ " | 36" | 13 ¹ / ₂ " | 21" | DS3PMSV3621FL | 1,206. | 1,325. | 1,383. |
| | 41 ⁷ / ₈ " | 42" | 13 ¹ / ₂ " | 21" | DS3PMSV4221FL | 1,251. | 1,372. | 1,434. |
| | 47 ⁷ / ₈ " | 48" | 13 ¹ / ₂ " | 21" | DS3PMSV4821FL | 1,294. | 1,421. | 1,485. |
| | 59 ⁷ / ₈ " | 60" | 13 ¹ / ₂ " | 21" | DS3PMSV6021FL | 1,336. | 1,468. | 1,536. |
| | 65 ⁷ / ₈ " | 66" | 13 ¹ / ₂ " | 21" | DS3PMSV6621FL | 1,381. | 1,518. | 1,584. |
| | 71 ⁷ / ₈ " | 72" | 13 ¹ / ₂ " | 21" | DS3PMSV7221FL | 1,426. | 1,566. | 1,635. |

w* = nominal width
 Dimensions listed under w h d are actual to the nearest 1/16"

| Ordering Information | Order Code | Included With | Options |
|---|---|--|---|
| Sliding Door Overheads: 1. Pattern number 2. Paint finish case 3. Door finish (laminated and veneer door only) 4. Door edge finish (laminated door only) | Sliding Door Overhead w/ Steel Door <i>Example:</i> DS3PMSS3021FL /117/117 DS3PMSS Pattern Number 3021FL 117 Dark grey paint finish case | Sliding Door Overhead Note: Sliding door overheads are only available in Knoll core finishes. | Sliding Door Overhead Lock/No lock For non-locking units substitute the "L" suffix with a "N" and deduct \$20.00 from the list price. Paint Configuration Option: Add "Y" at the end of the pattern number to specify a different paint finish on the case and sliding door. P3 pricing applies to all products with dual paint finishes. |

Sliding Door Overheads

21" High Panel-Mounted

Dividends Horizon Partial Height Door

Dividends Horizon

| description | w* | w | d | h | pattern number | P1 | P2 | P3 |
|---|----------------------------------|-----|----------------------------------|-----|----------------------|--------|--------|--------|
| Dividends Horizon Panel-Mounted Sliding Door Overhead w/ Steel Door | 29 ⁷ / ₈ " | 30" | 13 ¹ / ₂ " | 21" | DS3PMSS3021PL | \$642. | \$708. | \$738. |
| | 35 ⁷ / ₈ " | 36" | 13 ¹ / ₂ " | 21" | DS3PMSS3621PL | 664. | 728. | 762. |
| | 41 ⁷ / ₈ " | 42" | 13 ¹ / ₂ " | 21" | DS3PMSS4221PL | 684. | 751. | 783. |
| | 47 ⁷ / ₈ " | 48" | 13 ¹ / ₂ " | 21" | DS3PMSS4821PL | 700. | 771. | 807. |
| | 59 ⁷ / ₈ " | 60" | 13 ¹ / ₂ " | 21" | DS3PMSS6021PL | 776. | 854. | 893. |
| | 65 ⁷ / ₈ " | 66" | 13 ¹ / ₂ " | 21" | DS3PMSS6621PL | 801. | 879. | 918. |
| | 71 ⁷ / ₈ " | 72" | 13 ¹ / ₂ " | 21" | DS3PMSS7221PL | 815. | 895. | 936. |

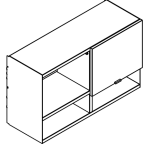

| | | | | | | | | |
|--|----------------------------------|-----|----------------------------------|-----|----------------------|--------|--------|--------|
| Dividends Horizon Panel-Mounted Sliding Door Overhead w/ Laminate Door | 29 ⁷ / ₈ " | 30" | 13 ¹ / ₂ " | 21" | DS3PMSL3021PL | 1,061. | 1,165. | 1,215. |
| | 35 ⁷ / ₈ " | 36" | 13 ¹ / ₂ " | 21" | DS3PMSL3621PL | 1,092. | 1,198. | 1,251. |
| | 41 ⁷ / ₈ " | 42" | 13 ¹ / ₂ " | 21" | DS3PMSL4221PL | 1,122. | 1,230. | 1,288. |
| | 47 ⁷ / ₈ " | 48" | 13 ¹ / ₂ " | 21" | DS3PMSL4821PL | 1,153. | 1,267. | 1,324. |
| | 59 ⁷ / ₈ " | 60" | 13 ¹ / ₂ " | 21" | DS3PMSL6021PL | 1,186. | 1,302. | 1,359. |
| | 65 ⁷ / ₈ " | 66" | 13 ¹ / ₂ " | 21" | DS3PMSL6621PL | 1,217. | 1,335. | 1,397. |
| | 71 ⁷ / ₈ " | 72" | 13 ¹ / ₂ " | 21" | DS3PMSL7221PL | 1,248. | 1,370. | 1,433. |

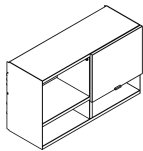

| | | | | | | | | |
|--|----------------------------------|-----|----------------------------------|-----|----------------------|--------|--------|--------|
| Dividends Horizon Panel-Mounted Sliding Door Overhead w/ Veneer Door | 29 ⁷ / ₈ " | 30" | 13 ¹ / ₂ " | 21" | DS3PMSV3021PL | 1,165. | 1,278. | 1,332. |
| | 35 ⁷ / ₈ " | 36" | 13 ¹ / ₂ " | 21" | DS3PMSV3621PL | 1,198. | 1,316. | 1,373. |
| | 41 ⁷ / ₈ " | 42" | 13 ¹ / ₂ " | 21" | DS3PMSV4221PL | 1,233. | 1,355. | 1,414. |
| | 47 ⁷ / ₈ " | 48" | 13 ¹ / ₂ " | 21" | DS3PMSV4821PL | 1,271. | 1,394. | 1,456. |
| | 59 ⁷ / ₈ " | 60" | 13 ¹ / ₂ " | 21" | DS3PMSV6021PL | 1,305. | 1,433. | 1,497. |
| | 65 ⁷ / ₈ " | 66" | 13 ¹ / ₂ " | 21" | DS3PMSV6621PL | 1,337. | 1,470. | 1,538. |
| | 71 ⁷ / ₈ " | 72" | 13 ¹ / ₂ " | 21" | DS3PMSV7221PL | 1,374. | 1,511. | 1,578. |

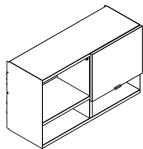

w* = nominal width
 Dimensions listed under w h d are actual to the nearest 1/16"

| Ordering Information | Order Code | Included With | Options |
|---|--|--|---|
| Sliding Door Overheads: 1. Pattern number 2. Paint finish case 3. Door finish (laminite and veneer door only) 4. Door edge finish (laminite door only) | Sliding Door Overhead w/ Steel Door <i>Example:</i> DS3PMSS3021PL /117/117 DS3PMSS Pattern Number 3021PL 117 Dark grey paint finish case | Sliding Door Overhead Note: Sliding door overheads are only available in Knoll core finishes. | Sliding Door Overhead Lock/No lock For non-locking units substitute the "L" suffix with a "N" and deduct \$20.00 from the list price. Paint Configuration Option: Add "Y" at the end of the pattern number to specify a different paint finish on the case and sliding door. P3 pricing applies to all products with dual paint finishes. |

Sliding Door Overheads

14" High Wall-Mounted

Dividends Horizon and Template Doors

Dividends Horizon

| description | w * | w | d | h | pattern no. | P1 | P2 | P3 |
|---|----------------------------------|-----|-----|-----|-------------------|--------|--------|--------|
| Dividends Horizon Wall-Mounted Sliding Door Overhead without Door | 35 ⁷ / ₈ " | 36" | 14" | 14" | DS3WMN3614 | \$725. | \$799. | \$834. |
| | 42 ⁷ / ₈ " | 42" | 14" | 14" | DS3WMN4214 | 766. | 846. | 882. |
| | 47 ⁷ / ₈ " | 48" | 14" | 14" | DS3WMN4814 | 806. | 884. | 925. |
| | 59 ⁷ / ₈ " | 60" | 14" | 14" | DS3WMN6014 | 1,100. | 1,211. | 1,266. |
| | 71 ⁷ / ₈ " | 72" | 14" | 14" | DS3WMN7214 | 1,192. | 1,314. | 1,372. |

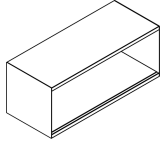

| | | | | | | | | |
|--|----------------------------------|-----|-----|-----|---------------------|--------|--------|--------|
| Dividends Horizon Wall-Mounted Sliding Door Overhead w/ Steel Door | 35 ⁷ / ₈ " | 36" | 15" | 14" | DS3WMSS3614L | 912. | 1,002. | 1,048. |
| | 42 ⁷ / ₈ " | 42" | 15" | 14" | DS3WMSS4214L | 957. | 1,055. | 1,101. |
| | 47 ⁷ / ₈ " | 48" | 15" | 14" | DS3WMSS4814L | 996. | 1,097. | 1,145. |
| | 59 ⁷ / ₈ " | 60" | 15" | 14" | DS3WMSS6014L | 1,300. | 1,430. | 1,497. |
| | 71 ⁷ / ₈ " | 72" | 15" | 14" | DS3WMSS7214L | 1,399. | 1,539. | 1,609. |

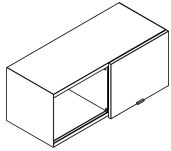

| | | | | | | | | |
|---|----------------------------------|-----|-----|-----|---------------------|-----|-----|--------|
| Dividends Horizon Wall-Mounted Sliding Door Overhead w/ Laminate Door | 35 ⁷ / ₈ " | 36" | 15" | 14" | DS3WMSL3614L | n/a | n/a | 1,217. |
| | 42 ⁷ / ₈ " | 42" | 15" | 14" | DS3WMSL4214L | n/a | n/a | 1,262. |
| | 47 ⁷ / ₈ " | 48" | 15" | 14" | DS3WMSL4814L | n/a | n/a | 1,305. |
| | 59 ⁷ / ₈ " | 60" | 15" | 14" | DS3WMSL6014L | n/a | n/a | 1,620. |
| | 71 ⁷ / ₈ " | 72" | 15" | 14" | DS3WMSL7214L | n/a | n/a | 1,727. |

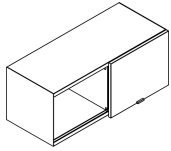

| | | | | | | | | |
|---|----------------------------------|-----|-----|-----|---------------------|-----|-----|--------|
| Dividends Horizon Wall-Mounted Sliding Door Overhead w/ Veneer Door | 35 ⁷ / ₈ " | 36" | 15" | 14" | DS3WMSV3614L | n/a | n/a | 1,412. |
| | 41 ⁷ / ₈ " | 42" | 15" | 14" | DS3WMSV4214L | n/a | n/a | 1,462. |
| | 47 ⁷ / ₈ " | 48" | 15" | 14" | DS3WMSV4814L | n/a | n/a | 1,524. |
| | 59 ⁷ / ₈ " | 60" | 15" | 14" | DS3WMSV6014L | n/a | n/a | 1,844. |
| | 71 ⁷ / ₈ " | 72" | 15" | 14" | DS3WMSV7214L | n/a | n/a | 1,970. |

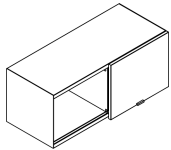

Ordering Information

Sliding Door Overheads:

1. Pattern number
2. Paint finish case
3. Door finish
(laminated and veneer door only)
4. Door edge finish
(laminated door only)

Order Code

Sliding Door Overhead

Example: **DS3WMSS4214N**
/118/118

| | |
|--------------|---------------------------|
| DS3WM | Pattern Number |
| SS | Steel Door |
| 42 | Width |
| 14 | Height |
| N | No lock |
| 118 | Bright White Paint Finish |
| 118 | Bright White Paint Finish |

Included With

Sliding Door Overhead

Wall mount cleat
Hardware
Specify one of the following for Template Glass door option:
(Temp) = Clear
(GL13) = Powder
(GL25) = Bronze
(GL35) = Grey

Options

Sliding Door Overhead

Lock Option:
For non-locking units substitute the "L" suffix with a "N" and deduct \$20.00 from the list price.

Paint Configuration Option:

Add "Y" at the end of the pattern number to specify a different paint finish on the case and sliding door. P3 pricing applies to all products with dual paint finishes.

Note: Sliding door overheads are only available in Knoll core finishes.

Overheads on this page accept LED task lights only. T5 task light brackets are not compatible.

Sliding Door Overheads

14" High Wall-Mounted

Dividends Horizon and Template Doors

Dividends Horizon

| description | w * | w | d | h | pattern no. | P1 | P2 | P3 |
|--|----------------------------------|-----|-----|-----|-------------------------|--------|--------|----------|
| Template Wall-Mounted | 35 ⁷ / ₈ " | 36" | 15" | 14" | DS3WMT(S/G)3614L | \$895. | \$986. | \$1,032. |
| Sliding Door Overhead w/Steel or Glass Doors | 42 ⁷ / ₈ " | 42" | 15" | 14" | DS3WMT(S/G)4214L | 945. | 1,040. | 1,087. |
| | 47 ⁷ / ₈ " | 48" | 15" | 14" | DS3WMT(S/G)4814L | 986. | 1,083. | 1,134. |
| | 59 ⁷ / ₈ " | 60" | 15" | 14" | DS3WMT(S/G)6014L | 1,297. | 1,426. | 1,492. |
| | 71 ⁷ / ₈ " | 72" | 15" | 14" | DS3WMT(S/G)7214L | 1,403. | 1,543. | 1,614. |

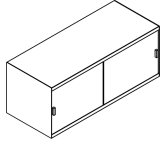

| Ordering Information | Order Code | Included With | Options |
|--|--------------------------------------|--|---|
| Sliding Door Overheads: | Sliding Door Overhead | Sliding Door Overhead | Sliding Door Overhead |
| 1. Pattern number | <i>Example:</i> DS3WMSS4214N | Wall mount cleat | Lock Option: |
| 2. Paint finish case | /118/118 | Hardware | For non-locking units substitute the "L" suffix with a "N" and deduct \$20.00 from the list price. |
| 3. Door finish (laminated and veneer door only) | DS3WMT Pattern Number | Specify one of the following for Template Glass door option: | Paint Configuration Option: |
| 4. Door edge finish (laminated door only) | SS Steel Door | (Temp) = Clear | Add "Y" at the end of the pattern number to specify a different paint finish on the case and sliding door. P3 pricing applies to all products with dual paint finishes. |
| | 42 Width | (GL13) = Powder | |
| | 14 Height | (GL25) = Bronze | |
| | N No lock | (GL35) = Grey | |
| | 118 Bright White Paint Finish | | |
| | 118 Bright White Paint Finish | | |

Overheads on this page accept LED task lights only. T5 task light brackets are not compatible.

Sliding Door Overheads

14" High Shared Center-Mounted

Dividends Horizon and Template Doors

Dividends Horizon

| description | w * | w | d | h | pattern no. | P1 | P2 | P3 |
|---|----------------------------------|-----|-----|-----|-------------------|--------|----------|----------|
| Dividends Horizon Shared Top-Mounted Sliding Door Overhead without Door | 35 ⁷ / ₈ " | 36" | 14" | 14" | DS3SMN3614 | \$972. | \$1,071. | \$1,119. |
| | 42 ⁷ / ₈ " | 42" | 14" | 14" | DS3SMN4214 | 1,014. | 1,117. | 1,168. |
| | 47 ⁷ / ₈ " | 48" | 14" | 14" | DS3SMN4814 | 1,045. | 1,149. | 1,202. |
| | 59 ⁷ / ₈ " | 60" | 14" | 14" | DS3SMN6014 | 1,238. | 1,361. | 1,424. |
| | 71 ⁷ / ₈ " | 72" | 14" | 14" | DS3SMN7214 | 1,292. | 1,421. | 1,486. |

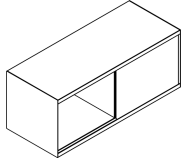

| | | | | | | | | |
|--|----------------------------------|-----|-----|-----|-------------------------|--------|--------|--------|
| Template Shared Top-Mounted Sliding Door Overhead with Steel Doors | 35 ⁷ / ₈ " | 36" | 15" | 14" | DS3SMT(S/G)3614L | 1,150. | 1,267. | 1,324. |
| | 42 ⁷ / ₈ " | 42" | 15" | 14" | DS3SMT(S/G)4214L | 1,198. | 1,318. | 1,377. |
| | 47 ⁷ / ₈ " | 47" | 15" | 14" | DS3SMT(S/G)4814L | 1,225. | 1,350. | 1,409. |
| | 59 ⁷ / ₈ " | 60" | 15" | 14" | DS3SMT(S/G)6014L | 1,430. | 1,575. | 1,644. |
| | 71 ⁷ / ₈ " | 72" | 15" | 14" | DS3SMT(S/G)7214L | 1,512. | 1,664. | 1,739. |

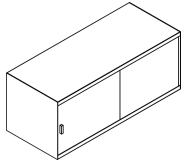

| | | | | | | | | |
|--|----------------------------------|-----|-----|-----|---------------------|--------|--------|--------|
| Dividends Horizon Shared Top-Mounted Sliding Door Overhead with Steel Door | 35 ⁷ / ₈ " | 36" | 15" | 14" | DS3SMSS3614L | 1,215. | 1,335. | 1,398. |
| | 42 ⁷ / ₈ " | 42" | 15" | 14" | DS3SMSS4214L | 1,263. | 1,389. | 1,451. |
| | 47 ⁷ / ₈ " | 48" | 15" | 14" | DS3SMSS4814L | 1,292. | 1,421. | 1,486. |
| | 59 ⁷ / ₈ " | 60" | 15" | 14" | DS3SMSS6014L | 1,493. | 1,642. | 1,717. |
| | 71 ⁷ / ₈ " | 72" | 15" | 14" | DS3SMSS7214L | 1,575. | 1,731. | 1,810. |

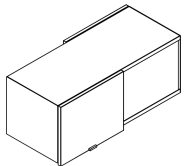

| | | | | | | | | |
|---|----------------------------------|-----|-----|-----|---------------------|-----|-----|--------|
| Dividends Horizon Shared Top-Mounted Sliding Door Overhead with Laminate Door | 35 ⁷ / ₈ " | 36" | 15" | 14" | DS3SMSL3614L | n/a | n/a | 1,864. |
| | 42 ⁷ / ₈ " | 42" | 15" | 14" | DS3SMSL4214L | n/a | n/a | 1,908. |
| | 47 ⁷ / ₈ " | 48" | 15" | 14" | DS3SMSL4814L | n/a | n/a | 1,944. |
| | 59 ⁷ / ₈ " | 60" | 15" | 14" | DS3SMSL6014L | n/a | n/a | 2,150. |
| | 71 ⁷ / ₈ " | 72" | 15" | 14" | DS3SMSL7214L | n/a | n/a | 2,244. |

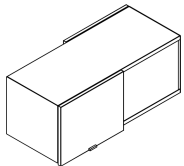

Ordering Information

Sliding Door Overheads:

1. Pattern number
2. Case paint finish
3. Door finish
(laminated and veneer door only)
4. Door edge finish
(laminated door only)

Order Code

Sliding Door Overhead

Example: **DS3SMSS4214N**
/118/118

| | |
|--------------|---------------------------|
| DS3SM | Pattern Number |
| SS | Steel Door |
| 42 | Width |
| 14 | Height |
| N | No lock |
| 118 | Bright White Paint Finish |
| 118 | Bright White Paint Finish |

Included With

Sliding Door Overhead

Hardware

Specify one of the following for Template Glass door option:

(Temp) = Clear
(GL13) = Powder
(GL25) = Bronze
(GL35) = Grey

Options

Sliding Door Overhead

Lock Option:

For non-locking units substitute the "L" suffix with a "N" and deduct \$20.00 from the list price. Deduct \$40.00 for shared overheads.

Paint Configuration Option:

Add "Y" at the end of the pattern number to specify a different paint finish on the case and sliding door. P3 pricing applies to all products with dual paint finishes.

Note: Sliding door overheads are only available in Knoll core finishes.

Note: Center-mounted sliding door overheads mount on full view panels only and must mount on module with panel widths.

Overheads on this page accept LED task lights only. T5 task light brackets are not compatible.

Sliding Door Overheads

14" High Shared Center-Mounted

Dividends Horizon and Template Doors

Dividends Horizon

| description | w* | w | d | h | pattern no. | P1 | P2 | P3 |
|---|----------------------------------|-----|-----|-----|---------------------|-----|-----|----------|
| Dividends Horizon Shared Top-Mounted Sliding Door Overhead with Veneer Door | 35 ⁷ / ₈ " | 36" | 15" | 14" | DS3SMSV3614L | n/a | n/a | \$2,256. |
| | 42 ⁷ / ₈ " | 42" | 15" | 14" | DS3SMSV4214L | n/a | n/a | 2,312. |
| | 47 ⁷ / ₈ " | 48" | 15" | 14" | DS3SMSV4814L | n/a | n/a | 2,378. |
| | 59 ⁷ / ₈ " | 60" | 15" | 14" | DS3SMSV6014L | n/a | n/a | 2,597. |
| | 71 ⁷ / ₈ " | 72" | 15" | 14" | DS3SMSV7214L | n/a | n/a | 2,729. |

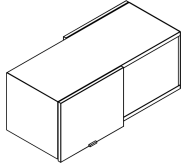

Ordering Information

Sliding Door Overheads:

1. Pattern number
2. Case paint finish
3. Door finish
(laminated and veneer door only)
4. Door edge finish
(laminated door only)

Order Code

Sliding Door Overhead

Example: **DS3SMSS4214N**
/118/118

| | |
|--------------|---------------------------|
| DS3SM | Pattern Number |
| SS | Steel Door |
| 42 | Width |
| 14 | Height |
| N | No lock |
| 118 | Bright White Paint Finish |
| 118 | Bright White Paint Finish |

Included With

Sliding Door Overhead

Hardware

Specify one of the following for Template Glass door option:

(Temp) = Clear
(GL13) = Powder
(GL25) = Bronze
(GL35) = Grey

Options

Sliding Door Overhead

Lock Option:

For non-locking units substitute the "L" suffix with a "N" and deduct \$20.00 from the list price. Deduct \$40.00 for shared overheads.

Paint Configuration Option:

Add "Y" at the end of the pattern number to specify a different paint finish on the case and sliding door. P3 pricing applies to all products with dual paint finishes.

Note: Sliding door overheads are only available in Knoll core finishes.

Note: Center-mounted sliding door overheads mount on full view panels only and must mount on module with panel widths.

Overheads on this page accept LED task lights only. T5 task light brackets are not compatible.

Sliding Door Overheads

14" High Individual Center-Mounted

Dividends Horizon Doors / Template Doors

Dividends Horizon

| description | w* | w | d | h | pattern no. | P1 | P2 | P3 | LAM | V1 |
|---|---------|-----|-----|-----|-------------------|--------|--------|--------|-----|----|
| Dividends Horizon Individual Center-Mounted Overhead without Door | 35 7/8" | 36" | 14" | 14" | DS3CMN3614 | \$779. | \$857. | \$895. | | |
| | 41 7/8" | 42" | 14" | 14" | DS3CMN4214 | 813. | 894. | 935. | | |
| | 47 7/8" | 48" | 14" | 14" | DS3CMN4814 | 833. | 916. | 958. | | |
| | 59 7/8" | 60" | 14" | 14" | DS3CMN6014 | 1,162. | 1,277. | 1,333. | | |
| | 71 7/8" | 72" | 14" | 14" | DS3CMN7214 | 1,221. | 1,346. | 1,404. | | |

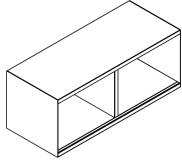

| | | | | | | | | | | |
|---|---------|-----|-----|-----|-------------------------|--------|--------|--------|--|--|
| Template Individual Center-Mounted Sliding Door Overhead with Steel Doors | 35 7/8" | 36" | 15" | 14" | DS3CMT(S/G)3614L | 932. | 1,026. | 1,072. | | |
| | 42 7/8" | 42" | 15" | 14" | DS3CMT(S/G)4214L | 971. | 1,070. | 1,118. | | |
| | 47 7/8" | 48" | 15" | 14" | DS3CMT(S/G)4814L | 996. | 1,097. | 1,145. | | |
| | 59 7/8" | 60" | 15" | 14" | DS3CMT(S/G)6014L | 1,355. | 1,492. | 1,558. | | |
| | 71 7/8" | 72" | 15" | 14" | DS3CMT(S/G)7214L | 1,432. | 1,576. | 1,646. | | |

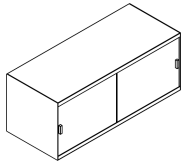

| | | | | | | | | | | |
|--|---------|-----|-----|-----|---------------------|--------|--------|--------|--|--|
| Dividends Horizon Individual Center-Mounted Sliding Door Overhead with Steel Doors | 35 7/8" | 36" | 15" | 14" | DS3CMSS3614L | 1,029. | 1,132. | 1,182. | | |
| | 41 7/8" | 42" | 15" | 14" | DS3CMSS4214L | 1,068. | 1,175. | 1,228. | | |
| | 47 7/8" | 48" | 15" | 14" | DS3CMSS4814L | 1,097. | 1,206. | 1,262. | | |
| | 59 7/8" | 60" | 15" | 14" | DS3CMSS6014L | 1,314. | 1,444. | 1,510. | | |
| | 71 7/8" | 72" | 15" | 14" | DS3CMSS7214L | 1,388. | 1,528. | 1,596. | | |

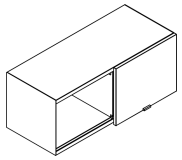

| Ordering Information | Order Code | Included With | Options |
|---|--------------------------------------|--|---|
| Sliding Door Overheads: | Sliding Door Overhead | Sliding Door Overhead | Sliding Door Overhead |
| 1. Pattern number | <i>Example:</i> DS3CMTS4214N | Hardware | Lock Option: |
| 2. Case paint finish | /118/118 | Specify one of the following for Template Glass door option: | For non-locking units substitute the "L" suffix with a "N" and deduct \$20.00 from the list price. |
| 3. Door finish | DS3CM Pattern Number | (Temp) = Clear | Paint Configuration Option: |
| 4. Door edge finish (laminated door only) | T Template Style Door | (GL13) = Powder | Add "Y" at the end of the pattern number to specify a different paint finish on the case and sliding door. P3 pricing applies to all products with dual paint finishes. |
| | S Steel Door | (GL25) = Bronze | Note: Sliding door overheads are only available in Knoll core finishes. |
| | 42 Width | (GL35) = Grey | Note: Center-mounted sliding door overheads mount on full view panels only and must mount on module with panel widths. |
| | 14 Height | | |
| | N No lock | | |
| | 118 Bright White Paint Finish | | |
| | 118 Bright White Paint Finish | | |

Overheads on this page accept LED task lights only. T5 task light brackets are not compatible.

Sliding Door Overheads

14" High Individual Center-Mounted Dividends Horizon Doors / Template Doors

Dividends Horizon

| description | w * | w | d | h | pattern no. | P1 | P2 | P3 | LAM | V1 |
|---|----------------------------------|-----|-----|-----|---------------------|------|------|------|----------|------|
| Dividends Horizon Individual Center-Mounted Sliding Door Overhead with Laminate Doors | 35 ⁷ / ₈ " | 36" | 15" | 14" | DS3CMSL3614L | \$0. | \$0. | \$0. | \$1,337. | \$0. |
| | 41 ⁷ / ₈ " | 42" | 15" | 14" | DS3CMSL4214L | 0. | 0. | 0. | 1,378. | 0. |
| | 47 ⁷ / ₈ " | 48" | 15" | 14" | DS3CMSL4814L | 0. | 0. | 0. | 1,409. | 0. |
| | 59 ⁷ / ₈ " | 60" | 15" | 14" | DS3CMSL6014L | 0. | 0. | 0. | 1,637. | 0. |
| | 71 ⁷ / ₈ " | 72" | 15" | 14" | DS3CMSL7214L | 0. | 0. | 0. | 1,717. | 0. |

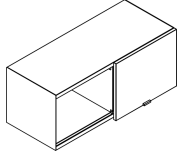

| | | | | | | | | | | |
|---|----------------------------------|-----|-----|-----|---------------------|----|----|----|----|--------|
| Dividends Horizon Individual Center-Mounted Sliding Door Overhead with Veneer Doors | 35 ⁷ / ₈ " | 36" | 15" | 14" | DS3CMSV3614L | 0. | 0. | 0. | 0. | 1,533. |
| | 41 ⁷ / ₈ " | 42" | 15" | 14" | DS3CMSV4214L | 0. | 0. | 0. | 0. | 1,579. |
| | 47 ⁷ / ₈ " | 48" | 15" | 14" | DS3CMSV4814L | 0. | 0. | 0. | 0. | 1,628. |
| | 59 ⁷ / ₈ " | 60" | 15" | 14" | DS3CMSV6014L | 0. | 0. | 0. | 0. | 1,857. |
| | 71 ⁷ / ₈ " | 72" | 15" | 14" | DS3CMSV7214L | 0. | 0. | 0. | 0. | 1,959. |

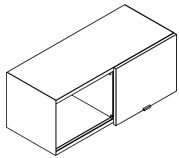

Ordering Information

Sliding Door Overheads:

1. Pattern number
2. Case paint finish
3. Door finish
4. Door edge finish (laminated door only)

Order Code

Sliding Door Overhead

Example: **DS3CMTS4214N /118/118**

| | |
|--------------|---------------------------|
| DS3CM | Pattern Number |
| T | Template Style Door |
| S | Steel Door |
| 42 | Width |
| 14 | Height |
| N | No lock |
| 118 | Bright White Paint Finish |
| 118 | Bright White Paint Finish |

Included With

Sliding Door Overhead

Hardware

Specify one of the following for Template Glass door option:

(Temp) = Clear
(GL13) = Powder
(GL25) = Bronze
(GL35) = Grey

Options

Sliding Door Overhead

Lock Option:

For non-locking units substitute the "L" suffix with a "N" and deduct \$20.00 from the list price.

Paint Configuration Option:

Add "Y" at the end of the pattern number to specify a different paint finish on the case and sliding door. P3 pricing applies to all products with dual paint finishes.

Note: Sliding door overheads are only available in Knoll core finishes.

Note: Center-mounted sliding door overheads mount on full view panels only and must mount on module with panel widths.

Overheads on this page accept LED task lights only. T5 task light brackets are not compatible.

This page intentionally left blank

Panel Up Mounted Overhead Cabinets

Up mounted cabinets mount to 50" or 57" high panels only to provide overhead storage within workstations and are an alternative to overheads panel-mounted on 64" high panels. Up mounted cabinets have full finished backs and require up mount brackets for mounting.

When installed on 50" high panels, up mounted cabinets match up to the overall 64" height of panel-mounted overhead cabinets and freestanding overdesks to provide a consistent height within the facility.

Overhead cabinets consist of a top, shelf, end panels, enclosed back, overhead door with or without lock and required assembly screws. 30" to 48" wide cabinets have single doors while cabinets 54", 60", 66" and 72" wide have double doors. 54" wide overhead cabinets will ship with one 24" and one 30" door. 66" wide overhead cabinets will ship with one 30" and one 36" door. 54" and 66" overhead doors may be removed and reversed.

Up mounted cabinets are shipped knocked-down.

Up mounted overheads must match the width of single or multiple panels and cannot be mounted off module.

Series 1 Flip-up Overhead Cabinets

Series 1 flip-up overhead cabinets match the aesthetics of the original Dividends Horizon system. The radiused fronts and molded plastic end trim match the radiused profile trim used on panel topcaps and end trim. Series 1 cabinets are offered with steel doors.

Series 2 Flip-up Overhead Cabinets

Series 2 overhead cabinets offer an alternative aesthetic to the Dividends Horizon Series 1 overhead. Unlike the radiused door profile of the Series 1 overhead door, the Series 2 door profile is rectilinear with soft radiused corners (see door profile drawing below). The Series 2 overhead offers a painted steel or veneer overhead door front.

Available Sizes

- Height: 15"
- Depth: 13¹/₂"
- Widths: 30", 36", 42", 48", 54", 60", 66" and 72"

Construction:

- Horizontal top and shelf: 18-gauge (30" to 48" wide), 16-gauge (60" to 72" wide) painted roll-formed steel
- Overhead door: 20-gauge painted
- Overhead door suspension: Steel ball-bearing
- Overhead door end trim: Color injected, molded plastic (Series 1 only)
- End panels: 16-gauge painted steel with integral mounting hooks
- Up mount brackets: 14-gauge steel

Interior Dimensions

Up mounted cabinet interiors measure:

- Depth 12"
- Usable interior height: 12⁵/₈"
- Width: 1/8" shorter than the exterior width.

Cabinet Door Clearance

Cabinet doors open over the tops of cabinets. Required clearance is: 16¹/₄" total height (height of cabinet plus top clearance required).

Panel Up Mounted Overhead for Stack Frames

Dividends Horizon non-load bearing stacking frames do not allow for panel-mount hanging components. To provide overhead storage, a panel up mounted overhead cabinet with enclosed back can be utilized.

Up mount brackets

Cabinet up mount brackets are required for up mounted applications.

Up mount brackets are ordered separately in pairs. Up mount brackets can be used on both Dividends Horizon Series 1 and Series 2 up mounted cabinets.

Touchdown Overhead Cabinets

Touchdown overhead cabinets are equipped with hydraulic assist cylinders that allows the overhead cabinet front to gently fall to a closed position.

Retrofit mechanisms may be field added to any flip-up overhead cabinet with a steel door.

Note: Touchdown mechanisms are not available with laminate or veneer doors.

Locks

Locks are standard on overhead cabinets and keyed randomly unless otherwise specified. Other keying options include keyed alike or keyed with lock cores K001-K250. All locks are factory-installed and are black finish. Cabinets can also be specified without locks if required.

When locks are not specified a plug is located in the lock position.

Optional lock retrofit kits are available for field-installation at a later date if required.

Task Lights

All Dividends up mounted cabinets will accept task lights. Task lights must be ordered separately.

Panel Up Mounted Cabinet

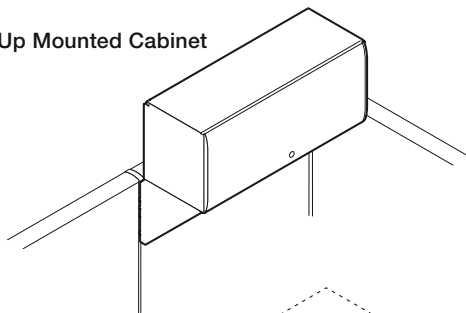

Up Mount Brackets

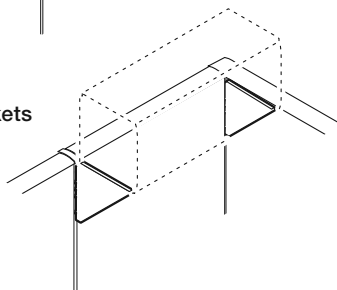

Interior Dimensions

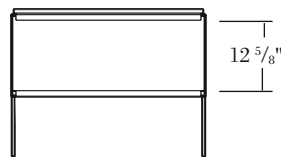

Front View, Interior Height

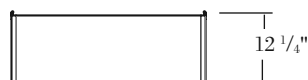

Top View, Interior Depth



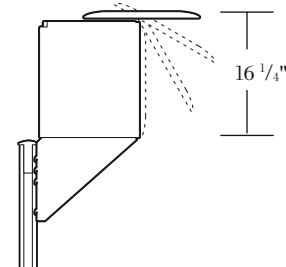

Cabinet Door Clearance



Up Mounted Overheads

Dividends and Series 2

Dividends Horizon

| description | w* | w | d | h | pattern no. | P1 | P2 | P3 | V1-P1 | V1-P2 | V1-P3 |
|---|-----|----------------------------------|-----------------------------------|----------------------------------|-----------------|--------|--------|--------|--------|--------|--------|
| Dividends Overhead Cabinet with Enclosed Back and Lock  | 30" | 29 ⁷ / ₈ " | 14 ¹ / ₈ " | 15" | DS1E30L | \$524. | \$579. | \$603. | n/a | n/a | n/a |
| | 36" | 35 ⁷ / ₈ " | 14 ¹ / ₈ " | 15" | DS1E36L | 544. | 600. | 626. | n/a | n/a | n/a |
| | 42" | 41 ⁷ / ₈ " | 14 ¹ / ₈ " | 15" | DS1E42L | 588. | 647. | 676. | n/a | n/a | n/a |
| | 48" | 47 ⁷ / ₈ " | 14 ¹ / ₈ " | 15" | DS1E48L | 615. | 676. | 706. | n/a | n/a | n/a |
| | 54" | 53 ⁷ / ₈ " | 14 ¹ / ₈ " | 15" | DS1E54L | 805. | 882. | 922. | n/a | n/a | n/a |
| | 60" | 59 ⁷ / ₈ " | 14 ¹ / ₈ " | 15" | DS1E60L | 805. | 882. | 922. | n/a | n/a | n/a |
| | 66" | 65 ⁷ / ₈ " | 14 ¹ / ₈ " | 15" | DS1E66L | 829. | 913. | 955. | n/a | n/a | n/a |
| | 72" | 71 ⁷ / ₈ " | 14 ¹ / ₈ " | 15" | DS1E72L | 829. | 913. | 955. | n/a | n/a | n/a |
| Series 2 Overhead Cabinet With Enclosed Back and Lock  | 30" | 29 ⁷ / ₈ " | 14 ¹ / ₈ " | 15" | DS2UM30L | 697. | 802. | 835. | 941. | 1,045. | 1,082. |
| | 36" | 35 ⁷ / ₈ " | 14 ¹ / ₈ " | 15" | DS2UM36L | 719. | 828. | 863. | 969. | 1,080. | 1,117. |
| | 42" | 41 ⁷ / ₈ " | 14 ¹ / ₈ " | 15" | DS2UM42L | 743. | 853. | 891. | 1,007. | 1,120. | 1,154. |
| | 48" | 47 ⁷ / ₈ " | 14 ¹ / ₈ " | 15" | DS2UM48L | 756. | 869. | 906. | 1,062. | 1,176. | 1,213. |
| | 54" | 53 ⁷ / ₈ " | 14 ¹ / ₈ " | 15" | DS2UM54L | 1,016. | 1,169. | 1,218. | 1,485. | 1,639. | 1,686. |
| | 60" | 59 ⁷ / ₈ " | 14 ¹ / ₈ " | 15" | DS2UM60L | 1,016. | 1,169. | 1,218. | 1,485. | 1,639. | 1,686. |
| | 66" | 65 ⁷ / ₈ " | 14 ¹ / ₈ " | 15" | DS2UM66L | 1,062. | 1,220. | 1,275. | 1,550. | 1,713. | 1,763. |
| | 72" | 71 ⁷ / ₈ " | 14 ¹ / ₈ " | 15" | DS2UM72L | 1,062. | 1,220. | 1,275. | 1,550. | 1,713. | 1,763. |
| Overhead Upmount Brackets (Pair) | | ⁷ / ₈ " | 12 ³ / ₁₆ " | 11 ³ / ₄ " | DB1U18 | 76. | 82. | 87. | n/a | n/a | n/a |
|  | | | | | | | | | | | |
| | | | | | | | | | | | |
| Reuter Upmount Brackets (Pair) | | ⁷ / ₈ " | 12 ³ / ₁₆ " | 11 ³ / ₄ " | DB1RU18 | 103. | 110. | 118. | n/a | n/a | n/a |
|  | | | | | | | | | | | |
| | | | | | | | | | | | |

w* = nominal width

Dimensions listed under w h d are actual to the nearest ¹/₁₆"

| Ordering Information | Order Code | Included with: | Options |
|---|--|---|---|
| Upmount Overhead Cabinet 1. Pattern Number 2. Paint Finish 3. Door End Cap Finish | Upmount Overhead Cabinet <i>Example:</i> DS1E 30L, 113, 113 DS1E 30L Pattern Number 113 Dark grey paint finish 113 Dark grey end cap finish | Upmount Overhead Cabinet Series 2 Overhead Cabinet Up Mount overheads include an enclosed back. Up Mount brackets are required and must be ordered separately. | Upmount Overhead Cabinet To specify overhead cabinet without locks, replace the "L" suffix from the pattern number with "N" Deduct \$20 for 54", 60", 66" and 72" overhead cabinets Deduct \$40 To specify Touchdown overhead cabinet, add "E" as the 2nd to last digit of the pattern number <i>Example:</i> DS3PML48EL (Add \$163 for cabinet widths of 48" or less. Add \$327 for cabinet widths of 54" or greater). |
| Series 2 Overhead Cabinet 1. Pattern Number 2. Paint Finish | Series 2 Overhead Cabinet <i>Example:</i> DS2UM 30L, 115 DS2UM Pattern Number 30L 115 Medium grey paint finish | | Series 2 Up Mount Overhead Finish Option: Add a "Y" to the end of the pattern number to specify a front color that is different than the case color. Use P3 pricing for this dual finish option. |

Overhead Book Shelves

Dividends Horizon bookshelves mount to the integral vertical channels on Dividends Horizon panels or to wall mount tracks to provide overhead storage within workstations or private offices.

Bookshelves include a shelf, end panels, open back and required assembly screws.

Shelves must match the width of single or multiple panels and cannot be mounted off-module.

All book shelves are shipped knocked-down.

Available Sizes

- Height: shelf 8"
- Depth: 14¹/₈"
- Widths: 24", 30", 36", 42", 48", 54", 60", 66" and 72"

Construction:

- Horizontal shelf: 18-gauge (24" to 48" wide), 16-gauge (60" to 72" wide) painted roll-formed steel
- End panels: 16-gauge painted steel with integral mounting hooks

Corner Shelf

Dividends Horizon corner shelves mount to the integral vertical channels of Dividends Horizon panels to provide overhead storage in corner applications. Panels supporting the corner shelf must be of the same width. Corner shelf consists of shelf, end panels and rear corner support bracket.

Note: Corner shelves do not accept task lights.

Note: Corner shelves may not be mounted on load bearing stack frames.

Available Sizes

- Height: 8"
- Depth: 12"
- Widths: 36", 42", and 48"

Construction:

- Shelf: 7/8" wood core construction with laminate on both sides and t-mold edge
- End panels: 16-gauge painted steel with integral mounting hooks

Task Lights

All Dividends Horizon shelves will accept task lights. Task lights must be ordered separately.

Bookshelf

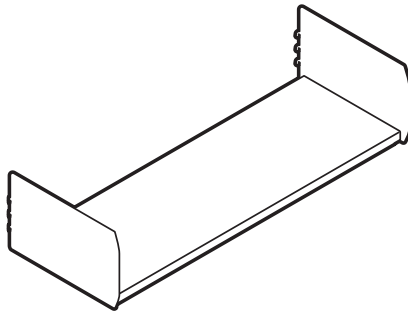

Corner Shelf

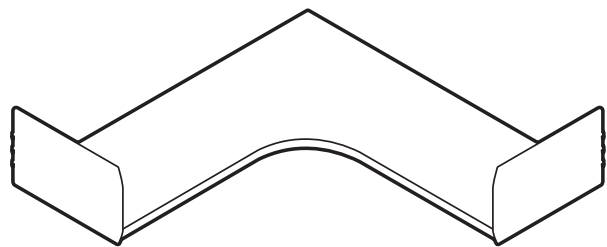

Overhead Bookshelf and Corner Shelf

7 1/4" High

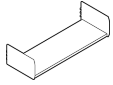
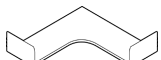
| description | w * | w | d | h | pattern no. | P1 | P2 | P3 |
|---|-----|---------|---------|--------|-----------------|--------|--------|--------|
|  Overhead Bookshelf | 24" | 23 7/8" | 14 1/8" | 7 1/4" | DS1S 24 | \$159. | \$177. | \$184. |
| | 30" | 29 7/8" | 14 1/8" | 7 1/4" | DS1S 30 | 159. | 177. | 184. |
| | 36" | 35 7/8" | 14 1/8" | 7 1/4" | DS1S 36 | 168. | 177. | 185. |
| | 42" | 41 7/8" | 14 1/8" | 7 1/4" | DS1S 42 | 176. | 185. | 192. |
| | 48" | 47 7/8" | 14 1/8" | 7 1/4" | DS1S 48 | 183. | 191. | 201. |
| | 54" | 53 7/8" | 14 1/8" | 7 1/4" | DS1S 54 | 196. | 209. | 218. |
| | 60" | 59 7/8" | 14 1/8" | 7 1/4" | DS1S 60 | 196. | 209. | 218. |
| | 66" | 65 7/8" | 14 1/8" | 7 1/4" | DS1S 66 | 214. | 225. | 237. |
| | 72" | 71 7/8" | 14 1/8" | 7 1/4" | DS1S 72 | 214. | 225. | 237. |
|  Overhead Corner Shelf | 36" | 35 7/8" | 12" | 7 1/4" | DS1CS 36 | 414. | 438. | 454. |
| | 42" | 41 7/8" | 12" | 7 1/4" | DS1CS 42 | 450. | 474. | 498. |
| | 48" | 47 7/8" | 12" | 7 1/4" | DS1CS 48 | 490. | 517. | 542. |

w* = nominal width
 Dimensions listed under w h d are actual to the nearest 1/16"

Ordering Information

Overhead Bookshelf

1. Pattern Number
2. Paint Finish

Overhead Corner Shelf

1. Pattern Number
2. Laminate Finish
3. Edge Band Finish
4. Paint Finish

Order Code

Overhead Bookshelf

Example: **DS1S 60, 113**

DS1S 60 Pattern Number

113 Dark Grey Finish

Overhead Corner Shelf

Example: **DS1CS36, M42, 117, 117**

DS1CS36 Pattern Number

M42 Soft Grey Laminate

117 Soft Grey Edge Band

117 Soft Grey Paint

Included with:

Overhead Bookshelf

Overhead Corner Shelf

- Rear Corner Support Bracket

Note: An upcharge applies when specifying a Legacy laminate. See Legacy finish page for more information.

Mounting Brackets and Accessories

Backstop, Wall-Mount and Panel Mount Specifications

Optional Overhead Back Stop

Panel-mounted overhead cabinet and bookshelf backs are open and use the panel face as the back. When required, an optional field-installed back stop is available. Attachment can be made to an assembled unit. Construction is dark grey extruded plastic.

Specify the overhead back stop width to match the width of the shelf or overhead cabinet.

Overhead Cabinet Wall-Mount Brackets

Wall-mount brackets allow Dividends Horizon panel-mounted overheads to be wall-mounted to dry-wall construction. Wall-mounting brackets are available in sizes 30", 36", 42" and 48".

Specify the width of wall-mount bracket to match the width of the panel-mounted overhead cabinet.

If a 60" cabinet is desired, two (2) 30" wide wall-mount brackets may be installed side-by-side to support the overhead cabinet. When a 72" cabinet is used, two (2) 36" wall-mount brackets may be used.

Shelf Wall-Mount Brackets

Wall-mount brackets allow Dividends Horizon panel-mounted shelves to be wall-mounted to dry-wall construction. Wallmounting brackets are painted black, and are available in sizes 30", 42" and 48".

Specify the width of wall-mount bracket to match the width of the panel-mounted overhead shelf. Specify paint finish to match the shelf paint finish.

A metal shelf back will ship with the wall-mount bracket, which is painted to match the shelf color. Overhead shelves larger than 48" wide cannot be wall mounted using the Dividends Horizon wall-mount bracket.

NOTE: WALL-MOUNT BRACKETS MUST ONLY BE USED WITH STRUCTURAL WALLS. TO ENSURE PROPER INSTALLATION, PLEASE FOLLOW THE INSTALLATION INSTRUCTIONS ENCLOSED WITH THE BRACKETS.

Up mount brackets

Cabinet up mount brackets are required for up mounted applications.

Up mount brackets are ordered separately in pairs. Up mount brackets can be used on both Dividends Horizon Series 1 and Series 2 up mounted cabinets.

Currents Downmount Bracket

This downmount bracket allows for Dividends Horizon or Series 2 panel mounted overhead cabinets to be mounted into Currents spine wall. This downmount bracket can only be used with Currents 64"H spine wall only.

Specify to match the overhead cabinet width. Specify paint finish to match the overhead cabinet finish.

Reuter Panel-Mount Brackets

Reuter panel-mount brackets are available to allow Reuter overheads and shelves to be panel-mounted on Dividends Horizon 57" or 64" high panels. Reuter overhead panel-mount brackets allow overhead sizes up to 72" to be panel-mounted. Reuter shelf panel-mount brackets allow shelves up to 48" to be panel-mounted. Finish black.

Vertical Dividers

Optional vertical dividers attach to the shelves within overhead cabinets and bookshelves to provide inner cabinet organization. Construction is 18-gauge steel with dark grey finish.

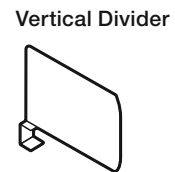
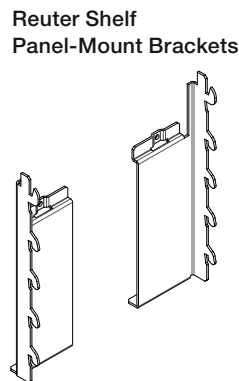
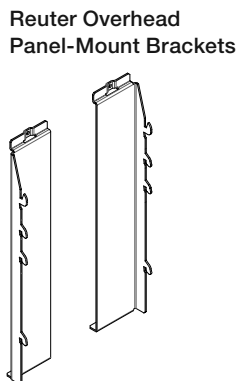
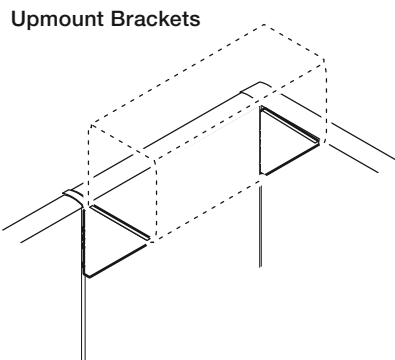
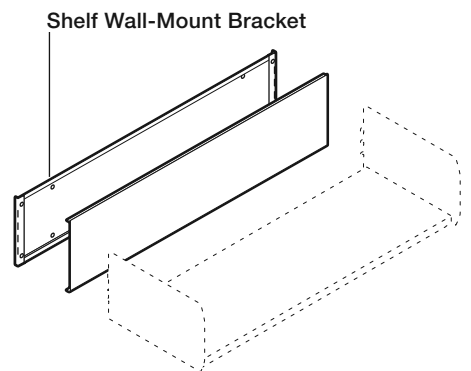
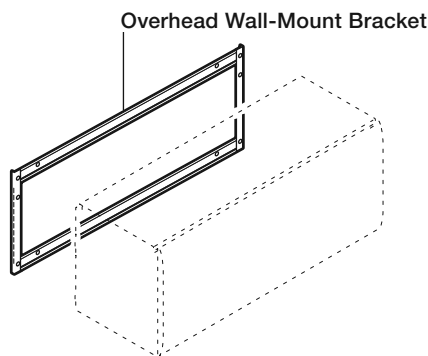
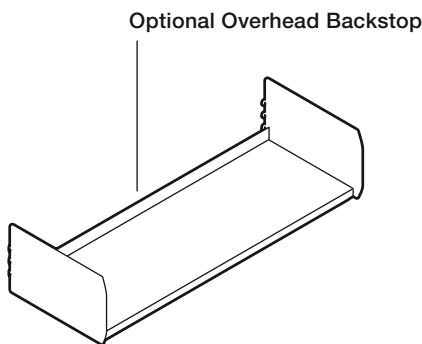

Overhead Cabinet Lock Retrofit Kit

The overhead cabinet lock retrofit kit allows non-locking Series 1 and Series 2 flip-up overhead cabinets to be converted to locking overhead cabinets.



Mounting Brackets and Accessories

Overhead Backstop, Wall-mount Brackets and Currents Downmount Brackets

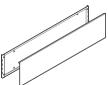
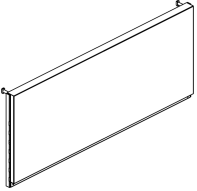
| description | w* | w | d | h | pattern no. | black | P1 | P2 | P3 |
|---|-----|-----------------------|------|---------------------|------------------|-------|------|------|------|
| Overhead Back Stop (Dark Grey Only)  | 24" | 23 ^{11/16} " | 5/8" | 1 ^{7/16} " | DS1BS 24 | | \$4. | n/a | n/a |
| | 30" | 29 ^{11/16} " | 5/8" | 1 ^{7/16} " | DS1BS 30 | | 4. | n/a | n/a |
| | 36" | 35 ^{11/16} " | 5/8" | 1 ^{7/16} " | DS1BS 36 | | 4. | n/a | n/a |
| | 42" | 41 ^{11/16} " | 5/8" | 1 ^{7/16} " | DS1BS 42 | | 7. | n/a | n/a |
| | 48" | 47 ^{11/16} " | 5/8" | 1 ^{7/16} " | DS1BS 48 | | 7. | n/a | n/a |
| | 54" | 53 ^{11/16} " | 5/8" | 1 ^{7/16} " | DS1BS 54 | | 10. | n/a | n/a |
| | 60" | 59 ^{11/16} " | 5/8" | 1 ^{7/16} " | DS1BS 60 | | 10. | n/a | n/a |
| | 66" | 65 ^{11/16} " | 5/8" | 1 ^{7/16} " | DS1BS 66 | | 10. | n/a | n/a |
| | 72" | 71 ^{11/16} " | 5/8" | 1 ^{7/16} " | DS1BS 72 | | 10. | n/a | n/a |
| 14" H Overhead Wall-Mount Bracket  | 24" | 24" | 1/2" | 1 4 1/4" | DS1WM 24 | 77. | 80. | 84. | 87. |
| | 30" | 30" | 1/2" | 1 4 1/4" | DS1WM 30 | 77. | 80. | 84. | 87. |
| | 36" | 36" | 1/2" | 1 4 1/4" | DS1WM 36 | 81. | 85. | 88. | 95. |
| | 42" | 42" | 1/2" | 1 4 1/4" | DS1WM 42 | 90. | 96. | 100. | 104. |
| | 48" | 48" | 1/2" | 1 4 1/4" | DS1WM 48 | 98. | 103. | 107. | 111. |
| Overhead Shelf-Mount Bracket  | 30" | 30" | 1/2" | 7" | DS1SWM 30 | | 77. | 83. | 90. |
| | 36" | 36" | 1/2" | 7" | DS1SWM 36 | | 81. | 92. | 96. |
| | 42" | 42" | 1/2" | 7" | DS1SWM 42 | | 90. | 100. | 103. |
| | 48" | 48" | 1/2" | 7" | DS1SWM 48 | | 98. | 106. | 109. |
| Dividends Series 2 Downmount Brackets (For Currents spine use)  | 24" | | | | DSCSWDB24 | | 255. | n/a | n/a |
| | 30" | | | | DSCSWDB30 | | 262. | n/a | n/a |
| | 36" | | | | DSCSWDB36 | | 269. | n/a | n/a |
| | 42" | | | | DSCSWDB42 | | 278. | n/a | n/a |
| | 48" | | | | DSCSWDB48 | | 283. | n/a | n/a |







w* = nominal width
 Dimensions listed under w h d are actual to the nearest 1/16"

| Ordering Information | Order Code | Included with: | Options |
|------------------------------------|------------------------------------|------------------------------------|------------------------------------|
| Overhead Wall-Mount Bracket | Overhead Wall-Mount Bracket | Overhead Wall-Mount Bracket | Overhead Wall-Mount Bracket |
| 1. Pattern Number | <i>Example:</i> DS1WM 30 | Overhead Back Stop | Overhead Back Stop |
| Overhead Back Stop | DS1WM Pattern Number | | |
| 1. Pattern Number | 30 | | |
| | Overhead Back Stop | | |
| | <i>Example:</i> DB1BS 30 | | |
| | DB1BS 30 Pattern Number | | |

Mounting Brackets and Accessories

Upmount Brackets, Vertical Dividers and Lock Retrofit Kit

Dividends Horizon

| description | pattern no. | black | P1 | P2 | P3 |
|---|----------------|--------|--------|--------|--------|
| Vertical Dividers (for flip-up overheads and open shelves) Package of 4  | DS1 VD | \$100. | \$104. | \$109. | \$115. |
| Overhead Cabinet Lock Retrofit Kit  | DS1 OHL | 60. | n/a | n/a | n/a |
| Overhead Upmount Brackets (Pair)  | DB1U18 | n/a | 76. | 82. | 87. |
| Reuter Upmount Brackets (Pair)  | DB1RU18 | n/a | 103. | 110. | 118. |
| Reuter Overhead Panel Bracket (pair)  | RO1DPB | 63. | n/a | n/a | n/a |
| Reuter Shelf Panel-Mount Bracket (pair)  | RS1DPB | 63. | n/a | n/a | n/a |

Ordering Information

Vertical Dividers

1. Pattern Number

Reuter Overhead Panel-Mount Bracket

1. Pattern Number

Order Code

Vertical Dividers

Example: **DS1 VD**

Reuter Overhead Panel-Mount Bracket

Example: **RO1 DPB**

Included with:

Vertical Dividers
(4) Vertical dividers

Reuter Overhead Panel-Mount Bracket
Brackets (pair)

Options

Vertical Dividers

Reuter Overhead Panel-Mount Bracket

Overhead cabinet lock retrofit kit is for Dividends Series 1 and Series 2 Flip-up Overhead only.

This page intentionally left blank

Task Lights

Dividends Horizon offers T5 and LED task lights. T5 task lights are available in standard and advanced models. Task lights must be ordered separately from shelves, overhead cabinets, and overdesk units.

Task lights are TCLP compliant and meet requirements of California Title 20 and Title 24. T5 advanced task lights are fitted with ballasts and lamps compliant with LEED requirements. All task lights are approved for New York City installations.

T5 Task Lights

T5 task lights include T5 cool white (4100K) fluorescent lamp, electronic ballast, 9 foot grounded cordset, prismatic lens, rocker switch, one cord exit management clip and mounting hardware. T5 task light housings are painted black.

The T5 task light cordset is a center exit. On smaller units the cord exit is off-center, but still not handed, allowing the cordset to be positioned either to the right or left of the task light for easy access to the closest available duplex.

All T5 task lights include mounting hardware for attachment to overhead cabinets, shelves, up mounted cabinets and freestanding overdesks. Specify task lights one size or less than the overall cabinet or overdesk width. T5 task lights have adjustable mounting brackets that lock into integral channels in the underside of the cabinet's lower shelf. The spring steel adjustable mounting brackets flex to install without requiring tools and allow the light to be positioned at any position side-to-side and front-to-back.

City of Chicago T5 task lights have a 9 foot power cord with a resettable circuit breaker built into the plug.

LED Task Lights

LED task lights include LED's, a power supply with 9'-12' cord and mounting hardware. Housings are clear anodized aluminum with white color end-caps. Cord management clips must be ordered separately. The power supply cord attaches to either end of the fixture, allowing for easier access to the closest available duplex.

LED task lights mount into the recess in the underside of overhead cabinets and shelves at least 5" wider than the task light width..

Cord Management Clips

Cord management clips attach to the integral slotted channels on panel frames to manage task light cordsets. Clips are 3/8" high black molded plastic construction.

Task Light Specifications

| Model Number | Fixture Length | Lamp Length | Lamp Part Number | Lamp Watts | Input Watts |
|--------------------------------|----------------|-------------|------------------------|------------|-------------|
| T5 Standard Task Lights | | | | | |
| DL3T5E19S | 19" | 12" | FULHAM F8T5/CW | 8 | 8 |
| DL3T5E25S | 25" | 21.6" | FULHAM F14T5/41K | 14 | 15 |
| DL3T5E37S | 37" | 33.4" | FULHAM F21T5/41K | 21 | 24 |
| DL3T5E49S | 49" | 45.2" | FULHAM F28T5/41K | 28 | 31 |
| T5 Advanced Task Lights | | | | | |
| DL3T5E25A | 25" | 22.2" | PHILIPS F14T5/841/ALTO | 14 | 18 |
| DL3T5E37A | 37" | 33.98" | PHILIPS F21T5/841/ALTO | 21 | 24 |
| DL3T5E49A | 49" | 45.8" | PHILIPS F28T5/841/ALTO | 28 | 31 |
| LED Task Lights | | | | | |
| DL4L17 | 17" | 16.4" | N/A | 6.6 | 7.8 |
| DL4L31 | 31" | 30.1" | N/A | 14.8 | 17.6 |
| DL4L44 | 44" | 43.7" | N/A | 21.8 | 25.9 |
| DL4L58 | 58" | 57.4" | N/A | 28.2 | 33.6 |

T5 Task Light

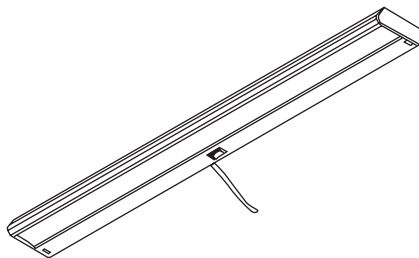

LED Task Light

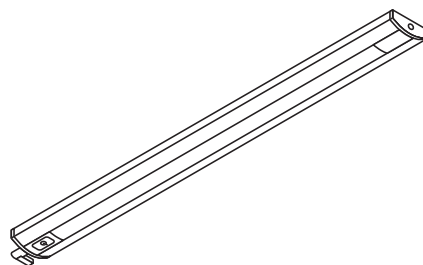

Cord Management Clip Attachment

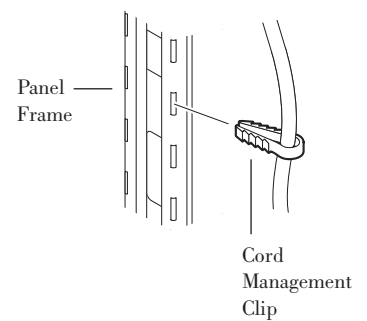

Task Lights

Cord Management Clip

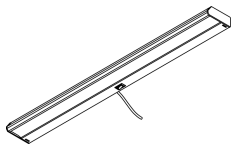
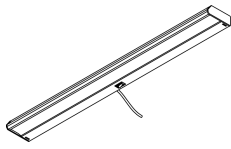
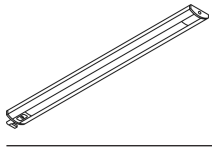
| description | type | w | d | h | pattern no. | list |
|--|--|-----|----|--------|------------------|--------|
|  T5 Standard Task Light | Use with 24" and wider overhead | 19" | 4" | 1 1/2" | DL3T5E19S | \$192. |
| | Use with 30" and wider overhead | 25" | 4" | 1 1/2" | DL3T5E25S | 209. |
| | Use with 42" and wider overhead | 37" | 4" | 1 1/2" | DL3T5E37S | 213. |
| | Use with 60" and wider overhead | 49" | 4" | 1 1/2" | DL3T5E49S | 233. |
|  T5 Advanced Task Light | Use with 30" and wider overhead | 25" | 4" | 1 1/2" | DL3T5E25A | 489. |
| | Use with 42" and wider overhead | 37" | 4" | 1 1/2" | DL3T5E37A | 514. |
| | Use with 60" and wider overhead | 49" | 4" | 1 1/2" | DL3T5E49A | 535. |
|  LED Task Light | Use with 24" and wider overhead (24 LED's) | 17" | 2" | 1/2" | DL4L17 | 495. |
| | Use with 36" and wider overhead (48 LED's) | 31" | 2" | 1/2" | DL4L31 | 825. |
| | Use with 44" and wider overhead (72 LED's) | 44" | 2" | 1/2" | DL4L44 | 1,075. |
| | Use with 66" and wider overhead (96 LED's) | 58" | 2" | 1/2" | DL4L58 | 1,350. |
| Cord management clip | (package of 50) | | | | DL3TC | 48. |

Ordering Information

Task Lights

1. Pattern Number

Cord Management Clip

1. Pattern Number

Order Code

T5 Standard Task Light

Example: **DL3T5E25S**

DL3 Task Light

T5 T5 lamp

E Electronic ballast

25 Width

S Standard

LED Task Light

Example: **DL4L17**

DL4 Task Light

L LED

17 Width

Included with:

T5 Task Lights:

120v and includes T5 cool white (4100K) fluorescent lamp, electronic ballast, 9' grounded cordset, prismatic lens, rocker switch, one cord exit management clip and mounting hardware. Housings are black.

LED Task Lights:

Includes LED's, power supply with 9-12' cord and mounting hardware. Housings are clear anodized aluminum with white color end-caps.

Cord Management Clips:

Additional clips must be ordered separately.

Options

T5 Task Lights:

Specify suffix -CH and add \$45 list for City of Chicago installations. Example: DL3T5E25S-CH

Cordset is center exit. On smaller units cord exit is off-center, but still not handed.

T5 advanced task lights are fitted with ballasts and lamps compliant with LEED requirements, meeting the LEED EB standard for mercury content.

LED Task Lights:

Power cord is able to attach to either end of fixture.

Notes:

All task lights mount into the recess in the underside of overhead cabinets and shelves at least 6" wider than task light width.

All task lights are TCLP compliant and meet requirements of California Title 20 and Title 24.

Dividends Floorstanding, Doublewide and Mobile Specifications

Floorstanding Pedestals

Dividends Series 1 floorstanding pedestals are used to support worksurfaces in both panel-wrap and freestanding desk applications. No cantilevers or other supports are required at the end of the worksurface supported by a pedestal.

For panel-wrap applications, three depths are available in order to mount beneath 18", 24" and 30" deep worksurfaces.

In floorstanding desks, pedestals can either be specified "Preconfigured" with floorstanding desks or ordered by component for "Build-to-Spec" applications.

Two drawer configurations are available: box/box/file and file/file. Pedestals can be specified with or without locks.

Mobile Pedestals

Dividends Series 1 mobile pedestals provide moveable storage within workstations and tuck beneath worksurfaces when not in use. Available drawer configurations are box/box/file, box/file, and file/file.

Mobile pedestals roll on four corner-mounted swivel casters and one bottom drawer-mounted caster for stability when the lower drawer is in the open position. The front corner casters are locking.

Mobile pedestals may be specified with an optional handle allowing easy mobility. All mobile pedestals include 13-gauge finished tops. All other construction and drawer dimensions are the same as freestanding pedestals.

Mobile pedestals measure 20⁵/₈" and 26⁵/₈" high, 15" wide and 18" or 24" deep. All mobile pedestals include locks.

Available Sizes

Depths: 18", 24" and 30"
Width: 15"
Height: 20⁵/₈" and 26⁷/₈"

Doublewide Pedestals

The doublewide pedestal incorporates two 12" high drawers in a 30" width (18³/₄" depth) and is intended for below worksurface applications only. The doublewide's design allows for side-to-side letter or legal filing and front-to-back letter filing.

Doublewide pedestal can be used below 19", 24", or 36" deep worksurfaces, not 18" deep worksurfaces.

Available Size

Depth: 18³/₄" (floorstanding pedestal only)
Width: 30"
Height: 26⁷/₈"

Construction

Floorstanding mobile and doublewide pedestals match the aesthetics and dimensions of Dividends Horizon panel components.

- Outer wrapper: 20-gauge seamless steel wrapper, includes finished back and full dust pan
- Inner frame: 20-gauge steel uprights and 16-gauge cross rails
- Drawer front: 20-gauge steel, gently radiused (double wide front: 18-gauge)
- Drawer top cap trim: Color injected, molded plastic
- Box drawer suspension (floorstanding ped only): ³/₄" extension, ball-bearing slides

- File drawer suspension: Full extension, ball-bearing slides
- Drawer pulls: Color injected, molded plastic
- Leveling glides: ³/₈" diameter steel stem with 1¹/₂" of height adjustment (double wide ped: ⁵/₁₆" diameter steel stem with a 1⁹/₁₆" of height adjustment)

Internal Drawer Dimensions (DS1)

Box drawer

- Internal height: 4⁵/₁₆"
- Internal width: 12⁹/₁₆"
- Internal depths: 18" = 15¹⁵/₁₆", 24" = 21¹/₄", 30" = 27¹/₄"

File drawer

- Internal height: 9¹/₄"
- Internal width: 12¹/₈"
- Internal depths: 18" = 15¹⁵/₁₆", 24" = 21¹/₄", 30" = 27¹/₄"

File drawer (doublewide ped)

- Internal height: 9³/₄"
- Internal width: 26³/₄"
- Internal depth: 15³/₄"

Locks

Pedestals can be ordered with or without locks. When specified without locks, a lock plug is included. An optional lock retrofit kit is available for field installation of locks at a later date if required.

Locks are keyed randomly unless otherwise specified. Other keying options include keyed alike or keyed with lock cores K001-K250. All random keyed locks are factory-installed and have a black finish.

Pedestal Accessories

A hanging file bar for front-to-back or side-to-side filing is included with Series 1 pedestals.

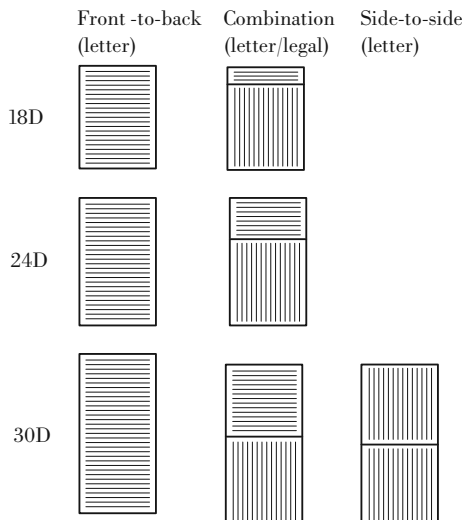

Pedestal Filing Configurations

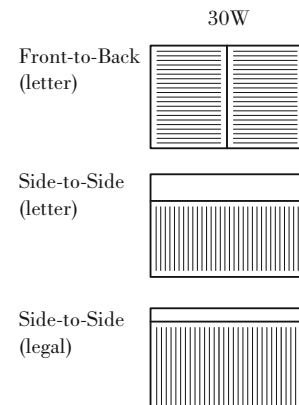

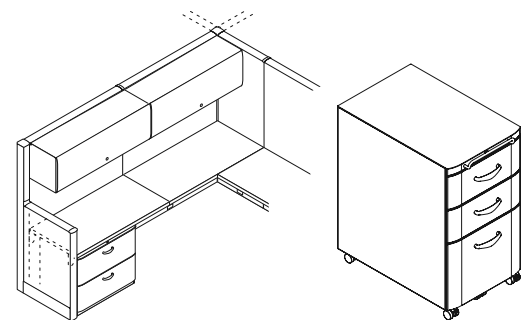

Doublewide Pedestal Filing Configurations



Doublewide Pedestal

Mobile Pedestal

Dividends Floorstanding, Doublewide and Mobile 18", 24" and 30" Depths

| description | type | d* | d | w | h | pattern no. | P1 | P2 | P3 |
|---|--------|-----|---------|---------|---------|-------------------|--------|--------|--------|
|  <p>Floorstanding Pedestals with Locks</p> | 6/6/12 | 18" | 17 1/2" | 14 7/8" | 26 7/8" | DS1PF L18A | \$619. | \$679. | \$711. |
| | 12/12 | 18" | 17 1/2" | 14 7/8" | 26 7/8" | DS1PF L18B | 595. | 653. | 684. |
| | 6/6/12 | 24" | 23 1/2" | 14 7/8" | 26 7/8" | DS1PF L24A | 679. | 747. | 781. |
| | 12/12 | 24" | 23 1/2" | 14 7/8" | 26 7/8" | DS1PF L24B | 652. | 719. | 748. |
| | 6/6/12 | 30" | 29 1/2" | 14 7/8" | 26 7/8" | DS1PF L30A | 713. | 783. | 821. |
| | 12/12 | 30" | 29 1/2" | 14 7/8" | 26 7/8" | DS1PF L30B | 683. | 748. | 782. |
|  <p>Mobile Pedestals with Locks</p> | 6/6/12 | 18" | 17 1/2" | 14 7/8" | 26 3/8" | DS1PM L18A | 1,021. | 1,050. | 1,174. |
| | 12/12 | 18" | 17 1/2" | 14 7/8" | 26 3/8" | DS1PM L18B | 990. | 1,091. | 1,140. |
| | 6/12 | 18" | 17 1/2" | 14 7/8" | 20 5/8" | DS1PM L18F | 908. | 998. | 1,045. |
| | 6/6/12 | 24" | 22 3/4" | 14 7/8" | 26 3/8" | DS1PM L24A | 1,099. | 1,211. | 1,265. |
| | 12/12 | 24" | 22 3/4" | 14 7/8" | 26 3/8" | DS1PM L24B | 1,069. | 1,174. | 1,227. |
| | 6/12 | 24" | 22 3/4" | 14 7/8" | 20 5/8" | DS1PM L24F | 984. | 1,082. | 1,130. |
|  <p>Doublewide Pedestals with Locks</p> | 12/12 | 19" | 18 3/4" | 30" | 26 7/8" | DS1DW 30L | 939. | 1,034. | 1,080. |

d* = nominal depth
 Dimensions listed under d w h are actual to the nearest 1/16"

| Ordering Information | Order Code | Included with: | Options |
|--|--|---|--|
| Floorstanding Pedestals 1. Pattern Number 2. Paint Finish 3. Pull Finish 4. Drawer Top Cap Finish Mobile Pedestals 1. Pattern Number 2. Paint Finish 3. Pull Finish 4. Drawer Top Cap Finish Doublewide Pedestals 1. Pattern Number 2. Paint Finish 3. Pull Finish 4. Drawer Top Cap Finish | Floorstanding Pedestals <i>Example:</i> DS1PF L24A, 117, 117, 117 <hr/> DS1PF Pattern Number 24A <hr/> 117 Soft Grey paint finish <hr/> 117 Soft Grey pull finish <hr/> 117 Soft Grey top cap finish <hr/> Doublewide Pedestals <i>Example:</i> DS1DW 30L, 117, 117, 117 <hr/> DS1DW Pattern Number 30L <hr/> 117 Soft Grey paint finish <hr/> 117 Soft Grey pull finish <hr/> 117 Soft Grey top cap finish <hr/> Mobile Pedestals <i>Example:</i> DS1PM L24A, 117, 117, 117 <hr/> DS1PM Pattern Number L24A <hr/> 117 Soft Grey paint finish <hr/> 117 Soft Grey pull finish <hr/> 117 Soft Grey drawer top cap finish | Floorstanding Pedestals <ul style="list-style-type: none"> • Hanging file bar (file drawer) Mobile Pedestals <ul style="list-style-type: none"> • Hanging file bar (file drawer) Doublewide Pedestals <ul style="list-style-type: none"> • Hanging file bar (front-to-back) • Hanging file rail (side-to-side) Doublewide pedestals are not intended for freestanding use and must be secured beneath a panel supported worksurface | Floorstanding Pedestals <ul style="list-style-type: none"> • To specify pedestals without locks, replace the "L" (6th character) in the pattern number with an "N". Deduct \$20 Doublewide Pedestals <ul style="list-style-type: none"> • To specify pedestals without locks, replace the "L" (6th character) in the pattern number with an "N". Deduct \$20 Mobile Pedestals Mobile pedestals are available with lock only. To specify a Dividends mobile pedestal with a handle, add "P" as the 7th character of the pattern number ie. DS1PML(P)24 add \$53 Full Extension Drawer Slide Option To specify full extension drawer slides for box drawers, add "F" at the end of the pattern number and add \$25 to the list price. |

Pedestals

Series 2 Floorstanding, Doublewide and Mobile Specifications

Series 2 Floorstanding Pedestals

Series 2 floorstanding pedestals are used to support worksurfaces in both panel wrapped and freestanding applications. No cantilevers or other supports are required at the end of the worksurface supported by a pedestal.

Two drawer configurations are available: box/box/file and file/ file. Mobile pedestals are not available without locks.

The Series 2 24" deep pedestal design offers case without a back. In panel applications or in freestanding desking applications where the desk is against the wall, a back is not necessary.

In desking applications where the back of the case is exposed, an optional back is used to conceal the pedestals contents.

The 18" and 30" deep Series 2 pedestals include a back with each case.

Mobile Pedestals

Series 2 mobile pedestals provide moveable storage within a workstation and tuck beneath worksurfaces when not in use. Available drawer configurations are box/file, box/box/file and file/file.

Mobile pedestals roll on four corner-mounted swivel casters and one bottom drawer-mounted caster for stability when the lower drawer is in the open position. The front corner casters are locking.

Mobile pedestals may be specified with an optional handle allowing easy mobility.

All mobile pedestals include 13-gauge finished tops. A back is included with all Series 2 mobile pedestals.

Pedestals may be specified without the top for attachment of a pedestal cushion. Pedestal cushion may be ordered through the Knoll Currents product line.

Available Sizes

Depths: 18", 24" and 30" (Floorstanding pedestal only)

Width: 15"

Height: 26 ⁷/₈"

Series 2 Doublewide Pedestals

The doublewide pedestal incorporates two 12" high drawers in a 30" or 36" width (18 ³/₄" depth) and is intended for below worksurface applications only. The doublewide's design allows for side-to-side letter or legal filing and front-to-back letter filing.

Doublewide pedestals can be used below 19", 24", 30" or 36" deep worksurfaces, not 18" deep worksurfaces.

Available Sizes

Depth: 18 ³/₄" (floorstanding pedestal only)

Width: 30" and 36"

Height: 26 ⁷/₈"

Construction:

- Outer wrapper: 20-gauge steel
- Drawer front: 20-gauge steel (double wide front: 18-gauge)
- Pedestal back: 20-gauge
- ³/₄ extension ball bearing slides on 6" box drawers

- Full extension ball bearing slides on 12" file drawers
- Leveling glides: ³/₈" diameter steel stem with 1 ¹/₂" of height adjustment (double wide ped: ⁵/₁₆" diameter steel stem with a 1 ⁹/₁₆" of height adjustment

Internal Drawer Dimensions (DS2, 24"d) Box drawer

- Internal height: 4 ⁵/₁₆"
- Internal width: 12 ¹/₁₆"
- Internal depths: 18 ³/₈"

File drawer

- Internal height: 9 ¹/₄"
- Internal width: 12 ¹/₈"
- Internal depths: 18 ³/₈"

File drawer (doublewide pedestal)

- Internal height: 9 ³/₄"
- Internal width: 26 ³/₄" and 32 ³/₄"
- Internal depth: 15 ³/₄"

Locks

Series 2 mobile pedestals are available not available without locks. Series 2 doublewide pedestals can be ordered with or without locks.

Locks are randomly keyed unless otherwise specified. Other keying options include keyed alike or keyed with lock cores K001-K250. All locks are factory-installed and have a black finish.

Pedestal Accessories

All Series 2 freestanding pedestal accessories including the hanging file bar must be specified separately. Series 2 double wide pedestals are shipped with hanging file bars.

Interior drawer dimensions for DS2 are 18" deep and 30" deep. Pedestals are the same as DS1 dimensions listed on page 228.

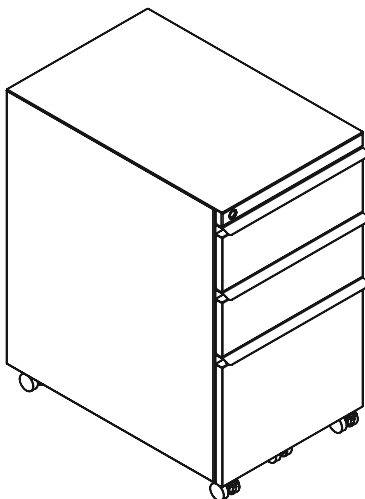

Mobile Pedestal

Pedestals

Series 2 Floorstanding, Doublewide and Mobile

18", 24" and 30" Depths

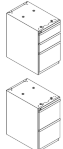
| description | type | d* | d | w | h | pattern no. | P1 | P2 | P3 | |
|---|---|---------------|---------|---------|---------|-------------------|-------------------|--------|--------|--------|
|  | Series 2 Floorstanding Pedestals with Locks | 6/6/12 w/back | 18" | 17 1/2" | 14 7/8" | 26 7/8" | DS2PF L18A | \$623. | \$718. | \$747. |
| | 12/12 w/back | 18" | 17 1/2" | 14 7/8" | 26 7/8" | DS2PF L18B | 599. | 690. | 720. | |
| | 6/6/12 no back | 24" | 23 1/2" | 14 7/8" | 26 7/8" | DS2PF L24A | 535. | 616. | 641. | |
| | 12/12 no back | 24" | 23 1/2" | 14 7/8" | 26 7/8" | DS2PF L24B | 505. | 583. | 607. | |
| | 6/6/12 w/back | 30" | 24 1/2" | 14 7/8" | 26 7/8" | DS2PF L30A | 720. | 828. | 867. | |
| | 12/12 w/back | 30" | 29 1/2" | 14 7/8" | 26 7/8" | DS2PF L30B | 688. | 788. | 824. | |

| | | | | | | | | | |
|--|--|--|--|---------|---------|---------------|-----|------|------|
| Series 2 Floorstanding Case Back (For 24" deep units only) | | | | 14 7/8" | 26 7/8" | DS2XPB | 92. | 103. | 106. |
|--|--|--|--|---------|---------|---------------|-----|------|------|

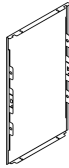

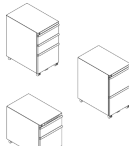
| | | | | | | | | | | |
|---|--------------------------------------|--------|---------|---------|---------|-------------------|-------------------|--------|--------|--------|
|  | Series 2 Mobile Pedestals with Locks | 6/6/12 | 18" | 16 3/4" | 14 7/8" | 26 3/8" | DS2PM L18A | 1,031. | 1,182. | 1,234. |
| | 12/12 | 18" | 16 3/4" | 14 7/8" | 26 3/8" | DS2PM L18B | 997. | 1,148. | 1,198. | |
| | 6/12 | 18" | 16 3/4" | 14 7/8" | 20 5/8" | DS2PM L18F | 915. | 1,055. | 1,099. | |
| | 6/6/12 | 24" | 22 3/4" | 14 7/8" | 26 3/8" | DS2PM L24A | 730. | 843. | 879. | |
| | 12/12 | 24" | 22 3/4" | 14 7/8" | 26 3/8" | DS2PM L24B | 730. | 843. | 879. | |
| | 6/12 | 24" | 22 3/4" | 14 7/8" | 20 3/8" | DS2PM L24F | 655. | 753. | 784. | |

d* = nominal depth
 Dimensions listed under d w h are actual to the nearest 1/16"

| Ordering Information | Order Code | Included with: | Options |
|--|---|--|--|
| Pedestals 1. Pattern Number 2. Paint Finish | Floorstanding Pedestals <i>Example:</i> DS2PF L24A, 117 <hr/> DS2PF Pattern Number L24A <hr/> 117 Soft Grey paint finish <hr/> Doublewide Pedestals <i>Example:</i> DS2DW 30L, 113 <hr/> DS2DW Pattern Number 30L <hr/> 113 Dark grey paint finish | Floorstanding Pedestals <ul style="list-style-type: none"> Hanging file bar not included Note: 24" deep floorstanding pedestals do not include a back panel. Back panels must be ordered separately. 18" and 30" deep floorstanding pedestals have backs. | Floorstanding Pedestals <ul style="list-style-type: none"> To specify pedestals without locks, replace the "L" suffix with an "N". Deduct \$15 Doublewide Pedestals <ul style="list-style-type: none"> To specify pedestals without locks, replace the "L" suffix with an "N". Deduct \$20 Mobile Pedestals <ul style="list-style-type: none"> To specify a Series 2 mobile pedestal without a steel top, replace "M" character with "O" in the pattern number ie. DS2P(O)L24A Deduct \$35 Add \$53 list for mobile handle. Add a "P" between the "L" lock code and the case size to designate the handle option, example (DS2PMLP24A) Finish Option: Add a "Y" to the end of the pattern number to specify a different finish for the door versus the case. Use P3 pricing for this dual finish option. |
| | | Mobile Pedestals <ul style="list-style-type: none"> Hanging file bar not included Doublewide Pedestals <ul style="list-style-type: none"> Hanging File Bar (front-to-back) Hanging file rail (side-to-side) Doublewide pedestals are not intended for freestanding use and must be secured beneath a panel supported worksurface. | Mobile Pedestals <ul style="list-style-type: none"> To specify a Series 2 mobile pedestal without a steel top, replace "M" character with "O" in the pattern number ie. DS2P(O)L24A Deduct \$35 Add \$53 list for mobile handle. Add a "P" between the "L" lock code and the case size to designate the handle option, example (DS2PMLP24A) Full Extension Drawer Slide Option To specify full extension drawer slides for box drawers, add "F" at the end of the pattern number and add \$25 to the list price. |

Pedestals

Series 2 Floorstanding, Doublewide and Mobile

18", 24" and 30" Depths

| description | type | d* | d | w | h | pattern no. | P1 | P2 | P3 |
|--|-------|-----|----------------------------------|-----|----------------------------------|------------------|--------|----------|----------|
| Series 2 Doublewide Pedestals with Locks | 12/12 | 19" | 18 ³ / ₄ " | 30" | 26 ⁷ / ₈ " | DS2DW 30L | \$945. | \$1,088. | \$1,135. |
| | 12/12 | 19" | 18 ³ / ₄ " | 36" | 26 ⁷ / ₈ " | DS2DW 36L | 998. | 1,149. | 1,199. |



d* = nominal depth
 Dimensions listed under d w h are actual to the nearest 1/16"

| Ordering Information | Order Code | Included with: | Options |
|----------------------|--|---|---|
| Pedestals | Floorstanding Pedestals | Floorstanding Pedestals | Floorstanding Pedestals |
| 1. Pattern Number | <i>Example:</i> DS2PF L24A, 117 | <ul style="list-style-type: none"> Hanging file bar not included | <ul style="list-style-type: none"> To specify pedestals without locks, replace the "L" suffix with an "N". Deduct \$15 |
| 2. Paint Finish | DS2PF Pattern Number L24A | Note: 24" deep floorstanding pedestals do not include a back panel. Back panels must be ordered separately. 18" and 30" deep floorstanding pedestals have backs. | Doublewide Pedestals |
| | 117 Soft Grey paint finish | | <ul style="list-style-type: none"> To specify pedestals without locks, replace the "L" suffix with an "N". Deduct \$20 |
| | Doublewide Pedestals | Mobile Pedestals | Mobile Pedestals |
| | <i>Example:</i> DS2DW 30L, 113 | <ul style="list-style-type: none"> Hanging file bar not included | <ul style="list-style-type: none"> To specify a Series 2 mobile pedestal without a steel top, replace "M" character with "O" in the pattern number ie. DS2P(O)L24A Deduct \$35 Add \$53 list for mobile handle. Add a "P" between the "L" lock code and the case size to designate the handle option, example (DS2PMLP24A) |
| | DS2DW Pattern Number 30L | Doublewide Pedestals | Finish Option: |
| | 113 Dark grey paint finish | <ul style="list-style-type: none"> Hanging File Bar (front-to-back) Hanging file rail (side-to-side) <p>Doublewide pedestals are not intended for freestanding use and must be secured beneath a panel supported worksurface.</p> | Add a "Y" to the end of the pattern number to specify a different finish for the door versus the case. Use P3 pricing for this dual finish option. |
| | | | Full Extension Drawer Slide Option |
| | | | To specify full extension drawer slides for box drawers, add "F" at the end of the pattern number and add \$25 to the list price. |

This page intentionally left blank

Pencil Tray

Five section tray rides on drawer sides of box drawers. Plastic injection molded construction. 13¹/₄" wide, 5⁷/₁₆" deep and 7/8" high. Black or clear finish available.

Hanging File Bar

Allows for side-to-side hanging folders. 20-gauge steel construction. Set of two. Black finish.

A hanging file bar is included with each file drawer when ordering Series 1 desks or pedestals. Hanging file bars are not included with Series 2 pedestals or desks - order separately.

Drawer Dividers

Two styles available: box drawer and file drawer sizes. 18-gauge steel construction. Black finish.

Stationery Inserts

Set of four trays for use in box drawers. 18-gauge steel construction. Can accommodate letter-and legal-sized stationery. Black finish.

Pencil Drawer

For use with freestanding desks or panel-mounted worksurfaces with depths of 24" or more. 24" wide, 17 5/8" deep and 2" high. Black finish.

Attachment: Mounts on underside of worksurface with included mounting hardware

Pedestal Lock Retrofit Kit

Allows existing nonlocking pedestals to be field-retrofitted with locks. Includes lock housing, lock core and lock rod assembly (must be specified box/box/file or file/file).

Worksurface Edge Grommet

Available factory-installed when ordering worksurfaces or as a kit for field installation. Can be installed in any location along the rear edge of worksurfaces. Includes a cutting template, grommet and cover. Dark grey finish.

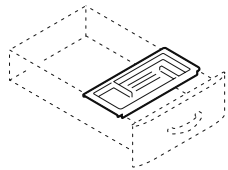

Pencil Tray

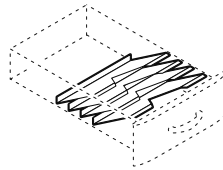

Stationery Inserts

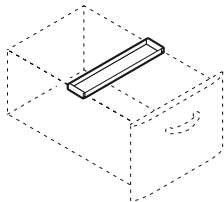

Hanging File Bar

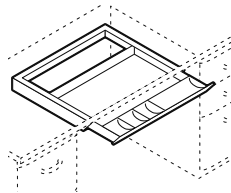

Pencil Drawer

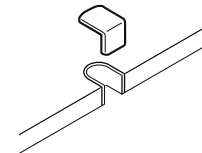

Worksurface Edge Grommet

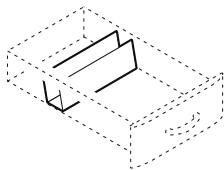



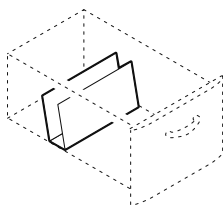



Drawer Divider, Box



Drawer Divider, File Drawer

Accessories

Drawer Organizers, Grommet Kits and Lock Retrofit Kits

| description | type | w | d | h | pattern no. | list |
|--|--------------|----------|----------|--------|-------------------|-------|
| Pencil Tray  | Black finish | 13 1/4" | 5 7/8" | 7/8" | DS2PPTN | \$40. |
| | Clear finish | 13 1/4" | 5 7/8" | 7/8" | DS2PPTC | 47. |
| Hanging File Bar  | | 12 3/16" | 2 15/16" | 1/2" | DS1PFS | 34. |
| Drawer Divider, Box  | | 12 3/8" | 3" | 3 1/8" | DS1PBD | 34. |
| Drawer Divider, File  | | 10 | 3 5/8" | 6 3/8" | DS1PFD | 34. |
| Stationary Inserts, box (4 trays)  | | 13 | 15 1/16" | 8 7/8" | DS1PST | 182. |
| Pencil Drawer  | | 24" | 17 5/8" | 2" | DS1PCD | 248. |
| Worksurface Grommet Kit (Dark Grey)  | | 2 3/16" | 2 5/16" | 1 3/8" | D1WSG | 25. |
| Dividends Floorstanding Pedestal Lock Retrofit Kit | | | | | DS1LKKT | 76. |
| Series 2 Floorstanding Pedestal Lock Retrofit Kit | 24" ped only | | | | DS2LKKT | 62. |
| Dividends Doublewide Pedestal Lock Retrofit Kit | | | | | DS1DWDPL | 69. |
| Series 2 Doublewide Pedestal Lock Retrofit Kit | | 30" | | | DS2DWDPL30 | 66. |
| | | 36" | | | DS2DWDPL36 | 69. |

Ordering Information

Pencil Tray
1. Pattern Number

Order Code

Pencil Tray
Example: **DS2PPT**
DS2PPT Pattern Number

Included with:

Pencil Tray

Options

Single Depth Credenzas

Dividends Horizon single depth credenzas increase planning and design options by blending residential furniture attributes within systems furniture applications. Credenzas offer a practical solution for functional under worksurface storage, while increasing the overall aesthetics of an office.

Credenzas consist of a metal, laminate, or veneer top option with a shelf and binder storage area. Single depth credenzas have four configuration options: sliding door only, drawer only, sliding door and drawer combination, and open shelves without a sliding door or a drawer.

The sliding door is a single steel, laminate, or veneer door with a handle that conceals half the width of the binder storage area. A single drawer may be specified for the location above the shelf. The drawer may be installed in either the right or left location, the drawer location does not need to be specified when ordered. When a drawer is specified along with a sliding door, the drawer front and sliding door finishes are the same. Units that include a drawer have a full back and those without a drawer have a partial back that encloses the binder storage area below the shelf.

Shorter width credenzas, 24, 30, and 36 inches wide, are available with a laminate or veneer top only. 24 inch wide credenzas do not include a center vertical septum and are only available as open shelf units, without a sliding door or drawer. Units are shipped knocked down and may be specified with or without locks. Dividends Horizon credenzas are available in all Knoll Core finishes. Legacy finishes are not available.

Available Sizes

Heights: 24 inches

Depth: 13-5/16 inches

Widths: 24 – 72 inches

Construction

• Top:

- Steel: 16-gauge painted steel
- Laminate: 1-1/4 inch thick particle board with high pressure laminate on top and a paper backer on the underside with 2mm edgeband
- Veneer: 1-1/4 inch thick particle board with 0.6mm veneer on top and edge.

• End Panels: 16-gauge painted steel

• Back Panel: 20-gauge painted steel

• Door:

- Steel: 20-gauge panted steel
- Laminate: 3/4 inch thick particle board with high pressure laminate on the outside and a paper backer on the inside with 1mm edgeband
- Veneer 3/4 inch thick particle board with 0.6mm thick veneer on top and edge

• Fixed Shelf: 16-gauge painted steel

• Door Handle: painted aluminum (same color as case)

Interior Dimensions

Heights: 12-1/2 inches for the lower section,

5-7/8 inches for the upper section

Depth: 12-1/16 inches

Locks

Locks are standard on credenzas with doors and/or drawers and are keyed randomly unless otherwise specified. All locks are factory installed and have a black finish. Credenzas can also be specified without locks if required.

Single Depth Credenza
with Open Shelves

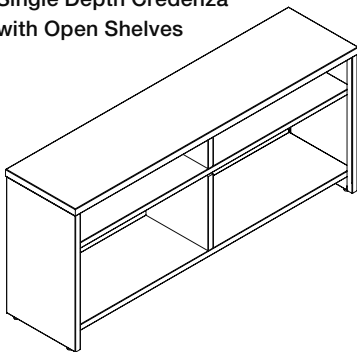

Single Depth Credenza
with a Drawer

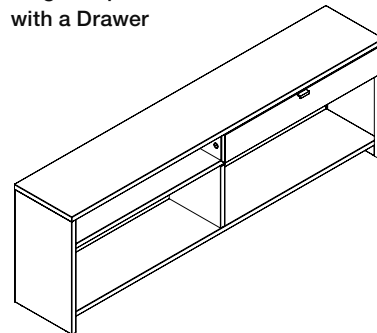

Single Depth Credenza
with a Sliding Door

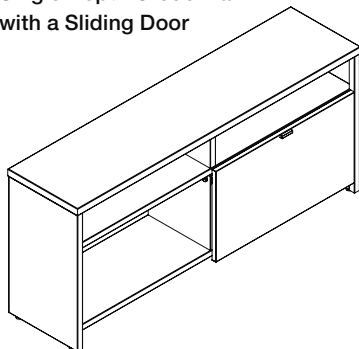

Single Depth Credenza
with a Drawer and a
Sliding Door

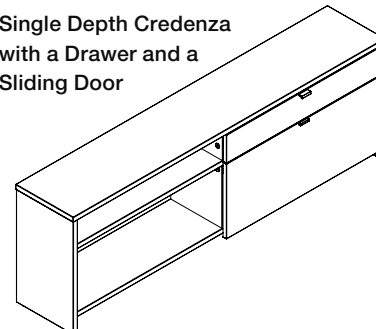

Credenzas

Single Depth with Steel Top

With or Without a Sliding Door

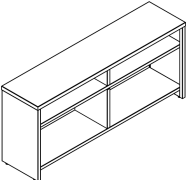
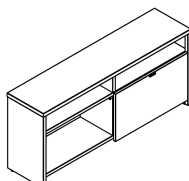
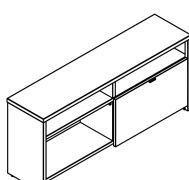
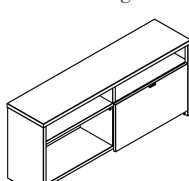
| description | w | h | d | pattern no. | P1 | P2 | P3 |
|--|-----|-----|-----------------------------------|---------------------|--------|--------|--------|
|  Credenza without Door | 42" | 24" | 13 ⁵ / ₁₆ " | DS4LC1ANS42N | \$685. | \$752. | \$786. |
| | 48" | 24" | 13 ⁵ / ₁₆ " | DS4LC1ANS48N | 702. | 772. | 808. |
| | 54" | 24" | 13 ⁵ / ₁₆ " | DS4LC1ANS54N | 782. | 862. | 902. |
| | 60" | 24" | 13 ⁵ / ₁₆ " | DS4LC1ANS60N | 791. | 872. | 911. |
| | 66" | 24" | 13 ⁵ / ₁₆ " | DS4LC1ANS66N | 815. | 895. | 936. |
| | 72" | 24" | 13 ⁵ / ₁₆ " | DS4LC1ANS72N | 848. | 932. | 972. |
|  Credenza with Steel Sliding Door | 42" | 24" | 13 ⁵ / ₁₆ " | DS4LC1BSS42L | 847. | 930. | 970. |
| | 48" | 24" | 13 ⁵ / ₁₆ " | DS4LC1BSS48L | 863. | 951. | 993. |
| | 54" | 24" | 13 ⁵ / ₁₆ " | DS4LC1BSS54L | 960. | 1,058. | 1,103. |
| | 60" | 24" | 13 ⁵ / ₁₆ " | DS4LC1BSS60L | 965. | 1,064. | 1,111. |
| | 66" | 24" | 13 ⁵ / ₁₆ " | DS4LC1BSS66L | 995. | 1,096. | 1,145. |
| | 72" | 24" | 13 ⁵ / ₁₆ " | DS4LC1BSS72L | 1,030. | 1,129. | 1,181. |
|  Credenza with Laminate Sliding Door | 42" | 24" | 13 ⁵ / ₁₆ " | DS4LC1BLS42L | 1,373. | 1,510. | 1,577. |
| | 48" | 24" | 13 ⁵ / ₁₆ " | DS4LC1BLS48L | 1,407. | 1,545. | 1,615. |
| | 54" | 24" | 13 ⁵ / ₁₆ " | DS4LC1BLS54L | 1,439. | 1,581. | 1,652. |
| | 60" | 24" | 13 ⁵ / ₁₆ " | DS4LC1BLS60L | 1,472. | 1,618. | 1,689. |
| | 66" | 24" | 13 ⁵ / ₁₆ " | DS4LC1BLS66L | 1,506. | 1,654. | 1,728. |
| | 72" | 24" | 13 ⁵ / ₁₆ " | DS4LC1BLS72L | 1,540. | 1,689. | 1,766. |
|  Credenza with Veneer Sliding Door | 42" | 24" | 13 ⁵ / ₁₆ " | DS4LC1BVS42L | 1,464. | 1,609. | 1,682. |
| | 48" | 24" | 13 ⁵ / ₁₆ " | DS4LC1BVS48L | 1,506. | 1,654. | 1,727. |
| | 54" | 24" | 13 ⁵ / ₁₆ " | DS4LC1BVS54L | 1,546. | 1,698. | 1,775. |
| | 60" | 24" | 13 ⁵ / ₁₆ " | DS4LC1BVS60L | 1,587. | 1,742. | 1,821. |
| | 66" | 24" | 13 ⁵ / ₁₆ " | DS4LC1BVS66L | 1,627. | 1,788. | 1,867. |
| | 72" | 24" | 13 ⁵ / ₁₆ " | DS4LC1BVS72L | 1,668. | 1,831. | 1,915. |

Dimensions listed under w h d are actual to the nearest 1/16"

| Ordering Information | Order Code | Included with: | Options |
|--|--|--|--|
| Credenza with Sliding Door: 1. Pattern number 2. Paint finish 3. Door finish (laminite and veneer only) 4. Door edge finish (laminite only) | Credenza with Sliding Door: <i>Example:</i> DS4LC1BSS42L/117 DS4LC1B Pattern Number SS42L 117 Dark grey paint | Credenza with or without Sliding Door: Note: Credenzas are only available in Knoll core finishes. | Credenza with or without Sliding Door: Lock/No lock option For non-locking credenzas with a sliding door or a drawer, substitute the "L" suffix with an "N" and deduct \$20 from the list price. |
| Credenza without Sliding Door: 1. Pattern number 2. Paint finish | <i>Example:</i> DS4LC1ANS42N/117 DS4LC1A Pattern Number NS42N 117 Dark grey paint | | Note: Credenzas with a drawer have a full back. Credenzas without a drawer have a partial back that encloses the binder storage area below the shelf. |

Paint Configuration Option:
 Add "Y" at the end of the pattern number to specify a different paint finish on the case and fronts. P3 pricing applies on all product with dual paint finishes.

Credenzas
Single Depth with Steel Top
Without a Sliding Door and with a Drawer

Dividends Horizon

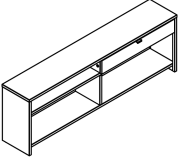
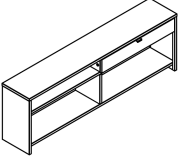
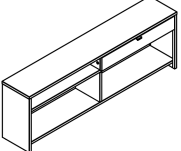
| description | w | h | d | pattern no. | P1 | P2 | P3 |
|---|-----|-----|-----------------------------------|---------------------|----------|----------|----------|
|  Credenza with Steel Drawer | 42" | 24" | 13 ⁵ / ₁₆ " | DS4LC1CSS42L | \$1,028. | \$1,094. | \$1,129. |
| | 48" | 24" | 13 ⁵ / ₁₆ " | DS4LC1CSS48L | 1,043. | 1,112. | 1,147. |
| | 54" | 24" | 13 ⁵ / ₁₆ " | DS4LC1CSS54L | 1,125. | 1,203. | 1,242. |
| | 60" | 24" | 13 ⁵ / ₁₆ " | DS4LC1CSS60L | 1,134. | 1,213. | 1,252. |
| | 66" | 24" | 13 ⁵ / ₁₆ " | DS4LC1CSS66L | 1,154. | 1,237. | 1,278. |
| | 72" | 24" | 13 ⁵ / ₁₆ " | DS4LC1CSS72L | 1,187. | 1,274. | 1,316. |
|  Credenza with Laminate Drawer | 42" | 24" | 13 ⁵ / ₁₆ " | DS4LC1CLS42L | 1,217. | 1,284. | 1,320. |
| | 48" | 24" | 13 ⁵ / ₁₆ " | DS4LC1CLS48L | 1,234. | 1,304. | 1,337. |
| | 54" | 24" | 13 ⁵ / ₁₆ " | DS4LC1CLS54L | 1,316. | 1,395. | 1,433. |
| | 60" | 24" | 13 ⁵ / ₁₆ " | DS4LC1CLS60L | 1,324. | 1,403. | 1,441. |
| | 66" | 24" | 13 ⁵ / ₁₆ " | DS4LC1CLS66L | 1,348. | 1,427. | 1,467. |
| | 72" | 24" | 13 ⁵ / ₁₆ " | DS4LC1CLS72L | 1,378. | 1,463. | 1,506. |
|  Credenza with Veneer Drawer | 42" | 24" | 13 ⁵ / ₁₆ " | DS4LC1CVS42L | 1,258. | 1,325. | 1,360. |
| | 48" | 24" | 13 ⁵ / ₁₆ " | DS4LC1CVS48L | 1,276. | 1,346. | 1,380. |
| | 54" | 24" | 13 ⁵ / ₁₆ " | DS4LC1CVS54L | 1,356. | 1,435. | 1,473. |
| | 60" | 24" | 13 ⁵ / ₁₆ " | DS4LC1CVS60L | 1,364. | 1,444. | 1,484. |
| | 66" | 24" | 13 ⁵ / ₁₆ " | DS4LC1CVS66L | 1,388. | 1,467. | 1,509. |
| | 72" | 24" | 13 ⁵ / ₁₆ " | DS4LC1CVS72L | 1,420. | 1,505. | 1,546. |

Dimensions listed under w h d are actual to the nearest 1/16"

| Ordering Information | Order Code | Included with: | Options |
|--|--|---|---|
| Credenza with a Drawer: 1. Pattern number 2. Paint finish 3. Drawer front finish (laminite and veneer only) 4. Drawer front edge finish (laminite only) | Credenza with a Drawer: <i>Example:</i> DS4LC1CLS42L /117/118/118 DS4LC1C Pattern Number LS42L 117 Dark grey paint 118 Bright white drawer front 118 Bright white drawer front edge | Credenza with a Drawer: Note: Credenzas are only available in Knoll core finishes. | Credenza with a Drawer: Lock/No lock option For non-locking credenzas with a sliding door or a drawer, substitute the "L" suffix with an "N" and deduct \$20 from the list price. Note: Credenzas with a drawer have a full back. Credenzas without a drawer have a partial back that encloses the binder storage area below the shelf. |

Paint Configuration Option:
 Add "Y" at the end of the pattern number to specify a different paint finish on the case and fronts. P3 pricing applies on all product with dual paint finishes.

Credenzas

Single Depth with Steel Top

With a Sliding Door and with a Drawer

Dividends Horizon

| description | w | h | d | pattern no. | P1 | P2 | P3 |
|---|-----|-----|-----------------------------------|---------------------|----------|----------|----------|
| Credenza with Steel Sliding Door and Drawer | 42" | 24" | 13 ⁵ / ₁₆ " | DS4LC1DSS42L | \$1,186. | \$1,273. | \$1,314. |
| | 48" | 24" | 13 ⁵ / ₁₆ " | DS4LC1DSS48L | 1,205. | 1,291. | 1,333. |
| | 54" | 24" | 13 ⁵ / ₁₆ " | DS4LC1DSS54L | 1,301. | 1,398. | 1,444. |
| | 60" | 24" | 13 ⁵ / ₁₆ " | DS4LC1DSS60L | 1,308. | 1,404. | 1,452. |
| | 66" | 24" | 13 ⁵ / ₁₆ " | DS4LC1DSS66L | 1,335. | 1,436. | 1,487. |
| | 72" | 24" | 13 ⁵ / ₁₆ " | DS4LC1DSS72L | 1,369. | 1,468. | 1,524. |

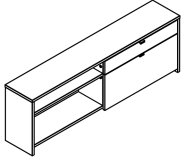

| | | | | | | | |
|--|-----|-----|-----------------------------------|---------------------|--------|--------|--------|
| Credenza with Laminate Sliding Door and Drawer | 42" | 24" | 13 ⁵ / ₁₆ " | DS4LC1DLS42L | 1,716. | 1,851. | 1,917. |
| | 48" | 24" | 13 ⁵ / ₁₆ " | DS4LC1DLS48L | 1,749. | 1,887. | 1,956. |
| | 54" | 24" | 13 ⁵ / ₁₆ " | DS4LC1DLS54L | 1,780. | 1,921. | 1,994. |
| | 60" | 24" | 13 ⁵ / ₁₆ " | DS4LC1DLS60L | 1,814. | 1,959. | 2,031. |
| | 66" | 24" | 13 ⁵ / ₁₆ " | DS4LC1DLS66L | 1,847. | 1,996. | 2,070. |
| | 72" | 24" | 13 ⁵ / ₁₆ " | DS4LC1DLS72L | 1,880. | 2,031. | 2,106. |

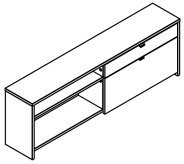

| | | | | | | | |
|--|-----|-----|-----------------------------------|---------------------|--------|--------|--------|
| Credenza with Veneer Sliding Door and Drawer | 42" | 24" | 13 ⁵ / ₁₆ " | DS4LC1DVS42L | 1,806. | 1,951. | 2,024. |
| | 48" | 24" | 13 ⁵ / ₁₆ " | DS4LC1DVS48L | 1,847. | 1,996. | 2,069. |
| | 54" | 24" | 13 ⁵ / ₁₆ " | DS4LC1DVS54L | 1,888. | 2,039. | 2,116. |
| | 60" | 24" | 13 ⁵ / ₁₆ " | DS4LC1DVS60L | 1,927. | 2,083. | 2,163. |
| | 66" | 24" | 13 ⁵ / ₁₆ " | DS4LC1DVS66L | 1,967. | 2,129. | 2,209. |
| | 72" | 24" | 13 ⁵ / ₁₆ " | DS4LC1DVS72L | 2,009. | 2,174. | 2,256. |

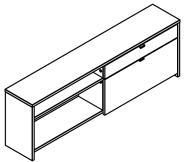

Dimensions listed under w h d are actual to the nearest 1/16"

| Ordering Information | Order Code | Included with: | Options |
|---|---|--|--|
| Credenza with a Sliding Door and a Drawer: 1. Pattern number 2. Paint finish 3. Drawer/Door finish (laminated and veneer only) 4. Drawer/Door edge finish (laminated only) | Credenza with a Sliding Door and a Drawer: <i>Example:</i> DS4LC1DSS42L/117 DS4LC1D Pattern Number SS42L 117 Dark grey paint | Credenza with a Sliding Door and a Drawer: Note: Credenzas are only available in Knoll core finishes. | Credenza with a Sliding Door and a Drawer: Lock/No lock option For non-locking credenzas with a sliding door or a drawer, substitute the "L" suffix with an "N" and deduct \$40 from the list price. Note: Credenzas with a drawer have a full back. Credenzas without a drawer have a partial back that encloses the binder storage area below the shelf. Paint Configuration Option: Add "Y" at the end of the pattern number to specify a different paint finish on the case and fronts. P3 pricing applies on all product with dual paint finishes. |

Storage Components

Credenzas

Single Depth with Laminate Top With or without a Sliding Door

Dividends Horizon

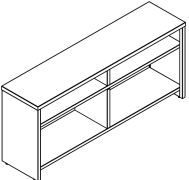
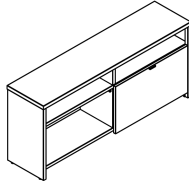
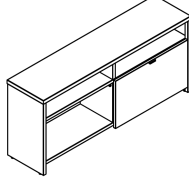
| description | w | h | d | pattern no. | P1 | P2 | P3 |
|--|-----|-----|-----------------------------------|---------------------|--------|----------|----------|
|  Credenza without Door | 24" | 24" | 13 ⁵ / ₁₆ " | DS4LC1ANL24N | \$921. | \$1,010. | \$1,060. |
| | 30" | 24" | 13 ⁵ / ₁₆ " | DS4LC1ANL30N | 921. | 1,010. | 1,060. |
| | 36" | 24" | 13 ⁵ / ₁₆ " | DS4LC1ANL36N | 921. | 1,010. | 1,060. |
| | 42" | 24" | 13 ⁵ / ₁₆ " | DS4LC1ANL42N | 921. | 1,010. | 1,060. |
| | 48" | 24" | 13 ⁵ / ₁₆ " | DS4LC1ANL48N | 947. | 1,041. | 1,090. |
| | 54" | 24" | 13 ⁵ / ₁₆ " | DS4LC1ANL54N | 1,020. | 1,123. | 1,175. |
| | 60" | 24" | 13 ⁵ / ₁₆ " | DS4LC1ANL60N | 1,021. | 1,125. | 1,176. |
| | 66" | 24" | 13 ⁵ / ₁₆ " | DS4LC1ANL66N | 1,058. | 1,164. | 1,215. |
| | 72" | 24" | 13 ⁵ / ₁₆ " | DS4LC1ANL72N | 1,093. | 1,202. | 1,255. |
|  Credenza with Steel Sliding Door | 30" | 24" | 13 ⁵ / ₁₆ " | DS4LC1BSL30L | 1,071. | 1,178. | 1,230. |
| | 36" | 24" | 13 ⁵ / ₁₆ " | DS4LC1BSL36L | 1,071. | 1,178. | 1,230. |
| | 42" | 24" | 13 ⁵ / ₁₆ " | DS4LC1BSL42L | 1,071. | 1,178. | 1,230. |
| | 48" | 24" | 13 ⁵ / ₁₆ " | DS4LC1BSL48L | 1,098. | 1,208. | 1,263. |
| | 54" | 24" | 13 ⁵ / ₁₆ " | DS4LC1BSL54L | 1,191. | 1,312. | 1,369. |
| | 60" | 24" | 13 ⁵ / ₁₆ " | DS4LC1BSL60L | 1,192. | 1,314. | 1,372. |
| | 66" | 24" | 13 ⁵ / ₁₆ " | DS4LC1BSL66L | 1,230. | 1,355. | 1,415. |
| | 72" | 24" | 13 ⁵ / ₁₆ " | DS4LC1BSL72L | 1,266. | 1,394. | 1,456. |
|  Credenza with Laminate Sliding Door | 30" | 24" | 13 ⁵ / ₁₆ " | DS4LC1BLL30L | 1,493. | 1,640. | 1,714. |
| | 36" | 24" | 13 ⁵ / ₁₆ " | DS4LC1BLL36L | 1,493. | 1,640. | 1,714. |
| | 42" | 24" | 13 ⁵ / ₁₆ " | DS4LC1BLL42L | 1,493. | 1,640. | 1,714. |
| | 48" | 24" | 13 ⁵ / ₁₆ " | DS4LC1BLL48L | 1,540. | 1,689. | 1,768. |
| | 54" | 24" | 13 ⁵ / ₁₆ " | DS4LC1BLL54L | 1,586. | 1,741. | 1,819. |
| | 60" | 24" | 13 ⁵ / ₁₆ " | DS4LC1BLL60L | 1,633. | 1,793. | 1,873. |
| | 66" | 24" | 13 ⁵ / ₁₆ " | DS4LC1BLL66L | 1,680. | 1,845. | 1,926. |
| | 72" | 24" | 13 ⁵ / ₁₆ " | DS4LC1BLL72L | 1,726. | 1,897. | 1,982. |

Dimensions listed under w h d are actual to the nearest 1/16"

| Ordering Information | Order Code | Included with: | Options |
|---|---|--|--|
| Credenza with Sliding Door: 1. Pattern number 2. Paint finish 3. Top finish 4. Top edge finish 5. Door finish (laminated and veneer only) 6. Door edge finish (laminated only) | Credenza with Sliding Door: Example: DS4LC1BLL42L /117/118/117/118/118 DS4LC1B Pattern Number LL42L 117 Dark grey paint 118 Bright white top 117 Dark grey top edge 118 Bright white door 118 Bright white door edge | Credenza with or without Sliding Door: Note: Credenzas are only available in Knoll core finishes. | Credenza with or without Sliding Door: Lock/No lock option For non-locking credenzas with sliding door or a drawer, substitute the "L" suffix with a "N" and deduct \$20. from the list price. Note: Credenzas with a drawer have a full back. Credenzas without a drawer have a partial back that encloses the binder storage area below the shelf. |
| Credenza without Sliding Door: 1. Pattern number 2. Paint finish 3. Top finish 4. Top edge finish | Credenza without a Sliding Door: Example: DS4LC1ANL42N/117 DS4LC1A Pattern Number NL42N 117 Dark grey paint 118 Bright white top 117 Dark grey top edge | | Paint Configuration Option: Add "Y" at the end of the pattern number to specify a different paint finish on the case and fronts. P3 pricing applies on all product with dual paint finishes. |

Credenzas

Single Depth with Laminate Top

With or without a Sliding Door

Dividends Horizon

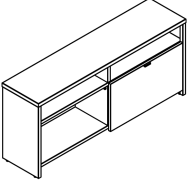
| description | w | h | d | pattern no. | P1 | P2 | P3 |
|---|-----|-----|-----------------------------------|---------------------|----------|----------|----------|
|  Credenza with Veneer Sliding Door | 30" | 24" | 13 ⁵ / ₁₆ " | DS4LC1BVL30L | \$1,586. | \$1,741. | \$1,821. |
| | 36" | 24" | 13 ⁵ / ₁₆ " | DS4LC1BVL36L | 1,586. | 1,741. | 1,821. |
| | 42" | 24" | 13 ⁵ / ₁₆ " | DS4LC1BVL42L | 1,586. | 1,741. | 1,821. |
| | 48" | 24" | 13 ⁵ / ₁₆ " | DS4LC1BVL48L | 1,641. | 1,802. | 1,882. |
| | 54" | 24" | 13 ⁵ / ₁₆ " | DS4LC1BVL54L | 1,693. | 1,861. | 1,945. |
| | 60" | 24" | 13 ⁵ / ₁₆ " | DS4LC1BVL60L | 1,748. | 1,920. | 2,007. |
| | 66" | 24" | 13 ⁵ / ₁₆ " | DS4LC1BVL66L | 1,802. | 1,979. | 2,070. |
| | 72" | 24" | 13 ⁵ / ₁₆ " | DS4LC1BVL72L | 1,855. | 2,039. | 2,131. |

Dimensions listed under w h d are actual to the nearest 1/16"

| Ordering Information | Order Code | Included with: | Options |
|---|--|--|--|
| Credenza with Sliding Door: 1. Pattern number 2. Paint finish 3. Top finish 4. Top edge finish 5. Door finish (laminated and veneer only) 6. Door edge finish (laminated only) | Credenza with Sliding Door: <i>Example:</i> DS4LC1BLL42L /117/118/117/118/118 DS4LC1B Pattern Number LL42L 117 Dark grey paint 118 Bright white top 117 Dark grey top edge 118 Bright white door 118 Bright white door edge | Credenza with or without Sliding Door: Note: Credenzas are only available in Knoll core finishes. | Credenza with or without Sliding Door: Lock/No lock option For non-locking credenzas with sliding door or a drawer, substitute the "L" suffix with a "N" and deduct \$20. from the list price. Note: Credenzas with a drawer have a full back. Credenzas without a drawer have a partial back that encloses the binder storage area below the shelf. |
| Credenza without Sliding Door: 1. Pattern number 2. Paint finish 3. Top finish 4. Top edge finish | Credenza without a Sliding Door: <i>Example:</i> DS4LC1ANL42N/117 DS4LC1A Pattern Number NL42N 117 Dark grey paint 118 Bright white top 117 Dark grey top edge | | Paint Configuration Option: Add "Y" at the end of the pattern number to specify a different paint finish on the case and fronts. P3 pricing applies on all product with dual paint finishes. |

Storage Components

*Single Depth with Laminate Top
Without a Sliding Door and with a Drawer*

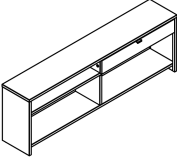
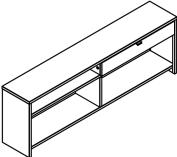
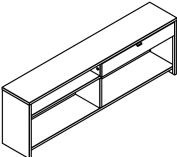
| description | w | h | d | pattern no. | P1 | P2 | P3 |
|--|-----|-----|-----------------------------------|---------------------|----------|----------|----------|
|  <p>Credenza with Steel Drawer</p> | 30" | 24" | 13 ⁵ / ₁₆ " | DS4LC1CSL30L | \$1,263. | \$1,353. | \$1,400. |
| | 36" | 24" | 13 ⁵ / ₁₆ " | DS4LC1CSL36L | 1,263. | 1,353. | 1,400. |
| | 42" | 24" | 13 ⁵ / ₁₆ " | DS4LC1CSL42L | 1,263. | 1,353. | 1,400. |
| | 48" | 24" | 13 ⁵ / ₁₆ " | DS4LC1CSL48L | 1,288. | 1,382. | 1,429. |
| | 54" | 24" | 13 ⁵ / ₁₆ " | DS4LC1CSL54L | 1,361. | 1,463. | 1,515. |
| | 60" | 24" | 13 ⁵ / ₁₆ " | DS4LC1CSL60L | 1,362. | 1,464. | 1,516. |
| | 66" | 24" | 13 ⁵ / ₁₆ " | DS4LC1CSL66L | 1,398. | 1,504. | 1,556. |
| | 72" | 24" | 13 ⁵ / ₁₆ " | DS4LC1CSL72L | 1,433. | 1,543. | 1,595. |
|  <p>Credenza with Laminate Drawer</p> | 30" | 24" | 13 ⁵ / ₁₆ " | DS4LC1CLL30L | 1,454. | 1,543. | 1,591. |
| | 36" | 24" | 13 ⁵ / ₁₆ " | DS4LC1CLL36L | 1,454. | 1,543. | 1,591. |
| | 42" | 24" | 13 ⁵ / ₁₆ " | DS4LC1CLL42L | 1,454. | 1,543. | 1,591. |
| | 48" | 24" | 13 ⁵ / ₁₆ " | DS4LC1CLL48L | 1,479. | 1,574. | 1,620. |
| | 54" | 24" | 13 ⁵ / ₁₆ " | DS4LC1CLL54L | 1,552. | 1,654. | 1,708. |
| | 60" | 24" | 13 ⁵ / ₁₆ " | DS4LC1CLL60L | 1,554. | 1,655. | 1,709. |
| | 66" | 24" | 13 ⁵ / ₁₆ " | DS4LC1CLL66L | 1,588. | 1,693. | 1,746. |
| | 72" | 24" | 13 ⁵ / ₁₆ " | DS4LC1CLL72L | 1,623. | 1,735. | 1,787. |
|  <p>Credenza with Veneer Drawer</p> | 30" | 24" | 13 ⁵ / ₁₆ " | DS4LC1CVL30L | 1,496. | 1,584. | 1,632. |
| | 36" | 24" | 13 ⁵ / ₁₆ " | DS4LC1CVL36L | 1,496. | 1,584. | 1,632. |
| | 42" | 24" | 13 ⁵ / ₁₆ " | DS4LC1CVL42L | 1,496. | 1,584. | 1,632. |
| | 48" | 24" | 13 ⁵ / ₁₆ " | DS4LC1CVL48L | 1,519. | 1,614. | 1,662. |
| | 54" | 24" | 13 ⁵ / ₁₆ " | DS4LC1CVL54L | 1,593. | 1,694. | 1,748. |
| | 60" | 24" | 13 ⁵ / ₁₆ " | DS4LC1CVL60L | 1,594. | 1,695. | 1,749. |
| | 66" | 24" | 13 ⁵ / ₁₆ " | DS4LC1CVL66L | 1,630. | 1,736. | 1,788. |
| | 72" | 24" | 13 ⁵ / ₁₆ " | DS4LC1CVL72L | 1,665. | 1,775. | 1,827. |

Dimensions listed under w h d are actual to the nearest 1/16"

| Ordering Information | Order Code | Included with: | Options |
|---|---|--|--|
| <p>Credenza with a Drawer:</p> <ol style="list-style-type: none"> 1. Pattern number 2. Paint finish 3. Top finish 4. Top edge finish 5. Drawer finish (laminated and veneer only) 6. Drawer edge finish (laminated only) | <p>Credenza with a Drawer:</p> <p><i>Example:</i> DS4LC1CSL42L /117/118/117</p> <hr/> <p>DS4LC1C Pattern Number</p> <hr/> <p>SL42L</p> <hr/> <p>117 Dark grey paint</p> <hr/> <p>118 Bright white top</p> <hr/> <p>117 Dark grey top edge</p> | <p>Credenza with a Drawer:</p> <p>Note: Credenzas are only available in Knoll core finishes.</p> | <p>Credenza with a Drawer:</p> <p>Lock/No lock option For non-locking credenzas with a sliding door or a drawer, substitute the "L" suffix with an "N" and deduct \$20 from the list price.</p> <p>Note: Credenzas with a drawer have a full back. Credenzas without a drawer have a partial back that encloses the binder storage area below the shelf.</p> <p>Paint Configuration Option: Add "Y" at the end of the pattern number to specify a different paint finish on the case and fronts. P3 pricing applies on all product with dual paint finishes.</p> |

Credenzas

Single Depth with Laminate Top

With a Sliding Door and with a Drawer

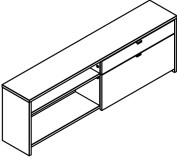
| description | w | d | h | pattern no. | P1 | P2 | P3 |
|---|-----|-----------------------------------|-----|---------------------|----------|----------|----------|
|  Credenza with Steel Sliding Door and Drawer | 30" | 13 ³ / ₁₆ " | 24" | DS4LC1DSL30L | \$1,411. | \$1,519. | \$1,574. |
| | 36" | 13 ³ / ₁₆ " | 24" | DS4LC1DSL36L | 1,411. | 1,519. | 1,574. |
| | 42" | 13 ³ / ₁₆ " | 24" | DS4LC1DSL42L | 1,411. | 1,519. | 1,574. |
| | 48" | 13 ³ / ₁₆ " | 24" | DS4LC1DSL48L | 1,438. | 1,549. | 1,604. |
| | 54" | 13 ³ / ₁₆ " | 24" | DS4LC1DSL54L | 1,534. | 1,652. | 1,712. |
| | 60" | 13 ³ / ₁₆ " | 24" | DS4LC1DSL60L | 1,535. | 1,653. | 1,715. |
| | 66" | 13 ³ / ₁₆ " | 24" | DS4LC1DSL66L | 1,574. | 1,694. | 1,758. |
| | 72" | 13 ³ / ₁₆ " | 24" | DS4LC1DSL72L | 1,607. | 1,735. | 1,797. |

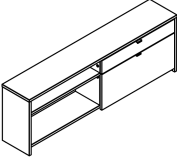
| | | | | | | | |
|--|-----|-----------------------------------|-----|---------------------|--------|--------|--------|
|  Credenza with Laminate Sliding Door and Drawer | 30" | 13 ³ / ₁₆ " | 24" | DS4LC1DLL30L | 1,832. | 1,982. | 2,054. |
| | 36" | 13 ³ / ₁₆ " | 24" | DS4LC1DLL36L | 1,832. | 1,982. | 2,054. |
| | 42" | 13 ³ / ₁₆ " | 24" | DS4LC1DLL42L | 1,832. | 1,982. | 2,054. |
| | 48" | 13 ³ / ₁₆ " | 24" | DS4LC1DLL48L | 1,880. | 2,031. | 2,107. |
| | 54" | 13 ³ / ₁₆ " | 24" | DS4LC1DLL54L | 1,926. | 2,082. | 2,162. |
| | 60" | 13 ³ / ₁₆ " | 24" | DS4LC1DLL60L | 1,974. | 2,134. | 2,215. |
| | 66" | 13 ³ / ₁₆ " | 24" | DS4LC1DLL66L | 2,021. | 2,185. | 2,269. |
| | 72" | 13 ³ / ₁₆ " | 24" | DS4LC1DLL72L | 2,066. | 2,238. | 2,321. |

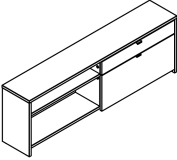
| | | | | | | | |
|---|-----|-----------------------------------|-----|---------------------|--------|--------|--------|
|  Credenza with Veneer Sliding Door and Drawer | 30" | 13 ³ / ₁₆ " | 24" | DS4LC1DVL30L | 1,926. | 2,082. | 2,163. |
| | 36" | 13 ³ / ₁₆ " | 24" | DS4LC1DVL36L | 1,926. | 2,082. | 2,163. |
| | 42" | 13 ³ / ₁₆ " | 24" | DS4LC1DVL42L | 1,926. | 2,082. | 2,163. |
| | 48" | 13 ³ / ₁₆ " | 24" | DS4LC1DVL48L | 1,983. | 2,142. | 2,224. |
| | 54" | 13 ³ / ₁₆ " | 24" | DS4LC1DVL54L | 2,035. | 2,202. | 2,285. |
| | 60" | 13 ³ / ₁₆ " | 24" | DS4LC1DVL60L | 2,089. | 2,262. | 2,348. |
| | 66" | 13 ³ / ₁₆ " | 24" | DS4LC1DVL66L | 2,142. | 2,319. | 2,412. |
| | 72" | 13 ³ / ₁₆ " | 24" | DS4LC1DVL72L | 2,198. | 2,381. | 2,471. |

Dimensions listed under w h d are actual to the nearest 1/16"

| Ordering Information | Order Code | Included with: | Options |
|--|--|--|---|
| Credenza with a Sliding Door and a Drawer: 1. Pattern number 2. Paint finish 3. Top finish 4. Top edge finish 5. Drawer/Door finish (laminated and veneer only) 6. Drawer/Door edge finish (laminated only) | Credenza with a Sliding Door and a Drawer: <i>Example:</i> DS4LC1DSL42L /117/118/117 DS4LC1D Pattern Number SL42L 117 Dark grey paint 118 Bright white top 117 Dark grey top edge | Credenza with a Sliding Door and a Drawer: Note: Credenzas are only available in Knoll core finishes. | Credenza with a Sliding Door and a Drawer: Lock/No lock option For non-locking credenzas with a sliding door or a drawer substitute the "L" suffix with an "N" and deduct \$40 from the list price. Note: Credenzas with a drawer have a full back. Credenzas without a drawer have a partial back that encloses the binder storage area below the shelf. Paint Configuration Option: Add "Y" at the end of the pattern number to specify a different paint finish on the case and fronts. P3 pricing applies on all product with dual paint finishes. |

Credenzas

Single Depth with Veneer Top

With or without a Sliding Door

Dividends Horizon

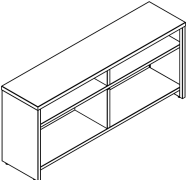
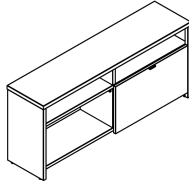
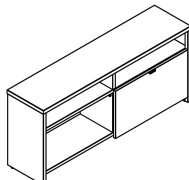
| description | w | h | d | pattern no. | P1 | P2 | P3 |
|--|-----|-----|-----------------------------------|---------------------|----------|----------|----------|
|  Credenza without Door | 24" | 24" | 13 ⁵ / ₁₆ " | DS4LC1ANV24N | \$1,409. | \$1,551. | \$1,621. |
| | 30" | 24" | 13 ⁵ / ₁₆ " | DS4LC1ANV30N | 1,409. | 1,551. | 1,621. |
| | 36" | 24" | 13 ⁵ / ₁₆ " | DS4LC1ANV36N | 1,409. | 1,551. | 1,621. |
| | 42" | 24" | 13 ⁵ / ₁₆ " | DS4LC1ANV42N | 1,409. | 1,551. | 1,621. |
| | 48" | 24" | 13 ⁵ / ₁₆ " | DS4LC1ANV48N | 1,442. | 1,588. | 1,661. |
| | 54" | 24" | 13 ⁵ / ₁₆ " | DS4LC1ANV54N | 1,478. | 1,626. | 1,699. |
| | 60" | 24" | 13 ⁵ / ₁₆ " | DS4LC1ANV60N | 1,512. | 1,663. | 1,738. |
| | 66" | 24" | 13 ⁵ / ₁₆ " | DS4LC1ANV66N | 1,545. | 1,699. | 1,778. |
| | 72" | 24" | 13 ⁵ / ₁₆ " | DS4LC1ANV72N | 1,580. | 1,737. | 1,816. |
|  Credenza with Steel Sliding Door | 30" | 24" | 13 ⁵ / ₁₆ " | DS4LC1BSV30L | 1,488. | 1,634. | 1,708. |
| | 36" | 24" | 13 ⁵ / ₁₆ " | DS4LC1BSV36L | 1,488. | 1,634. | 1,708. |
| | 42" | 24" | 13 ⁵ / ₁₆ " | DS4LC1BSV42L | 1,488. | 1,634. | 1,708. |
| | 48" | 24" | 13 ⁵ / ₁₆ " | DS4LC1BSV48L | 1,525. | 1,674. | 1,748. |
| | 54" | 24" | 13 ⁵ / ₁₆ " | DS4LC1BSV54L | 1,560. | 1,714. | 1,790. |
| | 60" | 24" | 13 ⁵ / ₁₆ " | DS4LC1BSV60L | 1,595. | 1,754. | 1,831. |
| | 66" | 24" | 13 ⁵ / ₁₆ " | DS4LC1BSV66L | 1,632. | 1,792. | 1,872. |
| | 72" | 24" | 13 ⁵ / ₁₆ " | DS4LC1BSV72L | 1,668. | 1,831. | 1,915. |
|  Credenza with Laminate Sliding Door | 30" | 24" | 13 ⁵ / ₁₆ " | DS4LC1BLV30L | 1,808. | 1,986. | 2,074. |
| | 36" | 24" | 13 ⁵ / ₁₆ " | DS4LC1BLV36L | 1,808. | 1,986. | 2,074. |
| | 42" | 24" | 13 ⁵ / ₁₆ " | DS4LC1BLV42L | 1,808. | 1,986. | 2,074. |
| | 48" | 24" | 13 ⁵ / ₁₆ " | DS4LC1BLV48L | 1,844. | 2,026. | 2,116. |
| | 54" | 24" | 13 ⁵ / ₁₆ " | DS4LC1BLV54L | 1,880. | 2,065. | 2,157. |
| | 60" | 24" | 13 ⁵ / ₁₆ " | DS4LC1BLV60L | 1,917. | 2,105. | 2,202. |
| | 66" | 24" | 13 ⁵ / ₁₆ " | DS4LC1BLV66L | 1,953. | 2,146. | 2,243. |
| | 72" | 24" | 13 ⁵ / ₁₆ " | DS4LC1BLV72L | 1,991. | 2,186. | 2,285. |

Dimensions listed under w h d are actual to the nearest 1/16"

| Ordering Information | Order Code | Included with: | Options |
|--|--|--|--|
| Credenza with Sliding Door: 1. Pattern number 2. Paint finish 3. Top finish 4. Door finish (laminare and veneer) 5. Door edge finish (laminare only) | Credenza with Sliding Door: <i>Example:</i> DS4LC1BSV42L /117/Y319 DS4LC1B Pattern Number SV42L 117 Dark grey paint Y319 Cherry Techwood top | Credenza with or without Sliding Door: Note: Credenzas are only available in Knoll core finishes. | Credenza with or without a Sliding Door: Lock/No lock option For non-locking credenzas with a sliding door or a drawer, substitute the "L" suffix with an "N" and deduct \$20 from the list price. Note: Credenzas with a drawer have a full back. Credenzas without a drawer have a partial back that encloses the binder storage area below the shelf. |
| Credenza without a Sliding Door: 1. Pattern number 2. Paint finish 3. Top finish | Credenza without a Sliding Door: <i>Example:</i> DS4LC1ANV42N /117/Y319 DS4LC1A Pattern Number NV42N 117 Dark grey paint Y319 Cherry Techwood top | | Paint Configuration Option: Add "Y" at the end of the pattern number to specify a different paint finish on the case and fronts. P3 pricing applies on all product with dual paint finishes. |

Credenzas
Single Depth with Veneer Top
With or without a Sliding Door

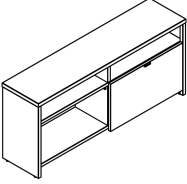
| description | w | h | d | pattern no. | P1 | P2 | P3 |
|---|-----|-----|-----------------------------------|---------------------|----------|----------|----------|
|  Credenza with Veneer Sliding Door | 30" | 24" | 13 ⁵ / ₁₆ " | DS4LC1BVV30L | \$1,901. | \$2,087. | \$2,183. |
| | 36" | 24" | 13 ⁵ / ₁₆ " | DS4LC1BVV36L | 1,901. | 2,087. | 2,183. |
| | 42" | 24" | 13 ⁵ / ₁₆ " | DS4LC1BVV42L | 1,901. | 2,087. | 2,183. |
| | 48" | 24" | 13 ⁵ / ₁₆ " | DS4LC1BVV48L | 1,945. | 2,137. | 2,234. |
| | 54" | 24" | 13 ⁵ / ₁₆ " | DS4LC1BVV54L | 1,990. | 2,185. | 2,284. |
| | 60" | 24" | 13 ⁵ / ₁₆ " | DS4LC1BVV60L | 2,033. | 2,234. | 2,333. |
| | 66" | 24" | 13 ⁵ / ₁₆ " | DS4LC1BVV66L | 2,076. | 2,282. | 2,385. |
| | 72" | 24" | 13 ⁵ / ₁₆ " | DS4LC1BVV72L | 2,122. | 2,329. | 2,435. |

Dimensions listed under w h d are actual to the nearest 1/16"

| Ordering Information | Order Code | Included with: | Options |
|--|--|--|--|
| Credenza with Sliding Door: 1. Pattern number 2. Paint finish 3. Top finish 4. Door finish (laminated and veneer) 5. Door edge finish (laminated only) | Credenza with Sliding Door: <i>Example:</i> DS4LC1BSV42L /117/Y319 <hr/> DS4LC1B Pattern Number SV42L <hr/> 117 Dark grey paint <hr/> Y319 Cherry Techwood top | Credenza with or without Sliding Door: Note: Credenzas are only available in Knoll core finishes. | Credenza with or without a Sliding Door: Lock/No lock option For non-locking credenzas with a sliding door or a drawer, substitute the "L" suffix with an "N" and deduct \$20 from the list price. Note: Credenzas with a drawer have a full back. Credenzas without a drawer have a partial back that encloses the binder storage area below the shelf. Paint Configuration Option: Add "Y" at the end of the pattern number to specify a different paint finish on the case and fronts. P3 pricing applies on all product with dual paint finishes. |
| Credenza without a Sliding Door: 1. Pattern number 2. Paint finish 3. Top finish | Credenza without a Sliding Door: <i>Example:</i> DS4LC1ANV42N /117/Y319 <hr/> DS4LC1A Pattern Number NV42N <hr/> 117 Dark grey paint <hr/> Y319 Cherry Techwood top | | |

Credenzas
Single Depth with Veneer Top
Without a Sliding Door and with a Drawer

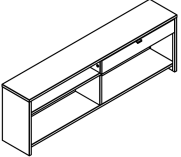
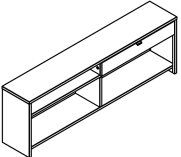
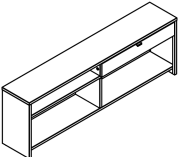
| description | w | h | d | pattern no. | P1 | P2 | P3 |
|---|-----|-----|----------|---------------------|----------|----------|----------|
|  Credenza with Steel Door | 30" | 24" | 13 5/16" | DS4LC1CSV30L | \$1,752. | \$1,892. | \$1,962. |
| | 36" | 24" | 13 5/16" | DS4LC1CSV36L | 1,752. | 1,892. | 1,962. |
| | 42" | 24" | 13 5/16" | DS4LC1CSV42L | 1,752. | 1,892. | 1,962. |
| | 48" | 24" | 13 5/16" | DS4LC1CSV48L | 1,785. | 1,928. | 2,001. |
| | 54" | 24" | 13 5/16" | DS4LC1CSV54L | 1,818. | 1,966. | 2,042. |
| | 60" | 24" | 13 5/16" | DS4LC1CSV60L | 1,853. | 2,003. | 2,079. |
| | 66" | 24" | 13 5/16" | DS4LC1CSV66L | 1,887. | 2,042. | 2,120. |
| | 72" | 24" | 13 5/16" | DS4LC1CSV72L | 1,920. | 2,077. | 2,156. |
|  Credenza with Laminate Door | 30" | 24" | 13 5/16" | DS4LC1CLV30L | 1,943. | 2,083. | 2,153. |
| | 36" | 24" | 13 5/16" | DS4LC1CLV36L | 1,943. | 2,083. | 2,153. |
| | 42" | 24" | 13 5/16" | DS4LC1CLV42L | 1,943. | 2,083. | 2,153. |
| | 48" | 24" | 13 5/16" | DS4LC1CLV48L | 1,975. | 2,121. | 2,192. |
| | 54" | 24" | 13 5/16" | DS4LC1CLV54L | 2,009. | 2,156. | 2,233. |
| | 60" | 24" | 13 5/16" | DS4LC1CLV60L | 2,045. | 2,194. | 2,270. |
| | 66" | 24" | 13 5/16" | DS4LC1CLV66L | 2,077. | 2,233. | 2,311. |
| | 72" | 24" | 13 5/16" | DS4LC1CLV72L | 2,110. | 2,269. | 2,348. |
|  Credenza with Veneer Door | 30" | 24" | 13 5/16" | DS4LC1CVV30L | 1,984. | 2,124. | 2,194. |
| | 36" | 24" | 13 5/16" | DS4LC1CVV36L | 1,984. | 2,124. | 2,194. |
| | 42" | 24" | 13 5/16" | DS4LC1CVV42L | 1,984. | 2,124. | 2,194. |
| | 48" | 24" | 13 5/16" | DS4LC1CVV48L | 2,016. | 2,163. | 2,234. |
| | 54" | 24" | 13 5/16" | DS4LC1CVV54L | 2,050. | 2,199. | 2,273. |
| | 60" | 24" | 13 5/16" | DS4LC1CVV60L | 2,085. | 2,236. | 2,311. |
| | 66" | 24" | 13 5/16" | DS4LC1CVV66L | 2,118. | 2,273. | 2,351. |
| | 72" | 24" | 13 5/16" | DS4LC1CVV72L | 2,152. | 2,310. | 2,390. |

Dimensions listed under w h d are actual to the nearest 1/16"

| Ordering Information | Order Code | Included with: | Options |
|---|--|---|---|
| Credenza with a Drawer: 1. Pattern number 2. Paint finish 3. Top finish 4. Door finish (laminated and veneer only) 5. Door edge finish (laminated only) | Credenza with a Drawer: <i>Example:</i> DS4LC1CSV42L /117/ Y319 <hr/> DS4LC1C Pattern Number SV42L <hr/> 117 Dark grey paint <hr/> Y319 Cherry Techwood top | Credenza with a Drawer: Note: Credenzas are only available in Knoll core finishes. | Credenza with a Drawer: Lock/No lock option For non-locking credenzas with a sliding door or a drawer, substitute the "L" suffix with an "N" and deduct \$20 from the list price. Note: Credenzas with a drawer have a full back. Credenzas without a drawer have a partial back that encloses the binder storage area below the shelf. Paint Configuration Option: Add "Y" at the end of the pattern number to specify a different paint finish on the case and fronts. P3 pricing applies on all product with dual paint finishes. |

Single Depth with Veneer Top
With a Sliding Door and with a Drawer

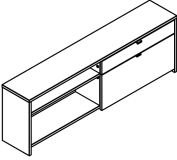
| description | w | h | d | pattern no. | P1 | P2 | P3 |
|--|-----|-----|-----------------------------------|---------------------|----------|----------|----------|
|  <p>Credenza with Steel Sliding Door and Drawer</p> | 30" | 24" | 13 ⁵ / ₁₆ " | DS4LC1DSV30L | \$1,828. | \$1,975. | \$2,048. |
| | 36" | 24" | 13 ⁵ / ₁₆ " | DS4LC1DSV36L | 1,828. | 1,975. | 2,048. |
| | 42" | 24" | 13 ⁵ / ₁₆ " | DS4LC1DSV42L | 1,828. | 1,975. | 2,048. |
| | 48" | 24" | 13 ⁵ / ₁₆ " | DS4LC1DSV48L | 1,865. | 2,014. | 2,089. |
| | 54" | 24" | 13 ⁵ / ₁₆ " | DS4LC1DSV54L | 1,901. | 2,054. | 2,131. |
| | 60" | 24" | 13 ⁵ / ₁₆ " | DS4LC1DSV60L | 1,938. | 2,095. | 2,174. |
| | 66" | 24" | 13 ⁵ / ₁₆ " | DS4LC1DSV66L | 1,973. | 2,133. | 2,214. |
| | 72" | 24" | 13 ⁵ / ₁₆ " | DS4LC1DSV72L | 2,009. | 2,174. | 2,256. |

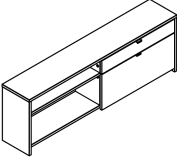
| | | | | | | | |
|---|-----|-----|-----------------------------------|---------------------|--------|--------|--------|
|  <p>Credenza with Laminate Sliding Door and Drawer</p> | 30" | 24" | 13 ⁵ / ₁₆ " | DS4LC1DLV30L | 2,147. | 2,325. | 2,416. |
| | 36" | 24" | 13 ⁵ / ₁₆ " | DS4LC1DLV36L | 2,147. | 2,325. | 2,416. |
| | 42" | 24" | 13 ⁵ / ₁₆ " | DS4LC1DLV42L | 2,147. | 2,325. | 2,416. |
| | 48" | 24" | 13 ⁵ / ₁₆ " | DS4LC1DLV48L | 2,184. | 2,365. | 2,458. |
| | 54" | 24" | 13 ⁵ / ₁₆ " | DS4LC1DLV54L | 2,221. | 2,407. | 2,499. |
| | 60" | 24" | 13 ⁵ / ₁₆ " | DS4LC1DLV60L | 2,258. | 2,448. | 2,542. |
| | 66" | 24" | 13 ⁵ / ₁₆ " | DS4LC1DLV66L | 2,292. | 2,489. | 2,583. |
| | 72" | 24" | 13 ⁵ / ₁₆ " | DS4LC1DLV72L | 2,330. | 2,528. | 2,627. |

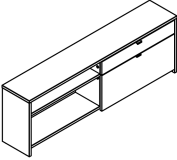
| | | | | | | | |
|--|-----|-----|-----------------------------------|---------------------|--------|--------|--------|
|  <p>Credenza with Veneer Sliding Door and Drawer</p> | 30" | 24" | 13 ⁵ / ₁₆ " | DS4LC1DVV30L | 2,242. | 2,428. | 2,525. |
| | 36" | 24" | 13 ⁵ / ₁₆ " | DS4LC1DVV36L | 2,242. | 2,428. | 2,525. |
| | 42" | 24" | 13 ⁵ / ₁₆ " | DS4LC1DVV42L | 2,242. | 2,428. | 2,525. |
| | 48" | 24" | 13 ⁵ / ₁₆ " | DS4LC1DVV48L | 2,285. | 2,478. | 2,574. |
| | 54" | 24" | 13 ⁵ / ₁₆ " | DS4LC1DVV54L | 2,329. | 2,527. | 2,626. |
| | 60" | 24" | 13 ⁵ / ₁₆ " | DS4LC1DVV60L | 2,373. | 2,574. | 2,676. |
| | 66" | 24" | 13 ⁵ / ₁₆ " | DS4LC1DVV66L | 2,418. | 2,623. | 2,726. |
| | 72" | 24" | 13 ⁵ / ₁₆ " | DS4LC1DVV72L | 2,463. | 2,672. | 2,775. |

Dimensions listed under w h d are actual to the nearest 1/16"

| Ordering Information | Order Code | Included with: | Options |
|--|---|---|---|
| <p>Credenza with a Sliding Door and a Drawer:</p> <ol style="list-style-type: none"> 1. Pattern number 2. Paint finish 3. Top finish 4. Drawer/Door finish (laminated and veneer only) 5. Drawer/Door edge finish (laminated only) | <p>Credenza with a Sliding Door and a Drawer:</p> <p><i>Example:</i> DS4LC1SV42L /117/Y319</p> <hr/> <p>DS4LC1 Pattern Number</p> <hr/> <p>SV42L</p> <hr/> <p>117 Dark grey paint</p> <hr/> <p>Y319 Cherry Techwood top</p> | <p>Credenza with a Sliding Door and a Drawer:</p> <p>Note: Credenzas are only available in Knoll core finishes.</p> | <p>Credenza with a Sliding Door and a Drawer:</p> <p>Lock/No lock option For non-locking credenzas with a sliding door or a drawer, substitute the "L" suffix with an "N" and deduct \$40 from the list price.</p> <p>Note: Credenzas with a drawer have a full back. Credenzas without a drawer have a partial back that encloses the binder storage area below the shelf.</p> <p>Paint Configuration Option: Add "Y" at the end of the pattern number to specify a different paint finish on the case and fronts. P3 pricing applies on all product with dual paint finishes.</p> |

Credenzas

Double Depth - Specifications

Double Depth Credenzas

Dividends Horizon double depth credenzas are designed for use in various applications, including personal storage in shared workstations, space division in the open plan, and impromptu collaboration areas. Double depth credenzas offer a more unified aesthetic option, with the seamless top and end panels, when back-to-back credenzas are required.

Double depth credenzas consist of a seamless laminate or veneer top option with a shelf and binder storage area. Credenzas have four configuration options: sliding door only, drawer only, sliding door and drawer combination, and open shelves without a sliding door or a drawer. Double depth credenzas have the same configuration on both sides.

The sliding door is a single steel, laminate, or veneer door with a handle that conceals half the width of the binder storage area. A single drawer may be specified for the location above the shelf. The drawer may be installed in either the right or left location, the drawer location does not need to be specified when ordered. When a drawer is specified along with a sliding door, the drawer front and sliding door finishes are the same. A single full back panel divides the front and back sections of the credenza.

24 inch wide credenzas do not include a center vertical septum and are only available as open shelf units, without a sliding door or drawer. Units are shipped knocked down and may be specified with or without locks. Dividends Horizon credenzas are available in all Knoll Core finishes. Legacy finishes are not available.

Available Sizes

Heights: 24 inches
Depth: 26-5/8 inches
Widths: 24 – 72 inches

Construction

• Top:

- Laminate: 1-1/4 inch thick particle board with high pressure laminate on top and a paper backer on the underside with 2mm edgeband
- Veneer: 1-1/4 inch thick particle board with 0.6mm veneer on top and edge.

• End Panels: 16-gauge painted steel

• Back Panel: 20-gauge painted steel

• Door:

- Steel: 20-gauge panted steel
- Laminate: 3/4 inch thick particle board with high pressure laminate on the outside and a paper backer on the inside with 1mm edgeband
- Veneer 3/4 inch thick particle board with 0.6mm thick veneer on top and edge

• Fixed Shelf: 16-gauge painted steel

• Door Handle: painted aluminum (same color as case)

Interior Dimensions

Heights: 12-1/2 inches for the lower section, 5-7/8 inches for the upper section
Depth: 12-1/16 inches

Locks

Locks are standard on credenzas with doors and/or drawers and are keyed randomly unless otherwise specified. All locks are factory installed and have a black finish. Credenzas can also be specified without locks if required.

Double Depth Credenza with Open Shelves

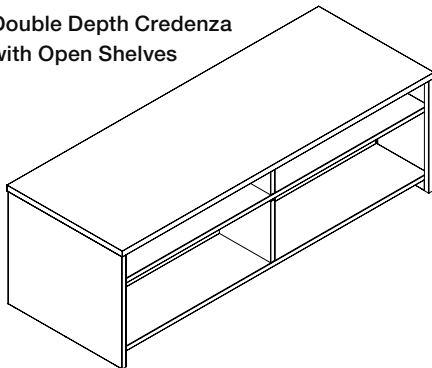

Double Depth Credenza with a Drawer

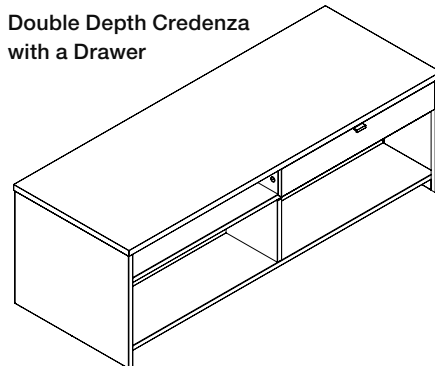

Double Depth Credenza with a Sliding Door

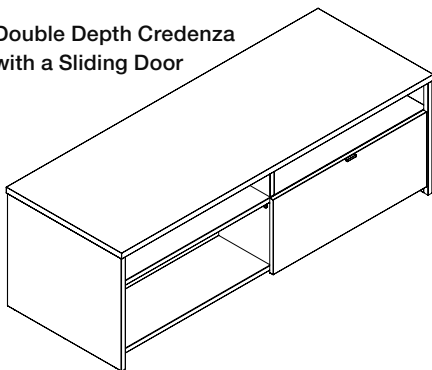

Double Depth Credenza with a Drawer and a Sliding Door

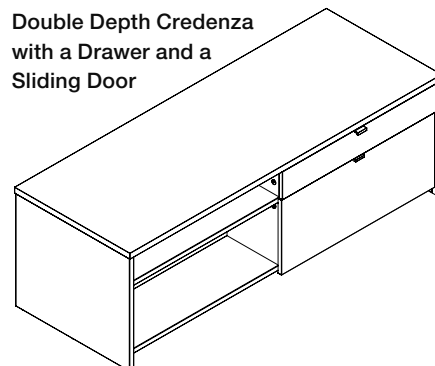

Credenzas

Double Depth with Laminate Top

With or without a Sliding Door

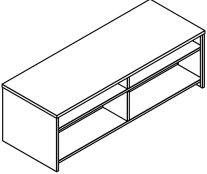
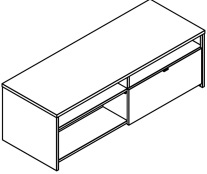
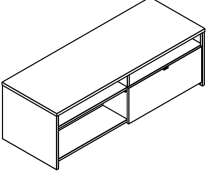
| description | w | h | d | pattern no. | P1 | P2 | P3 |
|--|-----|-----|----------------------------------|---------------------|----------|----------|----------|
|  Credenza without Door | 24" | 24" | 26 ⁵ / ₈ " | DS4LC2ANL24N | \$1,844. | \$2,024. | \$2,118. |
| | 30" | 24" | 26 ⁵ / ₈ " | DS4LC2ANL30N | 1,844. | 2,024. | 2,118. |
| | 36" | 24" | 26 ⁵ / ₈ " | DS4LC2ANL36N | 1,844. | 2,024. | 2,118. |
| | 42" | 24" | 26 ⁵ / ₈ " | DS4LC2ANL42N | 1,844. | 2,024. | 2,118. |
| | 48" | 24" | 26 ⁵ / ₈ " | DS4LC2ANL48N | 1,893. | 2,082. | 2,178. |
| | 54" | 24" | 26 ⁵ / ₈ " | DS4LC2ANL54N | 2,042. | 2,245. | 2,350. |
| | 60" | 24" | 26 ⁵ / ₈ " | DS4LC2ANL60N | 2,044. | 2,247. | 2,352. |
| | 66" | 24" | 26 ⁵ / ₈ " | DS4LC2ANL66N | 2,113. | 2,324. | 2,429. |
| | 72" | 24" | 26 ⁵ / ₈ " | DS4LC2ANL72N | 2,184. | 2,404. | 2,508. |
|  Credenza with Steel Sliding Door | 30" | 24" | 26 ⁵ / ₈ " | DS4LC2BSL30L | 2,140. | 2,357. | 2,464. |
| | 36" | 24" | 26 ⁵ / ₈ " | DS4LC2BSL36L | 2,140. | 2,357. | 2,464. |
| | 42" | 24" | 26 ⁵ / ₈ " | DS4LC2BSL42L | 2,140. | 2,357. | 2,464. |
| | 48" | 24" | 26 ⁵ / ₈ " | DS4LC2BSL48L | 2,196. | 2,417. | 2,526. |
| | 54" | 24" | 26 ⁵ / ₈ " | DS4LC2BSL54L | 2,384. | 2,623. | 2,738. |
| | 60" | 24" | 26 ⁵ / ₈ " | DS4LC2BSL60L | 2,388. | 2,626. | 2,746. |
| | 66" | 24" | 26 ⁵ / ₈ " | DS4LC2BSL66L | 2,464. | 2,710. | 2,831. |
| | 72" | 24" | 26 ⁵ / ₈ " | DS4LC2BSL72L | 2,532. | 2,786. | 2,912. |
|  Credenza with Laminate Sliding Door | 30" | 24" | 26 ⁵ / ₈ " | DS4LC2BLL30L | 2,985. | 3,279. | 3,425. |
| | 36" | 24" | 26 ⁵ / ₈ " | DS4LC2BLL36L | 2,985. | 3,279. | 3,425. |
| | 42" | 24" | 26 ⁵ / ₈ " | DS4LC2BLL42L | 2,985. | 3,279. | 3,425. |
| | 48" | 24" | 26 ⁵ / ₈ " | DS4LC2BLL48L | 3,080. | 3,380. | 3,535. |
| | 54" | 24" | 26 ⁵ / ₈ " | DS4LC2BLL54L | 3,173. | 3,483. | 3,639. |
| | 60" | 24" | 26 ⁵ / ₈ " | DS4LC2BLL60L | 3,266. | 3,587. | 3,747. |
| | 66" | 24" | 26 ⁵ / ₈ " | DS4LC2BLL66L | 3,359. | 3,688. | 3,855. |
| | 72" | 24" | 26 ⁵ / ₈ " | DS4LC2BLL72L | 3,453. | 3,793. | 3,961. |

Dimensions listed under w h d are actual to the nearest 1/16"

| Ordering Information | Order Code | Included with: | Options |
|---|---|---|--|
| Credenza with a Sliding Door: 1. Pattern number 2. Paint finish 3. Top finish 4. Top edge finish 5. Door finish (laminite and veneer only) 6. Door edge finish (laminite only) | Credenza with a Sliding Door: Example: DS4LC2BSL42L /117/118/117 <hr/> DS4LC2B Pattern Number LL42L <hr/> 117 Dark grey paint <hr/> 118 Bright white top <hr/> 117 Dark grey top edge | Credenza with a Sliding Door: Note: Credenzas are only available in Knoll core finishes. | Credenza with a Sliding Door: Lock/No lock option For non-locking credenzas with a sliding door or a drawer, substitute the "L" suffix with a "N" and deduct \$40 from the list price. Paint Configuration Option: Add "Y" at the end of the pattern number to specify a different paint finish on the case and fronts. P3 pricing applies on all product with dual paint finishes. |
| Credenza without a Sliding Door: 1. Pattern number 2. Paint finish 3. Top finish 4. Top edge finish | Credenza without a Sliding Door: Example: DS4LC2ANL42N /117/118/117 <hr/> DS4LC2A Pattern Number NL42N <hr/> 117 Dark grey paint <hr/> 118 Bright white top <hr/> 117 Dark grey top edge | | |

Credenzas
Double Depth with Laminate Top
With or without a Sliding Door

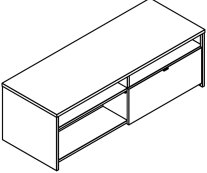
| description | w | h | d | pattern no. | P1 | P2 | P3 |
|---|-----|-----|----------------------------------|---------------------|----------|----------|----------|
|  Credenza with Veneer Sliding Door | 30" | 24" | 26 ⁵ / ₈ " | DS4LC2BVL30L | \$3,173. | \$3,483. | \$3,641. |
| | 36" | 24" | 26 ⁵ / ₈ " | DS4LC2BVL36L | 3,173. | 3,483. | 3,641. |
| | 42" | 24" | 26 ⁵ / ₈ " | DS4LC2BVL42L | 3,173. | 3,483. | 3,641. |
| | 48" | 24" | 26 ⁵ / ₈ " | DS4LC2BVL48L | 3,281. | 3,605. | 3,766. |
| | 54" | 24" | 26 ⁵ / ₈ " | DS4LC2BVL54L | 3,389. | 3,720. | 3,890. |
| | 60" | 24" | 26 ⁵ / ₈ " | DS4LC2BVL60L | 3,495. | 3,842. | 4,013. |
| | 66" | 24" | 26 ⁵ / ₈ " | DS4LC2BVL66L | 3,605. | 3,957. | 4,139. |
| | 72" | 24" | 26 ⁵ / ₈ " | DS4LC2BVL72L | 3,712. | 4,080. | 4,262. |

Dimensions listed under w h d are actual to the nearest 1/16"

| Ordering Information | Order Code | Included with: | Options |
|---|--|---|--|
| Credenza with a Sliding Door: 1. Pattern number 2. Paint finish 3. Top finish 4. Top edge finish 5. Door finish (laminated and veneer only) 6. Door edge finish (laminated only) | Credenza with a Sliding Door: <i>Example:</i> DS4LC2BSL42L /117/118/117 <hr/> DS4LC2B Pattern Number LL42L <hr/> 117 Dark grey paint <hr/> 118 Bright white top <hr/> 117 Dark grey top edge | Credenza with a Sliding Door: Note: Credenzas are only available in Knoll core finishes. | Credenza with a Sliding Door: Lock/No lock option For non-locking credenzas with a sliding door or a drawer, substitute the "L" suffix with a "N" and deduct \$40 from the list price. Paint Configuration Option: Add "Y" at the end of the pattern number to specify a different paint finish on the case and fronts. P3 pricing applies on all product with dual paint finishes. |
| Credenza without a Sliding Door: 1. Pattern number 2. Paint finish 3. Top finish 4. Top edge finish | Credenza without a Sliding Door: <i>Example:</i> DS4LC2ANL42N /117/118/117 <hr/> DS4LC2A Pattern Number NL42N <hr/> 117 Dark grey paint <hr/> 118 Bright white top <hr/> 117 Dark grey top edge | | |

*Double Depth with Laminate Top
Without a Sliding Door and with a Drawer*

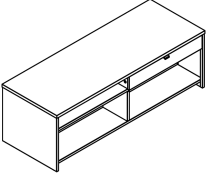
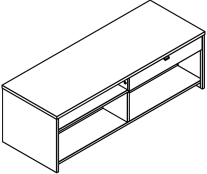
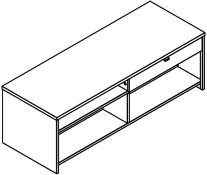
| description | w | h | d | pattern no. | P1 | P2 | P3 |
|--|-----|-----|----------------------------------|---------------------|----------|----------|----------|
|  <p>Credenza with Steel Drawer</p> | 30" | 24" | 26 ⁵ / ₈ " | DS4LC2CSL30L | \$2,526. | \$2,706. | \$2,800. |
| | 36" | 24" | 26 ⁵ / ₈ " | DS4LC2CSL36L | 2,526. | 2,706. | 2,800. |
| | 42" | 24" | 26 ⁵ / ₈ " | DS4LC2CSL42L | 2,526. | 2,706. | 2,800. |
| | 48" | 24" | 26 ⁵ / ₈ " | DS4LC2CSL48L | 2,575. | 2,763. | 2,860. |
| | 54" | 24" | 26 ⁵ / ₈ " | DS4LC2CSL54L | 2,723. | 2,928. | 3,032. |
| | 60" | 24" | 26 ⁵ / ₈ " | DS4LC2CSL60L | 2,725. | 2,930. | 3,035. |
| | 66" | 24" | 26 ⁵ / ₈ " | DS4LC2CSL66L | 2,796. | 3,007. | 3,112. |
| | 72" | 24" | 26 ⁵ / ₈ " | DS4LC2CSL72L | 2,866. | 3,087. | 3,191. |
|  <p>Credenza with Laminate Drawer</p> | 30" | 24" | 26 ⁵ / ₈ " | DS4LC2CLL30L | 2,907. | 3,087. | 3,182. |
| | 36" | 24" | 26 ⁵ / ₈ " | DS4LC2CLL36L | 2,907. | 3,087. | 3,182. |
| | 42" | 24" | 26 ⁵ / ₈ " | DS4LC2CLL42L | 2,907. | 3,087. | 3,182. |
| | 48" | 24" | 26 ⁵ / ₈ " | DS4LC2CLL48L | 2,957. | 3,146. | 3,241. |
| | 54" | 24" | 26 ⁵ / ₈ " | DS4LC2CLL54L | 3,104. | 3,310. | 3,414. |
| | 60" | 24" | 26 ⁵ / ₈ " | DS4LC2CLL60L | 3,106. | 3,312. | 3,416. |
| | 66" | 24" | 26 ⁵ / ₈ " | DS4LC2CLL66L | 3,177. | 3,389. | 3,493. |
| | 72" | 24" | 26 ⁵ / ₈ " | DS4LC2CLL72L | 3,247. | 3,467. | 3,573. |
|  <p>Credenza with Veneer Drawer</p> | 30" | 24" | 26 ⁵ / ₈ " | DS4LC2CVL30L | 2,989. | 3,169. | 3,264. |
| | 36" | 24" | 26 ⁵ / ₈ " | DS4LC2CVL36L | 2,989. | 3,169. | 3,264. |
| | 42" | 24" | 26 ⁵ / ₈ " | DS4LC2CVL42L | 2,989. | 3,169. | 3,264. |
| | 48" | 24" | 26 ⁵ / ₈ " | DS4LC2CVL48L | 3,039. | 3,227. | 3,323. |
| | 54" | 24" | 26 ⁵ / ₈ " | DS4LC2CVL54L | 3,187. | 3,391. | 3,495. |
| | 60" | 24" | 26 ⁵ / ₈ " | DS4LC2CVL60L | 3,189. | 3,394. | 3,498. |
| | 66" | 24" | 26 ⁵ / ₈ " | DS4LC2CVL66L | 3,259. | 3,469. | 3,576. |
| | 72" | 24" | 26 ⁵ / ₈ " | DS4LC2CVL72L | 3,330. | 3,551. | 3,654. |

Dimensions listed under w h d are actual to the nearest 1/16"

| Ordering Information | Order Code | Included with: | Options |
|---|---|--|---|
| <p>Credenza with a Drawer:</p> <ol style="list-style-type: none"> 1. Pattern number 2. Paint finish 3. Top finish 4. Top edge finish 5. Drawer finish (laminated and veneer only) 6. Drawer edge finish (laminated only) | <p>Credenza with a Drawer:</p> <p><i>Example:</i> DS4LC2CSL42L /117/118/117</p> <hr/> <p>DS4LC2C Pattern Number</p> <hr/> <p>SL42L</p> <hr/> <p>117 Dark grey paint</p> <hr/> <p>118 Bright white top</p> <hr/> <p>117 Dark grey top edge</p> | <p>Credenza with a Drawer:</p> <p>Note: Credenzas are only available in Knoll core finishes.</p> | <p>Credenza with a Drawer:</p> <p>Lock/No lock option For non-locking credenzas with a sliding door or a drawer, substitute the "L" suffix with a "N" and deduct \$40 from the list price.</p> <p>Paint Configuration Option: Add "Y" at the end of the pattern number to specify a different paint finish on the case and fronts. P3 pricing applies on all product with dual paint finishes.</p> |

*Double Depth with Laminate Top
With a Sliding Door and with a Drawer*

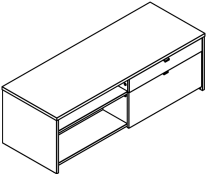
| description | w | h | d | pattern no. | P1 | P2 | P3 |
|---|-----|-----|----------------------------------|---------------------|----------|----------|----------|
|  | 30" | 24" | 26 ⁵ / ₈ " | DS4LC2DSL30L | \$2,823. | \$3,039. | \$3,146. |
| | 36" | 24" | 26 ⁵ / ₈ " | DS4LC2DSL36L | 2,823. | 3,039. | 3,146. |
| | 42" | 24" | 26 ⁵ / ₈ " | DS4LC2DSL42L | 2,823. | 3,039. | 3,146. |
| | 48" | 24" | 26 ⁵ / ₈ " | DS4LC2DSL48L | 2,878. | 3,098. | 3,207. |
| | 54" | 24" | 26 ⁵ / ₈ " | DS4LC2DSL54L | 3,065. | 3,306. | 3,421. |
| | 60" | 24" | 26 ⁵ / ₈ " | DS4LC2DSL60L | 3,069. | 3,308. | 3,427. |
| | 66" | 24" | 26 ⁵ / ₈ " | DS4LC2DSL66L | 3,146. | 3,391. | 3,513. |
| | 72" | 24" | 26 ⁵ / ₈ " | DS4LC2DSL72L | 3,214. | 3,467. | 3,594. |

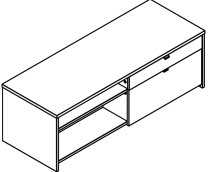
| | | | | | | | |
|---|-----|-----|----------------------------------|---------------------|--------|--------|--------|
|  | 30" | 24" | 26 ⁵ / ₈ " | DS4LC2DLL30L | 3,667. | 3,961. | 4,107. |
| | 36" | 24" | 26 ⁵ / ₈ " | DS4LC2DLL36L | 3,667. | 3,961. | 4,107. |
| | 42" | 24" | 26 ⁵ / ₈ " | DS4LC2DLL42L | 3,667. | 3,961. | 4,107. |
| | 48" | 24" | 26 ⁵ / ₈ " | DS4LC2DLL48L | 3,762. | 4,061. | 4,217. |
| | 54" | 24" | 26 ⁵ / ₈ " | DS4LC2DLL54L | 3,855. | 4,164. | 4,320. |
| | 60" | 24" | 26 ⁵ / ₈ " | DS4LC2DLL60L | 3,948. | 4,269. | 4,428. |
| | 66" | 24" | 26 ⁵ / ₈ " | DS4LC2DLL66L | 4,041. | 4,370. | 4,536. |
| | 72" | 24" | 26 ⁵ / ₈ " | DS4LC2DLL72L | 4,134. | 4,475. | 4,643. |

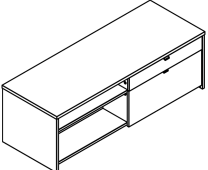
| | | | | | | | |
|--|-----|-----|----------------------------------|---------------------|--------|--------|--------|
|  | 30" | 24" | 26 ⁵ / ₈ " | DS4LC2DVL30L | 3,855. | 4,164. | 4,323. |
| | 36" | 24" | 26 ⁵ / ₈ " | DS4LC2DVL36L | 3,855. | 4,164. | 4,323. |
| | 42" | 24" | 26 ⁵ / ₈ " | DS4LC2DVL42L | 3,855. | 4,164. | 4,323. |
| | 48" | 24" | 26 ⁵ / ₈ " | DS4LC2DVL48L | 3,963. | 4,287. | 4,449. |
| | 54" | 24" | 26 ⁵ / ₈ " | DS4LC2DVL54L | 4,072. | 4,402. | 4,571. |
| | 60" | 24" | 26 ⁵ / ₈ " | DS4LC2DVL60L | 4,178. | 4,524. | 4,697. |
| | 66" | 24" | 26 ⁵ / ₈ " | DS4LC2DVL66L | 4,287. | 4,638. | 4,820. |
| | 72" | 24" | 26 ⁵ / ₈ " | DS4LC2DVL72L | 4,393. | 4,761. | 4,943. |

Dimensions listed under w h d are actual to the nearest 1/16"

| Ordering Information | Order Code | Included with: | Options |
|--|--|--|---|
| Credenza with a Sliding Door and a Drawer: 1. Pattern number 2. Paint finish 3. Top finish 4. Top edge finish 5. Drawer/Door finish (laminated and veneer only) 6. Drawer/Door edge finish (laminated only) | Credenza with a Sliding Door and a Drawer: <i>Example:</i> DS4LC2DSL42L /117/118/117 DS4LC2D Pattern Number SL42L 117 Dark grey paint 118 Bright white top 117 Dark grey top edge | Credenza with a Sliding Door and a Drawer: Note: Credenzas are only available in Knoll core finishes. | Credenza with a Sliding Door and a Drawer: Lock/No lock option For non-locking credenzas with a sliding door or a drawer, substitute the "L" suffix with a "N" and deduct \$80 from the list price. Paint Configuration Option: Add "Y" at the end of the pattern number to specify a different paint finish on the case and fronts. P3 pricing applies on all product with dual paint finishes. |

Credenzas

Double Depth with Veneer Top

With or without a Sliding Door

Dividends Horizon

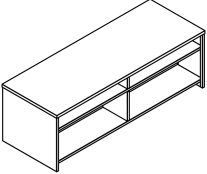
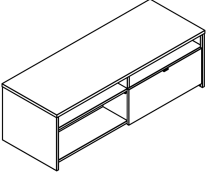
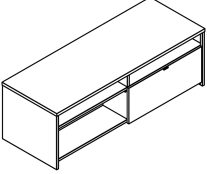
| description | w | h | d | pattern no. | P1 | P2 | P3 |
|--|-----|-----|-----------------------------------|---------------------|----------|----------|----------|
|  Credenza without Door | 24" | 24" | 26 ³ / ₈ " | DS4LC2ANV24N | \$2,820. | \$3,102. | \$3,243. |
| | 30" | 24" | 26 ³ / ₈ " | DS4LC2ANV30N | 2,820. | 3,102. | 3,243. |
| | 36" | 24" | 26 ³ / ₈ " | DS4LC2ANV36N | 2,820. | 3,102. | 3,243. |
| | 42" | 24" | 26 ³ / ₈ " | DS4LC2ANV42N | 2,820. | 3,102. | 3,243. |
| | 48" | 24" | 26 ³ / ₈ " | DS4LC2ANV48N | 2,888. | 3,177. | 3,321. |
| | 54" | 24" | 26 ³ / ₈ " | DS4LC2ANV54N | 2,955. | 3,250. | 3,400. |
| | 60" | 24" | 26 ³ / ₈ " | DS4LC2ANV60N | 3,025. | 3,325. | 3,474. |
| | 66" | 24" | 26 ³ / ₈ " | DS4LC2ANV66N | 3,092. | 3,400. | 3,558. |
| | 72" | 24" | 26 ³ / ₈ " | DS4LC2ANV72N | 3,161. | 3,472. | 3,633. |
|  Credenza with Steel Sliding Door | 30" | 24" | 26 ³ / ₈ " | DS4LC2BSV30L | 2,974. | 3,269. | 3,414. |
| | 36" | 24" | 26 ³ / ₈ " | DS4LC2BSV36L | 2,974. | 3,269. | 3,414. |
| | 42" | 24" | 26 ³ / ₈ " | DS4LC2BSV42L | 2,974. | 3,269. | 3,414. |
| | 48" | 24" | 26 ³ / ₈ " | DS4LC2BSV48L | 3,047. | 3,349. | 3,495. |
| | 54" | 24" | 26 ³ / ₈ " | DS4LC2BSV54L | 3,121. | 3,425. | 3,580. |
| | 60" | 24" | 26 ³ / ₈ " | DS4LC2BSV60L | 3,191. | 3,506. | 3,665. |
| | 66" | 24" | 26 ³ / ₈ " | DS4LC2BSV66L | 3,264. | 3,584. | 3,745. |
| | 72" | 24" | 26 ³ / ₈ " | DS4LC2BSV72L | 3,336. | 3,665. | 3,829. |
|  Credenza with Laminate Sliding Door | 30" | 24" | 26 ³ / ₈ " | DS4LC2BLV30L | 3,614. | 3,970. | 4,148. |
| | 36" | 24" | 26 ³ / ₈ " | DS4LC2BLV36L | 3,614. | 3,970. | 4,148. |
| | 42" | 24" | 26 ³ / ₈ " | DS4LC2BLV42L | 3,614. | 3,970. | 4,148. |
| | 48" | 24" | 26 ³ / ₈ " | DS4LC2BLV48L | 3,686. | 4,050. | 4,233. |
| | 54" | 24" | 26 ³ / ₈ " | DS4LC2BLV54L | 3,762. | 4,132. | 4,316. |
| | 60" | 24" | 26 ³ / ₈ " | DS4LC2BLV60L | 3,833. | 4,213. | 4,402. |
| | 66" | 24" | 26 ³ / ₈ " | DS4LC2BLV66L | 3,904. | 4,293. | 4,488. |
| | 72" | 24" | 26 ³ / ₁₆ " | DS4LC2BLV72L | 3,980. | 4,372. | 4,571. |

Dimensions listed under w h d are actual to the nearest 1/16"

| Ordering Information | Order Code | Included with: | Options |
|--|--|--|---|
| Credenza with a Sliding Door: 1. Pattern number 2. Paint finish 3. Top finish 4. Door finish (laminate and veneer) 5. Door edge finish (laminate only) | Credenza with a Sliding Door: <i>Example:</i> DS4LC2BSV42L /117/Y319 <hr/> DS4LC2B Pattern Number SV42L <hr/> 117 Dark grey paint <hr/> Y319 Cherry Techwood top | Credenza with or without Sliding Door: Note: Credenzas are only available in Knoll core finishes. | Credenza with or without a Sliding Drawer: Lock/No lock option For non-locking credenzas with a sliding door or a drawer, substitute the "L" suffix with a "N" and deduct \$40 from the list price. Paint Configuration Option: Add "Y" at the end of the pattern number to specify a different paint finish on the case and fronts. P3 pricing applies on all product with dual paint finishes. |
| Credenza without a Sliding Door: 1. Pattern number 2. Paint finish 3. Top finish | Credenza without a Sliding Door: <i>Example:</i> DS4LC2ASV42L /117/Y319 <hr/> DS4LC2A Pattern Number SV42L <hr/> 117 Dark grey paint <hr/> Y319 Cherry Techwood top | | |

Credenzas
Double Depth with Veneer Top
With or without a Sliding Door

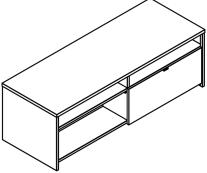
| description | w | h | d | pattern no. | P1 | P2 | P3 |
|---|-----|-----|---------|---------------------|----------|----------|----------|
|  | 30" | 24" | 26 5/8" | DS4LC2BVV30L | \$3,803. | \$4,176. | \$4,366. |
| | 36" | 24" | 26 5/8" | DS4LC2BVV36L | 3,803. | 4,176. | 4,366. |
| | 42" | 24" | 26 5/8" | DS4LC2BVV42L | 3,803. | 4,176. | 4,366. |
| | 48" | 24" | 26 5/8" | DS4LC2BVV48L | 3,890. | 4,275. | 4,466. |
| | 54" | 24" | 26 5/8" | DS4LC2BVV54L | 3,978. | 4,370. | 4,569. |
| | 60" | 24" | 26 5/8" | DS4LC2BVV60L | 4,066. | 4,466. | 4,670. |
| | 66" | 24" | 26 5/8" | DS4LC2BVV66L | 4,152. | 4,564. | 4,772. |
| | 72" | 24" | 26 5/8" | DS4LC2BVV72L | 4,243. | 4,661. | 4,867. |

Dimensions listed under w h d are actual to the nearest 1/16"

| Ordering Information | Order Code | Included with: | Options |
|--|--|--|---|
| Credenza with a Sliding Door: 1. Pattern number 2. Paint finish 3. Top finish 4. Door finish (laminate and veneer) 5. Door edge finish (laminate only) | Credenza with a Sliding Door: <i>Example:</i> DS4LC2BSV42L /117/Y319 <hr/> DS4LC2B Pattern Number SV42L <hr/> 117 Dark grey paint <hr/> Y319 Cherry Techwood top | Credenza with or without Sliding Door: Note: Credenzas are only available in Knoll core finishes. | Credenza with or without a Sliding Drawer: Lock/No lock option For non-locking credenzas with a sliding door or a drawer, substitute the "L" suffix with a "N" and deduct \$40 from the list price. Paint Configuration Option: Add "Y" at the end of the pattern number to specify a different paint finish on the case and fronts. P3 pricing applies on all product with dual paint finishes. |
| Credenza without a Sliding Door: 1. Pattern number 2. Paint finish 3. Top finish | Credenza without a Sliding Door: <i>Example:</i> DS4LC2ASV42L /117/Y319 <hr/> DS4LC2A Pattern Number SV42L <hr/> 117 Dark grey paint <hr/> Y319 Cherry Techwood top | | |

*Double Depth with Veneer Top
Without a Sliding Door and with a Drawer*

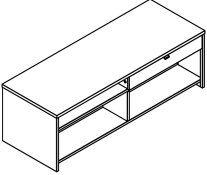
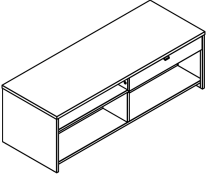
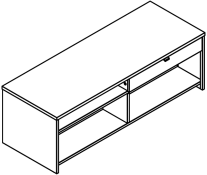
| description | w | h | d | pattern no. | P1 | P2 | P3 |
|--|-----|-----|---------|---------------------|----------|----------|----------|
|  <p>Credenza with Steel Drawer</p> | 30" | 24" | 26 5/8" | DS4LC2CSV30L | \$3,502. | \$3,785. | \$3,925. |
| | 36" | 24" | 26 5/8" | DS4LC2CSV36L | 3,502. | 3,785. | 3,925. |
| | 42" | 24" | 26 5/8" | DS4LC2CSV42L | 3,502. | 3,785. | 3,925. |
| | 48" | 24" | 26 5/8" | DS4LC2CSV48L | 3,569. | 3,859. | 4,003. |
| | 54" | 24" | 26 5/8" | DS4LC2CSV54L | 3,637. | 3,932. | 4,082. |
| | 60" | 24" | 26 5/8" | DS4LC2CSV60L | 3,708. | 4,007. | 4,156. |
| | 66" | 24" | 26 5/8" | DS4LC2CSV66L | 3,774. | 4,082. | 4,239. |
| | 72" | 24" | 26 5/8" | DS4LC2CSV72L | 3,842. | 4,154. | 4,314. |
|  <p>Credenza with Laminate Drawer</p> | 30" | 24" | 26 5/8" | DS4LC2CLV30L | 3,884. | 4,166. | 4,308. |
| | 36" | 24" | 26 5/8" | DS4LC2CLV36L | 3,884. | 4,166. | 4,308. |
| | 42" | 24" | 26 5/8" | DS4LC2CLV42L | 3,884. | 4,166. | 4,308. |
| | 48" | 24" | 26 5/8" | DS4LC2CLV48L | 3,950. | 4,241. | 4,384. |
| | 54" | 24" | 26 5/8" | DS4LC2CLV54L | 4,019. | 4,314. | 4,464. |
| | 60" | 24" | 26 5/8" | DS4LC2CLV60L | 4,089. | 4,389. | 4,539. |
| | 66" | 24" | 26 5/8" | DS4LC2CLV66L | 4,154. | 4,464. | 4,621. |
| | 72" | 24" | 26 5/8" | DS4LC2CLV72L | 4,223. | 4,536. | 4,697. |
|  <p>Credenza with Veneer Drawer</p> | 30" | 24" | 26 5/8" | DS4LC2CVV30L | 3,966. | 4,248. | 4,389. |
| | 36" | 24" | 26 5/8" | DS4LC2CVV36L | 3,966. | 4,248. | 4,389. |
| | 42" | 24" | 26 5/8" | DS4LC2CVV42L | 3,966. | 4,248. | 4,389. |
| | 48" | 24" | 26 5/8" | DS4LC2CVV48L | 4,033. | 4,323. | 4,466. |
| | 54" | 24" | 26 5/8" | DS4LC2CVV54L | 4,100. | 4,396. | 4,546. |
| | 60" | 24" | 26 5/8" | DS4LC2CVV60L | 4,170. | 4,471. | 4,621. |
| | 66" | 24" | 26 5/8" | DS4LC2CVV66L | 4,237. | 4,546. | 4,703. |
| | 72" | 24" | 26 5/8" | DS4LC2CVV72L | 4,306. | 4,619. | 4,778. |

Dimensions listed under w h d are actual to the nearest 1/16"

| Ordering Information | Order Code | Included with: | Options |
|--|---|--|---|
| <p>Credenza with a Drawer:</p> <ol style="list-style-type: none"> 1. Pattern number 2. Paint finish 3. Top finish 4. Door finish 5. Door edge finish <p>(laminates and veneer only) (laminates only)</p> | <p>Credenza with a Drawer:</p> <p><i>Example:</i> DS4LC2CSV42L /117/Y319</p> <hr/> <p>DS4LC2C Pattern Number SV42L</p> <hr/> <p>117 Dark grey paint Y319 Cherry Techwood top</p> | <p>Credenza with a Drawer:</p> <p>Note: Credenzas are only available in Knoll core finishes.</p> | <p>Credenza with a Drawer:</p> <p>Lock/No lock option For non-locking credenzas with a sliding door or a drawer, substitute the "L" suffix with a "N" and deduct \$40 from the list price.</p> <p>Paint Configuration Option: Add "Y" at the end of the pattern number to specify a different paint finish on the case and fronts. P3 pricing applies on all product with dual paint finishes.</p> |

*Double Depth with Veneer Top
With a Sliding Door and with a Drawer*

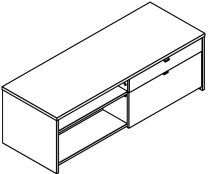
| description | w | h | d | pattern no. | P1 | P2 | P3 |
|--|-----|-----|----------------------------------|---------------------|----------|----------|----------|
|  <p>Credenza with Steel Sliding Door and Drawer</p> | 30" | 24" | 26 ⁵ / ₈ " | DS4LC2DSV30L | \$3,656. | \$3,950. | \$4,096. |
| | 36" | 24" | 26 ⁵ / ₈ " | DS4LC2DSV36L | 3,656. | 3,950. | 4,096. |
| | 42" | 24" | 26 ⁵ / ₈ " | DS4LC2DSV42L | 3,656. | 3,950. | 4,096. |
| | 48" | 24" | 26 ⁵ / ₈ " | DS4LC2DSV48L | 3,728. | 4,031. | 4,178. |
| | 54" | 24" | 26 ⁵ / ₈ " | DS4LC2DSV54L | 3,803. | 4,107. | 4,262. |
| | 60" | 24" | 26 ⁵ / ₈ " | DS4LC2DSV60L | 3,872. | 4,188. | 4,346. |
| | 66" | 24" | 26 ⁵ / ₈ " | DS4LC2DSV66L | 3,945. | 4,266. | 4,426. |
| | 72" | 24" | 26 ⁵ / ₈ " | DS4LC2DSV72L | 4,019. | 4,346. | 4,512. |

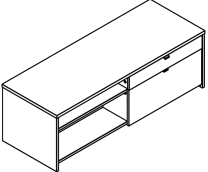
| | | | | | | | |
|---|-----|-----|----------------------------------|---------------------|--------|--------|--------|
|  <p>Credenza with Laminate Sliding Door and Drawer</p> | 30" | 24" | 26 ⁵ / ₈ " | DS4LC2DLV30L | 4,296. | 4,651. | 4,829. |
| | 36" | 24" | 26 ⁵ / ₈ " | DS4LC2DLV36L | 4,296. | 4,651. | 4,829. |
| | 42" | 24" | 26 ⁵ / ₈ " | DS4LC2DLV42L | 4,296. | 4,651. | 4,829. |
| | 48" | 24" | 26 ⁵ / ₈ " | DS4LC2DLV48L | 4,368. | 4,733. | 4,915. |
| | 54" | 24" | 26 ⁵ / ₈ " | DS4LC2DLV54L | 4,444. | 4,814. | 4,998. |
| | 60" | 24" | 26 ⁵ / ₈ " | DS4LC2DLV60L | 4,516. | 4,894. | 5,084. |
| | 66" | 24" | 26 ⁵ / ₈ " | DS4LC2DLV66L | 4,586. | 4,974. | 5,170. |
| | 72" | 24" | 26 ⁵ / ₈ " | DS4LC2DLV72L | 4,663. | 5,054. | 5,253. |

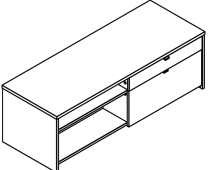
| | | | | | | | |
|--|-----|-----|----------------------------------|---------------------|--------|--------|--------|
|  <p>Credenza with Veneer Sliding Door and Drawer</p> | 30" | 24" | 26 ⁵ / ₈ " | DS4LC2DVV30L | 4,486. | 4,857. | 5,047. |
| | 36" | 24" | 26 ⁵ / ₈ " | DS4LC2DVV36L | 4,486. | 4,857. | 5,047. |
| | 42" | 24" | 26 ⁵ / ₈ " | DS4LC2DVV42L | 4,486. | 4,857. | 5,047. |
| | 48" | 24" | 26 ⁵ / ₈ " | DS4LC2DVV48L | 4,571. | 4,958. | 5,148. |
| | 54" | 24" | 26 ⁵ / ₈ " | DS4LC2DVV54L | 4,661. | 5,051. | 5,251. |
| | 60" | 24" | 26 ⁵ / ₈ " | DS4LC2DVV60L | 4,748. | 5,148. | 5,352. |
| | 66" | 24" | 26 ⁵ / ₈ " | DS4LC2DVV66L | 4,833. | 5,246. | 5,453. |
| | 72" | 24" | 26 ⁵ / ₈ " | DS4LC2DVV72L | 4,925. | 5,342. | 5,549. |

Dimensions listed under w h d are actual to the nearest ¹/₁₆"

| Ordering Information | Order Code | Included with: | Options |
|--|--|---|--|
| <p>Credenza with a Sliding Door and a Drawer:</p> <ol style="list-style-type: none"> 1. Pattern number 2. Paint finish 3. Top finish 4. Drawer/Door finish (laminates and veneer only) 5. Drawer/Door edge finish (laminates only) | <p>Credenza with a Sliding Door and a Drawer:</p> <p><i>Example:</i> DS4LC2SV42L /117/Y319</p> <hr/> <p>DS4LC2D Pattern Number</p> <hr/> <p>SV42L</p> <hr/> <p>117 Dark grey paint</p> <hr/> <p>Y319 Cherry Techwood top</p> | <p>Credenza with a Sliding Door and a Drawer:</p> <p>Note: Credenzas are only available in Knoll core finishes.</p> | <p>Credenza with a Sliding Door and a Drawer:</p> <p>Lock/No lock option For non-locking credenzas with a sliding door or a drawer, substitute the "L" suffix with a "N" and deduct \$80 from the list price.</p> <p>Paint Configuration Option: Add "Y" at the end of the pattern number to specify a different paint finish on the case and fronts. P3 pricing applies on all product with dual paint finishes.</p> |

This page intentionally left blank

Flip-up Door Overdesk Units

Series 1 and Series 2 freestanding flip-up door overdesk units mount atop freestanding desks to provide overhead storage.

Pass-through communications or visual privacy can be obtained with a removeable privacy screen. When installed on freestanding desks, overdesks match up to 64" high panels to provide a consistent height within the facility.

Flip-up door overdesk units consist of an overhead cabinet with or without lock and enclosed back along with desk-mount stanchions. Tackable privacy screens are optional and mount between the stanchions. Overdesks 30" to 48" wide have single overhead doors while units 60" and 72" wide have double doors.

Available Sizes

- Height: 37½"
- Depth: 13½"
- Widths: 36", 42", 48", 54", 60", 66" and 72"

Flip-up Door Overdesk Attachment

Flip-up door overdesks can be mounted to both single and double pedestal desks. The stanchion design provides attachment directly through the top of the worksurface. In addition, overdesks can be attached virtually anywhere along the worksurface provided that proper floorstanding worksurface support is used.

NOTE: ATTACHMENT REQUIRES DRILLING TOP OF WORKSURFACES.

Construction

- Outer cabinet: 20-gauge steel
- Cabinet top and lower shelf: 18-gauge for 36", 42" and 48" widths and 16-gauge for 60" and 72" widths
- Overhead doors: 20-gauge painted steel
- Door end trim: Color injected, molded plastic
- Overhead door suspension: Steel ball-bearing
- Outer stanchions: 14-gauge steel
- Inner stanchions: 20-gauge steel

Wire Management

Vertical wire management channels for task light wires are located inside stanchions and are concealed by the inner stanchion.

Locks

Locks are standard on overdesks and keyed randomly unless otherwise specified. Other keying options include keyed alike or keyed with lock cores (K001-K250). All locks are factory-installed and are black finish. Overdesks can also be specified without locks if required.

Optional lock retrofit kits are available for field installation in flip-up door overdesks without locks at a later date if required.

Tackable Privacy Screen

Flip-up door overdesk privacy screen provides visual privacy and a tackable surface. Privacy screens mount between flip-up door overdesk stanchions and are available in all overdesk widths.

Privacy screen construction is similar to the fabric insert used on Dividends panel frames. Two fabric wrapped inserts sandwich a honeycomb core providing both tackable and acoustic features.

Note: Tackable privacy screens are for use with Series 1 and Series 2 flip-up door overdesks only. They are not compatible with sliding door overdesks.

“Touchdown” Overhead Cabinets

Touchdown overhead cabinets are equipped with hydraulic assist cylinders that allows the overhead cabinet front to gently fall to a closed position.

Retrofit mechanisms may be field added to any flip-up door overdesk.

Task Lights

Series 1 and 2 flip-up door overdesks will accept task lights. Task lights must be ordered separately.

Flip-Up Door Overdesk Applications

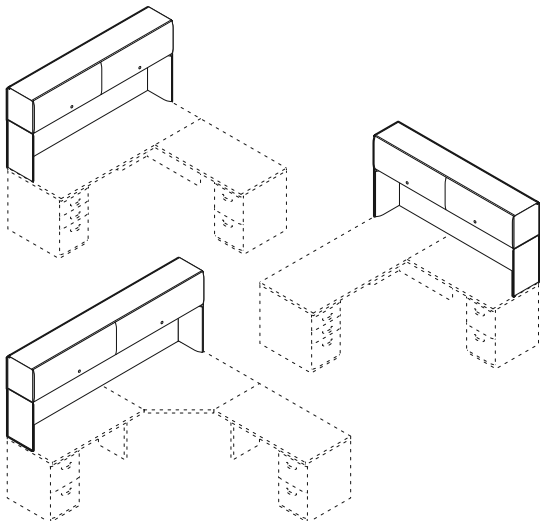

Overdesk units can span a single worksurface or two worksurfaces in “L” configuration.

Flip-Up Door Overdesk Unit Components

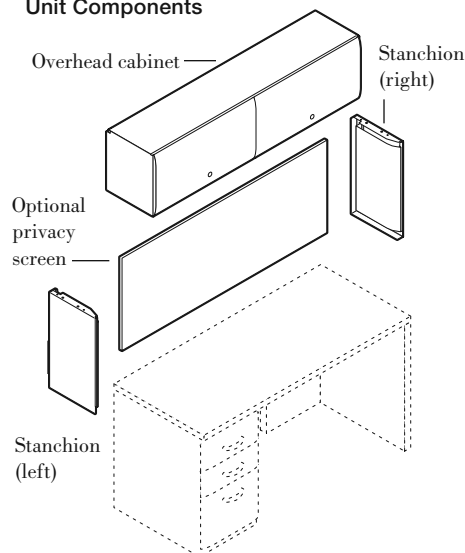

Flip-Up Door Overdesk Size Configurations

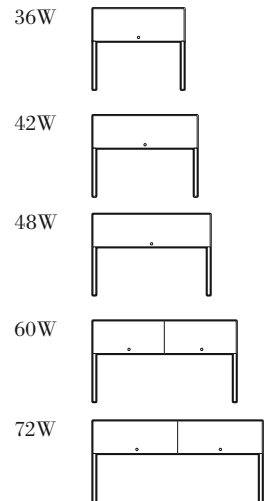

Flip-up Door Overdesk and Tackboards

Dividends and Series 2

Dividends Horizon

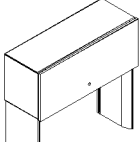
| description | w | d | h | pattern no. | black | P1 | P2 | P3 | V1-P1 | V1-P2 | V1-P3 |
|---|-----|---------|-----|------------------|-------|--------|--------|--------|-------|-------|-------|
|  Flip-Up Door Overdesk with Enclosed Back and Lock (includes Stanchions) | 36" | 13 1/2" | 15" | DD2OD 36L | n/a | \$809. | \$894. | \$936. | n/a | n/a | n/a |
| | 42" | 13 1/2" | 15" | DD2OD 42L | n/a | 852. | 939. | 985. | n/a | n/a | n/a |
| | 48" | 13 1/2" | 15" | DD2OD 48L | n/a | 878. | 967. | 1,015. | n/a | n/a | n/a |
| | 54" | 13 1/2" | 15" | DD2OD 54L | n/a | 1,071. | 1,177. | 1,238. | n/a | n/a | n/a |
| | 60" | 13 1/2" | 15" | DD2OD 60L | n/a | 1,071. | 1,177. | 1,238. | n/a | n/a | n/a |
| | 66" | 13 1/2" | 15" | DD2OD 66L | n/a | 1,099. | 1,210. | 1,272. | n/a | n/a | n/a |
| | 72" | 13 1/2" | 15" | DD2OD 72L | n/a | 1,099. | 1,210. | 1,272. | n/a | n/a | n/a |

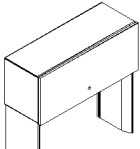
| | | | | | | | | | | | |
|--|-----|---------|-----|------------------|-----|--------|--------|--------|--------|--------|--------|
|  Series 2 Flip-Up Door Overdesk with Enclosed Back and Lock (includes Stanchions) | 36" | 13 1/2" | 15" | DS2OD 36L | n/a | 1,146. | 1,319. | 1,377. | 1,399. | 1,575. | 1,630. |
| | 42" | 13 1/2" | 15" | DS2OD 42L | n/a | 1,170. | 1,346. | 1,403. | 1,437. | 1,611. | 1,671. |
| | 48" | 13 1/2" | 15" | DS2OD 48L | n/a | 1,185. | 1,361. | 1,420. | 1,490. | 1,669. | 1,724. |
| | 54" | 13 1/2" | 15" | DS2OD 54L | n/a | 1,442. | 1,659. | 1,735. | 1,913. | 2,131. | 2,202. |
| | 60" | 13 1/2" | 15" | DS2OD 60L | n/a | 1,442. | 1,659. | 1,735. | 1,913. | 2,131. | 2,202. |
| | 66" | 13 1/2" | 15" | DS2OD 66L | n/a | 1,490. | 1,715. | 1,787. | 1,979. | 2,204. | 2,277. |
| | 72" | 13 1/2" | 15" | DS2OD 72L | n/a | 1,490. | 1,715. | 1,787. | 1,979. | 2,204. | 2,277. |

| | | | | | | | | | | | |
|--|--|--|--|---------------|------|------|------|------|--|--|--|
| Vertical Dividers (for flip-up overheads and open shelves) Package of 4 | | | | DS1 VD | 100. | 104. | 109. | 115. | | | |
|--|--|--|--|---------------|------|------|------|------|--|--|--|



| Ordering Information | Order Code | Included with: | Options |
|---|--|--|--|
| Overdesk Cabinet 1. Pattern Number 2. Paint Finish 3. Door End Cap Finish | Overdesk Cabinet <i>Example:</i> DD2OD 48L, 613, 113 DD2OD Pattern Number 48L 613 Silver paint finish 113 Dark grey door end cap finish | Overdesk Cabinet Stanchion mount overdesk cabinets include an enclosed back. | Overdesk Cabinet To specify overhead cabinet without locks, replace the "L" suffix from the pattern number with "N". For 30" to 48" wide overdesk units, Deduct \$20 For 54", 60", 66" and 72" wide overdesk units, Deduct \$40 To specify Touchdown overhead cabinet, add "E" as the 2nd to last digit of the pattern number <i>Example:</i> DS3PML48EL (Add \$163 for cabinet widths of 48" or less. Add \$327 for cabinet widths of 54" or greater). Add a "Y" to the end of the pattern number to specify a different finish for the door versus the case. Use P3 pricing for this dual finish option. |

Flip-up Door Overdesk and Tackboards

Dividends and Series 2 Tackboard

Dividends Horizon

| description | w | h | pattern no. | grade | | | | | | | |
|---|-----|-----|-----------------|--------|--------|--------|--------|--------|--------|--------|--------|
| | | | | 10 | 15 | 20 | 25 | 30 | 35 | 40 | 45 |
| Flip-Up Door Overdesk | 36" | 20" | DD3 PS36 | \$288. | \$296. | \$312. | \$317. | \$324. | \$330. | \$336. | \$346. |
| Tackable Privacy Screen | 42" | 20" | DD3 PS42 | 301. | 312. | 326. | 331. | 343. | 348. | 354. | 363. |
| (for Dividends and Series 2 Overdesks) | 48" | 20" | DD3 PS48 | 314. | 322. | 336. | 345. | 354. | 361. | 366. | 375. |
|  | 54" | 20" | DD3 PS54 | 335. | 346. | 363. | 369. | 379. | 384. | 394. | 401. |
| | 60" | 20" | DD3 PS60 | 335. | 346. | 363. | 369. | 379. | 384. | 394. | 401. |
| | 66" | 20" | DD3 PS66 | 363. | 371. | 392. | 397. | 408. | 415. | 425. | 434. |
| | 72" | 20" | DD3 PS72 | 363. | 371. | 392. | 397. | 408. | 415. | 425. | 434. |

Ordering Information

Overdesk Tackable Privacy Screen

1. Pattern Number
2. Fabric

Order Code

Overdesk Tackable Privacy Screen

Example: **DD3 PS48, W351-3**

DD3 PS48 Pattern Number

W351-3 Foundation Corn Silk

Included with:

Overdesk Tackable Privacy Screen

Options

Note: Flip-up Door overdesk tackable privacy screen is for use with Dividends and Series 2 Flip-up door overheads.

This page intentionally left blank

Sliding Door Overdesks

The rectilinear door profile of the sliding door overdesk was designed to complement the flat profile trim details of the Dividends Horizon system. Sliding door overdesks can be used in paneled workstation configurations or freestanding office applications.

Sliding door overdesks mount atop worksurfaces to provide overhead storage. When installed on a worksurface, sliding door overdesks match up to 57" and 64" high panels to provide a consistent height within the facility. 14" or 21" high sliding door overdesks consist of a top, shelf, mid cabinet septum, end panels/stanchions, and a door with a handle.

14" high cabinets and 21" high cabinets with full doors are standard with fully enclosed backs behind the storage area. No door units and 21" high cabinets with partial doors have a partial or full back option available. Partial backs cover the upper storage section of the cabinet. Full backs enclose both the upper and lower storage section of the cabinet.

21" high cabinets are able to be specified with a full or partial door. A partial door covers the upper section of the cabinet. A full door covers both the upper and lower section of the cabinet.

Available Sizes

- Height: 14" and 21"
- Depth: 13-1/2"
- Widths: 30", 36", 42", 48", 60", 66", and 72"

Sliding Door Overdesks

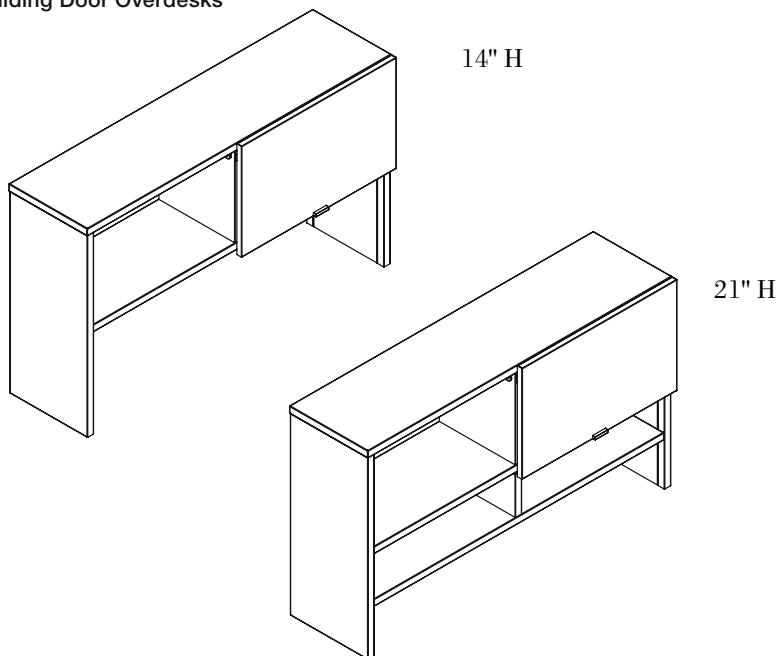

Construction

- **Horizontal top and shelf:** 18-gauge (30" to 48" wide), 16-gauge (60" to 72" wide) painted steel
- **Sliding door:**
 - Steel: 20-gauge painted steel
 - Laminate: 3/4" particle board with high pressure laminate on the outside and a paper backer on the inside. 1mm edgeband.
 - Veneer: 3/4" thick particle board with 0.6mm thick veneer on top and edge.
- **End panels/stanchions:** 16-gauge painted steel
- **Sliding door mechanism:** integral track in top and bottom shelves with full length abs plastic extrusion. Door brackets are injection molded nylon.
- **Fixed Shelf:** 16-gauge painted steel
- **Door handle:** painted aluminum (same color as case)
- **Back panel:** 20-gauge painted steel

Interior Dimensions

The interior dimensions of sliding door overdesks are:

- Depth: 12 1/4"
- Usable interior height: 12-1/2" high for 14"H cabinets and upper portion of 21"H cabinets; 6-1/8"H for lower portion of 21"H cabinets.
- Width: 1" shorter than exterior width

Overdesk Attachment

Overdesks can be mounted to both single and double pedestal desks as well as panel hung worksurfaces. The stanchion design provides attachment directly through the top of the worksurface. In addition, overdesks can be attached virtually anywhere along the worksurface provided that proper worksurface support is used.

Dividends Horizon Series 3 Overdesk units are sized to the nominal dimension, and are designed for use on the width dimension of Dividends Horizon rectangular worksurfaces.

Series 3 overheads are not compatible with use on extended corner worksurfaces, or a combination of other worksurfaces that are less than the nominal dimension.

NOTE: ATTACHMENT REQUIRES DRILLING TOP OF WORKSURFACES.

Task Lights

Sliding door overdesks will accept task lights. Task lights must be ordered separately.

Locks

Locks are standard on overhead cabinets and keyed randomly unless otherwise specified. All locks are factory-installed and are a black finish. Overdesks can also be specified without locks if required.

Note: Sliding door overdesks are only available in Knoll Core finishes.

Interior Dimensions for 14"H Overhead

Front View, Interior Height

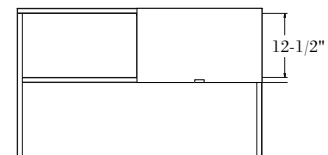

Top View, Interior Height

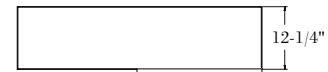

Interior Dimensions for 21"H Overhead

Front View, Interior Height

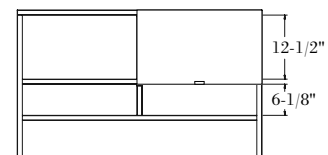

Top View, Interior Height

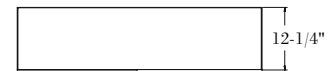

Sliding Door Overdesks

57" High Cabinet with 14" High Storage, 14" High Door

Dividends Horizon

| description | w | pattern no. | P1 | P2 | P3 |
|---|-----|-----------------------|--------|----------|----------|
| 57" h Overdesk without Door with 14" Tall Cabinet | 30" | DS3ODNS1573014 | \$962. | \$1,060. | \$1,104. |
| | 36" | DS3ODNS1573614 | 981. | 1,080. | 1,128. |
| | 42" | DS3ODNS1574214 | 999. | 1,099. | 1,149. |
| | 48" | DS3ODNS1574814 | 1,036. | 1,137. | 1,189. |
| | 60" | DS3ODNS1576014 | 1,123. | 1,236. | 1,291. |
| | 66" | DS3ODNS1576614 | 1,149. | 1,266. | 1,323. |
| | 72" | DS3ODNS1577214 | 1,168. | 1,284. | 1,342. |

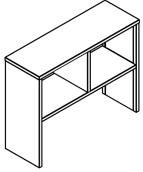

| | | | | | |
|---|-----|------------------------|--------|--------|--------|
| 57" h Overdesk with Steel Sliding Door and 14" Tall Cabinet | 30" | DS3ODSS1573014L | 1,040. | 1,142. | 1,191. |
| | 36" | DS3ODSS1573614L | 1,064. | 1,168. | 1,219. |
| | 42" | DS3ODSS1574214L | 1,088. | 1,192. | 1,246. |
| | 48" | DS3ODSS1574814L | 1,122. | 1,230. | 1,286. |
| | 60" | DS3ODSS1576014L | 1,226. | 1,350. | 1,408. |
| | 66" | DS3ODSS1576614L | 1,258. | 1,382. | 1,444. |
| | 72" | DS3ODSS1577214L | 1,276. | 1,400. | 1,461. |

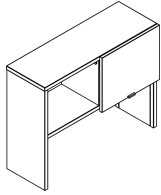

| | | | | | |
|--|-----|------------------------|--------|--------|--------|
| 57" h Overdesk with Laminate Sliding Door and 14" Tall Cabinet | 30" | DS3ODSL1573014L | 1,373. | 1,508. | 1,577. |
| | 36" | DS3ODSL1573614L | 1,409. | 1,549. | 1,618. |
| | 42" | DS3ODSL1574214L | 1,445. | 1,588. | 1,659. |
| | 48" | DS3ODSL1574814L | 1,484. | 1,628. | 1,700. |
| | 60" | DS3ODSL1576014L | 1,519. | 1,669. | 1,742. |
| | 66" | DS3ODSL1576614L | 1,555. | 1,709. | 1,786. |
| | 72" | DS3ODSL1577214L | 1,591. | 1,748. | 1,827. |

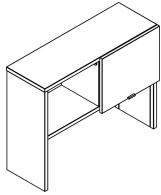

| | | | | | |
|--|-----|------------------------|--------|--------|--------|
| 57" h Overdesk with Veneer Sliding Door and 14" Tall Cabinet | 30" | DS3ODSV1573014L | 1,447. | 1,590. | 1,661. |
| | 36" | DS3ODSV1573614L | 1,491. | 1,636. | 1,711. |
| | 42" | DS3ODSV1574214L | 1,534. | 1,683. | 1,760. |
| | 48" | DS3ODSV1574814L | 1,576. | 1,730. | 1,809. |
| | 60" | DS3ODSV1576014L | 1,618. | 1,778. | 1,856. |
| | 66" | DS3ODSV1576614L | 1,661. | 1,824. | 1,906. |
| | 72" | DS3ODSV1577214L | 1,702. | 1,870. | 1,955. |

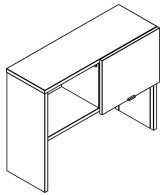

Ordering Information

Sliding Door Overdesk

1. Pattern number
2. Case finish
3. Door finish

Order Code

Sliding Door Overdesk

Example: **DS3ODSS 1573014FL, 613**

DS3ODSS Pattern Number
1573014FL

613 Silver Paint Finish

Included with:

Sliding Door Overdesk

Note: Overheads are only available in Knoll core finishes.

No lock - substitute "N" for "L" at the end of pattern number, subtract \$20.

Paint Configuration Option:

Add "Y" at the end of the pattern number to specify a different paint finish on the case and fronts. P3 pricing applies on all product with dual paint finishes.

Sliding Door Overdesks 57" High Cabinet with 21" High Storage (Full Height Door)

Dividends Horizon

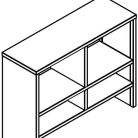
| description | w | pattern no. | P1 | P2 | P3 |
|--|-----|-------------------------|----------|----------|----------|
|  57" h without Sliding Door Overdesk with 21" Tall Cabinet | 30" | DS3ODNS()573021 | \$1,037. | \$1,141. | \$1,191. |
| | 36" | DS3ODNS()573621 | 1,062. | 1,168. | 1,220. |
| | 42" | DS3ODNS()574221 | 1,087. | 1,193. | 1,247. |
| | 48" | DS3ODNS()574821 | 1,128. | 1,242. | 1,299. |
| | 60" | DS3ODNS()576021 | 1,234. | 1,358. | 1,421. |
| | 66" | DS3ODNS()576621 | 1,267. | 1,395. | 1,457. |
| | 72" | DS3ODNS()577221 | 1,288. | 1,415. | 1,483. |

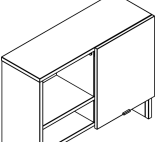
| | | | | | |
|--|-----|-------------------------|--------|--------|--------|
|  57" h Steel Sliding Door Overdesk with 21" Tall Cabinet | 30" | DS3ODSS2573021FL | 1,184. | 1,301. | 1,358. |
| | 36" | DS3ODSS2573621FL | 1,207. | 1,326. | 1,384. |
| | 42" | DS3ODSS2574221FL | 1,242. | 1,362. | 1,424. |
| | 48" | DS3ODSS2574821FL | 1,310. | 1,437. | 1,502. |
| | 60" | DS3ODSS2576021FL | 1,438. | 1,580. | 1,650. |
| | 66" | DS3ODSS2576621FL | 1,486. | 1,630. | 1,706. |
| | 72" | DS3ODSS2577221FL | 1,516. | 1,664. | 1,739. |

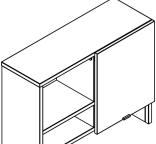
| | | | | | |
|--|-----|-------------------------|--------|--------|--------|
|  57" h Laminate Sliding Door Overdesk with 21" Tall Cabinet | 30" | DS3ODSL2573021FL | 1,552. | 1,706. | 1,782. |
| | 36" | DS3ODSL2573621FL | 1,605. | 1,764. | 1,843. |
| | 42" | DS3ODSL2574221FL | 1,657. | 1,821. | 1,902. |
| | 48" | DS3ODSL2574821FL | 1,711. | 1,879. | 1,962. |
| | 60" | DS3ODSL2576021FL | 1,763. | 1,938. | 2,025. |
| | 66" | DS3ODSL2576621FL | 1,815. | 1,996. | 2,083. |
| | 72" | DS3ODSL2577221FL | 1,867. | 2,052. | 2,144. |

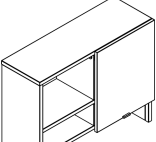
| | | | | | |
|---|-----|-------------------------|--------|--------|--------|
|  57" h Veneer Sliding Door Overdesk with 21" Tall Cabinet | 30" | DS3ODSV2573021FL | 1,632. | 1,792. | 1,872. |
| | 36" | DS3ODSV2573621FL | 1,694. | 1,863. | 1,948. |
| | 42" | DS3ODSV2574221FL | 1,761. | 1,935. | 2,021. |
| | 48" | DS3ODSV2574821FL | 1,823. | 2,003. | 2,094. |
| | 60" | DS3ODSV2576021FL | 1,889. | 2,074. | 2,168. |
| | 66" | DS3ODSV2576621FL | 1,952. | 2,144. | 2,241. |
| | 72" | DS3ODSV2577221FL | 2,016. | 2,215. | 2,315. |

Ordering Information

Sliding Door Overdesk

1. Pattern number
2. Case finish
3. Door finish

Order Code

Sliding Door Overdesk

Example: **DS3ODSS 2573021FL, 613**

DS3ODSS Pattern Number

2573021FL

613 Silver Paint Finish

Included with:

Sliding Door Overdesk

Note: Overheads are only available in Knoll core finishes.

Options

No lock - substitute "N" for "L" at the end of pattern number, subtract \$20.

Back option for No Door units
(1) = Back covering overhead only
(2) = Back covering overhead and shelf section

Paint Configuration Option:

Add "Y" at the end of the pattern number to specify a different paint finish on the case and fronts. P3 pricing applies on all product with dual paint finishes.

Sliding Door Overdesks 57" High Cabinet with 21" High Storage (Partial Height Door)

Dividends Horizon

| description | w | pattern no. | P1 | P2 | P3 |
|---|-----|---------------------------|----------|----------|----------|
| 57"h Steel Sliding Door Overdesk with 21" Tall Cabinet | 30" | DS3ODSS()573021PL | \$1,184. | \$1,301. | \$1,358. |
| | 36" | DS3ODSS()573621PL | 1,207. | 1,326. | 1,384. |
| | 42" | DS3ODSS()574221PL | 1,242. | 1,362. | 1,424. |
| | 48" | DS3ODSS()574821PL | 1,310. | 1,437. | 1,502. |
| | 60" | DS3ODSS()576021PL | 1,438. | 1,580. | 1,650. |
| | 66" | DS3ODSS()576621PL | 1,486. | 1,630. | 1,706. |
| | 72" | DS3ODSS()577221PL | 1,516. | 1,664. | 1,739. |

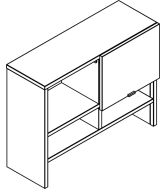

| | | | | | |
|--|-----|---------------------------|--------|--------|--------|
| 57"h Laminate Sliding Door Overdesk with 21" Tall Cabinet | 30" | DS3ODSL()573021PL | 1,543. | 1,694. | 1,771. |
| | 36" | DS3ODSL()573621PL | 1,595. | 1,754. | 1,830. |
| | 42" | DS3ODSL()574221PL | 1,647. | 1,810. | 1,891. |
| | 48" | DS3ODSL()574821PL | 1,698. | 1,866. | 1,951. |
| | 60" | DS3ODSL()576021PL | 1,753. | 1,923. | 2,010. |
| | 66" | DS3ODSL()576621PL | 1,804. | 1,982. | 2,071. |
| | 72" | DS3ODSL()577221PL | 1,855. | 2,038. | 2,131. |

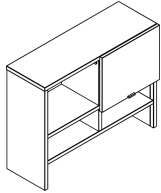

| | | | | | |
|--|-----|---------------------------|--------|--------|--------|
| 57"h Veneer Sliding Door Overdesk with 21" Tall Cabinet | 30" | DS3ODSV()573021PL | 1,619. | 1,779. | 1,858. |
| | 36" | DS3ODSV()573621PL | 1,678. | 1,843. | 1,924. |
| | 42" | DS3ODSV()574221PL | 1,736. | 1,907. | 1,994. |
| | 48" | DS3ODSV()574821PL | 1,794. | 1,972. | 2,060. |
| | 60" | DS3ODSV()576021PL | 1,853. | 2,035. | 2,129. |
| | 66" | DS3ODSV()576621PL | 1,913. | 2,100. | 2,194. |
| | 72" | DS3ODSV()577221PL | 1,970. | 2,166. | 2,263. |

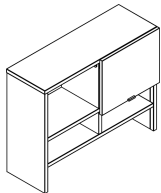

Ordering Information

Sliding Door Overdesk

1. Pattern number
2. Case finish
3. Door finish

Order Code

Sliding Door Overdesk

Example: **DS3ODSS 2573021PL, 613**

DS3ODSS Pattern Number
2573021PL

613 Silver Paint Finish

Included with:

Sliding Door Overdesk

Note: Overheads are only available in Knoll core finishes.

Options

No lock - substitute "N" for "L" at the end of pattern number, subtract \$20.

Back option

(1)= Back covering overhead only
(2) = Back covering overhead and shelf section

Paint Configuration Option:

Add "Y" at the end of the pattern number to specify a different paint finish on the case and fronts. P3 pricing applies on all product with dual paint finishes.

Sliding Door Overdesks 64" High Cabinet with 14" High Storage

Dividends Horizon

| description | w | pattern no. | P1 | P2 | P3 |
|---|-----|-----------------------|--------|----------|----------|
| 64"h without Sliding Door Overdesk with 14" Tall Cabinet | 30" | DS3ODNS1643014 | \$996. | \$1,095. | \$1,143. |
| | 36" | DS3ODNS1643614 | 1,005. | 1,103. | 1,152. |
| | 42" | DS3ODNS1644214 | 1,037. | 1,137. | 1,187. |
| | 48" | DS3ODNS1644814 | 1,127. | 1,237. | 1,291. |
| | 60" | DS3ODNS1646014 | 1,162. | 1,275. | 1,330. |
| | 66" | DS3ODNS1646614 | 1,187. | 1,304. | 1,361. |
| | 72" | DS3ODNS1647214 | 1,203. | 1,321. | 1,378. |

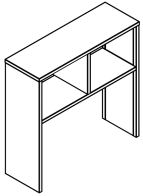

| | | | | | |
|---|-----|------------------------|--------|--------|--------|
| 64"h Steel Sliding Door Overdesk with 14" Tall Cabinet | 30" | DS3ODSS1643014L | 1,050. | 1,151. | 1,203. |
| | 36" | DS3ODSS1643614L | 1,073. | 1,178. | 1,228. |
| | 42" | DS3ODSS1644214L | 1,097. | 1,203. | 1,256. |
| | 48" | DS3ODSS1644814L | 1,132. | 1,243. | 1,299. |
| | 60" | DS3ODSS1646014L | 1,238. | 1,359. | 1,421. |
| | 66" | DS3ODSS1646614L | 1,272. | 1,395. | 1,457. |
| | 72" | DS3ODSS1647214L | 1,284. | 1,409. | 1,471. |

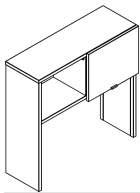

| | | | | | |
|--|-----|------------------------|--------|--------|--------|
| 64"h Laminate Sliding Door Overdesk with 14" Tall Cabinet | 30" | DS3ODSL1643014L | 1,384. | 1,520. | 1,588. |
| | 36" | DS3ODSL1643614L | 1,422. | 1,561. | 1,630. |
| | 42" | DS3ODSL1644214L | 1,459. | 1,602. | 1,674. |
| | 48" | DS3ODSL1644814L | 1,496. | 1,643. | 1,717. |
| | 60" | DS3ODSL1646014L | 1,534. | 1,683. | 1,760. |
| | 66" | DS3ODSL1646614L | 1,570. | 1,724. | 1,802. |
| | 72" | DS3ODSL1647214L | 1,606. | 1,765. | 1,844. |

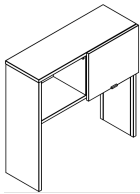

Ordering Information

Sliding Door Overdesk

1. Pattern number
2. Case finish
3. Door finish

Order Code

Sliding Door Overdesk

Example: **DS3ODSS 2643014FL, 613**

DS3ODSS Pattern Number
2643014FL

613 Silver Paint Finish

Included with:

Sliding Door Overdesk

Note: Overheads are only available in Knoll core finishes.

Options

No lock - substitute "N" for "L" at the end of pattern number, subtract \$20.

Paint Configuration Option:

Add "Y" at the end of the pattern number to specify a different paint finish on the case and fronts. P3 pricing applies on all product with dual paint finishes.

Sliding Door Overdesks 64" High Cabinet with 14" High Storage

Dividends Horizon

| description | w | pattern no. | P1 | P2 | P3 |
|---|-----|------------------------|----------|----------|----------|
| 64" h Veneer Sliding Door Overdesk with 14" Tall Cabinet | 30" | DS3ODSV1643014L | \$1,459. | \$1,603. | \$1,675. |
| | 36" | DS3ODSV1643614L | 1,502. | 1,650. | 1,724. |
| | 42" | DS3ODSV1644214L | 1,546. | 1,698. | 1,775. |
| | 48" | DS3ODSV1644814L | 1,590. | 1,745. | 1,824. |
| | 60" | DS3ODSV1646014L | 1,634. | 1,793. | 1,875. |
| | 66" | DS3ODSV1646614L | 1,678. | 1,842. | 1,924. |
| | 72" | DS3ODSV1647214L | 1,721. | 1,889. | 1,975. |

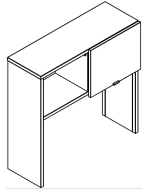

Ordering Information

Sliding Door Overdesk

1. Pattern number
2. Case finish
3. Door finish

Order Code

Sliding Door Overdesk

Example: **DS3ODSS 2643014FL, 613**

DS3ODSS Pattern Number
2643014FL

613 Silver Paint Finish

Included with:

Sliding Door Overdesk

Note: Overheads are only available in Knoll core finishes.

Options

No lock - substitute "N" for "L" at the end of pattern number, subtract \$20.

Paint Configuration Option:

Add "Y" at the end of the pattern number to specify a different paint finish on the case and fronts. P3 pricing applies on all product with dual paint finishes.

Sliding Door Overdesks 64" High Cabinet with 21" High Storage (Full Height Door)

Dividends Horizon

| description | w | pattern no. | P1 | P2 | P3 |
|---|-----|-------------------------|----------|----------|----------|
| 64"h without Sliding Door Overdesk with 21" Tall Cabinet | 30" | DS3ODNS()643021 | \$1,060. | \$1,166. | \$1,217. |
| | 36" | DS3ODNS()643621 | 1,076. | 1,184. | 1,238. |
| | 42" | DS3ODNS()644221 | 1,103. | 1,216. | 1,273. |
| | 48" | DS3ODNS()644821 | 1,175. | 1,291. | 1,351. |
| | 60" | DS3ODNS()646021 | 1,289. | 1,418. | 1,484. |
| | 66" | DS3ODNS()646621 | 1,330. | 1,462. | 1,531. |
| | 72" | DS3ODNS()647221 | 1,360. | 1,498. | 1,565. |

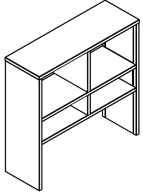

| | | | | | |
|---|-----|-------------------------|--------|--------|--------|
| 64"h Steel Sliding Door Overdesk with 21" Tall Cabinet | 30" | DS3ODSS2643021FL | 1,191. | 1,309. | 1,366. |
| | 36" | DS3ODSS2643621FL | 1,216. | 1,333. | 1,395. |
| | 42" | DS3ODSS2644221FL | 1,248. | 1,370. | 1,433. |
| | 48" | DS3ODSS2644821FL | 1,317. | 1,445. | 1,511. |
| | 60" | DS3ODSS2646021FL | 1,445. | 1,588. | 1,659. |
| | 66" | DS3ODSS2646621FL | 1,493. | 1,641. | 1,714. |
| | 72" | DS3ODSS2647221FL | 1,525. | 1,674. | 1,748. |

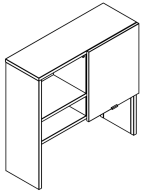

| | | | | | |
|--|-----|-------------------------|--------|--------|--------|
| 64"h Laminate Sliding Door Overdesk with 21" Tall Cabinet | 30" | DS3ODSL2643021FL | 1,567. | 1,722. | 1,799. |
| | 36" | DS3ODSL2643621FL | 1,619. | 1,779. | 1,858. |
| | 42" | DS3ODSL2644221FL | 1,672. | 1,836. | 1,919. |
| | 48" | DS3ODSL2644821FL | 1,724. | 1,895. | 1,979. |
| | 60" | DS3ODSL2646021FL | 1,777. | 1,953. | 2,042. |
| | 66" | DS3ODSL2646621FL | 1,829. | 2,010. | 2,100. |
| | 72" | DS3ODSL2647221FL | 1,882. | 2,069. | 2,163. |

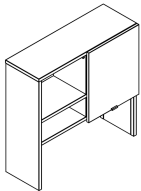

Ordering Information

Sliding Door Overdesk

1. Pattern number
2. Case finish
3. Door finish

Order Code

Sliding Door Overdesk

Example: **DS3ODSS 2643021FL, 613**

DS3ODSS Pattern Number
2643021FL

613 Silver Paint Finish

Included with:

Sliding Door Overdesk

Note: Overheads are only available in Knoll core finishes.

Options

No lock - substitute "N" for "L" at the end of pattern number, subtract \$20.

Back option for No Door units
(1) = Back covering overhead only
(2) = Back covering overhead and shelf section

Paint Configuration Option:
Add "Y" at the end of the pattern number to specify a different paint finish on the case and fronts. P3 pricing applies on all product with dual paint finishes.

Sliding Door Overdesks

64" High Cabinet with 21" High Storage (Full Height Door)

Dividends Horizon

| description | w | pattern no. | P1 | P2 | P3 |
|--|-----|-------------------------|----------|----------|----------|
| 64"h Veneer Sliding Door Overdesk with 21" Tall Cabinet | 30" | DS3ODSV2643021FL | \$1,646. | \$1,809. | \$1,890. |
| | 36" | DS3ODSV2643621FL | 1,711. | 1,879. | 1,962. |
| | 42" | DS3ODSV2644221FL | 1,775. | 1,950. | 2,036. |
| | 48" | DS3ODSV2644821FL | 1,837. | 2,021. | 2,108. |
| | 60" | DS3ODSV2646021FL | 1,902. | 2,089. | 2,184. |
| | 66" | DS3ODSV2646621FL | 1,966. | 2,162. | 2,258. |
| | 72" | DS3ODSV2647221FL | 2,030. | 2,231. | 2,329. |

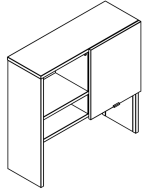

Ordering Information

Sliding Door Overdesk

1. Pattern number
2. Case finish
3. Door finish

Order Code

Sliding Door Overdesk

Example: **DS3ODSS 2643021FL,**
613

DS3ODSS Pattern Number
2643021FL

613 Silver Paint Finish

Included with:

Sliding Door Overdesk

Note: Overheads are only available
in Knoll core finishes.

Options

No lock - substitute "N" for "L" at
the end of pattern number, subtract
\$20.

Back option for No Door units
(1)= Back covering overhead only
(2) = Back covering overhead and
shelf section

Paint Configuration Option:
Add "Y" at the end of the pattern
number to specify a different paint
finish on the case and fronts. P3
pricing applies on all product with
dual paint finishes.

Sliding Door Overdesks 64" High Cabinet with 21" High Storage (Partial Height Door)

Dividends Horizon

| description | w | pattern no. | P1 | P2 | P3 |
|--|-----|---------------------------|----------|----------|----------|
| 64" h Steel Sliding Door Overdesk with 21" Tall Cabinet | 30" | DS3ODSS()643021PL | \$1,191. | \$1,309. | \$1,366. |
| | 36" | DS3ODSS()643621PL | 1,216. | 1,333. | 1,395. |
| | 42" | DS3ODSS()644221PL | 1,248. | 1,370. | 1,433. |
| | 48" | DS3ODSS()644821PL | 1,317. | 1,445. | 1,511. |
| | 60" | DS3ODSS()646021PL | 1,445. | 1,588. | 1,659. |
| | 66" | DS3ODSS()646621PL | 1,493. | 1,641. | 1,714. |
| | 72" | DS3ODSS()647221PL | 1,525. | 1,674. | 1,748. |

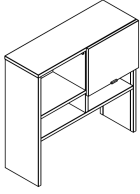

| | | | | | |
|---|-----|---------------------------|--------|--------|--------|
| 64" h Laminate Sliding Door Overdesk with 21" Tall Cabinet | 30" | DS3ODSL()643021PL | 1,557. | 1,712. | 1,788. |
| | 36" | DS3ODSL()643621PL | 1,609. | 1,769. | 1,847. |
| | 42" | DS3ODSL()644221PL | 1,662. | 1,826. | 1,907. |
| | 48" | DS3ODSL()644821PL | 1,714. | 1,882. | 1,967. |
| | 60" | DS3ODSL()646021PL | 1,766. | 1,941. | 2,028. |
| | 66" | DS3ODSL()646621PL | 1,817. | 1,998. | 2,086. |
| | 72" | DS3ODSL()647221PL | 1,869. | 2,055. | 2,147. |

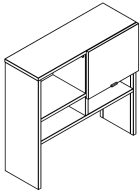

| | | | | | |
|---|-----|---------------------------|--------|--------|--------|
| 64" h Veneer Sliding Door Overdesk with 21" Tall Cabinet | 30" | DS3ODSV()643021PL | 1,634. | 1,794. | 1,875. |
| | 36" | DS3ODSV()643621PL | 1,690. | 1,860. | 1,943. |
| | 42" | DS3ODSV()644221PL | 1,751. | 1,922. | 2,009. |
| | 48" | DS3ODSV()644821PL | 1,810. | 1,988. | 2,076. |
| | 60" | DS3ODSV()646021PL | 1,867. | 2,052. | 2,142. |
| | 66" | DS3ODSV()646621PL | 1,925. | 2,116. | 2,212. |
| | 72" | DS3ODSV()647221PL | 1,984. | 2,181. | 2,280. |

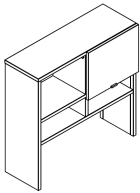

Ordering Information

Sliding Door Overdesk

1. Pattern number
2. Case finish
3. Door finish

Order Code

Sliding Door Overdesk

Example: **DS3ODSS 2643021PL, 613**

DS3ODSS Pattern Number
2643021PL

613 Silver Paint Finish

Included with:

Sliding Door Overdesk

Note: Overheads are only available in Knoll core finishes.

Options

No lock - substitute "N" for "L" at the end of pattern number, subtract \$20.

Back option

(1) = Back covering overhead only
(2) = Back covering overhead and shelf section

Paint Configuration Option:

Add "Y" at the end of the pattern number to specify a different paint finish on the case and fronts. P3 pricing applies on all product with dual paint finishes.

Sliding Door Overdesks with Tackboard

57" High Cabinet with 14" High Storage, 14" High Door

Dividends Horizon

| description | w | pattern no. | P1 | P2 | P3 |
|---|-----|------------------------|----------|----------|----------|
| 57"h Overdesk without Door with 14" Tall Cabinet with tackboard | 30" | DS3ODNS1573014T | \$1,270. | \$1,367. | \$1,412. |
| | 36" | DS3ODNS1573614T | 1,296. | 1,395. | 1,442. |
| | 42" | DS3ODNS1574214T | 1,332. | 1,432. | 1,483. |
| | 48" | DS3ODNS1574814T | 1,379. | 1,479. | 1,532. |
| | 60" | DS3ODNS1576014T | 1,491. | 1,603. | 1,658. |
| | 66" | DS3ODNS1576614T | 1,516. | 1,634. | 1,690. |
| | 72" | DS3ODNS1577214T | 1,564. | 1,681. | 1,738. |

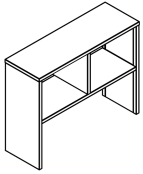

| | | | | | |
|---|-----|-------------------------|--------|--------|--------|
| 57"h Overdesk with Steel Sliding Door and 14" Tall Cabinet with tackboard | 30" | DS3ODSS1573014LT | 1,348. | 1,450. | 1,499. |
| | 36" | DS3ODSS1573614LT | 1,379. | 1,483. | 1,534. |
| | 42" | DS3ODSS1574214LT | 1,422. | 1,526. | 1,579. |
| | 48" | DS3ODSS1574814LT | 1,465. | 1,574. | 1,630. |
| | 60" | DS3ODSS1576014LT | 1,594. | 1,717. | 1,776. |
| | 66" | DS3ODSS1576614LT | 1,627. | 1,749. | 1,812. |
| | 72" | DS3ODSS1577214LT | 1,672. | 1,796. | 1,857. |

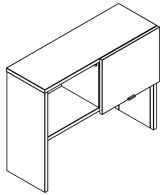

| | | | | | |
|--|-----|-------------------------|--------|--------|--------|
| 57"h Overdesk with Laminate Sliding Door and 14" Tall Cabinet with tackboard | 30" | DS3ODSL1573014LT | 1,681. | 1,816. | 1,884. |
| | 36" | DS3ODSL1573614LT | 1,724. | 1,863. | 1,933. |
| | 42" | DS3ODSL1574214LT | 1,778. | 1,922. | 1,993. |
| | 48" | DS3ODSL1574814LT | 1,826. | 1,970. | 2,043. |
| | 60" | DS3ODSL1576014LT | 1,887. | 2,036. | 2,109. |
| | 66" | DS3ODSL1576614LT | 1,922. | 2,076. | 2,153. |
| | 72" | DS3ODSL1577214LT | 1,987. | 2,144. | 2,224. |

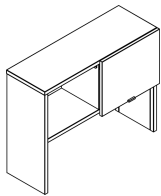

Ordering Information

Sliding Door Overdesk

1. Pattern number
2. Case finish
3. Door finish
4. Tackboard fabric

Order Code

Sliding Door Overdesk

Example: **DS3ODSS 1573014FL, 613**

DS3ODSS Pattern Number
1573014FL

613 Silver Paint Finish

Included with:

Sliding Door Overdesk

Note: Overheads are only available in Knoll core finishes.

Note: Fabric tackboard covers from top of worksurface to bottom of lower shelf.

Options

No lock - substitute "N" for "L" at the end of pattern number, subtract \$20.

Paint Configuration Option:

Add "Y" at the end of the pattern number to specify a different paint finish on the case and fronts. P3 pricing applies on all product with dual paint finishes.

Sliding Door Overdesks with Tackboard

57" High Cabinet with 14" High Storage, 14" High Door

Dividends Horizon

| description | w | pattern no. | P1 | P2 | P3 |
|---|-----|-------------------------|----------|----------|----------|
| 57" h Overdesk with Veneer Sliding Door and 14" Tall Cabinet with tackboard | 30" | DS3ODSV1573014LT | \$1,753. | \$1,897. | \$1,968. |
| | 36" | DS3ODSV1573614LT | 1,806. | 1,951. | 2,026. |
| | 42" | DS3ODSV1574214LT | 1,867. | 2,016. | 2,094. |
| | 48" | DS3ODSV1574814LT | 1,919. | 2,073. | 2,151. |
| | 60" | DS3ODSV1576014LT | 1,986. | 2,146. | 2,224. |
| | 66" | DS3ODSV1576614LT | 2,028. | 2,191. | 2,274. |
| | 72" | DS3ODSV1577214LT | 2,099. | 2,266. | 2,351. |

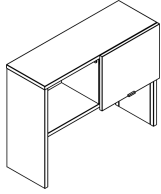

Ordering Information

Sliding Door Overdesk

1. Pattern number
2. Case finish
3. Door finish
4. Tackboard fabric

Order Code

Sliding Door Overdesk

Example: **DS3ODSS 1573014FL, 613**

DS3ODSS Pattern Number
1573014FL

613 Silver Paint Finish

Included with:

Sliding Door Overdesk

Note: Overheads are only available in Knoll core finishes.

Note: Fabric tackboard covers from top of worksurface to bottom of lower shelf.

Options

No lock - substitute "N" for "L" at the end of pattern number, subtract \$20.

Paint Configuration Option:

Add "Y" at the end of the pattern number to specify a different paint finish on the case and fronts. P3 pricing applies on all product with dual paint finishes.

Sliding Door Overdesks with Tackboard

57" High Cabinet with 21" High Storage (Full Height Door)

Dividends Horizon

| description | w | pattern no. | P1 | P2 | P3 |
|---|-----|-------------------|----------|----------|----------|
| 57"h without Sliding Door Overdesk with 21" Tall Cabinet with tackboard | 30" | DS3ODNS()573021T | \$1,251. | \$1,355. | \$1,405. |
| | 36" | DS3ODNS()573621T | 1,283. | 1,389. | 1,441. |
| | 42" | DS3ODNS()574221T | 1,327. | 1,433. | 1,487. |
| | 48" | DS3ODNS()574821T | 1,378. | 1,491. | 1,549. |
| | 60" | DS3ODNS()576021T | 1,508. | 1,633. | 1,694. |
| | 66" | DS3ODNS()576621T | 1,541. | 1,669. | 1,731. |
| | 72" | DS3ODNS()577221T | 1,591. | 1,718. | 1,786. |

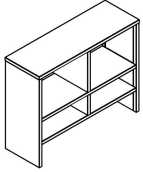

| | | | | | |
|---|-----|-------------------|--------|--------|--------|
| 57"h Steel Sliding Door Overdesk with 21" Tall Cabinet with tackboard | 30" | DS3ODSS2573021FLT | 1,398. | 1,515. | 1,572. |
| | 36" | DS3ODSS2573621FLT | 1,429. | 1,548. | 1,606. |
| | 42" | DS3ODSS2574221FLT | 1,481. | 1,603. | 1,664. |
| | 48" | DS3ODSS2574821FLT | 1,560. | 1,687. | 1,751. |
| | 60" | DS3ODSS2576021FLT | 1,713. | 1,854. | 1,925. |
| | 66" | DS3ODSS2576621FLT | 1,760. | 1,903. | 1,979. |
| | 72" | DS3ODSS2577221FLT | 1,820. | 1,967. | 2,042. |

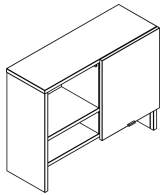

| | | | | | |
|--|-----|-------------------|--------|--------|--------|
| 57"h Laminate Sliding Door Overdesk with 21" Tall Cabinet with tackboard | 30" | DS3ODSL2573021FLT | 1,766. | 1,920. | 1,996. |
| | 36" | DS3ODSL2573621FLT | 1,826. | 1,986. | 2,064. |
| | 42" | DS3ODSL2574221FLT | 1,897. | 2,061. | 2,142. |
| | 48" | DS3ODSL2574821FLT | 1,960. | 2,129. | 2,212. |
| | 60" | DS3ODSL2576021FLT | 2,037. | 2,212. | 2,298. |
| | 66" | DS3ODSL2576621FLT | 2,089. | 2,270. | 2,358. |
| | 72" | DS3ODSL2577221FLT | 2,170. | 2,356. | 2,448. |

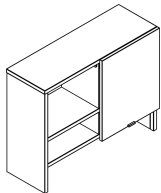

Ordering Information

Sliding Door Overdesk

1. Pattern number
2. Case finish
3. Door finish
4. Tackboard fabrics

Order Code

Sliding Door Overdesk

Example: DS3ODSS 2573021FLT, 613

DS3ODSS Pattern Number
2573021FLT

613 Silver Paint Finish

Included with:

Sliding Door Overdesk

Note: Overheads are only available in Knoll core finishes.

Note: Fabric tackboard covers from top of work surface to bottom of lower shelf.

Options

No lock - substitute "N" for "L" at the end of pattern number, subtract \$20.

Back option for No Door units
(1) = Back covering overhead only
(2) = Back covering overhead and shelf section

Paint Configuration Option:

Add "Y" at the end of the pattern number to specify a different paint finish on the case and fronts. P3 pricing applies on all product with dual paint finishes.

Sliding Door Overdesks with Tackboard

57" High Cabinet with 21" High Storage (Full Height Door)

Dividends Horizon

| description | w | pattern no. | P1 | P2 | P3 |
|--|-----|--------------------------|----------|----------|----------|
| 57" h Veneer Sliding Door Overdesk with 21" Tall Cabinet with tackboard | 30" | DS3ODSV2573021FLT | \$1,846. | \$2,006. | \$2,086. |
| | 36" | DS3ODSV2573621FLT | 1,917. | 2,084. | 2,169. |
| | 42" | DS3ODSV2574221FLT | 2,001. | 2,176. | 2,260. |
| | 48" | DS3ODSV2574821FLT | 2,073. | 2,253. | 2,343. |
| | 60" | DS3ODSV2576021FLT | 2,163. | 2,348. | 2,442. |
| | 66" | DS3ODSV2576621FLT | 2,226. | 2,419. | 2,515. |
| | 72" | DS3ODSV2577221FLT | 2,319. | 2,519. | 2,618. |

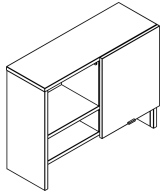

Ordering Information

Sliding Door Overdesk

1. Pattern number
2. Case finish
3. Door finish
4. Tackboard fabrics

Order Code

Sliding Door Overdesk

Example: **DS3ODSS 2573021FLT, 613**

DS3ODSS Pattern Number
2573021FLT

613 Silver Paint Finish

Included with:

Sliding Door Overdesk

Note: Overheads are only available in Knoll core finishes.

Note: Fabric tackboard covers from top of worksurface to bottom of lower shelf.

Options

No lock - substitute "N" for "L" at the end of pattern number, subtract \$20.

Back option for No Door units
(1) = Back covering overhead only
(2) = Back covering overhead and shelf section

Paint Configuration Option:
Add "Y" at the end of the pattern number to specify a different paint finish on the case and fronts. P3 pricing applies on all product with dual paint finishes.

Sliding Door Overdesks with Tackboard

57" High Cabinet with 21" High Storage (Partial Height Door)

Dividends Horizon

| description | w | pattern no. | P1 | P2 | P3 |
|--|-----|----------------------------|----------|----------|----------|
| 57" h Steel Sliding Door Overdesk with 21" Tall Cabinet with tackboard | 36" | DS3ODSS()573021PLT | \$1,429. | \$1,548. | \$1,606. |
| | 36" | DS3ODSS()573621PLT | 1,429. | 1,548. | 1,606. |
| | 42" | DS3ODSS()574221PLT | 1,481. | 1,603. | 1,664. |
| | 48" | DS3ODSS()574821PLT | 1,560. | 1,687. | 1,751. |
| | 60" | DS3ODSS()576021PLT | 1,713. | 1,854. | 1,925. |
| | 66" | DS3ODSS()576621PLT | 1,760. | 1,903. | 1,979. |
| | 72" | DS3ODSS()577221PLT | 1,820. | 1,967. | 2,042. |

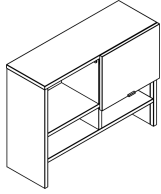

| | | | | | |
|---|-----|----------------------------|--------|--------|--------|
| 57" h Laminate Sliding Door Overdesk with 21" Tall Cabinet with tackboard | 30" | DS3ODSL()573021PLT | 1,758. | 1,908. | 1,985. |
| | 36" | DS3ODSL()573621PLT | 1,817. | 1,976. | 2,052. |
| | 42" | DS3ODSL()574221PLT | 1,888. | 2,049. | 2,131. |
| | 48" | DS3ODSL()574821PLT | 1,948. | 2,115. | 2,201. |
| | 60" | DS3ODSL()576021PLT | 2,028. | 2,198. | 2,285. |
| | 66" | DS3ODSL()576621PLT | 2,078. | 2,256. | 2,345. |
| | 72" | DS3ODSL()577221PLT | 2,158. | 2,342. | 2,434. |

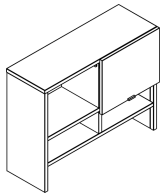

| | | | | | |
|---|-----|----------------------------|--------|--------|--------|
| 57" h Veneer Sliding Door Overdesk with 21" Tall Cabinet with tackboard | 30" | DS3ODSV()573021PLT | 1,834. | 1,994. | 2,073. |
| | 36" | DS3ODSV()573621PLT | 1,899. | 2,064. | 2,146. |
| | 42" | DS3ODSV()574221PLT | 1,975. | 2,148. | 2,234. |
| | 48" | DS3ODSV()574821PLT | 2,044. | 2,221. | 2,310. |
| | 60" | DS3ODSV()576021PLT | 2,128. | 2,310. | 2,402. |
| | 66" | DS3ODSV()576621PLT | 2,186. | 2,373. | 2,469. |
| | 72" | DS3ODSV()577221PLT | 2,273. | 2,469. | 2,567. |

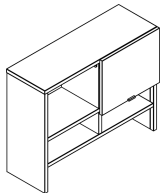

| Ordering Information | Order Code | Included with: | Options |
|--|--|---|--|
| Sliding Door Overdesk 1. Pattern number 2. Case finish 3. Door finish 4. Tackboard fabric | Sliding Door Overdesk <i>Example:</i> DS3ODSS 2573021PLF, 613 <hr/> DS3ODSS Pattern Number 2573021PLF <hr/> 613 Silver Paint Finish | Sliding Door Overdesk Note: Overheads are only available in Knoll core finishes. Note: Fabric tackboard covers from top of worksurface to bottom of lower shelf. | No lock - substitute "N" for "L" at the end of pattern number, subtract \$20. Back option for No Door units (1) = Back covering overhead only (2) = Back covering overhead and shelf section Paint Configuration Option: Add "Y" at the end of the pattern number to specify a different paint finish on the case and fronts. P3 pricing applies on all product with dual paint finishes. |

Sliding Door Overdesks with Tackboard

64" High Cabinet with 14" High Storage

Dividends Horizon

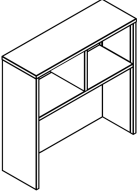
| description | w | pattern no. | P1 | P2 | P3 |
|--|-----|------------------------|----------|----------|----------|
|  64" h without Sliding Door Overdesk with 14" Tall Cabinet with tackboard | 30" | DS3ODNS1643014T | \$1,334. | \$1,433. | \$1,481. |
| | 36" | DS3ODNS1643614T | 1,351. | 1,450. | 1,499. |
| | 42" | DS3ODNS1644214T | 1,403. | 1,503. | 1,554. |
| | 48" | DS3ODNS1644814T | 1,504. | 1,613. | 1,668. |
| | 60" | DS3ODNS1646014T | 1,565. | 1,679. | 1,735. |
| | 66" | DS3ODNS1646614T | 1,591. | 1,708. | 1,765. |
| | 72" | DS3ODNS1647214T | 1,639. | 1,757. | 1,814. |

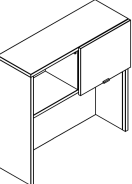
| | | | | | |
|--|-----|-------------------------|--------|--------|--------|
|  64" h Steel Sliding Door Overdesk with 14" Tall Cabinet with tackboard | 30" | DS3ODSS1643014LT | 1,389. | 1,490. | 1,541. |
| | 36" | DS3ODSS1643614LT | 1,420. | 1,525. | 1,575. |
| | 42" | DS3ODSS1644214LT | 1,463. | 1,569. | 1,622. |
| | 48" | DS3ODSS1644814LT | 1,508. | 1,619. | 1,676. |
| | 60" | DS3ODSS1646014LT | 1,641. | 1,763. | 1,824. |
| | 66" | DS3ODSS1646614LT | 1,675. | 1,798. | 1,861. |
| | 72" | DS3ODSS1647214LT | 1,720. | 1,846. | 1,906. |

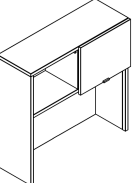
| | | | | | |
|---|-----|-------------------------|--------|--------|--------|
|  64" h Laminate Sliding Door Overdesk with 14" Tall Cabinet with tackboard | 30" | DS3ODSL1643014LT | 1,722. | 1,858. | 1,927. |
| | 36" | DS3ODSL1643614LT | 1,768. | 1,906. | 1,975. |
| | 42" | DS3ODSL1644214LT | 1,825. | 1,968. | 2,040. |
| | 48" | DS3ODSL1644814LT | 1,872. | 2,021. | 2,095. |
| | 60" | DS3ODSL1646014LT | 1,938. | 2,086. | 2,164. |
| | 66" | DS3ODSL1646614LT | 1,974. | 2,129. | 2,207. |
| | 72" | DS3ODSL1647214LT | 2,042. | 2,202. | 2,280. |

Ordering Information

Sliding Door Overdesk

1. Pattern number
2. Case finish
3. Door finish
4. Tackboard fabric

Order Code

Sliding Door Overdesk

Example: **DS3ODSS 2643014FLT, 613**

DS3ODSS Pattern Number
2643014FLT

613 Silver Paint Finish

Included with:

Sliding Door Overdesk

Note: Overheads are only available in Knoll core finishes.

Note: Fabric tackboard covers from top of worksurface to bottom of lower shelf.

Options

No lock - substitute "N" for "L" at the end of pattern number, subtract \$20.

Paint Configuration Option:

Add "Y" at the end of the pattern number to specify a different paint finish on the case and fronts. P3 pricing applies on all product with dual paint finishes.

Sliding Door Overdesks with Tackboard

64" High Cabinet with 14" High Storage

Dividends Horizon

| description | w | pattern no. | P1 | P2 | P3 |
|---|-----|-------------------------|----------|----------|----------|
| 64"h Veneer Sliding Door Overdesk with 14" Tall Cabinet with tackboard | 30" | DS3ODSV1643014LT | \$1,797. | \$1,941. | \$2,013. |
| | 36" | DS3ODSV1643614LT | 1,848. | 1,997. | 2,071. |
| | 42" | DS3ODSV1644214LT | 1,914. | 2,064. | 2,141. |
| | 48" | DS3ODSV1644814LT | 1,967. | 2,122. | 2,202. |
| | 60" | DS3ODSV1646014LT | 2,037. | 2,198. | 2,279. |
| | 66" | DS3ODSV1646614LT | 2,081. | 2,245. | 2,328. |
| | 72" | DS3ODSV1647214LT | 2,157. | 2,324. | 2,412. |

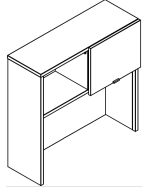

Ordering Information

Sliding Door Overdesk

1. Pattern number
2. Case finish
3. Door finish
4. Tackboard fabric

Order Code

Sliding Door Overdesk

Example: **DS3ODSS 2643014FLT, 613**

DS3ODSS Pattern Number
2643014FLT

613 Silver Paint Finish

Included with:

Sliding Door Overdesk

Note: Overheads are only available in Knoll core finishes.

Note: Fabric tackboard covers from top of worksurface to bottom of lower shelf.

Options

No lock - substitute "N" for "L" at the end of pattern number, subtract \$20.

Paint Configuration Option:

Add "Y" at the end of the pattern number to specify a different paint finish on the case and fronts. P3 pricing applies on all product with dual paint finishes.

Sliding Door Overdesks with Tackboard

64" High Cabinet with 21" High Storage (Full Height Door)

Dividends Horizon

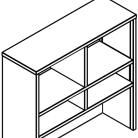
| description | w | pattern no. | P1 | P2 | P3 |
|---|-----|--------------------------|----------|----------|----------|
|  64"h without Sliding Door Overdesk with 21" Tall Cabinet with tackboard | 30" | DS3ODNS()643021T | \$1,367. | \$1,473. | \$1,525. |
| | 36" | DS3ODNS()643621T | 1,392. | 1,499. | 1,552. |
| | 42" | DS3ODNS()644221T | 1,436. | 1,549. | 1,606. |
| | 48" | DS3ODNS()644821T | 1,518. | 1,634. | 1,693. |
| | 60" | DS3ODNS()646021T | 1,656. | 1,785. | 1,851. |
| | 66" | DS3ODNS()646621T | 1,698. | 1,829. | 1,898. |
| | 72" | DS3ODNS()647221T | 1,757. | 1,894. | 1,961. |

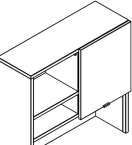
| | | | | | |
|---|-----|--------------------------|--------|--------|--------|
|  64"h Steel Sliding Door Overdesk with 21" Tall Cabinet with tackboard | 30" | DS3ODSS2643021FLT | 1,499. | 1,616. | 1,673. |
| | 36" | DS3ODSS2643621FLT | 1,531. | 1,648. | 1,710. |
| | 42" | DS3ODSS2644221FLT | 1,581. | 1,704. | 1,766. |
| | 48" | DS3ODSS2644821FLT | 1,659. | 1,788. | 1,854. |
| | 60" | DS3ODSS2646021FLT | 1,813. | 1,956. | 2,027. |
| | 66" | DS3ODSS2646621FLT | 1,861. | 2,008. | 2,081. |
| | 72" | DS3ODSS2647221FLT | 1,921. | 2,071. | 2,144. |

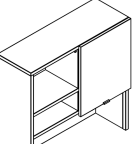
| | | | | | |
|--|-----|--------------------------|--------|--------|--------|
|  64"h Laminate Sliding Door Overdesk with 21" Tall Cabinet with tackboard | 30" | DS3ODSL2643021FLT | 1,875. | 2,030. | 2,107. |
| | 36" | DS3ODSL2643621FLT | 1,934. | 2,095. | 2,174. |
| | 42" | DS3ODSL2644221FLT | 2,005. | 2,169. | 2,252. |
| | 48" | DS3ODSL2644821FLT | 2,068. | 2,238. | 2,322. |
| | 60" | DS3ODSL2646021FLT | 2,144. | 2,320. | 2,409. |
| | 66" | DS3ODSL2646621FLT | 2,198. | 2,378. | 2,467. |
| | 72" | DS3ODSL2647221FLT | 2,279. | 2,465. | 2,559. |

Ordering Information

Sliding Door Overdesk

1. Pattern number
2. Case finish
3. Door finish
4. Tackboard fabric

Order Code

Sliding Door Overdesk

Example: **DS3ODSS 2643021FLT, 613**

DS3ODSS Pattern Number
2643021FLT

613 Silver Paint Finish

Included with:

Sliding Door Overdesk

Note: Overheads are only available in Knoll core finishes.

Note: Fabric tackboard covers from top of worksurface to bottom of lower shelf.

Options

No lock - substitute "N" for "L" at the end of pattern number, subtract \$20.

Back option for No Door units
(1) = Back covering overhead only
(2) = Back covering overhead and shelf section

Paint Configuration Option:

Add "Y" at the end of the pattern number to specify a different paint finish on the case and fronts. P3 pricing applies on all product with dual paint finishes.

Sliding Door Overdesks with Tackboard

64" High Cabinet with 21" High Storage (Full Height Door)

Dividends Horizon

| description | w | pattern no. | P1 | P2 | P3 |
|--|-----|--------------------------|----------|----------|----------|
| 64" h Veneer Sliding Door Overdesk with 21" Tall Cabinet with tackboard | 30" | DS3ODSV2643021FLT | \$1,954. | \$2,115. | \$2,198. |
| | 36" | DS3ODSV2643621FLT | 2,026. | 2,193. | 2,278. |
| | 42" | DS3ODSV2644221FLT | 2,108. | 2,283. | 2,369. |
| | 48" | DS3ODSV2644821FLT | 2,180. | 2,363. | 2,451. |
| | 60" | DS3ODSV2646021FLT | 2,270. | 2,456. | 2,551. |
| | 66" | DS3ODSV2646621FLT | 2,333. | 2,529. | 2,626. |
| | 72" | DS3ODSV2647221FLT | 2,426. | 2,628. | 2,725. |

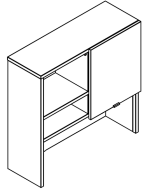

Ordering Information

Sliding Door Overdesk

1. Pattern number
2. Case finish
3. Door finish
4. Tackboard fabric

Order Code

Sliding Door Overdesk

Example: **DS3ODSS 2643021FLT, 613**

DS3ODSS Pattern Number
2643021FLT

613 Silver Paint Finish

Included with:

Sliding Door Overdesk

Note: Overheads are only available in Knoll core finishes.

Note: Fabric tackboard covers from top of worksurface to bottom of lower shelf.

Options

No lock - substitute "N" for "L" at the end of pattern number, subtract \$20.

Back option for No Door units
(1) = Back covering overhead only
(2) = Back covering overhead and shelf section

Paint Configuration Option:
Add "Y" at the end of the pattern number to specify a different paint finish on the case and fronts. P3 pricing applies on all product with dual paint finishes.

Sliding Door Overdesks with Tackboard

64" High Cabinet with 21" High Storage (Partial Height Door)

Dividends Horizon

| description | w | pattern no. | P1 | P2 | P3 |
|--|-----|----------------------------|----------|----------|----------|
| 64"h Steel Sliding Door Overdesk with 21" Tall Cabinet with tackboard | 30" | DS3ODSS()643021PLT | \$1,499. | \$1,616. | \$1,673. |
| | 36" | DS3ODSS()643621PLT | 1,531. | 1,648. | 1,710. |
| | 42" | DS3ODSS()644221PLT | 1,581. | 1,704. | 1,766. |
| | 48" | DS3ODSS()644821PLT | 1,659. | 1,788. | 1,854. |
| | 60" | DS3ODSS()646021PLT | 1,813. | 1,956. | 2,027. |
| | 66" | DS3ODSS()646621PLT | 1,861. | 2,008. | 2,081. |
| | 72" | DS3ODSS()647221PLT | 1,921. | 2,071. | 2,144. |

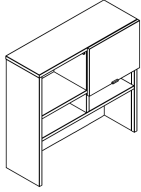

| | | | | | |
|---|-----|----------------------------|--------|--------|--------|
| 64"h Laminate Sliding Door Overdesk with 21" Tall Cabinet with tackboard | 30" | DS3ODSL()643021PLT | 1,864. | 2,020. | 2,096. |
| | 36" | DS3ODSL()643621PLT | 1,924. | 2,083. | 2,162. |
| | 42" | DS3ODSL()644221PLT | 1,995. | 2,159. | 2,241. |
| | 48" | DS3ODSL()644821PLT | 2,057. | 2,225. | 2,310. |
| | 60" | DS3ODSL()646021PLT | 2,134. | 2,309. | 2,395. |
| | 66" | DS3ODSL()646621PLT | 2,184. | 2,365. | 2,454. |
| | 72" | DS3ODSL()647221PLT | 2,265. | 2,451. | 2,543. |

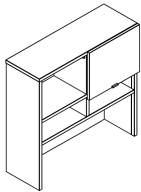

| | | | | | |
|---|-----|----------------------------|--------|--------|--------|
| 64"h Veneer Sliding Door Overdesk with 21" Tall Cabinet with tackboard | 30" | DS3ODSV()643021PLT | 1,941. | 2,102. | 2,182. |
| | 36" | DS3ODSV()643621PLT | 2,005. | 2,175. | 2,258. |
| | 42" | DS3ODSV()644221PLT | 2,084. | 2,255. | 2,343. |
| | 48" | DS3ODSV()644821PLT | 2,152. | 2,331. | 2,419. |
| | 60" | DS3ODSV()646021PLT | 2,235. | 2,420. | 2,510. |
| | 66" | DS3ODSV()646621PLT | 2,292. | 2,485. | 2,579. |
| | 72" | DS3ODSV()647221PLT | 2,381. | 2,577. | 2,676. |

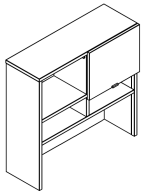

| Ordering Information | Order Code | Included with: | Options |
|--|--|---|--|
| Sliding Door Overdesk 1. Pattern number 2. Case finish 3. Door finish 4. Tackboard fabric | Sliding Door Overdesk <i>Example:</i> DS3ODSS 2643021PLT, 613 <hr/> DS3ODSS Pattern Number 2643021PLT <hr/> 613 Silver Paint Finish | Sliding Door Overdesk Note: Overheads are only available in Knoll core finishes. Note: Fabric tackboard covers from top of worksurface to bottom of lower shelf. | No lock - substitute "N" for "L" at the end of pattern number, subtract \$20. Back option for No Door units (1) = Back covering overhead only (2) = Back covering overhead and shelf section Paint Configuration Option: Add "Y" at the end of the pattern number to specify a different paint finish on the case and fronts. P3 pricing applies on all product with dual paint finishes. |

This page intentionally left blank

Available Worksurface Styles

- Rectangular
- Rectilinear corner
- Split top corner
- Curvilinear corner
- Trapezoid
- Smooth wave
- Curvilinear wave end
- Half-round
- Quarter-round
- Blended "D" shape
- "D" shape peninsula
- "P" and "G" shape peninsula
- Counter Worksurfaces
- Transition

Universal Applications

The undersides of worksurfaces are pre-drilled to accept various panel-hung and freestanding supports. Cascade edge worksurfaces do not have pre-drilled holes.

All supports must be ordered separately.

In panel-hung applications, worksurfaces are supported by:

- Cantilevers
- Pedestals
- Panel-to-worksurface brackets
- Flat brackets
- Panel-mounted C-leg support
- Open support legs

In peninsula applications, worksurfaces are supported by panels on one end and the other end is supported by:

- Support column
- A leg
- T support base

For freestanding applications, worksurface support is provided by:

- Pedestals
- End units
- Flat brackets

Construction

Laminate

- Surface material: .028 high-pressure laminate on top surface with a paper backer on under side
- Edge material: 2mm ABS on straight and curved surfaces
- Core material: 45 lb. density particle board
- Thickness: 1 1/4"

Techwood

- Surface material: 0.6mm veneer
- Edge material: 0.6mm veneer on straight and curved surfaces
- Core material: 45 lb. density particle board
- Thickness: 1 1/4"

For available sizes, refer to the individual worksurface categories within this section.

Optional Edge Grommets

Edge grommets are optional and can be specified factory-installed centered along the

rear edge of rectangular, rectilinear corner, curvilinear wave end, and curvilinear corner worksurfaces. Grommets can also be retrofitted to worksurfaces by ordering an edge grommet kit (pattern number D1WSG). The edge grommet kit allows grommets to be field-installed in any location along the rear edge of worksurfaces.

Note: Edge grommets on 'D', 'G', and 'P' peninsula worksurfaces are located on the panel hung side.

Cable Management

A 1/2" reveal is provided between the worksurface and panel for cable management. When edge grommets are specified, the grommet works in conjunction with the 1/2" reveal to allow plugs to be inserted through the grommet and cables to be positioned anywhere along the rear edge of the worksurface.

Loading Capacities

Maximum weight allowed for worksurfaces:

- 24"-42" wide: 200 lbs.
- 48" wide: 216 lbs.
- 54" wide: 243 lbs.
- 60" wide: 270 lbs.
- 66" wide: 297 lbs.
- 72" wide: 324 lbs.
- 78" wide: 351 lbs.
- 84" wide: 378 lbs.
- 90" wide: 405 lbs.
- 96" wide: 432 lbs.

Note: Installations which violate these requirements will not be covered by the Knoll, Inc. warranty.

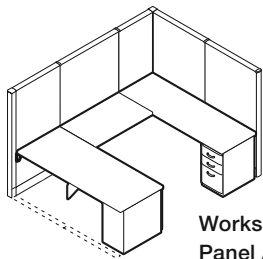

Worksurfaces and Supports, Panel Application

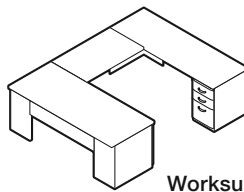

Worksurfaces and Supports, Freestanding Application

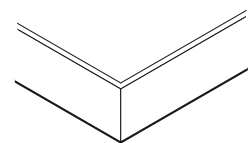

2mm ABS Edge Detail

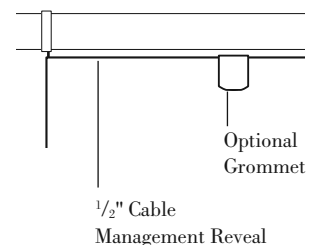
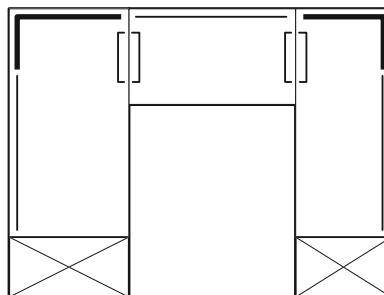
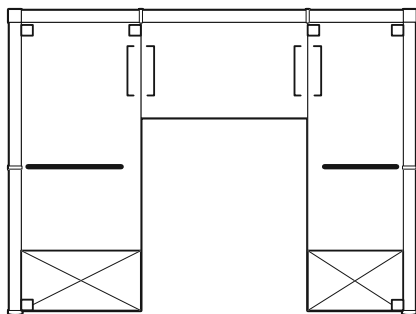

Worksurface Cable Management

Laminate Worksurface Grain Direction

The standard grain direction for wood grain or brushed laminates for each worksurface shape is shown below.

When wood grain or brushed laminates are specified on Dividends Horizon corner worksurfaces, a left, right or diagonal grain direction option must be specified as shown below. Insert the desired grain direction option (L, R or D) after the laminate finish code. The diagonal option is an upcharge. This option applies only to corner worksurfaces with the same dimension on each rear side.

Techwood Worksurface Grain Direction

The standard grain direction for Techwood worksurfaces for each worksurface shape is shown below.

Techwood corner worksurfaces with the same dimension on each rear side have a diagonal grain direction.

Laminate Worksurface Grain Direction

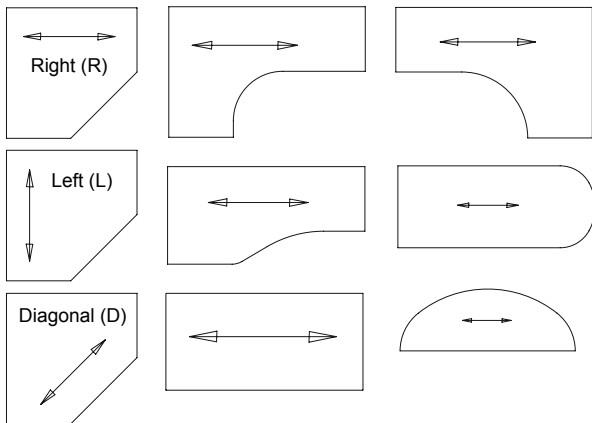

Techwood Worksurface Grain Direction

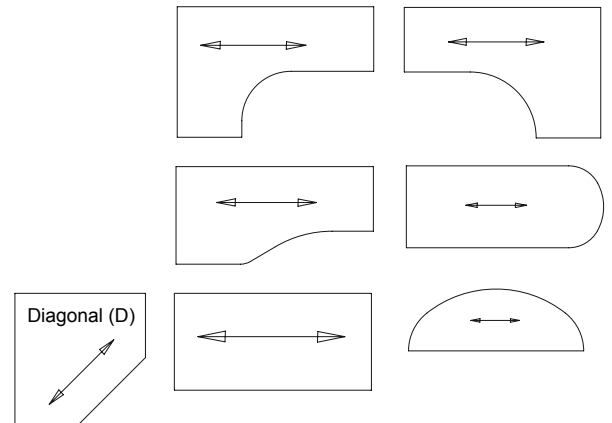

Panel-Hung Worksurface Support

All worksurfaces require support every 48" in width. In panel-hung applications, mid-span support must be provided by cantilevers, panel-mounted C-legs or open support legs.

When worksurfaces are mounted perpendicular to panels, the worksurface depth must equal the width of the panel when using panel-to-worksurface brackets.

Cantilevers are available in three depths to match worksurface depths.

- 18" deep worksurfaces are supported by 18" deep cantilevers.
- 24" deep worksurfaces are supported by 24" deep cantilevers.
- 30" deep worksurfaces are not recommended to be supported by cantilevers. 30" deep cantilevers are used for mid-span support.
- 36" deep worksurfaces cannot be supported by cantilevers.

Panel-mounted C-leg supports are available to support 24" and 30" worksurface depths in heavier worksurface load applications.

Open support legs are available to support 18", 24" and 30" worksurfaces depths.

Freestanding Worksurface Support

For freestanding desk applications, specify freestanding pedestals, end units and/or intermediate support every 48" in width.

- 18" deep worksurfaces can be supported by 18" deep pedestals and end units only
- 24" deep worksurfaces can be supported by either 18" or 24" deep pedestals or end units
- 30" deep worksurfaces can be supported by either 24" or 30" deep pedestals or end units
- 36" deep worksurfaces can only be supported by 30" deep pedestals or end units and provide a 6" front overhang for desk applications.

Maximum Width Between Panel-Hung Worksurface Supports

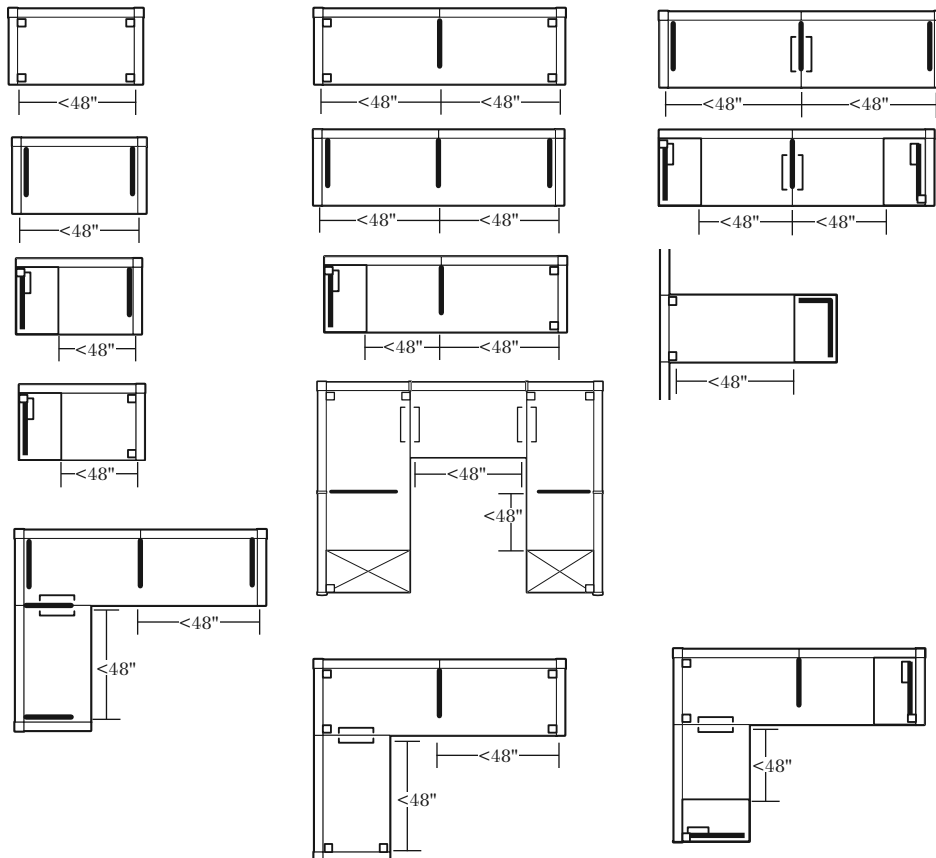

Maximum Width Between Freestanding Worksurface Supports

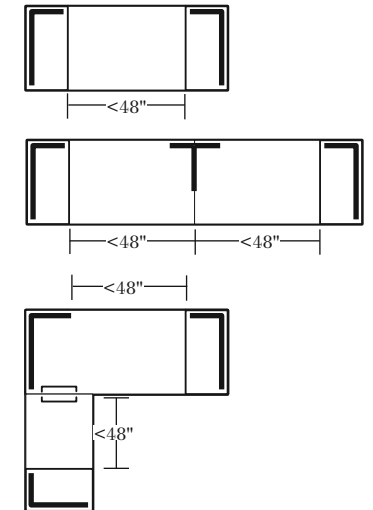









Worksurface Reinforcement

Worksurface reinforcements are required for worksurface spans greater than 48 inches. This includes freestanding desk worksurfaces over 48 inches using desk end units. Worksurface reinforcements have a black paint finish.

Notes:

- Whenever using pedestals they should be connected to panels with panel-to-worksurface brackets
- Panel runs must be floor-supported every 8 feet (i.e., pedestal with panel-to-worksurface brackets or panel-mounted C-leg)
- When a panel mounted C-leg is used, unsupported worksurface span is not to exceed 48".

Legend

-  Pedestal or End Unit
-  Panel Mounted C-leg Support
-  Cantilever or C-leg
-  Flat Bracket
-  Flat Bracket with Cantilever or Shared C-leg
-  Panel-to-worksurface Bracket
-  Pedestal or C-leg
-  End Unit
-  Intermediate

Worksurface Reinforcement Panel Hung Application

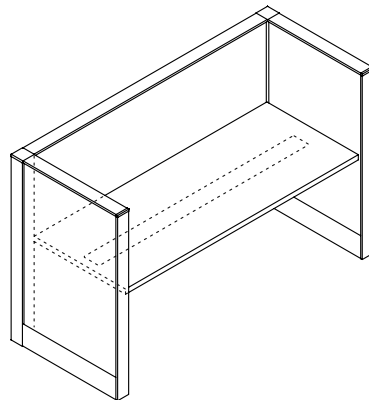
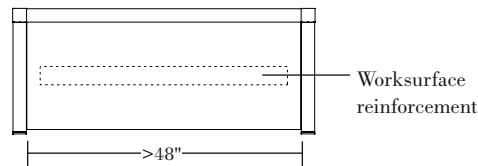

Worksurface Reinforcement Freestanding Desk Application

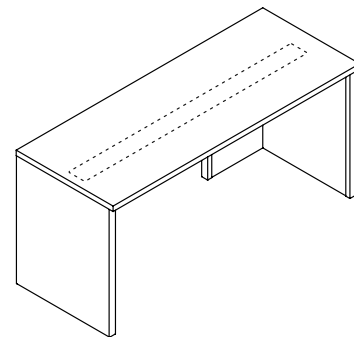
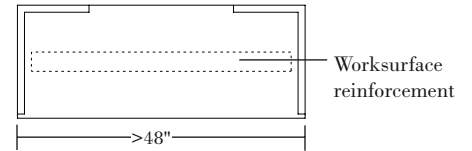

Rectangular Worksurfaces

18" and 24" Deep Specifications

Rectangular Worksurfaces

Dividends Horizon rectangular worksurfaces are universal and may be used in:

- Panel-hung applications
- Freestanding applications

Available Sizes

- Depths: 18" and 24"
- Widths: 24" to 96"

Panel-Hung Applications

When a worksurface spans multiple panels a cantilever or freestanding support is required every 48" of width.

Freestanding Applications

Rectangular worksurfaces in "build-to-spec" applications use pedestals and end units as the primary support for freestanding desks. Back panels are optional and can be specified as required.

The most common freestanding applications involve desks, returns and bridge units in "L" and "U" configurations.

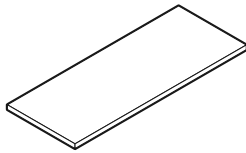

24"D Rectangular Worksurface

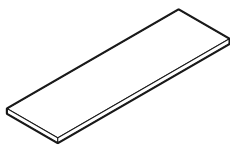

18"D Rectangular Worksurface

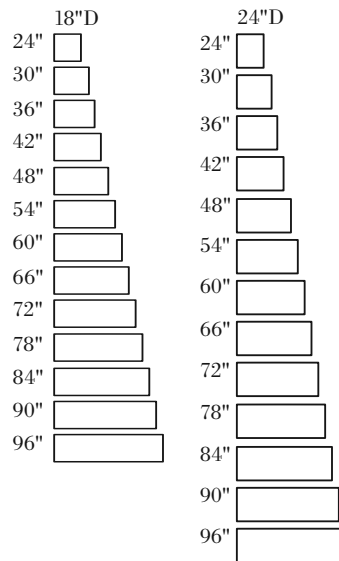

Rectangular Sizes Available

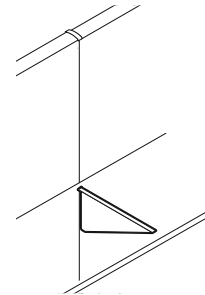

Worksurfaces over 48" W require mid-span support

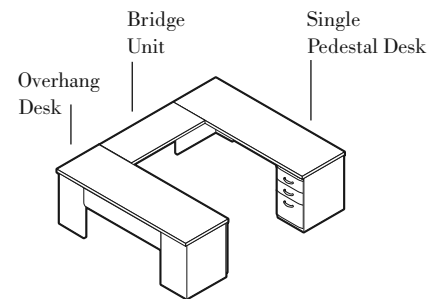
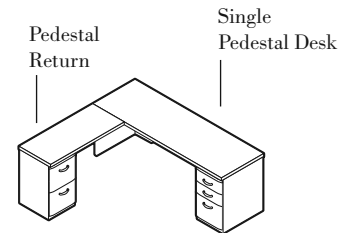



Freestanding Desk Applications

Rectangular Worksurfaces

18" and 24" Deep

Dividends Horizon

| description | w * | w | d | t | pattern no. | lamine w/ ABS edge | lamine w/ woodgrain edge | lamine w/ metal edge | techwood w/ techwood edge |
|--|-----------|-----------|---------|------------------|------------------|--------------------------|--------------------------------|----------------------------|---------------------------------|
| 18" Deep Rectangular No Grommets  | 24" | 23 13/16" | 17 1/2" | 1 1/4" | D1R 2418N | \$168. | \$184. | \$201. | \$412. |
| | 30" | 29 13/16" | 17 1/2" | 1 1/4" | D1R 3018N | 177. | 195. | 213. | 434. |
| | 36" | 35 13/16" | 17 1/2" | 1 1/4" | D1R 3618N | 198. | 218. | 239. | 454. |
| | 42" | 41 13/16" | 17 1/2" | 1 1/4" | D1R 4218N | 229. | 252. | 273. | 476. |
| | 48" | 47 13/16" | 17 1/2" | 1 1/4" | D1R 4818N | 255. | 280. | 307. | 497. |
| | 54" | 53 13/16" | 17 1/2" | 1 1/4" | D1R 5418N | 271. | 298. | 326. | 513. |
| | 60" | 59 13/16" | 17 1/2" | 1 1/4" | D1R 6018N | 295. | 324. | 354. | 534. |
| | 66" | 65 13/16" | 17 1/2" | 1 1/4" | D1R 6618N | 318. | 350. | 381. | 554. |
| | 72" | 71 13/16" | 17 1/2" | 1 1/4" | D1R 7218N | 334. | 368. | 402. | 574. |
| | 78" | 77 13/16" | 17 1/2" | 1 1/4" | D1R 7818N | 360. | 395. | 432. | 597. |
| | 84" | 83 13/16" | 17 1/2" | 1 1/4" | D1R 8418N | 379. | 416. | 453. | 620. |
| | 90" | 89 13/16" | 17 1/2" | 1 1/4" | D1R 9018N | 422. | 465. | 503. | 644. |
| 96" | 95 13/16" | 17 1/2" | 1 1/4" | D1R 9618N | 467. | 511. | 559. | 668. | |
| 24" Deep Rectangular No Grommets  | 24" | 23 13/16" | 23 1/2" | 1 1/4" | D1R 2424N | 178. | 197. | 215. | 425. |
| | 30" | 29 13/16" | 23 1/2" | 1 1/4" | D1R 3024N | 206. | 224. | 244. | 450. |
| | 36" | 35 13/16" | 23 1/2" | 1 1/4" | D1R 3624N | 227. | 249. | 271. | 473. |
| | 42" | 41 13/16" | 23 1/2" | 1 1/4" | D1R 4224N | 260. | 285. | 315. | 499. |
| | 48" | 47 13/16" | 23 1/2" | 1 1/4" | D1R 4824N | 290. | 321. | 351. | 523. |
| | 54" | 53 13/16" | 23 1/2" | 1 1/4" | D1R 5424N | 316. | 347. | 378. | 550. |
| | 60" | 59 13/16" | 23 1/2" | 1 1/4" | D1R 6024N | 342. | 374. | 407. | 578. |
| | 66" | 65 13/16" | 23 1/2" | 1 1/4" | D1R 6624N | 367. | 404. | 441. | 602. |
| | 72" | 71 13/16" | 23 1/2" | 1 1/4" | D1R 7224N | 383. | 423. | 461. | 629. |
| | 78" | 77 13/16" | 23 1/2" | 1 1/4" | D1R 7824N | 412. | 452. | 493. | 659. |
| | 84" | 83 13/16" | 23 1/2" | 1 1/4" | D1R 8424N | 436. | 482. | 524. | 687. |
| | 90" | 89 13/16" | 23 1/2" | 1 1/4" | D1R 9024N | 492. | 539. | 590. | 716. |
| 96" | 95 13/16" | 23 1/2" | 1 1/4" | D1R 9624N | 535. | 591. | 645. | 743. | |

w* = nominal width

Dimensions listed under w d t are actual to the nearest 1/16"

Ordering Information

Worksurfaces

1. Pattern Number
2. Top Finish Type
3. Edge Finish

Order Code

Worksurfaces

Example: **D1R 4818N, 114, 114**

D1R Pattern Number
4818N

114 Folkstone Grey
Laminate

114 Folkstone Grey Edge
Band

Included with:

Worksurfaces

Note: An upcharge applies when specifying Legacy laminates. See Legacy finish page.

Options

Worksurfaces

- Center-Located Edge Grommet
- Woodgrain ABS edge
- Metal edge
- Techwood edge

To specify edge grommet, replace the "N" suffix from the pattern number with "G".
Add \$18.

Rectangular Worksurfaces

19" Deep Specifications

Rectangular Worksurfaces

The 19" deep rectangular worksurface aligns with the depth of a doublewide pedestal.

Dividends Horizon worksurfaces provide a 1/2" reveal between the worksurface and panel for cable management.

Dividends Horizon 19" deep rectangular worksurfaces are universal and may be used in:

- Panel-hung applications
- Freestanding applications

Available Sizes

- Depths: 19"
- Widths: 24" to 96"

Panel-Hung Applications

When a worksurface spans multiple panels, a cantilever or freestanding support is required every 48" of width.

Freestanding Applications

Rectangular worksurfaces in "build-to-spec" applications use pedestals and end units as the primary support for freestanding desks. Back panels are optional and can be specified as required.

The most common freestanding applications involve desks, returns and bridge units in "L" and "U" configurations.

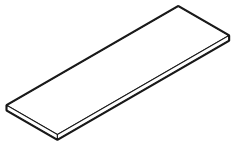

19"D Rectangular Worksurface

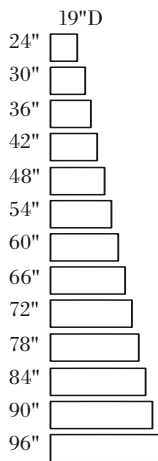

Rectangular Sizes Available

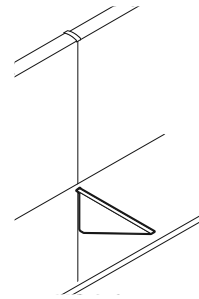

Worksurfaces over 48" W require mid-span support

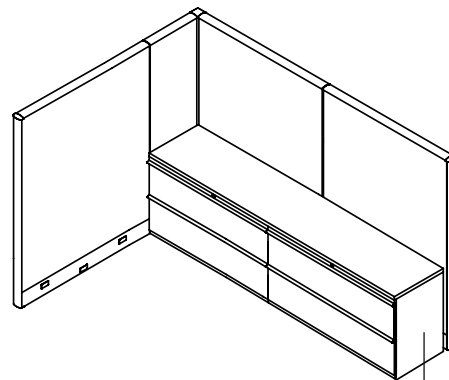

19" Deep Worksurface Application

Doublewide Pedestal

Rectangular Worksurfaces

19" Deep

Dividends Horizon

| description | w* | w | d | t | pattern no. | laminate w/ ABS edge | laminate w/ woodgrain edge | laminate w/ metal edge | techwood w/ techwood edge |
|---|-----|----------------------|--------------------|-------------------|-----------------|----------------------------|----------------------------------|------------------------------|---------------------------------|
| 19" Deep Rectangular - No Grommets (for use with doublewide pedestals)  | 24" | 23 ^{13/16"} | 18 ^{3/4"} | 1 ^{1/4"} | D1R2419N | \$170. | \$186. | \$205. | \$414. |
| | 30" | 29 ^{13/16"} | 18 ^{3/4"} | 1 ^{1/4"} | D1R3019N | 182. | 200. | 217. | 436. |
| | 36" | 35 ^{13/16"} | 18 ^{3/4"} | 1 ^{1/4"} | D1R3619N | 205. | 223. | 243. | 459. |
| | 42" | 41 ^{13/16"} | 18 ^{3/4"} | 1 ^{1/4"} | D1R4219N | 234. | 258. | 280. | 480. |
| | 48" | 47 ^{13/16"} | 18 ^{3/4"} | 1 ^{1/4"} | D1R4819N | 260. | 286. | 314. | 501. |
| | 54" | 53 ^{13/16"} | 18 ^{3/4"} | 1 ^{1/4"} | D1R5419N | 279. | 307. | 334. | 522. |
| | 60" | 59 ^{13/16"} | 18 ^{3/4"} | 1 ^{1/4"} | D1R6019N | 303. | 332. | 364. | 541. |
| | 66" | 65 ^{13/16"} | 18 ^{3/4"} | 1 ^{1/4"} | D1R6619N | 325. | 359. | 392. | 561. |
| | 72" | 71 ^{13/16"} | 18 ^{3/4"} | 1 ^{1/4"} | D1R7219N | 345. | 378. | 413. | 583. |
| | 78" | 77 ^{13/16"} | 18 ^{3/4"} | 1 ^{1/4"} | D1R7819N | 367. | 404. | 442. | 608. |
| | 84" | 83 ^{13/16"} | 18 ^{3/4"} | 1 ^{1/4"} | D1R8419N | 390. | 428. | 467. | 631. |
| | 90" | 89 ^{13/16"} | 18 ^{3/4"} | 1 ^{1/4"} | D1R9019N | 434. | 476. | 521. | 656. |
| | 96" | 95 ^{13/16"} | 18 ^{3/4"} | 1 ^{1/4"} | D1R9619N | 478. | 526. | 575. | 681. |

w* = nominal width

Dimensions listed under w d t are actual to the nearest 1/16"

Ordering Information

Worksurfaces

1. Pattern Number
2. Top Finish Type
3. Edge Finish

Order Code

Worksurfaces

Example: **D1R 4819N, 114, 114**

D1R Pattern Number
4819N

114 Folkstone Grey
Laminate

114 Folkstone Grey Edge
Band

Included with:

Worksurfaces

Note: An upcharge applies when specifying Legacy laminates. See Legacy finish page.

Options

Worksurfaces

- Center-Located Edge Grommet
- Woodgrain ABS edge
- Metal edge
- Techwood edge

To specify edge grommet, replace the "N" suffix from the pattern number with "G".
Add \$18.

Rectangular Worksurfaces

Dividends Horizon rectangular worksurfaces are universal and can be used in:

- Panel-hung applications
- Freestanding applications

See page 166 for the following:

- Worksurface construction
- Optional edge grommets
- Loading capacities

Available Sizes

- Depths: 30" and 36"
- Widths: 24" to 96" (30"D), 60" to 72" (36"D)

Panel-Hung Applications

When a worksurface spans multiple panels a cantilever or freestanding floor support is required every 48". 36" deep worksurfaces cannot be supported by cantilevers. Worksurfaces over 48" W require mid-span support

Freestanding Applications

Refer to the freestanding desk section for "preconfigured" applications. Rectangular worksurfaces in "build-to-spec" applications use pedestals and end units as the primary support for freestanding desks. Back panels are optional and can be specified as required.

The most common freestanding applications involve desks, returns and bridge units in "L" and "U" configurations.

Overhang Desks

Overhang desks can be ordered by component by specifying desk supports and worksurfaces separately. To specify, select either a 30" or 36" deep worksurface in 60", 66" or 72" widths. Back panels should be specified to match the worksurface width while supports (pedestals or end units) should be one size smaller than the worksurface depth to provide a 6" front overhang. Example: 36" deep worksurface with 30" deep pedestals or end units.

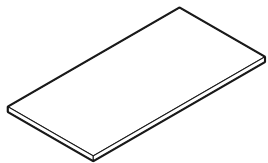

30"D Rectangular Worksurface

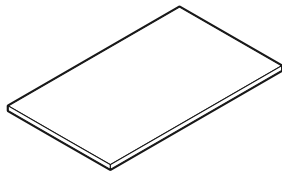

36"D Rectangular Worksurface

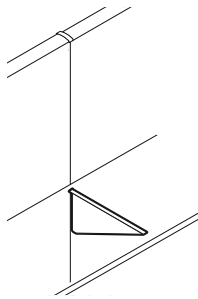

Worksurfaces over 48"W require mid-span support

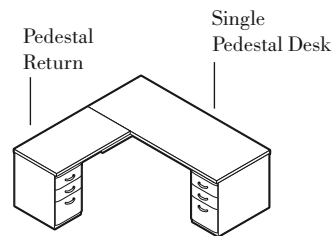
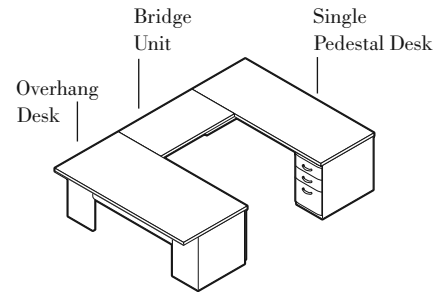



Freestanding Desk Applications

Rectangular Worksurfaces

30" and 36" Deep

Dividends Horizon

| description | w | w | d | t | pattern no. | laminate w/ ABS edge | laminate w/ woodgrain edge | laminate w/ metal edge | techwood w/ techwood edge |
|--|------------------------------------|------------------------------------|----------------------------------|---------------------------------|------------------|----------------------------|----------------------------------|---------------------------|---------------------------------|
| 30" Deep Rectangular No Grommets  | 24" | 23 ¹³ / ₁₆ " | 29 ¹ / ₂ " | 1 ¹ / ₄ " | D1R 2430N | \$228. | \$250. | \$272. | \$441. |
| | 30" | 29 ¹³ / ₁₆ " | 29 ¹ / ₂ " | 1 ¹ / ₄ " | D1R 3030N | 255. | 280. | 307. | 475. |
| | 36" | 35 ¹³ / ₁₆ " | 29 ¹ / ₂ " | 1 ¹ / ₄ " | D1R 3630N | 282. | 311. | 341. | 507. |
| | 42" | 41 ¹³ / ₁₆ " | 29 ¹ / ₂ " | 1 ¹ / ₄ " | D1R 4230N | 307. | 336. | 366. | 541. |
| | 48" | 47 ¹³ / ₁₆ " | 29 ¹ / ₂ " | 1 ¹ / ₄ " | D1R 4830N | 342. | 374. | 407. | 576. |
| | 54" | 53 ¹³ / ₁₆ " | 29 ¹ / ₂ " | 1 ¹ / ₄ " | D1R 5430N | 387. | 424. | 463. | 600. |
| | 60" | 59 ¹³ / ₁₆ " | 29 ¹ / ₂ " | 1 ¹ / ₄ " | D1R 6030N | 425. | 468. | 508. | 626. |
| | 66" | 65 ¹³ / ₁₆ " | 29 ¹ / ₂ " | 1 ¹ / ₄ " | D1R 6630N | 472. | 521. | 569. | 650. |
| | 72" | 71 ¹³ / ₁₆ " | 29 ¹ / ₂ " | 1 ¹ / ₄ " | D1R 7230N | 492. | 539. | 590. | 674. |
| | 78" | 77 ¹³ / ₁₆ " | 29 ¹ / ₂ " | 1 ¹ / ₄ " | D1R 7830N | 525. | 580. | 631. | 706. |
| | 84" | 83 ¹³ / ₁₆ " | 29 ¹ / ₂ " | 1 ¹ / ₄ " | D1R 8430N | 557. | 613. | 670. | 736. |
| | 90" | 89 ¹³ / ₁₆ " | 29 ¹ / ₂ " | 1 ¹ / ₄ " | D1R 9030N | 599. | 659. | 719. | 767. |
| 96" | 95 ¹³ / ₁₆ " | 29 ¹ / ₂ " | 1 ¹ / ₄ " | D1R 9630N | 643. | 707. | 771. | 798. | |
| 36" Deep Rectangular No Grommets  | 60" | 59 ¹³ / ₁₆ " | 35 ¹ / ₂ " | 1 ¹ / ₄ " | D1R 6036N | 544. | 598. | 652. | 742. |
| | 66" | 65 ¹³ / ₁₆ " | 35 ¹ / ₂ " | 1 ¹ / ₄ " | D1R 6636N | 601. | 663. | 721. | 768. |
| | 72" | 71 ¹³ / ₁₆ " | 35 ¹ / ₂ " | 1 ¹ / ₄ " | D1R 7236N | 663. | 731. | 796. | 797. |
| | 78" | 77 ¹³ / ₁₆ " | 35 ¹ / ₂ " | 1 ¹ / ₄ " | D1R 7836N | 706. | 751. | 802. | 805. |
| | 84" | 83 ¹³ / ₁₆ " | 35 ¹ / ₂ " | 1 ¹ / ₄ " | D1R 8436N | 748. | 770. | 808. | 814. |
| | 90" | 89 ¹³ / ₁₆ " | 35 ¹ / ₂ " | 1 ¹ / ₄ " | D1R 9036N | 805. | 829. | 861. | 876. |
| | 96" | 95 ¹³ / ₁₆ " | 35 ¹ / ₂ " | 1 ¹ / ₄ " | D1R 9636N | 862. | 887. | 912. | 937. |

w* = nominal width

Dimensions listed under w h t are actual to the nearest ¹/₁₆"

Ordering Information

Worksurfaces

1. Pattern Number
2. Top Finish Type
3. Edge Finish

Order Code

Worksurfaces

Example: **D1R 6030N, 114, 114**

D1R Pattern Number
6030N

114 Folkstone Grey
Laminate

114 Folkstone Grey Edge
Band

Included with:

Worksurfaces

Note: An upcharge applies when specifying Legacy laminates. See Legacy finish page.

Options

Worksurfaces

- Center-Located Edge Grommet
- Woodgrain ABS edge
- Metal edge
- Techwood edge

To specify edge grommet, replace the "N" suffix from the pattern number with "G".
Add \$18.

Curvilinear Wave End Worksurfaces

Dividends Horizon curvilinear wave end worksurfaces are primarily used in panel-hung applications.

Available Sizes

Curvilinear wave end worksurfaces are handed with one side deeper than the other.

- Depths: 24"/30", 18"/30", 24"/36"
- Widths: 36" to 72"

Curvilinear Wave End Applications

36" to 48" wide wave ends are generally used as worksurface returns attached to curvilinear corners.

72" wide wave ends are used as primary worksurfaces with returns attached at the deep end.

Note: Only 18" and 24" deep returns can be attached to 72" wide wave end worksurfaces.

Curvilinear Wave End Support

In applications where worksurface ends are mounted perpendicular to panels, panel-to-worksurface brackets or a cantilever and a panel-to-worksurface bracket can be used as shown below.

72" wide curvilinear wave ends always require mid-span cantilever support including applications involving pedestal support at one end.

Pedestal Support Applications

Pedestals can be used as supports in the following locations:

- The deep end of all curvilinear wave ends
- The shallow end of all 48" and 72" wide curvilinear wave end worksurfaces

Recommended Pedestal Depths

- 18" deep wave ends require 18" deep pedestals
- 24" deep wave ends can use either a 18" or 24" deep pedestal
- 30" deep wave ends can use either a 24" or 30" deep pedestal
- 36" deep wave ends require a 30" deep pedestal

Note: When the pedestal depth is less than the worksurface depth, a panel-to-worksurface bracket must be used in the rear corner of the worksurface to the panel.

Freestanding Applications

Curvilinear wave end worksurfaces can be used to create unique freestanding workstations supported by pedestals and end units. The most common application is a 72" wide wave end worksurface with a single pedestal and end unit attached to a freestanding return.

Curvilinear Wave End Worksurface

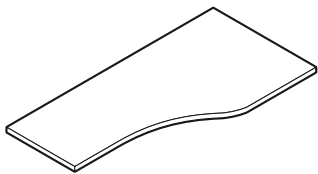

Curvilinear Wave End Worksurface Sizes

| | | |
|------|----------|----------|
| 72"W | 30"/18"D | 18"/30"D |
| 72"W | 30"/24"D | 24"/30"D |
| 72"W | 36"/24"D | 24"/36"D |

Curvilinear Wave End Applications

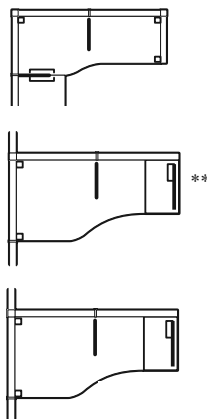
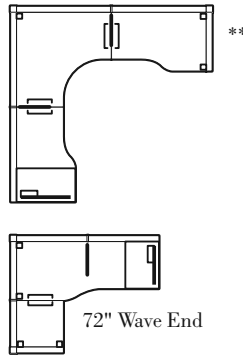

** Requires a return panel, panel-mounted C-leg support, open support leg, or a pedestal with a panel-to-worksurface bracket for support.

Pedestal Support Applications

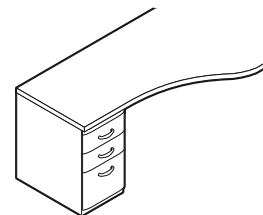
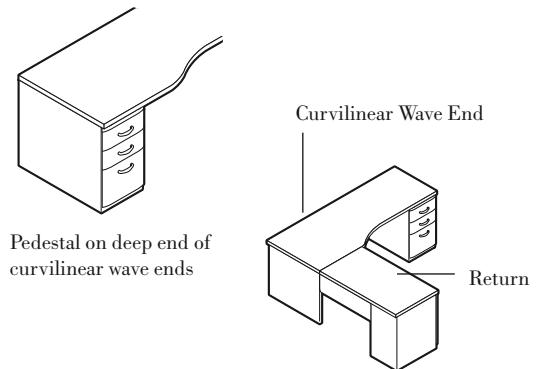



Pedestal on shallow end of curvilinear wave ends

Curvilinear Wave End Worksurfaces

Mixed Depths

Dividends Horizon

| description | w* | | | | | | | t | pattern no. | laminates w/ | laminates w/ | laminates w/ | techwood w/ |
|--|-----|-----------|---------|---------|-----------|-----------|----------|--------------------|-------------|----------------|--------------|---------------|-------------|
| | | 1 | 2 | 3 | A | B | ABS edge | | | woodgrain edge | metal edge | techwood edge | |
| Curvilinear Wave End Left No Grommets  | 36" | 35 13/16" | 23 1/2" | 29 1/2" | 14 15/16" | 2 15/16" | 1 1/4" | D1W 363024N | \$480. | \$526. | \$578. | \$919. | |
| | 42" | 41 13/16" | 23 1/2" | 29 1/2" | 14 15/16" | 8 15/16" | 1 1/4" | D1W 423024N | 502. | 555. | 602. | 947. | |
| | 48" | 47 13/16" | 23 1/2" | 29 1/2" | 14 15/16" | 14 15/16" | 1 1/4" | D1W 483024N | 536. | 592. | 646. | 973. | |
| | 72" | 71 13/16" | 17 1/2" | 29 1/2" | 23 7/16" | 14 15/16" | 1 1/4" | D1W 723018N | 666. | 732. | 798. | 999. | |
| | 72" | 71 13/16" | 23 1/2" | 29 1/2" | 23 7/16" | 30 7/16" | 1 1/4" | D1W 723024N | 685. | 752. | 824. | 1,028. | |
| | 72" | 71 13/16" | 23 1/2" | 35 1/2" | 23 7/16" | 14 15/16" | 1 1/4" | D1W 723624N | 708. | 776. | 849. | 1,055. | |
| Curvilinear Wave End Right No Grommets  | 36" | 35 13/16" | 29 1/2" | 23 1/2" | 2 15/16" | 14 15/16" | 1 1/4" | D1W 362430N | 480. | 526. | 578. | 919. | |
| | 42" | 41 13/16" | 29 1/2" | 23 1/2" | 8 15/16" | 14 15/16" | 1 1/4" | D1W 422430N | 502. | 555. | 602. | 947. | |
| | 48" | 47 13/16" | 29 1/2" | 23 1/2" | 14 15/16" | 14 15/16" | 1 1/4" | D1W 482430N | 536. | 592. | 646. | 973. | |
| | 72" | 71 13/16" | 29 1/2" | 17 1/2" | 14 15/16" | 23 7/16" | 1 1/4" | D1W 721830N | 666. | 732. | 798. | 999. | |
| | 72" | 71 13/16" | 29 1/2" | 23 1/2" | 30 7/16" | 23 7/16" | 1 1/4" | D1W 722430N | 685. | 752. | 824. | 1,028. | |
| | 72" | 71 13/16" | 35 1/2" | 23 1/2" | 14 15/16" | 23 7/16" | 1 1/4" | D1W 722436N | 708. | 776. | 849. | 1,055. | |

w* = nominal width
A and B = straight edge length
Dimensions listed under 1, 2 and 3 are actual to nearest 1/16"

Ordering Information

Worksurfaces

1. Pattern Number
2. Top Finish Type
3. Edge Finish

Order Code

Worksurfaces

Example: **D1R 6030N, 114, 114**

D1R Pattern Number
6030N

114 Folkstone
Grey Laminate

114 Folkstone Grey Edge
Band

Included with:

Worksurfaces

Note: An upcharge applies when specifying Legacy laminates. See Legacy finish page.

Options

Worksurfaces

- Center-Located Edge Grommet
- Woodgrain ABS edge
- Metal edge
- Techwood edge

To specify edge grommet, replace the "N" suffix from the pattern number with "G".
Add \$18.

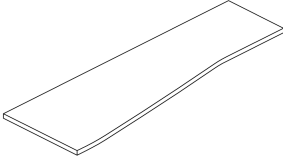
| description | w* | w | depth left | depth right | t | pattern no. | laminate w/ ABS edge | laminate w/ woodgrain edge | laminate w/ metal edge | techwood w/ techwood edge |
|--|-----------|-----------|------------|-------------|---------------------|---------------------|----------------------|----------------------------|------------------------|---------------------------|
| Smooth Wave  | 48" | 47 13/16" | 17 1/2" | 23 1/2" | 1 1/4" | D1W S481824N | \$536. | \$592. | \$646. | \$936. |
| | 48" | 47 13/16" | 17 1/2" | 29 1/2" | 1 1/4" | D1W S481830N | 536. | 592. | 646. | 939. |
| | 48" | 47 13/16" | 23 1/2" | 17 1/2" | 1 1/4" | D1W S482418N | 536. | 592. | 646. | 945. |
| | 48" | 47 13/16" | 23 1/2" | 29 1/2" | 1 1/4" | D1W S482430N | 536. | 592. | 646. | 948. |
| | 48" | 47 13/16" | 29 1/2" | 17 1/2" | 1 1/4" | D1W S483018N | 536. | 592. | 646. | 952. |
| | 48" | 47 13/16" | 29 1/2" | 23 1/2" | 1 1/4" | D1W S483024N | 536. | 592. | 646. | 955. |
| | 60" | 59 13/16" | 17 1/2" | 23 1/2" | 1 1/4" | D1W S601824N | 623. | 685. | 746. | 959. |
| | 60" | 59 13/16" | 17 1/2" | 29 1/2" | 1 1/4" | D1W S601830N | 623. | 685. | 746. | 963. |
| | 60" | 59 13/16" | 23 1/2" | 17 1/2" | 1 1/4" | D1W S602418N | 623. | 685. | 746. | 968. |
| | 60" | 59 13/16" | 23 1/2" | 29 1/2" | 1 1/4" | D1W S602430N | 623. | 685. | 746. | 973. |
| | 60" | 59 13/16" | 29 1/2" | 17 1/2" | 1 1/4" | D1W S603018N | 623. | 685. | 746. | 978. |
| | 60" | 59 13/16" | 29 1/2" | 23 1/2" | 1 1/4" | D1W S603024N | 623. | 685. | 746. | 981. |
| | 66" | 65 13/16" | 17 1/2" | 23 1/2" | 1 1/4" | D1W S661824N | 666. | 733. | 800. | 985. |
| | 66" | 65 13/16" | 17 1/2" | 29 1/2" | 1 1/4" | D1W S661830N | 666. | 733. | 800. | 988. |
| | 66" | 65 13/16" | 23 1/2" | 17 1/2" | 1 1/4" | D1W S662418N | 666. | 733. | 800. | 993. |
| | 66" | 65 13/16" | 23 1/2" | 29 1/2" | 1 1/4" | D1W S662430N | 666. | 733. | 800. | 997. |
| | 66" | 65 13/16" | 29 1/2" | 17 1/2" | 1 1/4" | D1W S663018N | 666. | 733. | 800. | 1,001. |
| | 66" | 65 13/16" | 29 1/2" | 23 1/2" | 1 1/4" | D1W S663024N | 666. | 733. | 800. | 1,004. |
| | 72" | 71 13/16" | 17 1/2" | 23 1/2" | 1 1/4" | D1W S721824N | 708. | 776. | 849. | 1,009. |
| | 72" | 71 13/16" | 17 1/2" | 29 1/2" | 1 1/4" | D1W S721830N | 708. | 776. | 849. | 1,013. |
| | 72" | 71 13/16" | 23 1/2" | 17 1/2" | 1 1/4" | D1W S722418N | 708. | 776. | 849. | 1,019. |
| | 72" | 71 13/16" | 23 1/2" | 29 1/2" | 1 1/4" | D1W S722430N | 708. | 776. | 849. | 1,025. |
| | 72" | 71 13/16" | 29 1/2" | 17 1/2" | 1 1/4" | D1W S723018N | 708. | 776. | 849. | 1,029. |
| | 72" | 71 13/16" | 29 1/2" | 23 1/2" | 1 1/4" | D1W S723024N | 708. | 776. | 849. | 1,032. |
| | 78" | 77 13/16" | 17 1/2" | 23 1/2" | 1 1/4" | D1W S781824N | 748. | 825. | 899. | 1,036. |
| | 78" | 77 13/16" | 17 1/2" | 29 1/2" | 1 1/4" | D1W S781830N | 748. | 825. | 899. | 1,038. |
| | 78" | 77 13/16" | 23 1/2" | 17 1/2" | 1 1/4" | D1W S782418N | 748. | 825. | 899. | 1,039. |
| | 78" | 77 13/16" | 23 1/2" | 29 1/2" | 1 1/4" | D1W S782430N | 748. | 825. | 899. | 1,044. |
| | 78" | 77 13/16" | 29 1/2" | 17 1/2" | 1 1/4" | D1W S783018N | 748. | 825. | 899. | 1,049. |
| | 78" | 77 13/16" | 29 1/2" | 23 1/2" | 1 1/4" | D1W S783024N | 748. | 825. | 899. | 1,054. |
| | 84" | 83 13/16" | 17 1/2" | 23 1/2" | 1 1/4" | D1W S841824N | 794. | 871. | 951. | 1,057. |
| | 84" | 83 13/16" | 17 1/2" | 29 1/2" | 1 1/4" | D1W S841830N | 794. | 871. | 951. | 1,061. |
| 84" | 83 13/16" | 23 1/2" | 17 1/2" | 1 1/4" | D1W S842418N | 794. | 871. | 951. | 1,065. | |
| 84" | 83 13/16" | 23 1/2" | 29 1/2" | 1 1/4" | D1W S842430N | 794. | 871. | 951. | 1,069. | |
| 84" | 83 13/16" | 29 1/2" | 17 1/2" | 1 1/4" | D1W S843018N | 794. | 871. | 951. | 1,072. | |
| 84" | 83 13/16" | 29 1/2" | 23 1/2" | 1 1/4" | D1W S843024N | 794. | 871. | 951. | 1,077. | |

Ordering Information

Worksurfaces

1. Pattern Number
2. Top Finish Type
3. Edge Finish

Order Code

Worksurfaces

Example: **D1R 6030N, 114, 114**

| | |
|------------|------------------------------------|
| D1W | Dividends Worksurface |
| S | Smooth Wave Shape |
| 72 | Overall width in inches |
| 30 | Nominal depth at user's left side |
| 24 | Nominal depth at user's right side |
| N | No grommet |
| 114 | Folkstone Grey Laminate |
| 114 | Folkstone Grey Edge Band |

Included with:

Worksurfaces

Note: An upcharge applies when specifying Legacy laminates. See Legacy finish page.

Options

Worksurfaces

- 1 Center-Located Edge Grommets
- Woodgrain ABS edge
- Metal edge
- Techwood edge

To specify edge grommets, replace the "N" suffix from the pattern number with a "G".

Add \$28

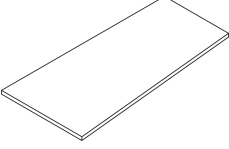
| description | w* | w | depth left | depth right | t | pattern no. | laminate w/ ABS edge | laminate w/ woodgrain edge | laminate w/ metal edge | techwood w/ techwood edge |
|--|-----|----------------------|--------------------|--------------------|-------------------|---------------------|----------------------|----------------------------|------------------------|---------------------------|
| Trapezoidal  | 48" | 47 ^{13/16"} | 23 ^{1/2"} | 29 ^{1/2"} | 1 ^{1/4"} | D1W T482430N | \$536. | \$592. | \$646. | \$670. |
| | 48" | 47 ^{13/16"} | 29 ^{1/2"} | 23 ^{1/2"} | 1 ^{1/4"} | D1W T483024N | 536. | 592. | 646. | 670. |
| | 60" | 59 ^{13/16"} | 23 ^{1/2"} | 29 ^{1/2"} | 1 ^{1/4"} | D1W T602430N | 623. | 685. | 746. | 708. |
| | 60" | 59 ^{13/16"} | 29 ^{1/2"} | 23 ^{1/2"} | 1 ^{1/4"} | D1W T603024N | 623. | 685. | 746. | 708. |
| | 66" | 65 ^{13/16"} | 23 ^{1/2"} | 29 ^{1/2"} | 1 ^{1/4"} | D1W T662430N | 666. | 733. | 800. | 744. |
| | 66" | 65 ^{13/16"} | 29 ^{1/2"} | 23 ^{1/2"} | 1 ^{1/4"} | D1W T663024N | 666. | 733. | 800. | 744. |
| | 72" | 71 ^{13/16"} | 23 ^{1/2"} | 29 ^{1/2"} | 1 ^{1/4"} | D1W T722430N | 708. | 776. | 849. | 782. |
| | 72" | 71 ^{13/16"} | 29 ^{1/2"} | 23 ^{1/2"} | 1 ^{1/4"} | D1W T723024N | 708. | 776. | 849. | 782. |

Ordering Information

Worksurfaces

1. Pattern Number
2. Top Finish Type
3. Edge Finish

Order Code

Worksurfaces

Example: **D1W T482430N**

| | |
|------------|------------------------------------|
| D1W | Dividends Worksurface |
| T | Trapezoidal Shape |
| 48 | Overall Width, inches |
| 24 | Nominal depth at user's left side |
| 30 | Nominal depth at user's right side |
| N | No grommet |
| 114 | Folkstone Grey Laminate |
| 114 | Folkstone Grey Edge Band |

Included with:

Worksurface

Note: An upcharge applies when specifying Legacy laminates. See Legacy finish page.

Options

Worksurfaces

- 1 Center-Located Edge Grommets
- Woodgrain ABS edge
- Metal edge
- Techwood edge

To specify edge grommets replace the "N" suffix from the pattern number with a "G".

Add \$28

Corner Worksurfaces

Rectilinear and Split Top Corner Specifications

Rectilinear Corner Worksurfaces

Dividends Horizon rectilinear corner worksurfaces are used in panel-hung and freestanding applications.

Split Top Corner Worksurfaces

Split top corner worksurfaces allow for height and angle adjustment on the front work surface.

The depth of the front keyboard work surface is 10 ⁵/₈". The front surface adjusts from a - 5 ³/₄" below the work surface to a + 7" above. The mechanism has a tilt feature of ±10 degrees.

Included with the split top work surface is the back corner work surface, the front corner work surface, the split top mechanism, one rear corner panel-to-work surface bracket and two flat brackets for attachment to return work surfaces. Cantilevers must be ordered separately and are specified to the size return

work surface depth (i.e 24" cantilevers for 24" deep return work surfaces). Panel-mounted C-leg or Open Leg work surface supports may be used in place of cantilevers.

Available Sizes

- Widths: 36", 42" and 48"
- Returns: 18", 24" and 30"
- Thickness: 1 ¹/₄"

Corner Worksurface Support

Corner worksurfaces must be supported by cantilevers at each end and a panel-to-work surface bracket at the rear corner. Panel-mounted C-leg or Open Leg work surface supports may be used instead of cantilevers for corner work surface support. Cantilevers and panel-mounted C-leg or Open Leg supports are ordered separately. Panel-to-work surface bracket is included.

Corner Worksurface Applications

Corner worksurfaces attach to adjacent work surfaces with cantilevers and flat brackets. Suggested applications are illustrated below.

Note: All dimensions are nominal except for front edge dimension.

Note: Series 3 overdesk units are not compatible with corner work surfaces.

Rectilinear Corner Worksurface

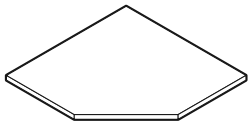

Rectilinear Split-Top Corner Worksurface

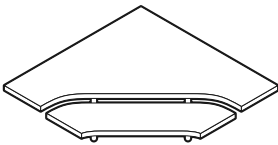

Rectilinear and Split Top Corner Worksurface Sizes Available

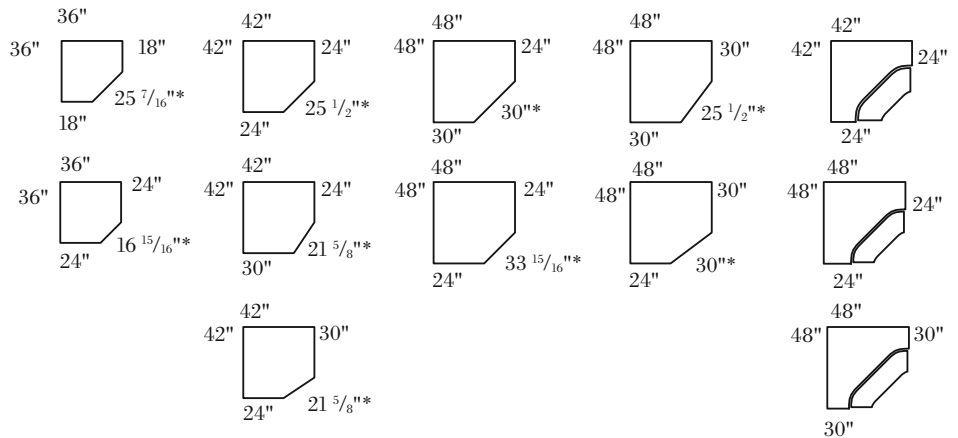

Corner Worksurface Support

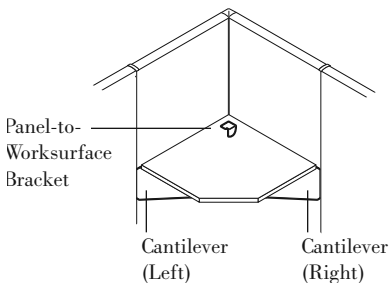

Corner Worksurface Applications

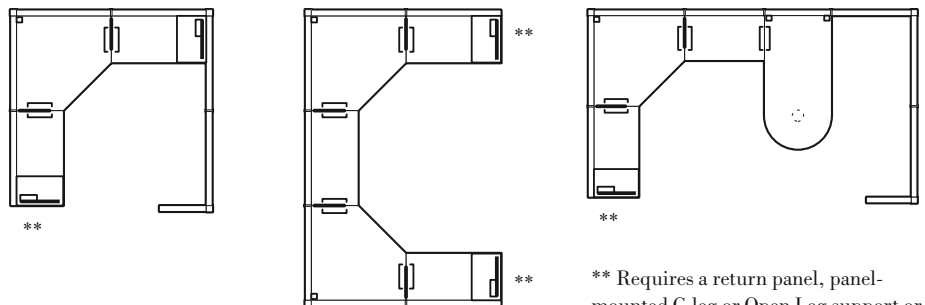





** Requires a return panel, panel-mounted C-leg or Open Leg support or a pedestal with a panel-to-work surface bracket for support.

Corner Worksurfaces

Rectilinear and Split Top Corner

Mixed Depths

| description | 1 | 2 | 3 | 4 | t | pattern no. | laminate w/ ABS edge | laminate w/ woodgrain edge | laminate w/ metal edge | techwood w/ techwood edge |
|--|-----|-----|-----|-----|--------|--------------------|----------------------------|----------------------------------|---------------------------|---------------------------------|
| Rectilinear Corner Worksurface No Grommets  | 36" | 36" | 18" | 18" | 1 1/4" | D1C 3618N | \$410. | \$451. | \$492. | \$832. |
| | 36" | 36" | 24" | 24" | 1 1/4" | D1C 3624N | 417. | 461. | 501. | 911. |
| | 42" | 42" | 24" | 24" | 1 1/4" | D1C 4224N | 470. | 518. | 563. | 987. |
| | 48" | 48" | 24" | 24" | 1 1/4" | D1C 4824N | 537. | 593. | 647. | 1,066. |
| | 48" | 48" | 30" | 30" | 1 1/4" | D1C 4830N | 555. | 610. | 666. | 1,144. |
| Rectilinear Corner Worksurface. 24" Deep Return Left 30" Deep Return Right No Grommets  | 42" | 42" | 24" | 30" | 1 1/4" | D1C 422430N | 493. | 541. | 592. | 1,072. |
| | 48" | 48" | 24" | 30" | 1 1/4" | D1C 482430N | 559. | 616. | 673. | 1,144. |
| Rectilinear Corner Worksurface. 30" Deep Return Left 24" Deep Return Right No Grommets  | 42" | 42" | 30" | 24" | 1 1/4" | D1C 423024N | 493. | 541. | 592. | 1,072. |
| | 48" | 48" | 30" | 24" | 1 1/4" | D1C 483024N | 559. | 616. | 673. | 1,144. |
| Split Top Corner Worksurface No Grommets  | 42" | 42" | 24" | 24" | 1 1/4" | D1CS 4224N | 1,672. | 1,838. | 2,007. | 2,842. |
| | 48" | 48" | 24" | 24" | 1 1/4" | D1CS 4824N | 1,722. | 1,892. | 2,065. | 2,937. |
| | 48" | 48" | 30" | 30" | 1 1/4" | D1CS 4830N | 1,734. | 1,906. | 2,082. | 3,032. |

Note: Above 1, 2, 3, and 4 dimensions are all nominal
Actual dimensions are 1/2" less than shown above.

| Ordering Information | Order Code | Included with: | Options |
|---|---|--|--|
| Worksurfaces 1. Pattern Number 2. Top Finish Type 3. Edge Finish Split Top Corner Worksurfaces 1. Pattern Number 2. Top Finish Type 3. Edge Finish | Worksurfaces <i>Example:</i> D1C 423024N, 117, 115 D1C Pattern Number 423024N 117 Soft Grey Laminate 115 Medium Grey Edge Band Split Top Corner Worksurfaces <i>Example:</i> D1CS 4224N, 117, 117 D1CS Pattern Number 4224N 117 Soft Grey Laminate 117 Soft Grey Edge Band | Worksurfaces <ul style="list-style-type: none"> • Worksurface • Panel-to-Worksurface Bracket Split Top Corner Worksurfaces <ul style="list-style-type: none"> • Front Worksurface • Back Worksurface • Split Top Mechanism • Flat Brackets • Panel-to-Worksurface Bracket <p>Note: When wood grain or brushed laminates are specified on corner worksurfaces where side 1 and 2 are of equal length, one of three grain direction options must be specified. Insert the desired grain direction option (L,R or D) after the laminate code. Please add \$26 to the list price for diagonal grain (D) selection.</p> <p>Note: Techwood corner worksurfaces with the same dimension on side 1 and side 2 have a diagonal grain direction. See grain direction page for more information.</p> <p>Note: An upcharge applies when specifying Legacy laminates. See Legacy finish page.</p> | Worksurfaces <ul style="list-style-type: none"> • 2 Center-Located Edge Grommets • Woodgrain PVC edge • Metal edge • Techwood edge <p>To specify edge grommets, replace the "N" suffix from the pattern number with a "G". Add \$29</p> Split Top Corner Worksurfaces <ul style="list-style-type: none"> • 2 Center-Located Edge Grommets • Woodgrain PVC edge • Metal edge • Techwood edge <p>Note: Overdesk units are not compatible with corner worksurfaces.</p> |

Corner Worksurfaces

Curvilinear Corner "L" Shape - 24" Depths Specifications

Curvilinear Corner L Shape Worksurfaces

Dividends Horizon curvilinear corner "L" shape worksurfaces are specified for panel-hung applications only and provide a continuous flow when used in conjunction with other curvilinear worksurfaces.

Curvilinear Corner Worksurface Support

Curvilinear corner "L" shape worksurfaces must be supported by cantilevers at each end and a panel-to-worksurface bracket at the rear corner. Panel-mounted C-leg or open leg worksurface supports may be used instead of cantilevers for corner worksurface support.

Cantilevers, panel-mounted c-leg and open support legs are ordered separately. A panel-to-worksurface bracket is included.

Note: Worksurfaces greater than 48" wide require an additional mid-span cantilever support along the 60" or 72" side.

Note: A pedestal, panel-mounted C-leg or Open Leg Support can be substituted for a cantilever in the following locations:

- The long end of 60" and 72" wide curvilinear "L" shape corner worksurfaces

Note: Series 3 overdesk units are not compatible with corner worksurfaces.

Curvilinear Corner Worksurface

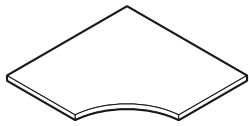

Curvilinear Corner Worksurface Support Options

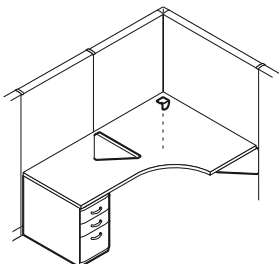
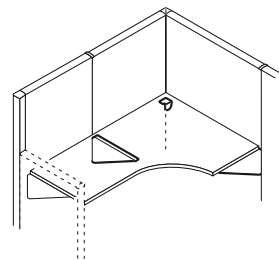
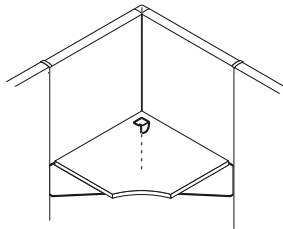

Curvilinear Corner "L" Shape Worksurface

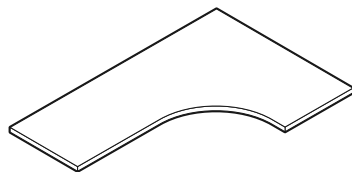

Curvilinear Corner Worksurface Applications

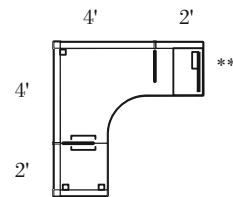
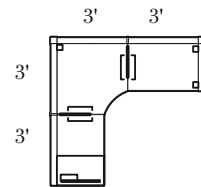

** Requires a return panel or pedestal/panel-mounted C-leg or Open Support Leg with panel-to-worksurface bracket for support

Corner Worksurfaces

Curvilinear Corner "L" Shape - 24" Depths

24" Depths

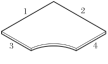
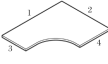
| description | 1 | 2 | 3 | 4 | t | pattern no. | laminates w/ ABS edge | laminates w/ woodgrain edge | laminates w/ metal edge | techwood w/ techwood edge |
|---|-----|-----|-----|-----|--------|--------------------|-----------------------------|-----------------------------------|----------------------------|------------------------------|
| Curvilinear Corner "L" Shape Worksurface 24" Deep Returns Left and Right | 36" | 36" | 24" | 24" | 1 1/4" | D1L 3636SSN | \$446. | \$489. | \$533. | \$1,026. |
| | 42" | 42" | 24" | 24" | 1 1/4" | D1L 4242SSN | 535. | 591. | 645. | 1,089. |
|  | 42" | 60" | 24" | 24" | 1 1/4" | D1L 4260SSN | 738. | 812. | 885. | 1,215. |
| | 42" | 66" | 24" | 24" | 1 1/4" | D1L 4266SSN | 758. | 839. | 912. | 1,247. |
|  | 42" | 72" | 24" | 24" | 1 1/4" | D1L 4272SSN | 786. | 865. | 946. | 1,309. |
| | 42" | 78" | 24" | 24" | 1 1/4" | D1L 4278SSN | 796. | 876. | 954. | 1,370. |
| | 48" | 48" | 24" | 24" | 1 1/4" | D1L 4848SSN | 602. | 666. | 722. | 1,150. |
| | 48" | 60" | 24" | 24" | 1 1/4" | D1L 4860SSN | 746. | 821. | 894. | 1,278. |
| | 48" | 66" | 24" | 24" | 1 1/4" | D1L 4866SSN | 773. | 851. | 927. | 1,341. |
| | 48" | 72" | 24" | 24" | 1 1/4" | D1L 4872SSN | 803. | 881. | 958. | 1,401. |
| | 48" | 78" | 24" | 24" | 1 1/4" | D1L 4878SSN | 885. | 973. | 1,061. | 1,432. |
| | 48" | 84" | 24" | 24" | 1 1/4" | D1L 4884SSN | 993. | 1,093. | 1,192. | 1,462. |
| | 60" | 42" | 24" | 24" | 1 1/4" | D1L 6042SSN | 738. | 812. | 885. | 1,215. |
| | 60" | 48" | 24" | 24" | 1 1/4" | D1L 6048SSN | 746. | 821. | 894. | 1,278. |
| | 66" | 42" | 24" | 24" | 1 1/4" | D1L 6642SSN | 758. | 839. | 912. | 1,247. |
| | 66" | 48" | 24" | 24" | 1 1/4" | D1L 6648SSN | 773. | 851. | 927. | 1,341. |
| | 72" | 42" | 24" | 24" | 1 1/4" | D1L 7242SSN | 786. | 865. | 946. | 1,309. |
| | 72" | 48" | 24" | 24" | 1 1/4" | D1L 7248SSN | 803. | 881. | 958. | 1,401. |
| | 78" | 42" | 24" | 24" | 1 1/4" | D1L 7842SSN | 796. | 876. | 954. | 1,370. |
| | 78" | 48" | 24" | 24" | 1 1/4" | D1L 7848SSN | 885. | 973. | 1,061. | 1,432. |
| | 84" | 48" | 24" | 24" | 1 1/4" | D1L 8448SSN | 993. | 1,093. | 1,192. | 1,462. |

Note: Above 1, 2, 3, and 4 dimensions are all nominal
Actual dimensions are 1/2" less than shown above.

| Ordering Information | Order Code | Included with: | Options |
|------------------------|--|---|--|
| 1. Worksurfaces | Worksurfaces | Worksurfaces | Worksurfaces |
| 2. Pattern Number | <i>Example:</i> D1L 4860SSN, 117, 117 | <ul style="list-style-type: none"> Worksurface Panel-to-Worksurface Bracket | <ul style="list-style-type: none"> 2 center-located edge grommets Woodgrain ABS edge Metal edge Techwood |
| 3. Top Finish Type | D1L Pattern Number | <p>Note: When wood grain or brushed laminates are specified on corner worksurfaces where side 1 and 2 are of equal length, one of three grain direction options must be specified. Insert the desired grain direction option (L,R or D) after the laminate code. Please add \$26 to the list price for diagonal grain (D) selection.</p> <p>Note: Techwood corner worksurfaces with the same dimension on side 1 and side 2 have a diagonal grain direction. See grain direction page for more information.</p> <p>Note: An upcharge applies when specifying Legacy laminates. See Legacy finish page.</p> | <p>To specify edge grommets, replace the "N" suffix from the pattern number with "G" Add \$29</p> <p>Note: Overdesk units are not compatible with corner worksurfaces.</p> |
| 4. Edge Finish | 4860SSN | | |
| | 117 Soft Grey laminate | | |
| | 117 Soft Grey Edge Band | | |

Corner Worksurfaces

Curvilinear Corner "L" shape-Mixed Depths Specifications

Curvilinear Corner "L" Shape Worksurfaces

Dividends Horizon curvilinear corner, "L" shape worksurfaces are specified for panel-hung applications only and provide a continuous flow when used in conjunction with other curvilinear worksurfaces.

Curvilinear Corner Worksurface Support

Curvilinear corner "L" shape worksurfaces must be supported by cantilevers at each end and a panel-to-worksurface bracket at the rear corner. Panel-mounted C-leg or open leg worksurface supports may be used instead of cantilevers for corner worksurface support.

Cantilevers and panel-mounted C-leg or open leg supports are ordered separately. A panel-to-worksurface bracket is included.

Note: 60" and 72" wide curvilinear corners require an additional mid-span cantilever support along the 60" or 72" side.

Note: A pedestal or panel-mounted C-leg can be substituted for a cantilever in the following locations:

- The long end of 60" and 72" wide curvilinear "L" shape corner worksurfaces

Curvilinear Corner Worksurface Applications

Curvilinear "L" shape corner worksurfaces are primarily used with wave end and rectangular worksurface returns.

Curvilinear Corner Worksurface

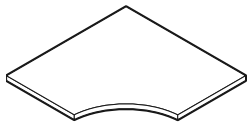

Curvilinear Corner Worksurface Support Options

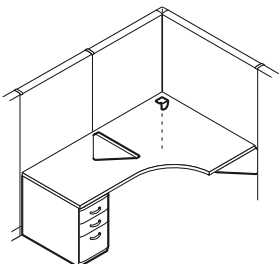
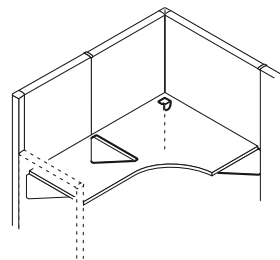
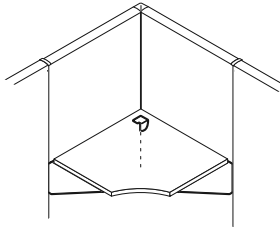

Curvilinear Corner "L" Shape Worksurface

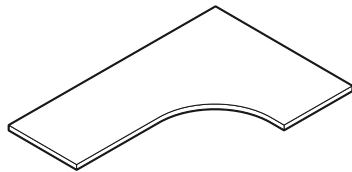

Curvilinear Corner Worksurface Applications

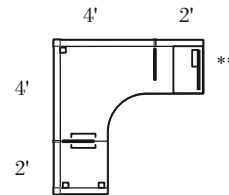
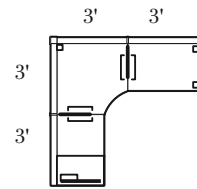

** Requires a return panel or pedestal/panel-mounted C-leg or Open Leg Support with panel-to-worksurface bracket for support

Corner Worksurfaces

Curvilinear Corner "L" shape-Mixed Depths

Mixed Depths

Dividends Horizon

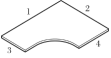
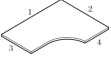
| description | 1 | 2 | 3 | 4 | t | pattern no. | laminata w/ ABS edge | laminata w/ woodgrain edge | laminata w/ metal edge | techwood w/ techwood edge |
|---|-----|-----|-----|-----|--------|--------------------|----------------------------|----------------------------------|---------------------------|---------------------------------|
| Curvilinear Corner "L" Shape Worksurface. 30" Deep Returns Left and Right | 48" | 48" | 30" | 30" | 1 1/4" | D1L 4848DDN | \$650. | \$716. | \$778. | \$1,164. |
| Curvilinear Corner "L" Shape Worksurface 24" Deep Return Left 30" Deep Return Right  | 48" | 48" | 24" | 30" | 1 1/4" | D1L 4848SDN | 643. | 707. | 771. | 1,164. |
| | 48" | 60" | 24" | 30" | 1 1/4" | D1L 4860SDN | 734. | 808. | 878. | 1,194. |
| | 48" | 66" | 24" | 30" | 1 1/4" | D1L 4866SDN | 770. | 847. | 923. | 1,223. |
| | 48" | 72" | 24" | 30" | 1 1/4" | D1L 4872SDN | 808. | 887. | 966. | 1,255. |
| | 60" | 48" | 24" | 30" | 1 1/4" | D1L 6048SDN | 719. | 790. | 863. | 1,288. |
| | 66" | 48" | 24" | 30" | 1 1/4" | D1L 6648SDN | 755. | 830. | 910. | 1,319. |
| | 72" | 48" | 24" | 30" | 1 1/4" | D1L 7248SDN | 794. | 874. | 952. | 1,350. |
| Curvilinear Corner "L" Shape Worksurface 30" Deep Return Left 24" Deep Return Right  | 48" | 48" | 30" | 24" | 1 1/4" | D1L 4848DSN | 643. | 707. | 771. | 1,164. |
| | 48" | 60" | 30" | 24" | 1 1/4" | D1L 4860DSN | 719. | 790. | 863. | 1,194. |
| | 48" | 66" | 30" | 24" | 1 1/4" | D1L 4866DSN | 755. | 830. | 910. | 1,223. |
| | 48" | 72" | 30" | 24" | 1 1/4" | D1L 4872DSN | 794. | 874. | 952. | 1,255. |
| | 60" | 48" | 30" | 24" | 1 1/4" | D1L 6048DSN | 734. | 808. | 878. | 1,288. |
| | 66" | 48" | 30" | 24" | 1 1/4" | D1L 6648DSN | 770. | 847. | 923. | 1,319. |
| | 72" | 48" | 30" | 24" | 1 1/4" | D1L 7248DSN | 808. | 887. | 966. | 1,350. |

Note: Above 1, 2, 3, and 4 dimensions are all nominal
Actual dimensions are 1/2" less than shown above.

Ordering Information

Worksurfaces

1. Pattern Number
2. Top Finish Type
3. Edge Band Finish

Order Code

Worksurfaces

Example: **D1L 4860SDN, 117, 117**

| | |
|----------------|---------------------|
| D1L | Pattern Number |
| 4860SDN | |
| 117 | Soft Grey Laminate |
| 117 | Soft Grey edge band |

Included with:

Worksurfaces

- Worksurface
- Panel-to-worksurface bracket

Note: An upcharge applies when specifying Legacy laminates. See Legacy finish page.

Options

Worksurfaces

- 2 center-located edge grommets
- Woodgrain ABS edge
- Metal edge
- Techwood

To specify edge grommets, replace the "N" suffix from the pattern number with "G"

Add \$29

Note: An overdesk unit will not align with the width of a corner worksurface due to the 1/2" wire drop gap. The overdesk will be 1/2" too wide.

Peninsula Worksurfaces

"D", "P", "9" and Blended "D" Specifications

"D", Blended "D", Conferencing, "P" and "9" Shape Peninsula Worksurfaces

Dividends Horizon peninsula worksurfaces mount perpendicular to panels of the same width to provide conferencing area within a workstation.

"D", "P" and "9" tops are supported by panel-to-worksurface brackets on the flat end and a support column, T leg or A leg support at the free end. Adjacent worksurfaces can attach to peninsula tops with flat brackets.

All brackets and supports are ordered separately. "D", "P" and "9" shape peninsula worksurfaces may be used in freestanding applications.

"D" Shaped Peninsula

Available Sizes

- Depths: 24", 30" and 36"
- Widths: 48", 60", 66" and 72"
- Thickness: 1 1/4"

"P" and "9" Shaped Peninsula

Available Sizes

- Depth: 30" panel depth
- Widths: 66", 72" and 78"
- Conferencing diameter: 36" and 42"
- Thickness: 1 1/4"

Blended "D" Peninsula

Available Sizes

- Depths: 48"
- Widths: 72" and 66"
- Thickness: 1 1/4"

Conferencing Worksurfaces

- Depth: 48"
- Width: 60"
- Thickness: 1 1/4"

"D" and "P" Shape Peninsula Worksurfaces

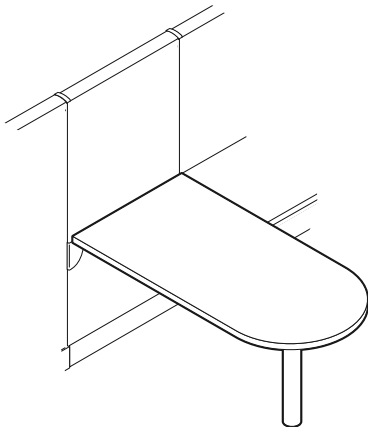

Blended "D" Shape Peninsula Worksurface

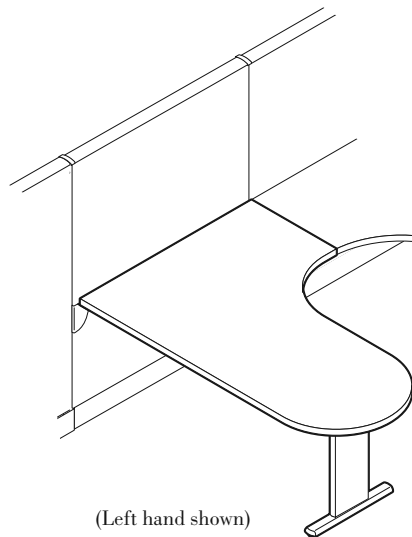

Conferencing Worksurface Dimensions

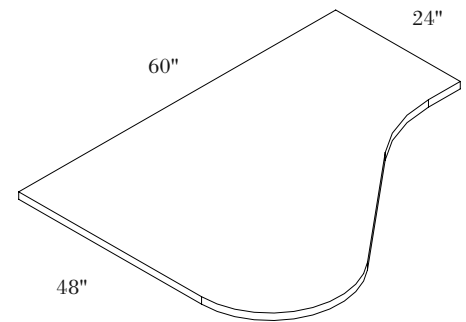





Peninsula Worksurfaces

“D”, “P”, “9” and Blended “D”

Mixed Depths

Dividends Horizon

| description | type | w * | w | d | dia. | t | pattern no. | laminates w/ | laminates w/ | laminates w/ | techwood w/ | |
|---|---|----------|----------------------|----------------------|----------------------|-------------------|-------------------|------------------|----------------|--------------|---------------|--------|
| | | | | | | | | ABS edge | woodgrain edge | metal edge | techwood edge | |
| “D” Peninsula Worksurface Laminate No Grommets  | | 48" | 47 ^{13/16"} | 23 ^{13/16"} | | 1 ^{1/4"} | D1D 4824N | \$441. | \$486. | \$529. | \$1,094. | |
| | | 48" | 47 ^{13/16"} | 29 ^{13/16"} | | 1 ^{1/4"} | D1D 4830N | 486. | 533. | 584. | 1,130. | |
| | | 60" | 59 ^{13/16"} | 29 ^{13/16"} | | 1 ^{1/4"} | D1D 6030N | 620. | 683. | 744. | 1,166. | |
| | | 66" | 65 ^{13/16"} | 29 ^{13/16"} | | 1 ^{1/4"} | D1D 6630N | 678. | 743. | 812. | 1,203. | |
| | | 72" | 71 ^{13/16"} | 29 ^{13/16"} | | 1 ^{1/4"} | D1D 7230N | 712. | 782. | 855. | 1,238. | |
| | | 72" | 71 ^{13/16"} | 35 ^{13/16"} | | 1 ^{1/4"} | D1D 7236N | 778. | 857. | 936. | 1,275. | |
| Blended “D” Peninsula Worksurface (Left hand shown)  | LH w/ 24" return depth | 66" | 65 ^{13/16"} | 47 ^{13/16"} | | 1 ^{1/4"} | D1BD6648SL | 720. | 794. | 864. | 2,552. | |
| | | 72" | 71 ^{13/16"} | 47 ^{13/16"} | | 1 ^{1/4"} | D1BD7248SL | 736. | 811. | 883. | 2,575. | |
| | LH w/ 30" return depth | 66" | 65 ^{13/16"} | 47 ^{13/16"} | | 1 ^{1/4"} | D1BD6648DL | 758. | 839. | 912. | 2,552. | |
| | | 72" | 71 ^{13/16"} | 47 ^{13/16"} | | 1 ^{1/4"} | D1BD7248DL | 785. | 864. | 945. | 2,575. | |
| | RH w/ 24" return depth | 66" | 65 ^{13/16"} | 47 ^{13/16"} | | 1 ^{1/4"} | D1BD6648SR | 720. | 794. | 864. | 2,552. | |
| | | 72" | 71 ^{13/16"} | 47 ^{13/16"} | | 1 ^{1/4"} | D1BD7248SR | 736. | 811. | 883. | 2,575. | |
| | RH w/ 30" return depth | 66" | 65 ^{13/16"} | 47 ^{13/16"} | | 1 ^{1/4"} | D1BD6648DR | 758. | 839. | 912. | 2,552. | |
| | | 72" | 71 ^{13/16"} | 47 ^{13/16"} | | 1 ^{1/4"} | D1BD7248DR | 785. | 864. | 945. | 2,575. | |
| | Conferencing worksurface (left hand shown)  | | 60" | 59 ^{13/16"} | 48" | 24" | 1 ^{1/4"} | DB1BD48SL | 992. | 1,092. | 1,191. | 2,526. |
| | | | 60" | 59 ^{13/16"} | 48" | 24" | 1 ^{1/4"} | DB1BD48SR | 992. | 1,092. | 1,191. | 2,526. |
| | Peninsula Worksurface-Laminate No Grommets (9-shaped shown)  | P-shaped | 66" | 65 ^{13/16"} | 29 ^{13/16"} | 36" | 1 ^{1/4"} | D1P 6630N | 708. | 776. | 849. | 1,634. |
| | | | 72" | 71 ^{13/16"} | 29 ^{13/16"} | 42" | 1 ^{1/4"} | D1P 7230N | 721. | 795. | 865. | 1,680. |
| 78" | | | 77 ^{13/16"} | 29 ^{13/16"} | 42" | 1 ^{1/4"} | D1P 7830N | 810. | 889. | 968. | 1,728. | |
| 9-shaped | | 66" | 65 ^{13/16"} | 29 ^{13/16"} | 36" | 1 ^{1/4"} | D19 6630N | 708. | 776. | 849. | 1,634. | |
| | | 72" | 71 ^{13/16"} | 29 ^{13/16"} | 42" | 1 ^{1/4"} | D19 7230N | 721. | 795. | 865. | 1,680. | |
| | | 78" | 77 ^{13/16"} | 29 ^{13/16"} | 42" | 1 ^{1/4"} | D19 7830N | 810. | 889. | 968. | 1,728. | |

w* = nominal width
 Dimensions listed under w d t are actual to the nearest 1/16"

| Ordering Information | Order Code | Included with: | Options |
|---|--|---|--|
| “D” Worksurface 1. Pattern Number 2. Top Finish Type 3. Edge Finish | “D” Worksurface <hr/> <i>Example:</i> D1H 6030, 114, 114 D1H 6030 Pattern Number 114 Folkstone Grey Laminate <hr/> 114 Folkstone Grey Edge Band | Worksurface Note: Support column and panel-to-worksurface brackets must be ordered separately. Note: An upcharge applies when specifying Legacy laminates. See Legacy finish page. | Worksurfaces <ul style="list-style-type: none"> • Woodgrain ABS edge • Metal edge • Techwood edge To specify an edge grommet, replace “N” suffix from pattern number with “G”. Add \$19. |

Curvilinear Half-Round Worksurfaces

Curvilinear half-round worksurfaces are sized to match up to the width of two back-to-back 24" deep or two back-to-back 30" deep freestanding desks.

Panel-supported half-round worksurfaces are notched along the flat end to accommodate the panel end trim.

Attachment is with a column support, T leg or A leg (must be ordered separately) at the free end of the worksurface and with flat brackets on the flat end of the half-round worksurface. The flat brackets attach to the adjacent freestanding desks. Flat brackets are black.

Available Sizes

- Depths: 18" and 24"
- Widths: 48" and 63"
- Thickness: 1 1/4"

Note: All Dividends Horizon worksurfaces include a 1/2" wire drop at the rear edge. When used back to back with Half-Round worksurface, these two 1/2" wire drops will meet to form a 1" space between worksurfaces.

Transition Worksurfaces

Attachment is with a column support, T leg or A leg (must be ordered separately) at the free end of the worksurface and with flat brackets on the flat end of the transition worksurface. The flat brackets attach to the adjacent freestanding desks. Flat brackets are black.

Available Sizes

- Depths: 24", 36", 48"
- Widths: 48"
- Thickness: 1 1/4"

Corner Round Worksurfaces

Corner-round worksurfaces are designed to "finish" a run of panel-mounted worksurfaces. Corner-round may be specified in two ways.

In a 90° "L" configuration, a notched corner-round worksurface is used to wrap around the panels. Two cantilevers and flat brackets (must be ordered separately) support the corner-round worksurface.

In an end run configuration, the corner-round worksurface is handed and must be specified as a left-hand or a right-hand top. One cantilever with a flat bracket and one panel-to-worksurface bracket (must be ordered separately) support the corner-round top.

Available Sizes

- Depth: 24"
- Width: 24"
- Thickness: 1 1/4"

Optional Edge Grommets

Grommets are not available for worksurfaces on this page.

Curvilinear Half-Round Worksurfaces (without panels)

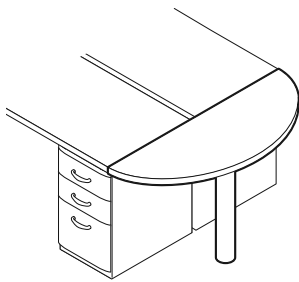

Curvilinear Half-Round Worksurfaces (with panels)

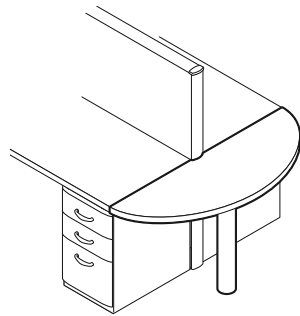

Corner-Round Worksurface

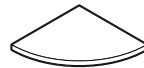

Notched Corner Worksurfae



Corner-Round Applications

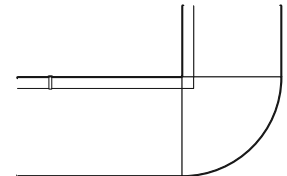

Corner-Round - Notched "L" Configuration

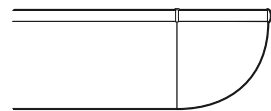



Corner-Round - End Run Configuration (right-hand shown) Quarter-round Surface

Curvilinear Half- and Corner-Round Worksurfaces

Mixed Depths

Dividends Horizon

| description | type | w | return depth | t | pattern no. | laminate w/ ABS edge | laminate w/ woodgrain edge | laminate w/ metal edge | techwood w/ techwood edge |
|--|------------|-----------|--------------|--------|-----------------|----------------------|----------------------------|------------------------|---------------------------|
|  Curvilinear Half-Round Worksurface | w/o panels | 48" | 18" | 1 1/4" | D1H4818 | \$383. | \$423. | \$461. | \$1,053. |
| | w/o panels | 60" | 24" | 1 1/4" | D1H6024 | 528. | 582. | 634. | 1,144. |
| | w/panels | 51" | 18" | 1 1/4" | D1H5118P | 391. | 431. | 468. | 1,097. |
| | w/panels | 63" | 24" | 1 1/4" | D1H6324P | 534. | 590. | 644. | 1,191. |
|  Transition Worksurface | w panels | 51" | 24" | 1 1/4" | D2H5124P | 470. | 518. | 563. | 1,221. |
| | w panels | 51" | 36" | 1 1/4" | D2H5136P | 480. | 526. | 578. | 1,265. |
| | w panels | 51" | 48" | 1 1/4" | D2H5148P | 489. | 536. | 588. | 1,303. |
| | w/o panels | 48" | 24" | 1 1/4" | D2H4824 | 465. | 508. | 556. | 1,104. |
| | w/o panels | 48" | 36" | 1 1/4" | D2H4836 | 471. | 519. | 568. | 1,144. |
| | w/o panels | 48" | 48" | 1 1/4" | D2H4848 | 483. | 529. | 580. | 1,183. |
|  Corner Round Worksurface | left | 23 13/16" | 23 1/2" | 1 1/4" | D1CRL24 | 206. | 224. | 244. | 895. |
| | notched | 23 1/2" | 23 1/2" | 1 1/4" | D1CRN24 | 206. | 224. | 244. | 895. |
| | right | 23 13/16" | 23 1/2" | 1 1/4" | D1CRR24 | 206. | 224. | 244. | 895. |

Ordering Information

Half-Round Worksurface

1. Pattern Number
2. Top Finish Type
3. Edge Finish

Transition Worksurface

1. Pattern Number
2. Top Finish Type
3. Edge Finish

Corner-Round Worksurface

1. Pattern Number
2. Top Finish Type
3. Edge Finish

Order Code

Half-Round Worksurface

Example: **D1H 5118P, 118, 118**

D1H Pattern Number
5118P

118 Bright White Laminate

118 Bright White Edge Band

Transition Worksurface

Example: **D2H 5136P, 117, 117**

D2H Pattern Number
5136P

117 Soft Grey Laminate

117 Soft Grey Edge Band

Included with:

Half-Round Worksurface

- Worksurface
- 2 flat brackets

Note: Support column must be ordered separately.

Transition Worksurface

- Worksurface
- 2 flat brackets

Note: Support column must be ordered separately.

Corner Round Worksurface

- Worksurface

Note: 2 cantilevers must be ordered separately.

Note: An upcharge applies when specifying Legacy laminates. See Legacy finish page.

Options

Half-Round Worksurface

- Woodgrain ABS edge
- Metal edge
- Techwood edge

Transition Worksurface

- Woodgrain ABS edge
- Metal edge
- Techwood edge

Corner-Round Worksurface

- Woodgrain ABS edge
- Metal edge
- Techwood edge

Curvilinear Half-Round and Transition Worksurface Option

Add an 'F' suffix to the pattern number when using with flat profile panel trim.

Transaction Counter Worksurfaces

15" Deep Specifications

15"D Counter Worksurfaces

Dividends Horizon 15"D counter worksurfaces attach to the tops of 42" high panels to provide a transaction area within workstations. Three types are available:

- Straight
- Square corner
- Quarter-round corner

Available Sizes

- Depth: 15"
- Widths: 24" to 96"
- Thickness: 1 1/4"

Straight Counter Worksurface Support

Straight counter worksurfaces can span single or multiple panels. Counter worksurfaces are supported by four counter worksurface brackets which are included with the straight counter worksurfaces. Counter worksurface brackets are required at panel or post junctions for proper support.

Note: High-low panel end trim must be field cut when using countertops in a high-low straight panel run application.

Note: Counter worksurfaces may NOT be used with on any screens or 36H panels.

Square and Quarter-Round Corner Counter Worksurfaces

Square corners allow rectilinear "L", "T" and "X" configurations while quarter-round corners allow radiused "L" configurations. When using corner counter worksurfaces, all adjoining straight counter worksurfaces must be 6" less than panel(s) width dimension. Square and quarter-round counter worksurfaces are supported by flat brackets which are included with corner worksurfaces. Additional support is provided by counter worksurface brackets from the adjoining straight counter worksurfaces.

Square-corner counter worksurfaces include three flat brackets while quarter-round counters include two flat brackets. Flat brackets are dark grey finish.

Counter Worksurface Corner Applications

Suggested applications and configurations are illustrated below.

Note: When connecting a 15" deep counter worksurface with either corner counter worksurface, specify 6" shorter than the required width to accommodate the width of the corner counter worksurface.

Counter Worksurface Supports

Straight counter worksurfaces 24" to 48" wide include four counter worksurface brackets while straight counters 54" to 96" wide include six counter worksurface brackets.

15"D Counter Worksurface

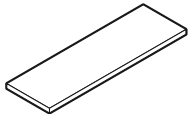

15"D Square-Shape Counter Worksurface



15"D Quarter Round Counter Worksurface



15"D Counter Worksurface Sizes Available

| | |
|-----|--|
| 15D | |
| 24 | |
| 30 | |
| 36 | |
| 42 | |
| 48 | |
| 54 | |
| 60 | |
| 66 | |
| 72 | |
| 78 | |
| 84 | |
| 90 | |
| 96 | |
| 15 | |
| 15 | |

15"D Counter Worksurface Applications

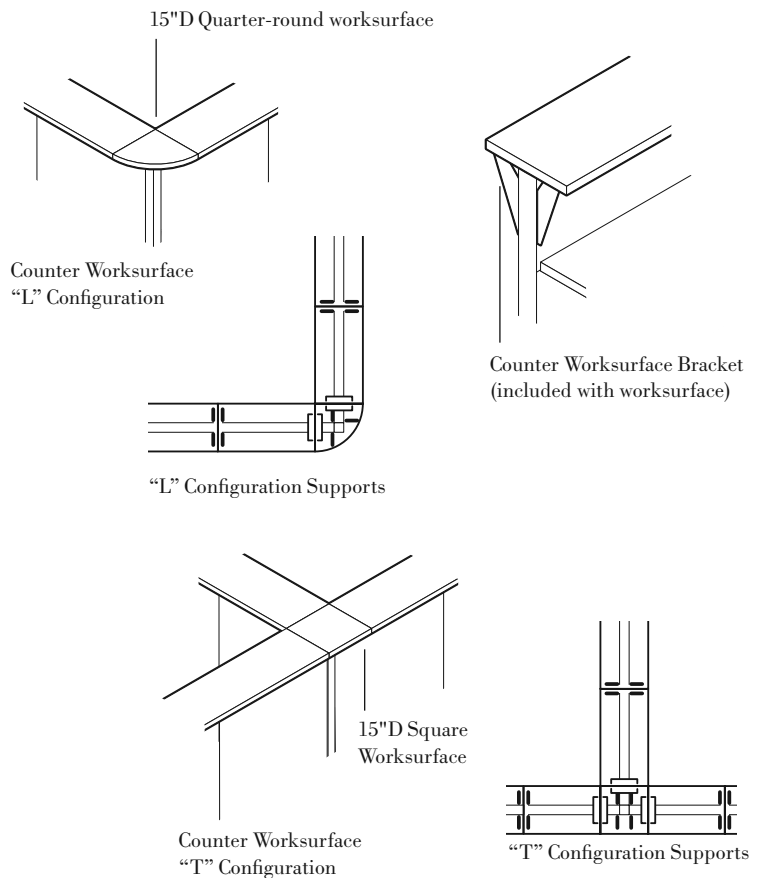



Transaction Counter Worksurfaces

Rectangular, Square Corner and Quarter-round Corner

15" Deep

Dividends Horizon

| description | w * | w | d | t | pattern no. | laminates w/ ABS edge | laminates w/ woodgrain edge | laminates w/ metal edge | techwood w/ techwood edge |
|---|-----|----------------------|-----|-------------------|------------------|-----------------------------|-----------------------------------|----------------------------|---------------------------------|
| 15" Deep Quarter-Round Shape Corner Counter Worksurface  | 15" | 14 ^{13/16"} | 15" | 1 ^{1/4"} | D1R 1515C | \$203. | \$224. | \$245. | \$820. |
| 15" Deep Square-Shape Corner Counter Worksurface  | 15" | 14 ^{13/16"} | 15" | 1 ^{1/4"} | D1R 1515S | 185. | 207. | 224. | 513. |
| 15" Deep Rectangular Counter Worksurface  | 24" | 23 ^{13/16"} | 15" | 1 ^{1/4"} | D1R 2415 | 233. | 256. | 279. | 530. |
| | 30" | 29 ^{13/16"} | 15" | 1 ^{1/4"} | D1R 3015 | 252. | 277. | 300. | 554. |
| | 36" | 35 ^{13/16"} | 15" | 1 ^{1/4"} | D1R 3615 | 258. | 284. | 309. | 580. |
| | 42" | 41 ^{13/16"} | 15" | 1 ^{1/4"} | D1R 4215 | 259. | 285. | 311. | 602. |
| | 48" | 47 ^{13/16"} | 15" | 1 ^{1/4"} | D1R 4815 | 259. | 285. | 311. | 627. |
| | 54" | 54 ^{13/16"} | 15" | 1 ^{1/4"} | D1R 5415 | 269. | 295. | 325. | 649. |
| | 60" | 59 ^{13/16"} | 15" | 1 ^{1/4"} | D1R 6015 | 285. | 315. | 344. | 674. |
| | 66" | 65 ^{13/16"} | 15" | 1 ^{1/4"} | D1R 6615 | 295. | 326. | 356. | 698. |
| | 72" | 71 ^{13/16"} | 15" | 1 ^{1/4"} | D1R 7215 | 324. | 356. | 388. | 721. |
| | 78" | 77 ^{13/16"} | 15" | 1 ^{1/4"} | D1R 7815 | 344. | 377. | 412. | 744. |
| | 84" | 83 ^{13/16"} | 15" | 1 ^{1/4"} | D1R 8415 | 360. | 397. | 433. | 769. |
| | 90" | 89 ^{13/16"} | 15" | 1 ^{1/4"} | D1R 9015 | 379. | 417. | 453. | 794. |
| | 96" | 95 ^{13/16"} | 15" | 1 ^{1/4"} | D1R 9615 | 397. | 437. | 475. | 817. |



w* = nominal width

Dimensions listed under w d are actual to the nearest 1/16"

| Ordering Information | Order Code | Included with: | Options |
|---|---|--|---|
| 15"D Counter Worksurface 1. Pattern Number 2. Top Finish Type 3. Edge Finish 4. Counter Worksurface Bracket Finish | 15"D Counter Worksurface <i>Example:</i> D1R 3615, 117, 117, 117 D1R 3615 Pattern Number 117 Soft Grey Laminate 117 Soft Grey Edge Band 117 Soft Grey Bracket Finish | 15"D Counter Worksurface • Four counter worksurface brackets • Attachment hardware | 15"D Counter Worksurface • Woodgrain ABS edge • Metal edge • Techwood edge |
| Square-Shape Corner Counter Worksurface 1. Pattern Number 2. Top Finish Type 3. Edge Finish | Square-Shape Counter Worksurface <i>Example:</i> D1R 1515S, 117, 117 D1R Pattern Number 1515S 117 Soft Grey Laminate 117 Soft Grey Edge Band | Square-Shape Counter Worksurface • Three counter worksurface flat brackets • Attachment hardware | Square-Shape Counter Worksurface • Woodgrain ABS edge • Metal edge • Techwood edge |
| Quarter-Round Shape Counter Worksurface 1. Pattern Number 2. Top Finish Type 3. Edge Finish | Quarter-Round Shape Counter Worksurface <i>Example:</i> D1R 1515C, 117, 117 D1R Pattern Number 1515C 117 Soft Grey Laminate 117 Soft Grey Edge Band | Quarter-Round Shape Counter Worksurface • Two counter worksurface flat brackets • Attachment hardware Note: An upcharge applies when specifying Legacy laminates. See Legacy finish page. | Quarter-Round Shape Counter Worksurface • Woodgrain ABS edge • Metal edge • Techwood edge |

Rectangular with Cascade Edge 24" and 30" Deep

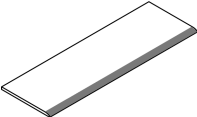
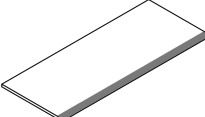
Dividends Horizon

| description | w | d | t | pattern no. | Solid | Woodgrain |
|--|-----|--------|-------------------|-------------------|--------|-----------|
| 24" D Rectangular  | 24" | 24" | 1 1/4" | DCE1R2424N | \$222. | \$255. |
| | 30" | 24" | 1 1/4" | DCE1R3024N | 255. | 293. |
| | 36" | 24" | 1 1/4" | DCE1R3624N | 281. | 324. |
| | 42" | 24" | 1 1/4" | DCE1R4224N | 324. | 373. |
| | 48" | 24" | 1 1/4" | DCE1R4824N | 364. | 419. |
| | 54" | 24" | 1 1/4" | DCE1R5424N | 391. | 449. |
| | 60" | 24" | 1 1/4" | DCE1R6024N | 424. | 488. |
| | 66" | 24" | 1 1/4" | DCE1R6624N | 459. | 526. |
| | 72" | 24" | 1 1/4" | DCE1R7224N | 479. | 551. |
| | 78" | 24" | 1 1/4" | DCE1R7824N | 515. | 591. |
| | 84" | 24" | 1 1/4" | DCE1R8424N | 544. | 625. |
| | 90" | 24" | 1 1/4" | DCE1R9024N | 614. | 704. |
| 96" | 24" | 1 1/4" | DCE1R9624N | 670. | 770. | |
| 30" D Rectangular  | 24" | 30" | 1 1/4" | DCE1R2430N | 282. | 326. |
| | 30" | 30" | 1 1/4" | DCE1R3030N | 317. | 364. |
| | 36" | 30" | 1 1/4" | DCE1R3630N | 353. | 406. |
| | 42" | 30" | 1 1/4" | DCE1R4230N | 383. | 439. |
| | 48" | 30" | 1 1/4" | DCE1R4830N | 424. | 488. |
| | 54" | 30" | 1 1/4" | DCE1R5430N | 480. | 552. |
| | 60" | 30" | 1 1/4" | DCE1R6030N | 528. | 606. |
| | 66" | 30" | 1 1/4" | DCE1R6630N | 589. | 677. |
| | 72" | 30" | 1 1/4" | DCE1R7230N | 614. | 704. |
| | 78" | 30" | 1 1/4" | DCE1R7830N | 654. | 752. |
| | 84" | 30" | 1 1/4" | DCE1R8430N | 696. | 800. |
| | 90" | 30" | 1 1/4" | DCE1R9030N | 748. | 860. |
| 96" | 30" | 1 1/4" | DCE1R9630N | 800. | 919. | |
| Sample  | 12" | 12" | 1 1/4" | DCE1R1212G | 137. | 159. |

Ordering Information

1. Pattern Number
2. Top Finish Type

Order Code

| Worksurfaces | |
|--------------------------|------------------------------------|
| Example: DCE1R4824N, 118 | |
| DCE1 | Dividends Cascade Edge Worksurface |
| R | Rectangular |
| 48 | Width |
| 24 | Depth |
| N | No Grommet |
| 118 | Bright White finish |

Included with:

Specify worksurface supports separately.

Available Colors:

| Solid: | |
|--------|----------------|
| 114 | Folkstone Grey |
| 117 | Soft Grey |
| 118 | Bright White |
| 119 | Pumice |

Woodgrain:

| | |
|-----|----------------|
| 124 | Medium Cherry |
| 125 | Natural Maple |
| 126 | Natural Cherry |
| 127 | Walnut |

Options

Worksurfaces

- Center-Located Edge Grommet
To specify, replace the "N" suffix from the pattern number with "G".

Add \$22.

Shaded area on worksurface drawings represents cascade edge detail.

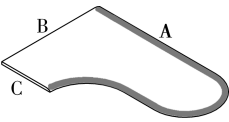
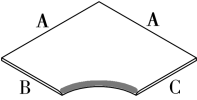
| description | A | B | C | pattern no. | Solid | Woodgrain |
|--|-----|-----|-----|-------------------------|--------|-----------|
| Blended “D”  right hand shown | 66" | 48" | 24" | DCE1BD6648S(L/R) | \$898. | \$1,032. |
| | 66" | 48" | 30" | DCE1BD6648D(L/R) | 943. | 1,086. |
| | 72" | 48" | 24" | DCE1BD7248S(L/R) | 917. | 1,057. |
| | 72" | 48" | 30" | DCE1BD7248D(L/R) | 978. | 1,125. |
| | 78" | 48" | 24" | DCE1BD7848S(L/R) | 1,060. | 1,219. |
| | 78" | 48" | 30" | DCE1BD7848D(L/R) | 1,096. | 1,259. |
| | 84" | 48" | 24" | DCE1BD8448S(L/R) | 1,089. | 1,252. |
| | 84" | 48" | 30" | DCE1BD8448D(L/R) | 1,158. | 1,330. |
| Blended “L”  | 36" | 24" | 24" | DCE1L3636SSN | 554. | 639. |
| | 42" | 24" | 24" | DCE1L4242SSN | 670. | 770. |
| | 42" | 24" | 30" | DCE1L4242SDN | 796. | 913. |
| | 42" | 30" | 24" | DCE1L4242DSN | 796. | 913. |
| | 48" | 24" | 24" | DCE1L4848SSN | 752. | 865. |
| | 48" | 24" | 30" | DCE1L4848SDN | 901. | 1,036. |
| | 48" | 30" | 24" | DCE1L4848DSN | 901. | 1,036. |
| | 48" | 30" | 30" | DCE1L4848DDN | 808. | 930. |

Ordering Information

1. Pattern Number
2. Top Finish Type

Order Code

| Worksurfaces | |
|-----------------|------------------------------------|
| <i>Example:</i> | DCE1BD7248SL, 118 |
| DCE1 | Dividends Cascade Edge worksurface |
| BD | Blended “D” |
| 72 | Width |
| 48 | Depth |
| S | 24”d return |
| L | Extended Left |
| 118 | Bright White |

Included with:

| | |
|-------------------|----------------|
| Available Colors: | |
| Solid: | |
| 114 | Folkstone Grey |
| 117 | Soft Grey |
| 118 | Bright White |
| 119 | Pumice |
| Woodgrain: | |
| 124 | Medium Cherry |
| 125 | Natural Maple |
| 126 | Natural Cherry |
| 127 | Walnut |

Options

| |
|--|
| Worksurfaces |
| <ul style="list-style-type: none"> Center-Located Edge Grommet (Blended “L” only)To specify, replace the “N” suffix from the pattern number with “G”. Add \$44. |
| Note: Support column and panel-to-worksurface brackets must be ordered separately. |
| Shaded area on worksurface drawings represents cascade edge detail. |
| Note: When wood grain or brushed laminates are specified on Cascade corner worksurfaces with two “A” sides of equal length, one of three grain direction options must be specified. Insert the desired grain direction option (L,R or D) after the laminate code. Please add \$26 to the list price for diagonal grain (D) selection. |

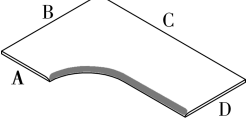
| description | Width B | Width C | Width A | Width D | t | pattern no. | Solid | Woodgrain |
|--|---------|---------|---------|---------|---------------------|---------------------|--------|-----------|
| Blended “L”  | 42" | 60" | 24" | 24" | 1 1/4" | DCE1L4260SSN | \$919. | \$1,058. |
| | 42" | 66" | 24" | 24" | 1 1/4" | DCE1L4266SSN | 943. | 1,086. |
| | 42" | 72" | 24" | 24" | 1 1/4" | DCE1L4272SSN | 979. | 1,127. |
| | 42" | 78" | 24" | 24" | 1 1/4" | DCE1L4278SSN | 991. | 1,138. |
| | 48" | 60" | 24" | 24" | 1 1/4" | DCE1L4860SSN | 932. | 1,070. |
| | 48" | 60" | 24" | 30" | 1 1/4" | DCE1L4860SDN | 913. | 1,052. |
| | 48" | 60" | 30" | 24" | 1 1/4" | DCE1L4860DSN | 913. | 1,052. |
| | 48" | 66" | 24" | 24" | 1 1/4" | DCE1L4866SSN | 965. | 1,109. |
| | 48" | 66" | 24" | 30" | 1 1/4" | DCE1L4866SDN | 961. | 1,106. |
| | 48" | 66" | 30" | 24" | 1 1/4" | DCE1L4866DSN | 961. | 1,106. |
| | 48" | 72" | 24" | 24" | 1 1/4" | DCE1L4872SSN | 1,000. | 1,150. |
| | 48" | 72" | 24" | 30" | 1 1/4" | DCE1L4872SDN | 1,006. | 1,158. |
| | 48" | 72" | 30" | 24" | 1 1/4" | DCE1L4872DSN | 1,006. | 1,158. |
| | 48" | 78" | 24" | 24" | 1 1/4" | DCE1L4878SSN | 1,102. | 1,268. |
| | 48" | 84" | 24" | 24" | 1 1/4" | DCE1L4884SSN | 1,239. | 1,426. |
| | 60" | 42" | 24" | 24" | 1 1/4" | DCE1L6042SSN | 919. | 1,058. |
| | 60" | 48" | 24" | 24" | 1 1/4" | DCE1L6048SSN | 932. | 1,070. |
| | 60" | 48" | 24" | 30" | 1 1/4" | DCE1L6048SDN | 913. | 1,052. |
| | 60" | 48" | 30" | 24" | 1 1/4" | DCE1L6048DSN | 913. | 1,052. |
| | 66" | 42" | 24" | 24" | 1 1/4" | DCE1L6642SSN | 943. | 1,086. |
| | 66" | 48" | 24" | 24" | 1 1/4" | DCE1L6648SSN | 965. | 1,109. |
| | 66" | 48" | 24" | 30" | 1 1/4" | DCE1L6648SDN | 961. | 1,106. |
| | 66" | 48" | 30" | 24" | 1 1/4" | DCE1L6648DSN | 961. | 1,106. |
| | 72" | 42" | 24" | 24" | 1 1/4" | DCE1L7242SSN | 979. | 1,127. |
| | 72" | 48" | 24" | 24" | 1 1/4" | DCE1L7248SSN | 1,000. | 1,150. |
| | 72" | 48" | 24" | 30" | 1 1/4" | DCE1L7248SDN | 1,006. | 1,158. |
| | 72" | 48" | 30" | 24" | 1 1/4" | DCE1L7248DSN | 1,006. | 1,158. |
| | 78" | 42" | 24" | 24" | 1 1/4" | DCE1L7842SSN | 991. | 1,138. |
| 78" | 48" | 24" | 24" | 1 1/4" | DCE1L7848SSN | 1,102. | 1,268. | |
| 84" | 48" | 24" | 24" | 1 1/4" | DCE1L8448SSN | 1,239. | 1,426. | |

Ordering Information

1. Pattern Number
2. Top Finish Type

Order Code





| | |
|--------------|------------------------------------|
| Worksurfaces | |
| Example: | DCE1L4872SDG,114 |
| DCE1 | Dividends Cascade Edge worksurface |
| L | Blended “L” |
| 48 | Width |
| 72 | Depth |
| S | 24”d, left side |
| D | 30”d, right side |
| G | Grommet |
| 114 | Folkstone Grey |

Included with:

| | |
|-------------------|----------------|
| Available Colors: | |
| Solid: | |
| 114 | Folkstone Grey |
| 117 | Soft Grey |
| 118 | Bright White |
| 119 | Pumice |
| Woodgrain: | |
| 124 | Medium Cherry |
| 125 | Natural Maple |
| 126 | Natural Cherry |
| 127 | Walnut |

Options

- Worksurfaces**
- Center-Located Edge Grommet
To specify, replace the “N” suffix from the pattern number with “G”.
Add \$44.
- Note:** Specify the panel-to-worksurface brackets separately.
- Shaded area on worksurface drawings represents cascade edge detail.

| description | w | d | t | pattern no. | Solid | Woodgrain |
|---|-----|-----|--------|-------------------|--------|-----------|
|  | 48" | 18" | 1 1/4" | DCE1H4818 | \$479. | \$551. |
| | 48" | 18" | 1 1/4" | DCE1H4818P | 479. | 551. |
| | 60" | 24" | 1 1/4" | DCE1H6024 | 659. | 760. |
| | 60" | 24" | 1 1/4" | DCE1H6024P | 659. | 760. |
| LH Corner Round | 24" | 24" | 1 1/4" | DCE1CR24L | 255. | 293. |
|  | | | | | | |
| | | | | | | |
| RH Corner Round | 24" | 24" | 1 1/4" | DCE1CR24R | 255. | 293. |
|  | | | | | | |
| | | | | | | |
| Notched Corner Round | 24" | 24" | 1 1/4" | DCE1CR24N | 255. | 293. |
|  | | | | | | |
| | | | | | | |

Ordering Information

1. Pattern Number
2. Top Finish Type

Order Code

| | |
|--------------|------------------------------------|
| Worksurfaces | |
| Example: | DCE1H4818P,117 |
| DCE1 | Dividends Cascade Edge worksurface |
| H | Half Round |
| 48 | Width |
| 18 | Depth |
| P | Notched for panel |
| 117 | Soft Grey |

Included with:

| | |
|-------------------|----------------|
| Available Colors: | |
| Solid: | |
| 114 | Folkstone Grey |
| 117 | Soft Grey |
| 118 | Bright White |
| 119 | Pumice |
| Woodgrain: | |
| 124 | Medium Cherry |
| 125 | Natural Maple |
| 126 | Natural Cherry |
| 127 | Walnut |

Options

P= Notched for panel

Note: Specify all support brackets separately.

Shaded area on worksurface drawings represents cascade edge detail.

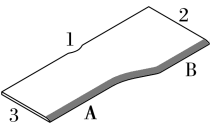
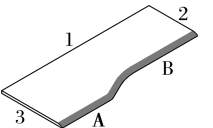
| description | 1 | 2 | 3 | A | B | t | pattern no. | Solid | Woodgrain |
|---|-----|-----|-----|---------|---------|--------|---------------------|--------|-----------|
| Wave End, RH  | 36" | 30" | 24" | 3" | 15" | 1 1/4" | DCE1W362430N | \$596. | \$685. |
| | 42" | 30" | 24" | 9" | 15" | 1 1/4" | DCE1W422430N | 626. | 721. |
| | 48" | 30" | 24" | 15" | 15" | 1 1/4" | DCE1W482430N | 671. | 772. |
| | 72" | 30" | 24" | 30 1/2" | 23 1/2" | 1 1/4" | DCE1W722430N | 854. | 980. |
| <i>shown with grommet</i> | | | | | | | | | |
| Wave End, LH  | 36" | 24" | 30" | 15" | 3" | 1 1/4" | DCE1W363024N | 596. | 685. |
| | 42" | 24" | 30" | 15" | 9" | 1 1/4" | DCE1W423024N | 626. | 721. |
| | 48" | 24" | 30" | 15" | 15" | 1 1/4" | DCE1W483024N | 671. | 772. |
| | 72" | 24" | 30" | 23 1/2" | 30 1/2" | 1 1/4" | DCE1W723024N | 854. | 980. |

Ordering Information

1. Pattern Number
2. Top Finish Type

Order Code

| | |
|--------------|-------------------|
| Worksurfaces | |
| Example: | DCE1W483024N,118 |
| DCE1 | Dividends Cascade |
| | Edge worksurface |
| W | Wave End |
| 48 | Width |
| 30 | 30"d, left side |
| 24 | 24"d, right side |
| N | No grommet |
| 118 | Bright White |

Included with:

| | |
|-------------------|----------------|
| Available Colors: | |
| Solid: | |
| 114 | Folkstone Grey |
| 117 | Soft Grey |
| 118 | Bright White |
| 119 | Pumice |
| Woodgrain: | |
| 124 | Medium Cherry |
| 125 | Natural Maple |
| 126 | Natural Cherry |
| 127 | Walnut |

Options

- Worksurfaces**
- Center-Located Edge Grommet
To specify, replace the "N" suffix from the pattern number with "G".
Add \$21.
- Note:** Specify all support brackets separately.
- Shaded area on worksurface drawings represents cascade edge detail.

This page intentionally left blank

Worksurface Supports

Worksurfaces are shipped without supports which must be ordered separately.

A variety of worksurface supports are available. They include:

- Cantilevers
- Flat brackets
- Panel-to-worksurface brackets

In addition, freestanding pedestals and end units can also be used for worksurface support.

Cantilevers and panel-to-worksurface brackets are used strictly in panel-mount applications while flat brackets, pedestals and end units can be used in both panel-mounted and freestanding applications.

Cantilevers

Cantilevers provide panel-hung worksurface support when the worksurface width runs parallel to the panel run.

Primary cantilever applications include:

- Corner worksurfaces
- Worksurface mid-span support
- 18" and 24" deep rectangular worksurface support in moderate load situations

Note: For heavy load applications, panel-to-worksurface brackets, freestanding pedestal, panel-mount C-leg, or open support leg is recommended. In applications involving 30" deep worksurfaces, cantilevers are only recommended for mid-span support.

Cantilevers are left- and right-handed and are available in three depths (18", 24" and 30") to support 18", 24" and 30" deep worksurfaces.

Note: 36" deep worksurfaces cannot be supported by cantilevers.

• **Attachment:** Cantilevers lock into the panel's slotted standard and adjust vertically in 1 1/2" increments. Cantilevers are left- or right-handed

• **Construction:** 14-gauge, black painted steel

Flat Brackets

Flat brackets are used to join a primary worksurface with an adjacent return or bridge unit worksurface at the same height.

Flat brackets are available in three depths to support 18", 24" and 30" deep worksurface returns.

• **Attachment:** Flat brackets attach to pre-drilled positions on the undersides of worksurfaces with provided screws

• **Construction:** 14-gauge painted steel

Shared Cantilevers

Adjacent worksurfaces can share a single cantilever if the appropriate flat bracket is used in conjunction with the appropriate cantilever (i.e. 18" cantilever with 18" flat bracket).

Panel-to-Worksurface Brackets, Worksurface Support

Panel-to-worksurface brackets are used to:

- Mount worksurfaces perpendicular to panels
- Anchor the rear corner of corner worksurfaces to panels
- Secure a panel to a pedestal

Panel-to-worksurface brackets provide the most secure panel-hung support for heavily loaded worksurfaces.

Panel worksurface brackets are handed left or right.

Note: The panel width must match the worksurface depth for panel-to-worksurface brackets to connect worksurfaces perpendicular to panels.

• **Attachment:** Panel-to-worksurface brackets lock into the panel's slotted standard and adjust vertically in 1 1/2" increments

• **Construction:** 14-gauge painted steel

Panel-to-Worksurface Brackets, Stabilizing Support

Panel-to-worksurface brackets are also used in conjunction with pedestals to stabilize panel runs.

In applications where the worksurface is "wrapped" with a return panel and a pedestal is installed below the worksurface at the "wrapped" end, a panel-to-worksurface bracket is used at the front corner of the worksurface. In pedestal applications, the panel-to-worksurface bracket connects the pedestal at the rear corner of the pedestal to the panel (as shown in the illustration below) or front corner of the pedestal to the panel when a return wing panel is used.

Panel-to-Worksurface Brackets, Off-Module Support

For applications where the width of the panel exceeds the depth of the worksurface, specify off-module panel-to-worksurface brackets which allow off module worksurface support.

Worksurface Reinforcement

Worksurface reinforcements are required for worksurface spans greater than 48 inches. This includes freestanding desk worksurfaces over 48 inches using desk end units. Worksurface reinforcements have a black paint finish.

Panel Mounted Worksurface Bracket Application

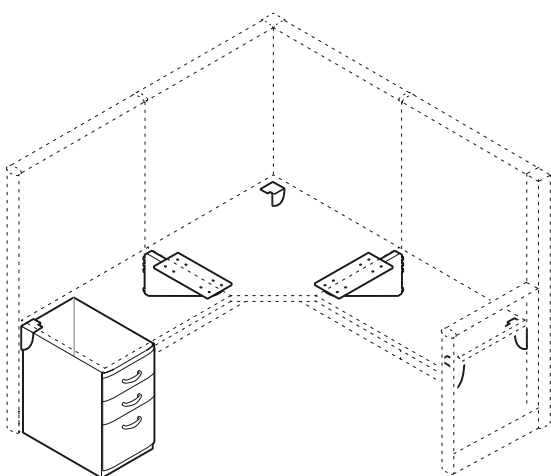

Flat Bracket Application

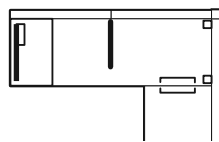

Shared Cantilever Application

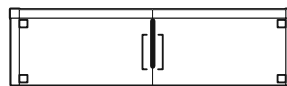

Stabilizing Support

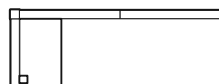

Off-Module Support

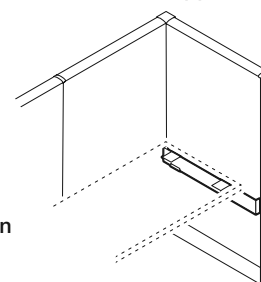



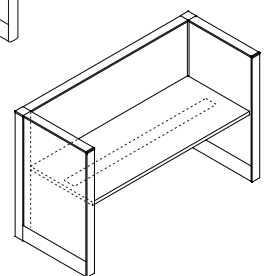

Worksurface Reinforcement Panel Hung Application



Panel Mounted Worksurface Brackets

Cantilevers, Flat Brackets and Panel-to-Worksurface Brackets

Dividends Horizon

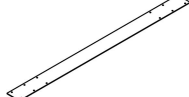
| description | type | w | d | h | pattern no. | black | P1 | P2 | P3 |
|---|-------------|----------------------------------|------------------------------------|------------------------------------|----------------------------|--------|--------|--------|--------|
| Cantilever Bracket Left or Right (Left Shown) (package of 10)  | For 18"D WS | 1 ⁵ / ₁₆ " | 12 ³ / ₁₆ " | 11 ¹³ / ₁₆ " | DB1C 18 (L or R) 10 | \$405. | \$425. | \$445. | \$465. |
| | For 24"D WS | 1 ⁵ / ₁₆ " | 20 ⁵ / ₈ " | 10 ¹ / ₂ " | DB1C 24 (L or R) 10 | 504. | 529. | 554. | 581. |
| | For 30"D WS | 1 ⁵ / ₁₆ " | 26 ¹⁵ / ₁₆ " | 10 ¹ / ₂ " | DB1C 30 (L or R) 10 | 721. | 757. | 791. | 829. |
| Cantilever Brackets, Left or Right (Left Shown) (single pack)  | For 18"D WS | 1 ⁵ / ₁₆ " | 12 ³ / ₁₆ " | 11 ¹³ / ₁₆ " | DB1C18 (L or R) | 50. | 52. | 55. | 56. |
| | For 24"D WS | 1 ⁵ / ₁₆ " | 20 ⁵ / ₈ " | 10 ¹ / ₂ " | DB1C24 (L or R) | 63. | 68. | 72. | 74. |
| | For 30"D WS | 1 ⁵ / ₁₆ " | 26 ¹⁵ / ₁₆ " | 10 ¹ / ₂ " | DB1C30 (L or R) | 89. | 94. | 99. | 103. |
| Cantilever Brackets for 120° Planning (Left Shown)(single pack)  | | 20 ⁵ / ₈ " | | 1 ⁵ / ₁₆ " | DB120C (L or R) | 63. | 68. | 72. | 74. |
| Flat Bracket (single pack)  | For 18"D WS | 3 ³ / ₄ " | 8 ⁵ / ₁₆ " | | DB1F18SP | 16. | 0. | 0. | 0. |
| | For 24"D WS | 3 ³ / ₄ " | 14 ⁵ / ₈ " | | DB1F24SP | 28. | 0. | 0. | 0. |
| | For 30"D WS | 3 ³ / ₄ " | 20 ¹⁵ / ₁₆ " | | DB1F30SP | 32. | 0. | 0. | 0. |
| Flat Bracket (package of 10)  | For 18"D WS | 3 ³ / ₄ " | 8 ⁵ / ₁₆ " | | DB1F18TP | 137. | 0. | 0. | 0. |
| | For 24"D WS | 3 ³ / ₄ " | 14 ⁵ / ₁₆ " | | DB1F24TP | 237. | 0. | 0. | 0. |
| | For 30"D WS | 3 ³ / ₄ " | 20 ⁵ / ₁₆ " | | DB1F30TP | 261. | 0. | 0. | 0. |
| Worksurface Reinforcement  | | 54" | 4" | | DB1WR54 | 66. | 0. | 0. | 0. |
| | | 60" | 4" | | DB1WR60 | 67. | 0. | 0. | 0. |
| | | 66" | 4" | | DB1WR66 | 70. | 0. | 0. | 0. |
| | | 72" | 4" | | DB1WR72 | 72. | 0. | 0. | 0. |

Worksurface Supports

| Ordering Information | Order Code | Included with: | Options |
|--|--|--|---|
| Panel-to-Worksurface Bracket, Off Module 1. Pattern Number 2. Trim Finish | Panel-to-Worksurface Bracket, Off Module <i>Example:</i> DB1P WS36, 113 <hr/> DB1P Pattern Number WS36 <hr/> 113 Dark Grey Finish | Panel-to-Worksurface Bracket, Off Module <ul style="list-style-type: none"> • Trim finish mounting rail • Worksurface brackets | Panel-to-Worksurface Bracket, Off Module |

Panel Mounted Worksurface Brackets

Cantilevers, Flat Brackets and Panel-to-Worksurface Brackets

Dividends Horizon

| description | type | w | d | h | pattern no. | black | P1 | P2 | P3 |
|---|--------------|----|----|-----------------------------------|----------------|-------|------|-------|-------|
|  Panel-to-Worksurface Brackets | Left (Shown) | 3" | 3" | 4 ¹¹ / ₁₆ " | DB1PWSL | \$9. | \$9. | \$10. | \$11. |
| | Pair | 3" | 3" | 4 ¹¹ / ₁₆ " | DB1PWSP | 19. | 19. | 21. | 24. |
| | Right | 3" | 3" | 4 ¹¹ / ₁₆ " | DB1PWSR | 9. | 9. | 10. | 11. |

| | | | | | | | | | |
|--|--------------|----|----|-----------------------------------|------------------|-----|-----|-----|-----|
|  Panel-to-Worksurface Brackets (package of 10) | Left (Shown) | 3" | 3" | 4 ¹¹ / ₁₆ " | DB1PWSL10 | 75. | 75. | 85. | 97. |
| | Right | 3" | 3" | 4 ¹¹ / ₁₆ " | DB1PWSR10 | 75. | 75. | 85. | 97. |

| | | | | | | | | | |
|--|-------|----|----|-----------------------------------|------------------|-----|-----|-----|-----|
|  Panel-to-Worksurface Brackets for use with Worksurface Height Panels ONLY | Left | 3" | 3" | 4 ¹¹ / ₁₆ " | DB1PWSLWH | 24. | 26. | 28. | 30. |
| | Pair | 3" | 3" | 4 ¹¹ / ₁₆ " | DB1PWSPWH | 47. | 51. | 56. | 60. |
| | Right | 3" | 3" | 4 ¹¹ / ₁₆ " | DB1PWSRWH | 24. | 26. | 28. | 30. |

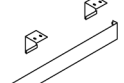
| | | | | | | | | | |
|---|--------------------|--|--|--|-----------------|----|-----|-----|------|
|  Panel-to-Worksurface Brackets (Off Module) | For 24" Wide Panel | | | | DB1PWS24 | 0. | 70. | 75. | 77. |
| | For 30" Wide Panel | | | | DB1PWS30 | 0. | 73. | 79. | 83. |
| | For 36" Wide Panel | | | | DB1PWS36 | 0. | 76. | 83. | 87. |
| | For 42" Wide Panel | | | | DB1PWS42 | 0. | 81. | 92. | 98. |
| | For 48" Wide Panel | | | | DB1PWS48 | 0. | 87. | 98. | 101. |

Ordering Information

Panel-to-Worksurface Bracket, Off Module

1. Pattern Number
2. Trim Finish

Order Code

Panel-to-Worksurface Bracket, Off Module

Example: **DB1P WS36, 113**

| | |
|-------------|------------------|
| DB1P | Pattern Number |
| WS36 | |
| 113 | Dark Grey Finish |

Included with:

Panel-to-Worksurface Bracket, Off Module

- Trim finish mounting rail
- Worksurface brackets

Options

Panel-to-Worksurface Bracket, Off Module

This page intentionally left blank

Screen-to-Worksurface Brackets, Worksurface Support

Screen-to-worksurface brackets are used to:

- Mount worksurfaces perpendicular to screens
- Anchor the rear corner of corner worksurfaces to screens

Screen-to-worksurface brackets provide the most secure screen-hung support for heavily loaded worksurfaces.

Screen worksurface brackets are handed left or right.

Note: The screen width must match the worksurface depth for screen-to-worksurface brackets to connect worksurfaces perpendicular to screens.

- **Attachment:** Screen-to-worksurface brackets lock into the screen's slotted standard and adjust vertically in 1 1/2" increments
- **Construction:** 14-gauge painted steel

Screen-to-Worksurface Support Application

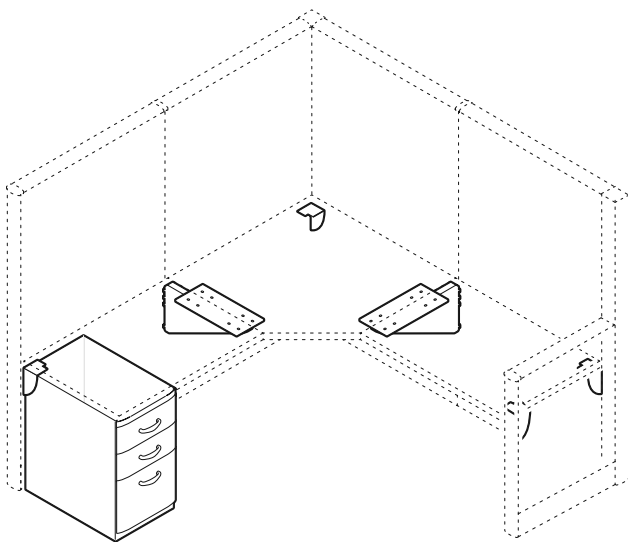

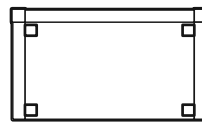

Screen-to-Worksurface Brackets



Screen-to-Worksurface Brackets

Screen mid-span worksurface support

| description | type | w | d | h | pattern no. | P1 | P2 | P3 |
|---|------------|---|---|---|----------------|------|------|-------|
| Screen-to-Worksurface Brackets (Individual) | Left | | | | DB1SWSL | \$7. | \$9. | \$12. |
| | Right | | | | DB1WSR | 7. | 9. | 12. |
|  | | | | | | | | |
| Screen-to-Worksurface Brackets (Pair) | Left/Right | | | | DB1SWSP | 15. | 20. | 26. |
| Screen Mid-Span Worksurface Support | left hand | | | | DBSMLH | 26. | 27. | 28. |
| | right hand | | | | DBSMRH | 26. | 27. | 28. |
|  | | | | | | | | |

Ordering Information

Panel-to-Worksurface Bracket, Off Module

1. Pattern Number
2. Trim Finish

Order Code

Panel-to-Worksurface Bracket, Off Module

Example: **DB1P WS36, 113**

DB1P Pattern Number

WS36

113 Dark Grey Finish

Included with:

Panel-to-Worksurface Bracket, Off Module

- Trim finish mounting rail
- Worksurface brackets

Options

Panel-to-Worksurface Bracket, Off Module

Panel-Mounted C-Legs, Open Support Legs, and Worksurface End Panels

Panel-mounted C-legs, open support legs, and worksurface end panels provide panel-hung worksurface support when the worksurface width runs parallel to the panel run.

Primary panel-mounted support applications include:

- Rectangular worksurface end support for 24" and 30" depth worksurfaces
- Mid span worksurface support for 24" and 30" depth worksurfaces
- Corner and split top corner worksurface support
- Support for heavier worksurface load applications
- Shared support between two adjacent worksurfaces

Note: 18" deep and 36" worksurface may not be used with panel-mounted C-leg worksurface support.

Construction

C-leg support:

- Support foot: die cast aluminum
- Support leg: extruded aluminum
- Mounting bracket: $\frac{3}{16}$ " steel plate

Open Support Leg:

- Vertical members: extruded aluminum
- Top plate and spanner bar: 0.025" cold rolled steel
- Mounting brackets: $\frac{3}{16}$ " steel plate

Worksurface End Panel:

- Panel: 20 gauge steel
- Mounting brackets: 14 gauge steel

Note: Open support legs and worksurface end panels are only available in Knoll Core finishes

Note: The shared open support leg is designed for use where 2 panels meet. It cannot be used on the end of a panel run.

Note: Worksurface end panels are for use with panels only and are non-handed.

Panel-Mounted C-Leg Support

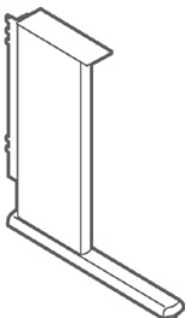

Panel-Mounted C-Leg Support (radiused foot)

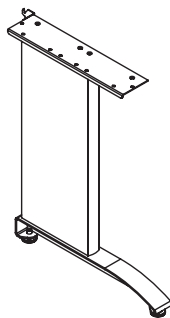

Open Support Leg

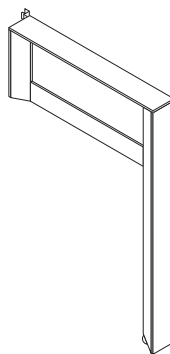

Worksurface End Panel

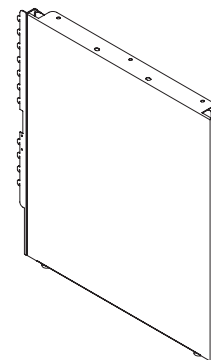

Panel Mounted Worksurface Supports

Open Support Leg, C-Leg and Worksurface End Panel

Dividends Horizon

Worksurface Supports

| description | type | w | d | h | pattern no. | P1 | P2 | P3 |
|---|-----------------------------|---------------------------------|-----|----------------------------------|-------------------|--------|--------|--------|
| Panel Mounted C-Leg Worksurface Support (Left-hand shown) | Left-hand C-Leg | | | 26 ⁷ / ₈ " | DB1CL24L | \$350. | \$384. | \$401. |
| | Right-hand C-Leg | | | 26 ⁷ / ₈ " | DB1CL 24R | 350. | 384. | 401. |
| | Shared C-Leg | | | 26 ⁷ / ₈ " | DB1CL24S | 370. | 407. | 427. |
| Panel Mounted C-Leg Worksurface Support Radiused Foot (Right-hand shown) | LH Shared Worksurface C-Leg | | | 26 ⁷ / ₈ " | DB2CL24LS | 439. | 486. | 504. |
| | LH Single Worksurface C-Leg | | | 26 ⁷ / ₈ " | DB2CL24L | 416. | 457. | 478. |
| | RH Shared Worksurface C-Leg | | | 26 ⁷ / ₈ " | DB2CL24RS | 439. | 486. | 504. |
| | RH Single Worksurface C-Leg | | | 26 ⁷ / ₈ " | DB2CL24R | 416. | 457. | 478. |
| Open Support Leg Panel Attachment | | 3" | 15" | 26 ⁷ / ₈ " | DB1LSP15() | 334. | 355. | 369. |
| | | 3" | 18" | 26 ⁷ / ₈ " | DB1LSP18() | 334. | 355. | 369. |
| | | 3" | 24" | 26 ⁷ / ₈ " | DB1LSP24() | 330. | 348. | 365. |
| | | 3" | 30" | 26 ⁷ / ₈ " | DB1LSP30() | 346. | 362. | 381. |
| | | 3" | 36" | 26 ⁷ / ₈ " | DB1LSP36() | 366. | 384. | 401. |
| Open Support Leg Screen Attachment | | 3" | 15" | 26 ⁷ / ₈ " | DB1LSS15() | 334. | 355. | 369. |
| | | 3" | 18" | 26 ⁷ / ₈ " | DB1LSS18() | 334. | 355. | 369. |
| | | 3" | 24" | 26 ⁷ / ₈ " | DB1LSS24() | 330. | 348. | 365. |
| | | 3" | 30" | 26 ⁷ / ₈ " | DB1LSS30() | 346. | 362. | 381. |
| | | 3" | 36" | 26 ⁷ / ₈ " | DB1LSS36() | 366. | 384. | 401. |
| Worksurface End Panel Panel Attachment | | 1 ¹ / ₄ " | 15" | 26 ⁷ / ₈ " | DB1PSP15 | 305. | 333. | 352. |
| | | 1 ¹ / ₄ " | 18" | 26 ⁷ / ₈ " | DB1PSP18 | 317. | 350. | 365. |
| | | 1 ¹ / ₄ " | 24" | 26 ⁷ / ₈ " | DB1PSP24 | 348. | 383. | 400. |
| | | 1 ¹ / ₄ " | 30" | 26 ⁷ / ₈ " | DB1PSP30 | 373. | 412. | 431. |
| | | 1 ¹ / ₄ " | 36" | 26 ⁷ / ₈ " | DB1PSP36 | 399. | 439. | 458. |

Ordering Information

Panel-Mounted C-Leg Worksurface Support

1. Pattern Number
2. Paint Finish

Worksurface End Panel

1. Pattern Number
2. Paint Finish

Open Support Leg

1. Pattern Number
2. Paint Finish

Order Code

Panel Mounted C-Leg Worksurface Support

Example: **DB1 CL24R, 117**

DB1 Pattern Number
CL24R

117 Soft Grey finish

Worksurface End Panel

Example: **DB1 PSP 24**

DB1 PSP Pattern Number
24

117 Soft Grey finish

Included with:

Panel-Mounted C-Leg Worksurface Support

- C-leg foot
- C-leg column
- Panel attachment bracket
- C-leg flat bracket
- Leveling glides

Worksurface End Panel

- Panel attachment bracket
- Leveling glides

Note: Open Support Legs are only available in Knoll core finishes.

Note: The shared open support leg is designed for use where 2 panels meet. It cannot be used at the end of a panel run.

Options

Open Support Leg Option

- (R) = Right-hand leg
(L) = Left-hand leg
(S) = Shared leg

Note: Worksurface end panels are for use with panels only.

Round Support Column

4" diameter round column may be used to support the rounded end of panel-mounted curvilinear half-round, "D", "P", "9", and blended "D" peninsula tops. Column is available in all Knoll core paint finishes

Construction

- Material: 4" diameter steel tube
- Mounting bracket: heavy gauge steel plate, 6 x 6

T-Support Column

The T-support column may be used to support the rounded end of a panel-mounted curvilinear half-round, "D", "P", "9", and blended "D" peninsula tops. The T-support column is recommended for use with "D" peninsula worksurfaces used in freestanding applications. The T-support column is available in all Dividends paint finishes.

Construction

T-support column specifications:

- Support foot: die cast aluminum
- Support leg: extruded aluminum
- Mounting bracket: heavy gauge steel plate

T-End Unit

The T-end unit is used on the end of a freestanding "D" peninsula worksurface top. The T-end is available in a depth of 24" and 30" for use with "D", "P" and "9" top depths of 24" and 30".

Construction

- Outer skin: 21-gauge steel
- Inner frame: 20-gauge steel
- Mounting brackets: 11-gauge steel

A Leg

An A leg may be used to support panel mounted curvilinear half-round, "D", "P", "9" and blended "D" peninsula tops. A legs are available in any Knoll Core paint finish.

Construction

- Vertical members: extruded aluminum
- Top plate and spanner bar: 0.025" cold rolled steel
- Mounting brackets: 14 gauge steel

Note: A legs are only available in Knoll Core finishes

Round Column with Panel "D" Worksurface

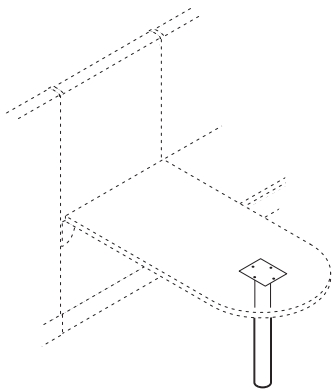

T-Support Base with Panel "D" Worksurface

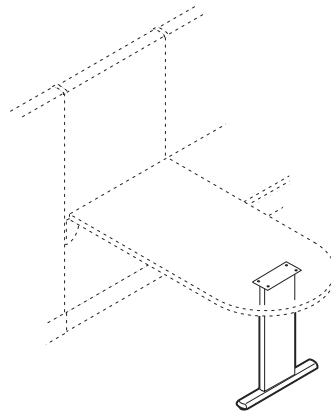

T-End Unit with Freestanding "D" Worksurface

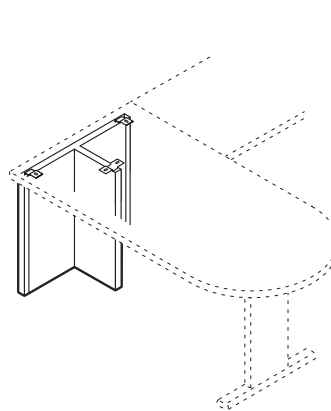

A-Leg with Panel "D" Worksurface

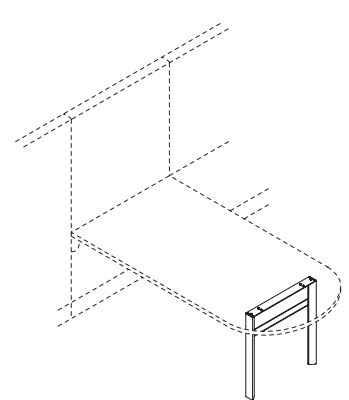





Peninsula Worksurface Supports

Round Support Column, T-Support Base and A Leg

Dividends Horizon

Worksurface Supports

| description | w | d | h | pattern no. | Black (NA) | P1 | P2 | P3 |
|--|------------------------------------|-----|----------------------------------|-----------------|------------|--------|--------|--------|
|  T-End Unit | 21 ¹³ / ₁₆ " | 12" | 26 ⁷ / ₈ " | DD1TEU24 | | \$330. | \$364. | \$381. |
| | 27 ¹³ / ₁₆ " | 12" | 26 ⁷ / ₈ " | DD1TEU30 | | 362. | 397. | 415. |
|  T-Support Base | 23 ¹ / ₂ " | 12" | 26 ⁷ / ₈ " | DB1TB | | 311. | 343. | 357. |
|  Round Support Column | 4" | 4" | 26 ⁷ / ₈ " | DB1S CR | 244. | 268. | 281. | 301. |
|  A Leg | 3" | 15" | 26 ⁷ / ₈ " | DB1LS15A | | 354. | 389. | 404. |
| | 3" | 18" | 26 ⁷ / ₈ " | DB1LS18A | | 365. | 401. | 417. |
| | 3" | 24" | 26 ⁷ / ₈ " | DB1LS24A | | 376. | 414. | 431. |
| | 3" | 30" | 26 ⁷ / ₈ " | DB1LS30A | | 390. | 427. | 444. |
| | 3" | 36" | 26 ⁷ / ₈ " | DB1LS36A | | 399. | 439. | 456. |

Dimensions listed under w d t are actual to the nearest 1/16"

| Ordering Information | Order Code | Included with: | Options |
|---|---|---|---|
| T-End Unit 1. Pattern Number 2. Paint Finish | T-End Unit <i>Example:</i> DD1TEU24, 115 DD1TEU24 Pattern Number 115 Medium Grey Paint Finish | T-End Unit • Worksurface T-Support Base Note: The A leg is for use in peninsula worksurface applications only. It is not to be used in freestanding applications. | T-End Unit T-Support Base A Leg Round Support Column |
| T-Support Base 1. Pattern Number 2. Paint Finish | T-Support Base <i>Example:</i> DB1TB, 115 DB1TB Pattern Number 115 Medium Grey Paint Finish | Note: A Legs are only available in Knoll core finishes. | |
| A Leg 1. Pattern Number 2. Paint Finish | | | |
| Round Support Column 1. Pattern Number 2. Paint Finish | Round Support Column <i>Example:</i> DB1SCR, 118 DB1SCR Pattern Number 118 Bright White Paint Finish | | |

Y Leg Tables

Freestanding and Credenza Supported Specifications

Dividends Horizon Tables

The design details of Dividends Horizon tables are consistent with the scale and visual language of the Dividends Horizon system. This design consistency makes Dividends Horizon tables appropriate for use in conference, meeting, private office and open plan office applications.

Dividends Horizon Y Leg tables are available in two versions:

- Freestanding Y Leg
- Credenza Supported Y Leg

Freestanding Y Leg Tables

Freestanding Y Leg tables include a worksurface and base assembly. All freestanding table sizes are available with two Y legs and a horizontal stretcher connecting the two columns.

In addition, 24 and 30 inch deep tables are available without a stretcher. Tables without stretcher include an integral worksurface support plate. 36 and 42 inch deep tables are available only with a stretcher.

Available Sizes

- Width: 60-96 inches
- Depth: 24-42 inches
- Height: 28-1/2 inches

Credenza Supported Y Leg Tables

The unique Dividends Horizon Credenza Supported Y Leg tables are designed to be used in concert with Dividends Horizon low credenzas, specified separately.

Credenza Supported Tables include one Y Leg, credenza support spacer, and a worksurface with integral stiffening plate.

Note: Credenza supported tables may be used with laminate or veneer top credenzas only, and are not compatible with steel top credenzas.

Available Sizes

- Width: 60-96 inches
- Depth: 24-36 inches
- Height: 28-1/2 inches

Optional Edge Grommet

Edge grommets are optional and can be factory installed centered along the rear edge of rectangular or racetrack freestanding or credenza supported Y Leg tables.

Construction

- Worksurface:
 - Material: 0.028 inch thick high pressure laminate or 0.6mm thick veneer on 1-1/8" particle board core
 - Edge: plastic laminate tops have a 2mm edgeband; Techwood tops have a 3/16 inch thick Techwood edge
- Bases:
 - Stretcher: extruded aluminum
 - Stiffening plate: 4 inch deep 12 gauge steel plate (length varies)
 - Foot: die cast aluminum
 - Column: extruded aluminum with 3/16 inch thick structural plate
 - Credenza support spacer: 2-15/16 inches high x 9-5/8 inches wide x 1-9/16 inches deep steel box with a flat bracket on top

Note: Dividends Horizon tables are only available in Knoll Core paint, laminate, and Techwood finishes. Legacy finishes are not available. All paint finishes have the Dividends Horizon textured paint finish; this includes 613 Silver, which is a smooth paint on all other Dividends Horizon products.

Note: The stiffening plate on tables without a stretcher prevents the field installation of a grommet or plexus box. (see illustration below)

24" Deep Freestanding Racetrack Y Leg Table with Stretcher



24" Deep Credenza Supported Racetrack Y Leg Table

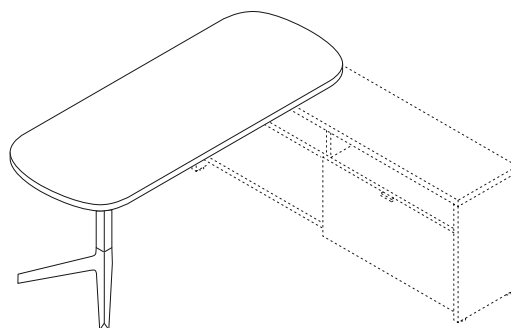

24" Deep Freestanding Racetrack Y Leg Table without Stretcher

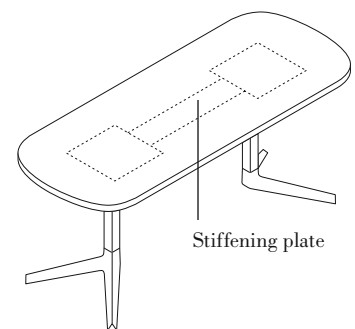

Y Leg Tables

Freestanding Rectangular Table Top

24" and 30" Deep

| description | w* | w | d | t | h | pattern no. | Laminate | Laminate | Laminate | Techgrain | Techgrain | Techgrain |
|---|-----|----------------------|--------------------|-------------------|--------------------|---------------------|-----------------|-----------------|-----------------|-----------------|-----------------|-----------------|
| | | | | | | | Top P1 Paint | Top P2 Paint | Top P3 Paint | Top P1 Paint | Top P2 Paint | Top P3 Paint |
| 24" Deep Rectangular with (2) Y-Legs, No Grommet | 60" | 59 ^{13/16"} | 23 ^{1/2"} | 1 ^{1/4"} | 28 ^{1/2"} | DT1ARY6024NS | \$1,656. | \$1,823. | \$1,896. | \$1,898. | \$2,087. | \$2,173. |
| | 66" | 65 ^{13/16"} | 23 ^{1/2"} | 1 ^{1/4"} | 28 ^{1/2"} | DT1ARY6624NS | 1,675. | 1,844. | 1,916. | 1,927. | 2,123. | 2,208. |
| | 72" | 71 ^{13/16"} | 23 ^{1/2"} | 1 ^{1/4"} | 28 ^{1/2"} | DT1ARY7224NS | 1,692. | 1,863. | 1,939. | 1,960. | 2,156. | 2,243. |
| | 78" | 77 ^{13/16"} | 23 ^{1/2"} | 1 ^{1/4"} | 28 ^{1/2"} | DT1ARY7824NS | 1,713. | 1,882. | 1,958. | 1,993. | 2,192. | 2,280. |
| | 84" | 83 ^{13/16"} | 23 ^{1/2"} | 1 ^{1/4"} | 28 ^{1/2"} | DT1ARY8424NS | 1,743. | 1,917. | 1,995. | 2,025. | 2,227. | 2,316. |
| | 90" | 89 ^{13/16"} | 23 ^{1/2"} | 1 ^{1/4"} | 28 ^{1/2"} | DT1ARY9024NS | 1,774. | 1,953. | 2,030. | 2,055. | 2,262. | 2,351. |
| | 96" | 95 ^{13/16"} | 23 ^{1/2"} | 1 ^{1/4"} | 28 ^{1/2"} | DT1ARY9624NS | 1,806. | 1,987. | 2,065. | 2,086. | 2,295. | 2,389. |

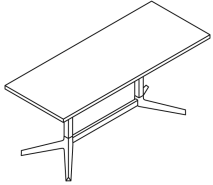

(with stretcher shown)

| | | | | | | | | | | | | |
|---|-----|----------------------|--------------------|-------------------|--------------------|---------------------|--------|--------|--------|--------|--------|--------|
| 30" Deep Rectangular with (2) Y-Legs, No Grommet | 60" | 59 ^{13/16"} | 29 ^{1/2"} | 1 ^{1/4"} | 28 ^{1/2"} | DT1ARY6030NS | 1,698. | 1,869. | 1,945. | 1,940. | 2,133. | 2,218. |
| | 66" | 65 ^{13/16"} | 29 ^{1/2"} | 1 ^{1/4"} | 28 ^{1/2"} | DT1ARY6630NS | 1,723. | 1,896. | 1,972. | 1,976. | 2,174. | 2,260. |
| | 72" | 71 ^{13/16"} | 29 ^{1/2"} | 1 ^{1/4"} | 28 ^{1/2"} | DT1ARY7230NS | 1,745. | 1,920. | 1,998. | 2,012. | 2,214. | 2,304. |
| | 78" | 77 ^{13/16"} | 29 ^{1/2"} | 1 ^{1/4"} | 28 ^{1/2"} | DT1ARY7830NS | 1,770. | 1,948. | 2,026. | 2,050. | 2,255. | 2,345. |
| | 84" | 83 ^{13/16"} | 29 ^{1/2"} | 1 ^{1/4"} | 28 ^{1/2"} | DT1ARY8430NS | 1,804. | 1,985. | 2,063. | 2,086. | 2,295. | 2,389. |
| | 90" | 89 ^{13/16"} | 29 ^{1/2"} | 1 ^{1/4"} | 28 ^{1/2"} | DT1ARY9030NS | 1,836. | 2,021. | 2,101. | 2,124. | 2,334. | 2,429. |
| | 96" | 95 ^{13/16"} | 29 ^{1/2"} | 1 ^{1/4"} | 28 ^{1/2"} | DT1ARY9630NS | 1,870. | 2,058. | 2,139. | 2,162. | 2,376. | 2,471. |

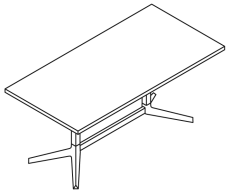

(with stretcher shown)

w* = nominal width
 Dimensions listed under w d t h are actual to the nearest 1/16"

| Ordering Information | Order Code | Included with: | Options |
|--|---|---|---|
| Freestanding Y Leg Table: 1. Pattern number 2. Base/Stretcher Paint Finish 3. Top Finish 4. Edge Finish | Freestanding Y Leg Table: <i>Example:</i> DT1ARY6024NS, 114, 114 <hr/> DT1 Dividends Horizon Table <hr/> A 2 Leg table assembly <hr/> R Rectangular shape <hr/> Y Y Leg Base <hr/> 60 Overall width in inches <hr/> 24 Overall depth in inches <hr/> N No grommet <hr/> S Stretcher <hr/> 114 Base/ stretcher paint finish <hr/> 114 Laminate top finish <hr/> 114 Edgeband finish | Freestanding Y Leg Table: <ul style="list-style-type: none"> (2) Y Legs Hardware kit Table top Stretcher or stiffening plate Note: Y Leg tables are finished with textured paint, including 613 Silver. Note: Y Leg Tables are only available in Knoll core finishes. | Grommet Option: <ul style="list-style-type: none"> To specify an edge grommet, replace the "N" suffix from the pattern number with an "E" and add \$17. Stretcher Option: <ul style="list-style-type: none"> A stretcher is optional on 24" and 30" deep tables ONLY. To specify a table without a stretcher replace the "S" suffix from the pattern number with an "N". Stretchers are required on 36" and 42" depths. |

Y Leg Tables

Freestanding Rectangular Table Top

36" and 42" Deep

| description | w* | w | d | t | h | pattern no. | Laminate | Laminate | Laminate | Techgrain | Techgrain | Techgrain |
|---|-----|----------------------|--------------------|-------------------|--------------------|--------------------|-----------------|-----------------|-----------------|-----------------|-----------------|-----------------|
| | | | | | | | Top P1 Paint | Top P2 Paint | Top P3 Paint | Top P1 Paint | Top P2 Paint | Top P3 Paint |
| 36" Deep Rectangular with (2) Y-Legs, No Grommet | 60" | 59 ^{13/16"} | 35 ^{1/2"} | 1 ^{1/4"} | 28 ^{1/2"} | DT1ARY6036N | \$1,756. | \$1,928. | \$2,007. | \$2,026. | \$2,228. | \$2,316. |
| | 66" | 65 ^{13/16"} | 35 ^{1/2"} | 1 ^{1/4"} | 28 ^{1/2"} | DT1ARY6636N | 1,786. | 1,964. | 2,043. | 2,064. | 2,272. | 2,361. |
| | 72" | 71 ^{13/16"} | 35 ^{1/2"} | 1 ^{1/4"} | 28 ^{1/2"} | DT1ARY7236N | 1,816. | 1,998. | 2,079. | 2,104. | 2,315. | 2,407. |
| | 78" | 77 ^{13/16"} | 35 ^{1/2"} | 1 ^{1/4"} | 28 ^{1/2"} | DT1ARY7836N | 1,847. | 2,032. | 2,113. | 2,143. | 2,359. | 2,453. |
| | 84" | 83 ^{13/16"} | 35 ^{1/2"} | 1 ^{1/4"} | 28 ^{1/2"} | DT1ARY8436N | 1,877. | 2,065. | 2,148. | 2,184. | 2,402. | 2,498. |
| | 90" | 89 ^{13/16"} | 35 ^{1/2"} | 1 ^{1/4"} | 28 ^{1/2"} | DT1ARY9036N | 1,907. | 2,099. | 2,183. | 2,224. | 2,448. | 2,543. |
| | 96" | 95 ^{13/16"} | 35 ^{1/2"} | 1 ^{1/4"} | 28 ^{1/2"} | DT1ARY9636N | 1,940. | 2,133. | 2,218. | 2,264. | 2,491. | 2,588. |

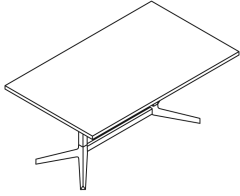

| | | | | | | | | | | | | |
|---|-----|----------------------|--------------------|-------------------|--------------------|--------------------|--------|--------|--------|--------|--------|--------|
| 42" Deep Rectangular with (2) Y-Legs, No Grommet | 84" | 83 ^{13/16"} | 42 ^{1/2"} | 1 ^{1/4"} | 28 ^{1/2"} | DT1ARY8442N | 1,925. | 2,120. | 2,206. | 2,444. | 2,688. | 2,797. |
| | 90" | 89 ^{13/16"} | 42 ^{1/2"} | 1 ^{1/4"} | 28 ^{1/2"} | DT1ARY9042N | 1,967. | 2,165. | 2,251. | 2,478. | 2,726. | 2,834. |
| | 96" | 95 ^{13/16"} | 42 ^{1/2"} | 1 ^{1/4"} | 28 ^{1/2"} | DT1ARY9642N | 1,997. | 2,198. | 2,284. | 2,511. | 2,762. | 2,872. |

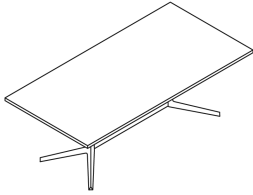

w* = nominal width
Dimensions listed under w d t h are actual to the nearest 1/16"

| Ordering Information | Order Code | Included with: | Options |
|--|---|--|---|
| Freestanding Y Leg Table: 1. Pattern number 2. Base/Stretcher Paint Finish 3. Top Finish 4. Edge Finish | Freestanding Y Leg Table: <i>Example:</i> DT1ARY6024NS, 114, 114 <hr/> DT1 Dividends Horizon Table <hr/> A 2 Leg table assembly <hr/> R Rectangular shape <hr/> Y Y Leg Base <hr/> 60 Overall width in inches <hr/> 24 Overall depth in inches <hr/> N No grommet <hr/> S Stretcher <hr/> 114 Base/ stretcher paint finish <hr/> 114 Laminate top finish <hr/> 114 Edgeband finish | Freestanding Y Leg Table: <ul style="list-style-type: none"> • (2) Y Legs • Hardware kit • Table top • Stretcher or stiffening plate Note: Y Leg tables are finished with textured paint, including 613 Silver. Note: Y Leg Tables are only available in Knoll core finishes. | Grommet Option: <ul style="list-style-type: none"> • To specify an edge grommet, replace the "N" suffix from the pattern number with an "E" and add \$17. Stretcher Option: <ul style="list-style-type: none"> • A stretcher is optional on 24" and 30" deep tables ONLY. To specify a table without a stretcher replace the "S" suffix from the pattern number with an "N". Stretchers are required on 36" and 42" depths. |

Y Leg Tables

Freestanding Racetrack Table Top

24" and 30" Deep

| description | w* | w | d | t | h | pattern number | Laminate | Laminate | Laminate | Techgrain | Techgrain | Techgrain |
|---|-----|----------------------|--------------------|-------------------|--------------------|---------------------|-----------------|-----------------|-----------------|-----------------|-----------------|-----------------|
| | | | | | | | Top P1 Paint | Top P2 Paint | Top P3 Paint | Top P1 Paint | Top P2 Paint | Top P3 Paint |
| 24" Deep Racetrack with (2) Y-Legs, No Grommet | 60" | 59 ^{13/16"} | 23 ^{1/2"} | 1 ^{1/4"} | 28 ^{1/2"} | DT1ATY6024NS | \$1,655. | \$1,822. | \$1,895. | \$2,955. | \$3,251. | \$3,382. |
| | 66" | 65 ^{13/16"} | 23 ^{1/2"} | 1 ^{1/4"} | 28 ^{1/2"} | DT1ATY6624NS | 1,708. | 1,877. | 1,953. | 2,983. | 3,280. | 3,413. |
| | 72" | 71 ^{13/16"} | 23 ^{1/2"} | 1 ^{1/4"} | 28 ^{1/2"} | DT1ATY7224NS | 1,758. | 1,934. | 2,010. | 3,009. | 3,312. | 3,444. |
| | 78" | 77 ^{13/16"} | 23 ^{1/2"} | 1 ^{1/4"} | 28 ^{1/2"} | DT1ATY7824NS | 1,809. | 1,990. | 2,069. | 3,037. | 3,343. | 3,474. |
| | 84" | 83 ^{13/16"} | 23 ^{1/2"} | 1 ^{1/4"} | 28 ^{1/2"} | DT1ATY8424NS | 1,840. | 2,024. | 2,104. | 3,063. | 3,371. | 3,505. |
| | 90" | 89 ^{13/16"} | 23 ^{1/2"} | 1 ^{1/4"} | 28 ^{1/2"} | DT1ATY9024NS | 1,870. | 2,058. | 2,139. | 3,092. | 3,401. | 3,538. |
| | 96" | 95 ^{13/16"} | 23 ^{1/2"} | 1 ^{1/4"} | 28 ^{1/2"} | DT1ATY9624NS | 1,902. | 2,092. | 2,177. | 3,119. | 3,430. | 3,569. |



(with stretcher shown)

| | | | | | | | | | | | | |
|---|-----|----------------------|--------------------|-------------------|--------------------|---------------------|--------|--------|--------|--------|--------|--------|
| 30" Deep Racetrack with (2) Y-Legs, No Grommet | 60" | 59 ^{13/16"} | 29 ^{1/2"} | 1 ^{1/4"} | 28 ^{1/2"} | DT1ATY6030NS | 1,721. | 1,892. | 1,969. | 2,999. | 3,300. | 3,432. |
| | 66" | 65 ^{13/16"} | 29 ^{1/2"} | 1 ^{1/4"} | 28 ^{1/2"} | DT1ATY6630NS | 1,769. | 1,947. | 2,024. | 3,028. | 3,332. | 3,465. |
| | 72" | 71 ^{13/16"} | 29 ^{1/2"} | 1 ^{1/4"} | 28 ^{1/2"} | DT1ATY7230NS | 1,817. | 1,998. | 2,079. | 3,058. | 3,363. | 3,499. |
| | 78" | 77 ^{13/16"} | 29 ^{1/2"} | 1 ^{1/4"} | 28 ^{1/2"} | DT1ATY7830NS | 1,865. | 2,051. | 2,133. | 3,088. | 3,397. | 3,534. |
| | 84" | 83 ^{13/16"} | 29 ^{1/2"} | 1 ^{1/4"} | 28 ^{1/2"} | DT1ATY8430NS | 1,900. | 2,090. | 2,174. | 3,118. | 3,429. | 3,567. |
| | 90" | 89 ^{13/16"} | 29 ^{1/2"} | 1 ^{1/4"} | 28 ^{1/2"} | DT1ATY9030NS | 1,935. | 2,128. | 2,213. | 3,147. | 3,461. | 3,600. |
| | 96" | 95 ^{13/16"} | 29 ^{1/2"} | 1 ^{1/4"} | 28 ^{1/2"} | DT1ATY9630NS | 1,970. | 2,167. | 2,253. | 3,176. | 3,494. | 3,635. |



(with stretcher shown)

w* = nominal width
 Dimensions listed under w d t h are actual to the nearest 1/16"

| Ordering Information | Order Code | Included with: | Options |
|--|---|---|---|
| Freestanding Y Leg Table: 1. Pattern number 2. Base/Stretcher Paint Finish 3. Top Finish 4. Edge Finish | Freestanding Y Leg Table: <i>Example:</i> DT1ATY6024NS, 114, 114 <hr/> DT1 Dividends Horizon Table <hr/> A 2 Leg table assembly <hr/> T Racetrack shape <hr/> Y Y Leg Base <hr/> 60 Overall width in inches <hr/> 24 Overall depth in inches <hr/> N No grommet <hr/> S Stretcher <hr/> 114 Base/ stretcher paint finish <hr/> 114 Laminate top finish <hr/> 114 Edgeband finish | Freestanding Y Leg Table: <ul style="list-style-type: none"> • (2) Y Legs • Hardware kit • Table top • Stretcher or stiffening plate Note: Y Leg tables are finished with textured paint, including 613 Silver. Note: Y Leg Tables are only available in Knoll core finishes. | Grommet Option: <ul style="list-style-type: none"> • To specify an edge grommet, replace the "N" suffix from the pattern number with an "E" and add \$17. Stretcher Option: <ul style="list-style-type: none"> • A stretcher is optional on 24" and 30" deep tables ONLY. To specify a table without a stretcher replace the "S" suffix from pattern number with an "N". Stretchers are required on 36" and 42" depths. |

Y Leg Tables

Freestanding Racetrack Table Top

36" and 42" Deep

Dividends Horizon

| description | w* | w | d | t | h | pattern no. | Laminate | Laminate | Laminate | Techgrain | Techgrain | Techgrain |
|---|-----|----------------------|--------------------|-------------------|--------------------|--------------------|-----------------|-----------------|-----------------|-----------------|-----------------|-----------------|
| | | | | | | | Top P1 Paint | Top P2 Paint | Top P3 Paint | Top P1 Paint | Top P2 Paint | Top P3 Paint |
| 36" Deep Racetrack with (2) Y-Legs, No Grommet | 60" | 59 ^{13/16"} | 35 ^{1/2"} | 1 ^{1/4"} | 28 ^{1/2"} | DT1ATY6036N | \$1,779. | \$1,958. | \$2,036. | \$3,043. | \$3,348. | \$3,483. |
| | 66" | 65 ^{13/16"} | 35 ^{1/2"} | 1 ^{1/4"} | 28 ^{1/2"} | DT1ATY6636N | 1,835. | 2,019. | 2,099. | 3,076. | 3,382. | 3,518. |
| | 72" | 71 ^{13/16"} | 35 ^{1/2"} | 1 ^{1/4"} | 28 ^{1/2"} | DT1ATY7236N | 1,890. | 2,080. | 2,164. | 3,106. | 3,417. | 3,556. |
| | 78" | 77 ^{13/16"} | 35 ^{1/2"} | 1 ^{1/4"} | 28 ^{1/2"} | DT1ATY7836N | 1,947. | 2,139. | 2,226. | 3,139. | 3,453. | 3,592. |
| | 84" | 83 ^{13/16"} | 35 ^{1/2"} | 1 ^{1/4"} | 28 ^{1/2"} | DT1ATY8436N | 1,976. | 2,175. | 2,260. | 3,171. | 3,488. | 3,629. |
| | 90" | 89 ^{13/16"} | 35 ^{1/2"} | 1 ^{1/4"} | 28 ^{1/2"} | DT1ATY9036N | 2,008. | 2,209. | 2,296. | 3,202. | 3,525. | 3,665. |
| | 96" | 95 ^{13/16"} | 35 ^{1/2"} | 1 ^{1/4"} | 28 ^{1/2"} | DT1ATY9636N | 2,038. | 2,242. | 2,331. | 3,234. | 3,559. | 3,700. |

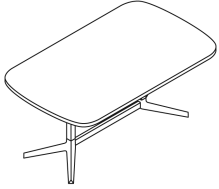

| | | | | | | | | | | | | |
|---|-----|----------------------|--------------------|-------------------|--------------------|--------------------|--------|--------|--------|--------|--------|--------|
| 42" Deep Racetrack with (2) Y-Legs, No Grommet | 84" | 83 ^{13/16"} | 42 ^{1/2"} | 1 ^{1/4"} | 28 ^{1/2"} | DT1ATY8442N | 2,024. | 2,226. | 2,314. | 3,226. | 3,550. | 3,690. |
| | 90" | 89 ^{13/16"} | 42 ^{1/2"} | 1 ^{1/4"} | 28 ^{1/2"} | DT1ATY9042N | 2,062. | 2,270. | 2,360. | 3,260. | 3,587. | 3,728. |
| | 96" | 95 ^{13/16"} | 42 ^{1/2"} | 1 ^{1/4"} | 28 ^{1/2"} | DT1ATY9642N | 2,099. | 2,310. | 2,401. | 3,293. | 3,623. | 3,769. |

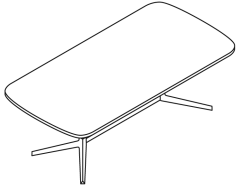

w* = nominal width
Dimensions listed under w d t h are actual to the nearest 1/16"

| Ordering Information | Order Code | Included with: | Options |
|--|---|---|---|
| Freestanding Y Leg Table: 1. Pattern number 2. Base/Stretcher Paint Finish 3. Top Finish 4. Edge Finish | Freestanding Y Leg Table: <i>Example:</i> DT1ATY6024NS, 114, 114 <hr/> DT1 Dividends Horizon Table <hr/> A 2 Leg table assembly <hr/> T Racetrack shape <hr/> Y Y Leg Base <hr/> 60 Overall width in inches <hr/> 24 Overall depth in inches <hr/> N No grommet <hr/> S Stretcher <hr/> 114 Base/ stretcher paint finish <hr/> 114 Laminate top finish <hr/> 114 Edgeband finish | Freestanding Y Leg Table: <ul style="list-style-type: none"> • (2) Y Legs • Hardware kit • Table top • Stretcher or stiffening plate Note: Y Leg tables are finished with textured paint, including 613 Silver. Note: Y Leg Tables are only available in Knoll core finishes. | Grommet Option: <ul style="list-style-type: none"> • To specify an edge grommet, replace the "N" suffix from the pattern number with an "E" and add \$17. Stretcher Option: <ul style="list-style-type: none"> • A stretcher is optional on 24" and 30" deep tables ONLY. To specify a table without a stretcher replace the "S" suffix from pattern number with an "N". Stretchers are required on 36" and 42" depths. |

Y Leg Tables

Credenza Supported Rectangular Table Top

24", 30" and 36" Deep

| description | w* | w | d | t | h | pattern no" | Laminate | Laminate | Laminate | Techgrain | Techgrain | Techgrain |
|---|-----|------------------------------------|----------------------------------|---------------------------------|----------------------------------|--------------------|--------------|--------------|--------------|--------------|--------------|--------------|
| | | | | | | | Top P1 Paint | Top P2 Paint | Top P3 Paint | Top P1 Paint | Top P2 Paint | Top P3 Paint |
| 24" Deep Rectangular with (1) Y-Leg and (1) Spacer - No Grommet | 60" | 59 ¹³ / ₁₆ " | 23 ¹ / ₂ " | 1 ¹ / ₄ " | 28 ¹ / ₂ " | DT1CRY6024N | \$1,384. | \$1,524. | \$1,584. | \$1,622. | \$1,785. | \$1,855. |
| | 66" | 65 ¹³ / ₁₆ " | 23 ¹ / ₂ " | 1 ¹ / ₄ " | 28 ¹ / ₂ " | DT1CRY6624N | 1,402. | 1,542. | 1,605. | 1,653. | 1,819. | 1,891. |
| | 72" | 71 ¹³ / ₁₆ " | 23 ¹ / ₂ " | 1 ¹ / ₄ " | 28 ¹ / ₂ " | DT1CRY7224N | 1,420. | 1,562. | 1,626. | 1,685. | 1,853. | 1,926. |
| | 78" | 77 ¹³ / ₁₆ " | 23 ¹ / ₂ " | 1 ¹ / ₄ " | 28 ¹ / ₂ " | DT1CRY7824N | 1,437. | 1,582. | 1,645. | 1,718. | 1,889. | 1,964. |
| | 84" | 83 ¹³ / ₁₆ " | 23 ¹ / ₂ " | 1 ¹ / ₄ " | 28 ¹ / ₂ " | DT1CRY8424N | 1,468. | 1,617. | 1,682. | 1,749. | 1,922. | 2,000. |
| | 90" | 89 ¹³ / ₁₆ " | 23 ¹ / ₂ " | 1 ¹ / ₄ " | 28 ¹ / ₂ " | DT1CRY9024N | 1,502. | 1,650. | 1,718. | 1,779. | 1,958. | 2,035. |
| | 96" | 95 ¹³ / ₁₆ " | 23 ¹ / ₂ " | 1 ¹ / ₄ " | 28 ¹ / ₂ " | DT1CRY9624N | 1,534. | 1,686. | 1,754. | 1,812. | 1,993. | 2,072. |

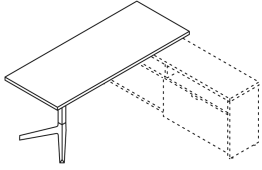

(credenza not included)

| | | | | | | | | | | | | |
|---|-----|------------------------------------|----------------------------------|---------------------------------|----------------------------------|--------------------|--------|--------|--------|--------|--------|--------|
| 30" Deep Rectangular with (1) Y-Leg and (1) Spacer - No Grommet | 60" | 59 ¹³ / ₁₆ " | 29 ¹ / ₂ " | 1 ¹ / ₄ " | 28 ¹ / ₂ " | DT1CRY6030N | 1,424. | 1,566. | 1,629. | 1,665. | 1,830. | 1,903. |
| | 66" | 65 ¹³ / ₁₆ " | 29 ¹ / ₂ " | 1 ¹ / ₄ " | 28 ¹ / ₂ " | DT1CRY6630N | 1,448. | 1,592. | 1,655. | 1,700. | 1,871. | 1,947. |
| | 72" | 71 ¹³ / ₁₆ " | 29 ¹ / ₂ " | 1 ¹ / ₄ " | 28 ¹ / ₂ " | DT1CRY7230N | 1,470. | 1,618. | 1,683. | 1,738. | 1,912. | 1,988. |
| | 78" | 77 ¹³ / ₁₆ " | 29 ¹ / ₂ " | 1 ¹ / ₄ " | 28 ¹ / ₂ " | DT1CRY7830N | 1,496. | 1,644. | 1,712. | 1,774. | 1,953. | 2,030. |
| | 84" | 83 ¹³ / ₁₆ " | 29 ¹ / ₂ " | 1 ¹ / ₄ " | 28 ¹ / ₂ " | DT1CRY8430N | 1,530. | 1,682. | 1,749. | 1,812. | 1,993. | 2,072. |
| | 90" | 89 ¹³ / ₁₆ " | 29 ¹ / ₂ " | 1 ¹ / ₄ " | 28 ¹ / ₂ " | DT1CRY9030N | 1,562. | 1,720. | 1,789. | 1,848. | 2,033. | 2,113. |
| | 96" | 95 ¹³ / ₁₆ " | 29 ¹ / ₂ " | 1 ¹ / ₄ " | 28 ¹ / ₂ " | DT1CRY9630N | 1,596. | 1,758. | 1,827. | 1,883. | 2,073. | 2,155. |

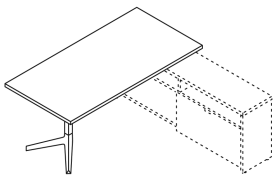

(credenza not included)

| | | | | | | | | | | | | |
|---|-----|------------------------------------|----------------------------------|---------------------------------|----------------------------------|--------------------|--------|--------|--------|--------|--------|--------|
| 36" Deep Rectangular with (1) Y-Leg and (1) Spacer - No Grommet | 60" | 59 ¹³ / ₁₆ " | 35 ¹ / ₂ " | 1 ¹ / ₄ " | 28 ¹ / ₂ " | DT1CRY6036N | 1,510. | 1,662. | 1,727. | 1,778. | 1,957. | 2,035. |
| | 66" | 65 ¹³ / ₁₆ " | 35 ¹ / ₂ " | 1 ¹ / ₄ " | 28 ¹ / ₂ " | DT1CRY6636N | 1,539. | 1,691. | 1,761. | 1,816. | 1,998. | 2,077. |
| | 72" | 71 ¹³ / ₁₆ " | 35 ¹ / ₂ " | 1 ¹ / ₄ " | 28 ¹ / ₂ " | DT1CRY7236N | 1,567. | 1,724. | 1,792. | 1,852. | 2,037. | 2,120. |
| | 78" | 77 ¹³ / ₁₆ " | 35 ¹ / ₂ " | 1 ¹ / ₄ " | 28 ¹ / ₂ " | DT1CRY7836N | 1,595. | 1,756. | 1,825. | 1,890. | 2,079. | 2,163. |
| | 84" | 83 ¹³ / ₁₆ " | 35 ¹ / ₂ " | 1 ¹ / ₄ " | 28 ¹ / ₂ " | DT1CRY8436N | 1,635. | 1,799. | 1,870. | 1,925. | 2,118. | 2,204. |
| | 90" | 89 ¹³ / ₁₆ " | 35 ¹ / ₂ " | 1 ¹ / ₄ " | 28 ¹ / ₂ " | DT1CRY9036N | 1,675. | 1,843. | 1,916. | 1,964. | 2,161. | 2,245. |
| | 96" | 95 ¹³ / ₁₆ " | 35 ¹ / ₂ " | 1 ¹ / ₄ " | 28 ¹ / ₂ " | DT1CRY9636N | 1,716. | 1,887. | 1,961. | 2,000. | 2,200. | 2,287. |

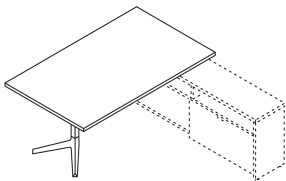

(credenza not included)

w* = nominal width

Dimensions listed under w d t h are actual to the nearest¹/₁₆"

Ordering Information

Credenza Supported Y Leg Table:

1. Pattern number
2. Base/Stretcher Paint Finish
3. Top Finish
4. Edge Finish

Order Code

Credenza Supported Y Leg Table:

Example: **DT1CRY6024N, 114, 114**

| | |
|------------|------------------------------|
| DT1 | Dividends Horizon Table |
| C | Credenza support assembly |
| R | Rectangular shape |
| Y | Y Leg Base |
| 60 | Overall width in inches |
| 24 | Overall depth in inches |
| N | No grommet |
| 114 | Base/ stretcher paint finish |
| 114 | Laminate top finish |
| 114 | Edgeband finish |

Included with:

Credenza Supported Y leg Table:

- (1) Y Leg
- (1) Credenza support spacer
- Hardware kit
- Table top
- Stiffening plate

Credenza must be specified separately

Note: Y Leg tables are finished with textured paint, including 613 Silver.

Note: Y Leg Tables are only available in Knoll core finishes.

Options

Grommet Option:

- To specify an edge grommet, replace the "N" suffix from the pattern number with an "E" and add \$17.

Note: Credenza supported tables may be used with laminate or veneer top credenzas only and are not compatible with steel top credenzas.

Y Leg Tables

Credenza Supported Racetrack Table Top

24", 30" and 36" Deep

| description | w* | w | d | h | pattern no. | Laminate | Laminate | Laminate | Techgrain | Techgrain | Techgrain |
|---|-----|----------------------|--------------------|--------------------|--------------------|-----------------|-----------------|-----------------|-----------------|-----------------|-----------------|
| | | | | | | Top P1 Paint | Top P2 Paint | Top P3 Paint | Top P1 Paint | Top P2 Paint | Top P3 Paint |
| 24" Deep Racetrack with (1) Y-Leg and (1) Spacer - No Grommet | 60" | 59 ^{13/16"} | 23 ^{1/2"} | 28 ^{1/2"} | DT1CTY6024N | \$1,382. | \$1,520. | \$1,582. | \$2,706. | \$2,975. | \$3,057. |
| | 66" | 65 ^{13/16"} | 23 ^{1/2"} | 28 ^{1/2"} | DT1CTY6624N | 1,433. | 1,577. | 1,640. | 2,720. | 2,993. | 3,082. |
| | 72" | 71 ^{13/16"} | 23 ^{1/2"} | 28 ^{1/2"} | DT1CTY7224N | 1,485. | 1,633. | 1,697. | 2,735. | 3,009. | 3,103. |
| | 78" | 77 ^{13/16"} | 23 ^{1/2"} | 28 ^{1/2"} | DT1CTY7824N | 1,536. | 1,688. | 1,757. | 2,751. | 3,026. | 3,128. |
| | 84" | 83 ^{13/16"} | 23 ^{1/2"} | 28 ^{1/2"} | DT1CTY8424N | 1,552. | 1,708. | 1,775. | 2,764. | 3,043. | 3,151. |
| | 90" | 89 ^{13/16"} | 23 ^{1/2"} | 28 ^{1/2"} | DT1CTY9024N | 1,569. | 1,726. | 1,794. | 2,781. | 3,059. | 3,174. |
| | 96" | 95 ^{13/16"} | 23 ^{1/2"} | 28 ^{1/2"} | DT1CTY9624N | 1,585. | 1,744. | 1,814. | 2,796. | 3,077. | 3,198. |

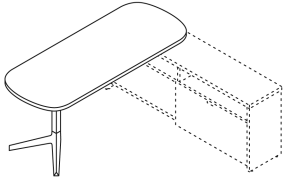

(credenza not included)

| | | | | | | | | | | | |
|---|-----|----------------------|--------------------|--------------------|--------------------|--------|--------|--------|--------|--------|--------|
| 30" Deep Racetrack with (1) Y-Leg and (1) Spacer - No Grommet | 60" | 59 ^{13/16"} | 29 ^{1/2"} | 28 ^{1/2"} | DT1CTY6030N | 1,448. | 1,592. | 1,655. | 2,722. | 2,994. | 3,095. |
| | 66" | 65 ^{13/16"} | 29 ^{1/2"} | 28 ^{1/2"} | DT1CTY6630N | 1,497. | 1,645. | 1,713. | 2,753. | 3,027. | 3,132. |
| | 72" | 71 ^{13/16"} | 29 ^{1/2"} | 28 ^{1/2"} | DT1CTY7230N | 1,544. | 1,697. | 1,766. | 2,782. | 3,061. | 3,171. |
| | 78" | 77 ^{13/16"} | 29 ^{1/2"} | 28 ^{1/2"} | DT1CTY7830N | 1,592. | 1,752. | 1,822. | 2,812. | 3,095. | 3,208. |
| | 84" | 83 ^{13/16"} | 29 ^{1/2"} | 28 ^{1/2"} | DT1CTY8430N | 1,627. | 1,789. | 1,862. | 2,844. | 3,128. | 3,245. |
| | 90" | 89 ^{13/16"} | 29 ^{1/2"} | 28 ^{1/2"} | DT1CTY9030N | 1,662. | 1,827. | 1,900. | 2,872. | 3,163. | 3,283. |
| | 96" | 95 ^{13/16"} | 29 ^{1/2"} | 28 ^{1/2"} | DT1CTY9630N | 1,694. | 1,865. | 1,941. | 2,904. | 3,194. | 3,322. |

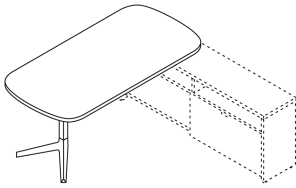

(credenza not included)

| | | | | | | | | | | | |
|---|-----|----------------------|--------------------|--------------------|--------------------|--------|--------|--------|--------|--------|--------|
| 36" Deep Racetrack with (1) Y-Leg and (1) Spacer - No Grommet | 60" | 59 ^{13/16"} | 35 ^{1/2"} | 28 ^{1/2"} | DT1CTY6036N | 1,533. | 1,685. | 1,753. | 2,738. | 3,012. | 3,132. |
| | 66" | 65 ^{13/16"} | 35 ^{1/2"} | 28 ^{1/2"} | DT1CTY6636N | 1,585. | 1,744. | 1,814. | 2,784. | 3,062. | 3,184. |
| | 72" | 71 ^{13/16"} | 35 ^{1/2"} | 28 ^{1/2"} | DT1CTY7236N | 1,640. | 1,804. | 1,876. | 2,829. | 3,113. | 3,236. |
| | 78" | 77 ^{13/16"} | 35 ^{1/2"} | 28 ^{1/2"} | DT1CTY7836N | 1,692. | 1,863. | 1,939. | 2,876. | 3,164. | 3,287. |
| | 84" | 83 ^{13/16"} | 35 ^{1/2"} | 28 ^{1/2"} | DT1CTY8436N | 1,733. | 1,905. | 1,983. | 2,920. | 3,213. | 3,343. |
| | 90" | 89 ^{13/16"} | 35 ^{1/2"} | 28 ^{1/2"} | DT1CTY9036N | 1,772. | 1,949. | 2,027. | 2,966. | 3,262. | 3,394. |
| | 96" | 95 ^{13/16"} | 35 ^{1/2"} | 28 ^{1/2"} | DT1CTY9636N | 1,811. | 1,992. | 2,071. | 3,011. | 3,313. | 3,447. |

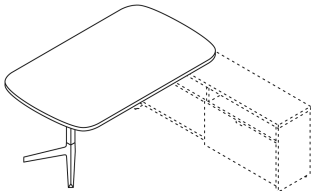

(credenza not included)

w* = nominal width

Dimensions listed under w d t h are actual to the nearest 1/16"

| Ordering Information | Order Code | Included with: | Options |
|--|--|---|--|
| Credenza Supported Y Leg Table: | Credenza Supported Y Leg Table: | Credenza Supported Y Leg Table: | Grommet Option: |
| 1. Pattern number | <i>Example:</i> DT1CTY6024N, 114, 114 | <ul style="list-style-type: none"> (1) Y Leg (1) Credenza support spacer Hardware kit Table top Stiffening plate | <ul style="list-style-type: none"> To specify an edge grommet, replace the "N" suffix from the pattern number with an "E" and add \$18. |
| 2. Base/Stretcher Paint Finish | DT1 Dividends Horizon Table | Credenza must be specified separately | Note: Credenza supported tables may be used with laminate or veneer top credenzas only and are not compatible with steel top credenzas. |
| 3. Top Finish | C Credenza support assembly | Note: Y Leg tables are finished with textured paint, including 613 Silver. | |
| 4. Edge Finish | T Racetrack shape | Note: Y Leg Tables are only available in Knoll core finishes. | |
| | Y Y Leg Base | | |
| | 60 Overall width in inches | | |
| | 24 Overall depth in inches | | |
| | N No grommet | | |
| | 114 Base/ stretcher paint finish | | |
| | 114 Laminate top finish | | |
| | 114 Edgeband finish | | |

This page intentionally left blank

X Base Tables

Dividends Horizon X base tables are designed to be used along with the Dividends Horizon system to create a consistent aesthetic throughout the entire office. With various height and width options, X base tables can be used in a multitude of applications, including collaboration areas in the open plan, break rooms, and lounge areas.

Available with a round, square or rounded square top shape with either a laminate or veneer finish, a Dividends Horizon X base table is appropriate for use in a vast array of applications from the private office to the open plan and even to lounge areas. The five height options allow for the same table base to be used in various applications while maintaining visual consistency throughout the space.

X base tables include a top, support column, and X base.

Available Sizes

- Width: 30 - 48 inches
- Depth: 30 - 48 inches
- Heights: 17, 21, 28-1/2, 36, and 42 inches

Construction

• Worksurface:

- Material: 0.028" thick high pressure laminate or 0.6mm thick veneer on 1-1/8" particle board core
- Edge: plastic laminate tops have a 2mm edgeband; Techwood tops have a 3/16" thick Techwood edge.

• Base:

- Foot: die cast aluminum
- Column: extruded aluminum with 3/16" thick structural plate

Table Supports

X bases may be specified separately for use with an alternative table top. The appropriate X base size must be selected according to the width of the table top being used. X bases are available in five heights and may be used with table tops that are 30 to 48 inches wide.

Available Sizes

Heights: 17, 21, 28-1/2, 36, and 42 inches

Construction

• Base:

- Foot: die cast aluminum
- Column: extruded aluminum with 3/16" thick structural plate

Note: Dividends Horizon tables are only available in Knoll Core paint and laminate finishes. Legacy finishes are not available. All paint finishes have the Dividends Horizon textured paint finish; this includes 613 Silver, which is a smooth paint on all other Dividends Horizon products.

Square X Base Table



Round X Base Table

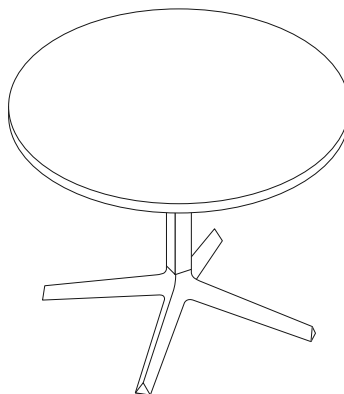



Rounded Square X Base Table



X Base Tables

Square Table Tops

17", 21", 28", 36" and 42" High

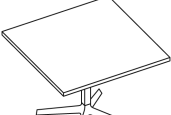
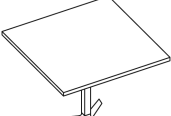
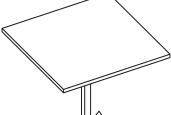
| description | w* | w | d | t | h | pattern no. | Laminate Top P1 Paint | Laminate Top P2 Paint | Laminate Top P3 Paint | Techgrain Top P1 Paint | Techgrain Top P2 Paint | Techgrain Top P3 Paint |
|--|-----|----------------------|----------------------|-------------------|--------------------|---------------------|-----------------------|-----------------------|-----------------------|------------------------|------------------------|------------------------|
|  17" High Square X Base Table | 30" | 29 ^{13/16"} | 29 ^{13/16"} | 1 ^{1/4"} | 17" | DT1ASX303017 | \$1,007. | \$1,111. | \$1,155. | \$1,488. | \$1,644. | \$1,711. |
| | 36" | 35 ^{13/16"} | 35 ^{13/16"} | 1 ^{1/4"} | 17" | DT1ASX363617 | 1,051. | 1,160. | 1,207. | 1,572. | 1,731. | 1,801. |
| | 42" | 41 ^{13/16"} | 41 ^{13/16"} | 1 ^{1/4"} | 17" | DT1ASX424217 | 1,167. | 1,285. | 1,336. | 1,664. | 1,831. | 1,905. |
| | 48" | 47 ^{13/16"} | 47 ^{13/16"} | 1 ^{1/4"} | 17" | DT1ASX484817 | 1,223. | 1,350. | 1,403. | 1,730. | 1,904. | 1,983. |
|  21" High Square X Base Table | 30" | 29 ^{13/16"} | 29 ^{13/16"} | 1 ^{1/4"} | 21" | DT1ASX303021 | 1,007. | 1,111. | 1,155. | 1,488. | 1,644. | 1,711. |
| | 36" | 35 ^{13/16"} | 35 ^{13/16"} | 1 ^{1/4"} | 21" | DT1ASX363621 | 1,051. | 1,160. | 1,207. | 1,572. | 1,731. | 1,801. |
| | 42" | 41 ^{13/16"} | 41 ^{13/16"} | 1 ^{1/4"} | 21" | DT1ASX424221 | 1,167. | 1,285. | 1,336. | 1,664. | 1,831. | 1,905. |
| | 48" | 47 ^{13/16"} | 47 ^{13/16"} | 1 ^{1/4"} | 21" | DT1ASX484821 | 1,223. | 1,350. | 1,403. | 1,730. | 1,904. | 1,983. |
|  28" High Square X Base Table | 30" | 29 ^{13/16"} | 29 ^{13/16"} | 1 ^{1/4"} | 28 ^{1/2"} | DT1ASX3030 | 1,032. | 1,135. | 1,179. | 1,510. | 1,667. | 1,733. |
| | 36" | 35 ^{13/16"} | 35 ^{13/16"} | 1 ^{1/4"} | 28 ^{1/2"} | DT1ASX3636 | 1,074. | 1,181. | 1,228. | 1,594. | 1,754. | 1,824. |
| | 42" | 41 ^{13/16"} | 41 ^{13/16"} | 1 ^{1/4"} | 28 ^{1/2"} | DT1ASX4242 | 1,188. | 1,309. | 1,360. | 1,686. | 1,854. | 1,927. |
| | 48" | 47 ^{13/16"} | 47 ^{13/16"} | 1 ^{1/4"} | 28 ^{1/2"} | DT1ASX4848 | 1,246. | 1,371. | 1,426. | 1,753. | 1,926. | 2,005. |
|  36" High Square X Base Table | 30" | 29 ^{13/16"} | 29 ^{13/16"} | 1 ^{1/4"} | 36" | DT1ASX303036 | 1,088. | 1,190. | 1,237. | 1,567. | 1,724. | 1,789. |
| | 36" | 35 ^{13/16"} | 35 ^{13/16"} | 1 ^{1/4"} | 36" | DT1ASX363636 | 1,132. | 1,239. | 1,286. | 1,650. | 1,811. | 1,880. |
| | 42" | 41 ^{13/16"} | 41 ^{13/16"} | 1 ^{1/4"} | 36" | DT1ASX424236 | 1,245. | 1,364. | 1,418. | 1,743. | 1,912. | 1,986. |
| | 48" | 47 ^{13/16"} | 47 ^{13/16"} | 1 ^{1/4"} | 36" | DT1ASX484836 | 1,304. | 1,428. | 1,484. | 1,810. | 1,985. | 2,061. |
|  42" High Square X Base Table | 30" | 29 ^{13/16"} | 29 ^{13/16"} | 1 ^{1/4"} | 42" | DT1ASX303042 | 1,110. | 1,214. | 1,259. | 1,590. | 1,746. | 1,812. |
| | 36" | 35 ^{13/16"} | 35 ^{13/16"} | 1 ^{1/4"} | 42" | DT1ASX363642 | 1,152. | 1,262. | 1,310. | 1,674. | 1,832. | 1,903. |
| | 42" | 41 ^{13/16"} | 41 ^{13/16"} | 1 ^{1/4"} | 42" | DT1ASX424242 | 1,270. | 1,388. | 1,439. | 1,766. | 1,935. | 2,008. |
| | 48" | 47 ^{13/16"} | 47 ^{13/16"} | 1 ^{1/4"} | 42" | DT1ASX484842 | 1,326. | 1,451. | 1,506. | 1,831. | 2,007. | 2,084. |

w* = nominal width
 Dimensions listed under w d t h are actual to the nearest 1/16"



| Ordering Information | Order Code | Included with: | Options |
|----------------------|--|--|---------|
| X Base Table: | X Base Table: | X Base Table: | |
| 1. Pattern number | <i>Example:</i> DT1ASX3030, 114, 114, | • (1) X Base | |
| 2. Base Paint Finish | 114 | • Hardware kit | |
| 3. Top Finish | DT1 Dividends Horizon | • Table top | |
| 4. Edge Finish | Table | Note: X Base Tables are finished with textured paint, including 613 Silver. | |
| | A Table assembly | Note: X Base Tables are only available in Knoll core finishes. | |
| | S Square shape | | |
| | X X Base | | |
| | 30 Overall width in inches | | |
| | 30 Overall depth in inches | | |
| | 114 Base finish | | |
| | 114 Laminate top finish | | |
| | 114 Edgeband finish | | |

X Base Tables

Round Table Tops

17", 21", 28", 36" and 42" High

Dividends Horizon

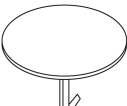
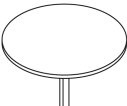
| description | w* | w | d | t | h | pattern no. | Laminate Top P1 Paint | Laminate Top P2 Paint | Laminate Top P3 Paint | Techgrain Top P1 Paint | Techgrain Top P2 Paint | Techgrain Top P3 Paint |
|---|-----|----------------------|----------------------|-------------------|--------------------|-------------------|-----------------------|-----------------------|-----------------------|------------------------|------------------------|------------------------|
|  17" High Round X Base Table | 30" | 29 ^{13/16"} | 29 ^{13/16"} | 1 ^{1/4"} | 17" | DT1ACX3017 | \$1,018. | \$1,123. | \$1,169. | \$2,273. | \$2,500. | \$2,602. |
| | 36" | 35 ^{13/16"} | 35 ^{13/16"} | 1 ^{1/4"} | 17" | DT1ACX3617 | 1,060. | 1,168. | 1,215. | 2,362. | 2,601. | 2,707. |
| | 42" | 41 ^{13/16"} | 41 ^{13/16"} | 1 ^{1/4"} | 17" | DT1ACX4217 | 1,172. | 1,291. | 1,345. | 2,475. | 2,726. | 2,835. |
| | 48" | 47 ^{13/16"} | 47 ^{13/16"} | 1 ^{1/4"} | 17" | DT1ACX4817 | 1,228. | 1,355. | 1,408. | 2,543. | 2,800. | 2,913. |
|  21" High Round X Base Table | 30" | 29 ^{13/16"} | 29 ^{13/16"} | 1 ^{1/4"} | 21" | DT1ACX3021 | 1,018. | 1,123. | 1,169. | 2,273. | 2,500. | 2,602. |
| | 36" | 35 ^{13/16"} | 35 ^{13/16"} | 1 ^{1/4"} | 21" | DT1ACX3621 | 1,060. | 1,168. | 1,215. | 2,362. | 2,601. | 2,707. |
| | 42" | 41 ^{13/16"} | 41 ^{13/16"} | 1 ^{1/4"} | 21" | DT1ACX4221 | 1,172. | 1,291. | 1,345. | 2,475. | 2,726. | 2,835. |
| | 48" | 47 ^{13/16"} | 47 ^{13/16"} | 1 ^{1/4"} | 21" | DT1ACX4821 | 1,228. | 1,355. | 1,408. | 2,543. | 2,800. | 2,913. |
|  28" High Round X Base Table | 30" | 29 ^{13/16"} | 29 ^{13/16"} | 1 ^{1/4"} | 28 ^{1/2"} | DT1ACX30 | 1,041. | 1,145. | 1,190. | 2,295. | 2,524. | 2,626. |
| | 36" | 35 ^{13/16"} | 35 ^{13/16"} | 1 ^{1/4"} | 28 ^{1/2"} | DT1ACX36 | 1,082. | 1,189. | 1,238. | 2,385. | 2,625. | 2,728. |
| | 42" | 41 ^{13/16"} | 41 ^{13/16"} | 1 ^{1/4"} | 28 ^{1/2"} | DT1ACX42 | 1,193. | 1,315. | 1,366. | 2,499. | 2,749. | 2,860. |
| | 48" | 47 ^{13/16"} | 47 ^{13/16"} | 1 ^{1/4"} | 28 ^{1/2"} | DT1ACX48 | 1,253. | 1,377. | 1,432. | 2,566. | 2,823. | 2,936. |
|  36" High Round X Base Table | 30" | 29 ^{13/16"} | 29 ^{13/16"} | 1 ^{1/4"} | 36" | DT1ACX3036 | 1,098. | 1,202. | 1,247. | 2,352. | 2,579. | 2,682. |
| | 36" | 35 ^{13/16"} | 35 ^{13/16"} | 1 ^{1/4"} | 36" | DT1ACX3636 | 1,139. | 1,246. | 1,294. | 2,442. | 2,681. | 2,785. |
| | 42" | 41 ^{13/16"} | 41 ^{13/16"} | 1 ^{1/4"} | 36" | DT1ACX4236 | 1,252. | 1,370. | 1,423. | 2,555. | 2,806. | 2,916. |
| | 48" | 47 ^{13/16"} | 47 ^{13/16"} | 1 ^{1/4"} | 36" | DT1ACX4836 | 1,310. | 1,434. | 1,490. | 2,623. | 2,880. | 2,992. |
|  42" High Round X Base Table | 30" | 29 ^{13/16"} | 29 ^{13/16"} | 1 ^{1/4"} | 42" | DT1ACX3042 | 1,120. | 1,224. | 1,272. | 2,375. | 2,602. | 2,706. |
| | 36" | 35 ^{13/16"} | 35 ^{13/16"} | 1 ^{1/4"} | 42" | DT1ACX3642 | 1,163. | 1,271. | 1,318. | 2,465. | 2,704. | 2,808. |
| | 42" | 41 ^{13/16"} | 41 ^{13/16"} | 1 ^{1/4"} | 42" | DT1ACX4242 | 1,275. | 1,394. | 1,445. | 2,578. | 2,828. | 2,939. |
| | 48" | 47 ^{13/16"} | 47 ^{13/16"} | 1 ^{1/4"} | 42" | DT1ACX4842 | 1,331. | 1,457. | 1,511. | 2,646. | 2,903. | 3,014. |

w* = nominal width

Dimensions listed under w d t h are actual to the nearest 1/16"





| Ordering Information | Order Code | Included with: | Options |
|--|--|---|---------|
| X Base Table: 1. Pattern number 2. Base Paint Finish 3. Top Finish 4. Edge Finish | X Base Table: <i>Example:</i> DT1ACX3030, 114, 114, 114 DT1 Dividends Horizon Table A Table assembly C Round shape X X Base 30 Overall width in inches 30 Overall depth in inches 114 Base finish 114 Laminate top finish 114 Edgeband finish | X Base Table: <ul style="list-style-type: none"> (1) X Base Hardware kit Table top Note: X Base Tables are finished with textured paint, including 613 Silver. Note: X Base Tables are only available in Knoll core finishes. | |

X Base Tables

Rounded Square Table Tops

17", 21", 28", 36" and 42" High

Dividends Horizon

| description | w* | w | d | t | h | pattern no. | Laminate | Laminate | Laminate | Techgrain | Techgrain | Techgrain |
|--|-----|----------------------|----------------------|-------------------|--------------------|---------------------|-----------------|-----------------|-----------------|-----------------|-----------------|-----------------|
| | | | | | | | Top P1 Paint | Top P2 Paint | Top P3 Paint | Top P1 Paint | Top P2 Paint | Top P3 Paint |
|  17" High Rounded Square X Base Table | 30" | 29 ^{13/16"} | 29 ^{13/16"} | 1 ^{1/4"} | 17" | DT1ADX303017 | \$1,018. | \$1,123. | \$1,169. | \$2,273. | \$2,500. | \$2,602. |
| | 36" | 35 ^{13/16"} | 35 ^{13/16"} | 1 ^{1/4"} | 17" | DT1ADX363617 | 1,060. | 1,168. | 1,215. | 2,362. | 2,601. | 2,707. |
| | 42" | 41 ^{13/16"} | 41 ^{13/16"} | 1 ^{1/4"} | 17" | DT1ADX424217 | 1,172. | 1,291. | 1,345. | 2,475. | 2,726. | 2,835. |
| | 48" | 47 ^{13/16"} | 47 ^{13/16"} | 1 ^{1/4"} | 17" | DT1ADX484817 | 1,228. | 1,355. | 1,408. | 2,543. | 2,800. | 2,913. |
|  21" High Rounded Square X Base Table | 30" | 29 ^{13/16"} | 29 ^{13/16"} | 1 ^{1/4"} | 21" | DT1ADX303021 | 1,018. | 1,123. | 1,169. | 2,273. | 2,500. | 2,602. |
| | 36" | 35 ^{13/16"} | 35 ^{13/16"} | 1 ^{1/4"} | 21" | DT1ADX363621 | 1,060. | 1,168. | 1,215. | 2,362. | 2,601. | 2,707. |
| | 42" | 41 ^{13/16"} | 41 ^{13/16"} | 1 ^{1/4"} | 21" | DT1ADX424221 | 1,172. | 1,291. | 1,345. | 2,475. | 2,726. | 2,835. |
| | 48" | 47 ^{13/16"} | 47 ^{13/16"} | 1 ^{1/4"} | 21" | DT1ADX484821 | 1,228. | 1,355. | 1,408. | 2,543. | 2,800. | 2,913. |
|  28" High Rounded Square X Base Table | 30" | 29 ^{13/16"} | 29 ^{13/16"} | 1 ^{1/4"} | 28 ^{1/2"} | DT1ADX3030 | 1,041. | 1,145. | 1,190. | 2,295. | 2,524. | 2,626. |
| | 36" | 35 ^{13/16"} | 35 ^{13/16"} | 1 ^{1/4"} | 28 ^{1/2"} | DT1ADX3636 | 1,082. | 1,189. | 1,238. | 2,385. | 2,625. | 2,728. |
| | 42" | 41 ^{13/16"} | 41 ^{13/16"} | 1 ^{1/4"} | 28 ^{1/2"} | DT1ADX4242 | 1,193. | 1,315. | 1,366. | 2,499. | 2,749. | 2,860. |
| | 48" | 47 ^{13/16"} | 47 ^{13/16"} | 1 ^{1/4"} | 28 ^{1/2"} | DT1ADX4848 | 1,253. | 1,377. | 1,432. | 2,566. | 2,823. | 2,936. |
|  36" High Rounded Square X Base Table | 30" | 29 ^{13/16"} | 29 ^{13/16"} | 1 ^{1/4"} | 36" | DT1ADX303036 | 1,098. | 1,202. | 1,247. | 2,352. | 2,579. | 2,682. |
| | 36" | 35 ^{13/16"} | 35 ^{13/16"} | 1 ^{1/4"} | 36" | DT1ADX363636 | 1,139. | 1,246. | 1,294. | 2,442. | 2,681. | 2,785. |
| | 42" | 41 ^{13/16"} | 41 ^{13/16"} | 1 ^{1/4"} | 36" | DT1ADX424236 | 1,252. | 1,370. | 1,423. | 2,555. | 2,806. | 2,916. |
| | 48" | 47 ^{13/16"} | 47 ^{13/16"} | 1 ^{1/4"} | 36" | DT1ADX484836 | 1,310. | 1,434. | 1,490. | 2,623. | 2,880. | 2,992. |

Tables

w* = nominal width
 Dimensions listed under w d t h are actual to the nearest 1/16"

| Ordering Information | Order Code | Included with: | Options |
|--|---|---|---------|
| X Base Table: 1. Pattern number 2. Base Paint Finish 3. Top Finish 4. Edge Finish | X Base Table: <i>Example:</i> DT1ADX3030, 114, 114, 114 DT1 Dividends Horizon Table A Table assembly D Rounded Square shape X X Base 30 Overall width in inches 30 Overall depth in inches 114 Base finish 114 Laminate top finish 114 Edgeband finish | X Base Table: <ul style="list-style-type: none"> (1) X Base Hardware kit Table top Note: X Base Tables are finished with textured paint, including 613 Silver. Note: X Base Tables are only available in Knoll core finishes. | |

X Base Tables

Rounded Square Table Tops

17", 21", 28", 36" and 42" High

| description | w* | w | d | t | h | pattern no. | Laminate | Laminate | Laminate | Techgrain | Techgrain | Techgrain |
|--------------------------------------|-----|----------------------|----------------------|-------------------|-----|---------------------|-----------------|-----------------|-----------------|-----------------|-----------------|-----------------|
| | | | | | | | Top P1 Paint | Top P2 Paint | Top P3 Paint | Top P1 Paint | Top P2 Paint | Top P3 Paint |
| 42" High Rounded Square X Base Table | 30" | 29 ^{13/16"} | 29 ^{13/16"} | 1 ^{1/4"} | 42" | DT1ADX303042 | \$1,120. | \$1,224. | \$1,272. | \$2,375. | \$2,602. | \$2,706. |
| | 36" | 35 ^{13/16"} | 35 ^{13/16"} | 1 ^{1/4"} | 42" | DT1ADX363642 | 1,163. | 1,271. | 1,318. | 2,465. | 2,704. | 2,808. |
| | 42" | 41 ^{13/16"} | 41 ^{13/16"} | 1 ^{1/4"} | 42" | DT1ADX424242 | 1,275. | 1,394. | 1,445. | 2,578. | 2,828. | 2,939. |
| | 48" | 47 ^{13/16"} | 47 ^{13/16"} | 1 ^{1/4"} | 42" | DT1ADX484842 | 1,331. | 1,457. | 1,511. | 2,646. | 2,903. | 3,014. |



w* = nominal width
 Dimensions listed under w d t h are actual to the nearest 1/16"

| Ordering Information | Order Code | Included with: | Options |
|--|---|---|---------|
| X Base Table: 1. Pattern number 2. Base Paint Finish 3. Top Finish 4. Edge Finish | X Base Table: <i>Example:</i> DT1ADX3030, 114, 114, 114 <hr/> DT1 Dividends Horizon Table <hr/> A Table assembly <hr/> D Rounded Square shape <hr/> X X Base <hr/> 30 Overall width in inches <hr/> 30 Overall depth in inches <hr/> 114 Base finish <hr/> 114 Laminate top finish <hr/> 114 Edgeband finish | X Base Table: <ul style="list-style-type: none"> • (1) X Base • Hardware kit • Table top Note: X Base Tables are finished with textured paint, including 613 Silver. Note: X Base Tables are only available in Knoll core finishes. | |

Table Supports

X Bases

Credenza Support Spacer

| description | w | h | d | pattern no. | P1 | P2 | P3 |
|---|---|-----|---|-----------------|--------|--------|--------|
| Small X-Base, for use with 30" or 36" wide round, square or rounded square table tops | | 17" | | DT1BXS17 | \$541. | \$598. | \$623. |
| | | 21" | | DT1BXS21 | 541. | 598. | 623. |
| | | 28" | | DT1BXS | 563. | 621. | 646. |
| | | 36" | | DT1BXS36 | 621. | 677. | 702. |
| | | 42" | | DT1BXS42 | 643. | 700. | 725. |



| | | | | | | | |
|---|--|-----|--|-----------------|------|------|------|
| Large X Base, for use with 42" or 48" wide round, square or rounded square table tops | | 17" | | DT1BXL17 | 597. | 659. | 686. |
| | | 21" | | DT1BXL21 | 597. | 659. | 686. |
| | | 28" | | DT1BXL | 620. | 682. | 709. |
| | | 36" | | DT1BXL36 | 676. | 738. | 765. |
| | | 42" | | DT1BXL42 | 699. | 761. | 787. |



| | | | | | | | |
|--|---------------------------------|-----------------------------------|----------------------------------|-------------|------|------|------|
| Credenza Support Spacer For use with Dividends Horizon Credenza | 9 ⁵ / ₈ " | 2 ¹⁵ / ₁₆ " | 1 ⁹ / ₁₆ " | DT1S | 150. | 166. | 173. |
|--|---------------------------------|-----------------------------------|----------------------------------|-------------|------|------|------|



| | | | | | | | |
|---|--|-----|--|---------------|------|------|------|
| Small T-Base, for use with 24" or 30" deep tops | | 28" | | DT1BTS | 563. | 621. | 646. |
|---|--|-----|--|---------------|------|------|------|



| | | | | | | | |
|---|--|-----|--|---------------|------|------|------|
| Large T-Base, for use with 24" or 30" deep tops | | 28" | | DT1BTL | 620. | 682. | 709. |
|---|--|-----|--|---------------|------|------|------|



Ordering Information

Table Supports:

1. Pattern number
2. Paint Finish

Order Code

X Base:

Example: **DT1BXS, 114**

DT1 Dividends Horizon Table

B Base

S X Shape

114 Paint finish

Credenza Support Spacer:

Example: **DT1S, 114**

DT1 Dividends Horizon Table

S Support Spacer

114 Paint finish

Included with:

X Base:

- X Base
- Hardware kit

T Base:

- T Base
- Hardware kit

Credenza Support spacer:

- Support spacer
- Hardware Kit

Note: X and T bases are painted with textured paint, including 613 Silver.

Note: Table supports are only available in Knoll core finishes.

Options

Casters are designed for use on X- and Y-bases only.

Tables with casters may not exceed 28"h, 84"w or 42"d.

Table Supports
X Bases
Credenza Support Spacer

| description | w | h | d | pattern no. | P1 | P2 | P3 |
|---|---|----|---|---------------|-------|------|------|
| Caster Kit (set of 4) black only  | | 1" | | DT1CK4 | \$38. | \$0. | \$0. |

Ordering Information

Table Supports:

1. Pattern number
2. Paint Finish

Order Code

X Base:

Example: **DT1BXS, 114**

DT1 Dividends Horizon Table

B Base

S X Shape

114 Paint finish

Credenza Support Spacer:

Example: **DT1S, 114**

DT1 Dividends Horizon Table

S Support Spacer

114 Paint finish

Included with:

X Base:

- X Base
- Hardware kit

T Base:

- T Base
- Hardware kit

Credenza Support spacer:

- Support spacer
- Hardware Kit

Note: X and T bases are painted with textured paint, including 613 Silver.

Note: Table supports are only available in Knoll core finishes.

Options

Casters are designed for use on X- and Y-bases only.

Tables with casters may not exceed 28"h, 84"w or 42"d.

Table Supports

C-Leg and T-Leg Bases

Fixed Height and Height Adjustable

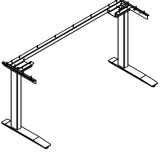
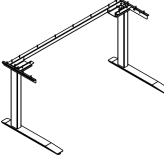
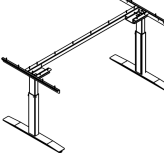
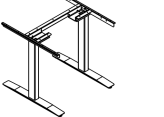
| description | type | w* | w | d | pattern no. | Fixed (F) | Pin-Set (P) | Handcrank (H) | Electric (E) | Advanced Electric (A) | |
|---|--|---|-----|-----|----------------------|--------------------|-------------|---------------|--------------|-----------------------|--------|
|  | For use with 36"W, 24"D C-Leg Top | 36" | 34" | 23" | DT1BC3423() | \$955. | \$1,273. | \$1,909. | \$3,316. | \$3,491. | |
| | For use with 42"W, 24"D C-Leg Top | 42" | 40" | 23" | DT1BC4023() | 955. | 1,273. | 1,909. | 3,316. | 3,491. | |
| | For use with 48"W, 24"D C-Leg Top | 48" | 46" | 23" | DT1BC4623() | 955. | 1,273. | 1,909. | 3,316. | 3,491. | |
| | For use with 54"W, 24"D C-Leg Top | 54" | 52" | 23" | DT1BC5223() | 955. | 1,273. | 1,909. | 3,316. | 3,491. | |
| | For use with 60"W, 24"D C-Leg Top | 60" | 58" | 23" | DT1BC5823() | 955. | 1,273. | 1,909. | 3,316. | 3,491. | |
| | For use with 66"W, 24"D C-Leg Top | 66" | 64" | 23" | DT1BC6423() | 977. | 1,295. | 1,923. | 3,338. | 3,514. | |
| | For use with 72"W, 24"D C-Leg Top | 72" | 70" | 23" | DT1BC7023() | 977. | 1,295. | 1,932. | 3,338. | 3,514. | |
| <i>Fixed Shown</i> | | | | | | | | | | | |
|  | For use with 36"W, 30"D C-Leg Top | 36" | 34" | 29" | DT1BC3429() | 1,000. | 1,318. | 1,955. | 3,360. | 3,536. | |
| | For use with 42"W, 30"D C-Leg Top | 42" | 40" | 29" | DT1BC4029() | 1,000. | 1,318. | 1,955. | 3,360. | 3,536. | |
| | For use with 48"W, 30"D C-Leg Top | 48" | 46" | 29" | DT1BC4629() | 1,000. | 1,318. | 1,955. | 3,360. | 3,536. | |
| | For use with 54"W, 30"D C-Leg Top | 54" | 52" | 29" | DT1BC5229() | 1,000. | 1,318. | 1,955. | 3,360. | 3,536. | |
| | For use with 60"W, 30"D C-Leg Top | 60" | 58" | 29" | DT1BC5829() | 1,000. | 1,318. | 1,955. | 3,360. | 3,536. | |
| | For use with 66"W, 30"D C-Leg Top | 66" | 64" | 29" | DT1BC6429() | 1,023. | 1,341. | 1,977. | 3,381. | 3,559. | |
| | For use with 72"W, 30"D C-Leg Top | 72" | 70" | 29" | DT1BC7029() | 1,023. | 1,341. | 1,977. | 3,381. | 3,559. | |
| <i>Fixed Shown</i> | | | | | | | | | | | |
|  | For use with 48"W, 30" or 36"D T-Leg Top | 48" | 46" | 29" | DT1BT4629() | 1,000. | 1,318. | 1,955. | 3,360. | 3,536. | |
| | For use with 54"W, 30" or 36"D T-Leg Top | 54" | 52" | 29" | DT1BT5229() | 1,000. | 1,318. | 1,955. | 3,360. | 3,536. | |
| | For use with 60"W, 30" or 36"D T-Leg Top | 60" | 58" | 29" | DT1BT5829() | 1,000. | 1,318. | 1,955. | 3,360. | 3,536. | |
| | For use with 66"W, 30" or 36"D T-Leg Top | 66" | 64" | 29" | DT1BT6429() | 1,023. | 1,341. | 1,977. | 3,381. | 3,559. | |
| | For use with 72"W, 30" or 36"D T-Leg Top | 72" | 70" | 29" | DT1BT7029() | 1,023. | 1,341. | 1,977. | 3,381. | 3,559. | |
| <i>Pin-Set Shown</i> | | | | | | | | | | | |
| C-Leg Corner Base | For use with Corner C-Leg Top | 48" | 46" | 16" | DT1BK464616() | 1,545. | 2,023. | 3,000. | 5,087. | 5,355. | |
| <i>Fixed Shown</i> | | | | | | | | | | | |
|  | T-Leg Corner Base | For use with 42" Corner T-Leg Top | 32" | 30" | 29" | DT1BT3029() | 1,000. | 1,318. | 1,955. | 3,360. | 3,536. |
| | | For use with 48" Corner C-Leg/T-Leg Top | 36" | 34" | 29" | DT1BT3429() | 1,000. | 1,318. | 1,955. | 3,360. | 3,536. |
| <i>Fixed Shown</i> | | | | | | | | | | | |

Tables

Ordering Information

Table Supports

1. Pattern Number
2. Base Type
3. Shroud Option
4. Base Finish
5. Shroud/Feet Paint Finish (optional)

w* = nominal width

Order Code

Table Supports

Example: **DT1BC5829HS, 9005, 613**

| | |
|-------------|--------------------------|
| DT1B | Universal Base |
| C | C-Leg |
| 58 | Width |
| 29 | Depth |
| H | Handcrank |
| S | Shroud |
| 9005 | Black Base Finish |
| 613 | Shroud/Feet Paint Finish |

Included With

Table Supports
Mounting hardware
Shrouds (optional)

Options

Table Supports

Base Type Options:

- (F) = Fixed (27" High)
- (P) = Pin-Set (22" - 35" High)
- (H) = Handcrank (22" - 35" High)
- (E) = Electric (27" - 46 1/2" High)
- (A) = Advanced Electric (21" - 47 1/2" High)



Shroud Option:

Add an 'S' suffix to the pattern number to specify a painted shroud for the lower leg with matching foot and add \$100 to the list price. Add an 'N' suffix to specify a leg without a shroud.

Table Supports

C-Leg and T-Leg Bases

Fixed Height and Height Adjustable



| description | type | w | d | h | pattern no. | list |
|--|--|----|------|------|------------------|--------|
| Electric Table Memory Switch with Digital Display  | For use with Electric C-Leg and T-Leg bases | 5" | .75" | 1" | SISDDPS | \$375. |
| Locking Casters, Set of 4  | For use with C-Leg and T-Leg bases | 2" | 2" | 1.5" | SISLC4 | 50. |
| Insert Kit, Antenna Privacy Screen | To attach Antenna Workspaces Privacy Screens to C-Leg and T-Leg worksurfaces | | | | SISAWDSIK | 25. |

| Ordering Information | Order Code | Included With | Options |
|-----------------------|--|-----------------------|-----------------------|
| Table Supports | Table Supports | Table Supports | Table Supports |
| 1. Pattern Number | <i>Example:</i> SISDDPS SIS Universal Base DDPS Electric Table Memory Switch with Digital Display | | |

Rectangular and Corner C-Leg and T-Leg Worksurfaces

24", 30" and 36" Deep Rectangular

Dividends Horizon

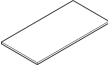
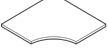
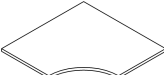
| description | type | w* | w | d* | d | h | pattern no. | Laminate w/ ABS edge | laminates w/ woodgrain edge | Techwood w/ Techwood edge |
|--|---------------------------------------|-----|-----|-----|-----|--------|--------------------|----------------------|-----------------------------|---------------------------|
|  C-Leg Rectangular Tops, 24" Deep | For use with 24"D C-Leg base | 36" | 34" | 24" | 23" | 1 1/4" | DT1R3423N | \$227. | \$249. | \$473. |
| | For use with 24"D C-Leg base | 42" | 40" | 24" | 23" | 1 1/4" | DT1R4023N | 260. | 285. | 499. |
| | For use with 24"D C-Leg base | 48" | 46" | 24" | 23" | 1 1/4" | DT1R4623N | 290. | 321. | 523. |
| | For use with 24"D C-Leg base | 54" | 52" | 24" | 23" | 1 1/4" | DT1R5223N | 316. | 347. | 550. |
| | For use with 24"D C-Leg base | 60" | 58" | 24" | 23" | 1 1/4" | DT1R5823N | 342. | 374. | 578. |
| | For use with 24"D C-Leg base | 66" | 64" | 24" | 23" | 1 1/4" | DT1R6423N | 367. | 404. | 602. |
| | For use with 24"D C-Leg base | 72" | 70" | 24" | 23" | 1 1/4" | DT1R7023N | 383. | 423. | 629. |
|  C-Leg and T-Leg Rectangular Tops, 30" Deep | For use with 30"D C-Leg base | 36" | 34" | 30" | 29" | 1 1/4" | DT1R3429N | 282. | 311. | 507. |
| | For use with 30"D C-Leg base | 42" | 40" | 30" | 29" | 1 1/4" | DT1R4029N | 307. | 336. | 541. |
| | For use with 30"D C-Leg or T-Leg base | 48" | 46" | 30" | 29" | 1 1/4" | DT1R4629N | 342. | 374. | 576. |
| | For use with 30"D C-Leg or T-Leg base | 54" | 52" | 30" | 29" | 1 1/4" | DT1R5229N | 387. | 424. | 600. |
| | For use with 30"D C-Leg or T-Leg base | 60" | 58" | 30" | 29" | 1 1/4" | DT1R5829N | 425. | 468. | 626. |
| | For use with 30"D C-Leg or T-Leg base | 66" | 64" | 30" | 29" | 1 1/4" | DT1R6429N | 472. | 521. | 650. |
| | For use with 30"D C-Leg or T-Leg base | 72" | 70" | 30" | 29" | 1 1/4" | DT1R7029N | 492. | 539. | 674. |
|  T-Leg Rectangular Tops, 36" Deep | For use with 30"D T-Leg base | 48" | 46" | 36" | 35" | 1 1/4" | DT1R4635N | 448. | 480. | 683. |
| | For use with 30"D T-Leg base | 54" | 52" | 36" | 35" | 1 1/4" | DT1R5235N | 494. | 531. | 707. |
| | For use with 30"D T-Leg base | 60" | 58" | 36" | 35" | 1 1/4" | DT1R5835N | 544. | 598. | 742. |
| | For use with 30"D T-Leg base | 66" | 64" | 36" | 35" | 1 1/4" | DT1R6435N | 601. | 663. | 768. |
| | For use with 30"D T-Leg base | 72" | 70" | 36" | 35" | 1 1/4" | DT1R7035N | 663. | 731. | 797. |
|  C-Leg/T-Leg Corner Tops, 24" or 30" Deep | For use with C-Leg/T-Leg Corner base | 48" | 46" | 24" | 23" | 1 1/4" | DT1L4646SSN | 602. | 666. | 1,150. |
| | For use with C-Leg/T-Leg Corner base | 48" | 46" | 30" | 29" | 1 1/4" | DT1L4646DDN | 650. | 716. | 1,164. |
|  T-Leg Corner Top, 24" Deep | For use with T-Leg Corner base | 42" | 40" | 24" | 23" | 1 1/4" | DT1L4040SSN | 535. | 591. | 1,089. |

Tables

| Ordering Information | Order Code | Included With | Options |
|---|---|-------------------------------|---|
| Dividends Horizon Tops 1. Pattern Number 2. Top Finish 3. Edge Finish (for laminate tops only) w * and d * = nominal dimensions | Dividends Horizon Tops <i>Example:</i> DT1R5829N, 118, 118 DT1R Rectangular 58 Width 29 Depth N No Grommet 118 Bright White Laminate 118 Bright White Edge | Dividends Horizon Tops | Dividends Horizon Tops Top Finish Options: Laminate with ABS edge Laminate with woodgrain edge Techwood with techwood edge Note: When woodgrain laminates are specified on corner worksurfaces a grain direction option must be specified. (L) = Left (R) = Right (D) = Diagonal (Add \$26 to list price) Note: Techwood corner worksurfaces have a diagonal grain direction. See grain direction page for more information. |

Dividends Horizon Conference Tables

Dividends Horizon conference tables are designed with a scale and visual language consistent with the full scope of Dividends Horizon products. This design consistency makes Dividends Horizon tables appropriate for use in conference, meeting, private office and open plan office applications.

Dividends Horizon conference tables are available in racetrack, rectangular, or boat shape and in all standard Dividends Horizon finishes.

Conference tables include a table top and base assembly. A conference table base assembly includes two Y legs, one center support T base, and two horizontal stretchers that connect the three bases. Top sizes up to 120 inches are produced in one piece, while tops longer than 120 inches are produced in two pieces.

Available Sizes

Width: 102- 144 inches

Depth: 36- 48 inches

Height: 28-1/2 inches

Construction

Worksurface:

- Material: 0.028 inch thick high pressure laminate or 0.6mm thick veneer on 1-1/8 inch thick particle board core
- Edge: plastic laminate tops have a 2mm edgeband; Techwood tops have a 3/16" thick Techwood edge

Base:

- Stretcher: extruded aluminum
- Foot: die cast aluminum
- Column: extruded aluminum with 3/16 inch thick structural plate

Note: Dividends Horizon conference tables are only available in Knoll Core paint, laminate, and Techwood finishes. Legacy finishes are not available. All paint finishes have the Dividends Horizon textured paint finish; this includes 613 Silver, which is a smooth paint on all other Dividends Horizon products.

Note: Grain patterns on woodgrain laminate and veneer tops will not match at the seam in the middle of conference tables.

Rectangular Conference Table

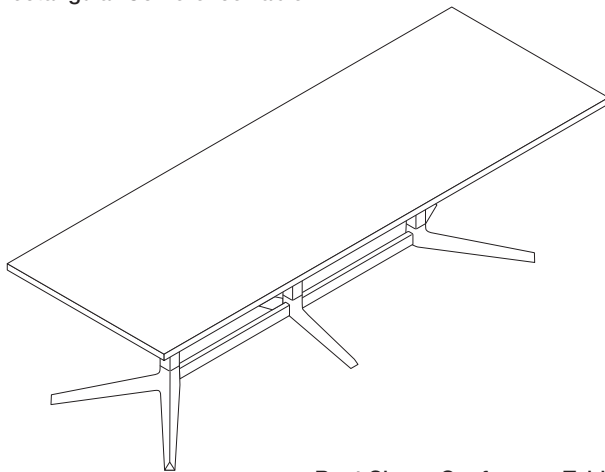

Racetrack Conference Table

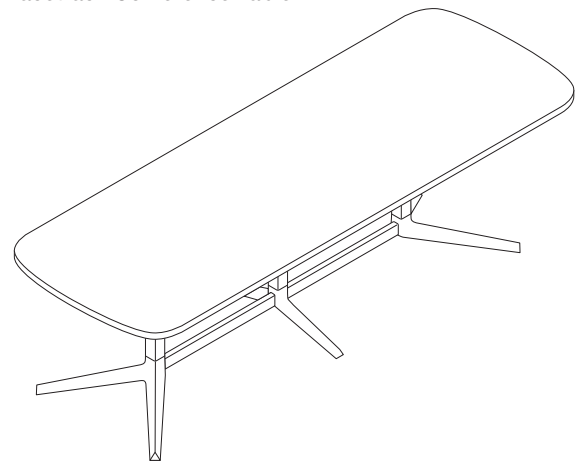

Boat Shape Conference Table



Conference Tables

Rectangular Table Top

36", 42" and 48" Deep

Dividends Horizon

| description | w* | w | d | t | h | pattern no. | Laminate | Laminate | Laminate | Techgrain | Techgrain | Techgrain |
|---------------------------------------|------|-----------------------|--------------------|-------------------|--------------------|---------------------|-----------------|-----------------|-----------------|-----------------|-----------------|-----------------|
| | | | | | | | Top P1 Paint | Top P2 Paint | Top P3 Paint | Top P1 Paint | Top P2 Paint | Top P3 Paint |
| 36" Deep Rectangular Conference Table | 102" | 101 ^{13/16"} | 35 ^{1/2"} | 1 ^{1/4"} | 28 ^{1/2"} | DT1ARY10236N | \$2,388. | \$2,443. | \$2,500. | \$2,727. | \$2,842. | \$3,069. |
| | 108" | 107 ^{13/16"} | 35 ^{1/2"} | 1 ^{1/4"} | 28 ^{1/2"} | DT1ARY10836N | 2,443. | 2,500. | 2,557. | 2,784. | 3,062. | 3,186. |

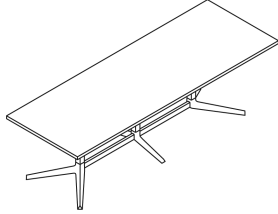

| | | | | | | | | | | | | |
|---------------------------------------|------|-----------------------|--------------------|-------------------|--------------------|---------------------|--------|--------|--------|--------|--------|--------|
| 42" Deep Rectangular Conference Table | 102" | 101 ^{13/16"} | 41 ^{1/2"} | 1 ^{1/4"} | 28 ^{1/2"} | DT1ARY10242N | 2,443. | 2,500. | 2,557. | 2,784. | 2,898. | 3,126. |
| | 108" | 107 ^{13/16"} | 41 ^{1/2"} | 1 ^{1/4"} | 28 ^{1/2"} | DT1ARY10842N | 2,500. | 2,557. | 2,615. | 2,812. | 3,126. | 3,280. |
| | 120" | 119 ^{13/16"} | 41 ^{1/2"} | 1 ^{1/4"} | 28 ^{1/2"} | DT1ARY12042N | 2,674. | 2,729. | 2,786. | 2,921. | 3,214. | 3,344. |
| | 132" | 131 ^{13/16"} | 41 ^{1/2"} | 1 ^{1/4"} | 28 ^{1/2"} | DT1ARY13242N | 2,786. | 2,844. | 2,901. | 3,397. | 3,737. | 3,888. |
| | 144" | 143 ^{13/16"} | 41 ^{1/2"} | 1 ^{1/4"} | 28 ^{1/2"} | DT1ARY14442N | 2,901. | 2,957. | 3,013. | 3,871. | 4,260. | 4,428. |

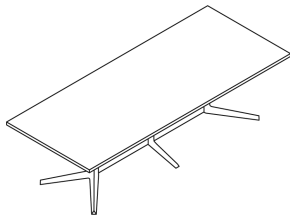

| | | | | | | | | | | | | |
|---------------------------------------|------|-----------------------|--------------------|-------------------|--------------------|---------------------|--------|--------|--------|--------|--------|--------|
| 48" Deep Rectangular Conference Table | 102" | 101 ^{13/16"} | 47 ^{1/2"} | 1 ^{1/4"} | 28 ^{1/2"} | DT1ARY10248N | 2,500. | 2,557. | 2,615. | 2,842. | 3,011. | 3,239. |
| | 108" | 107 ^{13/16"} | 47 ^{1/2"} | 1 ^{1/4"} | 28 ^{1/2"} | DT1ARY10848N | 2,557. | 2,615. | 2,672. | 2,927. | 3,210. | 3,353. |
| | 120" | 119 ^{13/16"} | 47 ^{1/2"} | 1 ^{1/4"} | 28 ^{1/2"} | DT1ARY12048N | 2,737. | 2,793. | 2,853. | 3,007. | 3,309. | 3,440. |
| | 132" | 131 ^{13/16"} | 47 ^{1/2"} | 1 ^{1/4"} | 28 ^{1/2"} | DT1ARY13248N | 2,853. | 2,908. | 2,965. | 3,491. | 3,840. | 3,995. |
| | 144" | 143 ^{13/16"} | 47 ^{1/2"} | 1 ^{1/4"} | 28 ^{1/2"} | DT1ARY14448N | 2,965. | 3,021. | 3,079. | 3,973. | 4,371. | 4,547. |

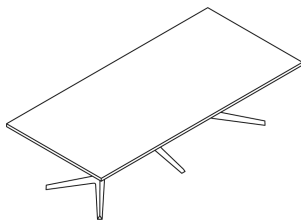

w* = nominal width
Dimensions listed under w d t h are actual to the nearest 1/16"

| Ordering Information | Order Code | Included with: | Options |
|--------------------------------|---|--------------------------|--------------------------|
| Conference Tables: | Conference Table: | Conference Table: | Conference Tables |
| 1. Pattern number | <i>Example:</i> DT1ARY10836N | • (2) Y Legs | |
| 2. Base/Stretcher Paint Finish | DT1 Dividends Horizon Table | • (1) T leg | |
| 3. Top Finish | A Table Assembly | • (2) Stretchers | |
| 4. Edge Finish | R Rectangular shape | • Table Top | |
| | Y Y Leg Base | • Hardware Kit | |
| | 108 Overall width in inches | | |
| | 36 Overall depth in inches | | |
| | N No grommet | | |
| | 114 Base/ stretcher paint finish | | |
| | 114 Laminate top finish | | |
| | 114 Edgeband finish | | |

Conference Tables

Racetrack Table Top

36", 42" and 48" Deep

Dividends Horizon

| description | w | w | d | t | h | pattern no. | Laminate | Laminate | Laminate | Techgrain | Techgrain | Techgrain |
|-------------------------------------|------|-----------------------|--------------------|-------------------|--------------------|---------------------|-----------------|-----------------|-----------------|-----------------|-----------------|-----------------|
| | | | | | | | Top P1 Paint | Top P2 Paint | Top P3 Paint | Top P1 Paint | Top P2 Paint | Top P3 Paint |
| 36" Deep Racetrack Conference Table | 102" | 101 ^{13/16"} | 35 ^{1/2"} | 1 ^{1/4"} | 28 ^{1/2"} | DT1ATY10236N | \$2,388. | \$2,443. | \$2,500. | \$3,525. | \$3,864. | \$3,978. |
| | 108" | 107 ^{13/16"} | 35 ^{1/2"} | 1 ^{1/4"} | 28 ^{1/2"} | DT1ATY10836N | 2,443. | 2,500. | 2,557. | 3,574. | 3,932. | 4,089. |

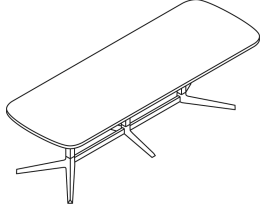

| | | | | | | | | | | | | |
|-------------------------------------|------|-----------------------|--------------------|-------------------|--------------------|---------------------|--------|--------|--------|--------|--------|--------|
| 42" Deep Racetrack Conference Table | 102" | 101 ^{13/16"} | 41 ^{1/2"} | 1 ^{1/4"} | 28 ^{1/2"} | DT1ATY10242N | 2,443. | 2,500. | 2,557. | 3,552. | 3,921. | 4,091. |
| | 108" | 107 ^{13/16"} | 41 ^{1/2"} | 1 ^{1/4"} | 28 ^{1/2"} | DT1ATY10842N | 2,500. | 2,557. | 2,615. | 3,637. | 3,978. | 4,148. |
| | 120" | 119 ^{13/16"} | 41 ^{1/2"} | 1 ^{1/4"} | 28 ^{1/2"} | DT1ATY12042N | 2,674. | 2,729. | 2,786. | 3,712. | 4,083. | 4,246. |
| | 132" | 131 ^{13/16"} | 41 ^{1/2"} | 1 ^{1/4"} | 28 ^{1/2"} | DT1ATY13242N | 2,786. | 2,844. | 2,901. | 4,262. | 4,687. | 4,876. |
| | 144" | 143 ^{13/16"} | 41 ^{1/2"} | 1 ^{1/4"} | 28 ^{1/2"} | DT1ATY14442N | 2,901. | 2,957. | 3,013. | 4,811. | 5,290. | 5,503. |

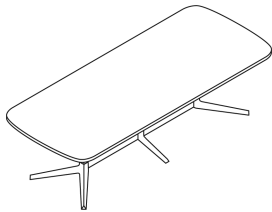

| | | | | | | | | | | | | |
|-------------------------------------|------|-----------------------|--------------------|-------------------|--------------------|---------------------|--------|--------|--------|--------|--------|--------|
| 48" Deep Racetrack Conference Table | 102" | 101 ^{13/16"} | 47 ^{1/2"} | 1 ^{1/4"} | 28 ^{1/2"} | DT1ATY10248N | 2,500. | 2,557. | 2,615. | 3,637. | 3,949. | 4,119. |
| | 108" | 107 ^{13/16"} | 47 ^{1/2"} | 1 ^{1/4"} | 28 ^{1/2"} | DT1ATY10848N | 2,557. | 2,615. | 2,672. | 3,751. | 4,035. | 4,206. |
| | 120" | 119 ^{13/16"} | 47 ^{1/2"} | 1 ^{1/4"} | 28 ^{1/2"} | DT1ATY12048N | 2,737. | 2,793. | 2,853. | 3,794. | 4,174. | 4,342. |
| | 132" | 131 ^{13/16"} | 47 ^{1/2"} | 1 ^{1/4"} | 28 ^{1/2"} | DT1ATY13248N | 2,853. | 2,908. | 2,965. | 4,353. | 4,788. | 4,982. |
| | 144" | 143 ^{13/16"} | 47 ^{1/2"} | 1 ^{1/4"} | 28 ^{1/2"} | DT1ATY14448N | 2,965. | 3,021. | 3,079. | 4,914. | 5,404. | 5,620. |

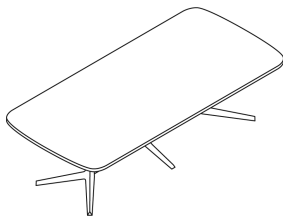

w* = nominal width
Dimensions listed under w d t h are actual to the nearest 1/16"

| Ordering Information | Order Code | Included with: | Options |
|--------------------------------|---|--------------------------|--------------------------|
| Conference Tables: | Conference Table: | Conference Table: | Conference Tables |
| 1. Pattern number | <i>Example:</i> DT1ARY10836N | • (2) Y Legs | |
| 2. Base/Stretcher Paint Finish | DT1 Dividends Horizon Table | • (1) T leg | |
| 3. Top Finish | A Table Assembly | • (2) Stretchers | |
| 4. Edge Finish | R Rectangular shape | • Table Top | |
| | Y Y Leg Base | • Hardware Kit | |
| | 108 Overall width in inches | | |
| | 36 Overall depth in inches | | |
| | N No grommet | | |
| | 114 Base/ stretcher paint finish | | |
| | 114 Laminate top finish | | |
| | 114 Edgeband finish | | |

Conference Tables

Boat Shape Table Top

42" and 48" Deep

| description | w* | w | d | t | h | pattern no. | Laminate | Laminate | Laminate | Techgrain | Techgrain | Techgrain |
|---|------|------------|---------|--------|---------|---------------------|-----------------|-----------------|-----------------|-----------------|-----------------|-----------------|
| | | | | | | | Top P1 Paint | Top P2 Paint | Top P3 Paint | Top P1 Paint | Top P2 Paint | Top P3 Paint |
| 42" Deep Boat Shape Conference Table | 102" | 101 13/16" | 41 1/2" | 1 1/4" | 28 1/2" | DT1ABY10242N | \$2,443. | \$2,500. | \$2,557. | \$3,552. | \$3,921. | \$4,091. |
| | 108" | 107 13/16" | 41 1/2" | 1 1/4" | 28 1/2" | DT1ABY10842N | 2,500. | 2,557. | 2,615. | 3,637. | 3,978. | 4,148. |
| | 120" | 119 13/16" | 41 1/2" | 1 1/4" | 28 1/2" | DT1ABY12042N | 2,674. | 2,729. | 2,786. | 3,712. | 4,083. | 4,246. |
| | 132" | 131 13/16" | 41 1/2" | 1 1/4" | 28 1/2" | DT1ABY13242N | 2,786. | 2,844. | 2,901. | 4,262. | 4,687. | 4,876. |
| | 144" | 143 13/16" | 41 1/2" | 1 1/4" | 28 1/2" | DT1ABY14442N | 2,901. | 2,957. | 3,013. | 4,811. | 5,290. | 5,503. |

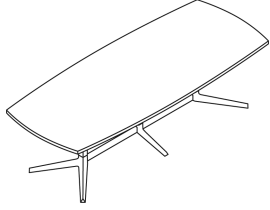

| | | | | | | | | | | | | |
|---|------|------------|---------|--------|---------|---------------------|--------|--------|--------|--------|--------|--------|
| 48" Deep Boat Shape Conference Table | 102" | 101 13/16" | 47 1/2" | 1 1/4" | 28 1/2" | DT1ABY10248N | 2,500. | 2,557. | 2,615. | 3,637. | 3,949. | 4,119. |
| | 108" | 107 13/16" | 47 1/2" | 1 1/4" | 28 1/2" | DT1ABY10848N | 2,557. | 2,615. | 2,672. | 3,751. | 4,035. | 4,206. |
| | 120" | 119 13/16" | 47 1/2" | 1 1/4" | 28 1/2" | DT1ABY12048N | 2,737. | 2,793. | 2,853. | 3,794. | 4,174. | 4,342. |
| | 132" | 131 13/16" | 47 1/2" | 1 1/4" | 28 1/2" | DT1ABY13248N | 2,853. | 2,908. | 2,965. | 4,353. | 4,788. | 4,982. |
| | 144" | 143 13/16" | 47 1/2" | 1 1/4" | 28 1/2" | DT1ABY14448N | 2,965. | 3,021. | 3,079. | 4,914. | 5,404. | 5,620. |

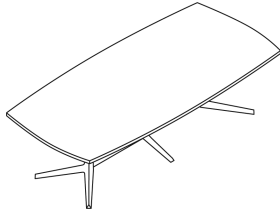

Tables

w* = nominal width
Dimensions listed under w d t h are actual to the nearest 1/16"

| Ordering Information | Order Code | Included with: | Options |
|--------------------------------|---|--------------------------|--------------------------|
| Conference Tables: | Conference Table: | Conference Table: | Conference Tables |
| 1. Pattern number | <i>Example:</i> DT1ARY10836N | • (2) Y Legs | |
| 2. Base/Stretcher Paint Finish | DT1 Dividends Horizon Table | • (1) T leg | |
| 3. Top Finish | A Table Assembly | • (2) Stretchers | |
| 4. Edge Finish | R Rectangular shape | • Table Top | |
| | Y Y Leg Base | • Hardware Kit | |
| | 108 Overall width in inches | | |
| | 36 Overall depth in inches | | |
| | N No grommet | | |
| | 114 Base/ stretcher paint finish | | |
| | 114 Laminate top finish | | |
| | 114 Edgeband finish | | |

Preconfigured Desks

Series 2 Single and Double Pedestal Specifications

Series 2 Single and Double Pedestal Desks

Series 2 freestanding single and double pedestal desks can be specified "Preconfigured" or by component for "Build-to-Spec" applications. These applications include when a different pedestal drawer configuration is required, or when back panels are not needed.

"Preconfigured" single pedestal desks consist of a worksurface, Series 2 box/box/file pedestal, "L" shaped end panel and full height back panel.

"Preconfigured" double pedestal desks consist of a worksurface, two pedestals (file/file and box/ box/file) and full height back panel.

Available Sizes

- Height: 28½"
- Depths: 24", 30" and 36"
(double pedestal desk only)
- Widths: 60", 66" and 72"
- Worksurface thickness: 1¼"

"Build-to-Spec" Desks

For "Build-to-Spec" desks specify by component. Refer to individual component category for information.

Construction

All freestanding desks match the aesthetics and dimensions of Dividends Horizon panel components.

Drawers overlay the cabinet front and feature softly-radiused integral pulls, drawer fronts and drawer trim. Series 2 desks include full-height modesty panels.

Worksurface support is provided by pedestals and end units which are non-handed and shipped knocked down. This allows pedestals and end units to be positioned at either end of worksurfaces.

Optional Edge Grommets

Edge grommets are optional for all desks except overhang desks and can be specified factory-installed, centered along the rear edge of worksurfaces. Grommets can also be ordered as a kit (pattern number D1WSG) for field installation in any position along the rear edge of the worksurface. When grommets are specified, a reveal of ½" is provided between the rear of the worksurface and the back panel for repositioning cables anywhere along the back panel.

Locks

Desk pedestals can be ordered with or without locks. When specified without locks, a lock plug is included. An optional lock retrofit kit is available for field-installation of locks at a later date if required. Locks are keyed randomly unless otherwise specified. Other keying options include keyed alike or keyed with lock cores K001-K250.

All locks are factory-installed and have a black finish.

Desk Accessory

All Series 2 pedestal accessories including the hanging file bar must be specified separately.

Series 2 Single Pedestal Desk

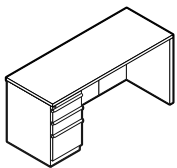

Series 2 Double Pedestal Desk

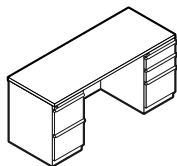

Series 2 Desk Components

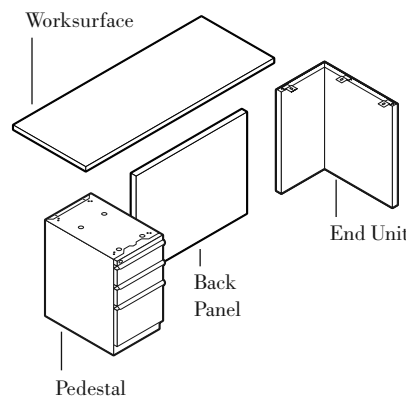

Optional Edge Grommet

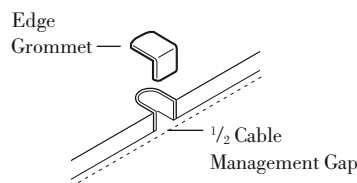

Series 2 Freestanding Desk Configurations

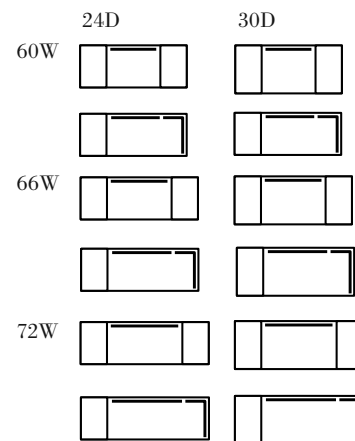

Preconfigured Desks

Series 2 Single and Double Pedestal

24", 30" and 36" Deep

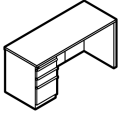
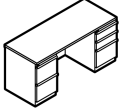
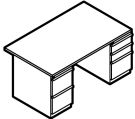
| description | w* | w | d | h | pattern no. | P1 | P2 | P3 |
|---|-----|----------------------|--------------------|--------------------|--------------------|----------|----------|----------|
|  Single Pedestal Desk with Locks | 60" | 59 ^{13/16"} | 23 ^{1/2"} | 28 ^{1/2"} | DD2S L6024N | \$1,654. | \$1,787. | \$1,850. |
| | 60" | 59 ^{13/16"} | 29 ^{1/2"} | 28 ^{1/2"} | DD2S L6030N | 1,814. | 1,951. | 2,020. |
| | 66" | 65 ^{13/16"} | 23 ^{1/2"} | 28 ^{1/2"} | DD2S L6624N | 1,694. | 1,827. | 1,893. |
| | 66" | 65 ^{13/16"} | 29 ^{1/2"} | 28 ^{1/2"} | DD2S L6630N | 1,873. | 2,013. | 2,082. |
| | 72" | 71 ^{13/16"} | 23 ^{1/2"} | 28 ^{1/2"} | DD2S L7224N | 1,723. | 1,856. | 1,923. |
| | 72" | 71 ^{13/16"} | 29 ^{1/2"} | 28 ^{1/2"} | DD2S L7230N | 1,903. | 2,046. | 2,115. |
|  Double Pedestal Desk with Locks | 60" | 59 ^{13/16"} | 23 ^{1/2"} | 28 ^{1/2"} | DD2D L6024N | 1,902. | 2,059. | 2,137. |
| | 60" | 59 ^{13/16"} | 29 ^{1/2"} | 28 ^{1/2"} | DD2D L6030N | 2,054. | 2,215. | 2,295. |
| | 66" | 65 ^{13/16"} | 23 ^{1/2"} | 28 ^{1/2"} | DD2D L6624N | 1,944. | 2,100. | 2,180. |
| | 66" | 65 ^{13/16"} | 29 ^{1/2"} | 28 ^{1/2"} | DD2D L6630N | 2,115. | 2,279. | 2,360. |
| | 72" | 71 ^{13/16"} | 23 ^{1/2"} | 28 ^{1/2"} | DD2D L7224N | 1,971. | 2,130. | 2,210. |
| | 72" | 71 ^{13/16"} | 29 ^{1/2"} | 28 ^{1/2"} | DD2D L7230N | 2,146. | 2,309. | 2,394. |
|  Double Pedestal Desk with Locks and 6" Front Overhang | 60" | 59 ^{13/16"} | 35 ^{1/2"} | 28 ^{1/2"} | DD2O L6036N | 2,178. | 2,337. | 2,420. |
| | 66" | 65 ^{13/16"} | 35 ^{1/2"} | 28 ^{1/2"} | DD2O L6636N | 2,247. | 2,412. | 2,493. |
| | 72" | 71 ^{13/16"} | 35 ^{1/2"} | 28 ^{1/2"} | DD2O L7236N | 2,322. | 2,488. | 2,566. |

w* = nominal width
 Dimensions listed under w d h are actual to the nearest 1/16"

| Ordering Information | Order Code | Included with: | Options |
|--|--|--|--|
| Single Pedestal Desk 1. Pattern Number 2. Laminate Finish 3. Edge Band Finish 4. Paint Finish Double Pedestal Desk 1. Pattern Number 2. Laminate Finish 3. Edge Band Finish 4. Paint Finish | Single Pedestal Desk <i>Example:</i> DD2S L7230N, 117, 117, 117 DD2S Pattern Number L7230N 117 Soft Grey laminate 117 Soft Grey edge finish 117 Soft Grey paint finish Double Pedestal Desk <i>Example:</i> DD2D L7230N, 117, 117, 117 DD2D Pattern Number L7230N 117 Soft Grey laminate 117 Soft Grey edge finish 117 Soft Grey paint finish | Single Pedestal Desk Double Pedestal Desk Note: An upcharge applies when specifying Legacy laminates. See Legacy finish page. | Single Pedestal Desk <ul style="list-style-type: none"> To specify desk with center located edge grommet, replace the suffix letter "N" with a "G". Add \$19 (Grommets not available for overhang desks) <ul style="list-style-type: none"> To specify pedestals without locks, replace the fifth character "L" with an "N". Deduct \$22 Double Pedestal Desk <ul style="list-style-type: none"> To specify desk with center located edge grommet, replace the suffix letter "N" with a "G". Add \$19 (Grommets not available for overhang desks) <ul style="list-style-type: none"> To specify pedestals without locks, replace the fifth character "L" with an "N". Deduct \$42 |

Preconfigured Desks

Single and Double Pedestal Specifications

Single and Double Pedestal Desks

Dividends freestanding single and double pedestal desks can be specified "Preconfigured" or by component for "Build-to-Spec" applications. These applications include when a different pedestal drawer configuration is required, or when back panels are not needed. "Preconfigured" single pedestal desks consist of a worksurface, box/box/file pedestal, "L" shaped end panel and half-height back panel. "Preconfigured" double pedestal desks consist of a worksurface, two pedestals (file/file and box/ box/file) and half-height back panel.

Available Sizes

- Height: 28 1/2"
- Depths: 24", 30" and 36"
(Double pedestal desk only)
- Widths: 60", 66" and 72"
- Worksurface thickness: 1 1/4"

"Build-to-Spec" Desks

For "Build-to-Spec" desks specify by component. Refer to individual component category for information.

Construction

All freestanding desks match the aesthetics and dimensions of Dividends panel components.

Drawers overlay the cabinet front and feature softly-radiused pulls, drawer fronts and drawer trim.

Half-height back panels extend 11" from the bottom of the worksurface, are inset 3/4" from the pedestal backs and match the softly-radiused aesthetics of other Dividends components.

Worksurface support is provided by pedestals and end units which are non-handed and shipped knocked down. This allows pedestals and end units to be positioned at either end of worksurfaces.

Locks

Desk pedestals can be ordered with or without locks. When specified without locks, a lock plug is included. An optional lock retrofit kit is available for field-installation of locks at a later date if required. Locks are keyed randomly unless otherwise specified. Other keying options include keyed alike or keyed with lock cores K001-K250 All locks are factory-installed and have a black finish.

Accessory

Hanging file bars for front-to-back or side-to-side filing are included with pedestals.

Single Pedestal Desk

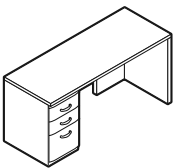

Double Pedestal Desk

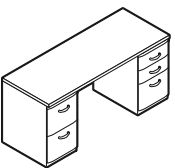

Desk Components

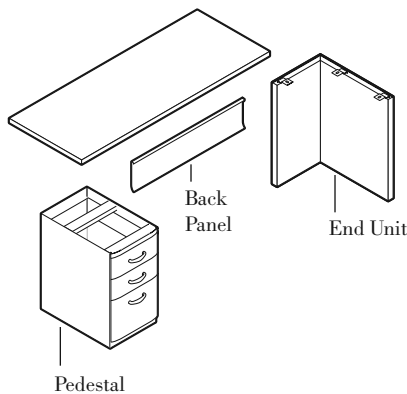

Freestanding Desk Configurations

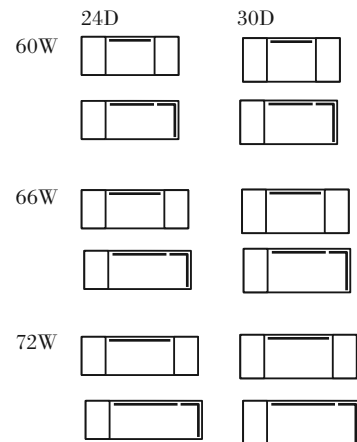

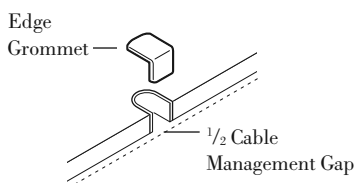

Optional Edge Grommet



Preconfigured Desks

Single and Double Pedestal

24", 30" and 36" Deep

| description | w* | w | d | h | pattern no. | P1 | P2 | P3 |
|---|-----|----------------------|--------------------|--------------------|--------------------|----------|----------|----------|
|  Single Pedestal Desk with Locks | 60" | 59 ^{13/16"} | 23 ^{1/2"} | 28 ^{1/2"} | DD1S L6024N | \$1,654. | \$1,787. | \$1,850. |
| | 60" | 59 ^{13/16"} | 29 ^{1/2"} | 28 ^{1/2"} | DD1S L6030N | 1,814. | 1,951. | 2,020. |
| | 66" | 65 ^{13/16"} | 23 ^{1/2"} | 28 ^{1/2"} | DD1S L6624N | 1,694. | 1,827. | 1,893. |
| | 66" | 65 ^{13/16"} | 29 ^{1/2"} | 28 ^{1/2"} | DD1S L6630N | 1,873. | 2,013. | 2,082. |
| | 72" | 71 ^{13/16"} | 23 ^{1/2"} | 28 ^{1/2"} | DD1S L7224N | 1,723. | 1,856. | 1,923. |
| | 72" | 71 ^{13/16"} | 29 ^{1/2"} | 28 ^{1/2"} | DD1S L7230N | 1,903. | 2,046. | 2,115. |
|  Double Pedestal Desk with Locks | 60" | 59 ^{13/16"} | 23 ^{1/2"} | 28 ^{1/2"} | DD1D L6024N | 1,902. | 2,059. | 2,137. |
| | 60" | 59 ^{13/16"} | 29 ^{1/2"} | 28 ^{1/2"} | DD1D L6030N | 2,054. | 2,215. | 2,295. |
| | 66" | 65 ^{13/16"} | 23 ^{1/2"} | 28 ^{1/2"} | DD1D L6624N | 1,944. | 2,100. | 2,180. |
| | 66" | 65 ^{13/16"} | 29 ^{1/2"} | 28 ^{1/2"} | DD1D L6630N | 2,115. | 2,279. | 2,360. |
| | 72" | 71 ^{13/16"} | 23 ^{1/2"} | 28 ^{1/2"} | DD1D L7224N | 1,971. | 2,130. | 2,210. |
| | 72" | 71 ^{13/16"} | 29 ^{1/2"} | 28 ^{1/2"} | DD1D L7230N | 2,146. | 2,309. | 2,394. |
|  Double Pedestal Desk with Locks and 6" Front Overhang | 60" | 59 ^{13/16"} | 35 ^{1/2"} | 28 ^{1/2"} | DD1O L6036N | 2,178. | 2,337. | 2,420. |
| | 66" | 65 ^{13/16"} | 35 ^{1/2"} | 28 ^{1/2"} | DD1O L6636N | 2,247. | 2,412. | 2,493. |
| | 72" | 71 ^{13/16"} | 35 ^{1/2"} | 28 ^{1/2"} | DD1O L7236N | 2,322. | 2,488. | 2,566. |

w* = nominal width
 Dimensions listed under w d h are actual to the nearest 1/16"

| Ordering Information | Order Code | Included with: | Options |
|--|--|--|--|
| Single Pedestal Desk 1. Pattern Number 2. Laminate Finish 3. Edge Band Finish 4. Paint Finish 5. Pull Finish 6. Drawer Top Cap Finish | Single Pedestal Desk <i>Example:</i> DD1S L7230N, 117, 117, 117, 117, 117 DD1S Pattern Number L7230N 117 Soft Grey laminate 117 Soft Grey edge finish 117 Soft Grey paint finish 117 Soft Grey pull finish Y3 Dark Grey top cap finish | Single Pedestal Desk Double Pedestal Desk Note: An upcharge applies when specifying Legacy laminates. See Legacy finish page. | Single Pedestal Desk <ul style="list-style-type: none"> To specify desk with center located edge grommet, replace the suffix letter "N" with a "G". Add \$19 (Grommets not available for overhang desks) <ul style="list-style-type: none"> To specify pedestals without locks, replace the fifth character "L" with an "N". Deduct \$22 |
| Double Pedestal Desk 1. Pattern Number 2. Laminate Finish 3. Edge Band Finish 4. Paint Finish 5. Pull Finish 6. Drawer Top Cap Finish | Double Pedestal Desk <i>Example:</i> DD1D L7230N, 117, 117, 117, 117, 117 DD1D Pattern Number L7230N 117 Soft Grey laminate 117 Soft Grey edge finish 117 Soft Grey paint finish 117 Soft Grey pull finish 117 Soft Grey top cap finish | | Double Pedestal Desk <ul style="list-style-type: none"> To specify desk with center located edge grommet, replace the suffix letter "N" with a "G". Add \$19 (Grommets not available for overhang desks) <ul style="list-style-type: none"> To specify pedestals without locks, replace the fifth character "L" with an "N". Deduct \$42 |

Preconfigured Desks

Series 2 Freestanding Corner Unit Specifications

Series 2 Freestanding Corner Units (Assembly)

Dividends Horizon Series 2 freestanding corner units are available "Preconfigured" and can also be specified by component for "Build-to-Spec" applications.

"Preconfigured" freestanding corners consist of a worksurface, three "L" shaped end units and two full height back panels.

Available Sizes

- Height: 28½"
- Widths: 36", 42" and 48"
- Returns: 24" depth

Construction

Corner Unit:

- Worksurface: 1¼" thick, 45 lb. density particle board core with high pressure laminate surface and 2mm vinyl edge banding
- Back panels: 20-gauge steel
- Series 2 Freestanding Corner Units include full height back panels

Rear Corner End Unit

- Outer skin: 21-gauge steel
- Inner frame: 20-gauge steel
- Leveling glide: ¾" 16-gauge steel with 1½" of height adjustment
- Attachment bracket: 11-gauge steel

Side Corner End Unit

- Outer skin: 21-gauge
- Inner frame: 20-gauge
- Leveling glide: ¾" 16-gauge steel with 1½" of height adjustment
- Attachment bracket: 11-gauge steel

Freestanding Corner End Units (Components)

Freestanding corner end units have mounting brackets that allow attachment to corner worksurfaces. A 6" wide rear corner end unit is used in the rear corner to support the worksurface top. A 12" wide non-handed side corner end unit is attached to both sides of a corner worksurface for support.

Optional Edge Grommets

Edge grommets are optional and can be specified factory-installed on center on both edges along the rear edge of the worksurface. Grommets can also be ordered as a kit (pattern number D1WSG) for field installation in any position along the rear edge of the worksurface.

Series 2 Freestanding Corner Unit Components

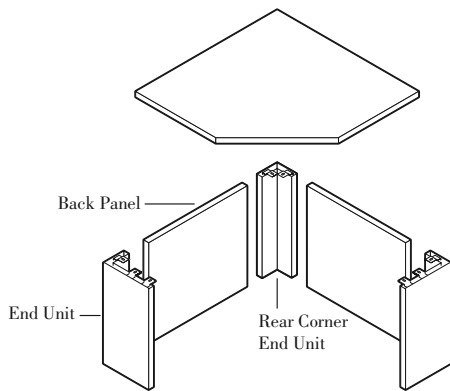

Edge Grommet Locations

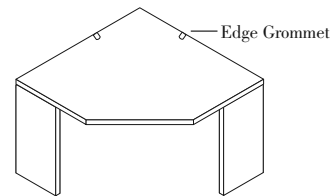

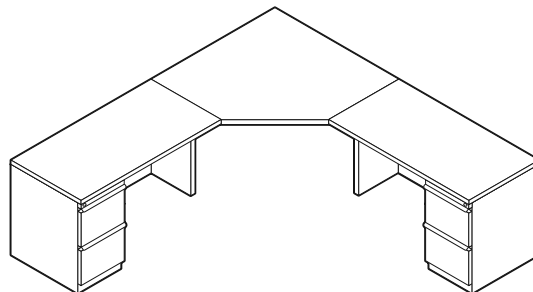

Series 2 Freestanding Corner Unit Attached to Return to Form a "L" Shaped Workstation



Preconfigured Desks

Series 2 Freestanding Corner Unit

24" Deep

| description | type | w * | w | d | h | pattern no. | P1 | P2 | P3 |
|--|------|-----|---------|---------|---------|---------------------|----------|----------|----------|
|  Freestanding Corner Unit (Assembly) | | 36" | 35 1/2" | 23 1/2" | 28 1/2" | DD2VD 3624 N | \$1,398. | \$1,539. | \$1,609. |
| | | 42" | 41 1/2" | 23 1/2" | 28 1/2" | DD2VD 4224 N | 1,445. | 1,590. | 1,662. |
| | | 48" | 47 1/2" | 23 1/2" | 28 1/2" | DD2VD 4824 N | 1,516. | 1,667. | 1,743. |
|  Freestanding Curved Corner Unit (Assembly) | | 36" | 35 1/2" | 23 1/2" | 28 1/2" | DD2VL 3624 N | 1,428. | 1,571. | 1,644. |
| | | 42" | 41 1/2" | 23 1/2" | 28 1/2" | DD2VL 4224 N | 1,515. | 1,666. | 1,742. |
| | | 48" | 47 1/2" | 23 1/2" | 28 1/2" | DD2VL 4824 N | 1,582. | 1,742. | 1,819. |
|  Freestanding Corner End Unit (Component) | | | 6 9/16" | 6 9/16" | 26 7/8" | DD1R CU6 | 293. | 324. | 338. |

w* = nominal width
 Dimensions listed under w d h are actual to the nearest 1/16"

| Ordering Information | Order Code | Included with: | Options |
|---|---|--|---|
| Freestanding Corner 1. Pattern Number 2. Laminate Finish 3. Edge Band Finish 4. Paint Finish | Freestanding Corner <i>Example:</i> DD2VD 3624 N, 117, 117 DD2VD Pattern Number 3624 N No Grommets 117 Soft Grey laminate 117 Soft Grey edge finish 117 Soft Grey paint finish | Freestanding Corner <ul style="list-style-type: none"> • Corner supports (3) • Back panels (2) • Corner worksurface • Connecting hardware Freestanding Corner End Unit Note: Series 2 freestanding corner units have full height modesty panels. Note: An upcharge applies when specifying Legacy laminates. See Legacy finish page. | Freestanding Corner <ul style="list-style-type: none"> • To specify two center-mounted edge grommets, replace the suffix letter "N" with a "G". Add \$30. Freestanding Corner End Unit |
| Freestanding Corner End Unit 1. Pattern Number 2. Paint Finish | Freestanding Corner End Unit <i>Example:</i> DD1RCU6, 117 DD1RCU6 Pattern Number 117 Soft Grey paint finish | | |

Preconfigured Desks

Freestanding Corner Unit Specifications

Freestanding Corner Units (Assembly)

Dividends freestanding corner units are available "Preconfigured" and can also be specified by component for "Build-to-Spec" applications. "Preconfigured" freestanding corners consist of a worksurface, three "L" shaped end units and two 11" high back panels.

Available Sizes

- Height: 28½"
- Widths: 36", 42" and 48"
- Returns: 24" depth

Construction

Corner Unit Specifications

- Worksurface: 1¼" thick, 45 lb. density particle board core with high pressure laminate surface and 2mm vinyl edge banding
- Back panels: 20-gauge steel

Rear Corner End Unit

- Outer skin: 21-gauge steel
- Inner frame: 20-gauge steel
- Leveling glide: ¾" 16-gauge steel with 1½" of height adjustment
- Attachment bracket: 11-gauge steel

Side Corner End Unit

- Outer skin: 21-gauge
- Inner frame: 20-gauge
- Leveling glide: ¾" 16-gauge steel
- Attachment bracket: 11-gauge steel

Freestanding Corner End Units (Components)

Freestanding corner end units have mounting brackets that allow attachment to corner worksurfaces. A 6" wide rear corner end unit is used in the rear corner to support the worksurface top. A 12" wide non-handed side corner end unit is attached to both sides of a corner worksurface for support.

Optional Edge Grommets

Edge grommets are optional and can be specified factory-installed on center on both edges along the rear edge of the worksurface. Grommets can also be ordered as a kit (pattern number D1WSG) for field installation in any position along the rear edge of the worksurface.

Freestanding Corner Unit Components

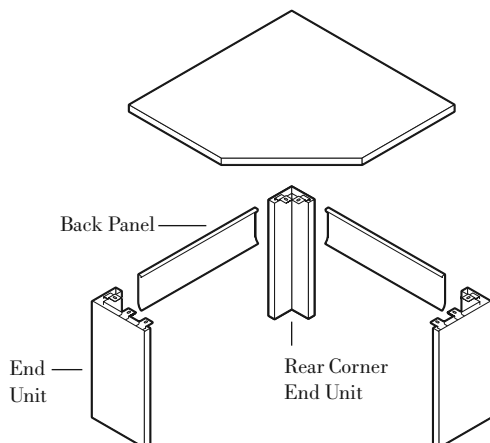

Edge Grommet Locations

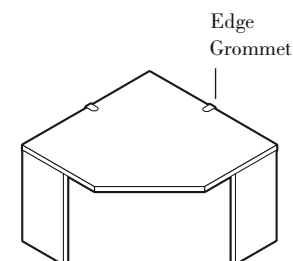

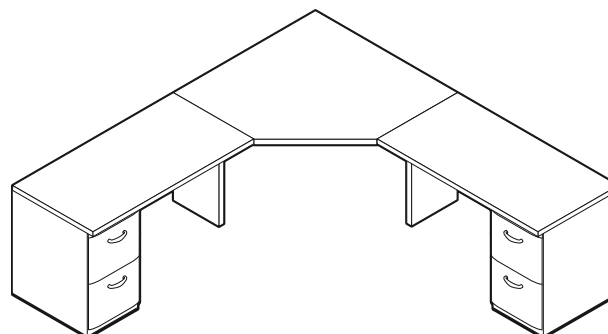

Freestanding Corner Unit attached to returns to form an "L" shaped workstation



Preconfigured Desks

Freestanding Corner Unit

24" Deep

| description | type | w* | w | d | h | pattern no. | P1 | P2 | P3 |
|--|-------------|-----|-----------|----------|---------|---------------------|----------|----------|----------|
|  Freestanding Corner Unit (Assembly) | | 36" | 35 1/2" | 23 1/2" | 28 1/2" | DD1VD 3624 N | \$1,398. | \$1,539. | \$1,609. |
| | | 42" | 41 1/2" | 23 1/2" | 28 1/2" | DD1VD 4224 N | 1,445. | 1,590. | 1,662. |
| | | 48" | 47 1/2" | 23 1/2" | 28 1/2" | DD1VD 4824 N | 1,516. | 1,667. | 1,743. |
|  Freestanding Curved Corner Unit (Assembly) | | 36" | 35 1/2" | 23 1/2" | 28 1/2" | DD1VL 3624 N | 1,428. | 1,571. | 1,644. |
| | | 42" | 41 1/2" | 23 1/2" | 28 1/2" | DD1VL 4224 N | 1,515. | 1,666. | 1,742. |
| | | 48" | 47 1/2" | 23 1/2" | 28 1/2" | DD1VL 4824 N | 1,582. | 1,742. | 1,819. |
| Freestanding Corner End Unit (Component) | | | 6 9/16" | 6 9/16" | 26 7/8" | DD1R CU6 | 293. | 324. | 338. |
| Freestanding Corner Unit (Component) | | | 6 9/16" | 12 9/16" | 26 7/8" | DD1S CU12 | 346. | 380. | 398. |
|  Back Panels for Freestanding Corner Unit (Component) | full height | 36" | 20 15/16" | 26 5/8" | | DD1 FBPV36 | 209. | 227. | 238. |
| | full height | 42" | 26 15/16" | 26 5/8" | | DD1 FBPV42 | 211. | 230. | 242. |
| | full height | 48" | 32 15/16" | 26 5/8" | | DD1 FBPV48 | 214. | 235. | 245. |
| | half height | 36" | 20 15/16" | 11" | | DD1 BPV36 | 175. | 190. | 199. |
| | half height | 42" | 26 15/16" | 11" | | DD1 BPV42 | 183. | 202. | 211. |
| | half height | 48" | 32 15/16" | 11" | | DD1 BPV48 | 191. | 213. | 222. |

w* = nominal width
 Dimensions listed under w d h are actual to the nearest 1/16"

| Ordering Information | Order Code | Included with: | Options |
|---|---|--|--|
| Freestanding Corner 1. Pattern Number 2. Laminate Finish 3. Edge Band Finish 4. Paint Finish | Freestanding Corner <i>Example:</i> DD1VD 3624 N, 117, 117 DD1VD Pattern Number 3624 N No Grommets 117 Soft Grey laminate 117 Soft Grey edge finish 117 Soft Grey paint finish Freestanding Corner End Unit <i>Example:</i> DD1R CU6, 117 DD1R Pattern Number CU6 117 Soft Grey paint finish Freestanding Corner Back Panel <i>Example:</i> DD1 BPV42, 115 DD1 Pattern Number BPV42 115 Medium grey paint finish | Freestanding Corner <ul style="list-style-type: none"> • Corner supports (3) • Back panels (2) • Corner worksurface • Connecting hardware Freestanding Corner End Unit Freestanding Corner Back Panel Note: Series 1 freestanding corner units have a curved half modesty panel. Note: An upcharge applies when specifying Legacy laminates. See Legacy finish page. | Freestanding Corner <ul style="list-style-type: none"> • To specify two center-mounted edge grommets, replace the suffix letter "N" with a "G". Add \$30. Freestanding Corner End Unit Freestanding Corner Back Panel |

Preconfigured Desks

Series 2 Returns and Bridge Units

Specifications

Series 2 End Panel and Pedestal Returns

Dividends Horizon freestanding returns can be specified "Preconfigured" or can be ordered by component for "Build-to-Spec" applications. These applications include when a different pedestal drawer combination is required or when back panels are not needed.

"Preconfigured" pedestal returns consist of a worksurface, file/file pedestal, and full-height back panel. "Preconfigured" end panel returns consist of a worksurface, "L" shaped end panel and full height back panel.

Available Sizes

- Height: 28 1/2"
- Widths: 36", 42" and 48"
- Depths: 18" and 24"

Attachment

Returns attach to adjacent desks or freestanding corner units with flat brackets, which are included.

Construction

All freestanding returns match the aesthetics of the Dividends Horizon panel system.

Drawers overlay the cabinet front and feature softly-radiused integral pulls, drawer fronts and drawer trim. Series 2 Desk components include full-height back panels.

Worksurface support is provided by pedestals and end units which are non-handed and shipped knocked down. This allows pedestals and end units to be positioned at either end of worksurfaces.

"Build-to-Spec" Returns and Bridges

For "Build-to-Spec" returns and bridges, specify by component. Refer to the individual component categories for information.

Accessory

Hanging file bars for front-to-back or side-to-side filing are included with pedestals.

Bridge Units

Bridge units are used to form freestanding "U" shaped workstations.

Bridge units consist of a worksurface and back panel and connect to adjacent freestanding components with flat brackets which are included.

Available Sizes

- Height: 28 1/2"
- Widths: 30", 36", 42" and 48"
- Depths: 18" and 24"

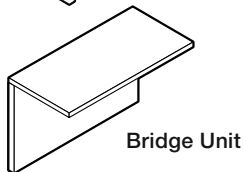
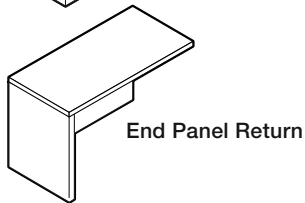
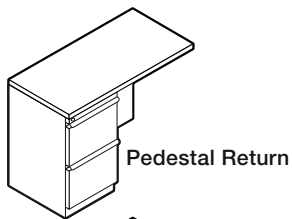

Series 2 Return Sizes Available

| | 18"D | 24"D |
|------|------|------|
| 30"W | | |
| 42"W | | |
| 48"W | | |

Series 2 Bridge Unit Sizes Available

| | | |
|------|--|--|
| 30"W | | |
| 42"W | | |
| 42"W | | |
| 48"W | | |

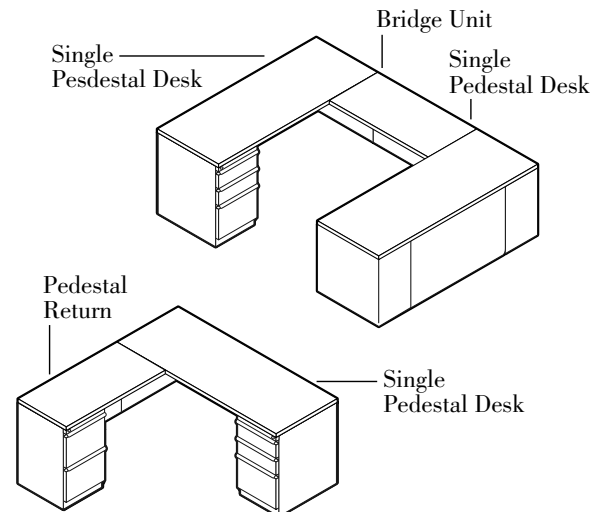

Series 2 Desk Configurations



Preconfigured Desks

Series 2 Returns and Bridge Units

18" and 24" Deep

| description | w* | w | d | h | pattern no. | P1 | P2 | P3 |
|--|-----|------------------------------------|----------------------------------|----------------------------------|----------------------|--------|--------|--------|
|  End Panel Return | 36" | 35 ¹³ / ₁₆ " | 17 ¹ / ₂ " | 28 ¹ / ₂ " | DD2E 3618N | \$772. | \$830. | \$853. |
| | 36" | 35 ¹³ / ₁₆ " | 23 ¹ / ₂ " | 28 ¹ / ₂ " | DD2E 3624N | 843. | 902. | 933. |
| | 42" | 41 ¹³ / ₁₆ " | 17 ¹ / ₂ " | 28 ¹ / ₂ " | DD2E 4218N | 812. | 869. | 899. |
| | 42" | 41 ¹³ / ₁₆ " | 23 ¹ / ₂ " | 28 ¹ / ₂ " | DD2E 4224N | 883. | 944. | 976. |
|  Pedestal Return | 36" | 35 ¹³ / ₁₆ " | 17 ¹ / ₂ " | 28 ¹ / ₂ " | DD2P (L)3618N | 997. | 1,077. | 1,116. |
| | 36" | 35 ¹³ / ₁₆ " | 23 ¹ / ₂ " | 28 ¹ / ₂ " | DD2P (L)3624N | 1,091. | 1,173. | 1,215. |
| | 42" | 41 ¹³ / ₁₆ " | 17 ¹ / ₂ " | 28 ¹ / ₂ " | DD2P (L)4218N | 1,041. | 1,119. | 1,156. |
| | 42" | 41 ¹³ / ₁₆ " | 23 ¹ / ₂ " | 28 ¹ / ₂ " | DD2P (L)4224N | 1,134. | 1,218. | 1,259. |
| | 48" | 47 ¹³ / ₁₆ " | 17 ¹ / ₂ " | 28 ¹ / ₂ " | DD2P (L)4818N | 1,080. | 1,156. | 1,198. |
| | 48" | 47 ¹³ / ₁₆ " | 23 ¹ / ₂ " | 28 ¹ / ₂ " | DD2P (L)4824N | 1,177. | 1,263. | 1,307. |
|  Bridge Unit | 30" | 29 ¹³ / ₁₆ " | 17 ¹ / ₂ " | 28 ¹ / ₂ " | DD2B 3018N | 376. | 394. | 400. |
| | 36" | 35 ¹³ / ₁₆ " | 17 ¹ / ₂ " | 28 ¹ / ₂ " | DD2B 3618N | 415. | 434. | 443. |
| | 36" | 35 ¹³ / ₁₆ " | 23 ¹ / ₂ " | 28 ¹ / ₂ " | DD2B 3624N | 445. | 463. | 471. |
| | 42" | 41 ¹³ / ₁₆ " | 17 ¹ / ₂ " | 28 ¹ / ₂ " | DD2B 4218N | 450. | 469. | 478. |
| | 42" | 41 ¹³ / ₁₆ " | 23 ¹ / ₂ " | 28 ¹ / ₂ " | DD2B 4224N | 488. | 506. | 515. |
| | 48" | 47 ¹³ / ₁₆ " | 17 ¹ / ₂ " | 28 ¹ / ₂ " | DD2B 4818N | 488. | 506. | 515. |
| | 48" | 47 ¹³ / ₁₆ " | 23 ¹ / ₂ " | 28 ¹ / ₂ " | DD2B 4824N | 531. | 551. | 561. |

w* = nominal width
 Dimensions listed under w d h are actual to the nearest 1/16"

| Ordering Information | Order Code | Included with: | Options |
|---|--|---|--|
| Pedestal Return 1. Pattern Number 2. Laminate Finish 3. Edge Band Finish 4. Paint Finish | Pedestal Return <i>Example:</i> DD2P L4824N, 117, 117, 117 DP2P Pattern Number L4824N 117 Soft Grey laminate 117 Soft Grey edge finish 117 Soft Grey paint finish End Panel Return or Bridge Unit <i>Example:</i> DD2B 4224N, 117, 117, 117 DD2B Pattern Number 4424 117 Soft Grey laminate 117 Soft Grey finish 117 Soft Grey finish | Pedestal Return <ul style="list-style-type: none"> • Worksurface • Pedestal • Back panel • Half height flat bracket (1) • Connecting hardware End Panel Return or Bridge Unit <ul style="list-style-type: none"> • Worksurface • Back panel • Half height flat brackets (2) • Connecting hardware Note: An upcharge applies when specifying Legacy laminates. See Legacy finish page. | Pedestal Return <ul style="list-style-type: none"> • To specify center-mounted edge grommet, replace the "N" suffix from the pattern number with "G". Add \$19 • To specify pedestal without locks, replace the 5th digit "L" from the pattern number with "N". Deduct \$22 End Panel Return or Bridge Unit <ul style="list-style-type: none"> • To specify center-mounted edge grommet, replace the "N" suffix from the pattern number with "G". Add \$19 |

Preconfigured Desks

Returns and Bridge Units

Specifications

End Panel and Pedestal Returns

Dividends freestanding returns can be specified "Preconfigured" or can be ordered by component for "Build-to-Spec" applications. These applications include when a different pedestal drawer combination is required or when back panels are not needed.

"Preconfigured" pedestal returns consist of a worksurface, file/file pedestal, and half-height back panel. "Preconfigured" end panel returns consist of a worksurface, "L" shaped end panel and half-height back panel.

Available Sizes

- Height: 28 1/2"
- Widths: 36", 42" and 48"
- Depths: 18" and 24"

Attachment

Returns attach to adjacent desks or freestanding corner units with flat brackets, which are included.

Construction

All freestanding returns match the aesthetics of the Dividends panel system.

Drawers overlay the cabinet front and feature softly-radiused pulls, drawer fronts and drawer trim.

Half-height back panels extend 11" from the bottom of the worksurface, are inset 3/4" from the pedestal backs and match the softly radiused aesthetics of other Dividends components.

Worksurface support is provided by pedestals and end units which are non-handed and shipped knocked down. This allows pedestals and end units to be positioned at either end of worksurfaces.

"Build-to-Spec" Returns and Bridges

For "Build-to-Spec" returns and bridges, specify by component. Refer to the individual component categories for information.

Accessory

Hanging file bars for front-to-back or side-to-side filing are included with pedestals.

Bridge Units

Bridge units are used to form freestanding "U" shaped workstations.

Bridge units consist of a worksurface and back panel and connect to adjacent freestanding components with flat brackets which are included.

Available Sizes

- Height: 28 1/2"
- Widths: 30", 36", 42" and 48"
- Depths: 18" and 24"

Pedestal Return

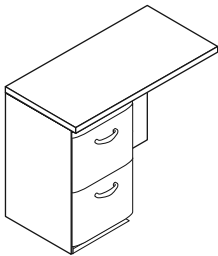

End Panel Return

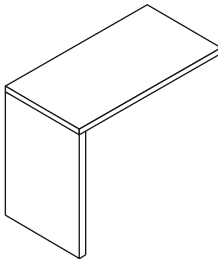

Bridge Unit



Return Sizes Available

| | 18D | 24D |
|-----|-----|-----|
| 30W | | |
| 30W | | |
| 42W | | |
| 42W | | |
| 48W | | |

Bridge Unit Sizes Available

| | | |
|-----|--|--|
| 30W | | |
| 42W | | |
| 42W | | |
| 48W | | |

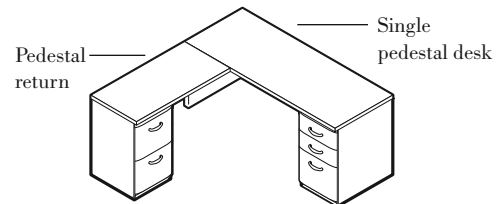
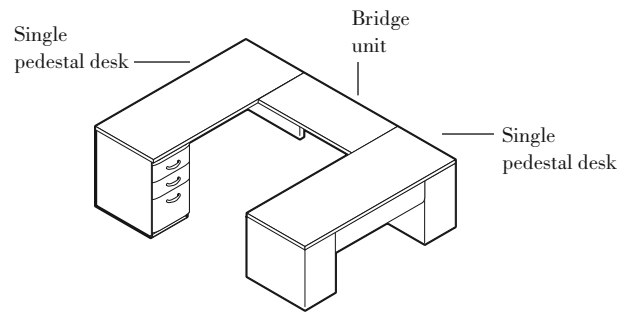

Freestanding Configuration



Preconfigured Desks

Returns and Bridge Units

18" and 24" Deep

| description | w* | w | d | h | pattern no. | P1 | P2 | P3 |
|--|-----|------------------------------------|----------------------------------|----------------------------------|----------------------|--------|--------|--------|
|  End Panel Return | 36" | 35 ¹³ / ₁₆ " | 17 ¹ / ₂ " | 28 ¹ / ₂ " | DD1E 3618N | \$772. | \$830. | \$853. |
| | 36" | 35 ¹³ / ₁₆ " | 23 ¹ / ₂ " | 28 ¹ / ₂ " | DD1E 3624N | 843. | 902. | 933. |
| | 42" | 41 ¹³ / ₁₆ " | 17 ¹ / ₂ " | 28 ¹ / ₂ " | DD1E 4218N | 812. | 869. | 899. |
| | 42" | 41 ¹³ / ₁₆ " | 23 ¹ / ₂ " | 28 ¹ / ₂ " | DD1E 4224N | 883. | 944. | 976. |
|  Pedestal Return | 36" | 35 ¹³ / ₁₆ " | 17 ¹ / ₂ " | 28 ¹ / ₂ " | DD1P (L)3618N | 997. | 1,077. | 1,116. |
| | 36" | 35 ¹³ / ₁₆ " | 23 ¹ / ₂ " | 28 ¹ / ₂ " | DD1P (L)3624N | 1,091. | 1,173. | 1,215. |
| | 42" | 41 ¹³ / ₁₆ " | 17 ¹ / ₂ " | 28 ¹ / ₂ " | DD1P (L)4218N | 1,041. | 1,119. | 1,156. |
| | 42" | 41 ¹³ / ₁₆ " | 23 ¹ / ₂ " | 28 ¹ / ₂ " | DD1P (L)4224N | 1,134. | 1,218. | 1,259. |
| | 48" | 47 ¹³ / ₁₆ " | 17 ¹ / ₂ " | 28 ¹ / ₂ " | DD1P (L)4818N | 1,080. | 1,156. | 1,198. |
| | 48" | 47 ¹³ / ₁₆ " | 23 ¹ / ₂ " | 28 ¹ / ₂ " | DD1P (L)4824N | 1,177. | 1,263. | 1,307. |
|  Bridge Unit | 30" | 29 ¹³ / ₁₆ " | 17 ¹ / ₂ " | 28 ¹ / ₂ " | DD1B 3018N | 376. | 394. | 400. |
| | 36" | 35 ¹³ / ₁₆ " | 17 ¹ / ₂ " | 28 ¹ / ₂ " | DD1B 3618N | 415. | 434. | 443. |
| | 36" | 35 ¹³ / ₁₆ " | 23 ¹ / ₂ " | 28 ¹ / ₂ " | DD1B 3624N | 445. | 463. | 471. |
| | 42" | 41 ¹³ / ₁₆ " | 17 ¹ / ₂ " | 28 ¹ / ₂ " | DD1B 4218N | 450. | 469. | 478. |
| | 42" | 41 ¹³ / ₁₆ " | 23 ¹ / ₂ " | 28 ¹ / ₂ " | DD1B 4224N | 488. | 506. | 515. |
| | 48" | 47 ¹³ / ₁₆ " | 17 ¹ / ₂ " | 28 ¹ / ₂ " | DD1B 4818N | 488. | 506. | 515. |
| | 48" | 47 ¹³ / ₁₆ " | 23 ¹ / ₂ " | 28 ¹ / ₂ " | DD1B 4824N | 531. | 551. | 561. |

w* = nominal width
 Dimensions listed under w d h are actual to the nearest 1/16"

| Ordering Information | Order Code | Included with: | Options |
|---|---|---|--|
| Pedestal Return 1. Pattern Number 2. Laminate Finish 3. Edge Band Finish 4. Paint Finish 5. Pull Finish 6. Drawer Top Cap Finish | Pedestal Return <i>Example:</i> DD1P L4824N, 117, 117, 117, 117, 117 DP1P Pattern Number L4824N 117 Soft Grey laminate 117 Soft Grey edge finish 117 Soft Grey paint finish 117 Soft Grey pull finish 117 Soft Grey top cap finish | Pedestal Return <ul style="list-style-type: none"> • Worksurface • Pedestal • Back panel • Half height flat bracket (1) • Connecting hardware End Panel Return or Bridge Unit <ul style="list-style-type: none"> • Worksurface • Back panel • Half height flat brackets (2) • Connecting hardware Note: An upcharge applies when specifying Legacy laminates. See Legacy finish page. | Pedestal Return <ul style="list-style-type: none"> • To specify center-mounted edge grommet, replace the "N" suffix from the pattern number with "G". Add \$19 • To specify pedestal without locks, replace the 5th digit "L" from the pattern number with "N". Deduct \$22 End Panel Return or Bridge Unit <ul style="list-style-type: none"> • To specify center-mounted edge grommet, replace the "N" suffix from the pattern number with "G". Add \$19 |
| End Panel Return or Bridge Unit 1. Pattern Number 2. Laminate Finish 3. Edge Band Finish 4. Paint Finish | End Panel Return or Bridge Unit <i>Example:</i> DD1B 4224N, 117, 117, 117 DD1B Pattern Number 4424 117 Soft Grey laminate 117 Soft Grey edge band 117 Soft Grey finish | | |

Desk Components

End Units

Planning Guidelines

Desk End Units

Dividends desk end units are an “L” shaped, non-handed design that can be used on either end of a worksurface in freestanding and panel applications. Desk end units have the same footprint (outside dimension) as pedestals and can be interchanged with pedestals.

End units are used in “Preconfigured” single pedestal desks and end panel returns.

They can also be specified by component for “Build-to-Spec” applications.

These include when an end panel is required on one end and a desk integration unit is required on the other, or when an end unit is required on both ends of the worksurface.

Available Sizes

Depths: 18", 24" and 30"

Width: 15"

Height: 26⁷/₈"

Desk End Unit Attachment

Desk end units have mounting brackets that allow attachment to worksurfaces with supplied screws. Dividends worksurfaces are pre-drilled for end unit attachment.

Construction

End unit specifications:

- Outer skin: 21-gauge steel
- Inner frame: 20-gauge steel
- Leveling glides: ³/₈" 16-gauge steel with 1¹/₂" of height adjustment
- Attachment bracket: 11-gauge steel

Desk Integration End Units

If a back panel (modesty) is required in a systems application, a desk integration end unit can be used in place of an end unit.

Panel-to-worksurface brackets are included and make the connection between the worksurface and Dividends Horizon panels. Desk integration end units are 15" wide.

Note: The desk integration end unit is a non-structural support. Panel-to-work surface brackets provide the actual support for the worksurface.

Note: Panel width must match the depth of the connecting worksurface.

Construction

Desk integration end unit specifications:

- Outer skin: 20-gauge steel
- Panel-to-worksurface brackets: 14-gauge steel

Intermediate End Units

Intermediate end units are freestanding “T” shaped end units used to support two desks in an in-line configuration.

Units attach to 18", 24" and 30" deep worksurfaces in place of desk end units. Mounting brackets and a front worksurface alignment plate are included with intermediate end units.

Available Size

- Depth: 14"
- Width: 30"
- Height: 26⁷/₈"

Construction

Intermediate end unit specifications:

- Outer skin: 20-gauge steel
- Inner frame: 20-gauge steel
- Mounting brackets: 11-gauge steel

Desk End Unit

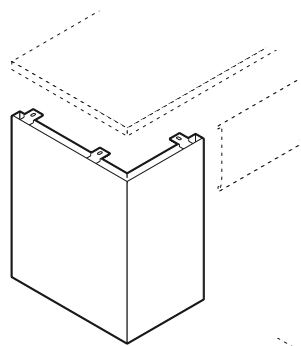

Intermediate End Unit

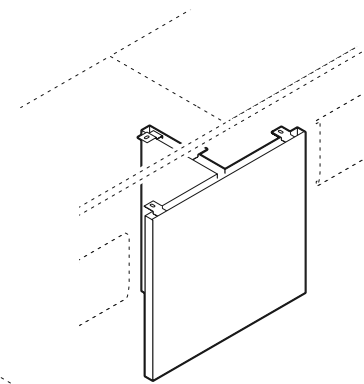

Desk Integration End Unit (Non-structural)

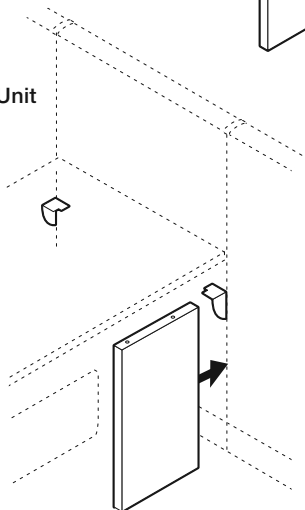

Desk End Unit Available Sizes

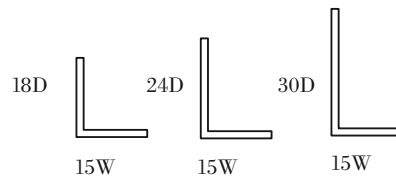

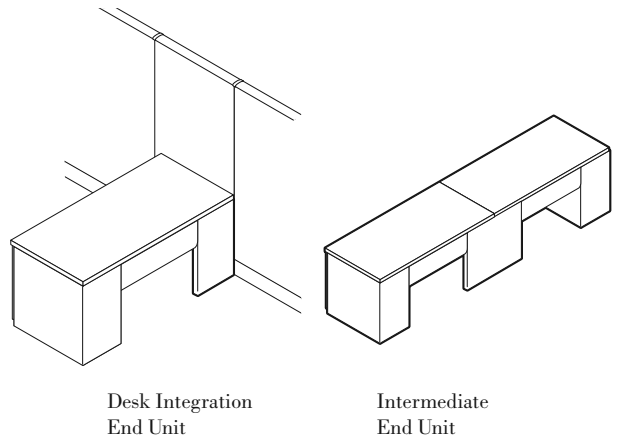

End Unit Configurations



End Units

Desk End, Desk Integration and Intermediate

| description | d* | d | w | h | pattern no. | P1 | P2 | P3 |
|--|---------------------------------|----------------------------------|-----------------------------------|----------------------------------|-----------------|--------|--------|--------|
|  Desk End Unit | 18" | 16 ³ / ₈ " | 14 ⁷ / ₈ " | 26 ⁷ / ₈ " | DD1 EU18 | \$369. | \$406. | \$426. |
| | 24" | 22 ³ / ₈ " | 14 ⁷ / ₈ " | 26 ⁷ / ₈ " | DD1 EU24 | 407. | 448. | 468. |
| | 30" | 28 ³ / ₈ " | 14 ⁷ / ₈ " | 26 ⁷ / ₈ " | DD1 EU30 | 444. | 487. | 510. |
|  Desk Integration End Unit (Non-structural) | 1 ¹ / ₂ " | 1 ¹ / ₂ " | 14 ⁷ / ₈ " | 26 ⁷ / ₈ " | DD1 DIEU | 206. | 223. | 233. |
|  Intermediate End Unit | 14" | 12" | 31 ⁹ / ₁₆ " | 26 ⁷ / ₈ " | DD1 IE30 | 369. | 406. | 426. |

d* = nominal depth

Dimensions listed under d w h are actual to the nearest 1/16"

| Ordering Information | Order Code | Included with: | Options |
|--|---|---|--|
| Desk End Unit 1. Pattern Number 2. Paint Finish | Desk End Unit <i>Example:</i> DD1 EU18, 117 DD1 EU18 Pattern Number 117 Soft Grey Paint Finish | Desk End Unit Desk Integration End Unit • Panel-to-Worksurface Brackets (2) Intermediate End Unit | Desk End Unit Desk Integration End Unit Intermediate End Unit |
| Desk Integration End Unit 1. Pattern Number 2. Paint Finish | Desk Integration End Unit <i>Example:</i> DD1 DIEU, 117 DD1 DIEU Pattern Number 117 Soft Grey Paint Finish | | |
| Intermediate End Unit 1. Pattern Number 2. Paint Finish | Intermediate End Unit <i>Example:</i> DD1 IE30, 117 DD1 IE30 Pattern Number 117 Soft Grey Paint Finish | | |

Desk Components

Half Height Back Panels

Planning Guidelines

Half Height Back Panels

Dividends back panels extend between pedestals, end units or desk integration end units in freestanding desks. They also extend between end units in returns and along the rear surface of bridge units. Back panels are softly-radiused to match the aesthetics of the Dividends Horizon system and extend 11" down from the worksurface to provide a half-height modesty.

Back panels are used in "Preconfigured" desks or can be specified separately by component for "Build-to-Spec" applications.

Available Sizes

- Widths: 19⁵/₈" to 48¹/₄" see compatibility chart (below)
- Height: 11"

Back Panel Attachment

Back panels attach to the undersides of worksurfaces with mounting brackets and do not require attachment to adjacent pedestals or end units. Dividends Horizon worksurfaces are pre-drilled for back panel attachment.

Construction

- Back panel specifications:
- Outer skin: 22-gauge steel
 - Mounting Brace: 16-gauge

Back Panel Compatibility

The chart below shows which back panels are specified for various configurations.

Optional Grommets/Wire Management

When installed, back panels provide a 1/2" reveal between the back panel and worksurface for wire management. Optional edge grommets are required to provide access.

Desk Configurations

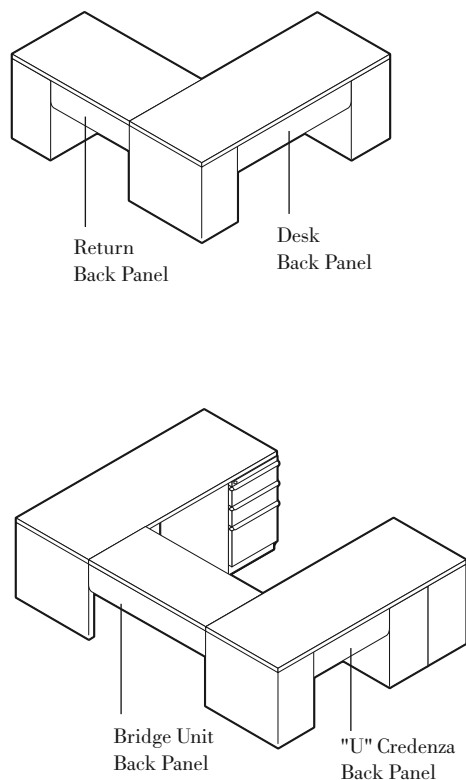

Back Panel Compatibility

| Product | Work-surface Width | Back Panel Width | Back Panel Pattern No. | No. of Required Peds/End Units |
|--|--------------------|------------------|------------------------|--------------------------------|
| Desks | 54 | 23 7/8" | DD1 BPD54 | 2 |
| | 60 | 29 7/8" | DD1 BPD60 | 2 |
| | 66 | 35 7/8" | DD1 BPD66 | 2 |
| | 72 | 41 7/8" | DD1 BPD72 | 2 |
| Returns | 36 | 21 5/8" | DD1 BPR36 | 1 |
| | 42 | 27 5/8" | DD1 BPR42 | 1 |
| | 48 | 33 5/8" | DD1 BPR48 | 1 |
| | 60 | 45 5/8" | DD1 BPR60 | 1 |
| Bridge Units | 30 | 31 3/8" | DD1 BPB30 | 0 |
| | 36 | 37 3/8" | DD1 BPB36 | 0 |
| | 42 | 43 3/8" | DD1 BPB42 | 0 |
| | 48 | 49 3/8" | DD1 BPB48 | 0 |
| "U" Credenza w/2 peds | 72 | 26 15/16" | DD1 BPU72 | 3 |
| Freestanding Corner Unit (needs two back panels) | 36 | 20 15/16" | DD1 BPV36 | 3 |
| | 42 | 26 15/16" | DD1 BPV42 | 3 |
| | 48 | 32 15/16" | DD1 BPV48 | 3 |





Note: Specify "desk" back panels from category (above) for use with desk integration end units and intermediate end units.

Desk Components

Half Height Back Panels

For Desks, Returns, Bridges and 2 Pedestal Configuration

Dividends Horizon

| description | top width | w * | h | pattern no. | P1 | P2 | P3 |
|--|-----------|------------------------------------|-----|------------------|--------|--------|--------|
|  Half Height Back panels for Desks | 54" | 29 ⁷ / ₈ " | 11" | DD1 BPD54 | \$207. | \$224. | \$235. |
| | 60" | 29 ⁷ / ₈ " | 11" | DD1 BPD60 | 216. | 238. | 248. |
| | 66" | 35 ⁷ / ₈ " | 11" | DD1 BPD66 | 227. | 251. | 260. |
| | 72" | 41 ⁷ / ₈ " | 11" | DD1 BPD72 | 240. | 261. | 277. |
|  Half Height Back panels for Returns | 36" | 21 ⁵ / ₈ " | 11" | DD1 BPR36 | 183. | 202. | 211. |
| | 42" | 27 ⁵ / ₈ " | 11" | DD1 BPR42 | 190. | 211. | 220. |
| | 48" | 33 ³ / ₈ " | 11" | DD1 BPR48 | 206. | 223. | 233. |
| | 60" | 45 ³ / ₈ " | 11" | DD1 BPR60 | 227. | 251. | 260. |
|  Half Height Back panels for Bridges | 30" | 31 ³ / ₈ " | 11" | DD1 BPB30 | 162. | 178. | 187. |
| | 36" | 37 ³ / ₈ " | 11" | DD1 BPB36 | 175. | 190. | 199. |
| | 42" | 43 ³ / ₈ " | 11" | DD1 BPB42 | 183. | 202. | 211. |
| | 48" | 49 ³ / ₈ " | 11" | DD1 BPB48 | 193. | 214. | 223. |
|  Half Height Back panels for 2 Pedestal "U" Credenza | 72" | 26 ¹⁵ / ₁₆ " | 11" | DD1 BPU72 | 183. | 202. | 211. |

Dimensions listed under w h are actual to the nearest¹/₁₆"

| Ordering Information | Order Code | Included with: | Options |
|--|--|---|--------------------------------|
| Back Panels for Bridges 1. Pattern Number 2. Paint Finish | Back Panels for Bridges <i>Example:</i> DD1 BPB36 , 117 <hr/> DD1 Pattern Number BPB36 <hr/> 117 Soft Grey Paint Finish | Back Panels for Bridges • Attachment Hardware | Back Panels for Bridges |

Desk Components

Full Back Panels

Planning Guidelines

Full Back Panels

Dividends full back panels extend between pedestals, end units or desk integration end units in freestanding desks. They also extend between end units in returns and along the rear surface of bridge units.

Full back panels are specified separately by component for "Build-to-Spec" applications.

Available Sizes

- Widths: 19⁵/₈" to 48¹/₄" see compatibility chart (above)
- Height: 26⁵/₈"

Full Back Panel Attachment

Back panels attach to the undersides of pedestals or end units with mounting brackets.

Construction

Back panel specifications:

- Outer skin: 20-gauge steel
- Mounting Brace: 16-gauge

Back Panel Compatibility

The chart below shows which back panels are specified for various configurations.

Optional Grommets/Wire Management

When installed, back panels provide a 1/2" reveal between the back panel and worksurface for wire management. Optional edge grommets are required to provide access.

Desk Configurations

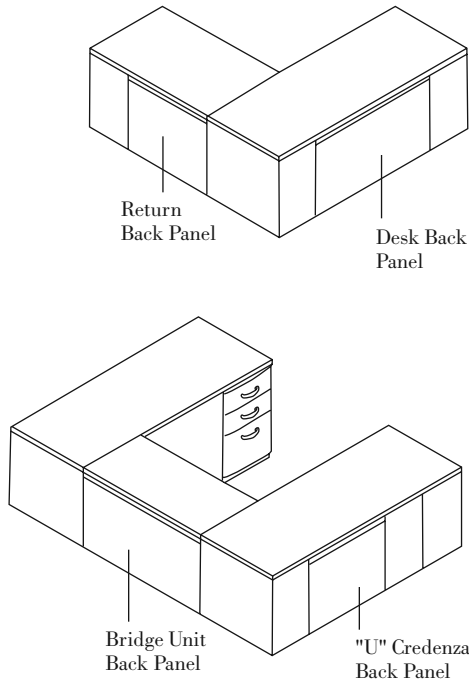





Back Panel Compatibility

| Product | Work-surface Width | Back Panel Width | Back Panel Pattern No. | No. of Required Peds/End Units |
|--|--------------------|------------------------------------|------------------------|--------------------------------|
| Desks | 54 | 23 ⁷ / ₈ " | DD1 FFBDP54 | 2 |
| | 60 | 29 ⁷ / ₈ " | DD1 FFBDP60 | 2 |
| | 66 | 35 ⁷ / ₈ " | DD1 FBPD66 | 2 |
| | 72 | 41 ⁷ / ₈ " | DD1 FBPD72 | 2 |
| Returns | 36 | 21 ⁵ / ₈ " | DD1 FBPR36 | 1 |
| | 42 | 27 ⁵ / ₈ " | DD1 FBPR42 | 1 |
| | 48 | 33 ⁵ / ₈ " | DD1 FBPR48 | 1 |
| | 60 | 45 ⁵ / ₈ " | DD1 FBPR60 | 1 |
| Bridge Units | 30 | 31 ⁵ / ₈ " | DD1 FBPB30 | 0 |
| | 36 | 37 ⁵ / ₈ " | DD1 FBPB36 | 0 |
| | 42 | 43 ⁵ / ₈ " | DD1 FBPB42 | 0 |
| | 48 | 49 ⁵ / ₈ " | DD1 FBPB48 | 0 |
| "U" Credenza w/2 peds | 72 | 26 ¹⁵ / ₁₆ " | DD1 FBPU72 | 3 |
| Freestanding Corner Unit (needs two back panels) | 36 | 20 ¹⁵ / ₁₆ " | DD1 FBPV36 | 3 |
| | 42 | 26 ¹⁵ / ₁₆ " | DD1 FBPV42 | 3 |
| | 48 | 32 ¹⁵ / ₁₆ " | DD1 FBPV48 | 3 |

Note: Specify "desk" back panels from category (above) for use with desk integration end units and intermediate end units.

Full Back Panels

For Desks, Returns, Bridges and 2 Pedestal Configuration

| description | top width | w * | h | pattern no. | P1 | P2 | P3 |
|---|-----------|------------------------------------|----------------------------------|-------------------|--------|--------|--------|
| Full Back panels for Desks  | 54" | 23 ⁷ / ₈ " | 26 ⁵ / ₈ " | DD1 FBPD54 | \$244. | \$268. | \$281. |
| | 60" | 29 ⁷ / ₈ " | 26 ⁵ / ₈ " | DD1 FBPD60 | 249. | 274. | 287. |
| | 66" | 35 ⁷ / ₈ " | 26 ⁵ / ₈ " | DD1 FBPD66 | 256. | 282. | 291. |
| | 72" | 41 ⁷ / ₈ " | 26 ⁵ / ₈ " | DD1 FBPD72 | 263. | 289. | 303. |
| Full Back panels for Returns  | 36" | 21 ⁵ / ₈ " | 26 ⁵ / ₈ " | DD1 FBPR36 | 229. | 252. | 263. |
| | 42" | 27 ⁵ / ₈ " | 26 ⁵ / ₈ " | DD1 FBPR42 | 235. | 258. | 269. |
| | 48" | 33 ⁵ / ₈ " | 26 ⁵ / ₈ " | DD1 FBPR48 | 245. | 269. | 282. |
| | 60" | 45 ⁵ / ₈ " | 26 ⁵ / ₈ " | DD1 FBPR60 | 268. | 292. | 310. |
| Full Back panels for Bridges  | 30" | 31 ³ / ₈ " | 26 ⁵ / ₈ " | DD1 FBPB30 | 215. | 236. | 246. |
| | 36" | 37 ³ / ₈ " | 26 ⁵ / ₈ " | DD1 FBPB36 | 225. | 249. | 259. |
| | 42" | 43 ³ / ₈ " | 26 ⁵ / ₈ " | DD1 FBPB42 | 245. | 269. | 282. |
| | 48" | 49 ³ / ₈ " | 26 ⁵ / ₈ " | DD1 FBPB48 | 252. | 278. | 289. |
| Full Back panels for 2 Pedestal "U" Credenza  | 72" | 26 ¹⁵ / ₁₆ " | 26 ⁵ / ₈ " | DD1 FBPU72 | 235. | 258. | 269. |

Dimensions listed under w h are actual to the nearest¹/₁₆"

| Ordering Information | Order Code | Included with: | Options |
|--|--|---|--------------------------------|
| Back Panels for Bridges 1. Pattern Number 2. Paint Finish | Back Panels for Bridges <i>Example:</i> DD1 FBPB36 , 117 <hr/> DD1 Pattern Number FBPB36 <hr/> 117 Soft Grey Paint Finish | Back Panels for Bridges • Attachment Hardware | Back Panels for Bridges |

Pencil Tray

Five section tray rides on drawer sides of box drawers. Plastic injection molded construction. 13¹/₄ wide, 5⁷/₁₆ deep and ⁷/₈ high. Black or clear finish available.

Hanging File Bar

Allows for side-to-side hanging folders. 20-gauge steel construction. Set of two. Black finish.

Note: A hanging file bar is included with each file drawer when ordering desks or pedestals.

Drawer Dividers

Two styles available: box drawer and file drawer sizes. 18-gauge steel construction. Black finish.

Stationery Inserts

Set of four trays for use in box drawers. 18-gauge steel construction. Can accommodate letter- and legal-sized stationery. Black finish.

Pencil Drawer

For use with freestanding desks or panel-mounted worksurfaces with depths of 24 or more. 24 wide, 17 ⁵/₈ deep and 2 high. Black finish.

Attachment: Mounts on underside of worksurface with included mounting hardware

Pedestal Lock Retrofit Kit

Allows existing nonlocking pedestals to be field-retrofitted with locks. Includes lock housing, lock core (keyed randomly unless specified keyed alike) and lock rod assembly (must be specified box/box/file or file/file).

Flat Brackets

Allow same-height worksurfaces to be joined in perpendicular configurations. All flat brackets are 3 ³/₄ wide. Black finish.

Three sizes available to support the following worksurface depths:

- 18 deep worksurfaces
- 24 deep worksurfaces
- 30 deep worksurfaces
- Construction: 14-gauge steel
- Attachment: Mounts on underside of worksurfaces in pre-drilled locations with included mounting hardware

Worksurface Cable Management Clips

Self-adhesive, injection-molded clips adhere to any flat, nonporous surface to route cables along and beneath worksurfaces. ³/₄ x ¹/₂ internal dimension.

Worksurface Cable Management Basket

Steel wire basket attaches to the underside of worksurfaces to provide management of excess cords and cables. Once installed, the cable basket slides forward to a position abutting the panel face to allow the passage of cords and cables. Black finish.

Worksurface Edge Grommet

Available factory-installed when ordering worksurfaces or as a kit for field installation. Can be installed in any location along the rear edge of worksurfaces. Includes a cutting template, grommet and cover. Dark grey finish.

Worksurface Reinforcement

Worksurface reinforcements are required for worksurface spans greater than 48 inches. This includes freestanding desk worksurfaces over 48 inches using desk end units. Worksurface reinforcements have a black paint finish.

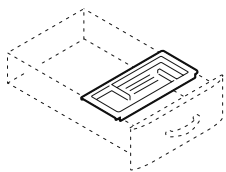

Pencil Tray

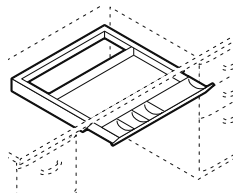

Pencil Drawer

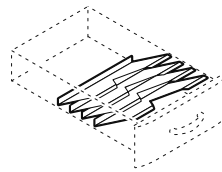

Stationery Inserts

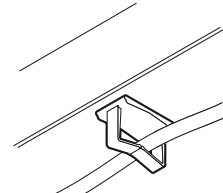

Worksurface Cable Management Clip

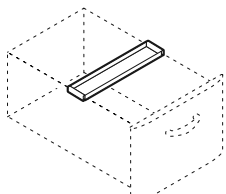

Hanging File Bar

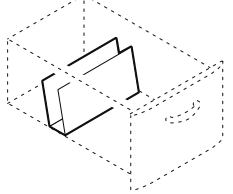

Drawer Divider, File Drawer

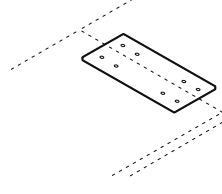

Flat Bracket

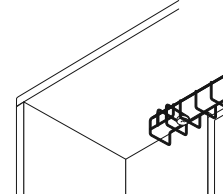

Worksurface Cable Management Basket

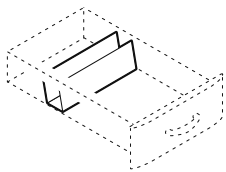

Drawer Divider, Box Drawer

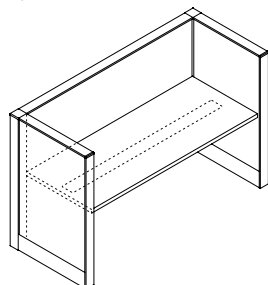



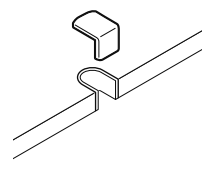





Worksurface Reinforcement Panel Hung Application

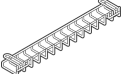

Worksurface Edge Grommet

Drawer Organizers, Cable Management and Grommet Kits

| description | type | w | d | h | pattern no. | list |
|---|---------------|----------|----------|--------|----------------|-------|
|  Pencil Tray | Black finish | 13 1/4" | 5 7/8" | 7/8" | DS2PPTN | \$40. |
| | Clear finish | 13 1/4" | 5 7/8" | 7/8" | DS2PPTC | 47. |
|  Hanging File Bar | | 12 3/16" | 2 15/16" | 1/2" | DS1PFS | 34. |
|  Drawer Divider, Box | | 12 3/8" | 3" | 3 1/8" | DS1PBD | 34. |
|  Drawer Divider, File | | 10 | 3 5/8" | 6 3/8" | DS1PFD | 34. |
|  Stationary Inserts, box (4 trays) | | 13 | 15 1/16" | 8 7/8" | DS1PST | 182. |
|  Pencil Drawer | | 24" | 17 5/8" | 2" | DS1PCD | 248. |
|  Worksurface Cable Management Clip | Package of 10 | 3/4" | 1/2" | | D1WC | 41. |
|  Worksurface Cable Management Basket | 19 1/2" wide | 16 1/2" | 3 1/2" | 1 1/2" | D1WB20 | 43. |
| | 25 1/2" wide | 25 1/2" | 3 1/2" | 1 1/2" | D1WB26 | 45. |
| | 31 1/2" wide | 31 1/2" | 3 1/2" | 1 1/2" | D1WB32 | 57. |
| | 35" wide | 35" | 3 1/2" | 1 1/2" | D1WB36 | 62. |
| | 41" wide | 41" | 3 1/2" | 1 1/2" | D1WB42 | 66. |
|  Worksurface Grommet Kit (Dark Grey) | | 2 3/16" | 2 5/16" | 1 3/8" | D1WSG | 25. |

Freestanding Desks

Ordering Information

Pencil Tray
1. Pattern Number

Order Code

Pencil Tray
Example: **DS1 PPT**
DS1 PPT Pattern Number

Included with:



Pencil Tray

Options

Desk Accessories

Flat Brackets and Worksurface Reinforcements

Dividends Horizon

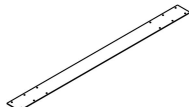
| description | w | d | pattern no. | list |
|---|--------|-----------|-----------------|-------|
| Flat Bracket (single pack)  | 3 3/4" | 8 5/16" | DB1F18SP | \$16. |
| | 3 3/4" | 14 5/8" | DB1F24SP | 28. |
| | 3 3/4" | 20 15/16" | DB1F30SP | 32. |
| Flat Bracket (package of 10)  | 3 3/4" | 8 5/16" | DB1F18TP | 137. |
| | 3 3/4" | 14 5/8" | DB1F24TP | 237. |
| | 3 3/4" | 20 3/16" | DB1F30TP | 261. |
| Worksurface Reinforcement  | 54" | 4" | DB1WR54 | 66. |
| | 60" | 4" | DB1WR60 | 67. |
| | 66" | 4" | DB1WR66 | 70. |
| | 72" | 4" | DB1WR72 | 72. |

Ordering Information

Flat Bracket
1. Pattern Number

Order Code

Flat Bracket
Example: **DB1PWSP**
DB1PWSP Pattern Number

Included with:

Flat Bracket

Options

Flat Bracket

Wall Mounting Suggestions

The following information is provided only as a guide, and represents minimum recommendations only. Knoll does not accept responsibility for the attachment of any Knoll product to a Customer's site wall. Wall specification/construction is the responsibility of the Customer and its structural engineer/architect. Failure to properly attach Knoll products to adequate wall structures can lead to property damage and/or personal injury.

You should consult your own structural engineers and/or architects and must not rely on the information provided herein.

It is the responsibility of the Customer and its structural engineers/architects to verify that the permanent structural walls (studs, blocks, solid masonry, etc.) on which the Knoll products are intended to be mounted are designed appropriately to support the product weight, PLUS 3 lbs. per linear inch for each useable shelf length

NOTE: A cabinet's top is considered a "useable shelf" and MUST be included in the calculation of the total load for an overhead cabinet.

It is the responsibility of the Customer and its structural engineer/architects to specify the fasteners and method for attaching the Knoll supplied wall mounting cleat, bracket, frame, etc. to the supporting wall and to confirm that the installers have adhered to these specifications. For all local building standards and codes, and additional requirements (including, but not limited to, seismic conditions) the Customer should always consult local code agencies.

| | EXISTING CONSTRUCTION | | | | | |
|--|---|--|---|---|--|--|
| | NEW CONSTRUCTION | Cinder Block or Poured Concrete Masonry Wall | Wood Stud Wall, the studs being FULL HEIGHT to the roof/floor above | Wood Stud Wall, the studs being only Ceiling Height | Steel Stud Wall, the studs being FULL HEIGHT to the roof/floor above | Steel Stud Wall, the studs being only Ceiling Height |
| Stud Specification | Wood studs, grade #2 or better, 3 1/2" minimum width, OR Metal studs, minimum 25 gage thickness, 3 5/8" minimum width | The wall must be a minimum of 6" thick, and must be full height to the roof/ floor structure above | Wood studs must be Grade #2, or better, 3 1/2" minimum width | Wood studs must be Grade #2, or better, 3 1/2" minimum width | Metal studs must be minimum 25 gage thickness, 3 5/8" minimum width | Metal studs must be minimum 25 gage thickness, 3 5/8" minimum width |
| Stud Centers | Metal and wood studs must be spaced at 16" c/c maximum | N/A | Wood studs must be spaced at 16" c/c maximum | Wood studs must be spaced at 16" c/c maximum" | Metal studs must be spaced at 16" c/c maximum | Metal studs must be spaced at 16" c/c maximum |
| Stud Height | Metal and wood studs must extend upwards, and be securely attached to the roof/ floor structure above | | | Wood studs must be braced above the ceiling, and be securely attached to the roof/floor structure above Affix #2 grade 'cap' across the top of the studs, then place diagonal studs from the top cap up to underside of the roof/ floor structure above | | Metal studs must be braced above the ceiling, and be securely attached to the roof/floor structure above Affix metal bracing 'cap' across the top of the studs, then place diagonal studs from the top cap up to underside of the roof / floor structure above |
| Mounting the Knoll Supplied Cleat, Bracket, Frame, etc* | Insert a 2" X 6" wood block, #2 grade or better, [or a Danback™ flexible wood backing system] horizontally between each of the studs to accommodate the full width of the cabinet, and beyond to the next stud. Fasten the wood block to each stud using three screws at the ends of each block. (Fasten the Danback™ as directed by the manufacturer) Fasten the Knoll supplied wall mounting cleat, bracket, frame, etc directly to each wood block every 6" For wall mounting structures that have a rectangular frame-like configuration: fasten the top horizontal element of the frame to the wood blocking every 6", and fasten the lower horizontal element to each wall stud, using one fastener per stud. | Fasten the Knoll supplied cabinet wall mounting cleat, bracket, frame, etc. directly to the masonry wall every 6" For wall mounting structures that have a rectangular frame-like configuration: fasten the top horizontal element of the frame to the wall every 6", and fasten the lower horizontal element to the wall every 16" | In the desired location of the cabinet mounting rail, remove an 8" high section of drywall the width of the cabinet, and beyond to the next stud. Insert a 2" X 6" wood block, #2 grade or better, horizontally between each of the exposed studs. Fasten the wood block to each stud using three screws at the ends of each block. Replace the drywall and repair as desired. Fasten the Knoll supplied wall mounting cleat, rail, frame, etc directly to the wood block every 6" For wall mounting structures that have a rectangular frame-like configuration: fasten the top horizontal element of the frame to the wood blocking every 6", and fasten the lower horizontal element to each wall stud, using one fastener per stud. | In the desired location of the cabinet mounting rail, remove an 8" high section of drywall the width of the cabinet, and beyond to the next stud. Insert a 2" X 6" wood block, #2 grade or better, horizontally between each of the exposed studs. Fasten the wood block to each stud using three screws at the ends of each block. Replace the drywall and repair as desired. Fasten the Knoll supplied wall mounting cleat, rail, frame, etc directly to the wood block every 6" For wall mounting structures that have a rectangular frame-like configuration: fasten the top horizontal element of the frame to the wood blocking every 6", and fasten the lower horizontal element to each wall stud, using one fastener per stud. | In the desired location of the cabinet mounting rail, remove an 8" high section of drywall the width of the cabinet, and beyond to the next stud. Insert a 2" X 6" wood block, #2 grade or better, [or a Danback™ flexible wood backing system] horizontally between each of the exposed studs. Fasten the wood block to each stud using three screws at the ends of each block. Replace the drywall and repair as desired. Fasten the Knoll supplied wall mounting cleat, rail, frame, etc directly to the wood block every 6" For wall mounting structures that have a rectangular frame-like configuration: fasten the top horizontal element of the frame to the wood blocking every 6", and fasten the lower horizontal element to each wall stud, using one fastener per stud. | In the desired location of the cabinet mounting rail, remove an 8" high section of drywall the width of the cabinet, and beyond to the next stud. Insert a 2" X 6" wood block, #2 grade or better, [or a Danback™ flexible wood backing system] horizontally between each of the exposed studs. Fasten the wood block to each stud using three screws at the ends of each block. Replace the drywall and repair as desired. Fasten the Knoll supplied wall mounting cleat, rail, frame, etc directly to the wood block every 6" For wall mounting structures that have a rectangular frame-like configuration: fasten the top horizontal element of the frame to the wood blocking every 6", and fasten the lower horizontal element to each wall stud, using one fastener per stud. |
| *Graham Wall Hung Shelf | The Graham Wall Hung Shelf Bracket (and others like it) requires full support behind the full height of the bracket This should be accomplished by insertion of additional 2"X 6" wood blocking between the studs as defined above | Fasten the Knoll supplied wall mounting brackets directly to the masonry wall, using the holes provided in each bracket | The Graham Wall Hung Shelf Bracket (and others like it) requires full support behind the full height of the bracket This should be accomplished by insertion of additional 2"X 6" wood blocking between the studs as defined above | The Graham Wall Hung Shelf Bracket (and others like it) requires full support behind the full height of the bracket This should be accomplished by insertion of additional 2"X 6" wood blocking between the studs as defined above | The Graham Wall Hung Shelf Bracket (and others like it) requires full support behind the full height of the bracket This should be accomplished by insertion of additional 2"X 6" wood blocking between the studs as defined above | The Graham Wall Hung Shelf Bracket (and others like it) requires full support behind the full height of the bracket This should be accomplished by insertion of additional 2"X 6" wood blocking between the studs as defined above |
| Fasten the Knoll supplied wall cleat with... | #10 x 2 1/2" Grabber Woodys Screws or equiv. @ 6" c/c, screwed directly into the wood blocking | 3/16" x 3 1/2" Tapcon Masonry Screws or equiv. @ 6" c/c with 1-1/4" embedment, screwed directly into the masonry wall | #10 x 2 1/2" Grabber Woodys Screws or equiv. @ 6" c/c, screwed directly into the wood blocking | #10 x 2 1/2" Grabber Woodys Screws or equiv. @ 6" c/c, screwed directly into the wood blocking | #10 x 2 1/2" Grabber Woodys Screws or equiv. @ 6" c/c, screwed directly into the wood blocking | #10 x 2 1/2" Grabber Woodys Screws or equiv. @ 6" c/c, screwed directly into the wood blocking |

Alpha-Numeric Index

| <i>pattern no.</i> | <i>page</i> | <i>pattern no.</i> | <i>page</i> | <i>pattern no.</i> | <i>page</i> | <i>pattern no.</i> | <i>page</i> |
|--------------------|-------------|--------------------|-------------|--------------------|-------------|--------------------|-------------|
| D19 6630N | 311 | D1L 6642SSN | 307 | DIR 8418N | 295 | D1W S723018N | 302 |
| D19 7230N | 311 | D1L 6648DSN | 309 | DIR 8424N | 295 | D1W S723024N | 302 |
| D19 7830N | 311 | D1L 6648SDN | 309 | DIR 8430N | 299 | D1W S781824N | 302 |
| D1BD6648DL | 311 | D1L 6648SSN | 307 | DIR 8436N | 299 | D1W S781830N | 302 |
| D1BD6648DR | 311 | D1L 7242SSN | 307 | DIR 9015 | 315 | D1W S782418N | 302 |
| D1BD6648SL | 311 | D1L 7248DSN | 309 | DIR 9018N | 295 | D1W S782430N | 302 |
| D1BD6648SR | 311 | D1L 7248SDN | 309 | DIR 9024N | 295 | D1W S783018N | 302 |
| D1BD7248DL | 311 | D1L 7248SSN | 307 | DIR 9030N | 299 | D1W S783024N | 302 |
| D1BD7248DR | 311 | D1L 7842SSN | 307 | DIR 9036N | 299 | D1W S841824N | 302 |
| D1BD7248SL | 311 | D1L 7848SSN | 307 | DIR 9615 | 315 | D1W S841830N | 302 |
| D1BD7248SR | 311 | D1L 8448SSN | 307 | DIR 9618N | 295 | D1W S842418N | 302 |
| D1C 3618N | 305 | D1P 6630N | 311 | DIR 9624N | 295 | D1W S842430N | 302 |
| D1C 3624N | 305 | D1P 7230N | 311 | DIR 9630N | 299 | D1W S843018N | 302 |
| D1C 422430N | 305 | D1P 7830N | 311 | DIR 9636N | 299 | D1W S843024N | 302 |
| D1C 4224N | 305 | DIR 1515C | 315 | DIR2419N | 297 | D1W T482430N | 303 |
| D1C 423024N | 305 | DIR 1515S | 315 | DIR3019N | 297 | D1W T483024N | 303 |
| D1C 482430N | 305 | DIR 2415 | 315 | DIR3619N | 297 | D1W T602430N | 303 |
| D1C 4824N | 305 | DIR 2418N | 295 | DIR4219N | 297 | D1W T603024N | 303 |
| D1C 483024N | 305 | DIR 2424N | 295 | DIR4819N | 297 | D1W T662430N | 303 |
| D1C 4830N | 305 | DIR 2430N | 299 | DIR5419N | 297 | D1W T663024N | 303 |
| D1CRL24 | 313 | DIR 3015 | 315 | DIR6019N | 297 | D1W T722430N | 303 |
| D1CRN24 | 313 | DIR 3018N | 295 | DIR6619N | 297 | D1W T723024N | 303 |
| D1CRR24 | 313 | DIR 3024N | 295 | DIR7219N | 297 | D1WB20 | 207, 373 |
| D1CS 4224N | 305 | DIR 3030N | 299 | DIR7819N | 297 | D1WB26 | 207, 373 |
| D1CS 4824N | 305 | DIR 3615 | 315 | DIR8419N | 297 | D1WB32 | 207, 373 |
| D1CS 4830N | 305 | DIR 3618N | 295 | DIR9019N | 297 | D1WB36 | 207, 373 |
| D1D 4824N | 311 | DIR 3624N | 295 | DIR9619N | 297 | D1WB42 | 207, 373 |
| D1D 4830N | 311 | DIR 3630N | 299 | D1W 362430N | 301 | D1WC | 207, 373 |
| D1D 6030N | 311 | DIR 4215 | 315 | D1W 363024N | 301 | D1WSC | 243, 373 |
| D1D 6630N | 311 | DIR 4218N | 295 | D1W 422430N | 301 | D1WT218 | 177 |
| D1D 7230N | 311 | DIR 4224N | 295 | D1W 423024N | 301 | D1WT224 | 177 |
| D1D 7236N | 311 | DIR 4230N | 299 | D1W 482430N | 301 | D1WT324 | 177 |
| D1H4818 | 313 | DIR 4815 | 315 | D1W 483024N | 301 | D1WT424 | 177 |
| D1H5118P | 313 | DIR 4818N | 295 | D1W 721830N | 301 | D1WT518 | 177 |
| D1H6024 | 313 | DIR 4824N | 295 | D1W 722430N | 301 | D1WT524 | 177 |
| D1H6324P | 313 | DIR 4830N | 299 | D1W 722436N | 301 | D1WW11481824 | 177 |
| D1L 3636SSN | 307 | DIR 5415 | 315 | D1W 723018N | 301 | D1WW11482418 | 177 |
| D1L 4242SSN | 307 | DIR 5418N | 295 | D1W 723024N | 301 | D1WW12481824 | 177 |
| D1L 4260SSN | 307 | DIR 5424N | 295 | D1W 723624N | 301 | D1WW12482418 | 177 |
| D1L 4266SSN | 307 | DIR 5430N | 299 | D1W S481824N | 302 | D1WW124824L | 177 |
| D1L 4272SSN | 307 | DIR 6015 | 315 | D1W S481830N | 302 | D1WW124824R | 177 |
| D1L 4278SSN | 307 | DIR 6018N | 295 | D1W S482418N | 302 | D1WW13481824 | 177 |
| D1L 4848DDN | 309 | DIR 6024N | 295 | D1W S482430N | 302 | D1WW13482418 | 177 |
| D1L 4848DSN | 309 | DIR 6030N | 299 | D1W S483018N | 302 | D1WW134824L | 177 |
| D1L 4848SDN | 309 | DIR 6036N | 299 | D1W S483024N | 302 | D1WW134824R | 177 |
| D1L 4848SSN | 307 | DIR 6615 | 315 | D1W S601824N | 302 | D1WW34824 | 177 |
| D1L 4860DSN | 309 | DIR 6618N | 295 | D1W S601830N | 302 | D1WW44824 | 177 |
| D1L 4860SDN | 309 | DIR 6624N | 295 | D1W S602418N | 302 | D1WW54824L | 177 |
| D1L 4860SSN | 307 | DIR 6630N | 299 | D1W S602430N | 302 | D1WW54824R | 177 |
| D1L 4866DSN | 309 | DIR 6636N | 299 | D1W S603018N | 302 | D1WW64824L | 177 |
| D1L 4866SDN | 309 | DIR 7215 | 315 | D1W S603024N | 302 | D1WW64824R | 177 |
| D1L 4866SSN | 307 | DIR 7218N | 295 | D1W S661824N | 302 | D1WW74824L | 177 |
| D1L 4872DSN | 309 | DIR 7224N | 295 | D1W S661830N | 302 | D1WW74824R | 177 |
| D1L 4872SDN | 309 | DIR 7230N | 299 | D1W S662418N | 302 | D2H4824 | 313 |
| D1L 4872SSN | 307 | DIR 7236N | 299 | D1W S662430N | 302 | D2H4836 | 313 |
| D1L 4878SSN | 307 | DIR 7815 | 315 | D1W S663018N | 302 | D2H4848 | 313 |
| D1L 4884SSN | 307 | DIR 7818N | 295 | D1W S663024N | 302 | D2H5124P | 313 |
| D1L 6042SSN | 307 | DIR 7824N | 295 | D1W S721824N | 302 | D2H5136P | 313 |
| D1L 6048DSN | 309 | DIR 7830N | 299 | D1W S721830N | 302 | D2H5148P | 313 |
| D1L 6048SDN | 309 | DIR 7836N | 299 | D1W S722418N | 302 | D2P1 | 81 |
| D1L 6048SSN | 307 | DIR 8415 | 315 | D1W S722430N | 302 | DB120C (L or R) | 323 |

| <i>pattern no.</i> | <i>page</i> | <i>pattern no.</i> | <i>page</i> | <i>pattern no.</i> | <i>page</i> | <i>pattern no.</i> | <i>page</i> |
|---------------------|-------------|--------------------|-------------|--------------------|-------------|--------------------|-------------|
| DB1BD48SL | 311 | DBSMLH | 327 | DCE1R4830N | 316 | DD1B 4218N | 365 |
| DB1BD48SR | 311 | DBSMRH | 327 | DCE1R5424N | 316 | DD1B 4224N | 365 |
| DB1C 18 (L or R) 10 | 323 | DCE1BD6648D(L/R) | 317 | DCE1R5430N | 316 | DD1B 4818N | 365 |
| DB1C 24 (L or R) 10 | 323 | DCE1BD6648S(L/R) | 317 | DCE1R6024N | 316 | DD1B 4824N | 365 |
| DB1C 30 (L or R) 10 | 323 | DCE1BD7248D(L/R) | 317 | DCE1R6030N | 316 | DD1D L6024N | 357 |
| DB1C18 (L or R) | 323 | DCE1BD7248S(L/R) | 317 | DCE1R6624N | 316 | DD1D L6030N | 357 |
| DB1C24 (L or R) | 323 | DCE1BD7848D(L/R) | 317 | DCE1R6630N | 316 | DD1D L6624N | 357 |
| DB1C30 (L or R) | 323 | DCE1BD7848S(L/R) | 317 | DCE1R7224N | 316 | DD1D L6630N | 357 |
| DB1CL 24R | 329 | DCE1BD8448D(L/R) | 317 | DCE1R7230N | 316 | DD1D L7224N | 357 |
| DB1CL24L | 329 | DCE1BD8448S(L/R) | 317 | DCE1R7824N | 316 | DD1D L7230N | 357 |
| DB1CL24S | 329 | DCE1CR24L | 319 | DCE1R7830N | 316 | DD1E 3618N | 365 |
| DB1F18SP | 323, 374 | DCE1CR24N | 319 | DCE1R8424N | 316 | DD1E 3624N | 365 |
| DB1F18TP | 323, 374 | DCE1CR24R | 319 | DCE1R8430N | 316 | DD1E 4218N | 365 |
| DB1F24SP | 323, 374 | DCE1H4818 | 319 | DCE1R9024N | 316 | DD1E 4224N | 365 |
| DB1F24TP | 323, 374 | DCE1H4818P | 319 | DCE1R9030N | 316 | DD1O L6036N | 357 |
| DB1F30SP | 323, 374 | DCE1H6024 | 319 | DCE1R9624N | 316 | DD1O L6636N | 357 |
| DB1F30TP | 323, 374 | DCE1H6024P | 319 | DCE1R9630N | 316 | DD1O L7236N | 357 |
| DB1LS15A | 331 | DCE1L3636SSN | 317 | DCE1W362430N | 320 | DD1P (L)3618N | 365 |
| DB1LS18A | 331 | DCE1L4242DSN | 317 | DCE1W363024N | 320 | DD1P (L)3624N | 365 |
| DB1LS24A | 331 | DCE1L4242SDN | 317 | DCE1W422430N | 320 | DD1P (L)4218N | 365 |
| DB1LS30A | 331 | DCE1L4242SSN | 317 | DCE1W423024N | 320 | DD1P (L)4224N | 365 |
| DB1LS36A | 331 | DCE1L4260SSN | 318 | DCE1W482430N | 320 | DD1P (L)4818N | 365 |
| DB1LSP15 | 329 | DCE1L4266SSN | 318 | DCE1W483024N | 320 | DD1P (L)4824N | 365 |
| DB1LSP18 | 329 | DCE1L4272SSN | 318 | DCE1W722430N | 320 | DD1R CU6 | 359, 361 |
| DB1LSP24 | 329 | DCE1L4278SSN | 318 | DCE1W723024N | 320 | DD1S CU12 | 361 |
| DB1LSP30 | 329 | DCE1L4848DDN | 317 | DD1 BPB30 | 369 | DD1S L6024N | 357 |
| DB1LSP36 | 329 | DCE1L4848DSN | 317 | DD1 BPB36 | 369 | DD1S L6030N | 357 |
| DB1LSS15 | 329 | DCE1L4848SDN | 317 | DD1 BPB42 | 369 | DD1S L6624N | 357 |
| DB1LSS18 | 329 | DCE1L4848SSN | 317 | DD1 BPB48 | 369 | DD1S L6630N | 357 |
| DB1LSS24 | 329 | DCE1L4860DSN | 318 | DD1 BPD54 | 369 | DD1S L7224N | 357 |
| DB1LSS30 | 329 | DCE1L4860SDN | 318 | DD1 BPD60 | 369 | DD1S L7230N | 357 |
| DB1LSS36 | 329 | DCE1L4860SSN | 318 | DD1 BPD66 | 369 | DD1TEU24 | 331 |
| DB1PSP15 | 329 | DCE1L4866DSN | 318 | DD1 BPD72 | 369 | DD1TEU30 | 331 |
| DB1PSP18 | 329 | DCE1L4866SDN | 318 | DD1 BPR36 | 369 | DD1VD 3624 N | 361 |
| DB1PSP24 | 329 | DCE1L4866SSN | 318 | DD1 BPR42 | 369 | DD1VD 4224 N | 361 |
| DB1PSP30 | 329 | DCE1L4872DSN | 318 | DD1 BPR48 | 369 | DD1VD 4824 N | 361 |
| DB1PSP36 | 329 | DCE1L4872SDN | 318 | DD1 BPR60 | 369 | DD1VL 3624 N | 361 |
| DB1PWS24 | 324 | DCE1L4872SSN | 318 | DD1 BPU72 | 369 | DD1VL 4224 N | 361 |
| DB1PWS30 | 324 | DCE1L4878SSN | 318 | DD1 BPV36 | 361 | DD1VL 4824 N | 361 |
| DB1PWS36 | 324 | DCE1L4884SSN | 318 | DD1 BPV42 | 361 | DD2B 3018N | 363 |
| DB1PWS42 | 324 | DCE1L6042SSN | 318 | DD1 BPV48 | 361 | DD2B 3618N | 363 |
| DB1PWS48 | 324 | DCE1L6048DSN | 318 | DD1 DIEU | 367 | DD2B 3624N | 363 |
| DB1PWSL | 324 | DCE1L6048SDN | 318 | DD1 EU18 | 367 | DD2B 4218N | 363 |
| DB1PWSL10 | 324 | DCE1L6048SSN | 318 | DD1 EU24 | 367 | DD2B 4224N | 363 |
| DB1PWSLWH | 324 | DCE1L6642SSN | 318 | DD1 EU30 | 367 | DD2B 4818N | 363 |
| DB1PWSP | 324 | DCE1L6648DSN | 318 | DD1 FBPB30 | 371 | DD2B 4824N | 363 |
| DB1PWSPWH | 324 | DCE1L6648SDN | 318 | DD1 FBPB36 | 371 | DD2D L6024N | 355 |
| DB1PWSR | 324 | DCE1L6648SSN | 318 | DD1 FBPB42 | 371 | DD2D L6030N | 355 |
| DB1PWSR10 | 324 | DCE1L7242SSN | 318 | DD1 FBPB48 | 371 | DD2D L6624N | 355 |
| DB1PWSRWH | 324 | DCE1L7248DSN | 318 | DD1 FBPD54 | 371 | DD2D L6630N | 355 |
| DB1RU18 | 227, 232 | DCE1L7248SDN | 318 | DD1 FBPD60 | 371 | DD2D L7224N | 355 |
| DB1S CR | 331 | DCE1L7248SSN | 318 | DD1 FBPD66 | 371 | DD2D L7230N | 355 |
| DB1SWSL | 327 | DCE1L7842SSN | 318 | DD1 FBPD72 | 371 | DD2E 3618N | 363 |
| DB1SWSP | 327 | DCE1L7848SSN | 318 | DD1 FBPR36 | 371 | DD2E 3624N | 363 |
| DB1SWSR | 327 | DCE1L8448SSN | 318 | DD1 FBPR42 | 371 | DD2E 4218N | 363 |
| DB1TB | 331 | DCE1R1212G | 316 | DD1 FBPR48 | 371 | DD2E 4224N | 363 |
| DB1U18 | 227, 232 | DCE1R2424N | 316 | DD1 FBPR60 | 371 | DD2O L6036N | 355 |
| DB1WR54 | 323, 374 | DCE1R2430N | 316 | DD1 FBPU72 | 371 | DD2O L6636N | 355 |
| DB1WR60 | 323, 374 | DCE1R3024N | 316 | DD1 FBPV36 | 361 | DD2O L7236N | 355 |
| DB1WR66 | 323, 374 | DCE1R3030N | 316 | DD1 FBPV42 | 361 | DD2OD 36L | 267 |
| DB1WR72 | 323, 374 | DCE1R3624N | 316 | DD1 FBPV48 | 361 | DD2OD 42L | 267 |
| DB2CL24L | 329 | DCE1R3630N | 316 | DD1 IE30 | 367 | DD2OD 48L | 267 |
| DB2CL24LS | 329 | DCE1R4224N | 316 | DD1B 3018N | 365 | DD2OD 54L | 267 |
| DB2CL24R | 329 | DCE1R4230N | 316 | DD1B 3618N | 365 | DD2OD 60L | 267 |
| DB2CL24RS | 329 | DCE1R4824N | 316 | DD1B 3624N | 365 | DD2OD 66L | 267 |

| <i>pattern no.</i> | <i>page</i> | <i>pattern no.</i> | <i>page</i> | <i>pattern no.</i> | <i>page</i> | <i>pattern no.</i> | <i>page</i> |
|--------------------|-------------|--------------------|---------------|--|-------------|--------------------|-------------|
| DD2OD 72L | 267 | DE1(E,8,T) PJ48NP | 183 | DP 101, 102, 129, 131, 135, 137, 138, 141, 153, 173, 174 | | DP1AU0783 | 117 |
| DD2P (L)3618N | 363 | DE1(E,8,T) PJ48WP | 183, 191, 197 | DP1 | 79 | DP1AU0784 | 117 |
| DD2P (L)3624N | 363 | DE1(E,8,T) PJ54WP | 184, 191, 197 | DP1 CG | 147 | DP1AU0786 | 168 |
| DD2P (L)4218N | 363 | DE1(E,8,T) PJ60WP | 184, 191, 197 | DP1 CHB | 147 | DP1AU0787 | 168 |
| DD2P (L)4224N | 363 | DE1(E,8,T) PJ66WP | 184, 191 | DP1 CHP | 147 | DP1AU0789 | 117 |
| DD2P (L)4818N | 363 | DE1(E,8,T) PJ72WP | 184, 191 | DP1 TKC | 207 | DP1AU0790 | 117 |
| DD2P (L)4824N | 363 | DE1(E,8,T) PJ78WP | 184, 191 | DP1 VWC | 207 | DP1AU0792 | 168 |
| DD2S L6024N | 355 | DE1(E,8,T) PJ84WP | 184, 191 | DP120PC08S | 174 | DP1AU0793 | 168 |
| DD2S L6030N | 355 | DE1(E,8,T) PJ96WP | 184 | DP120PC14S | 174 | DP1AU0795 | 117 |
| DD2S L6624N | 355 | DE1(E,8,T) PM24 | 183 | DP120PC22S | 174 | DP1AU0796 | 117 |
| DD2S L6630N | 355 | DE1(E,8,T) PM30 | 183 | DP120PC28S | 174 | DP1AU0798 | 168 |
| DD2S L7224N | 355 | DE1(E,8,T) PM36 | 183 | DP120PC36S | 174 | DP1AU0799 | 168 |
| DD2S L7230N | 355 | DE1(E,8,T) PM42 | 183 | DP120PC36SF | 174 | DP1AU1414 | 118 |
| DD2VD 3624 N | 359 | DE1(E,8,T) PM48 | 183 | DP120PC42S | 174 | DP1AU1415 | 118 |
| DD2VD 4224 N | 359 | DE1(E,8,T) PM60 | 183 | DP120PC42SH | 174 | DP1AU1417 | 118 |
| DD2VD 4824 N | 359 | DE1(E,8,T) PMS24 | 183 | DP120PC50S | 174 | DP1AU1418 | 118 |
| DD2VL 3624 N | 359 | DE1(E,8,T) PMS30 | 183 | DP120PC57S | 174 | DP1AU1423 | 118 |
| DD2VL 4224 N | 359 | DE1(E,8,T) PMS36 | 183 | DP120PC64S | 174 | DP1AU1424 | 118 |
| DD2VL 4824 N | 359 | DE1(E,8,T) PMS42 | 183 | DP120PC78S | 174 | DP1AU1429 | 118 |
| DD3 PS36 | 268 | DE1(E,8,T) PMS48 | 183 | DP120PC78S | 174 | DP1AU1430 | 118 |
| DD3 PS42 | 268 | DE1(E,8,T) PMS60 | 183 | DP120PO36 | 174 | DP1AU1435 | 118 |
| DD3 PS48 | 268 | DEIT B1NY1 | 203 | DP120PO42 | 174 | DP1AU1436 | 118 |
| DD3 PS54 | 268 | DEIT B156 | 203 | DP120PO50 | 174 | DP1AU1441 | 118 |
| DD3 PS60 | 268 | DEIT B156(L/R) | 199 | DP120PO57 | 174 | DP1AU1442 | 118 |
| DD3 PS66 | 268 | DEIT C1144 | 199 | DP120PO64 | 174 | DP1AU1447 | 118 |
| DD3 PS72 | 268 | DEIT R156 | 199 | DP120PO78 | 174 | DP1AU1448 | 118 |
| DE1 | 196, 197 | DEIT R156SF | 203 | DP120S | 174 | DP1AU1450 | 169 |
| DE1 FDP | 191 | DE2 | 196 | DP120SPO 14 | 173 | DP1AU1451 | 168 |
| DE18 B1NY1 | 203 | DE2KC10 | 75, 187 | DP120SPO 21 | 173 | DP1AU1453 | 118 |
| DE18 B156 | 203 | DE2PP36S | 200 | DP120SPO 28 | 173 | DP1AU1454 | 118 |
| DE18 B156(L/R) | 199 | DE2PP36T | 200 | DP1AU0714 | 117 | DP1AU1456 | 169 |
| DE18 C1144 | 199 | DE2PP42S | 200 | DP1AU0715 | 117 | DP1AU1457 | 168 |
| DE18 R156 | 199 | DE2PP42T | 200 | DP1AU0717 | 117 | DP1AU1459 | 118 |
| DE18 R156SF | 203 | DE2PP50S | 200 | DP1AU0718 | 117 | DP1AU1459 | 118 |
| DE1DATSHD | 207 | DE2PP50T | 200 | DP1AU0723 | 117 | DP1AU1460 | 118 |
| DE1DATSHDF | 207 | DE2PP64S | 200 | DP1AU0724 | 117 | DP1AU1462 | 169 |
| DE1DOR4 | 187 | DE2PP64T | 200 | DP1AU0729 | 117 | DP1AU1463 | 168 |
| DE1DOR5 | 187 | DE2PP78S | 200 | DP1AU0730 | 117 | DP1AU1465 | 118 |
| DE1DOR6 | 187 | DE2PP78T | 200 | DP1AU0735 | 117 | DP1AU1466 | 118 |
| DE1DR1 | 187 | DE4WSMC | 192 | DP1AU0736 | 117 | DP1AU1468 | 169 |
| DE1DR2 | 187 | DE4WSME108 | 192 | DP1AU0741 | 117 | DP1AU1469 | 168 |
| DE1DR3 | 187 | DE4WSME72 | 192 | DP1AU0742 | 117 | DP1AU1471 | 118 |
| DE1DR4 | 187 | DE4WSMED108 | 192 | DP1AU0747 | 117 | DP1AU1472 | 118 |
| DE1DR5 | 187 | DE4WSMED72 | 192 | DP1AU0748 | 117 | DP1AU1474 | 169 |
| DE1DR6 | 187 | DE6 FDP | 191 | DP1AU0750 | 168 | DP1AU1475 | 168 |
| DE1E B1NY1 | 203 | DE6 FDPF | 191 | DP1AU0751 | 168 | DP1AU1477 | 118 |
| DE1E B156 | 203 | DE6 VDR1 | 190 | DP1AU0753 | 117 | DP1AU1478 | 118 |
| DE1E B156(L/R) | 199 | DE6 VDR2 | 190 | DP1AU0754 | 117 | DP1AU1480 | 169 |
| DE1E C1144 | 199 | DE6 VDR3 | 190 | DP1AU0755 | 168 | DP1AU1481 | 168 |
| DE1E R156 | 199 | DE6 VDR4 | 190 | DP1AU0757 | 168 | DP1AU1483 | 118 |
| DE1E R156SF | 203 | DE6 VDR5 | 190 | DP1AU0759 | 117 | DP1AU1484 | 118 |
| DE1(E,8,T) PCNP | 183 | DE6 VDR6 | 190 | DP1AU0760 | 117 | DP1AU1486 | 169 |
| DE1(E,8,T) PCWP | 183 | DE6 VPM | 190 | DP1AU0762 | 168 | DP1AU1487 | 168 |
| DE1(E,8,T) PJ15NP | 183 | DL3T5E19S | 235 | DP1AU0763 | 168 | DP1AU1489 | 118 |
| DE1(E,8,T) PJ15WP | 183 | DL3T5E25A | 235 | DP1AU0765 | 117 | DP1AU1490 | 118 |
| DE1(E,8,T) PJ18NP | 183 | DL3T5E25S | 235 | DP1AU0766 | 117 | DP1AU1492 | 169 |
| DE1(E,8,T) PJ18WP | 183 | DL3T5E37A | 235 | DP1AU0768 | 168 | DP1AU1493 | 168 |
| DE1(E,8,T) PJ24NP | 183 | DL3T5E37S | 235 | DP1AU0769 | 168 | DP1AU1495 | 118 |
| DE1(E,8,T) PJ24WP | 183 | DL3T5E49A | 235 | DP1AU0771 | 117 | DP1AU1496 | 118 |
| DE1(E,8,T) PJ30NP | 183 | DL3T5E49S | 235 | DP1AU0772 | 117 | DP1AU1498 | 169 |
| DE1(E,8,T) PJ30WP | 183 | DL3TC | 235 | DP1AU0774 | 168 | DP1AU1499 | 168 |
| DE1(E,8,T) PJ36NP | 183 | DL4L17 | 235 | DP1AU0775 | 168 | DP1AUECTP | 118, 169 |
| DE1(E,8,T) PJ36WP | 183 | DL4L31 | 235 | DP1AU0777 | 117 | DP1BCT18 | 208 |
| DE1(E,8,T) PJ42NP | 183 | DL4L44 | 235 | DP1AU0778 | 117 | DP1BCT24 | 208 |
| DE1(E,8,T) PJ42WP | 183 | DL4L58 | 235 | DP1AU0780 | 168 | DP1BCT30 | 208 |
| | | | | DP1AU0781 | 168 | DP1BCT36 | 208 |

| <i>pattern no.</i> | <i>page</i> | <i>pattern no.</i> | <i>page</i> | <i>pattern no.</i> | <i>page</i> | <i>pattern no.</i> | <i>page</i> |
|--------------------|-------------|--------------------|-------------|--------------------|-------------|--------------------|-------------|
| DP1BCT42 | 208 | DP1SO2842CCF | 160 | DP1SO5760CCF | 161 | DP1SW0730 | 95 |
| DP1BCT48 | 208 | DP1SO2848 | 57, 68, 156 | DP1SO5760EPEF | 165 | DP1SW0736 | 95 |
| DP1BCT60 | 208 | DP1SO2848CCF | 160 | DP1SO6415 | 58, 157 | DP1SW0742 | 95 |
| DP1FPRBL | 147 | DP1SO2848EPEF | 164 | DP1SO6415CCF | 161 | DP1SW0748 | 95 |
| DP1FPRBS | 147 | DP1SO2860 | 57, 68, 156 | DP1SO6418 | 58, 157 | DP1SW1424 | 95 |
| DP1FPRBT | 147 | DP1SO2860CCF | 160 | DP1SO6418CCF | 161 | DP1SW1430 | 95 |
| DP1FPRBX | 147 | DP1SO2860EPEF | 164 | DP1SO6424 | 58, 157 | DP1SW1436 | 95 |
| DP1MBT24 | 85 | DP1SO4215 | 57, 156 | DP1SO6424CCF | 161 | DP1SW1442 | 95 |
| DP1MBT30 | 85 | DP1SO4215CCF | 160 | DP1SO6430 | 58, 157 | DP1SW1448 | 95 |
| DP1MBT36 | 85 | DP1SO4218 | 57, 156 | DP1SO6430CCF | 161 | DP1SW2124 | 95 |
| DP1MBT42 | 85 | DP1SO4218CCF | 160 | DP1SO6430EPEF | 165 | DP1SW2130 | 95 |
| DP1MBT48 | 85 | DP1SO4224 | 57, 156 | DP1SO6436 | 58, 157 | DP1SW2136 | 95 |
| DP1PRBL | 147 | DP1SO4224CCF | 160 | DP1SO6436CCF | 161 | DP1SW2142 | 95 |
| DP1PRBS | 147 | DP1SO4230 | 57, 156 | DP1SO6436EPEF | 165 | DP1SW2148 | 95 |
| DP1PRBT | 147 | DP1SO4230CCF | 160 | DP1SO6442 | 58, 157 | DP1SW2824 | 95 |
| DP1PRBX | 147 | DP1SO4230EPEF | 164 | DP1SO6442CCF | 161 | DP1SW2830 | 95 |
| DP1PRFN15 | 148 | DP1SO4236 | 57, 156 | DP1SO6448 | 58, 157 | DP1SW2836 | 95 |
| DP1PRFN250 | 148 | DP1SO4236CCF | 160 | DP1SO6448CCF | 161 | DP1SW2842 | 95 |
| DP1PRFN70 | 148 | DP1SO4236EPEF | 164 | DP1SO6448EPEF | 165 | DP1SW2848 | 95 |
| DP1PT3 | 141 | DP1SO4242 | 57, 156 | DP1SO6460 | 58, 157 | DP1WT57 | 144 |
| DP1PT4 | 141 | DP1SO4242CCF | 160 | DP1SO6460CCF | 161 | DP1WT64 | 144 |
| DP1SO1015 | 67 | DP1SO4248 | 57, 156 | DP1SO715 | 67 | DP1WT71 | 144 |
| DP1SO1018 | 67 | DP1SO4248CCF | 160 | DP1SO718 | 67 | DP1WT78 | 144 |
| DP1SO1024 | 67 | DP1SO4248EPEF | 164 | DP1SO724 | 67 | DP1WTBTC15 | 144 |
| DP1SO1030 | 67 | DP1SO4260 | 57, 156 | DP1SO730 | 67 | DP1WTBTC18 | 144 |
| DP1SO1036 | 67 | DP1SO4260CCF | 160 | DP1SO736 | 67 | DP1WTBTC24 | 144 |
| DP1SO1042 | 67 | DP1SO4260EPEF | 164 | DP1SO742 | 67 | DP1WTBTC30 | 144 |
| DP1SO1048 | 67 | DP1SO5015 | 57, 157 | DP1SO748 | 67 | DP1WTBTC36 | 144 |
| DP1SO1060 | 67 | DP1SO5015CCF | 161 | DP1SO760 | 67 | DP1WTBTC42 | 144 |
| DP1SO1415 | 67 | DP1SO5018 | 57, 157 | DP1SO7815 | 58 | DP1WTBTC48 | 144 |
| DP1SO1418 | 67 | DP1SO5018CCF | 161 | DP1SO7818 | 58 | DP1WTET57 | 144 |
| DP1SO1424 | 67 | DP1SO5024 | 57, 157 | DP1SO7824 | 58 | DP1WTET64 | 144 |
| DP1SO1430 | 67 | DP1SO5024CCF | 161 | DP1SO7830 | 58 | DP1WTET71 | 144 |
| DP1SO1436 | 67 | DP1SO5030 | 57, 157 | DP1SO7836 | 58 | DP1WTET78 | 144 |
| DP1SO1442 | 67 | DP1SO5030CCF | 161 | DP1SO7842 | 58 | DP1WTTC15 | 144 |
| DP1SO1448 | 67 | DP1SO5030EPEF | 165 | DP1SO7848 | 58 | DP1WTTC18 | 144 |
| DP1SO1460 | 67 | DP1SO5036 | 57, 157 | DP1SOS15 | 69 | DP1WTTC24 | 144 |
| DP1SO2115 | 68 | DP1SO5036CCF | 161 | DP1SOS18 | 69 | DP1WTTC30 | 144 |
| DP1SO2118 | 68 | DP1SO5036EPEF | 165 | DP1SOS24 | 69 | DP1WTTC36 | 144 |
| DP1SO2124 | 68 | DP1SO5042 | 57, 157 | DP1SOS30 | 69 | DP1WTTC42 | 144 |
| DP1SO2130 | 68 | DP1SO5042CCF | 161 | DP1SOS36 | 69 | DP1WTTC48 | 144 |
| DP1SO2136 | 68 | DP1SO5048 | 57, 157 | DP1SOS42 | 69 | DP1WTTC54 | 144 |
| DP1SO2142 | 68 | DP1SO5048CCF | 161 | DP1SOS48 | 69 | DP1WTTC60 | 144 |
| DP1SO2148 | 68 | DP1SO5048EPEF | 165 | DP1SOS60 | 69 | DP1WTTC66 | 144 |
| DP1SO2160 | 68 | DP1SO5060 | 57, 157 | DP1SOWH15 | 57, 156 | DP1WTTC72 | 144 |
| DP1SO2418 | 75 | DP1SO5060CCF | 161 | DP1SOWH15CCF | 160 | DP1WTTC78 | 144 |
| DP1SO2424 | 75 | DP1SO5060EPEF | 165 | DP1SOWH18 | 57, 156 | DP1WTTC84 | 144 |
| DP1SO2430 | 75 | DP1SO5715 | 58, 157 | DP1SOWH18CCF | 160 | DP1WTTC90 | 144 |
| DP1SO2436 | 75 | DP1SO5715CCF | 161 | DP1SOWH24 | 57, 156 | DP1WTTC96 | 144 |
| DP1SO2442 | 75 | DP1SO5718 | 58, 157 | DP1SOWH24CCF | 160 | DP1WTTSB | 145 |
| DP1SO2448 | 75 | DP1SO5718CCF | 161 | DP1SOWH30 | 57, 156 | DP2 STFL1418 | 53 |
| DP1SO2460 | 75 | DP1SO5724 | 58, 157 | DP1SOWH30CCF | 160 | DP2 STFL1424 | 53 |
| DP1SO2815 | 57, 68, 156 | DP1SO5724CCF | 161 | DP1SOWH30EPEF | 164 | DP2 STFL1430 | 53 |
| DP1SO2815CCF | 160 | DP1SO5730 | 58, 157 | DP1SOWH36 | 57, 156 | DP2 STFL1436 | 53 |
| DP1SO2818 | 57, 68, 156 | DP1SO5730CCF | 161 | DP1SOWH36CCF | 160 | DP2 STFL1442 | 53 |
| DP1SO2818CCF | 160 | DP1SO5730EPEF | 165 | DP1SOWH36EPEF | 164 | DP2 STFL1448 | 53 |
| DP1SO2824 | 57, 68, 156 | DP1SO5736 | 58, 157 | DP1SOWH42 | 57, 156 | DP2APO36 | 131 |
| DP1SO2824CCF | 160 | DP1SO5736CCF | 161 | DP1SOWH42CCF | 160 | DP2APO42 | 131 |
| DP1SO2830 | 57, 68, 156 | DP1SO5736EPEF | 165 | DP1SOWH48 | 57, 156 | DP2APO50 | 131 |
| DP1SO2830CCF | 160 | DP1SO5742 | 58, 157 | DP1SOWH48CCF | 160 | DP2APO57 | 131 |
| DP1SO2830EPEF | 164 | DP1SO5742CCF | 161 | DP1SOWH48EPEF | 164 | DP2APO64 | 131 |
| DP1SO2836 | 57, 68, 156 | DP1SO5748 | 58, 157 | DP1SOWH60 | 57, 156 | DP2APO78 | 131 |
| DP1SO2836CCF | 160 | DP1SO5748CCF | 161 | DP1SOWH60CCF | 160 | DP2ASPO 14 | 132 |
| DP1SO2836EPEF | 164 | DP1SO5748EPEF | 165 | DP1SOWH60EPEF | 164 | DP2ASPO 21 | 132 |
| DP1SO2842 | 57, 68, 156 | DP1SO5760 | 58, 157 | DP1SW0724 | 95 | DP2ASPO 28 | 132 |

| <i>pattern no.</i> | <i>page</i> | <i>pattern no.</i> | <i>page</i> | <i>pattern no.</i> | <i>page</i> | <i>pattern no.</i> | <i>page</i> |
|--------------------|-------------|--------------------|-------------|--------------------|-------------|--------------------|-------------|
| DP2BC18K | 75 | DP3L11418 | 71 | DP3L14218F | 62 | DP3L15736F | 64 |
| DP2BC24K | 75 | DP3L11418F | 72 | DP3L14224 | 61, 158 | DP3L15742 | 63, 159 |
| DP2BC30K | 75 | DP3L11424 | 71 | DP3L14224CCF | 162 | DP3L15742CCF | 163 |
| DP2BC36K | 75 | DP3L11424F | 72 | DP3L14224F | 62 | DP3L15742F | 64 |
| DP2BC42K | 75 | DP3L11430 | 71 | DP3L14230 | 61, 158 | DP3L15748 | 63, 159 |
| DP2BC48K | 75 | DP3L11430F | 72 | DP3L14230CCF | 162 | DP3L15748CCF | 163 |
| DP2BC60K | 75 | DP3L11436 | 71 | DP3L14230EPEF | 166 | DP3L15748EPEF | 167 |
| DP2CHTP | 147 | DP3L11436F | 72 | DP3L14230F | 62 | DP3L15748F | 64 |
| DP2PMS36 | 141 | DP3L11442 | 71 | DP3L14236 | 61, 158 | DP3L15760EPEF | 167 |
| DP2PMS42 | 141 | DP3L11442F | 72 | DP3L14236CCF | 162 | DP3L15772EPEF | 167 |
| DP2PMS50 | 141 | DP3L11448 | 71 | DP3L14236EPEF | 166 | DP3L15784EPEF | 167 |
| DP2PMS57 | 141 | DP3L11448F | 72 | DP3L14236F | 62 | DP3L1WH15 | 61, 158 |
| DP2PMS64 | 141 | DP3L12115 | 71 | DP3L14242 | 61, 158 | DP3L1WH15CCF | 162 |
| DP2PMS78 | 141 | DP3L12118 | 71 | DP3L14242CCF | 162 | DP3L1WH15F | 62 |
| DP2PRFIC15 | 148 | DP3L12124 | 71 | DP3L14242F | 62 | DP3L1WH18 | 61, 158 |
| DP2PRFIC70 | 148 | DP3L12130 | 71 | DP3L14248 | 61, 158 | DP3L1WH18CCF | 162 |
| DP2PRFN15 | 148 | DP3L12136 | 71 | DP3L14248CCF | 162 | DP3L1WH18F | 62 |
| DP2PRFN70 | 148 | DP3L12142 | 71 | DP3L14248EPEF | 166 | DP3L1WH24 | 61, 158 |
| DP2PRFW15 | 148 | DP3L12148 | 71 | DP3L14248F | 62 | DP3L1WH24CCF | 162 |
| DP2PRFW70 | 148 | DP3L12415 | 77 | DP3L14260EPEF | 166 | DP3L1WH24F | 62 |
| DP2PS | 90 | DP3L12415F | 77 | DP3L14272EPEF | 166 | DP3L1WH30 | 61, 158 |
| DP2SOS15 | 69 | DP3L12418 | 77 | DP3L14284EPEF | 166 | DP3L1WH30CCF | 162 |
| DP2SOS18 | 69 | DP3L12418F | 77 | DP3L15015 | 63, 159 | DP3L1WH30EPEF | 166 |
| DP2SOS24 | 69 | DP3L12424 | 77 | DP3L15015CCF | 163 | DP3L1WH30F | 62 |
| DP2SOS30 | 69 | DP3L12424F | 77 | DP3L15015F | 64 | DP3L1WH36 | 61, 158 |
| DP2SOS36 | 69 | DP3L12430 | 77 | DP3L15018 | 63, 159 | DP3L1WH36CCF | 162 |
| DP2SOS42 | 69 | DP3L12430F | 77 | DP3L15018CCF | 163 | DP3L1WH36EPEF | 166 |
| DP2SOS48 | 69 | DP3L12436 | 77 | DP3L15018F | 64 | DP3L1WH36F | 62 |
| DP2SOS60 | 69 | DP3L12436F | 77 | DP3L15024 | 63, 159 | DP3L1WH42 | 61, 158 |
| DP2SOSC | 69 | DP3L12442 | 77 | DP3L15024CCF | 163 | DP3L1WH42CCF | 162 |
| DP2STF 2118 | 53 | DP3L12442F | 77 | DP3L15024F | 64 | DP3L1WH42F | 62 |
| DP2STF 2124 | 53 | DP3L12448 | 77 | DP3L15030 | 63, 159 | DP3L1WH48 | 61, 158 |
| DP2STF 2130 | 53 | DP3L12448F | 77 | DP3L15030CCF | 163 | DP3L1WH48CCF | 162 |
| DP2STF 2136 | 53 | DP3L12815 | 61, 71, 158 | DP3L15030EPEF | 167 | DP3L1WH48EPEF | 166 |
| DP2STF 2142 | 53 | DP3L12815CCF | 162 | DP3L15030F | 64 | DP3L1WH48F | 62 |
| DP2STF 2148 | 53 | DP3L12815F | 62, 72 | DP3L15036 | 63, 159 | DP3L1WH60EPEF | 166 |
| DP2S(T/N)F 1418 | 53 | DP3L12818 | 61, 71, 158 | DP3L15036CCF | 163 | DP3L1WH72EPEF | 166 |
| DP2S(T/N)F 1424 | 53 | DP3L12818CCF | 162 | DP3L15036EPEF | 167 | DP3L1WH84EPEF | 166 |
| DP2S(T/N)F 1430 | 53 | DP3L12818F | 62, 72 | DP3L15036F | 64 | DP3MB | 84, 85 |
| DP2S(T/N)F 1436 | 53 | DP3L12824 | 61, 71, 158 | DP3L15042 | 63, 159 | DP3PSB | 76, 89, 90 |
| DP2S(T/N)F 1442 | 53 | DP3L12824CCF | 162 | DP3L15042CCF | 163 | DP3PWS36 | 141 |
| DP2S(T/N)F 1448 | 53 | DP3L12824F | 62, 72 | DP3L15042F | 64 | DP3PWS42 | 141 |
| DP2S(T/N)F 2818 | 53 | DP3L12830 | 61, 71, 158 | DP3L15048 | 63, 159 | DP3PWS50 | 141 |
| DP2S(T/N)F 2824 | 53 | DP3L12830CCF | 162 | DP3L15048CCF | 163 | DP3PWS57 | 141 |
| DP2S(T/N)F 2830 | 53 | DP3L12830EPEF | 166 | DP3L15048EPEF | 167 | DP3PWS64 | 141 |
| DP2S(T/N)F 2836 | 53 | DP3L12830F | 62, 72 | DP3L15048F | 64 | DP3PWS78 | 141 |
| DP2S(T/N)F 2842 | 53 | DP3L12836 | 61, 71, 158 | DP3L15060EPEF | 167 | DP3SS | 76, 87, 88 |
| DP2S(T/N)F 2848 | 53 | DP3L12836CCF | 162 | DP3L15072EPEF | 167 | DP6PE08 | 136 |
| DP3ESB | 76, 91, 92 | DP3L12836EPEF | 166 | DP3L15084EPEF | 167 | DP6PE14 | 136 |
| DP3L10715 | 71 | DP3L12836F | 62, 72 | DP3L15715 | 63, 159 | DP6PE22 | 136 |
| DP3L10718 | 71 | DP3L12842 | 61, 71, 158 | DP3L15715CCF | 163 | DP6PE28 | 136 |
| DP3L10724 | 71 | DP3L12842CCF | 162 | DP3L15715F | 64 | DP6PE36 | 136 |
| DP3L10730 | 71 | DP3L12842F | 62, 72 | DP3L15718 | 63, 159 | DP6PE36F | 136 |
| DP3L10736 | 71 | DP3L12848 | 61, 71, 158 | DP3L15718CCF | 163 | DP6PE42 | 136 |
| DP3L10742 | 71 | DP3L12848CCF | 162 | DP3L15718F | 64 | DP6PE42H | 136 |
| DP3L10748 | 71 | DP3L12848EPEF | 166 | DP3L15724 | 63, 159 | DP6PE50 | 136 |
| DP3L11015 | 71 | DP3L12848F | 62, 72 | DP3L15724CCF | 163 | DP6PE57 | 136 |
| DP3L11018 | 71 | DP3L12860EPEF | 166 | DP3L15724F | 64 | DP6PE64 | 136 |
| DP3L11024 | 71 | DP3L12872EPEF | 166 | DP3L15730 | 63, 159 | DP6PE78 | 136 |
| DP3L11030 | 71 | DP3L12884EPEF | 166 | DP3L15730CCF | 163 | DP6PEWH | 136 |
| DP3L11036 | 71 | DP3L14215 | 61, 158 | DP3L15730EPEF | 167 | DP6PEWH36 | 136 |
| DP3L11042 | 71 | DP3L14215CCF | 162 | DP3L15730F | 64 | DP6PEWH42 | 136 |
| DP3L11048 | 71 | DP3L14215F | 62 | DP3L15736 | 63, 159 | DP6PEWH50 | 136 |
| DP3L11415 | 71 | DP3L14218 | 61, 158 | DP3L15736CCF | 163 | DP6PEWH57 | 136 |
| DP3L11415F | 72 | DP3L14218CCF | 162 | DP3L15736EPEF | 167 | DP6PEWH64 | 136 |

| <i>pattern no.</i> | <i>page</i> | <i>pattern no.</i> | <i>page</i> | <i>pattern no.</i> | <i>page</i> | <i>pattern no.</i> | <i>page</i> |
|--------------------|-------------|--------------------|-------------|--------------------|-------------|--------------------|-------------|
| DP6PEWH78 | 136 | DP7CBBRR5030 | 41 | DP7CMMFR6460 | 20 | DP7CMMRR3618 | 15 |
| DP6PEWHS14 | 136 | DP7CBBRR5036 | 41 | DP7CMMFR7815 | 21 | DP7CMMRR3624 | 15 |
| DP6PEWHS21 | 136 | DP7CBBRR5042 | 41 | DP7CMMFR7818 | 21 | DP7CMMRR3630 | 15 |
| DP6PEWHS28 | 136 | DP7CBBRR5048 | 41 | DP7CMMFR7824 | 21 | DP7CMMRR3636 | 15 |
| DP6TF | 97 | DP7CBBRR5060 | 41 | DP7CMMFR7830 | 21 | DP7CMMRR3642 | 15 |
| DP6TS | 98 | DP7CBBRR5718 | 42 | DP7CMMFR7836 | 21 | DP7CMMRR3648 | 15 |
| DP7 | 48, 49, 50 | DP7CBBRR5724 | 42 | DP7CMMFR7842 | 21 | DP7CMMRR3660 | 15 |
| DP71RCT18 | 208 | DP7CBBRR5730 | 42 | DP7CMMFR7848 | 21 | DP7CMMRR4215 | 15 |
| DP71RCT24 | 208 | DP7CBBRR5736 | 42 | DP7CMMFRWH15 | 19 | DP7CMMRR4218 | 15 |
| DP71RCT30 | 208 | DP7CBBRR5742 | 42 | DP7CMMFRWH18 | 19 | DP7CMMRR4224 | 15 |
| DP71RCT36 | 208 | DP7CBBRR5748 | 42 | DP7CMMFRWH24 | 19 | DP7CMMRR4230 | 15 |
| DP71RCT42 | 208 | DP7CBBRR5760 | 42 | DP7CMMFRWH30 | 19 | DP7CMMRR4236 | 15 |
| DP71RCT48 | 208 | DP7CBBRR6418 | 42 | DP7CMMFRWH36 | 19 | DP7CMMRR4242 | 15 |
| DP71RCT60 | 208 | DP7CBBRR6424 | 42 | DP7CMMFRWH42 | 19 | DP7CMMRR4248 | 15 |
| DP72RCT18 | 208 | DP7CBBRR6430 | 42 | DP7CMMFRWH48 | 19 | DP7CMMRR4260 | 15 |
| DP72RCT24 | 208 | DP7CBBRR6436 | 42 | DP7CMMFRWH60 | 19 | DP7CMMRR5015 | 15 |
| DP72RCT30 | 208 | DP7CBBRR6442 | 42 | DP7CMMLL3618 | 17 | DP7CMMRR5018 | 15 |
| DP72RCT36 | 208 | DP7CBBRR6448 | 42 | DP7CMMLL3624 | 17 | DP7CMMRR5024 | 15 |
| DP72RCT42 | 208 | DP7CBBRR6460 | 42 | DP7CMMLL3630 | 17 | DP7CMMRR5030 | 15 |
| DP72RCT48 | 208 | DP7CBBRR7818 | 42 | DP7CMMLL3636 | 17 | DP7CMMRR5036 | 15 |
| DP72RCT60 | 208 | DP7CBBRR7824 | 42 | DP7CMMLL3642 | 17 | DP7CMMRR5042 | 15 |
| DP7BF | 124 | DP7CBBRR7830 | 42 | DP7CMMLL3648 | 17 | DP7CMMRR5048 | 15 |
| DP7CBBFR4218 | 43 | DP7CBBRR7836 | 42 | DP7CMMLL3660 | 17 | DP7CMMRR5060 | 15 |
| DP7CBBFR4224 | 43 | DP7CBBRR7842 | 42 | DP7CMMLL4218 | 17 | DP7CMMRR5715 | 16 |
| DP7CBBFR4230 | 43 | DP7CBBRR7848 | 42 | DP7CMMLL4224 | 17 | DP7CMMRR5718 | 16 |
| DP7CBBFR4236 | 43 | DP7CERK | 203 | DP7CMMLL4230 | 17 | DP7CMMRR5724 | 16 |
| DP7CBBFR4242 | 43 | DP7CMMFR3615 | 19 | DP7CMMLL4236 | 17 | DP7CMMRR5730 | 16 |
| DP7CBBFR4248 | 43 | DP7CMMFR3618 | 19 | DP7CMMLL4242 | 17 | DP7CMMRR5736 | 16 |
| DP7CBBFR4260 | 43 | DP7CMMFR3624 | 19 | DP7CMMLL4248 | 17 | DP7CMMRR5742 | 16 |
| DP7CBBFR5018 | 43 | DP7CMMFR3630 | 19 | DP7CMMLL4260 | 17 | DP7CMMRR5748 | 16 |
| DP7CBBFR5024 | 43 | DP7CMMFR3636 | 19 | DP7CMMLL5018 | 17 | DP7CMMRR5760 | 16 |
| DP7CBBFR5030 | 43 | DP7CMMFR3642 | 19 | DP7CMMLL5024 | 17 | DP7CMMRR6415 | 16 |
| DP7CBBFR5036 | 43 | DP7CMMFR3648 | 19 | DP7CMMLL5030 | 17 | DP7CMMRR6418 | 16 |
| DP7CBBFR5042 | 43 | DP7CMMFR3660 | 19 | DP7CMMLL5036 | 17 | DP7CMMRR6424 | 16 |
| DP7CBBFR5048 | 43 | DP7CMMFR4215 | 19 | DP7CMMLL5042 | 17 | DP7CMMRR6430 | 16 |
| DP7CBBFR5060 | 43 | DP7CMMFR4218 | 19 | DP7CMMLL5048 | 17 | DP7CMMRR6436 | 16 |
| DP7CBBFR5718 | 44 | DP7CMMFR4224 | 19 | DP7CMMLL5060 | 17 | DP7CMMRR6442 | 16 |
| DP7CBBFR5724 | 44 | DP7CMMFR4230 | 19 | DP7CMMLL5718 | 18 | DP7CMMRR6448 | 16 |
| DP7CBBFR5730 | 44 | DP7CMMFR4236 | 19 | DP7CMMLL5724 | 18 | DP7CMMRR6460 | 16 |
| DP7CBBFR5736 | 44 | DP7CMMFR4242 | 19 | DP7CMMLL5730 | 18 | DP7CMMRR7815 | 16 |
| DP7CBBFR5742 | 44 | DP7CMMFR4248 | 19 | DP7CMMLL5736 | 18 | DP7CMMRR7818 | 16 |
| DP7CBBFR5748 | 44 | DP7CMMFR4260 | 19 | DP7CMMLL5742 | 18 | DP7CMMRR7824 | 16 |
| DP7CBBFR5760 | 44 | DP7CMMFR5015 | 20 | DP7CMMLL5748 | 18 | DP7CMMRR7830 | 16 |
| DP7CBBFR6418 | 44 | DP7CMMFR5018 | 20 | DP7CMMLL5760 | 18 | DP7CMMRR7836 | 16 |
| DP7CBBFR6424 | 44 | DP7CMMFR5024 | 20 | DP7CMMLL6418 | 18 | DP7CMMRR7842 | 16 |
| DP7CBBFR6430 | 44 | DP7CMMFR5030 | 20 | DP7CMMLL6424 | 18 | DP7CMMRR7848 | 16 |
| DP7CBBFR6436 | 44 | DP7CMMFR5036 | 20 | DP7CMMLL6430 | 18 | DP7CMMRRWH15 | 15 |
| DP7CBBFR6442 | 44 | DP7CMMFR5042 | 20 | DP7CMMLL6436 | 18 | DP7CMMRRWH18 | 15 |
| DP7CBBFR6448 | 44 | DP7CMMFR5048 | 20 | DP7CMMLL6442 | 18 | DP7CMMRRWH24 | 15 |
| DP7CBBFR6460 | 44 | DP7CMMFR5060 | 20 | DP7CMMLL6448 | 18 | DP7CMMRRWH30 | 15 |
| DP7CBBFR7818 | 45 | DP7CMMFR5715 | 20 | DP7CMMLL6460 | 18 | DP7CMMRRWH36 | 15 |
| DP7CBBFR7824 | 45 | DP7CMMFR5718 | 20 | DP7CMMLL7818 | 18 | DP7CMMRRWH42 | 15 |
| DP7CBBFR7830 | 45 | DP7CMMFR5724 | 20 | DP7CMMLL7824 | 18 | DP7CMMRRWH48 | 15 |
| DP7CBBFR7836 | 45 | DP7CMMFR5730 | 20 | DP7CMMLL7830 | 18 | DP7CMMRRWH60 | 15 |
| DP7CBBFR7842 | 45 | DP7CMMFR5736 | 20 | DP7CMMLL7836 | 18 | DP7CPPFR4215 | 37 |
| DP7CBBFR7848 | 45 | DP7CMMFR5742 | 20 | DP7CMMLL7842 | 18 | DP7CPPFR4218 | 37 |
| DP7CBBRR4218 | 41 | DP7CMMFR5748 | 20 | DP7CMMLL7848 | 18 | DP7CPPFR4224 | 37 |
| DP7CBBRR4224 | 41 | DP7CMMFR5760 | 20 | DP7CMMLLWH18 | 17 | DP7CPPFR4230 | 37 |
| DP7CBBRR4230 | 41 | DP7CMMFR6415 | 20 | DP7CMMLLWH24 | 17 | DP7CPPFR4236 | 37 |
| DP7CBBRR4236 | 41 | DP7CMMFR6418 | 20 | DP7CMMLLWH30 | 17 | DP7CPPFR4242 | 37 |
| DP7CBBRR4242 | 41 | DP7CMMFR6424 | 20 | DP7CMMLLWH36 | 17 | DP7CPPFR4248 | 37 |
| DP7CBBRR4248 | 41 | DP7CMMFR6430 | 20 | DP7CMMLLWH42 | 17 | DP7CPPFR4260 | 37 |
| DP7CBBRR4260 | 41 | DP7CMMFR6436 | 20 | DP7CMMLLWH48 | 17 | DP7CPPFR5015 | 37 |
| DP7CBBRR5018 | 41 | DP7CMMFR6442 | 20 | DP7CMMLLWH60 | 17 | DP7CPPFR5018 | 37 |
| DP7CBBRR5024 | 41 | DP7CMMFR6448 | 20 | DP7CMMRR3615 | 15 | DP7CPPFR5024 | 37 |

| <i>pattern no.</i> | <i>page</i> | <i>pattern no.</i> | <i>page</i> | <i>pattern no.</i> | <i>page</i> | <i>pattern no.</i> | <i>page</i> |
|--------------------|-------------|--------------------|-------------|--------------------|-------------|--------------------|-------------|
| DP7CPPFR5030 | 37 | DP7CPPRR4230 | 31 | DP7CTTFR5742 | 29 | DP7CTTRR3648 | 24 |
| DP7CPPFR5036 | 37 | DP7CPPRR4236 | 31 | DP7CTTFR5748 | 29 | DP7CTTRR3660 | 24 |
| DP7CPPFR5042 | 37 | DP7CPPRR4242 | 31 | DP7CTTFR5760 | 29 | DP7CTTRR4215 | 24 |
| DP7CPPFR5048 | 37 | DP7CPPRR4248 | 31 | DP7CTTFR6415 | 30 | DP7CTTRR4218 | 24 |
| DP7CPPFR5060 | 37 | DP7CPPRR4260 | 31 | DP7CTTFR6418 | 30 | DP7CTTRR4224 | 24 |
| DP7CPPFR5715 | 38 | DP7CPPRR5015 | 31 | DP7CTTFR6424 | 30 | DP7CTTRR4230 | 24 |
| DP7CPPFR5718 | 38 | DP7CPPRR5018 | 31 | DP7CTTFR6430 | 30 | DP7CTTRR4236 | 24 |
| DP7CPPFR5724 | 38 | DP7CPPRR5024 | 31 | DP7CTTFR6436 | 30 | DP7CTTRR4242 | 24 |
| DP7CPPFR5730 | 38 | DP7CPPRR5030 | 31 | DP7CTTFR6442 | 30 | DP7CTTRR4248 | 24 |
| DP7CPPFR5736 | 38 | DP7CPPRR5036 | 31 | DP7CTTFR6448 | 30 | DP7CTTRR4260 | 24 |
| DP7CPPFR5742 | 38 | DP7CPPRR5042 | 31 | DP7CTTFR6460 | 30 | DP7CTTRR5015 | 24 |
| DP7CPPFR5748 | 38 | DP7CPPRR5048 | 31 | DP7CTTFR7815 | 30 | DP7CTTRR5018 | 24 |
| DP7CPPFR5760 | 38 | DP7CPPRR5060 | 31 | DP7CTTFR7818 | 30 | DP7CTTRR5024 | 24 |
| DP7CPPFR6415 | 38 | DP7CPPRR5715 | 32 | DP7CTTFR7824 | 30 | DP7CTTRR5030 | 24 |
| DP7CPPFR6418 | 38 | DP7CPPRR5718 | 32 | DP7CTTFR7830 | 30 | DP7CTTRR5036 | 24 |
| DP7CPPFR6424 | 38 | DP7CPPRR5724 | 32 | DP7CTTFR7836 | 30 | DP7CTTRR5042 | 24 |
| DP7CPPFR6430 | 38 | DP7CPPRR5730 | 32 | DP7CTTFR7842 | 30 | DP7CTTRR5048 | 24 |
| DP7CPPFR6436 | 38 | DP7CPPRR5736 | 32 | DP7CTTFR7848 | 30 | DP7CTTRR5060 | 24 |
| DP7CPPFR6442 | 38 | DP7CPPRR5742 | 32 | DP7CTTLL3618 | 26 | DP7CTTRR5715 | 25 |
| DP7CPPFR6448 | 38 | DP7CPPRR5748 | 32 | DP7CTTLL3624 | 26 | DP7CTTRR5718 | 25 |
| DP7CPPFR6460 | 38 | DP7CPPRR5760 | 32 | DP7CTTLL3630 | 26 | DP7CTTRR5724 | 25 |
| DP7CPPFR7815 | 39 | DP7CPPRR6415 | 32 | DP7CTTLL3636 | 26 | DP7CTTRR5730 | 25 |
| DP7CPPFR7818 | 39 | DP7CPPRR6418 | 32 | DP7CTTLL3642 | 26 | DP7CTTRR5736 | 25 |
| DP7CPPFR7824 | 39 | DP7CPPRR6424 | 32 | DP7CTTLL3648 | 26 | DP7CTTRR5742 | 25 |
| DP7CPPFR7830 | 39 | DP7CPPRR6430 | 32 | DP7CTTLL3660 | 26 | DP7CTTRR5748 | 25 |
| DP7CPPFR7836 | 39 | DP7CPPRR6436 | 32 | DP7CTTLL4218 | 26 | DP7CTTRR5760 | 25 |
| DP7CPPFR7842 | 39 | DP7CPPRR6442 | 32 | DP7CTTLL4224 | 26 | DP7CTTRR6415 | 25 |
| DP7CPPFR7848 | 39 | DP7CPPRR6448 | 32 | DP7CTTLL4230 | 26 | DP7CTTRR6418 | 25 |
| DP7CPPLL4218 | 34 | DP7CPPRR6460 | 32 | DP7CTTLL4236 | 26 | DP7CTTRR6424 | 25 |
| DP7CPPLL4224 | 34 | DP7CPPRR7815 | 33 | DP7CTTLL4242 | 26 | DP7CTTRR6430 | 25 |
| DP7CPPLL4230 | 34 | DP7CPPRR7818 | 33 | DP7CTTLL4248 | 26 | DP7CTTRR6436 | 25 |
| DP7CPPLL4236 | 34 | DP7CPPRR7824 | 33 | DP7CTTLL4260 | 26 | DP7CTTRR6442 | 25 |
| DP7CPPLL4242 | 34 | DP7CPPRR7830 | 33 | DP7CTTLL5018 | 26 | DP7CTTRR6448 | 25 |
| DP7CPPLL4248 | 34 | DP7CPPRR7836 | 33 | DP7CTTLL5024 | 26 | DP7CTTRR6460 | 25 |
| DP7CPPLL4260 | 34 | DP7CPPRR7842 | 33 | DP7CTTLL5030 | 26 | DP7CTTRR7815 | 25 |
| DP7CPPLL5018 | 34 | DP7CPPRR7848 | 33 | DP7CTTLL5036 | 26 | DP7CTTRR7818 | 25 |
| DP7CPPLL5024 | 34 | DP7CTTFR3615 | 28 | DP7CTTLL5042 | 26 | DP7CTTRR7824 | 25 |
| DP7CPPLL5030 | 34 | DP7CTTFR3618 | 28 | DP7CTTLL5048 | 26 | DP7CTTRR7830 | 25 |
| DP7CPPLL5036 | 34 | DP7CTTFR3624 | 28 | DP7CTTLL5060 | 26 | DP7CTTRR7836 | 25 |
| DP7CPPLL5042 | 34 | DP7CTTFR3630 | 28 | DP7CTTLL5718 | 27 | DP7CTTRR7842 | 25 |
| DP7CPPLL5048 | 34 | DP7CTTFR3636 | 28 | DP7CTTLL5724 | 27 | DP7CTTRR7848 | 25 |
| DP7CPPLL5060 | 34 | DP7CTTFR3642 | 28 | DP7CTTLL5730 | 27 | DP7HIRKD24 | 204 |
| DP7CPPLL5718 | 35 | DP7CTTFR3648 | 28 | DP7CTTLL5736 | 27 | DP7HIRKD30 | 204 |
| DP7CPPLL5724 | 35 | DP7CTTFR3660 | 28 | DP7CTTLL5742 | 27 | DP7HIRKD36 | 204 |
| DP7CPPLL5730 | 35 | DP7CTTFR4215 | 28 | DP7CTTLL5748 | 27 | DP7HIRKD42 | 204 |
| DP7CPPLL5736 | 35 | DP7CTTFR4218 | 28 | DP7CTTLL5760 | 27 | DP7HIRKD48 | 204 |
| DP7CPPLL5742 | 35 | DP7CTTFR4224 | 28 | DP7CTTLL6418 | 27 | DP7HIRKD60 | 204 |
| DP7CPPLL5748 | 35 | DP7CTTFR4230 | 28 | DP7CTTLL6424 | 27 | DP7HIRKS24 | 204 |
| DP7CPPLL5760 | 35 | DP7CTTFR4236 | 28 | DP7CTTLL6430 | 27 | DP7HIRKS30 | 204 |
| DP7CPPLL6418 | 35 | DP7CTTFR4242 | 28 | DP7CTTLL6436 | 27 | DP7HIRKS36 | 204 |
| DP7CPPLL6424 | 35 | DP7CTTFR4248 | 28 | DP7CTTLL6442 | 27 | DP7HIRKS42 | 204 |
| DP7CPPLL6430 | 35 | DP7CTTFR4260 | 28 | DP7CTTLL6448 | 27 | DP7HIRKS48 | 204 |
| DP7CPPLL6436 | 35 | DP7CTTFR5015 | 29 | DP7CTTLL6460 | 27 | DP7HIRKS60 | 204 |
| DP7CPPLL6442 | 35 | DP7CTTFR5018 | 29 | DP7CTTLL7818 | 27 | DP7HLCWH | 124 |
| DP7CPPLL6448 | 35 | DP7CTTFR5024 | 29 | DP7CTTLL7824 | 27 | DP7HRRKD24 | 204 |
| DP7CPPLL6460 | 35 | DP7CTTFR5030 | 29 | DP7CTTLL7830 | 27 | DP7HRRKD30 | 204 |
| DP7CPPLL7818 | 36 | DP7CTTFR5036 | 29 | DP7CTTLL7836 | 27 | DP7HRRKD36 | 204 |
| DP7CPPLL7824 | 36 | DP7CTTFR5042 | 29 | DP7CTTLL7842 | 27 | DP7HRRKD42 | 204 |
| DP7CPPLL7830 | 36 | DP7CTTFR5048 | 29 | DP7CTTLL7848 | 27 | DP7HRRKD48 | 204 |
| DP7CPPLL7836 | 36 | DP7CTTFR5060 | 29 | DP7CTTRR3615 | 24 | DP7HRRKD60 | 204 |
| DP7CPPLL7842 | 36 | DP7CTTFR5715 | 29 | DP7CTTRR3618 | 24 | DP7HRRKS24 | 204 |
| DP7CPPLL7848 | 36 | DP7CTTFR5718 | 29 | DP7CTTRR3624 | 24 | DP7HRRKS30 | 204 |
| DP7CPPRR4215 | 31 | DP7CTTFR5724 | 29 | DP7CTTRR3630 | 24 | DP7HRRKS36 | 204 |
| DP7CPPRR4218 | 31 | DP7CTTFR5730 | 29 | DP7CTTRR3636 | 24 | DP7HRRKS42 | 204 |
| DP7CPPRR4224 | 31 | DP7CTTFR5736 | 29 | DP7CTTRR3642 | 24 | DP7HRRKS48 | 204 |

| <i>pattern no.</i> | <i>page</i> | <i>pattern no.</i> | <i>page</i> | <i>pattern no.</i> | <i>page</i> | <i>pattern no.</i> | <i>page</i> |
|--------------------|-------------|--------------------|--------------------|--------------------|-------------|--------------------|-------------|
| DP7HRRKS60 | 204 | DP7PO42 | 124 | DPRD15742(L/R)L | 101 | DS1O42L | 211 |
| DP7PA362 | 121 | DP7PO42CPF | 152 | DPRD15742(L/R)N | 101 | DS1O48L | 211 |
| DP7PA363 | 121 | DP7PO50 | 124 | DPRD15748(L/R)L | 101 | DS1O54L | 211 |
| DP7PA364 | 121 | DP7PO50CPF | 152 | DPRD15748(L/R)N | 101 | DS1O60L | 211 |
| DP7PA422 | 121 | DP7PO57 | 124 | DPRD16436(L/R)L | 101 | DS1O66L | 211 |
| DP7PA423 | 121 | DP7PO57CPF | 152 | DPRD16436(L/R)N | 101 | DS1O72L | 211 |
| DP7PA424 | 121 | DP7PO64 | 124 | DPRD16442(L/R)L | 101 | DS1PBD | 243, 373 |
| DP7PA502 | 121 | DP7PO64CPF | 152 | DPRD16442(L/R)N | 101 | DS1PCD | 243, 373 |
| DP7PA503 | 121 | DP7PO78 | 124 | DPRD16448(L/R)L | 101 | DS1PF L18A | 237 |
| DP7PA504 | 121 | DP7POWH | 124 | DPRD16448(L/R)N | 101 | DS1PF L18B | 237 |
| DP7PA572 | 121 | DP7POWHCPF | 152 | DPRD17836(L/R)L | 101 | DS1PF L24A | 237 |
| DP7PA573 | 121 | DP7PP36S | 200 | DPRD17836(L/R)N | 101 | DS1PF L24B | 237 |
| DP7PA574 | 121 | DP7PP36T | 200 | DPRD17842(L/R)L | 101 | DS1PF L30A | 237 |
| DP7PA642 | 121 | DP7PP42S | 200 | DPRD17842(L/R)N | 101 | DS1PF L30B | 237 |
| DP7PA643 | 121 | DP7PP42T | 200 | DPRD17848(L/R)L | 101 | DS1PFD | 243, 373 |
| DP7PA644 | 121 | DP7PP50S | 200 | DPRD17848(L/R)N | 101 | DS1PFS | 243, 373 |
| DP7PA782 | 121 | DP7PP50T | 200 | DPRD1J1PM | 102 | DS1PM L18A | 237 |
| DP7PA783 | 121 | DP7PP57S | 200 | DPRD1SSB | 102 | DS1PM L18B | 237 |
| DP7PA784 | 121 | DP7PP57T | 200 | DPS7V1418 | 54 | DS1PM L18F | 237 |
| DP7PAWH2 | 121 | DP7PP64S | 200 | DPS7V1424 | 54 | DS1PM L24A | 237 |
| DP7PAWH3 | 121 | DP7PP64T | 200 | DPS7V1430 | 54 | DS1PM L24B | 237 |
| DP7PAWH4 | 121 | DP7PP78S | 200 | DPS7V1436 | 54 | DS1PM L24F | 237 |
| DP7PC07 | 125 | DP7PP78T | 200 | DPS7V1442 | 54 | DS1PST | 243, 373 |
| DP7PC07UH | 126 | DP7PT1 | 124 | DPS7V1448 | 54 | DS1S 24 | 229 |
| DP7PC14 | 125, 126 | DP7PT2 | 124 | DPS7V2118 | 54 | DS1S 30 | 229 |
| DP7PC14UH | 126 | DP7PT3 | 124 | DPS7V2124 | 54 | DS1S 36 | 229 |
| DP7PC21 | 125 | DP7PT4 | 124 | DPS7V2130 | 54 | DS1S 42 | 229 |
| DP7PC21UH | 126 | DP7PTCP | 152 | DPS7V2136 | 54 | DS1S 48 | 229 |
| DP7PC28 | 125 | DP7PTCPH | 152 | DPS7V2142 | 54 | DS1S 54 | 229 |
| DP7PC28UH | 126 | DP7PTS | 124 | DPS7V2148 | 54 | DS1S 60 | 229 |
| DP7PC36 | 125 | DP7RCCH24 | 204 | DPS7V2818 | 54 | DS1S 66 | 229 |
| DP7PC362 | 125 | DP7RCCH30 | 204 | DPS7V2824 | 54 | DS1S 72 | 229 |
| DP7PC36U | 126 | DP7RCCH36 | 204 | DPS7V2830 | 54 | DS1SWM 30 | 231 |
| DP7PC36UH | 126 | DP7RCCH42 | 204 | DPS7V2836 | 54 | DS1SWM 36 | 231 |
| DP7PC42 | 125 | DP7RCCH48 | 204 | DPS7V2842 | 54 | DS1SWM 42 | 231 |
| DP7PC422 | 125 | DP7RCCH60 | 204 | DPS7V2848 | 54 | DS1SWM 48 | 231 |
| DP7PC42U | 126 | DP7S | 108, 109, 110, 111 | DS1 OHL | 232 | DS1WM 24 | 231 |
| DP7PC50 | 125 | DP7SPO14 | 124 | DS1 VD | 232, 267 | DS1WM 30 | 231 |
| DP7PC502 | 125 | DP7SPO21 | 124 | DS1BS 24 | 231 | DS1WM 36 | 231 |
| DP7PC50U | 126 | DP7SPO28 | 124 | DS1BS 30 | 231 | DS1WM 42 | 231 |
| DP7PC57 | 125 | DP7SS | 114, 115 | DS1BS 36 | 231 | DS1WM 48 | 231 |
| DP7PC572 | 125 | DP7SSWT1424 | 113 | DS1BS 42 | 231 | DS2DW 30L | 240 |
| DP7PC57U | 126 | DP7SSWT1430 | 113 | DS1BS 48 | 231 | DS2DW 36L | 240 |
| DP7PC64 | 125 | DP7SSWT1436 | 113 | DS1BS 54 | 231 | DS2DWDPL30 | 243 |
| DP7PC642 | 125 | DP7SSWT1442 | 113 | DS1BS 60 | 231 | DS2DWDPL36 | 243 |
| DP7PC64U | 126 | DP7SSWT1448 | 113 | DS1BS 66 | 231 | DS2LKKT | 243 |
| DP7PC78 | 125 | DP7SSWT2124 | 113 | DS1BS 72 | 231 | DS2OD 36L | 267 |
| DP7PC782 | 125 | DP7SSWT2130 | 113 | DS1CS 36 | 229 | DS2OD 42L | 267 |
| DP7PC78U | 126 | DP7SSWT2136 | 113 | DS1CS 42 | 229 | DS2OD 48L | 267 |
| DP7PCWH | 125 | DP7SSWT2142 | 113 | DS1CS 48 | 229 | DS2OD 54L | 267 |
| DP7PCWH2 | 125 | DP7SSWT2148 | 113 | DS1DW 30L | 237 | DS2OD 60L | 267 |
| DP7PCWH42 | 125 | DP7SSWT2824 | 113 | DS1DWDPL | 243 | DS2OD 66L | 267 |
| DP7PCWH50 | 125 | DP7SSWT2830 | 113 | DS1E30L | 227 | DS2OD 72L | 267 |
| DP7PCWH57 | 125 | DP7SSWT2836 | 113 | DS1E36L | 227 | DS2PF L18A | 239 |
| DP7PCWH64 | 125 | DP7SSWT2842 | 113 | DS1E42L | 227 | DS2PF L18B | 239 |
| DP7PCWH78 | 125 | DP7SSWT2848 | 113 | DS1E48L | 227 | DS2PF L24A | 239 |
| DP7PCWHS14 | 125 | DP7SWT | 106, 107 | DS1E54L | 227 | DS2PF L24B | 239 |
| DP7PCWHS142 | 125 | DP7SWTFK24 | 107 | DS1E60L | 227 | DS2PF L30A | 239 |
| DP7PCWHS21 | 125 | DP7SWTFK30 | 107 | DS1E66L | 227 | DS2PF L30B | 239 |
| DP7PCWHS212 | 125 | DP7SWTFK36 | 107 | DS1E72L | 227 | DS2PM L18A | 239 |
| DP7PCWHS28 | 125 | DP7SWTFK42 | 107 | DS1EAKIT | 211 | DS2PM L18B | 239 |
| DP7PCWHS282 | 125 | DP7SWTFK48 | 107 | DS1LKKT | 243 | DS2PM L18F | 239 |
| DP7PCWHU | 126 | DP7SWTFKD | 107 | DS1O24L | 211 | DS2PM L24A | 239 |
| DP7PO36 | 124 | DPRD15736(L/R)L | 101 | DS1O30L | 211 | DS2PM L24B | 239 |
| DP7PO36CPF | 152 | DPRD15736(L/R)N | 101 | DS1O36L | 211 | DS2PM L24F | 239 |

| <i>pattern no.</i> | <i>page</i> | <i>pattern no.</i> | <i>page</i> | <i>pattern no.</i> | <i>page</i> | <i>pattern no.</i> | <i>page</i> |
|--------------------|--------------------|--------------------|--------------------|--------------------|--------------------|--------------------|-------------|
| DS2PM24L | 211 | DS3ODNS1644214T | 284 | DS3ODSL2647221FLT | 286 | DS3ODSV1574814L | 271 |
| DS2PM30L | 211 | DS3ODNS1644814 | 274 | DS3ODSS | 273, 278, 283, 288 | DS3ODSV1574814LT | 280 |
| DS2PM36L | 211 | DS3ODNS1644814T | 284 | DS3ODSS1573014L | 271 | DS3ODSV1576014L | 271 |
| DS2PM42L | 211 | DS3ODNS1646014 | 274 | DS3ODSS1573014LT | 279 | DS3ODSV1576014LT | 280 |
| DS2PM48L | 211 | DS3ODNS1646014T | 284 | DS3ODSS1573614L | 271 | DS3ODSV1576614L | 271 |
| DS2PM54L | 211 | DS3ODNS1646614 | 274 | DS3ODSS1573614LT | 279 | DS3ODSV1576614LT | 280 |
| DS2PM60L | 211 | DS3ODNS1646614T | 284 | DS3ODSS1574214L | 271 | DS3ODSV1577214L | 271 |
| DS2PM66L | 211 | DS3ODNS1647214 | 274 | DS3ODSS1574214LT | 279 | DS3ODSV1577214LT | 280 |
| DS2PM72L | 211 | DS3ODNS1647214T | 284 | DS3ODSS1574814L | 271 | DS3ODSV1643014L | 275 |
| DS2PPTC | 243, 373 | DS3ODSL | 273, 278, 283, 288 | DS3ODSS1574814LT | 279 | DS3ODSV1643014LT | 285 |
| DS2PPTN | 243, 373 | DS3ODSL1573014L | 271 | DS3ODSS1576014L | 271 | DS3ODSV1643614L | 275 |
| DS2UM30L | 227 | DS3ODSL1573014LT | 279 | DS3ODSS1576014LT | 279 | DS3ODSV1643614LT | 285 |
| DS2UM36L | 227 | DS3ODSL1573614L | 271 | DS3ODSS1576614L | 271 | DS3ODSV1644214L | 275 |
| DS2UM42L | 227 | DS3ODSL1573614LT | 279 | DS3ODSS1576614LT | 279 | DS3ODSV1644214LT | 285 |
| DS2UM48L | 227 | DS3ODSL1574214L | 271 | DS3ODSS1577214L | 271 | DS3ODSV1644814L | 275 |
| DS2UM54L | 227 | DS3ODSL1574214LT | 279 | DS3ODSS1577214LT | 279 | DS3ODSV1644814LT | 285 |
| DS2UM60L | 227 | DS3ODSL1574814L | 271 | DS3ODSS1643014L | 274 | DS3ODSV1646014L | 275 |
| DS2UM66L | 227 | DS3ODSL1574814LT | 279 | DS3ODSS1643014LT | 284 | DS3ODSV1646014LT | 285 |
| DS2UM72L | 227 | DS3ODSL1576014L | 271 | DS3ODSS1643614L | 274 | DS3ODSV1646614L | 275 |
| DS2XPB | 239 | DS3ODSL1576014LT | 279 | DS3ODSS1643614LT | 284 | DS3ODSV1646614LT | 285 |
| DS3CMN3614 | 223 | DS3ODSL1576614L | 271 | DS3ODSS1644214L | 274 | DS3ODSV1647214L | 275 |
| DS3CMN4214 | 223 | DS3ODSL1576614LT | 279 | DS3ODSS1644214LT | 284 | DS3ODSV1647214LT | 285 |
| DS3CMN4814 | 223 | DS3ODSL1577214L | 271 | DS3ODSS1644814L | 274 | DS3ODSV2573021FL | 272 |
| DS3CMN6014 | 223 | DS3ODSL1577214LT | 279 | DS3ODSS1644814LT | 284 | DS3ODSV2573021FLT | 282 |
| DS3CMN7214 | 223 | DS3ODSL1643014L | 274 | DS3ODSS1646014L | 274 | DS3ODSV2573621FL | 272 |
| DS3CMSL3614L | 224 | DS3ODSL1643014LT | 284 | DS3ODSS1646014LT | 284 | DS3ODSV2573621FLT | 282 |
| DS3CMSL4214L | 224 | DS3ODSL1643614L | 274 | DS3ODSS1646614L | 274 | DS3ODSV2574221FL | 272 |
| DS3CMSL4814L | 224 | DS3ODSL1643614LT | 284 | DS3ODSS1646614LT | 284 | DS3ODSV2574221FLT | 282 |
| DS3CMSL6014L | 224 | DS3ODSL1644214L | 274 | DS3ODSS1647214L | 274 | DS3ODSV2574821FL | 272 |
| DS3CMSL7214L | 224 | DS3ODSL1644214LT | 284 | DS3ODSS1647214LT | 284 | DS3ODSV2574821FLT | 282 |
| DS3CMSS3614L | 223 | DS3ODSL1644814L | 274 | DS3ODSS2573021FL | 272 | DS3ODSV2576021FL | 272 |
| DS3CMSS4214L | 223 | DS3ODSL1644814LT | 284 | DS3ODSS2573021FLT | 281 | DS3ODSV2576021FLT | 282 |
| DS3CMSS4814L | 223 | DS3ODSL1646014L | 274 | DS3ODSS2573621FL | 272 | DS3ODSV2576621FL | 272 |
| DS3CMSS6014L | 223 | DS3ODSL1646014LT | 284 | DS3ODSS2573621FLT | 281 | DS3ODSV2576621FLT | 282 |
| DS3CMSS7214L | 223 | DS3ODSL1646614L | 274 | DS3ODSS2574221FL | 272 | DS3ODSV2577221FL | 272 |
| DS3CMSSV3614L | 224 | DS3ODSL1646614LT | 284 | DS3ODSS2574221FLT | 281 | DS3ODSV2577221FLT | 282 |
| DS3CMSSV4214L | 224 | DS3ODSL1647214L | 274 | DS3ODSS2574821FL | 272 | DS3ODSV2643021FL | 277 |
| DS3CMSSV4814L | 224 | DS3ODSL1647214LT | 284 | DS3ODSS2574821FLT | 281 | DS3ODSV2643021FLT | 287 |
| DS3CMSSV6014L | 224 | DS3ODSL2573021FL | 272 | DS3ODSS2576021FL | 272 | DS3ODSV2643621FL | 277 |
| DS3CMSSV7214L | 224 | DS3ODSL2573021FLT | 281 | DS3ODSS2576021FLT | 281 | DS3ODSV2643621FLT | 287 |
| DS3CMT(S/G)3614L | 223 | DS3ODSL2573621FL | 272 | DS3ODSS2576621FL | 272 | DS3ODSV2644221FL | 277 |
| DS3CMT(S/G)4214L | 223 | DS3ODSL2573621FLT | 281 | DS3ODSS2576621FLT | 281 | DS3ODSV2644221FLT | 287 |
| DS3CMT(S/G)4814L | 223 | DS3ODSL2574221FL | 272 | DS3ODSS2577221FL | 272 | DS3ODSV2644821FL | 277 |
| DS3CMT(S/G)6014L | 223 | DS3ODSL2574221FLT | 281 | DS3ODSS2577221FLT | 281 | DS3ODSV2644821FLT | 287 |
| DS3CMT(S/G)7214L | 223 | DS3ODSL2574821FL | 272 | DS3ODSS2643021FL | 276 | DS3ODSV2646021FL | 277 |
| DS3ODNS | 272, 276, 281, 286 | DS3ODSL2574821FLT | 281 | DS3ODSS2643021FLT | 286 | DS3ODSV2646021FLT | 287 |
| DS3ODNS1573014 | 271 | DS3ODSL2576021FL | 272 | DS3ODSS2643621FL | 276 | DS3ODSV2646621FL | 277 |
| DS3ODNS1573014T | 279 | DS3ODSL2576021FLT | 281 | DS3ODSS2643621FLT | 286 | DS3ODSV2646621FLT | 287 |
| DS3ODNS1573614 | 271 | DS3ODSL2576621FL | 272 | DS3ODSS2644221FL | 276 | DS3ODSV2647221FL | 277 |
| DS3ODNS1573614T | 279 | DS3ODSL2576621FLT | 281 | DS3ODSS2644221FLT | 286 | DS3ODSV2647221FLT | 287 |
| DS3ODNS1574214 | 271 | DS3ODSL2577221FL | 272 | DS3ODSS2644821FL | 276 | DS3PML30L | 212 |
| DS3ODNS1574214T | 279 | DS3ODSL2577221FLT | 281 | DS3ODSS2644821FLT | 286 | DS3PML36L | 212 |
| DS3ODNS1574814 | 271 | DS3ODSL2643021FL | 276 | DS3ODSS2646021FL | 276 | DS3PML42L | 212 |
| DS3ODNS1574814T | 279 | DS3ODSL2643021FLT | 286 | DS3ODSS2646021FLT | 286 | DS3PML48L | 212 |
| DS3ODNS1576014 | 271 | DS3ODSL2643621FL | 276 | DS3ODSS2646621FL | 276 | DS3PML60L | 212 |
| DS3ODNS1576014T | 279 | DS3ODSL2643621FLT | 286 | DS3ODSS2646621FLT | 286 | DS3PML66L | 212 |
| DS3ODNS1576614 | 271 | DS3ODSL2644221FL | 276 | DS3ODSS2647221FL | 276 | DS3PML72L | 212 |
| DS3ODNS1576614T | 279 | DS3ODSL2644221FLT | 286 | DS3ODSS2647221FLT | 286 | DS3PMNS3014 | 215 |
| DS3ODNS1577214 | 271 | DS3ODSL2644821FL | 276 | DS3ODSV | 273, 278, 283, 288 | DS3PMNS3021 | 217 |
| DS3ODNS1577214T | 279 | DS3ODSL2644821FLT | 286 | DS3ODSV1573014L | 271 | DS3PMNS3614 | 215 |
| DS3ODNS1643014 | 274 | DS3ODSL2646021FL | 276 | DS3ODSV1573014LT | 280 | DS3PMNS3621 | 217 |
| DS3ODNS1643014T | 284 | DS3ODSL2646021FLT | 286 | DS3ODSV1573614L | 271 | DS3PMNS4214 | 215 |
| DS3ODNS1643614 | 274 | DS3ODSL2646621FL | 276 | DS3ODSV1573614LT | 280 | DS3PMNS4221 | 217 |
| DS3ODNS1643614T | 284 | DS3ODSL2646621FLT | 286 | DS3ODSV1574214L | 271 | DS3PMNS4814 | 215 |
| DS3ODNS1644214 | 274 | DS3ODSL2647221FL | 276 | DS3ODSV1574214LT | 280 | DS3PMNS4821 | 217 |

| <i>pattern no.</i> | <i>page</i> | <i>pattern no.</i> | <i>page</i> | <i>pattern no.</i> | <i>page</i> | <i>pattern no.</i> | <i>page</i> |
|--------------------|-------------|--------------------|-------------|--------------------|-------------|--------------------|-------------|
| DS3PMNS6014 | 215 | DS3PMSV4821FL | 217 | DS3WMSV4814L | 219 | DS4LC1BSS60L | 245 |
| DS3PMNS6021 | 217 | DS3PMSV4821PL | 218 | DS3WMSV6014L | 219 | DS4LC1BSS66L | 245 |
| DS3PMNS6614 | 215 | DS3PMSV6014L | 216 | DS3WMSV7214L | 219 | DS4LC1BSS72L | 245 |
| DS3PMNS6621 | 217 | DS3PMSV6021FL | 217 | DS3WMT(S/G)3614L | 220 | DS4LC1BSV30L | 252 |
| DS3PMNS7214 | 215 | DS3PMSV6021PL | 218 | DS3WMT(S/G)4214L | 220 | DS4LC1BSV36L | 252 |
| DS3PMNS7221 | 217 | DS3PMSV6614L | 216 | DS3WMT(S/G)4814L | 220 | DS4LC1BSV42L | 252 |
| DS3PMS30L | 211 | DS3PMSV6621FL | 217 | DS3WMT(S/G)6014L | 220 | DS4LC1BSV48L | 252 |
| DS3PMS36L | 211 | DS3PMSV6621PL | 218 | DS3WMT(S/G)7214L | 220 | DS4LC1BSV54L | 252 |
| DS3PMS42L | 211 | DS3PMSV7214L | 216 | DS4LC1ANL24N | 248 | DS4LC1BSV60L | 252 |
| DS3PMS48L | 211 | DS3PMSV7221FL | 217 | DS4LC1ANL30N | 248 | DS4LC1BSV66L | 252 |
| DS3PMS60L | 211 | DS3PMSV7221PL | 218 | DS4LC1ANL36N | 248 | DS4LC1BSV72L | 252 |
| DS3PMS66L | 211 | DS3PMT(S/G)3614L | 215 | DS4LC1ANL42N | 248 | DS4LC1BVL30L | 249 |
| DS3PMS72L | 211 | DS3PMT(S/G)4214L | 215 | DS4LC1ANL48N | 248 | DS4LC1BVL36L | 249 |
| DS3PMSL3014L | 215 | DS3PMT(S/G)4814L | 215 | DS4LC1ANL54N | 248 | DS4LC1BVL42L | 249 |
| DS3PMSL3021FL | 217 | DS3PMT(S/G)6014L | 215 | DS4LC1ANL60N | 248 | DS4LC1BVL48L | 249 |
| DS3PMSL3021PL | 218 | DS3PMT(S/G)7214L | 215 | DS4LC1ANL66N | 248 | DS4LC1BVL54L | 249 |
| DS3PMSL3614L | 215 | DS3PMV30L | 212 | DS4LC1ANL72N | 248 | DS4LC1BVL60L | 249 |
| DS3PMSL3621FL | 217 | DS3PMV36L | 212 | DS4LC1ANS42N | 245 | DS4LC1BVL66L | 249 |
| DS3PMSL3621PL | 218 | DS3PMV42L | 212 | DS4LC1ANS48N | 245 | DS4LC1BVL72L | 249 |
| DS3PMSL4214L | 215 | DS3PMV48L | 212 | DS4LC1ANS54N | 245 | DS4LC1BVS42L | 245 |
| DS3PMSL4221FL | 217 | DS3PMV60L | 212 | DS4LC1ANS60N | 245 | DS4LC1BVS48L | 245 |
| DS3PMSL4221PL | 218 | DS3PMV66L | 212 | DS4LC1ANS66N | 245 | DS4LC1BVS54L | 245 |
| DS3PMSL4814L | 215 | DS3PMV72L | 212 | DS4LC1ANS72N | 245 | DS4LC1BVS60L | 245 |
| DS3PMSL4821FL | 217 | DS3SMN3614 | 221 | DS4LC1ANV24N | 252 | DS4LC1BVS66L | 245 |
| DS3PMSL4821PL | 218 | DS3SMN4214 | 221 | DS4LC1ANV30N | 252 | DS4LC1BVS72L | 245 |
| DS3PMSL6014L | 215 | DS3SMN4814 | 221 | DS4LC1ANV36N | 252 | DS4LC1BVS72L | 245 |
| DS3PMSL6021FL | 217 | DS3SMN6014 | 221 | DS4LC1ANV42N | 252 | DS4LC1BVS72L | 245 |
| DS3PMSL6021PL | 218 | DS3SMN7214 | 221 | DS4LC1ANV48N | 252 | DS4LC1BVS72L | 245 |
| DS3PMSL6614L | 215 | DS3SMSL3614L | 221 | DS4LC1ANV54N | 252 | DS4LC1BVS72L | 245 |
| DS3PMSL6621FL | 217 | DS3SMSL4214L | 221 | DS4LC1ANV60N | 252 | DS4LC1BVS72L | 245 |
| DS3PMSL6621PL | 218 | DS3SMSL4814L | 221 | DS4LC1ANV66N | 252 | DS4LC1BVS72L | 245 |
| DS3PMSL7214L | 215 | DS3SMSL6014L | 221 | DS4LC1ANV72N | 252 | DS4LC1BVS72L | 245 |
| DS3PMSL7221FL | 217 | DS3SMSL7214L | 221 | DS4LC1BLL30L | 248 | DS4LC1BVS72L | 245 |
| DS3PMSL7221PL | 218 | DS3SMSS3614L | 221 | DS4LC1BLL36L | 248 | DS4LC1BVS72L | 245 |
| DS3PMSS3014L | 215 | DS3SMSS4214L | 221 | DS4LC1BLL42L | 248 | DS4LC1BVS72L | 245 |
| DS3PMSS3021FL | 217 | DS3SMSS4814L | 221 | DS4LC1BLL48L | 248 | DS4LC1BVS72L | 245 |
| DS3PMSS3021PL | 218 | DS3SMSS6014L | 221 | DS4LC1BLL54L | 248 | DS4LC1BVS72L | 245 |
| DS3PMSS3614L | 215 | DS3SMSS7214L | 221 | DS4LC1BLL60L | 248 | DS4LC1BVS72L | 245 |
| DS3PMSS3621FL | 217 | DS3SMSV3614L | 222 | DS4LC1BLL66L | 248 | DS4LC1BVS72L | 245 |
| DS3PMSS3621PL | 218 | DS3SMSV4214L | 222 | DS4LC1BLL72L | 248 | DS4LC1BVS72L | 245 |
| DS3PMSS4214L | 215 | DS3SMSV4814L | 222 | DS4LC1BLS42L | 245 | DS4LC1BVS72L | 245 |
| DS3PMSS4221FL | 217 | DS3SMSV6014L | 222 | DS4LC1BLS48L | 245 | DS4LC1BVS72L | 245 |
| DS3PMSS4221PL | 218 | DS3SMSV7214L | 222 | DS4LC1BLS54L | 245 | DS4LC1BVS72L | 245 |
| DS3PMSS4814L | 215 | DS3SMT(S/G)3614L | 221 | DS4LC1BLS60L | 245 | DS4LC1BVS72L | 245 |
| DS3PMSS4821FL | 217 | DS3SMT(S/G)4214L | 221 | DS4LC1BLS66L | 245 | DS4LC1BVS72L | 245 |
| DS3PMSS4821PL | 218 | DS3SMT(S/G)4814L | 221 | DS4LC1BLS72L | 245 | DS4LC1BVS72L | 245 |
| DS3PMSS6014L | 215 | DS3SMT(S/G)6014L | 221 | DS4LC1BLV30L | 252 | DS4LC1BVS72L | 245 |
| DS3PMSS6021FL | 217 | DS3SMT(S/G)7214L | 221 | DS4LC1BLV36L | 252 | DS4LC1BVS72L | 245 |
| DS3PMSS6021PL | 218 | DS3WMN3614 | 219 | DS4LC1BLV42L | 252 | DS4LC1BVS72L | 245 |
| DS3PMSS6614L | 215 | DS3WMN4214 | 219 | DS4LC1BLV48L | 252 | DS4LC1BVS72L | 245 |
| DS3PMSS6621FL | 217 | DS3WMN4814 | 219 | DS4LC1BLV54L | 252 | DS4LC1BVS72L | 245 |
| DS3PMSS6621PL | 218 | DS3WMN6014 | 219 | DS4LC1BLV60L | 252 | DS4LC1BVS72L | 245 |
| DS3PMSS7214L | 215 | DS3WMN7214 | 219 | DS4LC1BLV66L | 252 | DS4LC1BVS72L | 245 |
| DS3PMSS7221FL | 217 | DS3WMSL3614L | 219 | DS4LC1BLV72L | 252 | DS4LC1BVS72L | 245 |
| DS3PMSS7221PL | 218 | DS3WMSL4214L | 219 | DS4LC1BSL30L | 248 | DS4LC1BVS72L | 245 |
| DS3PMSV3014L | 216 | DS3WMSL4814L | 219 | DS4LC1BSL36L | 248 | DS4LC1BVS72L | 245 |
| DS3PMSV3021FL | 217 | DS3WMSL6014L | 219 | DS4LC1BSL42L | 248 | DS4LC1BVS72L | 245 |
| DS3PMSV3021PL | 218 | DS3WMSL7214L | 219 | DS4LC1BSL48L | 248 | DS4LC1BVS72L | 245 |
| DS3PMSV3614L | 216 | DS3WMSS3614L | 219 | DS4LC1BSL54L | 248 | DS4LC1BVS72L | 245 |
| DS3PMSV3621FL | 217 | DS3WMSS4214L | 219 | DS4LC1BSL60L | 248 | DS4LC1BVS72L | 245 |
| DS3PMSV3621PL | 218 | DS3WMSS4814L | 219 | DS4LC1BSL66L | 248 | DS4LC1BVS72L | 245 |
| DS3PMSV4214L | 216 | DS3WMSS6014L | 219 | DS4LC1BSL72L | 248 | DS4LC1BVS72L | 245 |
| DS3PMSV4221FL | 217 | DS3WMSS7214L | 219 | DS4LC1BSS42L | 245 | DS4LC1BVS72L | 245 |
| DS3PMSV4221PL | 218 | DS3WMSV3614L | 219 | DS4LC1BSS48L | 245 | DS4LC1BVS72L | 245 |
| DS3PMSV4814L | 216 | DS3WMSV4214L | 219 | DS4LC1BSS54L | 245 | DS4LC1BVS72L | 245 |

| <i>pattern no.</i> | <i>page</i> | <i>pattern no.</i> | <i>page</i> | <i>pattern no.</i> | <i>page</i> | <i>pattern no.</i> | <i>page</i> |
|--------------------|-------------|--------------------|-------------|--------------------|-------------|--------------------|-------------|
| DS4LC1CSS54L | 246 | DS4LC1DSS48L | 247 | DS4LC2BLV54L | 261 | DS4LC2CSV60L | 263 |
| DS4LC1CSS60L | 246 | DS4LC1DSS54L | 247 | DS4LC2BLV60L | 261 | DS4LC2CSV66L | 263 |
| DS4LC1CSS66L | 246 | DS4LC1DSS60L | 247 | DS4LC2BLV66L | 261 | DS4LC2CSV72L | 263 |
| DS4LC1CSS72L | 246 | DS4LC1DSS66L | 247 | DS4LC2BLV72L | 261 | DS4LC2CVL30L | 259 |
| DS4LC1CSV30L | 254 | DS4LC1DSS72L | 247 | DS4LC2BSL30L | 257 | DS4LC2CVL36L | 259 |
| DS4LC1CSV36L | 254 | DS4LC1DSV30L | 255 | DS4LC2BSL36L | 257 | DS4LC2CVL42L | 259 |
| DS4LC1CSV42L | 254 | DS4LC1DSV36L | 255 | DS4LC2BSLA2L | 257 | DS4LC2CVL48L | 259 |
| DS4LC1CSV48L | 254 | DS4LC1DSV42L | 255 | DS4LC2BSLA8L | 257 | DS4LC2CVL54L | 259 |
| DS4LC1CSV54L | 254 | DS4LC1DSV48L | 255 | DS4LC2BSL54L | 257 | DS4LC2CVL60L | 259 |
| DS4LC1CSV60L | 254 | DS4LC1DSV54L | 255 | DS4LC2BSL60L | 257 | DS4LC2CVL66L | 259 |
| DS4LC1CSV66L | 254 | DS4LC1DSV60L | 255 | DS4LC2BSL66L | 257 | DS4LC2CVL72L | 259 |
| DS4LC1CSV72L | 254 | DS4LC1DSV66L | 255 | DS4LC2BSL72L | 257 | DS4LC2CVV30L | 263 |
| DS4LC1CVL30L | 250 | DS4LC1DSV72L | 255 | DS4LC2BSV30L | 261 | DS4LC2CVV36L | 263 |
| DS4LC1CVL36L | 250 | DS4LC1DVL30L | 251 | DS4LC2BSV36L | 261 | DS4LC2CVV42L | 263 |
| DS4LC1CVL42L | 250 | DS4LC1DVL36L | 251 | DS4LC2BSV42L | 261 | DS4LC2CVV48L | 263 |
| DS4LC1CVL48L | 250 | DS4LC1DVL42L | 251 | DS4LC2BSV48L | 261 | DS4LC2CVV54L | 263 |
| DS4LC1CVL54L | 250 | DS4LC1DVL48L | 251 | DS4LC2BSV54L | 261 | DS4LC2CVV60L | 263 |
| DS4LC1CVL60L | 250 | DS4LC1DVL54L | 251 | DS4LC2BSV60L | 261 | DS4LC2CVV66L | 263 |
| DS4LC1CVL66L | 250 | DS4LC1DVL60L | 251 | DS4LC2BSV66L | 261 | DS4LC2CVV72L | 263 |
| DS4LC1CVL72L | 250 | DS4LC1DVL66L | 251 | DS4LC2BSV72L | 261 | DS4LC2DLL30L | 260 |
| DS4LC1CVS42L | 246 | DS4LC1DVL72L | 251 | DS4LC2BVL30L | 258 | DS4LC2DLL36L | 260 |
| DS4LC1CVS48L | 246 | DS4LC1DVS42L | 247 | DS4LC2BVL36L | 258 | DS4LC2DLL42L | 260 |
| DS4LC1CVS54L | 246 | DS4LC1DVS48L | 247 | DS4LC2BVL42L | 258 | DS4LC2DLL48L | 260 |
| DS4LC1CVS60L | 246 | DS4LC1DVS54L | 247 | DS4LC2BVL48L | 258 | DS4LC2DLL54L | 260 |
| DS4LC1CVS66L | 246 | DS4LC1DVS60L | 247 | DS4LC2BVL54L | 258 | DS4LC2DLL60L | 260 |
| DS4LC1CVS72L | 246 | DS4LC1DVS66L | 247 | DS4LC2BVL60L | 258 | DS4LC2DLL66L | 260 |
| DS4LC1CVV30L | 254 | DS4LC1DVS72L | 247 | DS4LC2BVL66L | 258 | DS4LC2DLL72L | 260 |
| DS4LC1CVV36L | 254 | DS4LC1DVV30L | 255 | DS4LC2BVL72L | 258 | DS4LC2DLV30L | 264 |
| DS4LC1CVV42L | 254 | DS4LC1DVV36L | 255 | DS4LC2BVV30L | 262 | DS4LC2DLV36L | 264 |
| DS4LC1CVV48L | 254 | DS4LC1DVV42L | 255 | DS4LC2BVV36L | 262 | DS4LC2DLV42L | 264 |
| DS4LC1CVV54L | 254 | DS4LC1DVV48L | 255 | DS4LC2BVV42L | 262 | DS4LC2DLV48L | 264 |
| DS4LC1CVV60L | 254 | DS4LC1DVV54L | 255 | DS4LC2BVV48L | 262 | DS4LC2DLV54L | 264 |
| DS4LC1CVV66L | 254 | DS4LC1DVV60L | 255 | DS4LC2BVV54L | 262 | DS4LC2DLV60L | 264 |
| DS4LC1CVV72L | 254 | DS4LC1DVV66L | 255 | DS4LC2BVV60L | 262 | DS4LC2DLV66L | 264 |
| DS4LC1DLL30L | 251 | DS4LC1DVV72L | 255 | DS4LC2BVV66L | 262 | DS4LC2DLV72L | 264 |
| DS4LC1DLL36L | 251 | DS4LC2ANL24N | 257 | DS4LC2BVV72L | 262 | DS4LC2DSL30L | 260 |
| DS4LC1DLL42L | 251 | DS4LC2ANL30N | 257 | DS4LC2CLL30L | 259 | DS4LC2DSL36L | 260 |
| DS4LC1DLL48L | 251 | DS4LC2ANL36N | 257 | DS4LC2CLL36L | 259 | DS4LC2DSL42L | 260 |
| DS4LC1DLL54L | 251 | DS4LC2ANL42N | 257 | DS4LC2CLLA2L | 259 | DS4LC2DSL48L | 260 |
| DS4LC1DLL60L | 251 | DS4LC2ANL48N | 257 | DS4LC2CLLA8L | 259 | DS4LC2DSL54L | 260 |
| DS4LC1DLL66L | 251 | DS4LC2ANL54N | 257 | DS4LC2CLL54L | 259 | DS4LC2DSL60L | 260 |
| DS4LC1DLL72L | 251 | DS4LC2ANL60N | 257 | DS4LC2CLL60L | 259 | DS4LC2DSL66L | 260 |
| DS4LC1DLS42L | 247 | DS4LC2ANL66N | 257 | DS4LC2CLL66L | 259 | DS4LC2DSL72L | 260 |
| DS4LC1DLS48L | 247 | DS4LC2ANL72N | 257 | DS4LC2CLL72L | 259 | DS4LC2DSV30L | 264 |
| DS4LC1DLS54L | 247 | DS4LC2ANV24N | 261 | DS4LC2CLV30L | 263 | DS4LC2DSV36L | 264 |
| DS4LC1DLS60L | 247 | DS4LC2ANV30N | 261 | DS4LC2CLV36L | 263 | DS4LC2DSV42L | 264 |
| DS4LC1DLS66L | 247 | DS4LC2ANV36N | 261 | DS4LC2CLV42L | 263 | DS4LC2DSV48L | 264 |
| DS4LC1DLS72L | 247 | DS4LC2ANV42N | 261 | DS4LC2CLV48L | 263 | DS4LC2DSV54L | 264 |
| DS4LC1DLV30L | 255 | DS4LC2ANV48N | 261 | DS4LC2CLV54L | 263 | DS4LC2DSV60L | 264 |
| DS4LC1DLV36L | 255 | DS4LC2ANV54N | 261 | DS4LC2CLV60L | 263 | DS4LC2DSV66L | 264 |
| DS4LC1DLV42L | 255 | DS4LC2ANV60N | 261 | DS4LC2CLV66L | 263 | DS4LC2DSV72L | 264 |
| DS4LC1DLV48L | 255 | DS4LC2ANV66N | 261 | DS4LC2CLV72L | 263 | DS4LC2DVL30L | 260 |
| DS4LC1DLV54L | 255 | DS4LC2ANV72N | 261 | DS4LC2CSL30L | 259 | DS4LC2DVL36L | 260 |
| DS4LC1DLV60L | 255 | DS4LC2BLL30L | 257 | DS4LC2CSL36L | 259 | DS4LC2DVL42L | 260 |
| DS4LC1DLV66L | 255 | DS4LC2BLL36L | 257 | DS4LC2CSLA2L | 259 | DS4LC2DVL48L | 260 |
| DS4LC1DLV72L | 255 | DS4LC2BLL42L | 257 | DS4LC2CSLA8L | 259 | DS4LC2DVL54L | 260 |
| DS4LC1DSL30L | 251 | DS4LC2BLL48L | 257 | DS4LC2CSL54L | 259 | DS4LC2DVL60L | 260 |
| DS4LC1DSL36L | 251 | DS4LC2BLL54L | 257 | DS4LC2CSL60L | 259 | DS4LC2DVL66L | 260 |
| DS4LC1DSL42L | 251 | DS4LC2BLL60L | 257 | DS4LC2CSL66L | 259 | DS4LC2DVL72L | 260 |
| DS4LC1DSL48L | 251 | DS4LC2BLL66L | 257 | DS4LC2CSL72L | 259 | DS4LC2DVV30L | 264 |
| DS4LC1DSL54L | 251 | DS4LC2BLL72L | 257 | DS4LC2CSV30L | 263 | DS4LC2DVV36L | 264 |
| DS4LC1DSL60L | 251 | DS4LC2BLV30L | 261 | DS4LC2CSV36L | 263 | DS4LC2DVV42L | 264 |
| DS4LC1DSL66L | 251 | DS4LC2BLV36L | 261 | DS4LC2CSV42L | 263 | DS4LC2DVV48L | 264 |
| DS4LC1DSL72L | 251 | DS4LC2BLV42L | 261 | DS4LC2CSV48L | 263 | DS4LC2DVV54L | 264 |
| DS4LC1DSS42L | 247 | DS4LC2BLV48L | 261 | DS4LC2CSV54L | 263 | DS4LC2DVV60L | 264 |

| <i>pattern no.</i> | <i>page</i> | <i>pattern no.</i> | <i>page</i> | <i>pattern no.</i> | <i>page</i> | <i>pattern no.</i> | <i>page</i> |
|--------------------|-------------|--------------------|-------------|--------------------|-------------|--------------------|-------------|
| DS4LC2DVV66L | 264 | DTIARY13242N | 351 | DTIATY6636N | 336 | DTICRY7836N | 337 |
| DS4LC2DVV72L | 264 | DTIARY13248N | 351 | DTIATY7224NS | 335 | DTICRY8424N | 337 |
| DSCSWDB24 | 231 | DTIARY14442N | 351 | DTIATY7230NS | 335 | DTICRY8430N | 337 |
| DSCSWDB30 | 231 | DTIARY14448N | 351 | DTIATY7236N | 336 | DTICRY8436N | 337 |
| DSCSWDB36 | 231 | DTIARY6024NS | 333 | DTIATY7824NS | 335 | DTICRY9024N | 337 |
| DSCSWDB42 | 231 | DTIARY6030NS | 333 | DTIATY7830NS | 335 | DTICRY9030N | 337 |
| DSCSWDB48 | 231 | DTIARY6036N | 334 | DTIATY7836N | 336 | DTICRY9036N | 337 |
| DTIABY10242N | 353 | DTIARY6624NS | 333 | DTIATY8424NS | 335 | DTICRY9624N | 337 |
| DTIABY10248N | 353 | DTIARY6630NS | 333 | DTIATY8430NS | 335 | DTICRY9630N | 337 |
| DTIABY10842N | 353 | DTIARY6636N | 334 | DTIATY8436N | 336 | DTICRY9636N | 337 |
| DTIABY10848N | 353 | DTIARY7224NS | 333 | DTIATY8442N | 336 | DTICTY6024N | 338 |
| DTIABY12042N | 353 | DTIARY7230NS | 333 | DTIATY9024NS | 335 | DTICTY6030N | 338 |
| DTIABY12048N | 353 | DTIARY7236N | 334 | DTIATY9030NS | 335 | DTICTY6036N | 338 |
| DTIABY13242N | 353 | DTIARY7824NS | 333 | DTIATY9036N | 336 | DTICTY6624N | 338 |
| DTIABY13248N | 353 | DTIARY7830NS | 333 | DTIATY9042N | 336 | DTICTY6630N | 338 |
| DTIABY14442N | 353 | DTIARY7836N | 334 | DTIATY9624NS | 335 | DTICTY6636N | 338 |
| DTIABY14448N | 353 | DTIARY8424NS | 333 | DTIATY9630NS | 335 | DTICTY7224N | 338 |
| DTIACX30 | 342 | DTIARY8430NS | 333 | DTIATY9636N | 336 | DTICTY7230N | 338 |
| DTIACX3017 | 342 | DTIARY8436N | 334 | DTIATY9642N | 336 | DTICTY7236N | 338 |
| DTIACX3021 | 342 | DTIARY8442N | 334 | DTIBC3423 | 347 | DTICTY7824N | 338 |
| DTIACX3036 | 342 | DTIARY9024NS | 333 | DTIBC3429 | 347 | DTICTY7830N | 338 |
| DTIACX3042 | 342 | DTIARY9030NS | 333 | DTIBC4023 | 347 | DTICTY7836N | 338 |
| DTIACX36 | 342 | DTIARY9036N | 334 | DTIBC4029 | 347 | DTICTY8424N | 338 |
| DTIACX3617 | 342 | DTIARY9042N | 334 | DTIBC4623 | 347 | DTICTY8430N | 338 |
| DTIACX3621 | 342 | DTIARY9624NS | 333 | DTIBC4629 | 347 | DTICTY8436N | 338 |
| DTIACX3636 | 342 | DTIARY9630NS | 333 | DTIBC5223 | 347 | DTICTY9024N | 338 |
| DTIACX3642 | 342 | DTIARY9636N | 334 | DTIBC5229 | 347 | DTICTY9030N | 338 |
| DTIACX42 | 342 | DTIARY9642N | 334 | DTIBC5823 | 347 | DTICTY9036N | 338 |
| DTIACX4217 | 342 | DTIASX3030 | 341 | DTIBC5829 | 347 | DTICTY9624N | 338 |
| DTIACX4221 | 342 | DTIASX303017 | 341 | DTIBC6423 | 347 | DTICTY9630N | 338 |
| DTIACX4236 | 342 | DTIASX303021 | 341 | DTIBC6429 | 347 | DTICTY9636N | 338 |
| DTIACX4242 | 342 | DTIASX303036 | 341 | DTIBC7023 | 347 | DTIL4040SSN | 349 |
| DTIACX48 | 342 | DTIASX303042 | 341 | DTIBC7029 | 347 | DTIL4646DDN | 349 |
| DTIACX4817 | 342 | DTIASX3636 | 341 | DTIBK464616 | 347 | DTIL4646SSN | 349 |
| DTIACX4821 | 342 | DTIASX363617 | 341 | DTIBT3029 | 347 | DTIR3423N | 349 |
| DTIACX4836 | 342 | DTIASX363621 | 341 | DTIBT3429 | 347 | DTIR3429N | 349 |
| DTIACX4842 | 342 | DTIASX363636 | 341 | DTIBT4629 | 347 | DTIR4023N | 349 |
| DTIADX3030 | 343 | DTIASX363642 | 341 | DTIBT5229 | 347 | DTIR4029N | 349 |
| DTIADX303017 | 343 | DTIASX4242 | 341 | DTIBT5829 | 347 | DTIR4623N | 349 |
| DTIADX303021 | 343 | DTIASX424217 | 341 | DTIBT6429 | 347 | DTIR4629N | 349 |
| DTIADX303036 | 343 | DTIASX424221 | 341 | DTIBT7029 | 347 | DTIR4635N | 349 |
| DTIADX303042 | 344 | DTIASX424236 | 341 | DTIBTL | 345 | DTIR5223N | 349 |
| DTIADX3636 | 343 | DTIASX424242 | 341 | DTIBTS | 345 | DTIR5229N | 349 |
| DTIADX363617 | 343 | DTIASX4848 | 341 | DTIBXL | 345 | DTIR5235N | 349 |
| DTIADX363621 | 343 | DTIASX484817 | 341 | DTIBXL17 | 345 | DTIR5823N | 349 |
| DTIADX363636 | 343 | DTIASX484821 | 341 | DTIBXL21 | 345 | DTIR5829N | 349 |
| DTIADX363642 | 344 | DTIASX484836 | 341 | DTIBXL36 | 345 | DTIR5835N | 349 |
| DTIADX4242 | 343 | DTIASX484842 | 341 | DTIBXL42 | 345 | DTIR6423N | 349 |
| DTIADX424217 | 343 | DTIATY10236N | 352 | DTIBXS | 345 | DTIR6429N | 349 |
| DTIADX424221 | 343 | DTIATY10242N | 352 | DTIBXS17 | 345 | DTIR6435N | 349 |
| DTIADX424236 | 343 | DTIATY10248N | 352 | DTIBXS21 | 345 | DTIR7023N | 349 |
| DTIADX424242 | 344 | DTIATY10836N | 352 | DTIBXS36 | 345 | DTIR7029N | 349 |
| DTIADX4848 | 343 | DTIATY10842N | 352 | DTIBXS42 | 345 | DTIR7035N | 349 |
| DTIADX484817 | 343 | DTIATY10848N | 352 | DTICK4 | 346 | DTIS | 345 |
| DTIADX484821 | 343 | DTIATY12042N | 352 | DTICRY6024N | 337 | RO1DPB | 232 |
| DTIADX484836 | 343 | DTIATY12048N | 352 | DTICRY6030N | 337 | RS1DPB | 232 |
| DTIADX484842 | 344 | DTIATY13242N | 352 | DTICRY6036N | 337 | SISAWDSIK | 348 |
| DTIARY10236N | 351 | DTIATY13248N | 352 | DTICRY6624N | 337 | SISDDPS | 348 |
| DTIARY10242N | 351 | DTIATY14442N | 352 | DTICRY6630N | 337 | SISLC4 | 348 |
| DTIARY10248N | 351 | DTIATY14448N | 352 | DTICRY6636N | 337 | | |
| DTIARY10836N | 351 | DTIATY6024NS | 335 | DTICRY7224N | 337 | | |
| DTIARY10842N | 351 | DTIATY6030NS | 335 | DTICRY7230N | 337 | | |
| DTIARY10848N | 351 | DTIATY6036N | 336 | DTICRY7236N | 337 | | |
| DTIARY12042N | 351 | DTIATY6624NS | 335 | DTICRY7824N | 337 | | |
| DTIARY12048N | 351 | DTIATY6630NS | 335 | DTICRY7830N | 337 | | |

Selling Policy

| | |
|--|---|
| | <p>This Selling Policy supercedes all previous selling policies. Prices, discounts and product offerings are subject to change without notice.</p> |
| Terms & Conditions of Sales | <p>Sales by Knoll, Inc. or Knoll North America Corp. ("Seller") of Knoll Product Lines (hereinafter "Products") within the United States and Canada are made only on the terms which are contained in this Selling Policy. Seller hereby gives notice of its objection to any different or additional terms and conditions. This sale is expressly conditional upon Purchaser's assent to the terms and conditions set forth below. Additional terms and conditions may apply to KnollStudio and KnollTextiles orders. These terms and conditions may be modified or supplemented only by a written document signed by an authorized representative of Seller. These terms and conditions supercede any prior and/or contemporaneous agreements or correspondence between Purchaser and Seller. Written quotations expire thirty (30) days from the date of issuance and can be withdrawn by written notice anytime during that period. Where Purchaser and Seller have entered into the Knoll Electronic Terms and Conditions, all orders, acknowledgements, invoices and other business communications placed or transmitted in accordance with the Knoll Electronic Terms and Conditions shall be deemed to be in writing and signed and shall be valid for all purposes as if they were originated and maintained in documentary form.</p> |
| Ordering Information | <p>All orders must be in writing. The product pattern number(s) contained on Seller's order acknowledgement shall be the final expression of the order.</p> |
| Order Confirmation | <p>A purchase order is not binding on Seller until Purchaser has received Seller's order confirmation or acknowledgment.</p> |
| Pricing Policies | <p>List prices are subject to change without notice.</p> <p>List prices shall be those prices in effect on the date of receipt of a complete purchase order unless shipment is requested more than ninety (90) days after order entry in which case prices in effect on the date of shipment apply. List prices include specified freight costs. Unless specified in writing by Seller, no other charges are included in Seller's list prices.</p> |
| Taxes | <p>All sales, use, excise and other taxes applicable to the sale of the Products shall be paid by Purchaser. If Purchaser claims an exemption from any tax, Purchaser shall submit to Seller the appropriate exemption certificates.</p> |
| Terms of Payment | <p>Payment for one hundred percent (100%) of the net order amount is due within thirty (30) days of the date of invoice, which is generally issued upon shipment. In case of any discrepancies, such as shortages, and Seller is notified in writing within ten (10) days of receipt of Product, only that portion may be deducted and the balance paid. For orders greater than \$100,000 net, a fifty percent (50%) deposit is due at the time of order placement, with the remainder due within thirty (30) days of the date of invoice.</p> <p>KnollStudio orders less than \$2,000 require payment for one hundred percent (100%) of the net order amount (including any applicable sales tax and charges for inside delivery, special packaging, etc.), due at time of order placement. For KnollStudio orders greater than \$2,000, a one-half (50%) deposit is due at time of order placement with the remainder (including any applicable sales tax and charges for inside delivery, special packaging, etc.) due prior to shipment.</p> <p>If, in the judgment of Seller, Purchaser's financial condition does not justify the terms of the payment, Seller may require full or partial payment in advance.</p> <p>Past due accounts shall be charged one and one-half percent (1.5%) per month, or the highest rate permitted by law, whichever is less, and will be added to the outstanding balance. In the event Purchaser defaults on payment, Purchaser shall be liable for all collection costs, including reasonable attorney's fees and costs.</p> |
| Changes and Cancellation | <p>Purchase orders may not be changed or cancelled, in whole or in part, without prior written consent of Seller. Changes may effect delivery dates. Expenses incurred because of changes shall be charged to Purchaser. In the event of cancellations, Purchaser will be liable for reasonable cancellation charges established by Seller. Orders for special Product, orders including "COM" (hereinafter defined) material and orders pursuant to expedited delivery programs, may not be canceled.</p> |
| Freight Prepaid | <p>Freight is prepaid and included in the price of all Products, except KnollTextiles, within the 48 contiguous United States for orders placed with Knoll, Inc. and within Canada, excluding the Yukon, Northwest Territories, Nunavut and Newfoundland for orders placed with Knoll North America Corp. Packing is tested for rigorous motion and transportation but is not guaranteed to protect furniture from all conditions. If special packaging is required for any reason, please consult with your sales representative or dealer. Seller shall select the method of shipment and routing. Freight for all KnollTextiles orders is prepaid and added to the invoice.</p> |
| Delivery/Freight Charges | <p>Shipments outside the contiguous 48 United States and Canada shall be shipped F.O.B. Origin.</p> <p>For shipments outside the contiguous United States and Canada, Purchaser is responsible for the cost of freight from point of embarkation, including any handling and transportation charges incidental to loading at the point of departure and unloading at the final destination.</p> <p>Conditions beyond the control of Seller, including weather, available facilities and traffic conditions, may affect exact time of delivery. Seller shall not be responsible for specific carrier delivery date or time unless it has made a specific delivery commitment, in writing.</p> <p>Nonstandard methods of shipment and/or additional services are available upon request. Purchaser will be billed for the differential cost of any special services in excess of standard surface carrier freight costs. Premium charges, at Purchaser's request, will be added for airfreight, exclusive use of vehicle and extra, export or special packaging. Accessorial charges will be added for inside delivery, extra labor, reassignment and redelivery.</p> <p>Partial shipments may be made and invoiced by Seller.</p> |
| Claims | <p>All shipments for Knoll Products within the contiguous United States and Canada are F.O.B. Origin. All risk of loss passes to Purchaser at time of delivery to carrier. Purchaser shall inspect all Products upon receipt and notify Seller within ten (10) working days after receipt of any damage or defects which are, or should be, apparent from an inspection of the Product and its packaging. Failure of Purchaser to notify Seller during the ten (10) working day period shall constitute acceptance of the Products and waiver of any apparent defects, errors or shortages. For all claims relating to Product damaged in transit or for any other claims relating to or arising out of the transportation of the Product, Purchaser must seek recovery from the carrier and Seller has no liability to Purchaser for such claims. Seller may, upon request, assist Purchaser with filing of such claims with the carrier, but Seller will not be liable for any of these transportation related claims.</p> |
| Seller's Security Interest | <p>Until Seller receives the full payment for the Product, Seller shall have a security interest in the Product. Purchaser agrees to perform all acts, including but not limited to the execution and filing of documentation, which may be necessary to perfect and assure the security interest of Seller.</p> |
| Returns | <p>The return of Products without a written authorization by Seller shall not be accepted. To receive authorization for Product return, please call Customer Service. All Products that are returned pursuant to a valid authorization shall be subject to a twenty-five percent (25%) of list restocking charge. Products not currently offered for sale by Seller (including COM) shall not be authorized for return. All returned Products must be unused, in original condition and in the original Seller packing cartons. No refund or credit shall be given for damaged Products.</p> |
| Held Orders/Storage | <p>If Purchaser requests that an order be held or delayed, prices and terms and conditions in effect at the time of shipment shall apply. If Purchaser requests a delay after the time when Seller can defer production, Purchaser will be invoiced for the Product, payable in accordance with standard terms, when the order is ready for shipment. Seller may transfer the Product to storage, in which case all expenses incurred in connection with storage, including demurrage, preparation for storage, storage charges and handling shall be payable by Purchaser upon submission of invoices by Seller. Risk of loss to the Product shall pass to the Purchaser upon delivery of the Product into storage.</p> |

Selling Policy

| | |
|---------------------------------|---|
| Customer's Own Material | <p>A Purchaser who requests a fabric or other surface material not standard to Seller's line of Products ("COM") must submit samples of the requested material to Seller prior to entry of a purchaser order. Seller shall determine if the material is suitable to its manufacturing processes and meets any requirements of Underwriters Laboratories. If the COM is acceptable, Seller will then establish a price for using the COM or the Product in question. For a description of the procedures for submitting samples and testing, contact customer resources or your sales representative. Seller shall have no responsibility for the appearance, condition, performance, durability, colorfastness or any other physical attribute of the COM. Purchaser shall indemnify and hold Seller harmless for any damages, injuries or losses arising out of or related to use of the COM on the Product.</p> |
| Warranty | <p>Seller warrants to the original Purchaser only that the Products Seller manufactures and sells to Purchaser are free of defects in workmanship and materials, during the applicable warranty period set forth below.</p> <p>Warranty period set forth below is for 24-hour, 7 days a week, multi shift use (includes parts and labor to repair).</p> <p>Should any failure to conform with this limited warranty appear to a Product listed below during the applicable warranty period from the date of shipment, Seller shall, upon prompt written notice, repair or replace, at its option and costs, the affected part or parts.</p> <p><i>Product and Period of Warranty</i></p> <p><i>Lifetime: Antenna Workspaces, AutoStrada, Calibre, Crinion Open Table, Currents, Dividends Horizon, Equity, Morrison, Reff Profiles laminate, Series 2 Storage, Template and other non-wood components (except cascade edge worksurfaces, operational parts, controls, electrical, Lighting, Series 2 Veneer Front Storage, special or custom products, see below)</i></p> <p><i>12 Years: Chadwick, Essentials Work Chairs, Generation by Knoll, Life, Moment, MultiGeneration by Knoll, ReGeneration by Knoll, RPM, Sapper and Toboggan seating (except seating upholstery, textiles, leathers and finishes, see below).</i></p> <p><i>10 Years: Anchor Storage except digital keypad lock, Antenna Workspaces, AutoStrada, Crinion Open Table, Dividends Horizon, Reff Profiles, Template wood components, Series 2 Veneer Front Storage, cascade edge worksurfaces, Wood Casegoods (The Graham Collection) (except wood casegoods upholstered surfaces, see below), Interaction tables (except height adjustment mechanisms for Counterforce, crank-adjustable, and split-top tables and worksurfaces, see below), Reuter overheads, Reuter vertical storage, KnollExtra Sapper Monitor Arm Collection, Adjustable keyboard mechanisms and platforms, Communication Boards (except fabric board textiles, see below), Smokador collection (except leathers, see below), and Orchestra Universal Systems Accessories.</i></p> <p><i>5 Years: Operational parts, controls, electrical, Lighting (except light ballasts, bulbs and power supply, see below), special or custom product, wood veneer products, Currents handerank, Interaction Counterforce, Interaction crank-adjustable, and split-top mechanisms, KnollStudio, Spark Series seating structural elements, Richard Schultz outdoor products, KnollExtra CPU storage and all universal storage drawers and Power Collection.</i></p> <p><i>3 Years: Seating upholstery, textiles, leathers and finishes. Fabric boards textiles and Smokador Collection leathers.</i></p> <p><i>2 Years: Anchor Storage digital keypad lock, all other KnollExtra product</i></p> <p><i>1 Year: Light ballasts, bulbs and power supply, seating upholstered armpads and soft armpads, wood casegoods upholstered surfaces. KnollStudio Maya Lin and Spark Series seating finishes.</i></p> <p>This warranty does not apply to:</p> <ul style="list-style-type: none">• Damage caused by a carrier other than the Seller.• Normal wear and tear or acts or omissions of parties other than Seller (including user modification, improper use or installation of Products).• COM or other third party materials applied to Products.• Products not installed by or under the auspices of a Knoll Dealer.• Dramatic temperature variations or exposure to unusual conditions.• Changes in surface finishes, including colorfastness due to aging or exposure to light.• Except as specifically noted above, textiles and upholstery supplied by <i>KnollTextiles</i> (consult current <i>KnollTextiles</i> price list for applicable warranty). <p>Natural variations occurring in wood, marble, and leather shall not be considered defects, and the Seller does not guarantee the colorfastness or matching of the colors, grains or textures, or surface hardness of such materials. The Seller also does not guarantee the colorfastness of fiberglass panel surfaces. THE EXPRESS WARRANTIES CONTAINED HEREIN ARE IN LIEU OF ALL OTHER WARRANTIES, EXPRESS OR IMPLIED, INCLUDING ANY WARRANTIES OF MERCHANTABILITY AND FITNESS FOR PARTICULAR PURPOSE AND ALL OTHER WARRANTIES ARISING FROM COURSE OF DEALING OR USAGE OF TRADE.</p> <p>The remedies provided above are the Purchaser's sole remedies for any failure of Seller to comply with its obligations regarding the workmanship of its Products. Correction of any nonconformity in the manner and for the period of time provided shall constitute complete fulfillment of all liabilities of Seller, with respect to or arising out of the Product furnished hereunder.</p> |
| Delay/Force Majeure | <p>Seller shall not be liable for failure to perform or for delay in performance due to fire, flood, strike or other labor difficulty, act of God, act of any governmental authority or of the Purchaser, riot, embargo, fuel or energy shortage, wrecks or delay in transportation, inability to obtain necessary labor, materials or manufacturing facilities from usual sources or failure of suppliers to meet their contractual obligations, or due to any cause beyond its reasonable control. If any such event occurs, Seller may extend delivery dates by a period of time necessary to overcome the effect of such delay, allocate available Product or cancel any purchase order.</p> |
| Compliance with Law | <p>PURCHASER IS SOLELY RESPONSIBLE FOR COMPLIANCE WITH ALL APPLICABLE FEDERAL, STATE AND LOCAL LAWS, ORDINANCES, REGULATIONS, RULES AND STANDARDS RELATING TO THE INSTALLATION, MAINTENANCE, USE AND OPERATION OF THE PRODUCTS.</p> |
| Patents | <p>Subject to the following provisions, Seller shall, at its own expense, defend or, at its option, settle any claim, suit or proceeding brought against the Purchaser, and/or its vendees, mediate and immediate, so far as based on an allegation that any Product or any part thereof furnished hereunder constitutes a direct or a contributory infringement of any claim of any patent of the United States or Canada. This obligation shall be effective only if Purchaser shall have made all payments then due hereunder and if Seller is notified promptly in writing and given authority, information and assistance for the defense of said claim, suit or proceeding. Seller shall pay all damages and costs awarded in such suit or proceedings so defended.</p> <p>The foregoing indemnity does not apply to the following:</p> <ul style="list-style-type: none">• Products supplied according to a design other than that of Seller, and which is required by the Purchaser.• Combination of the Product with another product not furnished hereunder unless Seller is a contributory infringer.• Any settlements of a suit or proceeding made without Seller's written consent. |
| Limitations of Liability | <p>SELLER, ITS CONTRACTORS, AUTHORIZED DEALERS AND SUBCONTRACTORS OR SUPPLIERS OF ANY TIER SHALL NOT BE LIABLE TO PURCHASER FOR ANY SPECIAL, INDIRECT, INCIDENTAL OR CONSEQUENTIAL DAMAGES ARISING FROM A BREACH OF THIS AGREEMENT.</p> <p>Purchaser's remedies set forth herein are exclusive and the liability of Seller with respect to the breach of this agreement or any contract entered into between the parties pursuant hereto shall not exceed the price of the Product or part on which such liability is based.</p> |

KnollKey Lock Program

KnollKey Lock Program General Information

Following is the KnollKey lock policy, applicable to all products.

Knoll furniture can be ordered keyed-alike or random keyed. Key-alike and random keying instructions cannot be mixed on any single order. Only one of the two instructions can be used on an individual order. When an order is submitted with mixed (key-alike and random) instructions, Knoll will release the order as key-alike only and lock cores will have to be specified separately.

Key-alike

For the convenience of the user, furniture may be keyed alike at no charge. Write "Key-alike" in the description of your purchase order for any pedestal, overhead, file or other item you wish to have keyed alike.

Using the key-alike instructions, order cores and keys as line items on your purchase order. Do NOT submit a key-alike form. The Knoll East Greenville Lock Center will select key numbers from the standard range of K 001 - K 250. Key numbers will not be repeated unless over 250 sets are ordered. Lock cores keyed-alike will ship separately from the product, ready for field installation.

There is no charge for key-alike orders if placed with the furniture order.

IF THE KEY-ALIKE ORDER IS NOT PLACED AT LEAST TWO WEEKS PRIOR TO THE FURNITURE SHIP DATE, A \$50 HANDLING CHARGE AND AIR FREIGHT CHARGES WILL APPLY.

If product is ordered and shipped random-keyed, additional lock cores for key-alike are billable.

Random-Keying

To specify product keyed-random, write "key-random" in the product description. Random-keyed product is shipped with the lock core factory installed. A shrouded key is included. Random means no effort has been made to match key numbers, or to make them different.

Keys

A Knoll shrouded key is shipped with every lock core. 250 Key numbers are available. For numbers above 250, contact Custom Product Development. Additional keys and key blanks are available. See service parts for more information.

Master Keying

Knoll locks can be controlled by means of a master key. There is no additional per-lock charge for master keying. A letter of approval from the client must accompany orders for master keys.

Installing Lock Cores

Lock cores can be installed or removed in the field by using a change key. Cores must be in the unlocked position to be removed. See service parts for change key pattern number and pricing.

Lock Distribution

All orders for key-alike lock cores/keys are packaged and shipped from the East Greenville Lock Center, regardless of where the pedestals, overhead, or other units are produced. Random keyed product will have cores factory-installed.

How to Specify Key-Alike

Following is an example of how to specify key-alike for a cluster of 10 workstations.

Step 1 - Using the project floorplan, count the number of locks in each workstation.

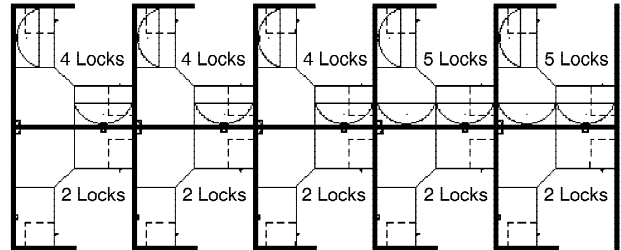

Step 2 - Count the number of workstations with the same quantity of locks. Group together the workstations with a like number of locks.

5 workstations with 2 locks per station
3 workstations with 4 locks per station
2 workstations with 5 locks per station

Step 3 - For the first group (5 sets of 2 locks), enter the number of workstations in the quantity column.

| Qty | Pattern # | Description | Unit List | Ext. List |
|-----|-----------|-------------|-----------|-----------|
| 5 | | | | |

Step 4 - Then enter the pattern number "KSPEC_ _" and add a suffix for the number of locks for that group (i.e., for 2 locks per station, add the suffix "2"). Up to 30 lock cores are available in a set (i.e., KSPEC 30).

| Qty | Pattern # | Description | Unit List | Ext. List |
|-----|-----------|---------------------|-----------|-----------|
| 5 | KSPEC 2 | Set of 2 cores/keys | N / C | N / C |

Step 5 - Repeat for other groups.

| Qty | Pattern # | Description | Unit List | Ext. List |
|-----|-----------|---------------------|-----------|-----------|
| 5 | KSPEC 2 | Set of 2 cores/keys | N / C | N / C |
| 3 | KSPEC 4 | Set of 4 cores/keys | N / C | N / C |
| 2 | KSPEC 5 | Set of 5 cores/keys | N / C | N / C |

Your Key instructions are complete.

Knoll will select key numbers for each set from 250 available numbers. Additional key numbers are available through Custom Product Development. **For additions to existing installations, specify desired key numbers in the description.**

Service Parts

| Pattern # | Description | List Price |
|--------------|---|------------|
| KKEY_ _ _ | Shrouded Key Specify key number desired | \$10 |
| KBLANK | Shrouded Key Blank | \$10 |
| KSPECB_ _ _ | Retrofit Universal Core/Key Specify key number desired | \$22 |
| KCHANGE | Change Key | \$10 |
| HLKRKMASTER* | Master Key | \$10 |

*Note: A letter of approval on company letterhead from the client must accompany all orders for master keys.

General Ordering Information

The Products

This guide encompasses all standard products for this product group.

Sizes

Dimensions listed in this guide are indicated as:

H = height

W = width

D = depth

Dia. = diameter

Rad. = radius

Pricing

All prices shown are list.

How to Order

Select pattern numbers and quantities required for your complete installation. Product questions can be addressed in the specific sections of this guide or by contacting your sales representative or customer resource representative at 1-800-343-5665.

Next, select options (if required), along with colors and finishes appropriate to each product. Reference the Finishes and Fabrics pages for color designations.

On large installations, an item's "designated area" can be specified to assist in product organization and handling.

To expedite complete / correct entry of your order, be certain all pattern numbers, quantities, colors and area identifications are completely specified. Also, include complete purchase order numbers, bill-to and ship-to addresses, a contact name and specific factory shipping dates required.

Mail all orders to:

Knoll, Inc.

1235 Water Street

P.O. Box 157

East Greenville, PA 18041

Attention: Order Entry

Once your order is entered at Knoll, an acknowledgment will be mailed to you. You will be advised of your scheduled shipping date within five days of the original acknowledgment. If it is necessary to revise your order, please contact your customer resource representative.

Sustainability Statement

Sustainable design is a key component of Knoll's environmental focus. Our commitment to social responsibility and a healthy environment has prompted us to further articulate our longstanding environmental programs and, with encouragement and support from our colleagues in the industry, we have re-energized our focus on such "green" initiatives as life cycle analysis and LEED™ certification. Knoll is proud to have contributed to projects that have received LEED certification from the U.S. Green Building Council.

For the latest information on Knoll products that help our customers achieve LEED certification, log on to knoll.com, click on "About Knoll" and then "Environmental Focus."