

Introduction	Knoll and Sustainable Design	3
Dividends Horizon System	Dividends Color Program Finishes	5
	Dividends Legacy Finishes	6
	Dividends Worksurfaces	7
	Dividends Table Supports	19
	Dividends Accessories	20
	Dividends Electrical	21
	Dividends T5 Task Lights	26
Equity System	Equity Finishes	27
	Equity Generation 1	28
	Equity Generation 3	30
	Equity service wall accessories	32
	Equity EW1 Worksurfaces	33
	Equity EW3 Worksurfaces	37
	Equity / Dividends style File tops	39
	Equity Task Light	40
Morrison System	Morrison System Finishes	41
	Knoll Color Program	42
	Morrison System Legacy Finishes	43
	Morrison Window Panel	44
	Morrison Connectors, post assemblies	45
	Morrison miscellaneous	49
	Trim Cover	50
	Morrison Rolling Doors	52
	Morrison Worksurfaces, 1 3/4"	54
	Morrison Worksurfaces, 1 1/4"	62
	Morrison Options Worksurfaces, 1 1/4"	76
	Currents System worksurfaces	90
	VDT corner and transitional end panels	91
	Kneehole filler and transitional filler panels	92
	Return filler panels	93
	Intermediate shelves	94
	Morrison shelves and flush counter surface, 1 3/4"	95
	Morrison shelves and flush counter surface, 1 1/4"	96
	Morrison Overhead cabinets	97
	Morrison Network privacy screen	98
	Morrison vertical storage	99
	Morrison Network T5 Task Light	100
	Morrison Options T5 Task Light	101
Reff System	Reff Finish Options	102
	Reff Panels	104
	Reff Worksurfaces	112
	Reff support components	133
	Reff Cabinetry	136
	Reff Overhead storage	157
	Reff accessories	179
AutoStrada System	AutoStrada Finishes	180
	AutoStrada Worksurfaces	181
	AutoStrada Cabinets	182
	AutoStrada Lower Storage	183
	AutoStrada T5 Task Light	184
Reuter	T5 Task Light for Reuter Overhead Storage	185
The Graham Collection	The Graham Collection T5 Task Light	186

Alpha-Numeric Index	187
Selling Policy	197
KnollKey Lock Program	199
General Ordering Information	200

Knoll and Sustainable Design

Each year Knoll sets key initiatives in our journey to sustainability. We are members of a global consortium on energy, have adopted a scientific, metrics-based approach to sustainable product design, and maintain a leadership position in establishing universal, verifiable, sustainability standards for our industry.

Knoll promotes independent third-party certification because it provides the most impartial and trustworthy foundation for industry-wide environmental compliance. Certification by established and respected third parties ensures that all manufacturers are held to the same high standards and that customers can trust a company's declaration about the environmental benefits of its products. Knoll third-party partners include: the International Standards Organization (ISO); Forest Stewardship Council (FSC®); Rainforest Alliance; GREENGUARD® Environmental Institute; and Chicago Climate Exchange (CCX®).

In addition, Knoll is aligned with the U.S. Green Building Council and can help companies, healthcare organizations and educational institutions achieve Leadership in Energy and Environmental Design (LEED®) workplace certification.

1. Global Climate Change

- Knoll is a sponsor of the Clinton Global Initiative, which brings together a community of global leaders to devise and implement solutions to some of the world's most pressing challenges, including environmental change.
- Knoll is a member of the Chicago Climate Exchange, which promotes greenhouse gas reduction through the trading of credits earned for reducing emissions.
- Knoll has a comprehensive Energy Management Program to increase energy efficiency in products and processes.

2. Life Cycle Assessment (LCA) Tool

- Life Cycle Assessment is a science-based measurement of a product's environmental impacts throughout its life cycle, from raw materials sourcing through manufacture, shipping, use and re-use or end-of-life. LCA enables cradle-to-cradle implementation of sustainable practices.
- Knoll has partnered with The Green Standard.org to develop an affordable, universal ISO-compliant computer-based LCA tool that can be used by the entire contract furniture industry and is partnering on the development of an Environmental Product Declaration System (EPDs) for Knoll products. EPDs are verified documents containing LCA results and additional environmental performance information about a product.

3. Setting Industry Standards

- Knoll partners with MTS (The Institute for Market Transformation to Sustainability) to develop the SMaRT® Consensus Sustainable Products Standards, a set of consensus-based sustainable product standards based on the LEED® model, for all building products, fabric, apparel, flooring and carpet. MTS, the developer of SMaRT®, is an accredited American National Standards Institute (ANSI) standard developer.
- Knoll has established FSC® (Forest Stewardship Council) certified wood as the standard for general office open plan office systems, casegoods and tables.
- Knoll also participates in an ongoing BIFMA (Business and Institutional Furniture Manufacturers Association) initiative to establish level™ sustainability standards for the contract furniture industry.
- Our goal is to encourage all manufacturers in the contract furniture industry and related industries to adopt standards that will lead to sustainable products and practices.

For more information about Knoll and sustainable design, visit knoll.com/environment.

All dimensions in this price list are nominal and follow standard size convention of its respective product line.

Core Paint and Laminate Finishes

Specify Core finishes for all new customers

Order Code	Color Name	Old Order Code	Paint Grade	Paint Finishes	Plastic Panel Trim Finishes	DS1 Pedestal and Overhead Plastic Finishes	Laminate Finishes	2mm Edgeband Finishes	Techwood Finishes	Cascade Worksurface Finishes
611	Beige Mist Metallic		P2	•						
118	Bright White	LH	P3	•		•	•	•		•
112	Brown		P1	•		•				
123	Brushed Grey						•			
122	Brushed Sand						•			
113	Dark Grey	Y3	P1	•	•	•		•		
128	Fog	G					•	•		
114	Folkstone Grey		P1	•		•	•	•		•
111	Jet Black	27	P1	•		•	•	•		
124	Medium Cherry						•	•		•
115	Medium Grey	Y2	P1	•	•	•		•		
612	Medium Metallic Grey	J	P2	•						
121	Micro Grey						•			
129	Micro Sand						•			
126	Natural Cherry						•	•		•
125	Natural Maple						•	•		•
119	Pumice	LB, F					•	•		•
116	Sandstone		P1	•		•				
613	Silver	3	P3	•						
117	Soft Grey	E, M42	P1	•	•	•	•	•		•
127	Walnut						•	•		•
Y811	Natural Techwood								•	
Y821	Blonde Maple Techwood (formerly known as Maple Techwood)								•	
Y831	Light Cherry Techwood (formerly known as Cherry Techwood)								•	

Note: All Dividends Horizon products except DS1 and DS2 pedestals and doublewide pedestals are painted with a textured finish excluding 613 Silver which is available as a smooth finish only.

X and Y base tables and the freestanding screen kits are always painted with a textured finish, including 613 Silver.

Note: Laminates and other finishes may vary in color due to different dye lots. Slight variations are to be expected.

Panel base raceway covers	Plastic panel trim	DS1 pedestal drawer plugs	2mm Edge Work-surfaces	2mm Edge Work-surfaces	Techwood edge work-surfaces	Cascade edge work-surface
Steel tile inserts	PVC post assemblies	DS1 pedestal handles	15" deep counters	15" deep counters	15" deep counters	
D1 style tile supports	Beltway raceway covers	DS1 Overhead door end plugs	Overhead doors	Overhead doors	Overhead doors	
Overhead cabinets	Power pole covers		Credenza top and doors	Credenza tops	Credenza doors	
Pedestal case and fronts			Overdesk doors	Overdesk doors	Overdesk doors	
					Series 2 overhead door	

Most products introduced after 2004 are not available in Legacy finishes. See individual pricing pages for availability.

Specify Legacy finishes to match existing product only. Legacy finishes are not available for new customers.

Trim Finishes

- Panel top caps
- Panel post trim
- Pedestal drawer top caps
- Overhead drawer top caps
- Pedestal drawer pulls
 - Y1 Pewter

Paint Finishes

- Panel base raceway covers
- Panel tiled insert supports
- Solid Steel panel inserts
- Perforated steel panel inserts
- Embossed steel panel inserts
- Overhead storage components
- Pedestals
- Desk components
- Metal panel topcaps and trim

P1 Finishes

- Y1 Pewter

P2 Finishes

- H Beige Metallic
- W Light Tan Metallic

All other Knoll paint finishes and custom finishes (Series 2 components only)

Laminates

Worksurfaces

An upcharge applies where specifying Legacy laminates. Add an amount equal to 10% of the solid PVC edgeband list price to the price of any product specified with a Legacy laminate.

- MC Caramel Maple
- CM Clear Maple
- M1 Light Grey
- PA Pearwood
- SD Sand
- B Snow
- WM Warm Cherry
- MR6 Winter Grey Matrix

Note: Laminates and other finishes may vary in color due to different dye lots. Slight variations are to be expected.

Worksurface Edges

2mm edgeband

- MC Caramel Maple
- CM Clear Maple
- Y3 Dark Grey
- Y2 Medium Grey
- MT Metal
- Y1 Pewter
- SD Sand
- B Snow
- WM Warm Cherry

Dividends Worksurfaces
Rectangular 18" Deep
Rectangular 18" Deep + Post

Standard Specials Systems

description	w	d	t	pattern no.	PVC edge	woodgrain PVC edge	metal edge	techgrain w/ techgrain edge
18" Deep Rectangular, No Grommet 	18"	18"	1 1/4"	D1R1818NQ	\$173.	\$190.	\$208.	\$421.
18" Deep Rectangular, No Grommet Post Condition	21"	18"	1 1/4"	D1R2118NQ	177.	195.	212.	430.
	27"	18"	1 1/4"	D1R2718NQ	184.	202.	221.	452.
	33"	18"	1 1/4"	D1R3318NQ	207.	228.	248.	474.
	39"	18"	1 1/4"	D1R3918NQ	240.	264.	288.	497.
	45"	18"	1 1/4"	D1R4518NQ	266.	293.	319.	518.
	51"	18"	1 1/4"	D1R5118NQ	283.	312.	340.	537.
	57"	18"	1 1/4"	D1R5718NQ	308.	339.	370.	557.
	63"	18"	1 1/4"	D1R6318NQ	332.	365.	398.	578.
	69"	18"	1 1/4"	D1R6918NQ	350.	386.	421.	598.
	75"	18"	1 1/4"	D1R7518NQ	375.	413.	450.	623.
	81"	18"	1 1/4"	D1R8118NQ	395.	435.	474.	647.
	87"	18"	1 1/4"	D1R8718NQ	440.	484.	528.	671.
	93"	18"	1 1/4"	D1R9318NQ	487.	536.	585.	696.
	99"	18"	1 1/4"	D1R9918NQ	546.	601.	655.	755.

Order Code	Ordering Information	Included with:	Options
"D" Worksurface	"D" Worksurface	Worksurfaces	Worksurfaces
<i>Example:</i> D1R 1818N Q, 114, 114	1. Pattern Number		• Center-Located Edge Grommet
D1R Pattern Number	2. Laminate Finish		To specify, replace the "N" suffix from the pattern number with "G" .
1818G Q	3. Edge Band Finish		Add \$18.
114 Folkstone Grey Laminate			• Woodgrain PVC edge
114 Folkstone grey Edge Band			• Metal edge

Dividends Worksurfaces
Rectangular 24" Deep
Rectangular 24" Deep + Post

Standard Specials Systems

description	w	d	t	pattern no.	PVC edge	woodgrain PVC edge	metal edge	techgrain w/ techgrain edge
24" Deep Rectangular, No Grommet 	102"	24"	1 1/4"	D1R10224NQ	\$676.	\$744.	\$811.	\$879.
	108"	24"	1 1/4"	D1R10824NQ	735.	809.	882.	956.
	120"	24"	1 1/4"	D1R12024NQ	853.	938.	1,024.	1,109.
24" Deep Rectangular, No Grommet Post Condition	21"	24"	1 1/4"	D1R2124NQ	185.	204.	222.	444.
	27"	24"	1 1/4"	D1R2724NQ	214.	235.	256.	470.
	33"	24"	1 1/4"	D1R3324NQ	237.	261.	285.	494.
	39"	24"	1 1/4"	D1R3924NQ	271.	299.	326.	520.
	45"	24"	1 1/4"	D1R4524NQ	303.	334.	364.	545.
	51"	24"	1 1/4"	D1R5124NQ	329.	362.	395.	575.
	57"	24"	1 1/4"	D1R5724NQ	355.	391.	426.	602.
	63"	24"	1 1/4"	D1R6324NQ	384.	422.	460.	629.
	69"	24"	1 1/4"	D1R6924NQ	400.	440.	480.	656.
	75"	24"	1 1/4"	D1R7524NQ	430.	472.	515.	687.
	81"	24"	1 1/4"	D1R8124NQ	454.	500.	545.	717.
	87"	24"	1 1/4"	D1R8724NQ	513.	565.	616.	747.
	93"	24"	1 1/4"	D1R9324NQ	558.	614.	670.	776.
	99"	24"	1 1/4"	D1R9924NQ	617.	679.	740.	835.

Ordering Information

Worksurfaces

1. Pattern Number
2. Laminate Finish
3. Edge Band Finish

Order Code

Worksurfaces

Example: **D1R 4524NQ, 114, 114**

D1R Pattern Number

4524N Q

114 Folkstone Grey Laminate

114 Folkstone Grey Edge Band

Included with:

Worksurfaces

Options

Worksurfaces

- Center-Located Edge Grommet
To specify, replace the "N" suffix from the pattern number with "G".
Add \$18.
- Woodgrain PVC edge
- Metal edge

Dividends Worksurfaces
Rectangular 30" Deep
Rectangular 30" Deep + Post

description	w	d	t	pattern no.	PVC edge	woodgrain PVC edge	metal edge	techgrain w/ techgrain edge
30" Deep Rectangular, No Grommet	102"	30"	1 1/4"	D1R10230NQ	\$788.	\$867.	\$946.	\$1,024.
	108"	30"	1 1/4"	D1R10830NQ	847.	932.	1,016.	1,101.
	114"	30"	1 1/4"	D1R11430NQ	906.	997.	1,087.	1,178.
	120"	30"	1 1/4"	D1R12030NQ	964.	1,060.	1,157.	1,253.
30" Deep Rectangular, No Grommet Post Condition	27"	33"	1 1/4"	D1R2730NQ	266.	292.	319.	496.
	33"	30"	1 1/4"	D1R3330NQ	294.	323.	353.	530.
	39"	30"	1 1/4"	D1R3930NQ	321.	353.	385.	565.
	45"	30"	1 1/4"	D1R4530NQ	355.	391.	426.	601.
	51"	30"	1 1/4"	D1R5130NQ	402.	443.	483.	627.
	57"	30"	1 1/4"	D1R5730NQ	444.	488.	532.	653.
	63"	30"	1 1/4"	D1R6330NQ	493.	543.	592.	679.
	69"	30"	1 1/4"	D1R6930NQ	513.	565.	616.	703.
	75"	30"	1 1/4"	D1R7530NQ	548.	602.	657.	736.
	81"	30"	1 1/4"	D1R8130NQ	582.	640.	698.	768.
	87"	30"	1 1/4"	D1R8730NQ	625.	688.	750.	800.
	93"	30"	1 1/4"	D1R9330NQ	670.	737.	804.	832.
	99"	30"	1 1/4"	D1R9930NQ	729.	802.	875.	948.

Ordering Information

Worksurfaces

1. Pattern Number
2. Laminate Finish
3. Edge Band Finish

Order Code

Worksurfaces

Example: **D1R 6330N Q, 114, 114**

D1R Pattern Number
6330N Q

114 Folkstone Grey Laminate

114 Folkstone Grey Edge Band

Included with:

Worksurfaces

Options:

Worksurfaces

- Center-Located Edge Grommet
To specify, replace the "N" suffix from the pattern number with "G".
Add \$18.
- Woodgrain PVC edge
- Metal edge

Dividends Worksurfaces
Rectangular 36" Deep
Rectangular 36" Deep + Post

Standard Specials Systems

description	w	d	thickness	pattern no.	PVC edge	woodgrain PVC edge	metal edge	techgrain w/ techgrain edge
36" Deep Rectangular, No Grommet	30"	36"	1 1/4"	D1R3036NQ	\$529.	\$582.	\$635.	\$688.
	36"	36"	1 1/4"	D1R3636NQ	553.	608.	664.	719.
	42"	36"	1 1/4"	D1R4236NQ	556.	612.	667.	723.
	48"	36"	1 1/4"	D1R4836NQ	562.	618.	674.	731.
	54"	36"	1 1/4"	D1R5436NQ	569.	626.	683.	775.
	78"	36"	1 1/4"	D1R7836NQ	751.	826.	901.	976.
	84"	36"	1 1/4"	D1R8436NQ	810.	891.	972.	1,053.
	90"	36"	1 1/4"	D1R9036NQ	869.	956.	1,043.	1,130.
	96"	36"	1 1/4"	D1R9636NQ	928.	1,021.	1,114.	1,206.
	102"	36"	1 1/4"	D1R10236NQ	987.	1,086.	1,184.	1,283.
	108"	36"	1 1/4"	D1R10836NQ	1,046.	1,151.	1,255.	1,360.
	114"	36"	1 1/4"	D1R11436NQ	1,105.	1,216.	1,326.	1,437.
120"	36"	1 1/4"	D1R12036NQ	1,164.	1,280.	1,397.	1,513.	
36" Deep Rectangular, No Grommet Post Condition	30"	36"	1 1/4"	D1R3336NQ	529.	582.	635.	688.
	39"	36"	1 1/4"	D1R3936NQ	553.	608.	664.	719.
	45"	36"	1 1/4"	D1R4536NQ	556.	612.	667.	723.
	51"	36"	1 1/4"	D1R5136NQ	562.	618.	674.	731.
	57"	36"	1 1/4"	D1R5736NQ	569.	626.	683.	775.
	63"	36"	1 1/4"	D1R6336NQ	628.	691.	753.	816.
	69"	36"	1 1/4"	D1R6936NQ	691.	761.	830.	899.
	75"	36"	1 1/4"	D1R7536NQ	751.	826.	901.	976.
	81"	36"	1 1/4"	D1R8136NQ	810.	891.	972.	1,053.
	87"	36"	1 1/4"	D1R8736NQ	869.	956.	1,043.	1,130.
	93"	36"	1 1/4"	D1R9336NQ	910.	1,001.	1,092.	1,183.
	99"	36"	1 1/4"	D1R9936NQ	947.	1,042.	1,136.	1,231.

Ordering Information

Worksurfaces

1. Pattern Number
2. Laminate Finish
3. Edge Band Finish

Order Code

Worksurfaces

Example: **D1R 3036N Q, 114, 114**

D1R Pattern Number
3036N Q

114 Folkstone Grey
Laminate

114 Folkstone Grey Edge
Band

Included with:

Worksurfaces

Options

Worksurfaces

- Center-Located Edge Grommet
To specify, replace the "N" suffix from the pattern number with "G".
Add \$18.
- Woodgrain PVC edge
- Metal edge

Dividends Worksurfaces

Curvilinear Wave End

Left

description	1	2	3	A	B	t	pattern no.	PVC edge	woodgrain PVC edge	metal edge	techgrain w/ techgrain edge
Curvilinear Wave End Left No Grommet	29 1/2"	23 1/2"	29 1/2"	14 15/16"	2 15/16"	1 1/4"	D1W303024NQ	\$500.	\$550.	\$600.	\$650.
	35 13/16"	17 1/2"	23 1/2"	14 15/16"	2 15/16"	1 1/4"	D1W362418NQ	559.	615.	671.	727.
	47 13/16"	23 1/2"	35 13/16"	14 15/16"	14 15/16"	1 1/4"	D1W483624NQ	642.	706.	770.	835.
	53 13/16"	23 1/2"	29 1/2"	14 15/16"	14 15/16"	1 1/4"	D1W543024NQ	649.	714.	779.	844.
	59 13/16"	17 1/2"	29 1/2"	23 7/16"	14 15/16"	1 1/4"	D1W603018NQ	661.	727.	793.	859.
	59 13/16"	23 1/2"	29 1/2"	23 7/16"	18 7/16"	1 1/4"	D1W603024NQ	661.	727.	793.	859.
	59 13/16"	23 1/2"	35 1/2"	17 1/2"	14 15/16"	1 1/4"	D1W603624NQ	739.	813.	887.	961.
	65 13/16"	23 1/2"	29 1/2"	23 7/16"	15 15/16"	1 1/4"	D1W663024NQ	694.	763.	833.	902.
	65 13/16"	23 1/2"	35 1/2"	23 7/16"	14 15/16"	1 1/4"	D1W663624NQ	777.	855.	932.	1,010.
	71 13/16"	29 1/2"	35 1/2"	23 7/16"	14 15/16"	1 1/4"	D1W723630NQ	806.	887.	967.	1,048.
	77 13/16"	23 1/2"	29 1/2"	23 7/16"	30 7/16"	1 1/4"	D1W783024NQ	781.	859.	937.	1,015.
	77 13/16"	23 1/2"	35 1/2"	23 7/16"	14 15/16"	1 1/4"	D1W783624NQ	869.	956.	1,043.	1,130.
	83 13/16"	23 1/2"	35 1/2"	23 7/16"	14 15/16"	1 1/4"	D1W843624NQ	896.	986.	1,075.	1,165.
	89 13/16"	23 1/2"	29 1/2"	23 7/16"	30 7/16"	1 1/4"	D1W903024NQ	886.	975.	1,063.	1,152.
	95 13/16"	23 1/2"	29 1/2"	23 7/16"	39"	1 1/4"	D1W963024NQ	945.	1,040.	1,134.	1,229.
	95 13/16"	23 1/2"	35 1/2"	23 7/16"	14 15/16"	1 1/4"	D1W963624NQ	969.	1,066.	1,163.	1,260.
	95 13/16"	29 1/2"	35 1/2"	23 7/16"	30 7/16"	1 1/4"	D1W963630NQ	969.	1,066.	1,163.	1,260.

Order Code	Ordering Information	Included with:	Options
Worksurfaces	Worksurfaces	Worksurfaces	Worksurfaces
<i>Example:</i> D1R 303024N Q, 114, 114	1. Pattern Number		• Center-Located Edge Grommet
D1R Pattern Number	2. Laminate Finish		To specify, replace the "N" suffix from the pattern number with "G".
303024N	3. Edge Band Finish		Add \$18.
114 Folkstone Grey Laminate			• Woodgrain PVC edge
114 Folkstone Grey Edge Band			• Metal edge

Dividends Worksurfaces

Curvilinear Wave End

Right

Standard Specials Systems

description	1	2	3	A	B	t	pattern no.	PVC edge	woodgrain PVC edge	metal edge	techgrain w/ techgrain edge
Curvilinear Wave End Right No Grommet	29 1/2"	29 1/2"	23 1/2"	2 15/16"	14 15/16"	1 1/4"	D1W302430NQ	\$500.	\$550.	\$600.	\$650.
	35 13/16"	23 1/2"	17 1/2"	2 15/16"	14 15/16"	1 1/4"	D1W361824NQ	559.	615.	671.	727.
	47 13/16"	35 15/16"	23 1/2"	14 15/16"	14 15/16"	1 1/4"	D1W482436NQ	642.	706.	770.	835.
	53 13/16"	29 1/2"	23 1/2"	14 15/16"	14 15/16"	1 1/4"	D1W542430NQ	649.	714.	779.	844.
	59 13/16"	29 1/2"	17 1/2"	14 15/16"	23 7/16"	1 1/4"	D1W601830NQ	661.	727.	793.	859.
	59 13/16"	29 1/2"	23 1/2"	18 7/16"	23 7/16"	1 1/4"	D1W602430NQ	661.	727.	793.	859.
	59 13/16"	35 1/2"	23 1/2"	14 15/16"	17 1/2"	1 1/4"	D1W602436NQ	739.	813.	887.	961.
	65 13/16"	29 1/2"	23 1/2"	15 15/16"	23 7/16"	1 1/4"	D1W662430NQ	694.	763.	833.	902.
	65 13/16"	35 1/2"	23 1/2"	14 15/16"	23 7/16"	1 1/4"	D1W662436NQ	777.	855.	932.	1,010.
	71 13/16"	35 1/2"	29 1/2"	30 7/16"	23 7/16"	1 1/4"	D1W723036NQ	806.	887.	967.	1,048.
	77 13/16"	29 1/2"	23 1/2"	30 7/16"	23 7/16"	1 1/4"	D1W782430NQ	781.	859.	937.	1,015.
	77 13/16"	35 1/2"	23 1/2"	14 15/16"	23 7/16"	1 1/4"	D1W782436NQ	869.	956.	1,043.	1,130.
	83 13/16"	35 1/2"	23 1/2"	14 15/16"	23 7/16"	1 1/4"	D1W842436NQ	896.	986.	1,075.	1,165.
	89 13/16"	29 1/2"	23 1/2"	30 7/16"	23 7/16"	1 1/4"	D1W902430NQ	886.	975.	1,063.	1,152.
	95 13/16"	29 1/2"	23 1/2"	39"	23 7/16"	1 1/4"	D1W962430NQ	945.	1,040.	1,134.	1,229.
	95 13/16"	35 1/2"	23 1/2"	14 15/16"	23 7/16"	1 1/4"	D1W962436NQ	969.	1,066.	1,163.	1,260.
	95 13/16"	35 1/2"	23 1/2"	30 7/16"	23 7/16"	1 1/4"	D1W963036NQ	969.	1,066.	1,163.	1,260.

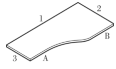

Ordering Information

Worksurfaces

1. Pattern Number
2. Laminate Finish
3. Edge Band Finish

Order Code

Worksurfaces

Example: **D1R 302430N Q, 114, 114**

D1R Pattern Number
302430N

Q14 Folkstone
Grey Laminate

114 Folkstone Grey Edge
Band

Included with:

Worksurfaces

Options

Worksurfaces

- Center-Located Edge Grommet
To specify, replace the "N" suffix from the pattern number with "G".
Add \$18.
- Woodgrain PVC edge
- Metal edge

Dividends Worksurfaces

Rectilinear Corner, Split Top Corner

Standard Specials Systems

description	1	2	3	4	t	pattern no.	PVC edge	woodgrain PVC edge	metal edge	techgrain w/ techgrain edge
Rectilinear Corner Worksurface. 30" Deep Return Left 30" Deep Return Right With Grommets	42"	42"	30"	30"	1 1/4"	D1C4230GQ	\$612.	\$673.	\$734.	\$1,132.
Rectilinear Corner Worksurface. 30" Deep Return Left 30" Deep Return Right No Grommets	42"	42"	30"	30"	1 1/4"	D1C4230NQ	579.	637.	695.	1,102.
Rectilinear Corner Worksurface. 36" Deep Return Left 36" Deep Return Right With Grommets	48"	48"	36"	36"	1 1/4"	D1C4836GQ	695.	765.	834.	1,269.
Rectilinear Corner Worksurface. 36" Deep Return Left 36" Deep Return Right No Grommets	48"	48"	36"	36"	1 1/4"	D1C4836NQ	662.	728.	794.	1,239.
Split Top Corner Worksurface With Grommets	36"	36"	24"	24"	1 1/4"	D1CS3624GQ	1,777.	1,955.	2,132.	3,082.
Split Top Corner Worksurface No Grommets	36"	36"	24"	24"	1 1/4"	D1CS3624NQ	1,744.	1,918.	2,093.	3,052.



Ordering Information

Worksurfaces

1. Pattern Number
2. Laminate Finish
3. Edge Band Finish

Split Top Corner Worksurfaces

1. Pattern Number
2. Laminate Finish
3. Edge Band Finish

Order Code

Worksurfaces

Example: **D1C 4230G Q 117, 115**

D1C Pattern Number
4230G Q

117 Soft Grey Laminate

115 Medium Grey Edge Band

Split Top Corner Worksurfaces

Example: **D1CS 3624G Q 117, 117**

D1CS Pattern Number
3624G Q

117 Soft Grey Laminate

117 Soft Grey Edge Band

Included with:

Worksurfaces

- Worksurface
- Panel-to-Worksurface Bracket
- Split Top Corner Worksurfaces

Split Top Corner Worksurfaces

- Front Worksurface
- Back Worksurface
- Split Top Mechanism
- Flat Brackets
- Panel-to-Worksurface Bracket

Options

Worksurfaces

- 2 Center-Located Edge Grommets
- Woodgrain PVC edge
- Metal edge

Worksurfaces

- 2 Center-Located Edge Grommets
- Woodgrain PVC edge
- Metal edge

Dividends Worksurfaces
Curvilinear Corner
“L” Shape-24” Depths

description	1	2	3	4	t	pattern no.	PVC edge	woodgrain PVC edge	metal edge	techgrain w/ techgrain edge
Curvilinear Corner “L” Shape Worksurface 24”	36”	48”	24”	24”	1 1/4”	D1L3648SSNQ	\$622.	\$684.	\$746.	\$1,120.
Deep Returns Left and Right No Grommet	36”	54”	24”	24”	1 1/4”	D1L3654SSNQ	700.	770.	840.	1,260.
	36”	60”	24”	24”	1 1/4”	D1L3660SSNQ	771.	848.	925.	1,388.
	36”	72”	24”	24”	1 1/4”	D1L3672SSNQ	821.	903.	985.	1,478.
	36”	78”	24”	24”	1 1/4”	D1L3678SSNQ	830.	913.	996.	1,494.
	42”	48”	24”	24”	1 1/4”	D1L4248SSNQ	629.	692.	755.	1,132.
	42”	54”	24”	24”	1 1/4”	D1L4254SSNQ	771.	848.	925.	1,388.
	42”	84”	24”	24”	1 1/4”	D1L4284SSNQ	1,036.	1,140.	1,243.	1,865.
	48”	36”	24”	24”	1 1/4”	D1L4836SSNQ	622.	684.	746.	1,120.
	48”	42”	24”	24”	1 1/4”	D1L4842SSNQ	629.	692.	755.	1,132.
	48”	54”	24”	24”	1 1/4”	D1L4854SSNQ	779.	857.	935.	1,402.
	48”	78”	24”	24”	1 1/4”	D1L4878SSNQ	923.	1,015.	1,108.	1,661.
	48”	96”	24”	24”	1 1/4”	D1L4896SSNQ	1,154.	1,269.	1,385.	2,077.
	54”	36”	24”	24”	1 1/4”	D1L5436SSNQ	700.	770.	840.	1,260.
	54”	42”	24”	24”	1 1/4”	D1L5442SSNQ	771.	848.	925.	1,388.
	54”	48”	24”	24”	1 1/4”	D1L5448SSNQ	779.	857.	935.	1,402.
	60”	36”	24”	24”	1 1/4”	D1L6036SSNQ	771.	848.	925.	1,388.
	72”	36”	24”	24”	1 1/4”	D1L7236SSNQ	821.	903.	985.	1,478.
	78”	36”	24”	24”	1 1/4”	D1L7836SSNQ	830.	913.	996.	1,494.
	84”	42”	24”	24”	1 1/4”	D1L8442SSNQ	1,036.	1,140.	1,243.	1,865.
	96”	48”	24”	24”	1 1/4”	D1L9648SSNQ	1,154.	1,269.	1,385.	2,077.

Ordering Information

1. **Worksurfaces**
2. Pattern Number
3. Laminate Finish
4. Edge Band Finish

Order Code

Worksurfaces	
<i>Example:</i> D1L 3648SSN Q M42, E	
D1L	Pattern Number
3648SSN	
M42	Soft grey laminate
E	Edge Band

Included With:

- Worksurfaces**
 Worksurface
 Panel-to-Worksurface Bracket

Options

- Worksurfaces**
- 2 center-located edge grommets
 To specify, replace the “N” suffix from the pattern number with “G”
Add \$28
 - Woodgrain PVC edge
 - Metal edge

Dividends Worksurfaces

Curvilinear Corner

"L" Shape-30" Depths

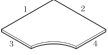
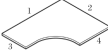
description	1	2	3	4	t	pattern no.	PVC edge	woodgrain PVC edge	metal edge	techgrain w/ techgrain edge
Curvilinear Corner "L" Shape Worksurface 30"	42"	42"	30"	30"	1 1/4"	D1L4242DDNQ	\$679.	\$747.	\$815.	\$1,222.
Deep Returns Left and Right No Grommet	42"	60"	30"	30"	1 1/4"	D1L4260DDNQ	791.	870.	949.	1,424.
	42"	66"	30"	30"	1 1/4"	D1L4266DDNQ	829.	912.	995.	1,492.
	42"	72"	30"	30"	1 1/4"	D1L4272DDNQ	868.	955.	1,042.	1,562.
	48"	60"	30"	30"	1 1/4"	D1L4860DDNQ	829.	912.	995.	1,492.
	48"	66"	30"	30"	1 1/4"	D1L4866DDNQ	867.	954.	1,040.	1,561.
	48"	72"	30"	30"	1 1/4"	D1L4872DDNQ	906.	997.	1,087.	1,631.
	48"	84"	30"	30"	1 1/4"	D1L4884DDNQ	1,024.	1,126.	1,229.	1,843.
	48"	96"	30"	30"	1 1/4"	D1L4896DDNQ	1,142.	1,256.	1,370.	2,056.
	60"	42"	30"	30"	1 1/4"	D1L6042DDNQ	791.	870.	949.	1,424.
	60"	48"	30"	30"	1 1/4"	D1L6048DDNQ	829.	912.	995.	1,492.
	66"	42"	30"	30"	1 1/4"	D1L6642DDNQ	829.	912.	995.	1,492.
	66"	48"	30"	30"	1 1/4"	D1L6648DDNQ	867.	954.	1,040.	1,561.
	72"	42"	30"	30"	1 1/4"	D1L7242DDNQ	868.	955.	1,042.	1,562.
	72"	48"	30"	30"	1 1/4"	D1L7248DDNQ	906.	997.	1,087.	1,631.
	84"	48"	30"	30"	1 1/4"	D1L8448DDNQ	1,024.	1,126.	1,229.	1,843.
	96"	48"	30"	30"	1 1/4"	D1L9648DDNQ	1,142.	1,256.	1,370.	2,056.

Ordering Information

1. Worksurfaces
2. Pattern Number
3. Laminate Finish
4. Edge Band Finish

Order Code

Worksurfaces	
<i>Example:</i>	D1L 4272DDN Q, 117, 117
D1L	Pattern Number
4272DDN	
Q17	Soft Grey laminate
117	Soft Grey Edge Band

Included with:

Worksurfaces
 Worksurface
 Panel-to-Worksurface Bracket

Options

- Worksurfaces**
- 2 center-located edge grommets
 To specify, replace the "N" suffix from the pattern number with "G"
Add \$28
 - Woodgrain PVC edge
 - Metal edge

Dividends Worksurfaces

Curvilinear Corner

"L" Shape-Mixed Depths

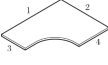
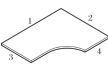
description	1	2	3	4	t	pattern no.	PVC edge	woodgrain PVC edge	metal edge	techgrain w/ techgrain edge
Curvilinear Corner "L" Shape Worksurface 24" Deep Return Left and 30" Deep Return Right	36"	48"	24"	30"	1 1/4"	D1L3648SDNQ	\$656.	\$722.	\$787.	\$1,181.
	36"	54"	24"	30"	1 1/4"	D1L3654SDNQ	730.	803.	876.	1,314.
	42"	42"	24"	30"	1 1/4"	D1L4242SDNQ	663.	729.	796.	1,193.
	42"	48"	24"	30"	1 1/4"	D1L4248SDNQ	670.	737.	804.	1,206.
	42"	66"	24"	30"	1 1/4"	D1L4266SDNQ	804.	884.	965.	1,447.
	42"	72"	24"	30"	1 1/4"	D1L4272SDNQ	843.	927.	1,012.	1,517.
	48"	42"	24"	30"	1 1/4"	D1L4842SDNQ	670.	737.	804.	1,206.
	48"	78"	24"	30"	1 1/4"	D1L4878SDNQ	902.	992.	1,082.	1,624.
	48"	84"	24"	30"	1 1/4"	D1L4884SDNQ	961.	1,057.	1,153.	1,730.
	54"	36"	24"	30"	1 1/4"	D1L5436SDNQ	730.	803.	876.	1,314.
	66"	42"	24"	30"	1 1/4"	D1L6642SDNQ	804.	884.	965.	1,447.
	84"	48"	24"	30"	1 1/4"	D1L8448SDNQ	961.	1,057.	1,153.	1,730.
	Curvilinear Corner "L" Shape Worksurface 30" Deep Return Left and 24" Deep Return Right	36"	48"	30"	24"	1 1/4"	D1L3648DSNQ	656.	722.	787.
	42"	42"	30"	24"	1 1/4"	D1L4242DSNQ	663.	729.	796.	1,193.
	42"	48"	30"	24"	1 1/4"	D1L4248DSNQ	670.	737.	804.	1,206.
	42"	66"	30"	24"	1 1/4"	D1L4266DSNQ	804.	884.	965.	1,447.
	42"	72"	30"	24"	1 1/4"	D1L4272DSNQ	843.	927.	1,012.	1,517.
	48"	78"	30"	24"	1 1/4"	D1L4878DSNQ	902.	992.	1,082.	1,624.
	48"	84"	30"	24"	1 1/4"	D1L4884DSNQ	961.	1,057.	1,153.	1,730.
	48"	96"	30"	24"	1 1/4"	D1L4896DSNQ	1,079.	1,187.	1,295.	1,942.
	54"	36"	30"	24"	1 1/4"	D1L5436DSNQ	730.	803.	876.	1,314.
	66"	42"	30"	24"	1 1/4"	D1L6642DSNQ	804.	884.	965.	1,447.
	84"	48"	30"	24"	1 1/4"	D1L8448DSNQ	961.	1,057.	1,153.	1,730.

Ordering Information

Worksurfaces

1. Pattern Number
2. Laminate Finish
3. Edge Band Finish

Note: "S" = 24"D
"D" = 30"D

Order Code

Worksurfaces

Example: **D1L 4272SDN Q, CH, Y1**

D1L Pattern Number

4272SDN

QH Chiffon Laminate

Y1 Pewter edge band

Included with:

Worksurfaces

- Worksurface
- Panel-to-worksurface bracket

Options



Worksurfaces

- 2 center-located edge grommets
To specify, replace the "N" suffix from the pattern number with "G"
Add \$28
- Woodgrain PVC edge
- Metal edge

Dividends Worksurfaces

“D”, “P” and “9” Peninsula, And Corner Round Worksurface

Standard Specials Systems

description	w	d	pattern no.	PVC edge	woodgrain PVC edge	metal edge	techgrain w/ techgrain edge
“D” Peninsula Worksurface 	30	24	D1D3024NQ	\$440.	\$484.	\$528.	\$792.
	30	30	D1D3030NQ	487.	536.	584.	877.
	36	24	D1D3624NQ	460.	506.	552.	828.
	36	30	D1D3630NQ	507.	558.	608.	913.
	54	24	D1D5424NQ	519.	571.	623.	934.
	54	30	D1D5430NQ	647.	712.	776.	1,165.
	54	36	D1D5436NQ	769.	846.	923.	1,384.
	60	24	D1D6024NQ	578.	636.	694.	1,040.
	60	36	D1D6036NQ	793.	872.	952.	1,427.
	66	24	D1D6624NQ	637.	701.	764.	1,147.
	66	36	D1D6636NQ	813.	894.	976.	1,463.
	72	24	D1D7224NQ	696.	766.	835.	1,253.
	78	24	D1D7824NQ	755.	831.	906.	1,359.
	78	30	D1D7830NQ	803.	883.	964.	1,445.
	78	36	D1D7836NQ	872.	959.	1,046.	1,570.
	84	24	D1D8424NQ	814.	895.	977.	1,465.
	84	30	D1D8430NQ	862.	948.	1,034.	1,552.
	84	36	D1D8436NQ	931.	1,024.	1,117.	1,676.
	96	24	D1D9624NQ	930.	1,023.	1,116.	1,674.
96	30	D1D9630NQ	955.	1,051.	1,146.	1,719.	
96	36	D1D9636NQ	1,049.	1,154.	1,259.	1,888.	
Conferencing worksurface (left hand shown) 	60	48	DB1BD48DLQ	1,118.	1,230.	1,342.	2,846.
	60	48	DB1BD48DRQ	1,118.	1,230.	1,342.	2,846.
Blended “D” Peninsula Worksurface (left hand shown) 	54	48	D1BD5448DLQ	766.	843.	919.	3,092.
		48	D1BD5448DRQ	766.	843.	919.	3,092.
		48	D1BD5448SLQ	738.	812.	886.	3,042.
		48	D1BD5448SRQ	738.	812.	886.	3,042.
	60	48	D1BD6048DLQ	791.	870.	949.	3,197.
		48	D1BD6048DRQ	791.	870.	949.	3,197.

Ordering Information

- “D” Worksurface**
1. Pattern Number
 2. Laminate Finish
 3. Edge Band Finish

Order Code

“D” Worksurface
Example: **D1BD 5448DL Q, 114, 114**

D1BD Pattern Number
5448 DL Q

114 Folkstone Grey Laminate

114 Folkstone grey Edge Band

Included with:



- “D” Worksurface**
- Worksurface
- Note: Support column and panel-to-worksurface brackets must be ordered separately.

Options

- “D” Worksurfaces**
- Woodgrain PVC edge
 - Metal edge

Dividends Worksurfaces
 “D”, “P” and “9” Peninsula,
 And Corner Round Worksurface

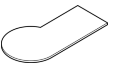
Standard Specials Systems

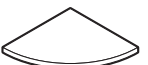
description	w	d	pattern no.	PVC edge	woodgrain PVC edge	metal edge	techgrain w/ techgrain edge	
Blended “D” Peninsula Worksurface (left hand shown) 	60	48	D1BD6048SLQ	\$752.	\$827.	\$902.	\$3,038.	
		48	D1BD6048SRQ	752.	827.	902.	3,038.	
	72	42	D1BD7242DLQ	820.	902.	984.	3,313.	
		42	D1BD7242DRQ	820.	902.	984.	3,313.	
		42	D1BD7242SLQ	768.	845.	922.	3,263.	
		42	D1BD7242SRQ	768.	845.	922.	3,263.	
	78	48	D1BD7848DLQ	879.	967.	1,055.	3,734.	
		48	D1BD7848DRQ	879.	967.	1,055.	3,734.	
		48	D1BD7848SLQ	827.	910.	992.	3,684.	
		48	D1BD7848SRQ	827.	910.	992.	3,684.	
	84	48	D1BD8448DLQ	938.	1,032.	1,126.	4,048.	
		48	D1BD8448DRQ	938.	1,032.	1,126.	4,048.	
		48	D1BD8448SLQ	886.	975.	1,063.	3,821.	
		48	D1BD8448SRQ	886.	975.	1,063.	3,821.	
	Peninsula Worksurface, P-shaped 	54	30	D1P5430NQ	727.	800.	872.	1,999.
		60	30	D1P6030NQ	739.	813.	887.	2,032.
78		36	D1P7836NQ	927.	1,020.	1,112.	2,549.	
84		30	D1P8430NQ	904.	994.	1,085.	2,486.	
90		30	D1P9030NQ	963.	1,059.	1,156.	2,648.	
Peninsula Worksurface, 9-shaped 	54	30	D195430NQ	727.	800.	872.	1,999.	
	60	30	D196030NQ	739.	813.	887.	2,032.	
	78	36	D197836NQ	927.	1,020.	1,112.	2,549.	
	84	30	D198430NQ	904.	994.	1,085.	2,486.	
	90	30	D199030NQ	963.	1,059.	1,156.	2,648.	
Corner Round Worksurface 	30	30	D1CRR30Q	296.	326.	355.	1,302.	

Ordering Information

- “D” Worksurface**
 1. Pattern Number
 2. Laminate Finish
 3. Edge Band Finish

Order Code

“D” Worksurface
Example: **D1BD 5448DL Q, 114, 114**

D1BD Pattern Number
5448 DL Q

114 Folkstone Grey Laminate

114 Folkstone grey Edge Band

Included with:

- “D” Worksurface**
 • Worksurface
 Note: Support column and panel-to-worksurface brackets must be ordered separately.

Options

- “D” Worksurfaces**
 • Woodgrain PVC edge
 • Metal edge

Dividends Table Supports

Double Y Leg Base

Standard Specials Systems

Dividends Horizon System

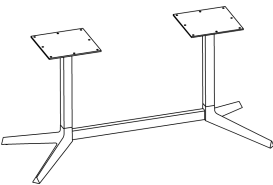
description	type	pattern no.	P1/P2/P3
 <p>Y-Base, Double with stretcher</p>	For use with 60" Wide x 24" or 30" Deep	DT1BYD602430Q	\$965.
	For use with 60" Wide x 36" Deep	DT1BYD6036Q	970.
	For use with 66" Wide x 24" or 30" Deep	DT1BYD662430Q	975.
	For use with 66" Wide x 36" Deep	DT1BYD6636Q	980.
	For use with 72" Wide x 24" or 30" Deep	DT1BYD722430Q	985.
	For use with 72" Wide x 36" Deep	DT1BYD7236Q	990.
	For use with 72" Wide x 42" Deep	DT1BYD7242Q	990.
	For use with 78" Wide x 24" or 30" Deep	DT1BYD782430Q	995.
	For use with 78" Wide x 36" Deep	DT1BYD7836Q	1,000.
	For use with 78" Wide x 42" Deep	DT1BYD7842Q	1,000.
	For use with 84" Wide x 24" or 30" Deep	DT1BYD842430Q	1,005.
	For use with 84" Wide x 36" Deep	DT1BYD8436Q	1,010.
	For use with 84" Wide x 42" Deep	DT1BYD8442Q	1,010.
	For use with 90" Wide x 24" or 30" Deep	DT1BYD902430Q	1,015.
	For use with 90" Wide x 36" Deep	DT1BYD9036Q	1,020.
	For use with 90" Wide x 42" Deep	DT1BYD9042Q	1,020.
	For use with 96" Wide x 24" or 30" Deep	DT1BYD962430Q	1,025.
	For use with 96" Wide x 36" Deep	DT1BYD9636Q	1,030.
	For use with 96" Wide x 42" Deep	DT1BYD9642Q	1,030.

Ordering Information

Table Supports:

1. Pattern number
2. Paint Finish

Order Code

Double Y Leg Base:

Example: **DT1BYD,114**

DT1 Dividends Horizon
Table

B Base

YD Double Y

114 Paint Finish

Included with:

Note: Table supports are only available in Knoll core finishes.

description	w	d	h	pattern no.	list	P1	P2	P3
Coat hook, 4 per pkg. For Flat top cap				DP5CHQ	\$226.			
Wall mounted bracket with cover For 14"h panel mounted sliding door overheads	30"		14"	DS3WMC1430Q		181.	197.	213.
	33"		14"	DS3WMC1433Q		185.	201.	217.
	36"		14"	DS3WMC1436Q		185.	201.	217.
	42"		14"	DS3WMC1442Q		188.	205.	221.
	48"		14"	DS3WMC1448Q		194.	212.	229.
Wall mounted bracket with cover For 21"h panel mounted sliding door overheads	30"		21"	DS3WMC2130Q		225.	246.	266.
	33"		21"	DS3WMC2133Q		230.	251.	271.
	36"		21"	DS3WMC2136Q		230.	251.	271.
	42"		21"	DS3WMC2142Q		248.	271.	293.
	48"		21"	DS3WMC2148Q		262.	286.	309.
Aluminum shelf with panel brackets	18"	8"	1"	DS1AS18Q()()	424.			
	24"	8"	1"	DS1AS24Q()()	447.			
	30"	8"	1"	DS1AS30Q()()	476.			
	36"	8"	1"	DS1AS36Q()()	504.			
	42"	8"	1"	DS1AS42Q()()	530.			
	48"	8"	1"	DS1AS48Q()()	553.			
	54"	8"	1"	DS1AS54Q()()	579.			
	60"	8"	1"	DS1AS60Q()()	605.			
	66"	8"	1"	DS1AS72Q()()	629.			
	72"	8"	1"	DS1AS66Q()()	653.			

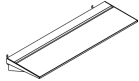

Ordering Information

Coat hook

1. Pattern Number
2. Paint Finish

Wall mounted bracket with cover

1. Pattern Number
2. Paint Finish

Application Notes

Wall mounted bracket with cover

For 60" wide overhead, use (2x) 30" brackets
 For 66" wide overhead, use (2x) 33" brackets
 For 72" wide overhead, use (2x) 36" brackets

Cover is required for aesthetics purpose

Aluminum display shelf

Aluminum display shelves provide an additional level of storage between the worksurface and standard overhead storage.

Aluminum display shelves include brackets for support from vertical panel connector tracks.

Shelves may be mounted on any combination of vertical panels of the same total width.

Shelves may extend 12" past the mounting bracket on either side.

Dividends Electrical
Alternative Electrical Specification
 8-wire (2+1) and 10-wire (2+2) Electrical Systems

Dividends Horizon Electrical Specifications

Wiring Diagram

8-wire / 3-circuit (2+1)

INDEPENDENT
 NEUTRAL

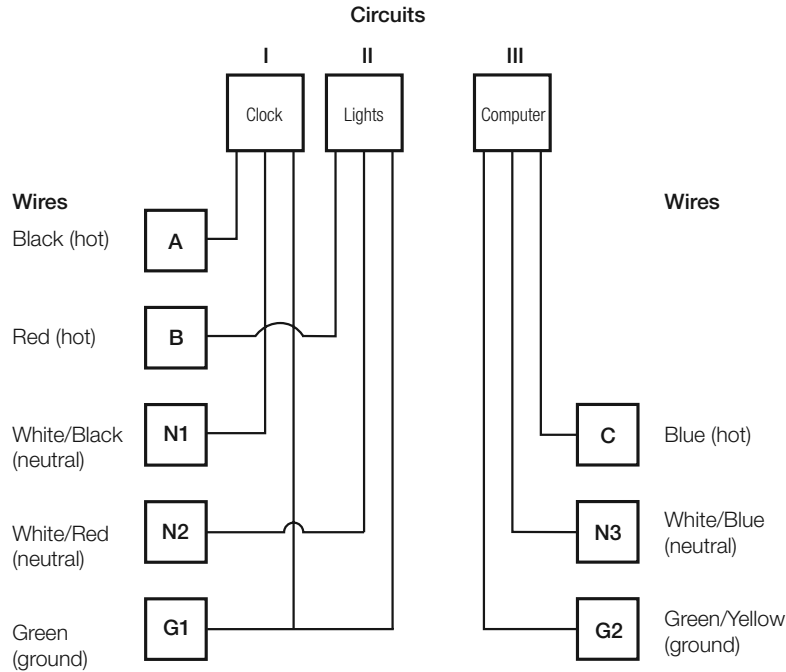

Wiring Diagram

10-wire / 4-circuit (2+2)

INDEPENDENT
 NEUTRAL

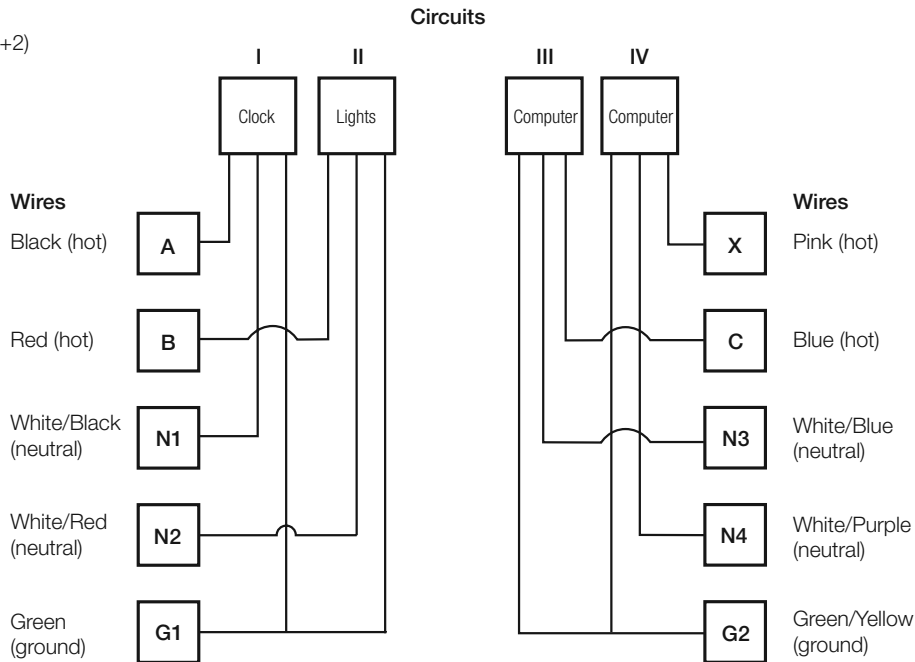







Please note that electrical components (i.e. power module, power jumpers and receptacles) from the 8 and 10-wire electrical systems with independent neutrals **cannot** be used with the 8-wire (3+1 and 2+2) and 10-wire (3+3) electrical systems that have shared neutrals.

Base Raceway

Power Modules, Connectors and Jumpers





8-wire (2+1) and 10-wire (2+2)

description	type	pattern no.	list	OE	OT
Power Module - Double sided for raceway on both sides 	24"W Panel	DE(0E/0T)PM24Q		\$113.	\$117.
	30"W Panel	DE(0E/0T)PM30Q		120.	121.
	36"W Panel	DE(0E/0T)PM36Q		134.	129.
	42"W Panel	DE(0E/0T)PM42Q		134.	136.
	48"W Panel	DE(0E/0T)PM48Q		141.	144.
Power Connector (power module-to-power module) 	12" no post	DE(0E/0T)PCNPQ		73.	87.
	15" with post	DE(0E/0T)PCWPQ		79.	93.
Power Jumper 	18" W Panel	DE(0E/0T)PJ18NPQ		92.	115.
	24" W Panel	DE(0E/0T)PJ24NPQ		96.	121.
	30" W Panel	DE(0E/0T)PJ30NPQ		100.	126.
	36" W Panel	DE(0E/0T)PJ36NPQ		105.	131.
	42" W Panel	DE(0E/0T)PJ42NPQ		111.	137.
	48" W Panel	DE(0E/0T)PJ48NPQ		118.	142.
Power Jumper (with post) 	18" W Panel + Post	DE(0E/0T)PJ18WPQ		93.	119.
	24" W Panel + Post	DE(0E/0T)PJ24WPQ		98.	122.
	30" W Panel + Post	DE(0E/0T)PJ30WPQ		101.	128.
	36" W Panel + Post	DE(0E/0T)PJ36WPQ		109.	134.
	42" W Panel + Post	DE(0E/0T)PJ42WPQ		116.	140.
	48" W Panel + Post	DE(0E/0T)PJ48WPQ		125.	142.
Multiple Panel Power Jumper (with or without post) 	54"W Panel Run	DE(0E/0T)PJ54WPQ		132.	152.
	60"W Panel Run	DE(0E/0T)PJ60WPQ		138.	159.
	66"W Panel Run	DE(0E/0T)PJ66WPQ		138.	159.
	72"W Panel Run	DE(0E/0T)PJ72WPQ		147.	165.
	78"W Panel Run	DE(0E/0T)PJ78WPQ		148.	181.
	84"W Panel Run	DE(0E/0T)PJ84WPQ		164.	185.
	96"W Panel Run	DE(0E/0T)PJ96WPQ		168.	191.
Receptacles 	Duplex circuit 1	DE0DRAQ	38.		
	Duplex circuit 2	DE0DRBQ	38.		
	Duplex circuit 3	DE0DRCQ	38.		
	Duplex circuit 4	DE0DRXQ	38.		

Ordering Information	Order Code	Included with:	Options
Power Jumper 1. Pattern Number	Power Jumper <i>Example:</i> DE0EPJ18NPQ DE0E Pattern Number PJ42NPQ	Power Jumper Note: Double-sided power module will not fit in a panel base raceway with tile to the floor on one side.	Power Jumper Options (0E) = 8 wire 2+1 (0T) = 10 wire 2+2

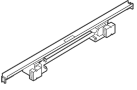
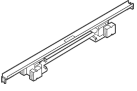
Beltway

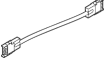
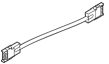
Power Modules, Power Connectors and Power Jumpers

description	type	pattern no.	OE	OT
Beltway Power Module 1-Side 	30"	DE(0E/0T)BPM301Q	\$217.	\$232.
	36"	DE(0E/0T)BPM361Q	225.	240.
	42"	DE(0E/0T)BPM421Q	238.	247.
	48"	DE(0E/0T)BPM481Q	242.	257.
Beltway Power Module 2-Side 	30"	DE(0E/0T)BPM302Q	210.	242.
	36"	DE(0E/0T)BPM362Q	218.	250.
	42"	DE(0E/0T)BPM422Q	235.	258.
	48"	DE(0E/0T)BPM482Q	236.	266.
Beltway Power Connector 	17" no post	DES(0E/0T)BPCNPQ	79.	107.
	20" with post	DES(0E/0T)BPCWPQ	87.	109.
Beltway Power Jumper (no post) 	18"	DES(0E/0T)BPJ18NPQ	104.	118.
	24"	DES(0E/0T)BPJ24NPQ	108.	123.
	30"	DES(0E/0T)BPJ30NPQ	113.	130.
	36"	DES(0E/0T)BPJ36NPQ	118.	134.
	42"	DES(0E/0T)BPJ42NPQ	123.	140.
	48"	DES(0E/0T)BPJ48NPQ	128.	145.
Beltway Power Jumper (with post) 	18"	DES(0E/0T)BPJ18WPQ	107.	121.
	24"	DES(0E/0T)BPJ24WPQ	111.	126.
	30"	DES(0E/0T)BPJ30WPQ	116.	130.
	36"	DES(0E/0T)BPJ36WPQ	120.	134.
	42"	DES(0E/0T)BPJ42WPQ	129.	144.
	48"	DES(0E/0T)BPJ48WPQ	133.	148.
Multiple Panel Power Jumper (with or without post) 	54"	DES(0E/0T)BPJ54WPQ	138.	152.
	60"	DES(0E/0T)BPJ60WPQ	142.	160.
	66"	DES(0E/0T)BPJ66WPQ	147.	165.
	72"	DES(0E/0T)BPJ72WPQ	152.	168.
	78"	DES(0E/0T)BPJ78WPQ	156.	172.
	84"	DES(0E/0T)BPJ84WPQ	166.	175.
	96"	DES(0E/0T)BPJ96WPQ	178.	192.

Ordering Information

Beltway Power Jumper
1. Pattern Number

Order Code

Beltway Power Jumper
Example: **DES0EBPJ18NPQ**
DES0EBP Pattern Number
J18NPQ

Included with:



Beltway Power Jumper

Options

Beltway Power Jumper
Options
(0E) = 8 wire 2+1
(0T) = 10 wire 2+2

Beltway

Power Modules, Power Connectors and Power Jumpers

description	type	pattern no.	OE	OT
90° Beltway Power Jumper 	30" beltway panel	DE(0E/0T)PJ120WPQ	\$208.	\$238.
	36" beltway panel	DE(0E/0T)PJ126WPQ	215.	246.
	42" beltway panel	DE(0E/0T)PJ138WPQ	225.	258.
	48" beltway panel	DE(0E/0T)PJ144WPQ	234.	264.
Vertical Power Jumper (within same panel) 		DE(0E/0T)VPJQ	178.	184.
Vertical Power Jumper (from adjacent panel) 	30" beltway panel	DE(0E/0T)PJ48WPQ	125.	142.
	36"&42" beltway panel	DE(0E/0T)PJ54WPQ	132.	152.
	48" beltway panel	DE(0E/0T)PJ60WPQ	138.	159.

Ordering Information

Order Code

Included with:

Options

Beltway Power Jumper

Beltway Power Jumper

Beltway Power Jumper

Beltway Power Jumper

1. Pattern Number

Example: **DES0EBPJ18NPQ**

DES0EBP Pattern Number
J18NPQ

Options
(OE) = 8 wire 2+1
(OT) = 10 wire 2+2



Dividends Electrical

Infeeds

Base Power and Raceway-to-Ceiling Infeeds

Standard Specials Systems

Dividends Horizon System

description	length	pattern no.	OE	OT
Base Power Infeed (specify left or right) 	56"	DE(OE/OT)BI56(L/R)Q	\$188.	\$254.
Base Power Infeed (reversible) 	56"	DE(OE/OT)RBI56Q	250.	302.
Raceway-to-Ceiling Infeed 	19 1/2'	DE(OE/OT)CI144Q	285.	342.

Ordering Information

Base Power Infeed (L/R)

1. Pattern Number

Order Code

Base Power Infeed (L/R)

Example: **DE18 BI56(L)**

DE18 Pattern Number (left
BI56(L) entry)

Included with:

Base Power Infeed (L/R)

Options

Base Power Infeed

Options

(OE) = 8 wire 2+1
(OT) = 10 wire 2+2

Base Power infeed (L/R):
To Specify direction of entry, add
either and "L" or "R" suffix to the
pattern number.

Dividends T5 Task Lights

Daisy Chain

description	type	w	d	h	pattern no.	Standard	Advanced
Task Light, starter 9 ft. cord, fused male plug 1 ft. cord, female plug	Use with 24" and wider overhead	19"	4"	1 1/2"	DL3T5E19()DCS()Q	\$308.	n/a
	Use with 30" and wider overhead	25"	4"	1 1/2"	DL3T5E25()DCS()Q	321.	568.
	Use with 42" and wider overhead	37"	4"	1 1/2"	DL3T5E37()DCS()Q	325.	591.
	Use with 60" and wider overhead	49"	4"	1 1/2"	DL3T5E49()DCS()Q	351.	608.

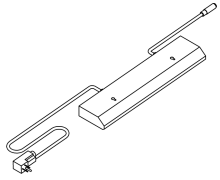

left hand shown

Task Light, adder 2 ft. cord, male plug 1 ft. cord, female plug	Use with 24" and wider overhead	19"	4"	1 1/2"	DL3T5E19()DCA()Q	340.	n/a
	Use with 30" and wider overhead	25"	4"	1 1/2"	DL3T5E25()DCA()Q	353.	600.
	Use with 42" and wider overhead	37"	4"	1 1/2"	DL3T5E37()DCA()Q	357.	623.
	Use with 60" and wider overhead	49"	4"	1 1/2"	DL3T5E49()DCA()Q	383.	640.

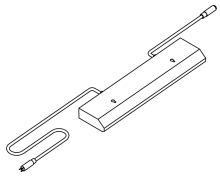

left hand shown

Task Light, ender 2 ft. cord, male plug	Use with 24" and wider overhead	19"	4"	1 1/2"	DL3T5E19()DCE()Q	227.	n/a
	Use with 30" and wider overhead	25"	4"	1 1/2"	DL3T5E25()DCE()Q	240.	487.
	Use with 42" and wider overhead	37"	4"	1 1/2"	DL3T5E37()DCE()Q	244.	510.
	Use with 60" and wider overhead	49"	4"	1 1/2"	DL3T5E49()DCE()Q	270.	527.

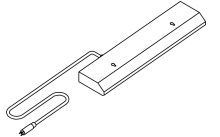

left hand shown

Order Code	Specification Information	Application Notes
Example: DL3T5E19SDCSLQ	<i>Specify:</i>	Task lights mount into the recess in the underside of overhead cabinets and shelves at least 5" wider than task light width.
DL3 Dividends Task Light	Width - Task Lights mount in cabinets and shelves at least 5" wider than light width.	Task lights include T5 cool white (4100K) fluorescent lamp, electronic ballast, prismatic lens, rocker switch, one cord exit management clip and mounting hardware.
T5 T5 lamp	1. Type: (S) Standard (A) Advanced	Cord management clips must be ordered separately.
E Electronic ballast	2. Handedness L= Left handed (male plug on user's left side) R=Right handed (male plug on user's right side)	Task lights are TCLP compliant and meet requirements of California Title 24.
19 Width	All housings are black.	Advanced task lights are fitted with ballast and lamp compliant with LEED requirements.
S Standard		
DC Daisy chain		
S Starter		
L Left handed		
Q Special		

Core finishes**Laminates**

111	Jet Black
114	Folkstone Grey (was LA)
117	Soft Grey (was M42)
118	Bright White
119	Pumice (was LF)
121	Micro Grey
122	Brushed Sand
123	Brushed Grey
124	Medium Cherry
125	Natural Maple
126	Natural Cherry
127	Walnut
128	Fog
129	Micro Sand

Worksurface Edge

111	Jet Black
113	Dark Grey (was Y3)
114	Folkstone Grey (was LA)
115	Medium Grey (was Y2)
117	Soft Grey (was E)
118	Bright White
119	Pumice (was LF)
124	Medium Cherry
125	Natural Maple
126	Natural Cherry
127	Walnut
128	Fog

Knoll Color Program Painted Trim**EP3 Panels***all other painted components***P1 Finishes**

111	Jet Black
112	Brown
113	Dark Grey (was Y3)
114	Folkstone Grey (was LA)
115	Med. Grey (was Y2)
116	Sandstone
117	Soft Grey (was E)

P2 Finishes

611	Beige Mist Metallic
612	Medium Metallic Grey

P3 Finishes

118	Bright White
613	Silver (was 3)

Insert Options*for insert panels, stack-on panels and
add-on screens.***Plexiglass**

CL	Clear
IC	Ice
SM	Smoked
TR	Translucent

**Lumasite (stack-on panels and
add-on screens only)**

LF	Frost
----	-------

Equity Generation 1

Door Panels and shrouds

Standard Specials Systems

description	type	w	h	pattern no.	list	add for P2	add for P3
36" Door panel	LH laminate door	36"	80"	EP1DL36LQ	\$2,077.	n/a	\$50.
	RH laminate door	36"	80"	EP1DL36RQ	2,077.	n/a	50.

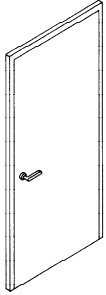

42" ADA Door panel	LH laminate door	42"	80"	EP1DL42LQ	2,433.	n/a	50.
	RH laminate door	42"	80"	EP1DL42RQ	2,433.	n/a	50.

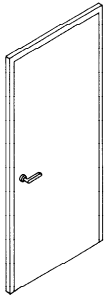

Order Code

Example: **EP1DL42LQ, 117, 117, 117**

EP1DL	Steel door panel
42	Width
LQ	Left handed
117	Soft Grey front/back finish
117	Soft Grey edgeband
117	Soft Grey trim

Specification Information

Specify one surface and/or trim color, as appropriate.

The direction the door pivots away from you determines the "hand."

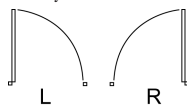

Post and post connectors must be ordered separately.

The door frame requires perpendicular support on the hinged side when the door is in an open position.

Application Notes

Two doors may not be placed back to back while sharing a single post connection. Doors in this application will not be properly supported and therefore no shroud exists to cover a back-to-back base opening.

All 42" and 48" wide doors provide a minimum opening clearance of 32" and are compliant with the Americans with Disabilities Act. The 36" door opening is less than 32" and is not ADA compliant.

All doors come with locking lever handset. Handset is ADA compliant.

An adaptor cup is included to connect the door to adjoining panels. Door shrouds give a finished look to door frames.

NOTE: EP1 & EP2 Panels and components are available in legacy colors only.

Equity Generation 1

Door Panels and shrouds

description	type	w	h	pattern no.	list	add for P2	add for P3
48" ADA Door panel	LH laminate door	48"	80"	EP1DL48LQ	\$3,331.	n/a	\$50.
	RH laminate door	48"	80"	EP1DL48RQ	3,331.	n/a	50.

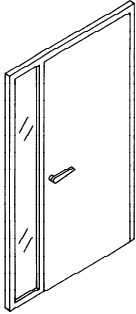

Door shrouds			
	LH corner door shroud	EP1SDOLQ	13.
	LH straight door shroud	EP1SDSLQ	13.
	RH corner door shroud	EP1SDORQ	13.
	RH straight door shroud	EP1SDSRQ	13.

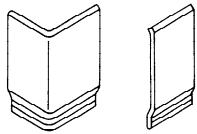

Order Code

Example: **EP1DL42LQ, 117, 117, 117**

EP1DL	Steel door panel
42	Width
LQ	Left handed
117	Soft Grey front/back finish
117	Soft Grey edgeband
117	Soft Grey trim

Specification Information

Specify one surface and/or trim color, as appropriate.

The direction the door pivots away from you determines the "hand."

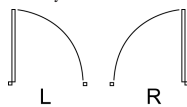

Post and post connectors must be ordered separately.

The door frame requires perpendicular support on the hinged side when the door is in an open position.

Application Notes

Two doors may not be placed back to back while sharing a single post connection. Doors in this application will not be properly supported and therefore no shroud exists to cover a back-to-back base opening.

All 42" and 48" wide doors provide a minimum opening clearance of 32" and are compliant with the Americans with Disabilities Act. The 36" door opening is less than 32" and is not ADA compliant.

All doors come with locking lever handset. Handset is ADA compliant.

An adaptor cup is included to connect the door to adjoining panels. Door shrouds give a finished look to door frames.

NOTE: EP1 & EP2 Panels and components are available in legacy colors only.

Equity Generation 3

Door Panels and shrouds

description	type	w	h	pattern no.	list	add for P2	add for P3
36" Door panel	LH laminate door	36"	81"	EP3DL36LQ	\$2,077.	\$25.	\$50.
	RH laminate door	36"	81"	EP3DL36RQ	2,077.	25.	50.

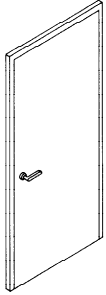

42" ADA Door panel	LH laminate door	42"	81"	EP3DL42LQ	2,433.	25.	50.
	RH laminate door	42"	81"	EP3DL42RQ	2,433.	25.	50.

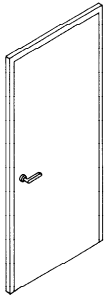

Order Code

Example: **EP3DL42LQ, 117, 117, 117**

EP3DL	Steel door panel
42	Width
LQ	Left handed
117	Soft Grey front/back finish
117	Soft Grey edgeband
117	Soft Grey trim

Specification Information

Specify one surface and/or trim color, as appropriate.

The direction the door pivots away from you determines the "hand."

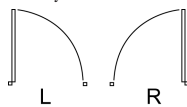

Post and post connectors must be ordered separately.

The door frame requires perpendicular support on the hinged side when the door is in an open position.

Application Notes

Two doors may not be placed back to back while sharing a single post connection. Doors in this application will not be properly supported and therefore no shroud exists to cover a back-to-back base opening.

All 42" and 48" wide doors provide a minimum opening clearance of 32" and are compliant with the Americans with Disabilities Act. The 36" door opening is less than 32" and is not ADA compliant.

All doors come with locking lever handset. Handset is ADA compliant.

An adaptor cup is included to connect the door to adjoining panels. Door shrouds give a finished look to door frames.

Equity Generation 3

Door Panels and shrouds

description	type	w	h	pattern no.	list	add for P2	add for P3
48" ADA Door panel	LH laminate door	48"	81"	EP3DL48LQ	\$3,331.	\$25.	\$50.
	RH laminate door	48"	81"	EP3DL48RQ	3,331.	25.	50.

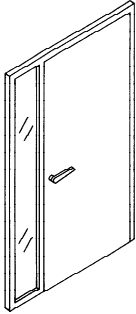

Door shrouds	LH corner door shroud			EP3SDOLQ	13.		
	LH straight door shroud			EP3SDSLQ	13.		
	RH corner door shroud			EP3SDORQ	13.		
	RH straight door shroud			EP3SDSRQ	13.		

Order Code

Example: **EP3DL42LQ, 117, 117, 117**

EP3DL	Steel door panel
42	Width
LQ	Left handed
117	Soft Grey front/back finish
117	Soft Grey edgeband
117	Soft Grey trim

Specification Information

Specify one surface and/or trim color, as appropriate.

The direction the door pivots away from you determines the "hand."

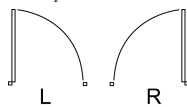

Post and post connectors must be ordered separately.

The door frame requires perpendicular support on the hinged side when the door is in an open position.

Application Notes

Two doors may not be placed back to back while sharing a single post connection. Doors in this application will not be properly supported and therefore no shroud exists to cover a back-to-back base opening.

All 42" and 48" wide doors provide a minimum opening clearance of 32" and are compliant with the Americans with Disabilities Act. The 36" door opening is less than 32" and is not ADA compliant.

All doors come with locking lever handset. Handset is ADA compliant.

An adaptor cup is included to connect the door to adjoining panels. Door shrouds give a finished look to door frames.

Equity service wall accessories

panel starter and end starter

Standard Specials Systems

description	nominal height	pattern no.	list
Equity panel starter	80	AA1EPS80Q	\$409.



Equity end starter	28	AX1E28Q	292.
	80	AX1E80Q	409.



Order Code	Specification Information	Application Notes
Example: AA1EPS80 Q, 613	<p><i>Specify legacy paint finish for Equity end and panel starters, trim kits and crown end cap:</i></p> <p><i>Note:</i> For more specific application information, please refer to pages 48-49 of the 1999 Equity Planning Guide. Additional finishes are available for crown end caps.</p> <p>*For pricing and discounting refer to the Currents price list.</p> <p>Leadtimes will be consistent with Currents published lead-times.</p>	<p>Equity panel starters attach perpendicular panels to Currents wall structural base covers. Equity panel starter includes clamp bracket and adapter. Both end and panel starters include top clip for added stiffness. No connector post is required for either starter.</p> <p>Equity end starter supports perpendicular panel run on the centerline of the end of the wall. Perpendicular panels should be at the same height or higher than the service wall.</p> <p>The Equity end trim kit encloses and flushes out the end of the Currents service wall with attached, end started Equity panels.</p>
AA1 Accessory		
EPS Equity panel starter		
80 Height		
Q Equity standard special		
613 Silver trim		
		<p>Specify trim kit suffix "T" for panels on both sides, "L" or "R" for attached panels only on left or right side of end of the Currents wall (as seen from outside of "T" end). Also specify crown end cap for all end conditions.</p> <p>Gap fillers fill the gap when attaching a lower height Equity panel at the end of a 64"H Currents service wall.</p>

Equity EW1 Worksurfaces

Rectangular

Standard Specials Systems

description	w	d	pattern no.	2mm edge	woodgrain edge	metal edge
15" Deep Rectangular	66"	15"	EW16615Q	\$417.	\$459.	\$500.
18" Deep Rectangular	24"	18"	EW12418Q	217.	239.	260.
grommet	24"	18"	EW12418GQ	237.	261.	284.
36" Deep Rectangular	42"	36"	EW14236Q	655.	721.	786.
grommet	42"	36"	EW14236GQ	675.	743.	810.

Equity System

Order Code

Example:	EW17220G, 117, 117
EW1	Equity top only
72	Width in inches
20	Depth in inches
G	w/grommet
117	Soft Grey lamination
117	Soft Grey edge

Specification Information

Specify surface and edge color.

Note:
If an edge grommet is not desired remove the "G" and deduct \$20. Worksurface cable baskets may be ordered separately from the standard Equity price list.

Extended worksurfaces not available with support hardware included.

Application Notes

Pattern numbers listed above are for worksurface only. See page 0 for Worksurface Loading and Support Application Information.

For cantilevered worksurfaces, please add a "C" to the end of the pattern number and add \$50 to the list price. Worksurfaces up to 48 inches wide will include one left hand and one right hand cantilever. Worksurfaces greater than 48 inches wide will include two left hand cantilevers and one right hand cantilever. The additional left hand cantilever is required for additional center support on tops spanning a distance greater than 48 inches.

A center support must be used with a 54" wide or larger worksurface.

Note:
Extended one end add "E" and \$20. Extended both ends add "EE" and \$40. ("EE" not available on 120".)

Extended tops are not available with support hardware included.

Equity EW1 Worksurfaces

Blended corner

Standard Specials Systems

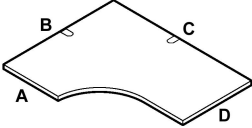
description	A	B	C	D	pattern no.	2mm edge	woodgrain edge	metal edge
	24"	36"	72"	30"	EW1BS3672D () GQ	\$851.	\$936.	\$1,021.
	24"	36"	78"	24"	EW1BS3678S () GQ	874.	961.	1,049.
	24"	42"	72"	24"	EW1BS4272S () GQ	917.	1,009.	1,100.
	24"	60"	60"	24"	EW1BS6060S () GQ	959.	1,055.	1,151.
	24"	72"	36"	30"	EW1BS7236D () GQ	851.	936.	1,021.
	24"	72"	42"	24"	EW1BS7242S () GQ	917.	1,009.	1,100.
	24"	78"	36"	24"	EW1BS7836S () GQ	874.	961.	1,049.
	30"	36"	72"	24"	EW1BD3672S () GQ	851.	936.	1,021.
	30"	48"	60"	30"	EW1BD4860D () GQ	884.	972.	1,061.
	30"	48"	72"	30"	EW1BD4872D () GQ	964.	1,060.	1,157.
	30"	60"	36"	24"	EW1BD6036S () GQ	802.	882.	962.
	30"	60"	48"	30"	EW1BD6048D () GQ	884.	972.	1,061.

Order Code

Example: **EW1BS3672SLG, 117, 117, 117**

EW1B	Blended worksurface
S	24" left depth
36	48 left width
72	72" right width
S	24" right width
L	Left side post covered
G	Grommet
117	Soft Grey laminate
117	Soft Grey edge
117	Soft Grey trim

Specification Information

Specify laminate, vinyl trim, and grommet colors when applicable.

All support bracketry must be ordered separately.

Note:
If and edge grommet is not desired remove the "G" and deduct \$20.

Application Notes

Blended worksurfaces are designed to take the place of two adjacent worksurfaces by blending them into one top. The front of the worksurface is curved to provide a smooth transition to the next attached worksurface.

Blended worksurfaces are handed and may or may not cover a post on either or both sides. Hand is determined from the seated position. Option suffixes for Blended corners are as follows:
X=No posts covered
L=Left side post covered
R=Right side post covered
B=Both sides posts covered

Blended peninsulas are handed and always cover one post. Hand is determined from seated position. Rounded end is 30" deep.



Depth options are as follows:
S=24" deep
D=30" deep

Center support must be used for all surfaces which exceed 48" in length.

Equity EW1 Worksurfaces

Counter caps, corner

Standard Specials Systems

description	A	B	C	pattern no.	PVC edge	woodgrain PVC edge	metal edge
Counter cap,corner 	42"	15"	15"	EW1CC4215Q	\$758.	\$834.	\$910.
Counter cap,corner grommet	48"	24"	30"	EW1CC482430GQ	1,010.	1,111.	1,212.
	48"	30"	24"	EW1CC483024GQ	1,010.	1,111.	1,212.
	48"	30"	30"	EW1CC483030GQ	1,010.	1,111.	1,212.
Counter cap,corner Extended one end 	42"	42"	15"	EW1CC4215EQ	781.	859.	937.
Counter cap,corner Extended both ends 	42"	42"	15"	EW1CC4215EEQ	805.	886.	966.

Equity System

Order Code	Specification Information	Application Notes
Example: EW1CC3015, 117, 117, 117	Specify surface, trim and cantilever trim color.	Counter caps are designed for mounting on top of panels.
EW1 Worksurface	EW1 counter caps work with all existing counter caps and are for use with Generation 1 or Generation 2 panels. Plastic cantilevers are supplied.	Corner counter caps-(E) extended one end, mount on top of 24", 30" or 36" panels at 90° to each other. They are non-handed and screw holes for the mounting brackets must be field-drilled.
CC Curved corner		
30 Width	EW2 counter caps are for use with Generation 3 panels only.	Steel mounting brackets are supplied.
15 Depth		
117 Soft Grey laminate		A counter cap extension (E) covers one post.
117 Soft Grey edge		A counter cap extension (EE) covers 2 posts.
117 Soft Grey cantilever trim		<i>Wood Grain and Metal edge bands:</i> When specifying a top with a wood grain edge band add \$25 to the standard list price. When specifying a top with a metal edge band add \$50 to the standard list price.

Equity EW1 Worksurfaces

P+9 tops

Standard Specials Systems

description	width	depth	pattern no.	PVC edge	woodgrain PVC edge	metal edge
P + 9 Top	60"	30"	EW1(9/P)6030Q	\$709.	\$780.	\$851.
	96"	36"	EW1(9/P)9636Q	1,213.	1,334.	1,456.

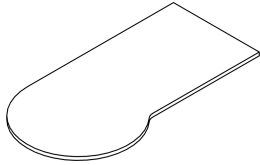

"9" top shown

Order Code	Specification Information	Application Notes
Example: EW1P7230C, 117, 117, 117	Specify surface and trim color. Specify hardware color for bases and stretcher rails.	Designed for use as primary worksurfaces and for conferencing in small groups.
EW1 Gen 1 worksurface		
P P top		
72 Width		
30 Depth		
C Supports included		
117 Soft Grey laminate		
117 Soft Grey edge		
117 Soft Grey trim		
	<p><i>Note:</i> "P" and "D" worksurfaces cannot be panel wrapped.</p> <p>Column bases and stretcher rails must be ordered separately.</p>	<p>To specify an EW1 "D", "P" or "9" top with support hardware (fixed-height column and stretcher rail) included add a "C" to the end of the pattern number and add \$200 to the list price.</p> <p>84" wide "D", "P" and "9" worksurfaces include a "V" support bar mounted on the underside for additional stability.</p>

Equity EW3 Worksurfaces

Blended and Curved corner tops

Standard Specials Systems

description	A	B	C	D	pattern no.	list
Blended corner	24"	36"	78"	24"	EW3BS3678S () GQ	\$1,120.
	24"	78"	36"	24"	EW3BS7836S () GQ	1,120.

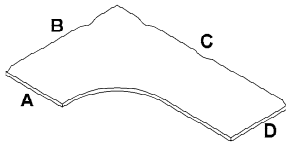

Note: EW3 Worksurfaces not available with Woodgrain or Metal edge.

Curved corner	48"	30"	24"		EW3CC483024GQ	1,290.
---------------	-----	-----	-----	--	----------------------	--------

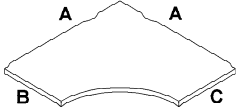

Note: EW3 Worksurfaces not available with Woodgrain or Metal edge.

Equity System

Order Code

Example: **EW3BS3672SLG, 117, 117**

EW3B	Blended worksurface
S	24" left depth
36	48" left width
72	72" right width
S	24" right depth
L	Left side post covered
G	Grommet
117	Soft Grey laminate
117	Soft Grey edge

Specification Information

Specify laminate, vinyl trim, and grommet colors when applicable.

All support bracketry must be ordered separately.

Note:
If an edge grommet is not desired, remove the "G" and deduct \$20.

Application Notes

Blended worksurfaces are designed to take the place of two adjacent worksurfaces by blending them into one top. The front of the worksurface is curved to provide a smooth transition to the next attached worksurface.

Blended worksurfaces are handed and may or may not cover a post on either or both sides. Hand is determined from the seated position. Option suffixes for Blended corners are as follows:
X=No posts covered
L=Left side post covered
R=Right side post covered
B=Both sides posts covered

Blended peninsulas are handed and always cover one post. Hand is determined from seated position. Rounded end is 30" deep.

Blended peninsulas do not come with grommets. Due to this, the worksurface meeting the "c" side will have a one-half grommet where the return meets the peninsula.

Depth options are as follows:
S=24" deep
D=30" deep

Center support must be used for all surfaces which exceed 48" in length.

Equity EW3 Worksurfaces

D,P+9 tops

Standard Specials Systems

description	w	d	pattern no.	list
P + 9 Top	66"	30"	EW3(9/P)6630Q	\$909.

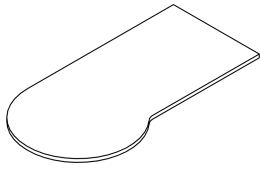

Note: EW3 Worksurfaces not available with Woodgrain or Metal edge.

"D" Top	72"	30"	EW3D7230Q	800.
---------	-----	-----	------------------	------

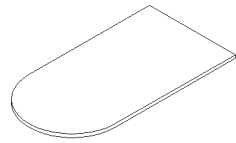

Note: EW3 Worksurfaces not available with Woodgrain or Metal edge.

Order Code	Specification Information	Application Notes
Example: EW1P7230C, 117, 117, 117	Specify surface and trim color. Specify hardware color for bases and stretcher rails.	Designed for use as primary worksurfaces and for conferencing in small groups.
EW1	Gen 1 worksurface	
P	P top	
72	Width	
30	Depth	
C	Supports included	
117	Soft Grey laminate	
117	Soft Grey edge	
117	Soft Grey trim	
	<i>Note:</i> "P" and "D" worksurfaces cannot be panel wrapped.	To specify an EW1 "D", "P" or "9" top with support hardware (fixed-height column and stretcher rail) included add a "C" to the end of the pattern number and add \$200 to the list price.
	Column bases and stretcher rails must be ordered separately.	84" wide "D", "P" and "9" worksurfaces include a "V" support bar mounted on the underside for additional stability.

description	w	d	pattern no.	PVC edge	woodgrain PVC edge	metal edge
Calibre file top 18"d	66"	18"	CE6618Q	\$345.	\$380.	\$414.
	78"	18"	CE7818Q	385.	424.	462.
	96"	18"	CE9618Q	497.	547.	596.
	114"	18"	CE11418Q	562.	618.	674.



Note: File tops are designed for use with Calibre Lateral Files with Calibre Fronts. For Morriuson Fronts and Series 2 Fronts contact CPD.

Calibre file top 36"d	48"	36"	CE4836Q	413.	454.	496.
	54"	36"	CE5436Q	474.	521.	569.
	66"	36"	CE6636Q	684.	752.	821.
	78"	36"	CE7836Q	595.	655.	714.
	96"	36"	CE9636Q	726.	799.	871.
	102"	36"	CE10236Q	770.	847.	924.
	114"	36"	CE11436Q	905.	996.	1,086.
	120"	36"	CE12036Q	972.	1,069.	1,166.

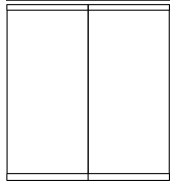

Note: File tops are designed for use with Calibre Lateral Files with Calibre Fronts. For Morriuson Fronts and Series 2 Fronts contact CPD.

Order Code

30X18 Equity/Dividends Style File Tops (Calibre Files)

Example: **CE3018**

CE	Equity/Dividend Edge
30	30" Wide
18	18" Deep

Specification Information

CE prefixed lateral file tops are designed to be attached to standard 18" deep (nominal) Calibre lateral files and cabinets. Please note that Calibre bookcases are 15" deep nominal and will not accept a Calibre lateral file laminate tops.

Calibre desking surfaces are not designed to serve as lateral file worksurface tops.

Applicaton Notes

Designed for use with standard 18" deep nominal Calibre lateral files and cabinets only.

Actual dimensions are listed in inches

Equity Task Light Daisy Chain

description	type	w	d	h	pattern no.	Standard	Advanced
Task Light, starter 9 ft. cord, fused male plug 1 ft. cord, female plug	Use with 24" and wider overhead	19"	4"	1 1/2"	EL4T5E19()DCS()Q	\$360.	n/a
	Use with 30" and wider overhead	25"	4"	1 1/2"	EL4T5E25()DCS()Q	367.	570.
	Use with 42" and wider overhead	37"	4"	1 1/2"	EL4T5E37()DCS()Q	373.	589.
	Use with 60" and wider overhead	49"	4"	1 1/2"	EL4T5E49()DCS()Q	387.	613.

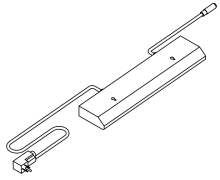

left hand shown

Task Light, adder 2 ft. cord, male plug 1 ft. cord, female plug	Use with 24" and wider overhead	19"	4"	1 1/2"	EL4T5E19()DCA()Q	392.	n/a
	Use with 30" and wider overhead	25"	4"	1 1/2"	EL4T5E25()DCA()Q	399.	600.
	Use with 42" and wider overhead	37"	4"	1 1/2"	EL4T5E37()DCA()Q	405.	623.
	Use with 60" and wider overhead	49"	4"	1 1/2"	EL4T5E49()DCA()Q	419.	640.

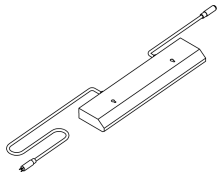

left hand shown

Task Light, ender 2 ft. cord, male plug	Use with 24" and wider overhead	19"	4"	1 1/2"	EL4T5E19()DCE()Q	279.	n/a
	Use with 30" and wider overhead	25"	4"	1 1/2"	EL4T5E25()DCE()Q	286.	487.
	Use with 42" and wider overhead	37"	4"	1 1/2"	EL4T5E37()DCE()Q	292.	510.
	Use with 60" and wider overhead	49"	4"	1 1/2"	EL4T5E49()DCE()Q	306.	527.

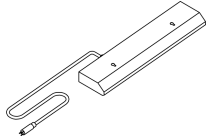

left hand shown

Order Code	Specification Information	Application Notes
Example: EL4T5E19SDCSLQ	<i>Specify:</i>	Task lights mount into the recess in the underside of overhead cabinets and shelves at least 5" wider than task light width.
EL4 Equity Task Light	Width - Task Lights mount in cabinets and shelves at least 5" wider than light width.	For extra deep (EDP) shelves, order the EDP light bracket for proper installation.
T5 T5 lamp	1. Type:	Task lights include T5 cool white (4100K) fluorescent lamp, electronic ballast, prismatic lens, rocker switch, one cord exit management clip and mounting hardware.
E Electronic ballast	(S) Standard	Task lights are TCLP compliant and meet requirements of California Title 24.
19 Width	(A) Advanced	
S Standard	2. Handedness	Advanced task lights are fitted with ballast and lamp compliant with LEED requirements.
DC Daisy chain	L= Left handed (male plug on user's left side)	
S Starter	R=Right handed (male plug on user's right side)	
L Left handed	All housings are black.	
Q Special		

KNOLLTEXTILES

Approved for vertical panels and privacy screens.

Fabric Group 10

Bailey II (W359)
Broadcloth (W288)
Element (W1077)
Foundation (W351)
Growth Spurt (W692)
Newbury (W812)
Solid Crepe (W257)
Symbolic Details (W693)
Tailor Made (W133)
Versatility (W432)

Fabric Group 15

Regency/Fairfield (W210/B)

Fabric Group 20

Archaea (W1254)
Banyan (W443)
Bauhaus Block (W296)
Circle Line (W1146)
Clarity (W281)
Criss Cross (W305)
Devon (W809)
Melbourne (W228)
Nematic (W1292)
panel and trim only
Outback (W229)
Photon (W1293)
Reflect (W884)
Resolution (W280)
Walkabout (W230)
Weave Three (W298)

Fabric Group 30

Basket Draft (W249)
Flow (W565)
Harmony (W232)
Interknit (W1090)
Match Point (W1145)
Micro (W465)
Progression (W403)
Progression Striae (W463)
Raku Cloth (W566)
Relay (W1020)

Fabric Group 40

Amplify (W1215)
Analogy (K614)
Bandwidth (W1219)
Clarkson (W1218)
panel and trim only
Foil Rap (W535)
Hard Rock (W1007)
Metaphor (K612)
Ornament (W1078)
Palladium (W1030)

Fabric Group 45

Backdrop (W302) *
Dristi (K872) with backing only
Fast Forward (W301)*

***Not available for upholstered connector trim covers**

Fabric Group 50

Knoll Hopsack (K1206)
panel and trim only
Presto (K1000)
Ricochet (K498)

Fabric Group 55

Transition (W816)

Ported panels can only be upholstered with textiles approved for application on Reff panels.

Customer's Own Material is subject to an application testing fee of per fabric and a fee for UL testing. Fabric requirements - application test, 10 yards; UL test, 15 yards. COM is also subject to extended leadtimes. COM panels are priced at Group 10 plus cost of fabric.

Knoll Color Program

Morrison System Finishes

Core paint and laminate finishes

Specify Core finishes for all new customers

Core	Legacy	Top caps and trim, Panels (veneer only)	Glazed panel, window, door frames (textured)	Desk panels, storage fronts Hinged doors	Desk supports, stanchion, storage, brackets, raceway covers	Work-surfaces and shelves (all)	Work-surfaces and shelves (post-formed)	Cascade Edge work-surfaces	Pedestals	Reuter Over-head
611	Beige Mist Metallic	•	•	•	•				P2	P2
118	Bright White	•	•	•	•	•	•	•	P3	P3
112	Brown	•	•	•	•				P1	P1
113	Dark Grey	Y3	•	•	•				P1	P1
114	Folkstone Grey	LA	•	•	•	•	•	•	P1	P1
111	Jet Black		•	•	•	•	•		P1	P1
115	Medium Grey	Y2	•	•	•				P1	P1
612	Medium Metallic Grey	J	•	•	•				P2	P2
119	Pumice	F				•	•	•		
116	Sandstone		•	•	•				P1	P1
613	Silver	3	•	•	•				P3	P3
117	Soft Grey	E/M42	•	•	•	•	•	•	P1	P1
128	Fog	G				•	•			
129	Micro Sand						•			
121	Micro Grey						•			
122	Brushed Sand						•			
123	Brushed Grey						•			
124	Medium Cherry						•	•		
125	Natural Maple						•	•		
126	Natural Cherry						•	•		
127	Walnut						•	•		

This price list contains pricing for Core finishes. For detailed pricing of Legacy finishes, please refer to the latest release of CAP worksheet or contact your customer service representative.

The new, Core P1 finishes in Morrison have the same list prices as P2. Additionally, Pedestals and Reuter overhead storage have a separate P3 price point for Silver and Bright White.

The new Core finish 113 Dark Grey is not a match to the Morrison Legacy finish NV. It is a match to the Dividends Legacy finish Y3.

The new Core finish 115 Medium Grey is not a match to the Morrison Legacy finish NJ. It is a match to the Dividends Legacy finish Y2.

Patterned laminates (Micro, Brushed and Wood grain laminates) are available on Morrison postformed worksurfaces and shelves (straight, trapezoidal, VDT).

Wood grain laminates are also available on Cascade Edge worksurfaces.

		Work-surfaces	Panels	Desk Panels	Shelves	Top caps/ Trim covers	Glazed Panel/ Window/ Door Frames*	Storage fronts	Storage Cases	Desk Supports, Stanchions, Steel shelves, brackets, raceway covers
Plastic Laminates	Light Grey	L			L					
	Medium Grey	G			G					
	Sand	D			D					
	Pumice	F			F					
	Snow	B			B					
Wood Grain Laminates	Clear Maple (Currents for Morrison worksurfaces only)	CM								
Veneer Group 1	Maple Techgrain®	4/Y821	4/Y821	M/C6J2	4/Y821	4/Y821		M/C6J2		
	Cherry Techgrain®	6/Y831	6/Y831	R/C6J3	6/Y831	6/Y831		R/C6J3		
	Medium brown mahogany Techgrain®	7/C6F3	7/C6F3	I/C6J4	7/C6F3	7/C6F3		I/C6J4		
	Medium red mahogany Techgrain®	8/C6F4	8/C6F4	C/C6J5	8/C6F4	8/C6F4		C/C6J5		
	American cherry Techgrain®	9/C6F5	9/C6F5	P/C6J6	9/C6F5	9/C6F5		P/C6J6		
Veneer Group 2	American cherry	X/C6F6	X/C6F6	X/C6F6	X/C6F6	X/C6F6		X/C6F6		
	Medium red mahogany	Z/C6F7	Z/C6F7	Z/C6F7	Z/C6F7	Z/C6F7		Z/C6F7		
Paint Group 2	Metallic Flint			2		2	2	2	2	2
	Light metallic grey			U		U	U	U	U	U
	Medium metallic grey			J		J	J	J	J	J
	Dark metallic grey			V		V	V	V	V	V
	Light metallic tan			W		W	W	W	W	W
	Metallic beige			H		H	H	H	H	H
Paint Group 3	Silver			3		3	3	3	3	3
	White			B		B	B	B	B	B

* Paint finishes for glazed panels, window and door frames are textured only.



Specify legacy finishes to match existing product only. Legacy finishes are not available for new customers.

This price list contains pricing for Core finishes. For detailed pricing of Legacy finishes, please refer to the latest release of CAP worksheet or contact your customer service representative.

In September 2008 all existing Morrison veneer finishes were transferred to our Toronto plant. All existing finishes were changed to closed pore finishing and assigned new finish codes. The older, semi-open pore finishes are no longer available and legacy finishes must be ordered with the newer finish codes beginning with "C".

As of February 2009 Legacy laminates will be priced 10% higher than Core laminates.

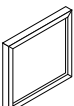

description	w	d	h	pattern no.	C/S	T
Windows, 8"H 	18"	2 1/4"	8"	MP3-W0818-C/S/T-Q-()	\$469.	\$525.
	24"	2 1/4"	8"	MP3-W0824-C/S/T-Q-()	525.	593.
	30"	2 1/4"	8"	MP3-W0830-C/S/T-Q-()	593.	663.
	36"	2 1/4"	8"	MP3-W0836-C/S/T-Q-()	649.	733.
	42"	2 1/4"	8"	MP3-W0842-C/S/T-Q-()	705.	788.
	48"	2 1/4"	8"	MP3-W0848-C/S/T-Q-()	772.	870.
	60"	2 1/4"	8"	MP3-W0860-C/S/T-Q-()	994.	1,119.
Windows, 14"H 	18"	2 1/4"	14"	MP3-W1418-C/S/T-Q-()	469.	525.
	24"	2 1/4"	14"	MP3-W1424-C/S/T-Q-()	525.	593.
	30"	2 1/4"	14"	MP3-W1430-C/S/T-Q-()	593.	663.
	36"	2 1/4"	14"	MP3-W1436-C/S/T-Q-()	649.	733.
	42"	2 1/4"	14"	MP3-W1442-C/S/T-Q-()	705.	788.
	48"	2 1/4"	14"	MP3-W1448-C/S/T-Q-()	772.	870.
	60"	2 1/4"	14"	MP3-W1460-C/S/T-Q-()	994.	1,119.
Windows, 26"H 	18"	2 1/4"	26"	MP3-W2618-C/S/T-Q-()	469.	525.
	24"	2 1/4"	26"	MP3-W2624-C/S/T-Q-()	525.	593.
	30"	2 1/4"	26"	MP3-W2630-C/S/T-Q-()	593.	663.
	36"	2 1/4"	26"	MP3-W2636-C/S/T-Q-()	649.	733.
	42"	2 1/4"	26"	MP3-W2642-C/S/T-Q-()	705.	788.
	48"	2 1/4"	26"	MP3-W2648-C/S/T-Q-()	772.	870.
	60"	2 1/4"	26"	MP3-W2660-C/S/T-Q-()	994.	1,119.

Order Code

Example:	MP3-W2230-C-Q-613
MP3	Panel
W	Window
22	Height
30	Width
C	Window finish
Q	Standard Special
613	Frame finish

Specification Information

Specify glazing for windows:
 C- Clear tempered glass
 S- Smoked acrylic
 T- Translucent acrylic

Frame finish

Application Notes

Windows mount on any height Morrison vertical panel of the same width with add-on connectors or full height connectors.

All windows are 1/4" less than nominal height to allow for a 1/4" horizontal reveal with light seal.

9"H windows may be mounted on 30"H and 39"H vertical panels and connected, respectively, with standard 39"H and 48"H connector tracks and post assemblies.

16"H windows may be mounted on 48"H and 64"H vertical panels and connected, respectively, with standard 64"H and 80"H connector tracks and post assemblies.

18"H windows may be mounted on 30"H and 56"H vertical panels and connected, respectively, with standard 48"H and 74"H standard connector tracks and post assemblies.

22"H windows may be mounted on 42"H vertical panels and connected with standard 64"H connector tracks and post assemblies.

32"H windows may be mounted on 48"H vertical panels and connected with standard 80"H connector tracks and post assemblies.

Full height 48" and 64" connectors permit cantilevered shelves and overhead cabinets.

Two 16"H windows may be mounted on a 48"H upholstered panel only when using 80"H full height connector tracks and post assemblies.

Morrison Connectors, post assemblies *straight upholstered*

Standard Specials Systems

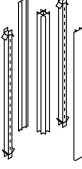
description	w	d	h	pattern no.	10	15	20	30	35	40	45
 Connector track upholstered	2 1/4"	2 1/4"	30"	MC1-30S2-()-Q	\$178.	\$178.	\$178.	\$178.	\$192.	\$192.	\$207.
	2 1/4"	2 1/4"	39"	MC1-39S2-()-Q	183.	183.	183.	183.	196.	196.	211.
	2 1/4"	2 1/4"	42"	MC1-42S2-()-Q	185.	185.	185.	185.	199.	199.	213.
	2 1/4"	2 1/4"	48"	MC1-48S2-()-Q	192.	192.	192.	192.	205.	205.	221.
	2 1/4"	2 1/4"	56"	MC1-56S2-()-Q	199.	199.	199.	199.	213.	213.	228.
	2 1/4"	2 1/4"	64"	MC1-64S2-()-Q	213.	213.	213.	213.	228.	228.	242.
	2 1/4"	2 1/4"	74"	MC1-74S2-()-Q	228.	228.	228.	228.	242.	242.	256.
	2 1/4"	2 1/4"	80"	MC1-80S2-()-Q	242.	242.	242.	242.	256.	256.	270.

Morrison System

Order Code	Specification Information	Application Notes
Example: MC1-42S2-15-W210/20-Q	Surface type:	Post assembly pricing includes connector tracks, posts and trim covers when required. Top caps and raceway covers are specified as separate kits and bulk shipped to facilitate installation
MC1 Connector	10- Fabric group 10	
42 Height	15- Fabric group 15	
S2 2 way "L"	20- Fabric group 20	
15 Surface type and group no.	25- Fabric group 25	
W210/20 Upholstery	30- Fabric group 30	
Q Standard Special	35- Fabric group 35	
	40- Fabric group 40	
	45- Fabric group 45	

Morrison Connectors, post assemblies
straight non-upholstered

Standard Specials Systems

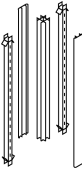
description	type	w	d	h	pattern no	Paint	V1
	painted	2 1/4"	2 1/4"	30"	MC1-30S2-()-Q	\$135.	
		2 1/4"	2 1/4"	39"	MC1-39S2-()-Q	139.	
		2 1/4"	2 1/4"	42"	MC1-42S2-()-Q	142.	
		2 1/4"	2 1/4"	48"	MC1-48S2-()-Q	156.	
		2 1/4"	2 1/4"	56"	MC1-56S2-()-Q	171.	
		2 1/4"	2 1/4"	64"	MC1-64S2-()-Q	185.	
		2 1/4"	2 1/4"	74"	MC1-74S2-()-Q	199.	
		2 1/4"	2 1/4"	80"	MC1-80S2-()-Q	212.	
	veneer	2 1/4"	2 1/4"	30"	MC1-30S2V-()-Q		207.
		2 1/4"	2 1/4"	39"	MC1-39S2V-()-Q		211.
		2 1/4"	2 1/4"	42"	MC1-42S2V-()-Q		213.
		2 1/4"	2 1/4"	48"	MC1-48S2V-()-Q		228.
		2 1/4"	2 1/4"	56"	MC1-56S2V-()-Q		242.
		2 1/4"	2 1/4"	64"	MC1-64S2V-()-Q		256.
		2 1/4"	2 1/4"	74"	MC1-74S2V-()-Q		284.
2 1/4"	2 1/4"	80"	MC1-80S2V-()-Q		298.		

Order Code

Example:	MC1-42S2-V-4-Q
MC1	Connector
42	Height
S2	2 way "L"
V	Surface type
4	Veneer
Q	Standard Special

Specification Information

Application Notes

Post assembly pricing includes connector tracks, posts and trim covers when required. Top caps and raceway covers are specified as separate kits and bulk shipped to facilitate installation.

Veneer Group 1 trim covers are quartered Techgrain®.

Veneer Group 2 trim covers are rift cut Techgrain®.

Morrison Connectors, post assemblies *variable angle upholstered*

Standard Specials Systems

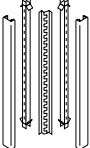
description	w	d	h	pattern no.	10	15	20	30	35	40	45
 Connector track upholstered	2 1/4"	2 1/4"	30"	MC1-30H1(-)-Q	\$623.	\$632.	\$632.	\$632.	\$678.	\$678.	\$684.
	2 1/4"	2 1/4"	39"	MC1-39H1(-)-Q	634.	644.	644.	644.	678.	678.	694.
	2 1/4"	2 1/4"	42"	MC1-42H1(-)-Q	642.	654.	654.	654.	678.	678.	705.
	2 1/4"	2 1/4"	48"	MC1-48H1(-)-Q	659.	669.	669.	669.	692.	692.	721.
	2 1/4"	2 1/4"	56"	MC1-56H1(-)-Q	669.	681.	681.	681.	705.	705.	734.
	2 1/4"	2 1/4"	74"	MC1-74H1(-)-Q	694.	707.	707.	707.	733.	733.	763.
	2 1/4"	2 1/4"	80"	MC1-80H1(-)-Q	712.	721.	721.	721.	746.	746.	780.

Morrison System

Order Code

Example:	MC1-64H1-15-W210/20-Q
MC1	Morrison accessory
64	Height
H1	Variable angle
15	Surface type and group no.
W210/20	Upholstery
Q	Standard Special

Specification Information

Finishes for variable angle:

Upholstered:

10-	Fabric group 10
15-	Fabric group 15
20-	Fabric group 20
30-	Fabric group 30
35-	Fabric group 35
40-	Fabric group 40
45-	Fabric group 45

Application Notes

Variable angle connector includes connector tracks, continuous hinge, and trim covers. Specify top cap and raceway cover kit separately.

Morrison Connectors, post assemblies
variable angle non-upholstered

Standard Specials Systems

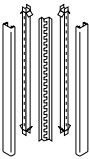
description	type	w	d	h	pattern no.	P	V1
Variable angle 	painted	2 1/4"	2 1/4"	30"	MC1-30H1-()-Q	\$593.	
		2 1/4"	2 1/4"	39"	MC1-39H1-()-Q	606.	
		2 1/4"	2 1/4"	42"	MC1-42H1-()-Q	613.	
		2 1/4"	2 1/4"	48"	MC1-48H1-()-Q	630.	
		2 1/4"	2 1/4"	56"	MC1-56H1-()-Q	639.	
		2 1/4"	2 1/4"	74"	MC1-74H1-()-Q	665.	
		2 1/4"	2 1/4"	80"	MC1-80H1-()-Q	681.	
	veneer	2 1/4"	2 1/4"	30"	MC1-30H1V-()-Q		715.
		2 1/4"	2 1/4"	39"	MC1-39H1V-()-Q		729.
		2 1/4"	2 1/4"	42"	MC1-42H1V-()-Q		736.
		2 1/4"	2 1/4"	48"	MC1-48H1V-()-Q		754.
		2 1/4"	2 1/4"	56"	MC1-56H1V-()-Q		766.
		2 1/4"	2 1/4"	74"	MC174H1V-()-Q		796.
		2 1/4"	2 1/4"	80"	MC1-80H1V-()-Q		812.

Order Code

Specification Information



Application Notes

Example: **MC1-64H1-15-W210/20-Q**

MC1	Morrison accessory
64	Height
H1	Variable angle
15	Surface type and group no.
W210/20	Upholstery
Q	Standard Special

Variable angle connector includes connector tracks, continuous hinge, and trim covers. Specify top cap and raceway cover kit separately.

Morrison miscellaneous
Topcap and Raceway kit
Mid panel connector
Ceiling power components

description	h	pattern no.	list	P	V1/P1	V2/P1
Mid panel connector 	30"	MC1-C30Q	\$305.			
	39"	MC1-C39Q	305.			
	42"	MC1-C42Q	305.			
	48"	MC1-C48Q	318.			
	56"	MC1-C56Q	318.			
	64"	MC1-C64Q	318.			
	74"	MC1-C74Q	332.			
	80"	MC1-C80Q	332.			
Topcap&Raceway kit 		MT5-CS2-()-Q		44.	56.	85.
Ceiling power pole		MP2-CPP-()-Q	606.			
Earthquake tie down bracket for screen panel (pair) black finish only		MPTIEDOWN	80.			

Order Code	Specification Information	Application Notes
Example: MC1-C30-Q		
MC1 Connector		Earthquake tie down brackets can be used on Morrison, Dividends Horizon and Reff screen panel.
C Mid panel		
30 Height		
Q Standard Special		

Trim Cover *upholstered*

description	h	pattern no.	10	15	20	30	35	40	45
 Straight spacer upholstered	30"	MT1-30S2-()-Q	\$107.	\$107.	\$107.	\$107.	\$122.	\$122.	\$122.
	39"	MT1-39S2-()-Q	110.	110.	110.	110.	126.	126.	126.
	42"	MT1-42S2-()-Q	113.	113.	113.	113.	129.	129.	129.
	48"	MT1-48S2-()-Q	122.	122.	122.	122.	135.	135.	135.
	56"	MT1-56S2-()-Q	129.	129.	129.	129.	142.	142.	142.
	64"	MT1-64S2-()-Q	142.	142.	142.	142.	156.	156.	156.
	74"	MT1-74S2-()-Q	156.	156.	156.	156.	171.	171.	171.
	80"	MT1-80S2-()-Q	170.	170.	170.	170.	185.	185.	185.

Example: **MT1-42S2-15-W210/20-Q**

MT1	Connector
42	Height
S2	2 way "L"
15	Surface type and group no.
W210/20	Upholstery
Q	Standard Special

Surface type:

10-	Fabric group 10
15-	Fabric group 15
20-	Fabric group 20
30-	Fabric group 30
35-	Fabric group 35
40-	Fabric group 40
45-	Fabric group 45

Trim Cover

non-upholstered

description	type	h	pattern no.	Paint	VI	
 Straight spacer	painted	30"	MT1-30S2-()-Q	\$100.		
		39"	MT1-39S2-()-Q	104.		
		42"	MT1-42S2-()-Q	107.		
		48"	MT1-48S2-()-Q	113.		
		56"	MT1-56S2-()-Q	122.		
		64"	MT1-64S2-()-Q	129.		
		74"	MT1-74S2-()-Q	135.		
		80"	MT1-80S2-()-Q	149.		
	veneer	30"	MT1-30S2V-()-Q			149.
		39"	MT1-39S2V-()-Q			154.
		42"	MT1-42S2V-()-Q			156.
		48"	MT1-48S2V-()-Q			163.
		56"	MT1-56S2V-()-Q			171.
		64"	MT1-64S2V-()-Q			185.
		74"	MT1-74S2V-()-Q			199.
80"	MT1-80S2V-()-Q			212.		

Order Code

Specification Information

Application Notes

Example: **MT1-42S2-V-4-Q**

MT1	Connector
42	Height
S2	2 way "L"
V	Surface type
4	Veneer
Q	Standard Special

Veneer Group I trim covers are quartered Techgrain®.

Morrison Rolling Doors for Dividends Horizon

Standard Specials Systems

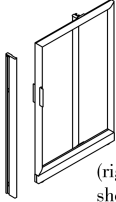
description	type	width	pattern number	RC	RC	C	C	T	T	
				1-19	20+	1-19	20+	1-19	20+	
Rolling door	64"H with lock	36"	QDMRD6436(L/R)()(-L-)	\$3,916.	\$3,404.	\$4,121.	\$3,582.	\$4,198.	\$3,650.	
 (right hand shown)	64"H with lock	42"	QDMRD6442(L/R)()(-L-)	3,916.	3,404.	4,121.	3,582.	4,198.	3,650.	
	64"H with lock	48"	QDMRD6448(L/R)()(-L-)	3,946.	3,431.	4,150.	3,608.	4,229.	3,677.	
	64"H without lock	36"	QDMRD6436(L/R)()(-N-)	3,780.	3,287.	3,905.	3,395.	3,996.	3,474.	
	64"H without lock	42"	QDMRD6442(L/R)()(-N-)	3,780.	3,287.	3,905.	3,395.	3,996.	3,474.	
	64"H without lock	48"	QDMRD6448(L/R)()(-N-)	3,811.	3,313.	3,936.	3,422.	4,026.	3,501.	
	78"H with lock	36"	QDMRD7836(L/R)()(-L-)	4,081.	3,549.	4,285.	3,726.	4,365.	3,794.	
	78"H with lock	42"	QDMRD7842(L/R)()(-L-)	4,081.	3,549.	4,285.	3,726.	4,365.	3,794.	
	78"H with lock	48"	QDMRD7848(L/R)()(-L-)	4,112.	3,575.	4,317.	3,753.	4,395.	3,821.	
	78"H without lock	36"	QDMRD7836(L/R)()(-N-)	3,946.	3,431.	4,071.	3,539.	4,161.	3,618.	
	78"H without lock	42"	QDMRD7842(L/R)()(-N-)	3,946.	3,431.	4,071.	3,539.	4,161.	3,618.	
	78"H without lock	48"	QDMRD7848(L/R)()(-N-)	3,976.	3,457.	4,102.	3,566.	4,193.	3,644.	
	Threshold for Rolling door	36"	QDMRDFT36						467.	
		42"	QDMRDFT42						479.	
		48"	QDMRDFT48						484.	

* Order standard trim components separately to fit your door application. See following Trim page for pattern numbers.

Order Code	Specification Information	Application Notes	Discount Notes
Example: QDMRD-7842-L-RC-117-L	<i>Specify:</i>	64"H rolling door kit includes door panel, post with mounting bracket, and door jamb. See Door Trim page for trim options to be specified separately at time of order entry.	Above products are Morrison product and Morrison discount will be applied.
QDM Morrison for Dividends	<i>Left / Right Hand</i>	78"H rolling door kit includes door panel, post with mounting bracket, door jamb, header and top cap for header. See Door Trim page for trim options to be specified at time of order entry.	
RD Rolling door	<i>Glazing for rolling door:</i>	36" wide doors are not ADA compliant.	
78 Height	C- Clear acrylic		
42 Width	T- Translucent acrylic		
L Left	RC- Ribbed polycarbonate		
RC Door finish	<i>Frame finish</i>		
117 Frame finish	<i>Lock / No Lock</i>		
N No lock	Rolling doors mount to the outside of Dividends workstations. <i>Trim option:</i>		
F Trim option	<i>code upch. Desc.</i>		
	S- n/c Smooth plastic		
	F- \$42 Flat metal		
	R- \$42 Radius metal		

64" High Door without Header

Jamb Side Trim

Top View

Universal Post DP2APO64
 Universal Post DP7 DP7PO64
 Post Top Cap – One Way DP()PT1
 Post Cover – Corner -DP()PC64L



Universal Post -DP2APO64
 Universal Post DP7 -DP7PO64
 Post Top Cap – One Way -DP()PT1
 Post Cover – Straight -DP()PC64S

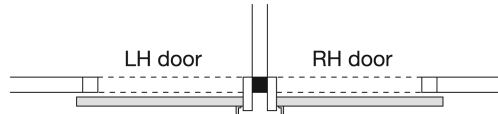

Universal Post -DP2APO64
 Universal Post DP7 -DP7PO64
 Post Top Cap – Two Way -DP()PT2
 Post Cover – Straight -DP()PC64S

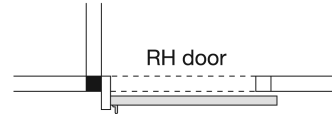

End Top Cap -DP1 -KR7713C40V01
 -DP2A -KRQCPDD2547~
 -DPV1 -NONE
 -DP4 -KRQCPDD2547~
 -DP5 -KRQCPDD2548~
 -KRQCPDD290740
 DP7 Windows
 Top Brkts for Jambs

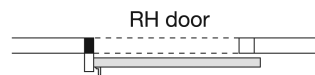

78" High Door w/Header

Jamb Side Trim

Top View

Universal Post -DP2APO78
 Universal Post DP7 -DP7PO78
 Post Top Cap – Two Way -DP()PT2
 Post Cover – Corner -DP()PC78L



Universal Post -DP2APO78
 Universal Post DP7 -DP7PO78
 Post Top Cap – Three Way -DP()PT3
 Post Cover – Straight -DP()PC78S

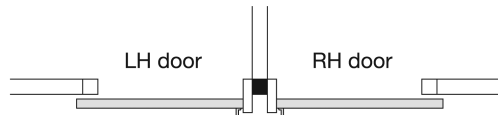

Universal Post -DP2APO78
 Universal Post DP7 -DP7PO78
 Post Top Cap – Three Way -DP()PT3
 Post Cover – Straight -DP()PC78S



End Top Cap -DP()TCT
 DP7 Windows -KRQCPDD290740
 Top Brkts for Jambs

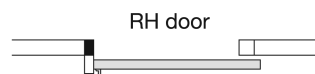

*See Dividends Horizon price list for component pricing.

Morrison Worksurfaces, 1 3/4" 18" D

Standard Specials Systems

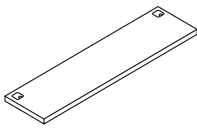
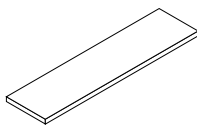
description	type	w	d	h	pattern no.	lam.	V1	V2
Straight, 18"D		18"	17 5/8"	1 3/4"	MW2-S1818-A-Q-()	\$418.	\$609.	\$819.
		24"	17 5/8"	1 3/4"	MW2-S2418-A-Q-()	418.	609.	819.
		30"	17 5/8"	1 3/4"	MW2-S3018-A-Q-()	461.	649.	879.
		36"	17 5/8"	1 3/4"	MW2-S3618-A-Q-()	505.	689.	939.
		42"	17 5/8"	1 3/4"	MW2-S4218-A-Q-()	549.	747.	1,037.
		48"	17 5/8"	1 3/4"	MW2-S4818-A-Q-()	605.	801.	1,116.
		54"	17 5/8"	1 3/4"	MW2-S5418-A-Q-()	642.	864.	1,195.
		60"	17 5/8"	1 3/4"	MW2-S6018-A-Q-()	662.	899.	1,276.
		66"	17 5/8"	1 3/4"	MW2-S6618-A-Q-()	722.	999.	1,412.
		72"	17 5/8"	1 3/4"	MW2-S7218-A-Q-()	780.	1,100.	1,534.
		78"	17 5/8"	1 3/4"	MW2-S7818-A-Q-()	839.	1,200.	1,656.
		84"	17 5/8"	1 3/4"	MW2-S8418-A-Q-()	898.	1,300.	1,777.
		90"	17 5/8"	1 3/4"	MW2-S9018-A-Q-()	957.	1,401.	1,899.
		96"	17 5/8"	1 3/4"	MW2-S9618-A-Q-()	1,016.	1,501.	2,020.
		102"	17 5/8"	1 3/4"	MW2-S10218-A-Q-()	1,075.	1,601.	2,142.
		108"	17 5/8"	1 3/4"	MW2-S10818-A-Q-()	1,134.	1,702.	2,263.
114"	17 5/8"	1 3/4"	MW2-S11418-A-Q-()	1,193.	1,802.	2,385.		
120"	17 5/8"	1 3/4"	MW2-S12018-A-Q-()	1,252.	1,902.	2,506.		
No Grommets		18"	17 5/8"	1 3/4"	MW2-S1818-B-Q-()	349.	526.	736.
		24"	17 5/8"	1 3/4"	MW2-S2418-B-Q-()	349.	526.	736.
		78"	17 5/8"	1 3/4"	MW2-S7818-B-Q-()	815.	1,117.	1,573.
		84"	17 5/8"	1 3/4"	MW2-S8418-B-Q-()	874.	1,218.	1,694.
		90"	17 5/8"	1 3/4"	MW2-S9018-B-Q-()	933.	1,318.	1,816.
		96"	17 5/8"	1 3/4"	MW2-S9618-B-Q-()	992.	1,418.	1,938.
		102"	17 5/8"	1 3/4"	MW2-S10218-B-Q-()	1,051.	1,519.	2,059.
		108"	17 5/8"	1 3/4"	MW2-S10818-B-Q-()	1,110.	1,619.	2,181.
		114"	17 5/8"	1 3/4"	MW2-S11418-B-Q-()	1,169.	1,719.	2,302.
		120"	17 5/8"	1 3/4"	MW2-S12018-B-Q-()	1,228.	1,820.	2,424.

Order Code	Specification Information	Application Notes
Example: MW2-S3618-A-Q-117	<i>Grommets/no grommets:</i>	18"D worksurfaces are used interchangeably in desk and panel system applications as shallow main surfaces, extensions, or credenza tops. They must be supported at each end by a pedestal, end panel, end support cantilever or cantilever bridging bracket with a maximum span of 60" between supports.
MW2 Worksurface 1 3/4" thick	A- Worksurfaces include 3" grommet in each back corner leading into desk support or wire manager.	All worksurfaces have threaded metal inserts at all end panel, desk support and bracket locations and pilot holes at pedestal locations.
S Worksurface type	B- Worksurface does not include grommets.	
36 Width	Specify surface finish	Panel supported worksurfaces over 60" must be mid-span supported by MB2-C18 bracket, specified separately.
18 Depth	All worksurfaces are U.L.-listed.	18"D worksurfaces with desk supports or filler panels do not accept pedestals.
A Grommets		All worksurfaces are 3/8" less than nominal depth for rear wire clearance or privacy screens.
Q Standare Special		
117 Surface finish		

Morrison Worksurfaces, 1 3/4" 24" D

Standard Specials Systems

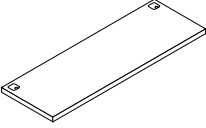
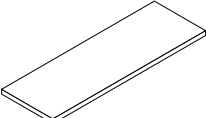
description	type	w	d	h	pattern no.	lam.	V1	V2
Straight, 24"D		18"	23 5/8"	1 3/4"	MW2-S1824-A-Q-()	\$469.	\$706.	\$955.
		102"	23 5/8"	1 3/4"	MW2-S10224-A-Q-()	1,304.	1,835.	2,546.
		108"	23 5/8"	1 3/4"	MW2-S10824-A-Q-()	1,422.	1,989.	2,746.
		114"	23 5/8"	1 3/4"	MW2-S11424-A-Q-()	1,540.	2,144.	2,945.
		120"	23 5/8"	1 3/4"	MW2-S12024-A-Q-()	1,658.	2,299.	3,145.
No Grommets		18"	23 5/8"	1 3/4"	MW2-S1824-B-Q-()	386.	623.	874.
		102"	23 5/8"	1 3/4"	MW2-S10224-B-Q-()	1,221.	1,755.	2,466.
		108"	23 5/8"	1 3/4"	MW2-S10824-B-Q-()	1,339.	1,909.	2,666.
		114"	23 5/8"	1 3/4"	MW2-S11424-B-Q-()	1,457.	2,064.	2,865.
		120"	23 5/8"	1 3/4"	MW2-S12024-B-Q-()	1,575.	2,218.	3,064.

Morrison System

Order Code

Example:	MW2-S1824-A-Q-117
MW2	Worksurface, 1 3/4" thick
S	Straight worksurface
18	Width
24	Depth
A	Grommets
Q	Standard Special
117	Surface finish

Specification Information

Grommets/no grommets:

A- Worksurfaces include 3" grommet in each back corner leading into desk support or wire manager.

B- Worksurface does not include grommets.

Specify surface finish

All worksurfaces are U.L.-listed.

Application Notes

24"D worksurfaces are used interchangeably as shallow main surfaces, extensions or credenza tops. They must be supported at each end by a pedestal, end panel, end support cantilever or cantilever bridging bracket with a maximum span of 60" between supports.

All worksurfaces have threaded metal inserts at all end panel, desk support and bracket locations and pilot holes at pedestal locations.

Use 18"D pedestals with 24"D worksurfaces for full wire management capability in desk or panel applications.

All straight worksurfaces are 3/8" less than nominal depth for rear wire clearance or privacy screens.

Plastic laminate worksurfaces are post-formed top and bottom, front and back.

Worksurfaces with grommets are bored to accept and are shipped with wire manager clips.

Panel supported worksurfaces over 60" must be mid-span supported by MB2-C18 bracket, specified separately.

Morrison Worksurfaces, 1 3/4" 30" D

Standard Specials Systems

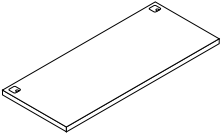
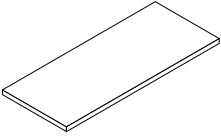
description	type	w	d	h	pattern no.	lam.	V1	V2
Straight, 30"D	Grommets 	18"	29 5/8"	1 3/4"	MW2-S1830-A-Q-()	\$521.	\$726.	\$1,016.
		24"	29 5/8"	1 3/4"	MW2-S2430-A-Q-()	521.	726.	1,016.
		102"	29 5/8"	1 3/4"	MW2-S10230-A-Q-()	1,436.	2,012.	2,879.
		108"	29 5/8"	1 3/4"	MW2-S10830-A-Q-()	1,554.	2,169.	3,115.
		114"	29 5/8"	1 3/4"	MW2-S11430-A-Q-()	1,672.	2,326.	3,351.
		120"	29 5/8"	1 3/4"	MW2-S12030-A-Q-()	1,790.	2,483.	3,587.
No Grommets 	No Grommets	18"	29 5/8"	1 3/4"	MW2-S1830-B-Q-()	441.	647.	939.
		24"	29 5/8"	1 3/4"	MW2-S2430-B-Q-()	441.	647.	939.
		102"	29 5/8"	1 3/4"	MW2-S10230-B-Q-()	1,352.	1,927.	2,801.
		108"	29 5/8"	1 3/4"	MW2-S10830-B-Q-()	1,470.	2,084.	3,037.
		114"	29 5/8"	1 3/4"	MW2-S11430-B-Q-()	1,588.	2,241.	3,273.
		120"	29 5/8"	1 3/4"	MW2-S12030-B-Q-()	1,706.	2,398.	3,509.

Order Code	Specification Information	Application Notes
Example: MW2-S4230A-Q-117	<i>Grommets/no grommets:</i>	30"D worksurfaces are used interchangeably in desk and panel system applications as main surfaces, extensions or credenza tops. They must be supported at each end by a pedestal, end panel, end support cantilever or cantilever bridging bracket with a maximum span of 60" between supports.
MW2 Worksurface, 1 3/4" thick	A- worksurface includes 3" grommet in each back corner leading into desk support or wire manager clips.	All straight worksurfaces are 3/8" less than nominal depth for rear wire clearance or privacy screens. Panel supported worksurfaces over 60" must be mid-span supported by MB2-C18 bracket, specified separately.
S Straight worksurface	B- worksurface does not include grommets	
42 Width	Specify surface finish.	Plastic laminate worksurfaces are post-formed top and bottom, front and back.
30 Depth	All worksurfaces are U.L.-listed.	
A Grommets		
Q Standard Special		
117 Surface finish		

Morrison Worksurfaces, 1 3/4" 36" D

Standard Specials Systems

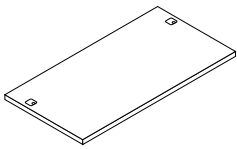
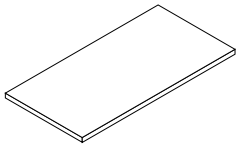
description	type	w	d	h	pattern no.	lam.	V1	V2
Straight, 36"D	Recessed Grommets 	36"	35 3/8"	1 3/4"	MW2-S3636-R-Q-()	\$873.	\$930.	\$1,387.
		42"	35 3/8"	1 3/4"	MW2-S4236-R-Q-()	917.	1,049.	1,522.
		48"	35 3/8"	1 3/4"	MW2-S4836-R-Q-()	961.	1,168.	1,658.
		54"	35 3/8"	1 3/4"	MW2-S5436-R-Q-()	1,004.	1,287.	1,794.
		60"	35 3/8"	1 3/4"	MW2-S6036-R-Q-()	1,048.	1,407.	1,929.
		84"	35 3/8"	1 3/4"	MW2-S8436-R-Q-()	1,305.	1,797.	2,420.
		90"	35 3/8"	1 3/4"	MW2-S9036-R-Q-()	1,405.	1,933.	2,556.
		96"	35 3/8"	1 3/4"	MW2-S9636-R-Q-()	1,506.	2,069.	2,692.
		102"	35 3/8"	1 3/4"	MW2-S10236-R-Q-()	1,606.	2,204.	2,827.
		108"	35 3/8"	1 3/4"	MW2-S10836-R-Q-()	1,706.	2,340.	2,963.
		114"	35 3/8"	1 3/4"	MW2-S11436-R-Q-()	1,807.	2,476.	3,099.
		120"	35 3/8"	1 3/4"	MW2-S12036-R-Q-()	1,907.	2,611.	3,234.
No Grommets 		36"	35 3/8"	1 3/4"	MW2-S3636-B-Q-()	720.	848.	1,375.
		42"	35 3/8"	1 3/4"	MW2-S4236-B-Q-()	781.	968.	1,494.
		48"	35 3/8"	1 3/4"	MW2-S4836-B-Q-()	843.	1,087.	1,613.
		54"	35 3/8"	1 3/4"	MW2-S5436-B-Q-()	904.	1,206.	1,732.
		60"	35 3/8"	1 3/4"	MW2-S6036-B-Q-()	965.	1,325.	1,851.
		84"	35 3/8"	1 3/4"	MW2-S8436-B-Q-()	1,222.	1,717.	2,342.
		90"	35 3/8"	1 3/4"	MW2-S9036-B-Q-()	1,323.	1,853.	2,478.
		96"	35 3/8"	1 3/4"	MW2-S9636-B-Q-()	1,423.	1,988.	2,614.
		102"	35 3/8"	1 3/4"	MW2-S10236-B-Q-()	1,523.	2,124.	2,749.
		108"	35 3/8"	1 3/4"	MW2-S10836-B-Q-()	1,624.	2,260.	2,885.
		114"	35 3/8"	1 3/4"	MW2-S11436-B-Q-()	1,724.	2,395.	3,021.
		120"	35 3/8"	1 3/4"	MW2-S12036-B-Q-()	1,824.	2,531.	3,157.

Morrison System

Order Code

Example:	MW2-S6036R-Q-117
MW2	Worksurface, 1 3/4" thick
S	Straight worksurface
60	Width
36	Depth
R	Grommets
Q	Standare Special
117	Surface finish

Specification Information

Grommets/no grommets:
B- worksurface does not include grommets
R- worksurface includes 3" grommets recessed for use with 6" recessed desk support.
 Specify surface finish.
 All worksurfaces are U.L.-listed.

Application Notes

36"D desks may be planned with 6" recessed desk support and 24"D pedestals or end panels, or 29" or 35"W universal end panels with knee-hole filler. 36"D worksurfaces do not accept privacy screens.

Plastic laminate worksurfaces are post-formed top and bottom, front and back.

All straight worksurfaces are 3/8" less than nominal depth for rear wire clearance or privacy screens.

Panel supported worksurfaces over 60" must be mid-span supported by MB2-C18 bracket, specified separately.

Morrison Worksurfaces, 1 3/4" 18" D + Post

Standard Specials Systems

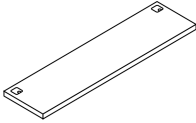
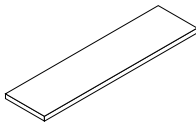
description	type	w	d	h	pattern no.	lam.	V1	V2
Straight, 18"D + Post	Grommets 	20"	17 3/8"	1 3/4"	MW2-S2018-A-Q-()	\$418.	\$609.	\$819.
		26"	17 3/8"	1 3/4"	MW2-S2618-A-Q-()	461.	649.	879.
		32"	17 3/8"	1 3/4"	MW2-S3218-A-Q-()	505.	689.	939.
		38"	17 3/8"	1 3/4"	MW2-S3818-A-Q-()	549.	747.	1,037.
		44"	17 3/8"	1 3/4"	MW2-S4418-A-Q-()	605.	801.	1,116.
		50"	17 3/8"	1 3/4"	MW2-S5018-A-Q-()	642.	864.	1,195.
		56"	17 3/8"	1 3/4"	MW2-S5618-A-Q-()	662.	899.	1,276.
		62"	17 3/8"	1 3/4"	MW2-S6218-A-Q-()	722.	999.	1,412.
		68"	17 3/8"	1 3/4"	MW2-S6818-A-Q-()	780.	1,100.	1,534.
		74"	17 3/8"	1 3/4"	MW2-S7418-A-Q-()	839.	1,200.	1,656.
		80"	17 3/8"	1 3/4"	MW2-S8018-A-Q-()	898.	1,300.	1,777.
		86"	17 3/8"	1 3/4"	MW2-S8618-A-Q-()	957.	1,401.	1,899.
		92"	17 3/8"	1 3/4"	MW2-S9218-A-Q-()	1,016.	1,501.	2,020.
		98"	17 3/8"	1 3/4"	MW2-S9818-A-Q-()	1,075.	1,601.	2,142.
		104"	17 3/8"	1 3/4"	MW2-S10418-A-Q-()	1,134.	1,702.	2,263.
		110"	17 3/8"	1 3/4"	MW2-S11018-A-Q-()	1,193.	1,802.	2,385.
116"	17 3/8"	1 3/4"	MW2-S11618-A-Q-()	1,252.	1,902.	2,506.		
No Grommets 	No Grommets	20"	17 3/8"	1 3/4"	MW2-S2018-B-Q-()	349.	526.	736.
		26"	17 3/8"	1 3/4"	MW2-S2618-B-Q-()	386.	566.	797.
		32"	17 3/8"	1 3/4"	MW2-S3218-B-Q-()	422.	607.	857.
		38"	17 3/8"	1 3/4"	MW2-S3818-B-Q-()	466.	664.	955.
		44"	17 3/8"	1 3/4"	MW2-S4418-B-Q-()	523.	719.	1,034.
		50"	17 3/8"	1 3/4"	MW2-S5018-B-Q-()	559.	781.	1,113.
		56"	17 3/8"	1 3/4"	MW2-S5618-B-Q-()	579.	817.	1,193.
		62"	17 3/8"	1 3/4"	MW2-S6218-B-Q-()	640.	917.	1,330.
		68"	17 3/8"	1 3/4"	MW2-S6818-B-Q-()	756.	1,017.	1,451.
		74"	17 3/8"	1 3/4"	MW2-S7418-B-Q-()	815.	1,117.	1,573.
		80"	17 3/8"	1 3/4"	MW2-S8018-B-Q-()	874.	1,218.	1,694.
		86"	17 3/8"	1 3/4"	MW2-S8618-B-Q-()	933.	1,318.	1,816.
		92"	17 3/8"	1 3/4"	MW2-S9218-B-Q-()	992.	1,418.	1,938.
		98"	17 3/8"	1 3/4"	MW2-S9818-B-Q-()	1,051.	1,519.	2,059.
		104"	17 3/8"	1 3/4"	MW2-S10418-B-Q-()	1,110.	1,619.	2,181.
		110"	17 3/8"	1 3/4"	MW2-S11018-B-Q-()	1,169.	1,719.	2,302.
116"	17 3/8"	1 3/4"	MW2-S11618-B-Q-()	1,228.	1,820.	2,424.		

Order Code

Example:	MW2-S3818-B-Q-117
MW2	Worksurface 1 3/4" thick
S	Worksurface type
38	Width
18	Depth
B	No grommets
Q	Standard Special
117	Surface finish

Specification Information

Grommets/no grommets:
A- Worksurfaces include 3" grommet in each back corner leading into desk support or wire manager.
B- Worksurface does not include grommets.
Specify surface finish
All worksurfaces are U.L.-listed.

Application Notes

18"D worksurfaces are used interchangeably in desk and panel system applications as shallow main surfaces, extensions, or credenza tops. They must be supported at each end by a pedestal, end panel, end support cantilever or cantilever bridging bracket with a maximum span of 60" between supports.

All worksurfaces have threaded metal inserts at all end panel, desk support and bracket locations and pilot holes at pedestal locations.

Panel supported worksurfaces over 60" must be mid-span supported by MB2-C18 bracket, specified separately.

18"D worksurfaces with desk supports or filler panels do not accept pedestals.

All worksurfaces are 3/8" less than nominal depth for rear wire clearance or privacy screens.

Morrison Worksurfaces, 1 3/4" 24" D + Post

Standard Specials Systems

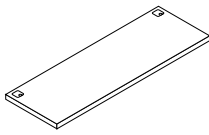
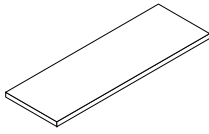
description	type	w	d	h	pattern no.	lam.	V1	V2
Straight, 24"D + Post	Grommets 	20"	23 5/8"	1 3/4"	MW2-S2024-A-Q-()	\$469.	\$706.	\$955.
		26"	23 5/8"	1 3/4"	MW2-S2624-A-Q-()	506.	725.	994.
		32"	23 5/8"	1 3/4"	MW2-S3224-A-Q-()	548.	766.	1,036.
		38"	23 5/8"	1 3/4"	MW2-S3824-A-Q-()	605.	802.	1,115.
		44"	23 5/8"	1 3/4"	MW2-S4424-A-Q-()	642.	880.	1,237.
		50"	23 5/8"	1 3/4"	MW2-S5024-A-Q-()	682.	958.	1,335.
		56"	23 5/8"	1 3/4"	MW2-S5624-A-Q-()	739.	1,021.	1,412.
		62"	23 5/8"	1 3/4"	MW2-S6224-A-Q-()	798.	1,115.	1,553.
		68"	23 5/8"	1 3/4"	MW2-S6824-A-Q-()	876.	1,211.	1,713.
		74"	23 5/8"	1 3/4"	MW2-S7424-A-Q-()	952.	1,310.	1,829.
		80"	23 5/8"	1 3/4"	MW2-S8024-A-Q-()	1,010.	1,407.	1,968.
		86"	23 5/8"	1 3/4"	MW2-S8624-A-Q-()	1,087.	1,526.	2,149.
		92"	23 5/8"	1 3/4"	MW2-S9224-A-Q-()	1,186.	1,680.	2,347.
		98"	23 5/8"	1 3/4"	MW2-S9824-A-Q-()	1,304.	1,835.	2,546.
		104"	23 5/8"	1 3/4"	MW2-S10424-A-Q-()	1,422.	1,989.	2,746.
		110"	23 5/8"	1 3/4"	MW2-S11024-A-Q-()	1,540.	2,144.	2,945.
116"	23 5/8"	1 3/4"	MW2-S11624-A-Q-()	1,658.	2,299.	3,145.		
No Grommets		20"	23 5/8"	1 3/4"	MW2-S2024-B-Q-()	386.	623.	874.
		26"	23 5/8"	1 3/4"	MW2-S2624-B-Q-()	422.	643.	916.
		32"	23 5/8"	1 3/4"	MW2-S3224-B-Q-()	466.	683.	955.
		38"	23 5/8"	1 3/4"	MW2-S3824-B-Q-()	523.	719.	1,034.
		44"	23 5/8"	1 3/4"	MW2-S4424-B-Q-()	559.	800.	1,154.
		50"	23 5/8"	1 3/4"	MW2-S5024-B-Q-()	602.	877.	1,253.
		56"	23 5/8"	1 3/4"	MW2-S5624-B-Q-()	655.	940.	1,330.
		62"	23 5/8"	1 3/4"	MW2-S6224-B-Q-()	715.	1,034.	1,471.
		68"	23 5/8"	1 3/4"	MW2-S6824-B-Q-()	791.	1,132.	1,632.
		74"	23 5/8"	1 3/4"	MW2-S7424-B-Q-()	870.	1,228.	1,752.
		80"	23 5/8"	1 3/4"	MW2-S8024-B-Q-()	930.	1,325.	1,889.
		86"	23 5/8"	1 3/4"	MW2-S8624-B-Q-()	1,003.	1,446.	2,067.
		92"	23 5/8"	1 3/4"	MW2-S9224-B-Q-()	1,103.	1,600.	2,267.
		98"	23 5/8"	1 3/4"	MW2-S9824-B-Q-()	1,221.	1,755.	2,466.
		104"	23 5/8"	1 3/4"	MW2-S10424-B-Q-()	1,339.	1,909.	2,666.
		110"	23 5/8"	1 3/4"	MW2-S11024-B-Q-()	1,457.	2,064.	2,865.
116"	23 5/8"	1 3/4"	MW2-S11624-B-Q-()	1,575.	2,218.	3,064.		

Morrison System

Order Code	Specification Information	Application Notes
Example: MW2-S7424-A-Q-117	<i>Grommets/no grommets:</i>	24"D worksurfaces are used interchangeably as shallow main surfaces, extensions or credenza tops. They must be supported at each end by a pedestal, end panel, end support cantilever or cantilever bridging bracket with a maximum span of 60" between supports.
MW2 Worksurface, 1 3/4" thick	A- Worksurfaces include 3" grommet in each back corner leading into desk support or wire manager.	
S Straight worksurface	B- Worksurface does not include grommets.	All worksurfaces have threaded metal inserts at all end panel, desk support and bracket locations and pilot holes at pedestal locations.
74 Width	Specify surface finish	
24 Depth	All worksurfaces are U.L.-listed.	Use 18"D pedestals with 24"D worksurfaces for full wire management capability in desk or panel applications.
A Grommets		
Q Standard Special		All straight worksurfaces are 3/8" less than nominal depth for rear wire clearance or privacy screens.
117 Surface finish		

Plastic laminate worksurfaces are post-formed top and bottom, front and back.

Worksurfaces with grommets are bored to accept and are shipped with wire manager clips.

Panel supported worksurfaces over 60" must be mid-span supported by MB2-C18 bracket, specified separately.

Morrison Worksurfaces, 1 3/4" 30" D + Post

Standard Specials Systems

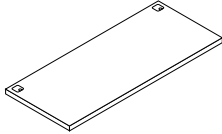
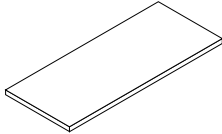
description	type	w	d	h	pattern no.	lam.	V1	V2
Straight, 30"D + Post		20"	29 5/8"	1 3/4"	MW2-S2030-A-Q-()	\$521.	\$726.	\$1,016.
		26"	29 5/8"	1 3/4"	MW2-S2630-A-Q-()	564.	784.	1,096.
		32"	29 5/8"	1 3/4"	MW2-S3230-A-Q-()	624.	841.	1,176.
		38"	29 5/8"	1 3/4"	MW2-S3830-A-Q-()	661.	900.	1,253.
		44"	29 5/8"	1 3/4"	MW2-S4430-A-Q-()	719.	977.	1,352.
		50"	29 5/8"	1 3/4"	MW2-S5030-A-Q-()	755.	1,056.	1,429.
		56"	29 5/8"	1 3/4"	MW2-S5630-A-Q-()	798.	1,115.	1,553.
		62"	29 5/8"	1 3/4"	MW2-S6230-A-Q-()	858.	1,194.	1,691.
		68"	29 5/8"	1 3/4"	MW2-S6830-A-Q-()	952.	1,310.	1,829.
		74"	29 5/8"	1 3/4"	MW2-S7430-A-Q-()	1,030.	1,429.	1,988.
		80"	29 5/8"	1 3/4"	MW2-S8030-A-Q-()	1,107.	1,545.	2,169.
		86"	29 5/8"	1 3/4"	MW2-S8630-A-Q-()	1,205.	1,698.	2,407.
		92"	29 5/8"	1 3/4"	MW2-S9230-A-Q-()	1,318.	1,855.	2,643.
		98"	29 5/8"	1 3/4"	MW2-S9830-A-Q-()	1,436.	2,012.	2,879.
		104"	29 5/8"	1 3/4"	MW2-S10430-A-Q-()	1,554.	2,169.	3,115.
		110"	29 5/8"	1 3/4"	MW2-S11030-A-Q-()	1,672.	2,326.	3,351.
116"	29 5/8"	1 3/4"	MW2-S11630-A-Q-()	1,790.	2,483.	3,587.		
No Grommets		20"	29 5/8"	1 3/4"	MW2-S2030-B-Q-()	441.	647.	939.
		26"	29 5/8"	1 3/4"	MW2-S2630-B-Q-()	485.	704.	1,017.
		32"	29 5/8"	1 3/4"	MW2-S3230-B-Q-()	543.	762.	1,095.
		38"	29 5/8"	1 3/4"	MW2-S3830-B-Q-()	579.	817.	1,175.
		44"	29 5/8"	1 3/4"	MW2-S4430-B-Q-()	637.	894.	1,273.
		50"	29 5/8"	1 3/4"	MW2-S5030-B-Q-()	676.	976.	1,349.
		56"	29 5/8"	1 3/4"	MW2-S5630-B-Q-()	715.	1,034.	1,471.
		62"	29 5/8"	1 3/4"	MW2-S6230-B-Q-()	778.	1,113.	1,611.
		68"	29 5/8"	1 3/4"	MW2-S6830-B-Q-()	870.	1,228.	1,752.
		74"	29 5/8"	1 3/4"	MW2-S7430-B-Q-()	949.	1,349.	1,907.
		80"	29 5/8"	1 3/4"	MW2-S8030-B-Q-()	1,027.	1,463.	2,086.
		86"	29 5/8"	1 3/4"	MW2-S8630-B-Q-()	1,122.	1,617.	2,328.
		92"	29 5/8"	1 3/4"	MW2-S9230-B-Q-()	1,234.	1,770.	2,565.
		98"	29 5/8"	1 3/4"	MW2-S9830-B-Q-()	1,352.	1,927.	2,801.
		104"	29 5/8"	1 3/4"	MW2-S10430-B-Q-()	1,470.	2,084.	3,037.
		110"	29 5/8"	1 3/4"	MW2-S11030-B-Q-()	1,588.	2,241.	3,273.
116"	29 5/8"	1 3/4"	MW2-S11630-B-Q-()	1,706.	2,398.	3,509.		

Order Code	Specification Information	Application Notes
Example: MW2-S4430A-Q-117	<i>Grommets/no grommets:</i>	30"D worksurfaces are used interchangeably in desk and panel system applications as main surfaces, extensions or credenza tops. They must be supported at each end by a pedestal, end panel, end support cantilever or cantilever bridging bracket with a maximum span of 60" between supports.
MW2 Worksurface, 1 3/4" thick	A- worksurface includes 3" grommet in each back corner leading into desk support or wire manager clips.	
S Straight worksurface	B- worksurface does not include grommets	All straight worksurfaces are 3/8" less than nominal depth for rear wire clearance or privacy screens.
44 Width	Specify surface finish.	
30 Depth		Panel supported worksurfaces over 60" must be mid-span supported by MB2-C18 bracket, specified separately.
A Grommets		
Q Standard Special		
117 Surface finish		
	All worksurfaces are U.L.-listed.	

Morrison Worksurfaces, 1 3/4" 36" D + Post

Standard Specials Systems

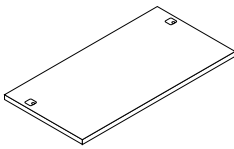
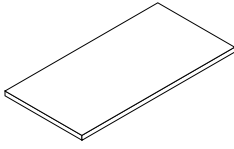
description	type	w	d	h	pattern no.	lam.	V1	V2
Straight, 36"D + Post		38"	35 3/8"	1 3/4"	MW2-S3836-R-Q-()	\$917.	\$1,049.	\$1,522.
		44"	35 3/8"	1 3/4"	MW2-S4436-R-Q-()	961.	1,168.	1,658.
		50"	35 3/8"	1 3/4"	MW2-S5036-R-Q-()	1,004.	1,287.	1,794.
		56"	35 3/8"	1 3/4"	MW2-S5636-R-Q-()	1,048.	1,407.	1,929.
		62"	35 3/8"	1 3/4"	MW2-S6236-R-Q-()	1,077.	1,467.	2,039.
		68"	35 3/8"	1 3/4"	MW2-S6836-R-Q-()	1,107.	1,526.	2,149.
		74"	35 3/8"	1 3/4"	MW2-S7436-R-Q-()	1,205.	1,661.	2,284.
		80"	35 3/8"	1 3/4"	MW2-S8036-R-Q-()	1,305.	1,797.	2,420.
		86"	35 3/8"	1 3/4"	MW2-S8636-R-Q-()	1,405.	1,933.	2,556.
		92"	35 3/8"	1 3/4"	MW2-S9236-R-Q-()	1,506.	2,069.	2,692.
		98"	35 3/8"	1 3/4"	MW2-S9836-R-Q-()	1,606.	2,204.	2,827.
		104"	35 3/8"	1 3/4"	MW2-S10436-R-Q-()	1,706.	2,340.	2,963.
		110"	35 3/8"	1 3/4"	MW2-S11036-R-Q-()	1,807.	2,476.	3,099.
		116"	35 3/8"	1 3/4"	MW2-S11636-R-Q-()	1,907.	2,611.	3,234.
No Grommets		38"	35 3/8"	1 3/4"	MW2-S3836-B-Q-()	781.	968.	1,494.
		44"	35 3/8"	1 3/4"	MW2-S4436-B-Q-()	843.	1,087.	1,613.
		50"	35 3/8"	1 3/4"	MW2-S5036-B-Q-()	904.	1,206.	1,732.
		56"	35 3/8"	1 3/4"	MW2-S5636-B-Q-()	965.	1,325.	1,851.
		62"	35 3/8"	1 3/4"	MW2-S6236-B-Q-()	996.	1,385.	1,960.
		68"	35 3/8"	1 3/4"	MW2-S6836-B-Q-()	1,027.	1,446.	2,067.
		74"	35 3/8"	1 3/4"	MW2-S7436-B-Q-()	1,122.	1,581.	2,207.
		80"	35 3/8"	1 3/4"	MW2-S8036-B-Q-()	1,222.	1,717.	2,342.
		86"	35 3/8"	1 3/4"	MW2-S8636-B-Q-()	1,323.	1,853.	2,478.
		92"	35 3/8"	1 3/4"	MW2-S9236-B-Q-()	1,423.	1,988.	2,614.
		98"	35 3/8"	1 3/4"	MW2-S9836-B-Q-()	1,523.	2,124.	2,749.
		104"	35 3/8"	1 3/4"	MW2-S10436-B-Q-()	1,624.	2,260.	2,885.
		110"	35 3/8"	1 3/4"	MW2-S11036-B-Q-()	1,724.	2,395.	3,021.
		116"	35 3/8"	1 3/4"	MW2-S11636-B-Q-()	1,824.	2,531.	3,157.

Morrison System

Order Code

Example:	MW2-S6836R-Q-117
MW2	Worksurface, 1 3/4" thick
S	Straight worksurface
68	Width
36	Depth
R	Grommets
Q	Standard Special
117	Surface finish

Specificatin Information

Grommets/no grommets:
 B- worksurface does not include grommets
 R- worksurface includes 3" grommets recessed for use with 6" recessed desk support.
 Specify surface finish.
 All worksurfaces are U.L.-listed.

Application Notes

36"D desks may be planned with 6" recessed desk support and 24"D pedestals or end panels, or 29" or 35"W universal end panels with kneehole filler. 36"D worksurfaces do not accept privacy screens.
 Plastic laminate worksurfaces are post-formed top and bottom, front and back.

Panel supported worksurfaces over 60" must be mid-span supported by MB2-C18 bracket, specified separately.

All straight worksurfaces are 3/8" less than nominal depth for rear wire clearance or privacy screens.

Morrison Worksurfaces, 1 1/4" 18" D

Standard Specials Systems

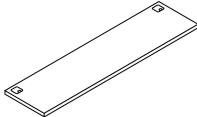
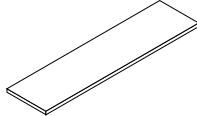
description	type	w	d	h	pattern no.	lam.	V1	V2
Straight, 18"D	Grommets 	18"	17 5/8"	1 1/4"	MU1-S1818-A-Q-()	\$350.	\$511.	\$704.
		24"	17 5/8"	1 1/4"	MU1-S2418-A-Q-()	350.	511.	704.
		30"	17 5/8"	1 1/4"	MU1-S3018-A-Q-()	381.	546.	759.
		36"	17 5/8"	1 1/4"	MU1-S3618-A-Q-()	413.	582.	813.
		42"	17 5/8"	1 1/4"	MU1-S4218-A-Q-()	430.	623.	887.
		48"	17 5/8"	1 1/4"	MU1-S4818-A-Q-()	487.	677.	964.
		54"	17 5/8"	1 1/4"	MU1-S5418-A-Q-()	505.	714.	1,021.
		60"	17 5/8"	1 1/4"	MU1-S6018-A-Q-()	526.	752.	1,099.
		66"	17 5/8"	1 1/4"	MU1-S6618-A-Q-()	562.	827.	1,207.
		72"	17 5/8"	1 1/4"	MU1-S7218-A-Q-()	617.	917.	1,324.
		78"	17 5/8"	1 1/4"	MU1-S7818-A-Q-()	676.	1,007.	1,442.
		84"	17 5/8"	1 1/4"	MU1-S8418-A-Q-()	735.	1,096.	1,560.
		90"	17 5/8"	1 1/4"	MU1-S9018-A-Q-()	794.	1,186.	1,678.
		96"	17 5/8"	1 1/4"	MU1-S9618-A-Q-()	853.	1,276.	1,796.
		102"	17 5/8"	1 1/4"	MU1-S10218-A-Q-()	912.	1,365.	1,914.
108"	17 5/8"	1 1/4"	MU1-S10818-A-Q-()	971.	1,455.	2,032.		
114"	17 5/8"	1 1/4"	MU1-S11418-A-Q-()	1,030.	1,545.	2,150.		
120"	17 5/8"	1 1/4"	MU1-S12018-A-Q-()	1,089.	1,634.	2,268.		
No Grommets 	18"	17 5/8"	1 1/4"	MU1-S1818-B-Q-()	267.	428.	622.	
	78"	17 5/8"	1 1/4"	MU1-S7818-B-Q-()	653.	924.	1,359.	
	84"	17 5/8"	1 1/4"	MU1-S8418-B-Q-()	712.	1,014.	1,477.	
	90"	17 5/8"	1 1/4"	MU1-S9018-B-Q-()	771.	1,103.	1,595.	
	96"	17 5/8"	1 1/4"	MU1-S9618-B-Q-()	830.	1,193.	1,713.	
	102"	17 5/8"	1 1/4"	MU1-S10218-B-Q-()	889.	1,283.	1,831.	
	108"	17 5/8"	1 1/4"	MU1-S10818-B-Q-()	948.	1,372.	1,949.	
	114"	17 5/8"	1 1/4"	MU1-S11418-B-Q-()	1,007.	1,462.	2,067.	
120"	17 5/8"	1 1/4"	MU1-S12018-B-Q-()	1,066.	1,552.	2,185.		

Order Code

Example:	MU1-S4818-A-Q-117
MU1	Worksurface 1 1/4" thick
S	Worksurface type
48	Width
18	Depth
A	Grommets
Q	Standard Special
117	Surface finish
Q	Standard Special

Specification Information

Grommets/no grommets:

A- Worksurfaces include 3" grommet in each back corner leading into desk support or wire manager.

B- Worksurface does not include grommets.

Specify surface finish.
1 1/4" worksurfaces are 3-ply, solid core construction with threaded metal inserts at all end panel, desk support and bracket locations and pilot holes at pedestal locations.

Worksurfaces with grommets are bored to accept and are shipped with wire manager clips.

All worksurfaces are U.L.-listed.

Application Notes

18"D worksurfaces are used interchangeably in desk and panel system applications as shallow main surfaces, extensions, or credenza tops. They may be supported at each end by an 18" end support bracket, 18" cantilever bracket, 18"W conference end panel, 18"D pedestal, or 12"W end panel (MN2-E12) in conjunction with a desk support.

18"D worksurfaces with desk supports do not accept pedestals.

All worksurfaces are 3/8" less than nominal depth for rear wire clearance or privacy screens.

Panel-supported 1 1/4" worksurfaces over 48" must be mid-span supported by MB2-C18 bracket, specified separately.

Suspended pedestals may not be used with 1 1/4" worksurfaces

Morrison Worksurfaces, 1 1/4" 24" D

Standard Specials Systems

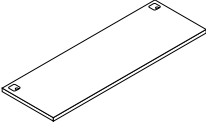
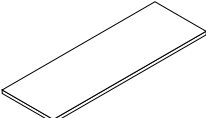
description	type	w	d	h	pattern no.	lam.	V1	V2
Straight, 24"D		18"	23 5/8"	1 1/4"	MU1-S1824-A-Q-()	\$376.	\$602.	\$830.
		102"	23 5/8"	1 1/4"	MU1-S10224-A-Q-()	1,002.	1,483.	2,139.
		108"	23 5/8"	1 1/4"	MU1-S10824-A-Q-()	1,079.	1,601.	2,310.
		114"	23 5/8"	1 1/4"	MU1-S11424-A-Q-()	1,155.	1,719.	2,482.
		120"	23 5/8"	1 1/4"	MU1-S12024-A-Q-()	1,232.	1,837.	2,653.
No Grommets		18"	23 5/8"	1 1/4"	MU1-S1824-B-Q-()	299.	523.	752.
		102"	23 5/8"	1 1/4"	MU1-S10224-B-Q-()	919.	1,402.	2,060.
		108"	23 5/8"	1 1/4"	MU1-S10824-B-Q-()	996.	1,520.	2,231.
		114"	23 5/8"	1 1/4"	MU1-S11424-B-Q-()	1,073.	1,638.	2,402.
		120"	23 5/8"	1 1/4"	MU1-S12024-B-Q-()	1,149.	1,756.	2,574.

Morrison System

Order Code	Specification Information	Application Notes
Example: MU1-S10224-B-Q-117	<i>Grommets/no grommets:</i>	24"D worksurfaces are used interchangeably as shallow main surfaces, extensions or credenza tops. They can be supported at each end by 24" end support bracket, 24" cantilever bracket, 24"W end panel, 18"D pedestal or end panel in conjunction with desk support.
MU1 Worksurface, 1 1/4" thick	A- Worksurfaces include 3" grommet in each back corner leading into desk support or wire manager.	Suspended pedestals may not be used with 1 1/4" worksurfaces
S Straight worksurface	B- Worksurface does not include grommets.	
102 Width	Specify surface finish.	Use 18"D pedestals with 24"D worksurfaces for full wire management capability in desk or panel applications.
24 Depth	1 1/4" worksurfaces are 3-ply, solid core construction with threaded metal inserts at all end panel, desk support and bracket locations and pilot holes at pedestal locations.	All straight worksurfaces are 3/8" less than nominal depth for rear wire clearance or privacy screens.
B No grommets	Worksurfaces with grommets are bored to accept and are shipped with wire manager clips.	Panel-supported 1 1/4" worksurfaces over 48" must be mid-span supported by MB2-C18 bracket, specified separately.
Q Standard Special	All worksurfaces are U.L.-listed.	
117 Surface finish		

Morrison Worksurfaces, 1 1/4" 30" D

Standard Specials Systems

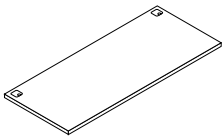
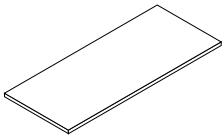
description	type	w	d	h	pattern no.	lam,	V1	V2
Straight, 30"D	Grommets 	18"	29 5/8"	1 1/4"	MU1-S1830-A-Q-()	\$414.	\$614.	\$885.
		24"	29 5/8"	1 1/4"	MU1-S2430-A-Q-()	414.	614.	885.
		102"	29 5/8"	1 1/4"	MU1-S10230-A-Q-()	1,075.	1,580.	2,326.
		108"	29 5/8"	1 1/4"	MU1-S10830-A-Q-()	1,158.	1,698.	2,499.
		114"	29 5/8"	1 1/4"	MU1-S11430-A-Q-()	1,240.	1,816.	2,673.
		120"	29 5/8"	1 1/4"	MU1-S12030-A-Q-()	1,323.	1,934.	2,846.
No Grommets 	No Grommets	18"	29 5/8"	1 1/4"	MU1-S1830-B-Q-()	336.	536.	807.
		24"	29 5/8"	1 1/4"	MU1-S2430-B-Q-()	336.	536.	807.
		102"	29 5/8"	1 1/4"	MU1-S10230-B-Q-()	994.	1,500.	2,247.
		108"	29 5/8"	1 1/4"	MU1-S10830-B-Q-()	1,076.	1,618.	2,420.
		114"	29 5/8"	1 1/4"	MU1-S11430-B-Q-()	1,159.	1,736.	2,594.
		120"	29 5/8"	1 1/4"	MU1-S12030-B-Q-()	1,241.	1,854.	2,767.

Order Code

Example:	MU1-S2430B-Q-117
MU1	Worksurface, 1 1/4" thick
S	Straight worksurface
24	Width
30	Depth
B	No grommets
Q	Standard Specials
117	Surface finish

Specification Information

Grommets/no grommets:

- A- worksurface includes 3" grommet in each back corner leading into desk support or wire manager clips.
 - B- worksurface does not include grommets
- Specify surface finish.

1 1/4" worksurfaces are 3-ply, solid core construction with threaded metal inserts at all end panel, desk support and bracket locations and pilot holes at pedestal locations.

All worksurfaces are U.L.-listed. Plastic laminate worksurfaces are post-formed top and bottom, front and back.

Application Notes

30"D worksurfaces are used interchangeably in desk and panel system applications as main surfaces, extensions or credenza tops. They can be supported at each end by 30" end support bracket, 30" cantilever bracket, 30" flat bracket, 30"W end panel, 24"D pedestal or end panel in conjunction with desk support, or 30"D pedestal.

All straight worksurfaces are 3/8" less than nominal depth for rear wire clearance or privacy screens.

Panel-supported 1 1/4" worksurfaces over 48" must be mid-span supported by MB2-C18 bracket, specified separately.

Worksurfaces with grommets are bored to accept and are shipped with wire manager clips.

Suspended pedestals may not be used with 1 1/4" worksurfaces.

Morrison Worksurfaces, 1 1/4" 36" D

Standard Specials Systems

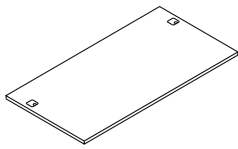
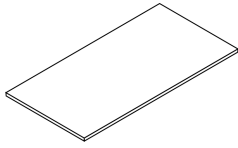
description	type	w	d	h	pattern no.	lam.	V1	V2
Straight, 36"D		36"	35 5/8"	1 1/4"	MU1-S3636-R-Q-()	\$568.	\$792.	\$1,185.
		42"	35 5/8"	1 1/4"	MU1-S4236-R-Q-()	607.	847.	1,258.
		48"	35 5/8"	1 1/4"	MU1-S4836-R-Q-()	641.	900.	1,335.
		54"	35 5/8"	1 1/4"	MU1-S5436-R-Q-()	677.	974.	1,428.
		60"	35 5/8"	1 1/4"	MU1-S6036-R-Q-()	714.	1,034.	1,520.
		66"	35 5/8"	1 1/4"	MU1-S6636-R-Q-()	750.	1,088.	1,633.
		72"	35 5/8"	1 1/4"	MU1-S7236-R-Q-()	824.	1,181.	1,745.
		78"	35 5/8"	1 1/4"	MU1-S7836-R-Q-()	884.	1,272.	1,905.
		84"	35 5/8"	1 1/4"	MU1-S8436-R-Q-()	946.	1,363.	2,043.
		90"	35 5/8"	1 1/4"	MU1-S9036-R-Q-()	996.	1,442.	2,163.
		96"	35 5/8"	1 1/4"	MU1-S9636-R-Q-()	1,075.	1,560.	2,336.
		102"	35 5/8"	1 1/4"	MU1-S10236-R-Q-()	1,158.	1,678.	2,510.
		108"	35 5/8"	1 1/4"	MU1-S10836-R-Q-()	1,240.	1,796.	2,683.
		114"	35 5/8"	1 1/4"	MU1-S11436-R-Q-()	1,323.	1,914.	2,857.
		120"	35 5/8"	1 1/4"	MU1-S12036-R-Q-()	1,405.	2,032.	3,030.
		No Grommets		36"	35 5/8"	1 1/4"	MU1-S3636-B-Q-()	487.
42"	35 5/8"			1 1/4"	MU1-S4236-B-Q-()	526.	767.	1,180.
48"	35 5/8"			1 1/4"	MU1-S4836-B-Q-()	562.	824.	1,256.
54"	35 5/8"			1 1/4"	MU1-S5436-B-Q-()	597.	896.	1,350.
60"	35 5/8"			1 1/4"	MU1-S6036-B-Q-()	635.	956.	1,443.
66"	35 5/8"			1 1/4"	MU1-S6636-B-Q-()	671.	1,005.	1,554.
72"	35 5/8"			1 1/4"	MU1-S7236-B-Q-()	743.	1,102.	1,666.
78"	35 5/8"			1 1/4"	MU1-S7836-B-Q-()	801.	1,192.	1,823.
84"	35 5/8"			1 1/4"	MU1-S8436-B-Q-()	864.	1,283.	1,959.
90"	35 5/8"			1 1/4"	MU1-S9036-B-Q-()	918.	1,365.	2,084.
96"	35 5/8"			1 1/4"	MU1-S9636-B-Q-()	994.	1,480.	2,257.
102"	35 5/8"			1 1/4"	MU1-S10236-B-Q-()	1,076.	1,598.	2,431.
108"	35 5/8"			1 1/4"	MU1-S10836-B-Q-()	1,159.	1,716.	2,604.
114"	35 5/8"			1 1/4"	MU1-S11436-B-Q-()	1,241.	1,834.	2,778.
120"	35 5/8"			1 1/4"	MU1-S12036-B-Q-()	1,324.	1,952.	2,951.

Morrison System

Order Code

Example:	MU1-S3636B-Q-117
MU1	Worksurface, 1 1/4" thick
S	Straight worksurface
36	Width
36	Depth
B	No grommets
Q	Standard Specials
117	Surface finish

Specification Information

Grommets/no grommets:

- A- worksurface includes 3" grommet in each back corner leading into desk support or wire manager clips.
 - B- worksurface does not include grommets
- Specify surface finish.

1 1/4" worksurfaces are 3-ply, solid core construction with threaded metal inserts at all end panel, desk support and bracket locations and pilot holes at pedestal locations.

All worksurfaces are U.L.-listed. Plastic laminate worksurfaces are post-formed top and bottom, front and back.

Application Notes

36"D worksurfaces are used interchangeably in desk and panel system applications as main surfaces, extensions or credenza tops. They can be supported at each end by 30" end support bracket, 30" cantilever bracket, 36" flat bracket, 30"W end panel, 24"D pedestal or end panel in conjunction with desk support, or 30"D pedestal.

All straight worksurfaces are 3/8" less than nominal depth for rear wire clearance or privacy screens.

Panel-supported 1 1/4" worksurfaces over 48" must be mid-span supported by MB2-C18 bracket, specified separately.

Worksurfaces with grommets are bored to accept and are shipped with wire manager clips.

Suspended pedestals may not be used with 1 1/4" worksurfaces.

Morrison Worksurfaces, 1 1/4" 18" D + Post

Standard Specials Systems

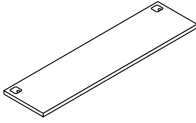
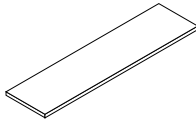
description	type	w	d	h	pattern no.	lam.	V1	V2
Straight, 18"D + Post	Grommets 	20"	17 5/8"	1 1/4"	MU1-S2018-A-Q-()	\$350.	\$511.	\$704.
		26"	17 5/8"	1 1/4"	MU1-S2618-A-Q-()	381.	546.	759.
		32"	17 5/8"	1 1/4"	MU1-S3218-A-Q-()	413.	582.	813.
		38"	17 5/8"	1 1/4"	MU1-S3818-A-Q-()	430.	623.	887.
		44"	17 5/8"	1 1/4"	MU1-S4418-A-Q-()	487.	677.	964.
		50"	17 5/8"	1 1/4"	MU1-S5018-A-Q-()	505.	714.	1,021.
		56"	17 5/8"	1 1/4"	MU1-S5618-A-Q-()	526.	752.	1,099.
		62"	17 5/8"	1 1/4"	MU1-S6218-A-Q-()	562.	827.	1,207.
		68"	17 5/8"	1 1/4"	MU1-S6818-A-Q-()	617.	917.	1,324.
		74"	17 5/8"	1 1/4"	MU1-S7418-A-Q-()	676.	1,007.	1,442.
		80"	17 5/8"	1 1/4"	MU1-S8018-A-Q-()	735.	1,096.	1,560.
		86"	17 5/8"	1 1/4"	MU1-S8618-A-Q-()	794.	1,186.	1,678.
		92"	17 5/8"	1 1/4"	MU1-S9218-A-Q-()	853.	1,276.	1,796.
		98"	17 5/8"	1 1/4"	MU1-S9818-A-Q-()	912.	1,365.	1,914.
		104"	17 5/8"	1 1/4"	MU1-S10418-A-Q-()	971.	1,455.	2,032.
		110"	17 5/8"	1 1/4"	MU1-S11018-A-Q-()	1,030.	1,545.	2,150.
116"	17 5/8"	1 1/4"	MU1-S11618-A-Q-()	1,089.	1,634.	2,268.		
No Grommets 	No Grommets	20"	17 5/8"	1 1/4"	MU1-S2018-B-Q-()	267.	428.	622.
		26"	17 5/8"	1 1/4"	MU1-S2618-B-Q-()	299.	464.	676.
		32"	17 5/8"	1 1/4"	MU1-S3218-B-Q-()	330.	499.	730.
		38"	17 5/8"	1 1/4"	MU1-S3818-B-Q-()	347.	540.	805.
		44"	17 5/8"	1 1/4"	MU1-S4418-B-Q-()	405.	595.	881.
		50"	17 5/8"	1 1/4"	MU1-S5018-B-Q-()	422.	631.	938.
		56"	17 5/8"	1 1/4"	MU1-S5618-B-Q-()	444.	669.	1,016.
		62"	17 5/8"	1 1/4"	MU1-S6218-B-Q-()	479.	745.	1,125.
		68"	17 5/8"	1 1/4"	MU1-S6818-B-Q-()	594.	834.	1,241.
		74"	17 5/8"	1 1/4"	MU1-S7418-B-Q-()	653.	924.	1,359.
		80"	17 5/8"	1 1/4"	MU1-S8018-B-Q-()	712.	1,014.	1,477.
		86"	17 5/8"	1 1/4"	MU1-S8618-B-Q-()	771.	1,103.	1,595.
		92"	17 5/8"	1 1/4"	MU1-S9218-B-Q-()	830.	1,193.	1,713.
		98"	17 5/8"	1 1/4"	MU1-S9818-B-Q-()	889.	1,283.	1,831.
		104"	17 5/8"	1 1/4"	MU1-S10418-B-Q-()	948.	1,372.	1,949.
		110"	17 5/8"	1 1/4"	MU1-S11018-B-Q-()	1,007.	1,462.	2,067.
116"	17 5/8"	1 1/4"	MU1-S11618-B-Q-()	1,066.	1,552.	2,185.		

Order Code

Example:	MU1-S4418-B-Q-117
MU1	Worksurface 1 1/4" thick
S	Worksurface type
44	Width
18	Depth
B	No grommets
Q	Standard Specials
117	Surface finish

Specification Information

B: Worksurface does not include grommets.

Specify surface finish.

1 1/4" worksurfaces are 3-ply, solid core construction with threaded metal inserts at all end panel, desk support and bracket locations and pilot holes at pedestal locations.

All worksurfaces are U.L.-listed.

Application Notes

18"D worksurfaces are used interchangeably in desk and panel system applications as shallow main surfaces, extensions, or credenza tops. They may be supported at each end by an 18" end support bracket, 18" cantilever bracket, 18"W conference end panel, 18"D pedestal, or 12"W end panel (MN2-E12) in conjunction with a desk support.

18"D worksurfaces with desk supports do not accept pedestals.

All worksurfaces are 3/8" less than nominal depth for rear wire clearance or privacy screens.

Panel-supported 1 1/4" worksurfaces over 48" must be mid-span supported by MB2-C18 bracket, specified separately.

Suspended pedestals may not be used with 1 1/4" worksurfaces

Morrison Worksurfaces, 1 1/4" 24" D + Post

Standard Specials Systems

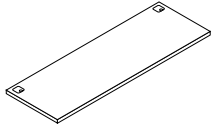
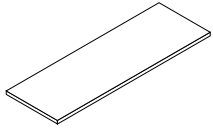
description	type	w	d	h	pattern no.	lam.	V1	V2
Straight, 24"D + Post		20"	23 5/8"	1 1/4"	MU1-S2024-A-Q-()	\$376.	\$602.	\$830.
		26"	23 5/8"	1 1/4"	MU1-S2624-A-Q-()	409.	620.	867.
		32"	23 5/8"	1 1/4"	MU1-S3224-A-Q-()	428.	636.	886.
		38"	23 5/8"	1 1/4"	MU1-S3824-A-Q-()	485.	675.	959.
		44"	23 5/8"	1 1/4"	MU1-S4424-A-Q-()	502.	729.	1,074.
		50"	23 5/8"	1 1/4"	MU1-S5024-A-Q-()	543.	802.	1,151.
		56"	23 5/8"	1 1/4"	MU1-S5624-A-Q-()	578.	840.	1,205.
		62"	23 5/8"	1 1/4"	MU1-S6224-A-Q-()	631.	936.	1,336.
		68"	23 5/8"	1 1/4"	MU1-S6824-A-Q-()	689.	1,009.	1,470.
		74"	23 5/8"	1 1/4"	MU1-S7424-A-Q-()	747.	1,095.	1,569.
		80"	23 5/8"	1 1/4"	MU1-S8024-A-Q-()	799.	1,174.	1,686.
		86"	23 5/8"	1 1/4"	MU1-S8624-A-Q-()	847.	1,250.	1,797.
		92"	23 5/8"	1 1/4"	MU1-S9224-A-Q-()	925.	1,365.	1,968.
		98"	23 5/8"	1 1/4"	MU1-S9824-A-Q-()	1,002.	1,483.	2,139.
		104"	23 5/8"	1 1/4"	MU1-S10424-A-Q-()	1,079.	1,601.	2,310.
		110"	23 5/8"	1 1/4"	MU1-S11024-A-Q-()	1,155.	1,719.	2,482.
116"	23 5/8"	1 1/4"	MU1-S11624-A-Q-()	1,232.	1,837.	2,653.		
No Grommets		20"	23 5/8"	1 1/4"	MU1-S2024-B-Q-()	299.	523.	752.
		26"	23 5/8"	1 1/4"	MU1-S2624-B-Q-()	330.	540.	789.
		32"	23 5/8"	1 1/4"	MU1-S3224-B-Q-()	347.	559.	805.
		38"	23 5/8"	1 1/4"	MU1-S3824-B-Q-()	405.	595.	881.
		44"	23 5/8"	1 1/4"	MU1-S4424-B-Q-()	422.	650.	996.
		50"	23 5/8"	1 1/4"	MU1-S5024-B-Q-()	461.	726.	1,071.
		56"	23 5/8"	1 1/4"	MU1-S5624-B-Q-()	498.	762.	1,125.
		62"	23 5/8"	1 1/4"	MU1-S6224-B-Q-()	552.	858.	1,259.
		68"	23 5/8"	1 1/4"	MU1-S6824-B-Q-()	609.	931.	1,390.
		74"	23 5/8"	1 1/4"	MU1-S7424-B-Q-()	663.	1,016.	1,489.
		80"	23 5/8"	1 1/4"	MU1-S8024-B-Q-()	716.	1,094.	1,608.
		86"	23 5/8"	1 1/4"	MU1-S8624-B-Q-()	768.	1,171.	1,719.
		92"	23 5/8"	1 1/4"	MU1-S9224-B-Q-()	843.	1,284.	1,889.
		98"	23 5/8"	1 1/4"	MU1-S9824-B-Q-()	919.	1,402.	2,060.
		104"	23 5/8"	1 1/4"	MU1-S10424-B-Q-()	996.	1,520.	2,231.
		110"	23 5/8"	1 1/4"	MU1-S11024-B-Q-()	1,073.	1,638.	2,402.
116"	23 5/8"	1 1/4"	MU1-S11624-B-Q-()	1,149.	1,756.	2,574.		

Morrison System

Order Code	Specification Information	Application Notes
Example: MU1-S3824-B-Q-117	<i>Grommets/no grommets:</i>	24"D worksurfaces are used interchangeably as shallow main surfaces, extensions or credenza tops. They can be supported at each end by 24" end support bracket, 24" cantilever bracket, 24"W end panel, 18"D pedestal or end panel in conjunction with desk support.
MU1 Worksurface, 1 1/4" thick	A- Worksurfaces include 3" grommet in each back corner leading into desk support or wire manager.	
S Straight worksurface	B- Worksurface does not include grommets.	Suspended pedestals may not be used with 1 1/4" worksurfaces.
38 Width	Specify surface finish.	
24 Depth	1 1/4" worksurfaces are 3-ply, solid core construction with threaded metal inserts at all end panel, desk support and bracket locations and pilot holes at pedestal locations.	Use 18"D pedestals with 24"D worksurfaces for full wire management capability in desk or panel applications.
B No grommets	Worksurfaces with grommets are bored to accept and are shipped with wire manager clips.	
Q Standard Specials	All worksurfaces are U.L.-listed.	All straight worksurfaces are 3/8" less than nominal depth for rear wire clearance or privacy screens.
117 Surface finish		Panel-supported 1 1/4" worksurfaces over 48" must be mid-span supported by MB2-C18 bracket, specified separately.

Morrison Worksurfaces, 1 1/4"

30" D + Post

Standard Specials Systems

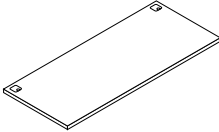
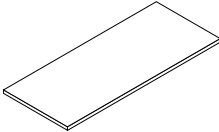
description	type	w	d	h	pattern no.	lam.	V1	V2
Straight, 30"D + Post		20"	29 5/8"	1 1/4"	MU1-S2030-A-Q-(-)	\$414.	\$614.	\$885.
		26"	29 5/8"	1 1/4"	MU1-S2630-A-Q-(-)	450.	654.	943.
		32"	29 5/8"	1 1/4"	MU1-S3230-A-Q-(-)	485.	694.	1,001.
		38"	29 5/8"	1 1/4"	MU1-S3830-A-Q-(-)	524.	749.	1,074.
		44"	29 5/8"	1 1/4"	MU1-S4430-A-Q-(-)	558.	802.	1,151.
		50"	29 5/8"	1 1/4"	MU1-S5030-A-Q-(-)	595.	876.	1,244.
		56"	29 5/8"	1 1/4"	MU1-S5630-A-Q-(-)	631.	936.	1,336.
		62"	29 5/8"	1 1/4"	MU1-S6230-A-Q-(-)	668.	990.	1,449.
		68"	29 5/8"	1 1/4"	MU1-S6830-A-Q-(-)	741.	1,083.	1,561.
		74"	29 5/8"	1 1/4"	MU1-S7430-A-Q-(-)	801.	1,174.	1,720.
		80"	29 5/8"	1 1/4"	MU1-S8030-A-Q-(-)	864.	1,265.	1,859.
		86"	29 5/8"	1 1/4"	MU1-S8630-A-Q-(-)	913.	1,344.	1,979.
		92"	29 5/8"	1 1/4"	MU1-S9230-A-Q-(-)	992.	1,462.	2,152.
		98"	29 5/8"	1 1/4"	MU1-S9830-A-Q-(-)	1,075.	1,580.	2,326.
		104"	29 5/8"	1 1/4"	MU1-S10430-A-Q-(-)	1,158.	1,698.	2,499.
		110"	29 5/8"	1 1/4"	MU1-S11030-A-Q-(-)	1,240.	1,816.	2,673.
		116"	29 5/8"	1 1/4"	MU1-S11630-A-Q-(-)	1,323.	1,934.	2,846.
No Grommets		20"	29 5/8"	1 1/4"	MU1-S2030-B-Q-(-)	336.	536.	807.
		26"	29 5/8"	1 1/4"	MU1-S2630-B-Q-(-)	371.	575.	865.
		32"	29 5/8"	1 1/4"	MU1-S3230-B-Q-(-)	405.	614.	923.
		38"	29 5/8"	1 1/4"	MU1-S3830-B-Q-(-)	444.	669.	996.
		44"	29 5/8"	1 1/4"	MU1-S4430-B-Q-(-)	479.	726.	1,071.
		50"	29 5/8"	1 1/4"	MU1-S5030-B-Q-(-)	514.	798.	1,166.
		56"	29 5/8"	1 1/4"	MU1-S5630-B-Q-(-)	552.	858.	1,259.
		62"	29 5/8"	1 1/4"	MU1-S6230-B-Q-(-)	589.	907.	1,370.
		68"	29 5/8"	1 1/4"	MU1-S6830-B-Q-(-)	661.	1,004.	1,482.
		74"	29 5/8"	1 1/4"	MU1-S7430-B-Q-(-)	719.	1,094.	1,639.
		80"	29 5/8"	1 1/4"	MU1-S8030-B-Q-(-)	781.	1,185.	1,775.
		86"	29 5/8"	1 1/4"	MU1-S8630-B-Q-(-)	835.	1,267.	1,900.
		92"	29 5/8"	1 1/4"	MU1-S9230-B-Q-(-)	911.	1,382.	2,073.
		98"	29 5/8"	1 1/4"	MU1-S9830-B-Q-(-)	994.	1,500.	2,247.
		104"	29 5/8"	1 1/4"	MU1-S10430-B-Q-(-)	1,076.	1,618.	2,420.
		110"	29 5/8"	1 1/4"	MU1-S11030-B-Q-(-)	1,159.	1,736.	2,594.
		116"	29 5/8"	1 1/4"	MU1-S11630-B-Q-(-)	1,241.	1,854.	2,767.

Order Code

Example:	MU1-S3830B-Q-117
MU1	Worksurface, 1 1/4" thick
S	Straight worksurface
38	Width
30	Depth
B	No grommets
Q	Standard Specials
117	Surface finish

Specification Information

Grommets/no grommets:

A- worksurface includes 3" grommet in each back corner leading into desk support or wire manager clips.

B- worksurface does not include grommets

Specify surface finish.

1 1/4" worksurfaces are 3-ply, solid core construction with threaded metal inserts at all end panel, desk support and bracket locations and pilot holes at pedestal locations.

All worksurfaces are U.L.-listed.

Plastic laminate worksurfaces are post-formed top and bottom, front and back.

Application Notes

30"D worksurfaces are used interchangeably in desk and panel system applications as main surfaces, extensions or credenza tops. They can be supported at each end by 30" end support bracket, 30" cantilever bracket, 30" flat bracket, 30"W end panel, 24"D pedestal or end panel in conjunction with desk support, or 30"D pedestal.

All straight worksurfaces are 3/8" less than nominal depth for rear wire clearance or privacy screens.

Panel-supported 1 1/4" worksurfaces over 48" must be mid-span supported by MB2-C18 bracket, specified separately.

Worksurfaces with grommets are bored to accept and are shipped with wire manager clips.

Suspended pedestals may not be used with 1 1/4" worksurfaces.

Morrison Worksurfaces, 1 1/4"

36" D + Post

Standard Specials Systems

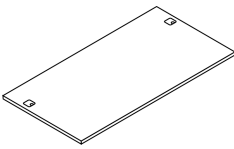
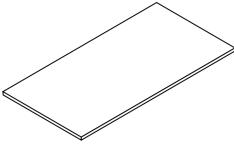
description	type	w	d	h	pattern no.	lam.	V1	V2
Straight, 36"D + Post		38"	35 5/8"	1 1/4"	MU1-S3836-R-Q-()	\$607.	\$847.	\$1,258.
		44"	35 5/8"	1 1/4"	MU1-S4436-R-Q-()	641.	900.	1,335.
		50"	35 5/8"	1 1/4"	MU1-S5036-R-Q-()	677.	974.	1,428.
		56"	35 5/8"	1 1/4"	MU1-S5636-R-Q-()	714.	1,034.	1,520.
		62"	35 5/8"	1 1/4"	MU1-S6236-R-Q-()	750.	1,088.	1,633.
		68"	35 5/8"	1 1/4"	MU1-S6836-R-Q-()	824.	1,181.	1,745.
		74"	35 5/8"	1 1/4"	MU1-S7436-R-Q-()	884.	1,272.	1,905.
		80"	35 5/8"	1 1/4"	MU1-S8036-R-Q-()	946.	1,363.	2,043.
		86"	35 5/8"	1 1/4"	MU1-S8636-R-Q-()	996.	1,442.	2,163.
		92"	35 5/8"	1 1/4"	MU1-S9236-R-Q-()	1,075.	1,560.	2,336.
		98"	35 5/8"	1 1/4"	MU1-S9836-R-Q-()	1,158.	1,678.	2,510.
		104"	35 5/8"	1 1/4"	MU1-S10436-R-Q-()	1,240.	1,796.	2,683.
		110"	35 5/8"	1 1/4"	MU1-S11036-R-Q-()	1,323.	1,914.	2,857.
		116"	35 5/8"	1 1/4"	MU1-S11636-R-Q-()	1,405.	2,032.	3,030.
No Grommets		38"	35 5/8"	1 1/4"	MU1-S3836-B-Q-()	526.	767.	1,180.
		44"	35 5/8"	1 1/4"	MU1-S4436-B-Q-()	562.	824.	1,256.
		50"	35 5/8"	1 1/4"	MU1-S5036-B-Q-()	597.	896.	1,350.
		56"	35 5/8"	1 1/4"	MU1-S5636-B-Q-()	635.	956.	1,443.
		62"	35 5/8"	1 1/4"	MU1-S6236-B-Q-()	671.	1,005.	1,554.
		68"	35 5/8"	1 1/4"	MU1-S6836-B-Q-()	743.	1,102.	1,666.
		74"	35 5/8"	1 1/4"	MU1-S7436-B-Q-()	801.	1,192.	1,823.
		80"	35 5/8"	1 1/4"	MU1-S8036-B-Q-()	864.	1,283.	1,959.
		86"	35 5/8"	1 1/4"	MU1-S8636-B-Q-()	918.	1,365.	2,084.
		92"	35 5/8"	1 1/4"	MU1-S9236-B-Q-()	994.	1,480.	2,257.
		98"	35 5/8"	1 1/4"	MU1-S9836-B-Q-()	1,076.	1,598.	2,431.
		104"	35 5/8"	1 1/4"	MU1-S10436-B-Q-()	1,159.	1,716.	2,604.
		110"	35 5/8"	1 1/4"	MU1-S11036-B-Q-()	1,241.	1,834.	2,778.
		116"	35 5/8"	1 1/4"	MU1-S11636-B-Q-()	1,324.	1,952.	2,951.

Morrison System

Order Code

Example:	MU1-S3836B-Q-117
MU1	Worksurface, 1 1/4" thick
S	Straight worksurface
38	Width
36	Depth
B	No grommets
Q	Standard Specials
117	Surface finish

Specification Information

Grommets/no grommets:

A- worksurface includes 3" grommet in each back corner leading into desk support or wire manager clips.

B- worksurface does not include grommets

Specify surface finish.

1 1/4" worksurfaces are 3-ply, solid core construction with threaded metal inserts at all end panel, desk support and bracket locations and pilot holes at pedestal locations.

All worksurfaces are U.L.-listed.

Plastic laminate worksurfaces are post-formed top and bottom, front and back.

Application Notes

30"D worksurfaces are used interchangeably in desk and panel system applications as main surfaces, extensions or credenza tops. They can be supported at each end by 30" end support bracket, 30" cantilever bracket, 30" flat bracket, 30"W end panel, 24"D pedestal or end panel in conjunction with desk support, or 30"D pedestal.

All straight worksurfaces are 3/8" less than nominal depth for rear wire clearance or privacy screens.

Panel-supported 1 1/4" worksurfaces over 48" must be mid-span supported by MB2-C18 bracket, specified separately.

Worksurfaces with grommets are bored to accept and are shipped with wire manager clips.

Suspended pedestals may not be used with 1 1/4" worksurfaces.

Morrison Worksurfaces, 1 1/4"

rounded end worksurfaces 30" D + 36" D

Standard Specials Systems

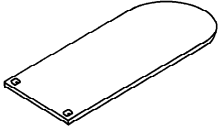
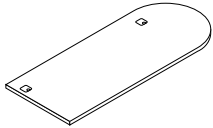
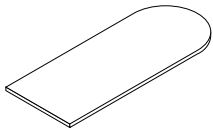
description	type	w	d	h	pattern no.	lam.	V1	V2
Rounded end	End Grommets 	66"	36"	1 1/4"	MU1-R6636-E-Q-()	\$1,317.	\$1,801.	\$2,584.
		78"	36"	1 1/4"	MU1-R7836-E-Q-()	1,376.	1,860.	2,643.
		87"	30"	1 1/4"	MU1-R8730-E-Q-()	1,352.	1,836.	2,620.
		90"	36"	1 1/4"	MU1-R9036-E-Q-()	1,494.	1,978.	2,761.
Recessed Grommets		66"	36"	1 1/4"	MU1-R6636-R-Q-() (L/R)	1,317.	1,801.	2,584.
		78"	36"	1 1/4"	MU1-R7836-R-Q-() (L/R)	1,376.	1,860.	2,643.
		87"	30"	1 1/4"	MU1-R8730-R-Q-() (L/R)	1,352.	1,836.	2,620.
		90"	36"	1 1/4"	MU1-R9036-R-Q-() (L/R)	1,494.	1,978.	2,761.
No Grommets		66"	36"	1 1/4"	MU1-R6636-B-Q-() (L/R)	1,235.	1,717.	2,503.
		78"	36"	1 1/4"	MU1-R7836-B-Q-() (L/R)	1,294.	1,776.	2,562.
		87"	30"	1 1/4"	MU1-R8730-B-Q-() (L/R)	1,271.	1,752.	2,538.
		90"	36"	1 1/4"	MU1-R9036-B-Q-() (L/R)	1,412.	1,894.	2,680.

Order Code

Example:	MU1-R6636E-Q-117
MU1	Worksurface, 1 1/4" thick
R	Rounded end
66	Width
36	Depth
E	End grommets
Q	Standard Specials
117	Surface finish

Specification Information

<i>Grommets/no grommets:</i>	
E-	rounded end worksurface includes 3" grommet in each straight end corner.
R-	rounded end worksurface includes 3" grommets recessed for use with 6" recessed desk support.
B-	rounded end worksurface does not include grommets

Specify surface finish.
Rounded end worksurfaces with recessed or no grommets are specified left or right to determine position of grommets and pedestal drilling. Rounded end when seated at desk defines L/R hand (Right hand shown above).

1 1/4" worksurfaces are 3-ply, solid core construction with threaded metal inserts at all end panel, desk support and bracket locations and pilot holes at pedestal locations.

MU1- worksurfaces are supported by brackets with machine screws.

All worksurfaces are U.L.-listed.

End grommets have inserts to accept desk support at straight end and no pedestal inserts. Plastic laminate worksurfaces have radiused T mold edge and a flat self-edge in the straight edge.

Application Notes

Rounded end worksurfaces are used interchangeably in desk and panel system applications as main surfaces or extensions. They may be supported by 30" end support brackets, 30" cantilever bracket, 30" flat bracket or 30" conference end panel, and by a support column at the rounded end.

Use 18"D pedestal or end panel with desk support under rounded end worksurfaces with recessed grommets. Use 48"D desk support with 63" rounded end and 60"W desk support with 75" rounded end.

Worksurfaces with end grommets may not be supported by conference end panel.

Suspended pedestals may not be used with 1 1/4" worksurfaces.

Rounded end worksurfaces have threaded metal inserts for desk support, end panel each end, and at all bracket locations. End grommet worksurfaces have no pedestal inserts.

Morrison Worksurfaces, 1 1/4"
P-shape curvilinear

Standard Specials Systems

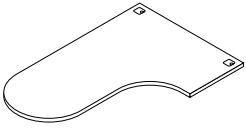
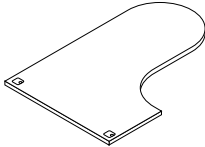
description	type	w	d	h	pattern no.	lam.	V1	V2
	24" D return	48"	66"	1 1/4"	MU1-P66SA-L-Q-()	\$2,079.	\$2,669.	\$3,741.
	24" D return	48"	78"	1 1/4"	MU1-P78SA-L-Q-()	2,138.	2,746.	3,848.
	30" D return	48"	66"	1 1/4"	MU1-P66DA-L-Q-()	2,106.	2,709.	3,793.
	30" D return	48"	72"	1 1/4"	MU1-P72DA-L-Q-()	2,165.	2,786.	3,900.
	24" D return	48"	66"	1 1/4"	MU1-P66SA-R-Q-()	2,079.	2,669.	3,741.
	24" D return	48"	78"	1 1/4"	MU1-P78SA-R-Q-()	2,138.	2,746.	3,848.
	30" D return	48"	66"	1 1/4"	MU1-P66DA-R-Q-()	2,106.	2,709.	3,793.
	30" D return	48"	72"	1 1/4"	MU1-P72DA-R-Q-()	2,165.	2,786.	3,900.

Morrison System

Order Code	Specification Information	Application Notes
Example: MU1-P66SA-L-Q-117	S- 24"D side edge	P-shape curvilinear worksurfaces may be used interchangeably in desk and panel system applications. They may be supported by a 48" VDT support bracket kit, or 48" desk support and 6" end panel, in conjunction with rounded end support column. Use flat bracket or bridging bracket to join to adjacent 1 1/4" worksurface. P-shape laminate surfaces have continuous T-mold edge in profile to match adjacent 1 1/4" worksurfaces.
MU1 Worksurface, 1 1/4"	D- 30"D side edge	
P P-shape curvilinear	Specify surface finish.	
66 Overall length	1 1/4" curvilinear surfaces are solid core construction with threaded metal inserts at desk support and all bracket locations.	
S Depth of return	All worksurfaces are U.L.-listed.	
A Grommets	All P-shape worksurfaces have 2 grommets at 48" end for use with 48" desk and overhead supports.	
L Rounded end left		
Q Standard Special		
117 Surface finish		

Morrison Worksurfaces, 1 1/4"
L-shape curvilinear

Standard Specials Systems

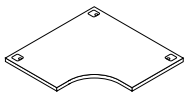
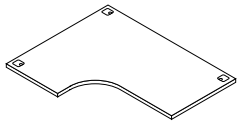
description	type	w	d	h	pattern no.	lam.	V1	V2
24"D returns left and right 	3 Grommets	42"	48"	1 1/4"	MU1-C4248SS-Q(-)	\$1,037.	\$1,336.	\$1,866.
		42"	60"	1 1/4"	MU1-C4260SS-Q(-)	1,179.	1,515.	2,122.
		42"	66"	1 1/4"	MU1-C4266SS-Q(-)	1,266.	1,628.	2,283.
		42"	72"	1 1/4"	MU1-C4272SS-Q(-)	1,352.	1,742.	2,444.
		48"	42"	1 1/4"	MU1-C4842SS-Q(-)	1,037.	1,336.	1,866.
		48"	66"	1 1/4"	MU1-C4866SS-Q(-)	1,352.	1,742.	2,444.
		60"	42"	1 1/4"	MU1-C6042SS-Q(-)	1,179.	1,515.	2,122.
		66"	42"	1 1/4"	MU1-C6642SS-Q(-)	1,266.	1,628.	2,283.
		66"	48"	1 1/4"	MU1-C6648SS-Q(-)	1,352.	1,742.	2,444.
		72"	42"	1 1/4"	MU1-C7242SS-Q(-)	1,352.	1,742.	2,444.
24"D return left, 30"D right 	3 Grommets	42"	42"	1 1/4"	MU1-C4242SD-Q(-)	966.	1,246.	1,738.
		42"	48"	1 1/4"	MU1-C4248SD-Q(-)	1,037.	1,336.	1,866.
		42"	60"	1 1/4"	MU1-C4260SD-Q(-)	1,179.	1,515.	2,122.
		42"	66"	1 1/4"	MU1-C4266SD-Q(-)	1,266.	1,628.	2,283.
		42"	72"	1 1/4"	MU1-C4272SD-Q(-)	1,352.	1,742.	2,444.
		48"	42"	1 1/4"	MU1-C4842SD-Q(-)	1,037.	1,336.	1,866.
		48"	66"	1 1/4"	MU1-C4866SD-Q(-)	1,352.	1,742.	2,444.
		60"	42"	1 1/4"	MU1-C6042SD-Q(-)	1,179.	1,515.	2,122.
		66"	42"	1 1/4"	MU1-C6642SD-Q(-)	1,266.	1,628.	2,283.
		66"	48"	1 1/4"	MU1-C6648SD-Q(-)	1,352.	1,742.	2,444.
72"	42"	1 1/4"	MU1-C7242SD-Q(-)	1,352.	1,742.	2,444.		

Order Code	Specification Information	Application Notes
Example: MU1-C4248SD-Q-117 MU1 Worksurface, 1 1/4" C L-shape curvilinear 42 Width left 48 Width right S Depth of left return D Depth of right return Q Standard Specials 117 Surface finish	Width dimension (W) refers to width of left-side back edge; depth dimension (D) indicates width of right-side back edge. S- 24"D side edge D- 30"D side edge Specify surface finish. 1 1/4" curvilinear surfaces are solid core construction with threaded metal inserts at desk support and all bracket locations. All worksurfaces are U.L.-listed. All L-shape curvilinear worksurfaces have three grommets.	L-shape curvilinear worksurfaces may be used interchangeably in desk and panel system applications. They may be supported by corner desk supports or by VDT end support bracket kit. Use cantilever bridging brackets or flat brackets to join to adjacent worksurfaces. L-shape surfaces may also be supported by MN1- end panel in conjunction with desk support, or cantilever bracket in panel planning. L-shape surfaces are veneer or post-formed plastic laminate on both back edges, matching profile T-mold on curvilinear front, and self-edge on sides. Curvilinear worksurfaces are available only in 1 1/4" thickness. L-shape surfaces are 3/8" less than nominal depth for rear wire clearance or privacy screens. If specifying privacy screens on both back edges, one or both must be 48" back-of-VDT type.

Morrison Worksurfaces, 1 1/4"

L-shape curvilinear

Standard Specials Systems

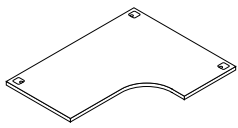
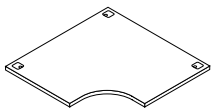
description	type	w	d	h	pattern no.	lam.	V1	V2
30"D return left, 24"D right 	3 Grommets	42"	42"	1 1/4"	MU1-C4242DS-Q-()	\$966.	\$1,246.	\$1,738.
		42"	48"	1 1/4"	MU1-C4248DS-Q-()	1,037.	1,336.	1,866.
		42"	60"	1 1/4"	MU1-C4260DS-Q-()	1,179.	1,515.	2,122.
		42"	66"	1 1/4"	MU1-C4266DS-Q-()	1,266.	1,628.	2,283.
		42"	72"	1 1/4"	MU1-C4272DS-Q-()	1,352.	1,742.	2,444.
		48"	42"	1 1/4"	MU1-C4842DS-Q-()	1,037.	1,336.	1,866.
		48"	66"	1 1/4"	MU1-C4866DS-Q-()	1,352.	1,742.	2,444.
		60"	42"	1 1/4"	MU1-C6042DS-Q-()	1,179.	1,515.	2,122.
		66"	42"	1 1/4"	MU1-C6642DS-Q-()	1,266.	1,628.	2,283.
		66"	48"	1 1/4"	MU1-C6648DS-Q-()	1,352.	1,742.	2,444.
72"	42"	1 1/4"	MU1-C7242DS-Q-()	1,352.	1,742.	2,444.		
30"D return left and right 	3 Grommets	42"	42"	1 1/4"	MU1-C4242DD-Q-()	966.	1,246.	1,738.
		42"	48"	1 1/4"	MU1-C4248DD-Q-()	1,037.	1,336.	1,866.
		42"	60"	1 1/4"	MU1-C4260DD-Q-()	1,179.	1,515.	2,122.
		42"	66"	1 1/4"	MU1-C4266DD-Q-()	1,266.	1,628.	2,283.
		42"	72"	1 1/4"	MU1-C4272DD-Q-()	1,352.	1,742.	2,444.
		48"	42"	1 1/4"	MU1-C4842DD-Q-()	1,037.	1,336.	1,866.
		48"	60"	1 1/4"	MU1-C4860DD-Q-()	1,250.	1,606.	2,249.
		48"	66"	1 1/4"	MU1-C4866DD-Q-()	1,352.	1,742.	2,444.
		48"	72"	1 1/4"	MU1-C4872DD-Q-()	1,423.	1,833.	2,571.
		60"	42"	1 1/4"	MU1-C6042DD-Q-()	1,179.	1,515.	2,122.
		60"	48"	1 1/4"	MU1-C6048DD-Q-()	1,250.	1,606.	2,249.
		66"	42"	1 1/4"	MU1-C6642DD-Q-()	1,266.	1,628.	2,283.
		66"	48"	1 1/4"	MU1-C6648DD-Q-()	1,352.	1,742.	2,444.
		72"	42"	1 1/4"	MU1-C7242DD-Q-()	1,352.	1,742.	2,444.
72"	48"	1 1/4"	MU1-C7248DD-Q-()	1,423.	1,833.	2,571.		

Morrison System

Order Code	Specification Information	Application Notes
Example: MU1-C4248SD-Q-117 MU1 Worksurface, 1 1/4" C L-shape curvilinear 42 Width left 48 Width right S Depth of left return D Depth of right return Q Standard Specials 117 Surface finish	Width dimension (W) refers to width of left-side back edge; depth dimension (D) indicates width of right-side back edge. S- 24"D side edge D- 30"D side edge Specify surface finish. 1 1/4" curvilinear surfaces are solid core construction with threaded metal inserts at desk support and all bracket locations. All worksurfaces are U.L.-listed. All L-shape curvilinear worksurfaces have three grommets.	L-shape curvilinear worksurfaces may be used interchangeably in desk and panel system applications. They may be supported by corner desk supports or by VDT end support bracket kit. Use cantilever bridging brackets or flat brackets to join to adjacent worksurfaces. L-shape surfaces may also be supported by MN1- end panel in conjunction with desk support, or cantilever bracket in panel planning. L-shape surfaces are veneer or post-formed plastic laminate on both back edges, matching profile T-mold on curvilinear front, and self-edge on sides. Curvilinear worksurfaces are available only in 1 1/4" thickness. L-shape surfaces are 3/8" less than nominal depth for rear wire clearance or privacy screens. If specifying privacy screens on both back edges, one or both must be 48" back-of-VDT type.

Morrison Worksurfaces, 1 1/4"

J-shape surfaces

Standard Specials Systems

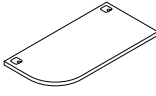
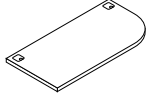
description	w	d	h	pattern no.	lam.	V1	V2
J-shape - Rounded left 	24"	23 5/8"	1 1/4"	MU1-J24A-L-Q(-)	\$742.	\$905.	\$1,222.
	30"	23 5/8"	1 1/4"	MU1-J30A-L-Q(-)	n/a	975.	1,316.
	36"	23 5/8"	1 1/4"	MU1-J36A-L-Q(-)	n/a	1,035.	1,397.
	42"	23 5/8"	1 1/4"	MU1-J42A-L-Q(-)	n/a	1,099.	1,483.
	48"	23 5/8"	1 1/4"	MU1-J48A-L-Q(-)	n/a	1,171.	1,581.
	54"	23 5/8"	1 1/4"	MU1-J54A-L-Q(-)	959.	1,243.	1,679.
	60"	23 5/8"	1 1/4"	MU1-J60A-L-Q(-)	1,018.	1,315.	1,777.
	66"	23 5/8"	1 1/4"	MU1-J66A-L-Q(-)	1,077.	1,387.	1,875.
	72"	23 5/8"	1 1/4"	MU1-J72A-L-Q(-)	1,136.	1,458.	1,973.
	78"	23 5/8"	1 1/4"	MU1-J78A-L-Q(-)	1,195.	1,530.	2,071.
	84"	23 5/8"	1 1/4"	MU1-J84A-L-Q(-)	1,254.	1,602.	2,169.
	90"	23 5/8"	1 1/4"	MU1-J90A-L-Q(-)	1,313.	1,674.	2,267.
96"	23 5/8"	1 1/4"	MU1-J96A-L-Q(-)	1,372.	1,746.	2,365.	
J-shape - Rounded right 	24"	23 5/8"	1 1/4"	MU1-J24A-R-Q(-)	742.	905.	1,222.
	30"	23 5/8"	1 1/4"	MU1-J30A-R-Q(-)	n/a	975.	1,316.
	36"	23 5/8"	1 1/4"	MU1-J36A-R-Q(-)	n/a	1,035.	1,397.
	42"	23 5/8"	1 1/4"	MU1-J42A-R-Q(-)	n/a	1,099.	1,483.
	48"	23 5/8"	1 1/4"	MU1-J48A-R-Q(-)	n/a	1,171.	1,581.
	54"	23 5/8"	1 1/4"	MU1-J54A-R-Q(-)	959.	1,243.	1,679.
	60"	23 5/8"	1 1/4"	MU1-J60A-R-Q(-)	1,018.	1,315.	1,777.
	66"	23 5/8"	1 1/4"	MU1-J66A-R-Q(-)	1,077.	1,387.	1,875.
	72"	23 5/8"	1 1/4"	MU1-J72A-R-Q(-)	1,136.	1,458.	1,973.
	78"	23 5/8"	1 1/4"	MU1-J78A-R-Q(-)	1,195.	1,530.	2,071.
	84"	23 5/8"	1 1/4"	MU1-J84A-R-Q(-)	1,254.	1,602.	2,169.
	90"	23 5/8"	1 1/4"	MU1-J90A-R-Q(-)	1,313.	1,674.	2,267.
96"	23 5/8"	1 1/4"	MU1-J96A-R-Q(-)	1,372.	1,746.	2,365.	

Order Code	Specification Information	Application Notes
Example: MU1-J30A-L-Q-117 MU1 Worksurface, 1 1/4" J J-shape 30 Width A With grommets L Left Q Standard Specials 117 Surface finish	1 1/4" curvilinear surfaces are solid core construction with threaded metal inserts at desk support and all bracket locations and pilot holes at pedestal locations. Specify surface finish. All worksurfaces are U.L.-listed. J-shape worksurfaces have 2 grommets for use with freestanding desk and overhead supports.	J-shape curvilinear worksurfaces may be used interchangeably in desk and panel system applications. They may be supported by straight desk support or cantilever brackets. J-shapes also require 9" Network end panel in desk or panel planning. Use flat bracket or bridging bracket to join to adjacent 1 1/4" worksurface. Also specify VDT end support bracket kit for optimal stability of vertical panel behind J-shape worksurface. J-shape surfaces are post-formed on back edge, matching profile T-mold on curvilinear front, and self-edge on sides. J-shapes are available only in plastic laminate, 1 1/4" thickness. J-shape surfaces are 3/8" less than nominal depth for wire clearance or privacy screens.

Morrison Worksurfaces, 1 1/4"

Wave-end surfaces

Standard Specials Systems

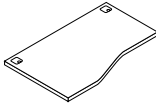
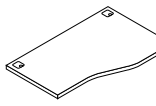
description	w	d	h	pattern no.	lam.
Left wave-end 	30"	29 5/8"	1 1/4"	MU1-W30A-L-Q-()	\$900.
	54"	29 5/8"	1 1/4"	MU1-W54A-L-Q-()	1,066.
	60"	29 5/8"	1 1/4"	MU1-W60A-L-Q-()	1,125.
	66"	29 5/8"	1 1/4"	MU1-W66A-L-Q-()	1,184.
	72"	29 5/8"	1 1/4"	MU1-W72A-L-Q-()	1,243.
	78"	29 5/8"	1 1/4"	MU1-W78A-L-Q-()	1,302.
	84"	29 5/8"	1 1/4"	MU1-W84A-L-Q-()	1,361.
	90"	29 5/8"	1 1/4"	MU1-W90A-L-Q-()	1,420.
	96"	29 5/8"	1 1/4"	MU1-W96A-L-Q-()	1,479.
Right wave-end 	30"	29 5/8"	1 1/4"	MU1-W30A-R-Q-()	900.
	54"	29 5/8"	1 1/4"	MU1-W54A-R-Q-()	1,066.
	60"	29 5/8"	1 1/4"	MU1-W60A-R-Q-()	1,125.
	66"	29 5/8"	1 1/4"	MU1-W66A-R-Q-()	1,184.
	72"	29 5/8"	1 1/4"	MU1-W72A-R-Q-()	1,243.
	78"	29 5/8"	1 1/4"	MU1-W78A-R-Q-()	1,302.
	84"	29 5/8"	1 1/4"	MU1-W84A-R-Q-()	1,361.
	90"	29 5/8"	1 1/4"	MU1-W90A-R-Q-()	1,420.
	96"	29 5/8"	1 1/4"	MU1-W96A-R-Q-()	1,479.

Morrison System

Order Code

Example:	MU1-W48A-L-Q-117
MU1	Worksurface, 1 1/4"
W	Wave-end curvilinear
48	Width
A	With grommets
L	Left
Q	Standard Special
117	Surface finish

Specification Information

1 1/4" curvilinear surfaces are solid core construction with threaded metal inserts at desk support, and all bracket locations and pilot holes at pedestal locations.

Specify surface finish.

All worksurfaces are U.L.-listed.

Wave-end worksurfaces have 2 grommets for use with freestanding desk and overhead supports.

Application Notes

Wave-end curvilinear worksurfaces may be used interchangeably in desk and panel system applications. They may be supported by straight desk support or cantilever brackets.

Use flat bracket or bridging bracket to join to adjacent 1 1/4" worksurface.

Wave-end surfaces are post-formed on back edge, matching profile T-mold on curvilinear front, and self-edge on sides.



Wave-end surfaces are available only in plastic laminate, 1 1/4" thickness.

Wave-end surfaces are nominal 30"D at left or right, and align with 24"D surface at the other end. Inserts for 24"D pedestal are standard at the wave end.

Wave-end surfaces are 3/8" less than nominal depth for wire clearance or privacy screens.

Morrison Options Worksurfaces, 1 1/4" 18" D

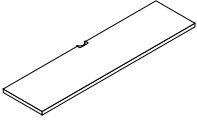
Standard Specials Systems

description	type	w	d	h	pattern no.	lam.	V1	V2
Straight, 18"D	Grommets 	18"	17 3/8"	1 1/4"	LU1-S1818-A-Q-()	\$231.	\$388.	\$572.
		24"	17 3/8"	1 1/4"	LU1-S2418-A-Q-()	231.	388.	572.
		102"	17 3/8"	1 1/4"	LU1-S10218-A-Q-()	610.	968.	1,484.
		114"	17 3/8"	1 1/4"	LU1-S11418-A-Q-()	640.	1,020.	1,567.
	No Grommets 	18"	17 3/8"	1 1/4"	LU1-S1818-B-Q-()	195.	359.	542.
		24"	17 3/8"	1 1/4"	LU1-S2418-B-Q-()	195.	359.	542.
		102"	17 3/8"	1 1/4"	LU1-S10218-B-Q-()	581.	938.	1,453.
		114"	17 3/8"	1 1/4"	LU1-S11418-B-Q-()	610.	992.	1,538.

Order Code	Specification Information	Application Notes
Example: LU1-S2418-B-Q-117		
LU1 Worksurface, 1 1/4" thick	A- worksurface includes one edge grommet	18"D worksurfaces are used in panel system applications as shallow main surfaces, extensions or credenza tops. They may be supported at each end by an 18" end support bracket, 18" cantilever bracket, 18"W desk end panel or 18"D pedestal.
S Straight worksurface	B- worksurface does not include grommet	
24 Width		Options worksurfaces cannot be used in conjunction with Network desk supports.
18 Depth	Specify surface finish.	
B No grommet	1 1/4" Options worksurfaces are 3-ply, solid core construction with pilot holes at all pedestal, end panel, and bracket locations.	All straight worksurfaces are 3/8" less than nominal depth for rear wire clearance.
Q Standard Specials	Edge grommets are centered at rear of worksurface.	
117 Surface finish		Panel-supported 1 1/4" worksurfaces over 48" must be mid-span supported by MB2-C18 bracket, specified separately.
		Panel-supported 1 1/4" worksurfaces over 96" must be pedestal or MB2-C24 cantilever bracket supported every 48".
		Suspended pedestals may not be used with 1 1/4" worksurfaces.

Morrison Options Worksurfaces, 1 1/4" 24" D

Standard Specials Systems

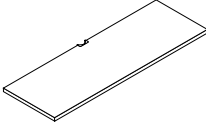
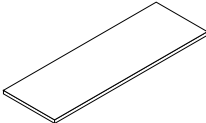
description	type	w	d	h	pattern no.	lam.	V1	V2
Straight, 24"D	Grommets 	18"	23 5/8"	1 1/4"	LU1-S1824-A-Q-()	\$273.	\$489.	\$706.
		102"	23 5/8"	1 1/4"	LU1-S10224-A-Q-()	668.	1,063.	1,628.
		114"	23 5/8"	1 1/4"	LU1-S11424-A-Q-()	712.	1,129.	1,720.
	No Grommets 	24"	23 5/8"	1 1/4"	LU1-S1824-B-Q-()	244.	457.	680.
		102"	23 5/8"	1 1/4"	LU1-S10224-B-Q-()	640.	1,033.	1,599.
		114"	23 5/8"	1 1/4"	LU1-S11424-B-Q-()	680.	1,099.	1,691.

Morrison System

Order Code	Specification Information	Application Notes
Example: LU1-S1824-B-Q-117		
LU1 Worksurface, 1 1/4" thick	A- worksurface includes one edge grommet	Options worksurfaces cannot be used in conjunction with Network desk supports.
S Straight worksurface	B- worksurface does not include grommet	
18 Width		All straight worksurfaces are 5/8" less than nominal depth for rear wire clearance.
24 Depth	Specify surface finish.	
B No grommet	1 1/4" Options worksurfaces are 3-ply, solid core construction with pilot holes at all pedestal, end panel, and bracket locations.	Panel-supported 1 1/4" worksurfaces over 48" must be mid-span supported by MB2-C18 bracket, specified separately.
Q Standard Specials	Edge grommets are centered at rear of worksurface.	
117 Surface finish		Panel-supported 1 1/4" worksurfaces over 96" must be pedestal or MB2-C24 cantilever bracket supported every 48".
		Suspended pedestals may not be used with 1 1/4" worksurfaces.

Morrison Options Worksurfaces, 1 1/4" 30" D

Standard Specials Systems

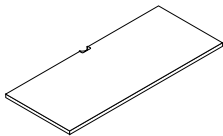
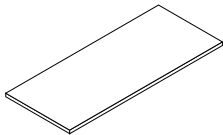
description	type	w	d	h	pattern no.	lam.	V1	V2
Straight, 30"D	Grommets 	18"	29 3/8"	1 1/4"	LU1-S1830-A-Q-()	\$290.	\$476.	\$742.
		24"	29 3/8"	1 1/4"	LU1-S2430-A-Q-()	290.	476.	742.
		102"	29 3/8"	1 1/4"	LU1-S10230-A-Q-()	727.	1,122.	1,698.
		108"	29 3/8"	1 1/4"	LU1-S10830-A-Q-()	786.	1,181.	1,781.
		114"	29 3/8"	1 1/4"	LU1-S11430-A-Q-()	845.	1,240.	1,863.
		120"	29 3/8"	1 1/4"	LU1-S12030-A-Q-()	904.	1,299.	1,946.
No Grommets 	No Grommets	18"	29 3/8"	1 1/4"	LU1-S1830-B-Q-()	261.	454.	712.
		24"	29 3/8"	1 1/4"	LU1-S2430-B-Q-()	261.	454.	712.
		102"	29 3/8"	1 1/4"	LU1-S10230-B-Q-()	699.	1,092.	1,669.
		108"	29 3/8"	1 1/4"	LU1-S10830-B-Q-()	758.	1,151.	1,751.
		114"	29 3/8"	1 1/4"	LU1-S11430-B-Q-()	817.	1,210.	1,834.
		120"	29 3/8"	1 1/4"	LU1-S12030-B-Q-()	876.	1,269.	1,916.

Order Code	Specification Information	Application Notes
Example: LU1-S1830B-Q-117	<i>Grommets/no grommets:</i>	30"D worksurfaces are used in panel system applications as main surfaces, extensions or credenza tops. They can be supported at each end by 30" end support bracket, 30" cantilever bracket or 30"W end panel.
LU1 Worksurface, 1 1/4" thick	A- worksurface includes one edge grommet	Options worksurfaces cannot be used in conjunction with Network desk supports.
S Straight worksurface	B- worksurface does not include grommets	All straight worksurfaces are 3/8" less than nominal depth for rear wire clearance.
18 Width	Specify surface finish.	Panel-supported 1 1/4" worksurfaces over 48" must be mid-span supported by MB2-C24 bracket, specified separately.
30 Depth	1 1/4" Options worksurfaces are 3-ply, solid core construction with pilot holes at all pedestal, end panel, and bracket locations.	Suspended pedestals may not be used with 1 1/4" worksurfaces.
B No grommets	Edge grommets are centered at rear of worksurface.	
Q Standard Specials		
117 Surface finish		

Morrison Options Worksurfaces, 1 1/4" 36" D

Standard Specials Systems

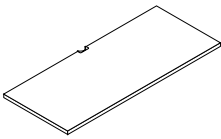
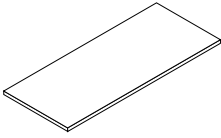
description	type	w	d	h	pattern no.	lam.	V1	V2
Straight, 36"D		36"	35 3/8"	1 1/4"	LU1-S3636-A-Q-()	\$432.	\$649.	\$992.
		42"	35 3/8"	1 1/4"	LU1-S4236-A-Q-()	464.	700.	1,058.
		48"	35 3/8"	1 1/4"	LU1-S4836-A-Q-()	492.	746.	1,127.
		54"	35 3/8"	1 1/4"	LU1-S5436-A-Q-()	524.	811.	1,212.
		60"	35 3/8"	1 1/4"	LU1-S6036-A-Q-()	553.	863.	1,296.
		66"	35 3/8"	1 1/4"	LU1-S6636-A-Q-()	584.	906.	1,401.
		72"	35 3/8"	1 1/4"	LU1-S7236-A-Q-()	631.	972.	1,481.
		78"	35 3/8"	1 1/4"	LU1-S7836-A-Q-()	662.	1,012.	1,548.
		84"	35 3/8"	1 1/4"	LU1-S8436-A-Q-()	693.	1,062.	1,625.
		90"	35 3/8"	1 1/4"	LU1-S9036-A-Q-()	722.	1,113.	1,687.
		96"	35 3/8"	1 1/4"	LU1-S9636-A-Q-()	750.	1,163.	1,769.
		102"	35 3/8"	1 1/4"	LU1-S10236-A-Q-()	809.	1,222.	1,851.
		108"	35 3/8"	1 1/4"	LU1-S10836-A-Q-()	868.	1,281.	1,934.
		114"	35 3/8"	1 1/4"	LU1-S11436-A-Q-()	927.	1,340.	2,017.
120"	35 3/8"	1 1/4"	LU1-S12036-A-Q-()	986.	1,399.	2,099.		
No Grommets		36"	35 3/8"	1 1/4"	LU1-S3636-B-Q-()	402.	621.	964.
		42"	35 3/8"	1 1/4"	LU1-S4236-B-Q-()	433.	669.	1,029.
		48"	35 3/8"	1 1/4"	LU1-S4836-B-Q-()	464.	716.	1,097.
		54"	35 3/8"	1 1/4"	LU1-S5436-B-Q-()	492.	785.	1,184.
		60"	35 3/8"	1 1/4"	LU1-S6036-B-Q-()	525.	833.	1,269.
		66"	35 3/8"	1 1/4"	LU1-S6636-B-Q-()	553.	879.	1,370.
		72"	35 3/8"	1 1/4"	LU1-S7236-B-Q-()	599.	942.	1,451.
		78"	35 3/8"	1 1/4"	LU1-S7836-B-Q-()	631.	985.	1,521.
		84"	35 3/8"	1 1/4"	LU1-S8436-B-Q-()	663.	1,034.	1,595.
		90"	35 3/8"	1 1/4"	LU1-S9036-B-Q-()	693.	1,083.	1,661.
		96"	35 3/8"	1 1/4"	LU1-S9636-B-Q-()	722.	1,133.	1,739.
		102"	35 3/8"	1 1/4"	LU1-S10236-B-Q-()	781.	1,192.	1,822.
		108"	35 3/8"	1 1/4"	LU1-S10836-B-Q-()	840.	1,251.	1,905.
		114"	35 3/8"	1 1/4"	LU1-S11436-B-Q-()	899.	1,310.	1,987.
120"	35 3/8"	1 1/4"	LU1-S12036-B-Q-()	958.	1,369.	2,070.		

Morrison System

Order Code	Specification Information	Application Notes
Example: LU1-S3636B-Q-117	<i>Grommets/no grommets:</i>	30"D worksurfaces are used in panel system applications as main surfaces, extensions or credenza tops. They can be supported at each end by 30" end support bracket, 30" cantilever bracket or 30"W end panel.
LU1 Worksurface, 1 1/4" thick	A- worksurface includes one edge grommet	
S Straight worksurface	B- worksurface does not include grommets	Options worksurfaces cannot be used in conjunction with Network desk supports.
36 Width	Specify surface finish.	
36 Depth	1 1/4" Options worksurfaces are 3-ply, solid core construction with pilot holes at all pedestal, end panel, and bracket locations.	All straight worksurfaces are 3/8" less than nominal depth for rear wire clearance.
B No grommets	Edge grommets are centered at rear of worksurface.	
Q Standard Specials		Panel-supported 1 1/4" worksurfaces over 48" must be mid-span supported by MB2-C24 bracket, specified separately.
117 Surface finish		
		Suspended pedestals may not be used with 1 1/4" worksurfaces.

Morrison Options Worksurfaces, 1 1/4" 18" D + Post

Standard Specials Systems

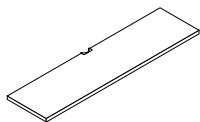
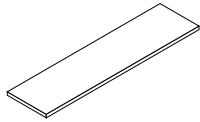
description	type	w	d	h	pattern no.	lam.	V1	V2
Straight, 18"D + Post		20"	17 5/8"	1 1/4"	LU1-S2018-A-Q-()	\$231.	\$388.	\$572.
		26"	17 5/8"	1 1/4"	LU1-S2618-A-Q-()	244.	405.	607.
		32"	17 5/8"	1 1/4"	LU1-S3218-A-Q-()	257.	421.	641.
		38"	17 5/8"	1 1/4"	LU1-S3818-A-Q-()	289.	472.	727.
		44"	17 5/8"	1 1/4"	LU1-S4418-A-Q-()	320.	499.	774.
		50"	17 5/8"	1 1/4"	LU1-S5018-A-Q-()	349.	550.	840.
		56"	17 5/8"	1 1/4"	LU1-S5618-A-Q-()	381.	599.	929.
		62"	17 5/8"	1 1/4"	LU1-S6218-A-Q-()	409.	662.	1,028.
		68"	17 5/8"	1 1/4"	LU1-S6818-A-Q-()	441.	729.	1,114.
		74"	17 5/8"	1 1/4"	LU1-S7418-A-Q-()	471.	767.	1,173.
		80"	17 5/8"	1 1/4"	LU1-S8018-A-Q-()	502.	804.	1,232.
		86"	17 5/8"	1 1/4"	LU1-S8618-A-Q-()	533.	858.	1,312.
		92"	17 5/8"	1 1/4"	LU1-S9218-A-Q-()	564.	904.	1,387.
		98"	17 5/8"	1 1/4"	LU1-S9818-A-Q-()	610.	968.	1,484.
		104"	17 5/8"	1 1/4"	LU1-S10418-A-Q-()	625.	994.	1,526.
		110"	17 5/8"	1 1/4"	LU1-S11018-A-Q-()	640.	1,020.	1,567.
		116"	17 5/8"	1 1/4"	LU1-S11618-A-Q-()	668.	1,044.	1,608.
No Grommets		20"	17 5/8"	1 1/4"	LU1-S2018-B-Q-()	195.	359.	542.
		26"	17 5/8"	1 1/4"	LU1-S2618-B-Q-()	212.	375.	576.
		32"	17 5/8"	1 1/4"	LU1-S3218-B-Q-()	230.	392.	610.
		38"	17 5/8"	1 1/4"	LU1-S3818-B-Q-()	257.	441.	695.
		44"	17 5/8"	1 1/4"	LU1-S4418-B-Q-()	290.	472.	745.
		50"	17 5/8"	1 1/4"	LU1-S5018-B-Q-()	320.	523.	813.
		56"	17 5/8"	1 1/4"	LU1-S5618-B-Q-()	350.	569.	897.
		62"	17 5/8"	1 1/4"	LU1-S6218-B-Q-()	381.	632.	997.
		68"	17 5/8"	1 1/4"	LU1-S6818-B-Q-()	409.	697.	1,083.
		74"	17 5/8"	1 1/4"	LU1-S7418-B-Q-()	443.	738.	1,140.
		80"	17 5/8"	1 1/4"	LU1-S8018-B-Q-()	471.	775.	1,201.
		86"	17 5/8"	1 1/4"	LU1-S8618-B-Q-()	503.	827.	1,281.
		92"	17 5/8"	1 1/4"	LU1-S9218-B-Q-()	533.	874.	1,358.
		98"	17 5/8"	1 1/4"	LU1-S9818-B-Q-()	581.	938.	1,453.
		104"	17 5/8"	1 1/4"	LU1-S10418-B-Q-()	596.	965.	1,495.
		110"	17 5/8"	1 1/4"	LU1-S11018-B-Q-()	610.	992.	1,538.
		116"	17 5/8"	1 1/4"	LU1-S11618-B-Q-()	640.	1,017.	1,579.

Order Code

Example:	LU1-S4418-B-Q-117
LU1	Worksurface, 1 1/4" thick
S	Straight worksurface
44	Width
18	Depth
B	No grommet
Q	Standard Specials
117	Surface finish

Specification Information

Grommet/no grommet:
A- worksurface includes one edge grommet
B- worksurface does not include grommet

Specify surface finish.

1 1/4" Options worksurfaces are 3-ply, solid core construction with pilot holes at all pedestal, end panel, and bracket locations.

Edge grommets are centered at rear of worksurface.

Application Notes

18"D worksurfaces are used in panel system applications as shallow main surfaces, extensions or credenza tops. They may be supported at each end by an 18" end support bracket, 18" cantilever bracket, 18"W desk end panel or 18"D pedestal.

Options worksurfaces cannot be used in conjunction with Network desk supports.

All straight worksurfaces are 3/8" less than nominal depth for rear wire clearance.

Panel-supported 1 1/4" worksurfaces over 48" must be mid-span supported by MB2-C18 bracket, specified separately.

Panel-supported 1 1/4" worksurfaces over 96" must be pedestal or MB2-C24 cantilever bracket supported every 48".

Suspended pedestals may not be used with 1 1/4" worksurfaces.

Morrison Options Worksurfaces, 1 1/4" 24" D + Post

Standard Specials Systems

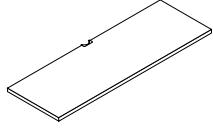
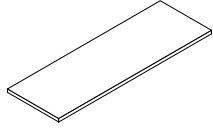
description	type	w	d	h	pattern no.	lam.	V1	V2
Straight, 24"D + Post		20"	23 5/8"	1 1/4"	LU1-S2024-A-Q-()	\$273.	\$489.	\$706.
		26"	23 5/8"	1 1/4"	LU1-S2624-A-Q-()	289.	504.	726.
		32"	23 5/8"	1 1/4"	LU1-S3224-A-Q-()	306.	525.	740.
		38"	23 5/8"	1 1/4"	LU1-S3824-A-Q-()	335.	542.	789.
		44"	23 5/8"	1 1/4"	LU1-S4424-A-Q-()	365.	582.	894.
		50"	23 5/8"	1 1/4"	LU1-S5024-A-Q-()	396.	647.	976.
		56"	23 5/8"	1 1/4"	LU1-S5624-A-Q-()	427.	680.	1,025.
		62"	23 5/8"	1 1/4"	LU1-S6224-A-Q-()	458.	748.	1,128.
		68"	23 5/8"	1 1/4"	LU1-S6824-A-Q-()	489.	794.	1,233.
		74"	23 5/8"	1 1/4"	LU1-S7424-A-Q-()	516.	819.	1,285.
		80"	23 5/8"	1 1/4"	LU1-S8024-A-Q-()	549.	890.	1,355.
		86"	23 5/8"	1 1/4"	LU1-S8624-A-Q-()	579.	948.	1,440.
		92"	23 5/8"	1 1/4"	LU1-S9224-A-Q-()	610.	1,002.	1,522.
		98"	23 5/8"	1 1/4"	LU1-S9824-A-Q-()	668.	1,063.	1,628.
		104"	23 5/8"	1 1/4"	LU1-S10424-A-Q-()	689.	1,096.	1,674.
		110"	23 5/8"	1 1/4"	LU1-S11024-A-Q-()	712.	1,129.	1,720.
116"	23 5/8"	1 1/4"	LU1-S11624-A-Q-()	733.	1,161.	1,765.		
No Grommets		20"	23 5/8"	1 1/4"	LU1-S2024-B-Q-()	244.	457.	680.
		26"	23 5/8"	1 1/4"	LU1-S2624-B-Q-()	257.	477.	694.
		32"	23 5/8"	1 1/4"	LU1-S3224-B-Q-()	275.	494.	709.
		38"	23 5/8"	1 1/4"	LU1-S3824-B-Q-()	306.	510.	758.
		44"	23 5/8"	1 1/4"	LU1-S4424-B-Q-()	335.	551.	865.
		50"	23 5/8"	1 1/4"	LU1-S5024-B-Q-()	366.	618.	945.
		56"	23 5/8"	1 1/4"	LU1-S5624-B-Q-()	396.	649.	995.
		62"	23 5/8"	1 1/4"	LU1-S6224-B-Q-()	428.	717.	1,100.
		68"	23 5/8"	1 1/4"	LU1-S6824-B-Q-()	458.	766.	1,204.
		74"	23 5/8"	1 1/4"	LU1-S7424-B-Q-()	489.	788.	1,257.
		80"	23 5/8"	1 1/4"	LU1-S8024-B-Q-()	517.	860.	1,325.
		86"	23 5/8"	1 1/4"	LU1-S8624-B-Q-()	549.	922.	1,410.
		92"	23 5/8"	1 1/4"	LU1-S9224-B-Q-()	581.	971.	1,494.
		98"	23 5/8"	1 1/4"	LU1-S9824-B-Q-()	640.	1,033.	1,599.
		104"	23 5/8"	1 1/4"	LU1-S10424-B-Q-()	660.	1,066.	1,645.
		110"	23 5/8"	1 1/4"	LU1-S11024-B-Q-()	680.	1,099.	1,691.
116"	23 5/8"	1 1/4"	LU1-S11624-B-Q-()	700.	1,129.	1,735.		

Morrison System

Order Code	Specification Information	Application Notes
Example: LU1-S3224-B-Q-117	<i>Grommet/no grommet:</i>	Options worksurfaces cannot be used in conjunction with Network desk supports.
LU1 Worksurface, 1 1/4" thick	A- worksurface includes one edge grommet	All straight worksurfaces are 3/8" less than nominal depth for rear wire clearance.
S Straight worksurface	B- worksurface does not include grommet	
32 Width	Specify surface finish.	Panel-supported 1 1/4" worksurfaces over 48" must be mid-span supported by MB2-C18 bracket, specified separately.
24 Depth		
B No grommet	1 1/4" Options worksurfaces are 3-ply, solid core construction with pilot holes at all pedestal, end panel, and bracket locations.	Panel-supported 1 1/4" worksurfaces over 96" must be pedestal or MB2-C24 cantilever bracket supported every 48".
Q Standard Specials		
117 Surface finish		
	Edge grommets are centered at rear of worksurface.	Suspended pedestals may not be used with 1 1/4" worksurfaces

Morrison Options Worksurfaces, 1 1/4" 30" D + Post

Standard Specials Systems

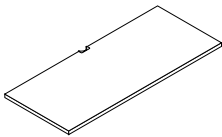
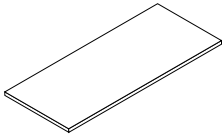
description	type	w	d	h	pattern no.	lam.	V1	V2
Straight, 30"D + Post	Grommets 	20"	29 5/8"	1 1/4"	LU1-S2030-A-Q-()	\$290.	\$476.	\$742.
		26"	29 5/8"	1 1/4"	LU1-S2630-A-Q-()	320.	512.	791.
		32"	29 5/8"	1 1/4"	LU1-S3230-A-Q-()	349.	549.	839.
		38"	29 5/8"	1 1/4"	LU1-S3830-A-Q-()	381.	599.	905.
		44"	29 5/8"	1 1/4"	LU1-S4430-A-Q-()	409.	645.	974.
		50"	29 5/8"	1 1/4"	LU1-S5030-A-Q-()	441.	710.	1,058.
		56"	29 5/8"	1 1/4"	LU1-S5630-A-Q-()	471.	762.	1,142.
		62"	29 5/8"	1 1/4"	LU1-S6230-A-Q-()	502.	806.	1,247.
		68"	29 5/8"	1 1/4"	LU1-S6830-A-Q-()	549.	872.	1,328.
		74"	29 5/8"	1 1/4"	LU1-S7430-A-Q-()	579.	912.	1,395.
		80"	29 5/8"	1 1/4"	LU1-S8030-A-Q-()	610.	962.	1,471.
		86"	29 5/8"	1 1/4"	LU1-S8630-A-Q-()	640.	1,012.	1,534.
		92"	29 5/8"	1 1/4"	LU1-S9230-A-Q-()	668.	1,063.	1,615.
		98"	29 5/8"	1 1/4"	LU1-S9830-A-Q-()	727.	1,122.	1,698.
		104"	29 5/8"	1 1/4"	LU1-S10430-A-Q-()	786.	1,181.	1,781.
		110"	29 5/8"	1 1/4"	LU1-S11030-A-Q-()	845.	1,240.	1,863.
116"	29 5/8"	1 1/4"	LU1-S11630-A-Q-()	904.	1,299.	1,946.		
No Grommets 	No Grommets	20"	29 5/8"	1 1/4"	LU1-S2030-B-Q-()	261.	454.	712.
		26"	29 5/8"	1 1/4"	LU1-S2630-B-Q-()	290.	487.	760.
		32"	29 5/8"	1 1/4"	LU1-S3230-B-Q-()	320.	520.	811.
		38"	29 5/8"	1 1/4"	LU1-S3830-B-Q-()	350.	569.	876.
		44"	29 5/8"	1 1/4"	LU1-S4430-B-Q-()	381.	616.	944.
		50"	29 5/8"	1 1/4"	LU1-S5030-B-Q-()	409.	684.	1,030.
		56"	29 5/8"	1 1/4"	LU1-S5630-B-Q-()	443.	733.	1,115.
		62"	29 5/8"	1 1/4"	LU1-S6230-B-Q-()	471.	779.	1,217.
		68"	29 5/8"	1 1/4"	LU1-S6830-B-Q-()	517.	841.	1,298.
		74"	29 5/8"	1 1/4"	LU1-S7430-B-Q-()	549.	885.	1,368.
		80"	29 5/8"	1 1/4"	LU1-S8030-B-Q-()	581.	933.	1,442.
		86"	29 5/8"	1 1/4"	LU1-S8630-B-Q-()	610.	983.	1,508.
		92"	29 5/8"	1 1/4"	LU1-S9230-B-Q-()	640.	1,033.	1,586.
		98"	29 5/8"	1 1/4"	LU1-S9830-B-Q-()	699.	1,092.	1,669.
		104"	29 5/8"	1 1/4"	LU1-S10430-B-Q-()	758.	1,151.	1,751.
		110"	29 5/8"	1 1/4"	LU1-S11030-B-Q-()	817.	1,210.	1,834.
116"	29 5/8"	1 1/4"	LU1-S11630-B-Q-()	876.	1,269.	1,916.		

Order Code	Specification Information	Application Notes
Example: LU1-S3230B-Q-117	<i>Grommets/no grommets:</i>	30"D worksurfaces are used in panel system applications as main surfaces, extensions or credenza tops. They can be supported at each end by 30" end support bracket, 30" cantilever bracket or 30"W end panel.
LU1 Worksurface, 1 1/4" thick	A- worksurface includes one edge grommet	Options worksurfaces cannot be used in conjunction with Network desk supports.
S Straight worksurface	B- worksurface does not include grommets	
32 Width	Specify surface finish.	All straight worksurfaces are 3/8" less than nominal depth for rear wire clearance.
30 Depth		
B No grommets	1 1/4" Options worksurfaces are 3-ply, solid core construction with pilot holes at all pedestal, end panel, and bracket locations.	Panel-supported 1 1/4" worksurfaces over 48" must be mid-span supported by MB2-C24 bracket, specified separately.
Q Standard Specials		
117 Surface finish		

Morrison Options Worksurfaces, 1 1/4" 36" D + Post

Standard Specials Systems

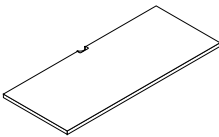
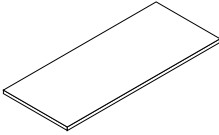
description	type	w	d	h	pattern no.	lam.	V1	V2
Straight, 36"D + Post		38"	35 7/8"	1 1/4"	LU1-S3836-A-Q-()	\$464.	\$700.	\$1,058.
		44"	35 7/8"	1 1/4"	LU1-S4436-A-Q-()	492.	746.	1,127.
		50"	35 7/8"	1 1/4"	LU1-S5036-A-Q-()	524.	811.	1,212.
		56"	35 7/8"	1 1/4"	LU1-S5636-A-Q-()	553.	863.	1,296.
		62"	35 7/8"	1 1/4"	LU1-S6236-A-Q-()	584.	906.	1,401.
		68"	35 7/8"	1 1/4"	LU1-S6836-A-Q-()	631.	972.	1,481.
		74"	35 7/8"	1 1/4"	LU1-S7436-A-Q-()	662.	1,012.	1,548.
		80"	35 7/8"	1 1/4"	LU1-S8036-A-Q-()	693.	1,062.	1,625.
		86"	35 7/8"	1 1/4"	LU1-S8636-A-Q-()	722.	1,113.	1,687.
		92"	35 7/8"	1 1/4"	LU1-S9236-A-Q-()	750.	1,163.	1,769.
		98"	35 7/8"	1 1/4"	LU1-S9836-A-Q-()	809.	1,222.	1,851.
		104"	35 7/8"	1 1/4"	LU1-S10436-A-Q-()	868.	1,281.	1,934.
		110"	35 7/8"	1 1/4"	LU1-S11036-A-Q-()	927.	1,340.	2,017.
		116"	35 7/8"	1 1/4"	LU1-S11636-A-Q-()	986.	1,399.	2,099.
No Grommets		38"	35 7/8"	1 1/4"	LU1-S3836-B-Q-()	433.	669.	1,029.
		44"	35 7/8"	1 1/4"	LU1-S4436-B-Q-()	464.	716.	1,097.
		50"	35 7/8"	1 1/4"	LU1-S5036-B-Q-()	492.	785.	1,184.
		56"	35 7/8"	1 1/4"	LU1-S5636-B-Q-()	525.	833.	1,269.
		62"	35 7/8"	1 1/4"	LU1-S6236-B-Q-()	553.	879.	1,370.
		68"	35 7/8"	1 1/4"	LU1-S6836-B-Q-()	599.	942.	1,451.
		74"	35 7/8"	1 1/4"	LU1-S7436-B-Q-()	631.	985.	1,521.
		80"	35 7/8"	1 1/4"	LU1-S8036-B-Q-()	663.	1,034.	1,595.
		86"	35 7/8"	1 1/4"	LU1-S8636-B-Q-()	693.	1,083.	1,661.
		92"	35 7/8"	1 1/4"	LU1-S9236-B-Q-()	722.	1,133.	1,739.
		98"	35 7/8"	1 1/4"	LU1-S9836-B-Q-()	781.	1,192.	1,822.
		104"	35 7/8"	1 1/4"	LU1-S10436-B-Q-()	840.	1,251.	1,905.
		110"	35 7/8"	1 1/4"	LU1-S11036-B-Q-()	899.	1,310.	1,987.
		116"	35 7/8"	1 1/4"	LU1-S11636-B-Q-()	958.	1,369.	2,070.

Morrison System

Order Code	Specification Information	Application Notes
Example: LU1-S3836B-Q-117	<i>Grommets/no grommets:</i>	30"D worksurfaces are used in panel system applications as main surfaces, extensions or credenza tops. They can be supported at each end by 30" end support bracket, 30" cantilever bracket or 30"W end panel.
LU1 Worksurface, 1 1/4" thick	A- worksurface includes one edge grommet	
S Straight worksurface	B- worksurface does not include grommets	Options worksurfaces cannot be used in conjunction with Network desk supports.
38 Width	Specify surface finish.	
36 Depth	1 1/4" Options worksurfaces are 3-ply, solid core construction with pilot holes at all pedestal, end panel, and bracket locations.	All straight worksurfaces are 3/8" less than nominal depth for rear wire clearance.
B No grommets	Edge grommets are centered at rear of worksurface.	
Q Standard Specials		Panel-supported 1 1/4" worksurfaces over 48" must be mid-span supported by MB2-C24 bracket, specified separately.
117 Surface finish		
		Suspended pedestals may not be used with 1 1/4" worksurfaces.

Morrison Options Worksurfaces, 1 1/4"
Rounded end 30" and 36"D

Standard Specials Systems

description	type	w	d	h	pattern no.	lam.	V1	V2
30"D rounded end	No Grommets	87"	30"	1 1/4"	LU1-R8730B-(L/R)-Q-()	\$996.	\$1,457.	\$2,276.
36"D rounded end	No Grommets	66"	36"	1 1/4"	LU1-R6636B-(L/R)-Q-()	961.	1,422.	2,217.
	No Grommets	78"	36"	1 1/4"	LU1-R7836B-(L/R)-Q-()	1,020.	1,481.	2,312.
	No Grommets	90"	36"	1 1/4"	LU1-R9036B-(L/R)-Q-()	1,138.	1,599.	2,500.

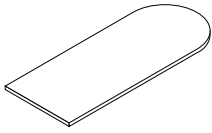

Order Code	Specification Information	Application Notes
Example: LU1-R8730B-L-Q-117	B- worksurface does not include grommets.	Rounded end worksurfaces may be supported by 30" end support brackets, 30" flat bracket or 30" conference end panel, and by a support column at the rounded end. Suspended pedestals may not be used with 1 1/4" worksurfaces. Conference worksurfaces must be supported by support column and flat bracket or bridging bracket to adjacent desk.
LU1 Options worksurface, 1 1/4" thick	Specify surface finish.	
R Rounded end		
87 Width	1 1/4" worksurfaces are 3-ply, solid core construction. Plastic laminate worksurfaces have radiused T mold edge.	
30 Depth	Rounded end worksurfaces have a flat self-edge in the straight end.	
B No grommets		
L Left hand		
Q Standard Special		
117 Surface finish		

Morrison Options Worksurfaces, 1 1/4"

P-shape curvilinear

Standard Specials Systems

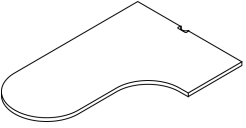
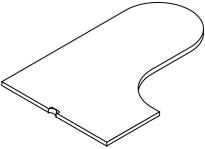
description	type	w	d	h	pattern no.	lam.	V1	V2
 Rounded end left	24"D return	48"	72"	1 1/4"	LU1-P72SA-L-Q-()	\$1,434.	\$1,841.	\$2,580.
	30"D return	48"	78"	1 1/4"	LU1-P78DA-L-Q-()	1,494.	1,922.	2,690.
 Rounded end right	24"D return	48"	72"	1 1/4"	LU1-P72SA-R-Q-()	1,434.	1,841.	2,580.
	30"D return	48"	78"	1 1/4"	LU1-P78DA-R-Q-()	1,494.	1,922.	2,690.

Morrison System

Order Code

Example: LU1-P72SA-L-Q-117
LU1 Worksurface, 1 1/4"
P P-shape curvilinear
72 Overall length
S Depth of return
A Grommets
L Rounded end left
Q Standard Special
117 Surface finish

Specification Information

S-	24"D side edge
D-	30"D side edge
Specify surface finish.	
1 1/4" curvilinear surfaces are solid core construction with threaded metal inserts at desk support and all bracket locations.	
All worksurfaces are U.L.-listed.	

Application Notes

P-shape curvilinear worksurfaces may be used interchangeably in desk and panel system applications. They may be supported by a 48" VDT support bracket kit, or 48" desk support and 6" end panel, in conjunction with rounded end support column. Use flat bracket or bridging bracket to join to adjacent 1 1/4" work surface.

P-shape laminate surfaces have continuous T-mold edge in profile to match adjacent 1 1/4" worksurfaces.

Morrison Options Worksurfaces, 1 1/4"

L-shape curvilinear

Standard Specials Systems

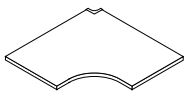
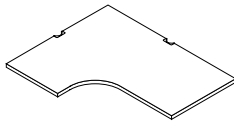
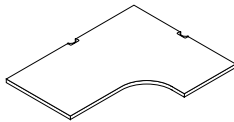
description	type	w	d	h	pattern no.	lam.	V1	V2
24"D returns left and right 	2 Grommets	42"	48"	1 1/4"	LU1-C4248SS-Q(-)	\$791.	\$1,076.	\$1,581.
		42"	60"	1 1/4"	LU1-C4260SS-Q(-)	897.	1,219.	1,797.
		42"	66"	1 1/4"	LU1-C4266SS-Q(-)	964.	1,311.	1,933.
		42"	72"	1 1/4"	LU1-C4272SS-Q(-)	1,031.	1,403.	2,069.
		48"	42"	1 1/4"	LU1-C4842SS-Q(-)	791.	1,076.	1,581.
		48"	66"	1 1/4"	LU1-C4866SS-Q(-)	1,031.	1,403.	2,069.
		60"	42"	1 1/4"	LU1-C6042SS-Q(-)	897.	1,219.	1,797.
		66"	42"	1 1/4"	LU1-C6642SS-Q(-)	964.	1,311.	1,933.
		66"	48"	1 1/4"	LU1-C6648SS-Q(-)	1,031.	1,403.	2,069.
		72"	42"	1 1/4"	LU1-C7242SS-Q(-)	1,031.	1,403.	2,069.
24"D returns left, 30"D right 	2 Grommets	42"	42"	1 1/4"	LU1-C4242SD-Q(-)	738.	1,005.	1,474.
		42"	48"	1 1/4"	LU1-C4248SD-Q(-)	791.	1,076.	1,581.
		42"	60"	1 1/4"	LU1-C4260SD-Q(-)	897.	1,219.	1,797.
		42"	66"	1 1/4"	LU1-C4266SD-Q(-)	964.	1,311.	1,933.
		42"	72"	1 1/4"	LU1-C4272SD-Q(-)	1,031.	1,403.	2,069.
		48"	42"	1 1/4"	LU1-C4842SD-Q(-)	791.	1,076.	1,581.
		48"	66"	1 1/4"	LU1-C4866SD-Q(-)	1,031.	1,403.	2,069.
		60"	42"	1 1/4"	LU1-C6042SD-Q(-)	897.	1,219.	1,797.
		66"	42"	1 1/4"	LU1-C6642SD-Q(-)	964.	1,311.	1,933.
		66"	48"	1 1/4"	LU1-C6648SD-Q(-)	1,031.	1,403.	2,069.
30"D returns left, 24"D right 	2 Grommets	42"	42"	1 1/4"	LU1-C4242DS-Q(-)	738.	1,005.	1,474.
		42"	48"	1 1/4"	LU1-C4248DS-Q(-)	791.	1,076.	1,581.
		42"	60"	1 1/4"	LU1-C4260DS-Q(-)	897.	1,219.	1,797.
		42"	66"	1 1/4"	LU1-C4266DS-Q(-)	964.	1,311.	1,933.
		42"	72"	1 1/4"	LU1-C4272DS-Q(-)	1,031.	1,403.	2,069.
		48"	42"	1 1/4"	LU1-C4842DS-Q(-)	791.	1,076.	1,581.
		48"	66"	1 1/4"	LU1-C4866DS-Q(-)	1,031.	1,403.	2,069.
		60"	42"	1 1/4"	LU1-C6042DS-Q(-)	897.	1,219.	1,797.
		66"	42"	1 1/4"	LU1-C6642DS-Q(-)	964.	1,311.	1,933.
		66"	48"	1 1/4"	LU1-C6648DS-Q(-)	1,031.	1,403.	2,069.
72"	42"	1 1/4"	LU1-C7242DS-Q(-)	1,031.	1,403.	2,069.		

Order Code

Example:	LU1-C4866SD-Q-117
LU1	Options worksurface, 1 1/4"
C	L-shape curvilinear
48	Width left
66	Width right
S	Depth of left return
D	Depth of right return
Q	Standard Special
117	Surface finish

Specification Information

Width dimension (W) refers to width of left-side back edge; depth dimension (D) indicates width of right-side back edge.

S- 24"D side edge
D- 30"D side edge

Specify surface finish.

1 1/4" curvilinear surfaces are solid core construction with pilot holes at all bracket locations.

Application Notes

Options L-shaped curvilinear worksurfaces may be supported by left- or right-hand cantilever brackets at the rear corner and cantilever bridging bracket on each side edge. Use mid-span support whenever Options worksurfaces span more than 48".

L-shape surfaces are veneer or post-formed plastic laminate on both back edges, matching profile T-mold on curvilinear front, and self-edge on sides.

Curvilinear worksurfaces are available only in 1 1/4" thickness.

L-shape surfaces are 3/8" less than nominal depth for rear wire clearance or privacy screens.

Morrison Options Worksurfaces, 1 1/4"

L-shape curvilinear

Standard Specials Systems

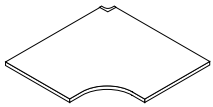
description	type	w	d	h	pattern no.	lam.	V1	V2
30"D returns left and right 	Corner Grommets	42"	42"	1 1/4"	LU1-C4242DD-Q-()	\$738.	\$1,005.	\$1,474.
	2 Grommets	42"	48"	1 1/4"	LU1-C4248DD-Q-()	791.	1,076.	1,581.
		42"	60"	1 1/4"	LU1-C4260DD-Q-()	897.	1,219.	1,797.
		42"	66"	1 1/4"	LU1-C4266DD-Q-()	964.	1,311.	1,933.
		42"	72"	1 1/4"	LU1-C4272DD-Q-()	1,031.	1,403.	2,069.
		48"	42"	1 1/4"	LU1-C4842DD-Q-()	791.	1,076.	1,581.
		48"	60"	1 1/4"	LU1-C4860DD-Q-()	964.	1,311.	1,933.
		48"	66"	1 1/4"	LU1-C4866DD-Q-()	1,031.	1,403.	2,069.
		48"	72"	1 1/4"	LU1-C4872DD-Q-()	1,099.	1,495.	2,204.
		60"	42"	1 1/4"	LU1-C6042DD-Q-()	897.	1,219.	1,797.
		60"	48"	1 1/4"	LU1-C6048DD-Q-()	964.	1,311.	1,933.
		66"	42"	1 1/4"	LU1-C6642DD-Q-()	964.	1,311.	1,933.
		66"	48"	1 1/4"	LU1-C6648DD-Q-()	1,031.	1,403.	2,069.
		72"	42"	1 1/4"	LU1-C7242DD-Q-()	1,031.	1,403.	2,069.
		72"	48"	1 1/4"	LU1-C7248DD-Q-()	1,099.	1,495.	2,204.

Morrison System

Order Code	Specification Information	Application Notes
Example: LU1-C4866SD-Q-117	Width dimension (W) refers to width of left-side back edge; depth dimension (D) indicates width of right-side back edge.	Options L-shaped curvilinear worksurfaces may be supported by left- or right-hand cantilever brackets at the rear corner and cantilever bridging bracket on each side edge. Use mid-span support whenever Options worksurfaces span more than 48".
LU1 Options worksurface, 1 1/4"		
C L-shape curvilinear	S- 24"D side edge	L-shape surfaces are veneer or post-formed plastic laminate on both back edges, matching profile T-mold on curvilinear front, and self-edge on sides.
48 Width left	D- 30"D side edge	
66 Width right	Specify surface finish.	
S Depth of left return	1 1/4" curvilinear surfaces are solid core construction with pilot holes at all bracket locations.	
D Depth of right return		
Q Standard Special		
117 Surface finish		
		L-shape surfaces are 3/8" less than nominal depth for rear wire clearance or privacy screens.

Morrison Options Worksurfaces, 1 1/4"

J-shape surfaces

Standard Specials Systems

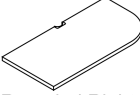

description	w	d	h	pattern no.	lam.	V1	V2
J-shape - Rounded left/right	24"	23 3/8"	1 1/4"	LU1-J24A-(L/R)-Q-()	\$489.	\$597.	\$806.
 Rounded Left	30"	23 3/8"	1 1/4"	LU1-J30A-(L/R)-Q-()	530.	647.	873.
	36"	23 3/8"	1 1/4"	LU1-J36A-(L/R)-Q-()	571.	696.	940.
 Rounded Right	42"	23 3/8"	1 1/4"	LU1-J42A-(L/R)-Q-()	607.	740.	998.
	48"	23 3/8"	1 1/4"	LU1-J48A-(L/R)-Q-()	643.	785.	1,060.
	54"	23 3/8"	1 1/4"	LU1-J54A-(L/R)-Q-()	702.	867.	1,178.
	60"	23 3/8"	1 1/4"	LU1-J60A-(L/R)-Q-()	761.	950.	1,296.
	66"	23 3/8"	1 1/4"	LU1-J66A-(L/R)-Q-()	820.	1,033.	1,414.
	72"	23 3/8"	1 1/4"	LU1-J72A-(L/R)-Q-()	879.	1,115.	1,532.
	78"	23 3/8"	1 1/4"	LU1-J78A-(L/R)-Q-()	938.	1,198.	1,650.
	84"	23 3/8"	1 1/4"	LU1-J84A-(L/R)-Q-()	997.	1,280.	1,768.
	90"	23 3/8"	1 1/4"	LU1-J90A-(L/R)-Q-()	1,056.	1,363.	1,886.
	96"	23 3/8"	1 1/4"	LU1-J96A-(L/R)-Q-()	1,115.	1,446.	2,004.

Order Code	Specification Information	Application Notes
Example: LU1-J36A-L-Q-117	1 1/4" curvilinear surfaces are solid core construction with pilot holes at bracket and pedestal locations.	J-shape curvilinear worksurfaces may be used interchangeably in desk and panel system applications. They may be supported by straight desk support or cantilever brackets. J-shapes also require 9" Network end panel in desk or panel planning.
LU1 Worksurface, 1 1/4"		
J J-shape		
36 Width		
A With grommets	<i>Grommets/no grommets:</i> A- Worksurface includes one edge grommet	
L Left		
Q Standard Special	Specify surface finish.	Use flat bracket or bridging bracket to join to adjacent 1 1/4" worksurface. Also specify VDT end support bracket kit for optimal stability of vertical panel behind J-shape worksurface.
117 Surface finish	Edge grommet is centered at rear of worksurface.	J-shape surfaces are post-formed on back edge, matching profile T-mold on curvilinear front, and self-edge on sides. J-shapes are available only in plastic laminate, 1 1/4" thickness. J-shape surfaces are 3/8" less than nominal depth for wire clearance or privacy screens.

Morrison Options Worksurfaces, 1 1/4"

Wave-end surfaces

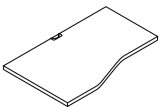
Standard Specials Systems

description	width	depth	height	pattern number	lam.
Wave-end left/right	30"	29 ⁵ / ₈ "	1 1/4"	LU1-W30A-(L/R)-Q-()	\$607.
	36"	29 ⁵ / ₈ "	1 1/4"	LU1-W36A-(L/R)-Q-()	643.
	42"	29 ⁵ / ₈ "	1 1/4"	LU1-W42A-(L/R)-Q-()	680.
	48"	29 ⁵ / ₈ "	1 1/4"	LU1-W48A-(L/R)-Q-()	719.
Wave-end Left	54"	29 ⁵ / ₈ "	1 1/4"	LU1-W54A-(L/R)-Q-()	778.
	60"	29 ⁵ / ₈ "	1 1/4"	LU1-W60A-(L/R)-Q-()	837.
	66"	29 ⁵ / ₈ "	1 1/4"	LU1-W66A-(L/R)-Q-()	896.
	72"	29 ⁵ / ₈ "	1 1/4"	LU1-W72A-(L/R)-Q-()	955.
	78"	29 ⁵ / ₈ "	1 1/4"	LU1-W78A-(L/R)-Q-()	1,014.
Wave-end Right	84"	29 ⁵ / ₈ "	1 1/4"	LU1-W84A-(L/R)-Q-()	1,073.
	90"	29 ⁵ / ₈ "	1 1/4"	LU1-W90A-(L/R)-Q-()	1,132.
	96"	29 ⁵ / ₈ "	1 1/4"	LU1-W96A-(L/R)-Q-()	1,191.

Morrison System

Order Code	Specification Information	Application Notes
Example: LU1-W42AL-Q-117	1 1/4" curvilinear surfaces are solid core construction with pilot holes at bracket and pedestal locations.	Options wave-end curvilinear worksurfaces are for panel planning only and cannot be used in conjunction with Network desk supports.
LU1 Options worksurface, 1 1/4"		
W Wave-end curvilinear	<i>Grommets/no grommets:</i>	
42 Width	A- Worksurface includes one edge grommet	Use cantilever bridging bracket to join to adjacent 1 1/4" worksurface.
A With grommets		Wave-end surfaces are post-formed on back edge, matching profile T-mold on curvilinear front, and self-edge on sides.
L Left	Specify surface finish.	Wave-end surfaces are available only in plastic laminate, 1 1/4" thickness.
Q Standard Special	Edge grommet is centered at rear of worksurface.	Wave-end surfaces are nominal 30"D at left or right, and align with 24"D surface at the other end.
117 Surface finish		

Currents System worksurfaces
curved, flat front and counter surface
1 3/4" wire drop

Standard Specials Systems

description	width	depth	pattern number	lam.	V1	V2
30"D straight worksurface, curved front	24"	30"	AW1-S2430Q()	\$359.	\$581.	\$771.
	30"	30"	AW1-S3030Q()	418.	627.	833.
	42"	30"	AW1-S4230Q()	478.	719.	959.
	54"	30"	AW1-S5430Q()	558.	833.	1,113.
	66"	30"	AW1-S6630Q()	649.	972.	1,299.
	78"	30"	AW1-S7830Q()	745.	1,114.	1,487.
24"D straight worksurface, curved front	54"	24"	AW1-S5424Q()	494.	742.	990.
	78"	24"	AW1-S7824Q()	620.	929.	1,235.
30"D straight worksurface, flat front	24"	30"	AW1-F2430Q()	359.	581.	771.
	30"	30"	AW1-F3030Q()	418.	627.	833.
	42"	30"	AW1-F4230Q()	478.	719.	959.
	54"	30"	AW1-F5430Q()	558.	833.	1,113.
	66"	30"	AW1-F6630Q()	649.	972.	1,299.
	78"	30"	AW1-F7830Q()	745.	1,114.	1,487.
Counter surface	24"	12"	AW1-CS2412Q()	248.	392.	527.
	30"	12"	AW1-CS3012Q()	278.	415.	558.
	42"	12"	AW1-CS4212Q()	309.	464.	620.
	54"	12"	AW1-CS5412Q()	340.	510.	682.
	66"	12"	AW1-CS6612Q()	372.	558.	740.

Order Code	Specification Information	Application Notes
Example: AW1 S2430-Q-119	Worksurface edges are trim grey.	Worksurfaces may be end-supported, cantilevered from Currents service wall, or supported by C-leg or pedestal at each end. Universal worksurfaces are interchangeable with Currents desks. Specify supports separately.
AW1 Worksurface	<i>Specify top finish</i>	24"D straight worksurfaces may be cantilevered with two cantilever brackets.
S Straight		24" and 30"D straight worksurfaces may be end supported with two Currents end support brackets.
24 Width		Universal straight worksurfaces 36" wide and greater include a steel stiffener that doubles as a horizontal cable manager.
30 Depth		Counter surface with curved front is designed to mount on either side of 39"H wall crown with counter surface brackets.
Q Standard Special		
119 Top finish		

description	type	width	depth	height	pattern number	P1	V1	V2
VDT corner panels	Desk height	48"	1 1/4"	24"	MK4-V2448-P/V-Q-()	\$1,160.	\$1,493.	\$2,115.
	Desk height	48"	1 1/4"	26"	MK4-V2648-P/V-Q-()	1,298.	1,670.	2,359.

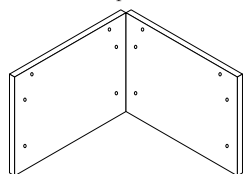

VDT transitional end panel	Desk height	48"	1 1/8"	24"	MK4-X2448-P/V-Q-()	598.	754.	1,038.
	Desk height	48"	1 1/8"	26"	MK4-X2648-P/V-Q-()	616.	837.	1,153.

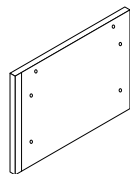

Morrison System

Order Code	Specification Information	Application Notes
Example: MK4-V2648-P-Q-612	<i>Surface type:</i>	VDT corner panels are wood desk panels ordered and shipped in pairs: one left and one right.
MK4 Desk panel	P- Painted	
V Desk panel type	V- Veneer	VDT corner end panels include 2 MB1-T brackets, VDT corner end panels/worksurface and bracket MB1-L1, filler/desk end panel.
26 Height		
48 Width		VDT transitional end panels are used when one back edge of a VDT surface is supported by a vertical panel.
P Surface type		
Q Standard Special		
612 Finish		

A VDT transitional end panel includes bracket MB1-T, desk end panel/ worksurface. Specify bracket MB1-W 18 or 20(L or R) separately.

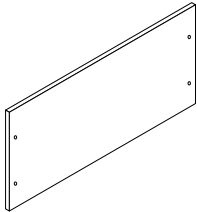
description	type	width	depth	height	pattern number	P1	V1	V2
Kneehole filler 	Desk height	18"	1 1/8"	26"	MK4-K1826-P/V-Q-()	\$157.	\$372.	\$576.
		24"	1 1/8"	26"	MK4-K2426-P/V-Q-()	216.	435.	658.
		30"	1 1/8"	26"	MK4-K3026-P/V-Q-()	275.	499.	741.
		36"	1 1/8"	26"	MK4-K3626-P/V-Q-()	334.	563.	824.
		42"	1 1/8"	26"	MK4-K4226-P/V-Q-()	393.	627.	906.
		48"	1 1/8"	26"	MK4-K4826-P/V-Q-()	452.	690.	989.
		54"	1 1/8"	26"	MK4-K5426-P/V-Q-()	511.	754.	1,071.
		84"	1 1/8"	26"	MK4-K8426-P/V-Q-()	807.	1,047.	1,497.
		90"	1 1/8"	26"	MK4-K9026-P/V-Q-()	892.	1,156.	1,654.
		96"	1 1/8"	26"	MK4-K9626-P/V-Q-()	977.	1,266.	1,811.
		102"	1 1/8"	26"	MK4-K10226-P/V-Q-()	1,062.	1,376.	1,968.
		108"	1 1/8"	26"	MK4-K10826-P/V-Q-()	1,147.	1,486.	2,125.
		114"	1 1/8"	26"	MK4-K11426-P/V-Q-()	1,232.	1,595.	2,282.
		120"	1 1/8"	26"	MK4-K12026-P/V-Q-()	1,317.	1,705.	2,439.

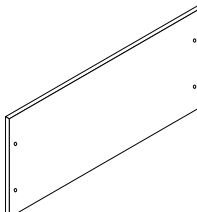
Transitional filler 	Desk height	18"	1 1/8"	26"	MK4-T1826-P/V-Q-()	157.	372.	576.
		24"	1 1/8"	26"	MK4-T2426-P/V-Q-()	216.	435.	658.
		30"	1 1/8"	26"	MK4-T3026-P/V-Q-()	275.	499.	741.
		36"	1 1/8"	26"	MK4-T3626-P/V-Q-()	334.	563.	824.
		42"	1 1/8"	26"	MK4-T4226-P/V-Q-()	393.	627.	906.
		48"	1 1/8"	26"	MK4-T4826-P/V-Q-()	452.	690.	989.
		54"	1 1/8"	26"	MK4-T5426-P/V-Q-()	511.	754.	1,071.
		84"	1 1/8"	26"	MK4-T8426-P/V-Q-()	807.	1,047.	1,497.
		90"	1 1/8"	26"	MK4-T9026-P/V-Q-()	892.	1,156.	1,654.
		96"	1 1/8"	26"	MK4-T9626-P/V-Q-()	977.	1,266.	1,811.
		102"	1 1/8"	26"	MK4-T10226-P/V-Q-()	1,062.	1,376.	1,968.
		108"	1 1/8"	26"	MK4-T10826-P/V-Q-()	1,147.	1,486.	2,125.
		114"	1 1/8"	26"	MK4-T11426-P/V-Q-()	1,232.	1,595.	2,282.
		120"	1 1/8"	26"	MK4-T12026-P/V-Q-()	1,317.	1,705.	2,439.

Order Code	Specification Information
Example: MK4-T5426-P-Q-612	P- Painted
MK4 Desk panel	V- Veneer
T Desk panel type	
54 Width	
26 Height	
P Surface type	
Q Standard Special	
612 Finish	

Specification Information

P- Painted
V- Veneer

Application Notes

Kneehole filler panels span use between two universal desk end panels to construct a freestanding wood desk.

A kneehole panel includes 2 brackets MB1-L1, filler panel/desk end panel.

All 69", 75" and 84" w kneehole filler panels are shipped with a center stabilizing bracket, MB1-AUX-D.

Transitional filler panels are used between a universal desk end panel and a vertical panel.

A transitional filler panel includes bracket MB1-L1, filler panel/desk end panel. Specify bracket MB1-W 18 or 20(L or R) separately.

A transitional filler panel over 84" w is shipped with a center stabilizing bracket, MB1-AUX-D.

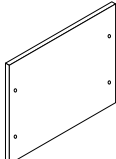
description	type	width	depth	height	pattern number	P1	V1	V2
Return filler 	Desk height	18"	1 1/8"	26"	MK4-R1826-P/V-L/R-Q-()	\$389.	\$506.	\$720.
		24"	1 1/8"	26"	MK4-R2426-P/V-L/R-Q-()	406.	550.	784.
		54"	1 1/8"	26"	MK4-R5426-P/V-L/R-Q-()	552.	841.	1,154.
		78"	1 1/8"	26"	MK4-R7826-P/V-L/R-Q-()	787.	1,080.	1,530.
		84"	1 1/8"	26"	MK4-R8426-P/V-L/R-Q-()	872.	1,198.	1,698.
		90"	1 1/8"	26"	MK4-R9026-P/V-L/R-Q-()	957.	1,316.	1,866.
		96"	1 1/8"	26"	MK4-R9626-P/V-L/R-Q-()	1,042.	1,434.	2,033.
		102"	1 1/8"	26"	MK4-R10226-P/V-L/R-Q-()	1,127.	1,552.	2,201.
		108"	1 1/8"	26"	MK4-R10826-P/V-L/R-Q-()	1,212.	1,670.	2,368.
		114"	1 1/8"	26"	MK4-R11426-P/V-L/R-Q-()	1,297.	1,788.	2,536.
		120"	1 1/8"	26"	MK4-R12026-P/V-L/R-Q-()	1,382.	1,906.	2,703.

Order Code	Specification Information	Application Notes
Example: MK4-R2426-P-L-Q-612		
MK4 Desk panel	<i>Return filler panel widths:</i>	Return filler panels provide enclosure between a universal desk end panel and the end panel of a return.
R Desk panel type	<i>Corresponding worksurface widths:</i>	
24 Width	32 3/4"	30"
26 Height	38 3/4"	36"
P Surface type	44 3/4"	42"
L Left	50 3/4"	48"
Q Standard Special	62 3/4"	60"
612 Paint	68 3/4"	66"
	74 3/4"	72"
	<i>Bridge filler panel widths:</i>	<i>Corresponding worksurface widths:</i>
	38 1/2"	30"
	44 1/2"	36"
	50 1/2"	42"
	56 1/2"	48"
	68 1/2"	60"
	74 1/2"	66"
	80 1/2"	72"
	<i>Surface type:</i>	
	P- Painted	
	V- Veneer	
		Return filler panels may also be connected to a vertical panel to provide enclosure for a desk or machine height return off a panel supported workstation. Specify MB1-FV brackets separately.
		All 69", 75" and 78"W return filler panels are shipped with a center stabilizing bracket, MB1-AUX-D.
		A return filler panel includes bracket MB1-L1, filler panel/desk end panel and all connecting hardware.

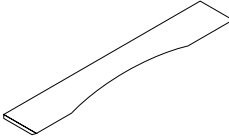
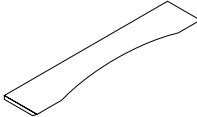
description	type	width	depth	height	pattern no.	P2
Full width 	42"	42"	10"	3/4"	MM3-IS42F-Q-()	\$293.
	48"	48"	10"	3/4"	MM3-IS48F-Q-()	345.
	54"	54"	10"	3/4"	MM3-IS54F-Q-()	396.
	84"	84"	10"	3/4"	MM3-IS84F-Q-()	647.
	90"	90"	10"	3/4"	MM3-IS90F-Q-()	721.
	96"	96"	10"	3/4"	MM3-IS96F-Q-()	795.
Returns 	54"	54"	10"	3/4"	MM3-IS54R-Q-()	349.
	84"	84"	10"	3/4"	MM3-IS84R-Q-()	548.
	90"	90"	10"	3/4"	MM3-IS90R-Q-()	597.
	96"	96"	10"	3/4"	MM3-IS96R-Q-()	647.

Order Code	
Example: MM3-IS54R-612-Q	
MM3	Accessory
IS	Intermediate shelves
54	Width
R	Return
612	Paint finish
Q	Standard Special

Specification Information

Specify paint finish.

Specify return shelves by number that corresponds to total return dimension (depth of desk and width of return).

Application Notes

Intermediate shelves provide an additional level of storage between the worksurface and standard overhead storage.

Intermediate shelves include brackets for cantilever support from vertical panel connector tracks.

Intermediate shelves may be mounted on 1" increments of height up to 1" from top of panel. Recommended position is 6" - 7" above the worksurface.

Use full width shelves with back panels of the same total width. Add returns to form a continuous "L". Half-round endpiece joins back-to-back shelves over a half-round conference worksurface. Quarter round terminates an intermediate shelf at a straight panel connection.

Intermediate shelves cannot be mounted to freestanding desks or overhead supports.

Use full width intermediate shelves that correspond with actual workstation width.

Morrison shelves and flush counter surface, 1 3/4" panel or wall mounted lam. and ven. shelves

Standard Specials Systems

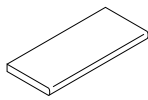
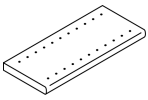
description	type	w	d	h	pattern no.	lam.	V1	V2
Panel mounted shelves and flush counter surfaces	without holes 	54"	13"	1 3/4"	MS2-W5413-Q-()	\$471.	\$840.	\$1,204.
		96"	13"	1 3/4"	MS2-W9613-Q-()	741.	1,331.	1,886.
		102"	13"	1 3/4"	MS2-W10213-Q-()	800.	1,416.	1,998.
		108"	13"	1 3/4"	MS2-W10813-Q-()	859.	1,501.	2,110.
		114"	13"	1 3/4"	MS2-W11413-Q-()	918.	1,586.	2,222.
		120"	13"	1 3/4"	MS2-W12013-Q-()	977.	1,671.	2,334.
	with holes 	54"	13"	1 3/4"	MS2-W5413-H-Q-()	486.	856.	1,219.
		96"	13"	1 3/4"	MS2-W9613-H-Q-()	758.	1,348.	1,897.
		102"	13"	1 3/4"	MS2-W10213-H-Q-()	817.	1,433.	2,010.
		108"	13"	1 3/4"	MS2-W10813-H-Q-()	876.	1,517.	2,122.
		114"	13"	1 3/4"	MS2-W11413-H-Q-()	935.	1,602.	2,234.
		120"	13"	1 3/4"	MS2-W12013-H-Q-()	994.	1,687.	2,346.

Morrison System

Order Code	Specification Information	Application Notes
Example: MS2-W5413-H-Q-612	<i>Specify paint finish for brackets and steel shelves.</i>	13"D shelves hold binders, books and other reference material. Order brackets and shelf organizers, if applicable, separately.
MS2W Shelf		
54 Width		
13 Depth		
H With holes		
Q Standard Special		
612 Surface finish		Standard 13" deep shelves double as flush counter surfaces. Specify undershelf or transaction shelf brackets for this application. Each set supports a maximum span of 48". Shelves over 60"W require MB1-AUX-S auxiliary support brackets.

All shelf brackets accept task light fixtures with the exception of the transaction shelf brackets MB2-TS-(). Adjacent bookend-style shelf brackets require MB1-TC tie clip to secure full-width task light.

Desk mounted counter surfaces do not accept task lights.

Morrison shelves and flush counter surface, 1 1/4"
panel or wall mounted lam. and ven. shelves

Standard Specials Systems

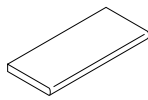
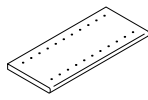
description	type	w	d	h	pattern no.	lam.	V1	V2
Panel mounted shelves and flush counter surfaces	without holes 	54"	13"	1 1/4"	MS2-U5413-Q-()	\$395.	\$700.	\$1,024.
		96"	13"	1 1/4"	MS2-U9613-Q-()	608.	1,033.	1,501.
		102"	13"	1 1/4"	MS2-U10213-Q-()	667.	1,092.	1,584.
		108"	13"	1 1/4"	MS2-U10813-Q-()	726.	1,151.	1,666.
		114"	13"	1 1/4"	MS2-U11413-Q-()	785.	1,210.	1,749.
		120"	13"	1 1/4"	MS2-U12013-Q-()	844.	1,269.	1,831.
	with holes 	54"	13"	1 1/4"	MS2-U5413-H-Q-()	412.	716.	1,040.
		96"	13"	1 1/4"	MS2-U9613-H-Q-()	624.	1,045.	1,519.
		102"	13"	1 1/4"	MS2-U10213-H-Q-()	683.	1,104.	1,601.
		108"	13"	1 1/4"	MS2-U10813-H-Q-()	742.	1,163.	1,684.
		114"	13"	1 1/4"	MS2-U11413-H-Q-()	801.	1,222.	1,766.
		120"	13"	1 1/4"	MS2-U12013-H-Q-()	860.	1,281.	1,849.

Order Code

Example:	MS2-U-5413-H-Q-612
MS2	Shelf
U	1 1/4" thick
54	Width
13	Depth
H	With holes
Q	Standard Special
612	Surface finish

Specification Information

Specify finish.
Specify suffix H for shelf holes that accept shelf organizers.

Application Notes

Panel mounted shelves are canti-levered from vertical panel connector tracks with bookend or undershelf brackets. 1 1/4" shelves must be midspan supported every 48".
13"D shelves hold binders, books and other reference material. Order brackets and shelf organizers, if applicable, separately.
Bookend-style brackets keep material upright when vertical panels are not used at the ends of shelves (brackets are shipped in pairs.)

Standard 13" deep shelves double as flush counter surfaces. Specify undershelf brackets or desk-mount stanchions for this application.

All shelves accept task lights. Adjacent bookend-style shelves require MB1-TC tie clip to secure full width task light.

Transaction shelf brackets support panel-mounted shelves without holes. Each set supports a maximum span of 48".

Morrison Overhead cabinets

panel and desk mounted

Standard Specials Systems

description	locks	w	d	h	pattern no.	P1	V1	V2
Painted or veneer front, panel mounted		24"	14"	17 ³ / ₄ "	MO8-24-()-()-N-L-Q	\$870.	\$1,030.	\$1,155.
		24"	14"	17 ³ / ₄ "	MO8-24-()-()-N-N-Q	789.	955.	1,079.

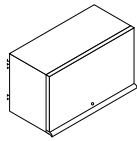

shown with lock

Painted or veneer front, stanchion mounted		24"	14"	17 ³ / ₄ "	MO8-N24-()-()-N-L-Q	870.	1,030.	1,155.
		24"	14"	17 ³ / ₄ "	MO8-N24-()-()-N-N-Q	789.	955.	1,079.

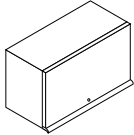

shown with lock

Order Code

Example: **MO8-N24-612-612-N-N-Q**

MO8	Overhead cabinet
N	Network mounted
24	Width
612	Paint finish for case
612	Surface finish for door
N	Black pulls
N	No lock
Q	Standard Special

Specification Information

Specify finish for case and front.

Order overhead cabinet locks with a KnollKey order form.

Interior shelves have slots for vertical dividers. Order vertical dividers separately.

Desk mounted MO8 overheads align with 64"H panel and vertical storage.

Overhead cabinet door pulls are matte black.

Overhead cabinets are hung from vertical panels with removable brackets. Cabinet door recedes within cabinet to allow use of top of overhead for storage or lighting.

Application Notes

Stanchion mounted overhead cabinets attach to overhead supports. Specify overhead backs separately for finished appearance in back-to-back or exposed applications.

Specify conversion kit MO7-SMB only if converting panel hung overheads to stanchion mounted.

Wall-mounting Morrison overhead cabinets: Use MO8-WMR to mount up to 120' of MO8 overheads. Specify one MO8-WMB for each overhead.

For Options overheads or Morrison or Options shelves, use MO6-WMSK to wall mount up to 9' of shelves or overheads. Kit includes wall mount rail and one vertical standard. Specify one additional MO6 WMSB for each shelf or overhead. Morrison shelves also require MB1-B13 shelf brackets.

Wall mount rails may be trimmed to length.

Specify conversion kit MO7-PMB only if converting stanchion mounted overheads to panel hung.

Wall mount wire manager is two-part wire concealment kit, 22"H.

Morrison Network privacy screen back screens

Standard Specials Systems

description	w	d	h	pattern no.	10	15	20	30	35	40	45
Back of worksurface screens to 42"H	24"	3/4"	15"	MZ1-B2415-(-)-Q	\$190.	\$214.	\$218.	\$241.	\$254.	\$269.	\$311.
	24"	3/4"	19"	MZ1-B2419-(-)-Q	242.	262.	269.	294.	311.	322.	351.
	24"	3/4"	22"	MZ1-B2422-(-)-Q	294.	310.	319.	351.	368.	377.	474.

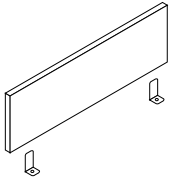

Order Code

Example:	MZ1-B2415-15-W210/20-Q
MZ1	Morrison Network privacy screen
B	Back of worksurface
24	Width
15	Height
15	Surface type and group no.
W210/20	Upholstery
Q	Standard Special

Specification Information

Surface type:

10-	Fabric group 10
15-	Fabric group 15
20-	Fabric group 20
30-	Fabric group 30
35-	Fabric group 35
40-	Fabric group 40
45-	Fabric group 45

Back of worksurface screens provide visual barrier and tackable surface from underside of worksurface to a height of 42", 46" or 49".

Screen widths should correspond to straight worksurface width, or sum of VDT corner and return widths.

Use back of worksurface screen for VDT applications where one side is backed by a vertical panel.

VDT worksurfaces will accept back screens on only one back edge.

Back screens may not be used at the end of a straight worksurface; use end screens in this application.

Privacy screens are not available in a combination of fabrics.

Back of worksurface screens are full dimension: two smaller screens may be substituted for a larger one. For example, if using fabric grades 20-70, specify two 36" screens for a 72" surface.

Between back-to-back straight or VDT worksurfaces specify a single 3/4" back screen. This allows back-to-back 23 5/8"D or 29 5/8"D worksurfaces to plan on a precise 6" module.

15" high screens are used for a 42" horizon.

19"H screens are used to fill in space between worksurface and Morrison overhead.

22"H screens fill the space between worksurface and Reuter overhead.

All but shared end screens start at the bottom of the worksurface.

Privacy screens are supported by brackets fastened at worksurface inserts. Privacy screens include mounting brackets, insert kit, and stiffener clip.

For replacement screen stiffeners see Accessories page.

Privacy screens may be specified to achieve ASTM E-84 Class "A" flamespread rating.

Morrison vertical storage options kiosk

description	width	depth	height	pattern number	Paint
Options Kiosk	24"	24"	18"	LV3-S18S-(L/R)-()-Q	\$1,236.
	24"	24"	56"	LV3-S56-(L/R)-()-Q	3,846.
	24"	30"	64"	LV3-D64-(L/R)-()-Q	4,163.
	30"	24"	64"	LV3-W64-(L/R)-()-Q	5,190.

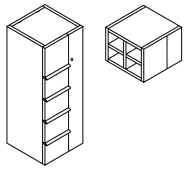

Order Code	Specification Information	Application Notes
Example: MV3-D64F-R612-Q	<i>Specify Melamine finishes for sides, top, and back of Options Kiosk.</i>	
MV3 Vertical storage		
D 30" deep	Options Kiosk fronts may be specified in any standard Morrison painted finish. Sides, top and back are available in melamine only. Kiosk storage is available in full painted finishes only.	Options Kiosks are freestanding wood construction vertical storage with four Morrison file drawers, hinged door cabinet, and coat storage with door. Options Kiosks have painted fronts and melamine sides, back and interior. The melamine top is finished, with lock cams and a few pilot holes visible.
64 Height		Kiosks are identical to Options kiosks but painted on all surfaces.
F Front access		64"H Kiosks include cabinet with hinged door over the file drawers.
R Right door hinge		18"H top cabinet attaches to 56"H Kiosk to create 74"H storage unit. Top cabinet includes front access hinged door storage over the coat storage and open shelves accessible from the sides.
612 Case and front finish		File supports for kiosk drawers must be ordered separately.
Q Standard Special	All kiosks have KnollKey lock for door, and internal sliding lock switch for files.	Flat top caps may be specified separately to coordinate with Morrison panel top caps; vault-shaped cupolas may also be used to prevent storage above kiosk. Kiosk back panels and extended depth top caps or cupolas are used with adjacent vertical panels. Back panel is notched to connect to panel with brackets and trim included. Specify straight connector track same height as vertical panel, and hi/low top cap for post configurations, in width of adjacent panel.

Morrison Network T5 Task Light Daisy Chain

Standard Specials Systems

description	type	w	d	h	pattern no.	Standard	Advanced
Task Light, starter 9 ft. cord, fused male plug 1 ft. cord, female plug	Use with 24" and wider overhead	19"	4"	1 1/2"	MN2T5E19()DCS()Q	\$342.	n/a
	Use with 30" and wider overhead	25"	4"	1 1/2"	MN2T5E25()DCS()Q	356.	533.
	Use with 42" and wider overhead	37"	4"	1 1/2"	MN2T5E37()DCS()Q	390.	554.
	Use with 60" and wider overhead	49"	4"	1 1/2"	MN2T5E49()DCS()Q	456.	570.

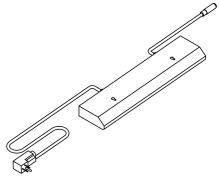

left hand shown

Task Light, adder 2 ft. cord, male plug 1 ft. cord, female plug	Use with 24" and wider overhead	19"	4"	1 1/2"	MN2T5E19()DCA()Q	374.	n/a
	Use with 30" and wider overhead	25"	4"	1 1/2"	MN2T5E25()DCA()Q	388.	565.
	Use with 42" and wider overhead	37"	4"	1 1/2"	MN2T5E37()DCA()Q	422.	586.
	Use with 60" and wider overhead	49"	4"	1 1/2"	MN2T5E49()DCA()Q	488.	602.

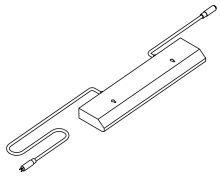

left hand shown

Task Light, ender 2 ft. cord, male plug	Use with 24" and wider overhead	19"	4"	1 1/2"	MN2T5E19()DCE()Q	261.	n/a
	Use with 30" and wider overhead	25"	4"	1 1/2"	MN2T5E25()DCE()Q	275.	452.
	Use with 42" and wider overhead	37"	4"	1 1/2"	MN2T5E37()DCE()Q	309.	473.
	Use with 60" and wider overhead	49"	4"	1 1/2"	MN2T5E49()DCE()Q	375.	489.

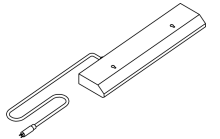

left hand shown

Order Code	Specification Information	Application Notes
Example: MN2T5E19SDCSLQ	<i>Specify:</i>	Task lights mount into the recess in the underside of overhead cabinets and shelves at least 6" wider than task light width.
MN2 Task Light	Width - Task Lights mount in cabinets and shelves at least 5" wider than light width.	Morrison Network task lights are mounted inside the horizontal beam of the overhead support.
T5 T5 lamp	1. Type: (S) Standard (A) Advanced	Task light cord may be managed in either stanchion to desk support wireway.
E Electronic ballast	2. Handedness L= Left handed (male plug on user's left side) R=Right handed (male plug on user's right side)	Task lights include T5 cool white (4100K) fluorescent lamp, electronic ballast, prismatic lens, rocker switch, one cord exit management clip and mounting hardware.
19 Width	All housings are black.	Task lights are TCLP compliant and meet requirements of California Title 24.
S Standard		Advanced task lights are fitted with ballast and lamp compliant with LEED requirements.
DC Daisy chain		
S Starter		
L Left handed		
Q Special		

Morrison Options T5 Task Light Daisy Chain

description	type	w	d	h	pattern no.	Standard	Advanced
Task Light, starter 9 ft. cord, fused male plug 1 ft. cord, female plug	Use with 24" and wider overhead	19"	4"	1 1/2"	LL2T5E19()DCS()Q	\$300.	n/a
	Use with 30" and wider overhead	25"	4"	1 1/2"	LL2T5E25()DCS()Q	343.	533.
	Use with 42" and wider overhead	37"	4"	1 1/2"	LL2T5E37()DCS()Q	368.	554.
	Use with 60" and wider overhead	49"	4"	1 1/2"	LL2T5E49()DCS()Q	411.	570.

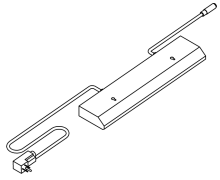

left hand shown

Task Light, adder 2 ft. cord, male plug 1 ft. cord, female plug	Use with 24" and wider overhead	19"	4"	1 1/2"	LL2T5E19()DCA()Q	332.	n/a
	Use with 30" and wider overhead	25"	4"	1 1/2"	LL2T5E25()DCA()Q	375.	565.
	Use with 42" and wider overhead	37"	4"	1 1/2"	LL2T5E37()DCA()Q	400.	586.
	Use with 60" and wider overhead	49"	4"	1 1/2"	LL2T5E49()DCA()Q	443.	602.

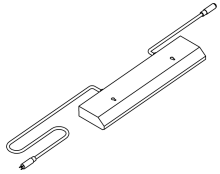

left hand shown

Task Light, ender 2 ft. cord, male plug	Use with 24" and wider overhead	19"	4"	1 1/2"	LL2T5E19()DCE()Q	219.	n/a
	Use with 30" and wider overhead	25"	4"	1 1/2"	LL2T5E25()DCE()Q	262.	452.
	Use with 42" and wider overhead	37"	4"	1 1/2"	LL2T5E37()DCE()Q	287.	473.
	Use with 60" and wider overhead	49"	4"	1 1/2"	LL2T5E49()DCE()Q	330.	489.

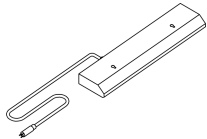

left hand shown

Order Code	Specification Information	Application Notes
Example: LL2T5E19SDCSLQ	<i>Specify:</i>	Task lights mount into the recess in the underside of overhead cabinets and shelves at least 6" wider than task light width.
LL2 Task Light	Width - Task Lights mount in cabinets and shelves at least 5" wider than light width.	Task lights include T5 cool white (4100K) fluorescent lamp, electronic ballast, prismatic lens, rocker switch, one cord exit management clip and mounting hardware.
T5 T5 lamp	1. Type: (S) Standard (A) Advanced	Task light cordset is center exit. On smaller units cord exit is off-center, but still not handed.
E Electronic ballast	2. Handedness: L= Left handed (male plug on user's left side) R=Right handed (male plug on user's right side)	Task lights are TCLP compliant and meet requirements of California Title 24.
19 Width	All housings are black.	Advanced task lights are fitted with ballast and lamp compliant with LEED requirements.
S Standard		
DC Daisy chain		
S Starter		
L Left handed		
Q Special		

Wood Finishes:

V1 Techwood Closed Pore

Y316	Maple
Y319	Cherry
Y323	Medium Walnut
Y326	Dark Mahogany
Y327	Light Oak
Y329	Medium Oak
Y341	Wenge *
Y342	Medium Teak *
Y343	Dark Grey Oak *
Y344	Espresso
Y851	Black Oak
Y811	Natural
Y821	Blond Maple
Y831	Light Cherry

**Not available on Reff optional Edges and Waterfall Edge.*

V1 - Techwood Closed Pore Surface with matching synthetic edge:

Options applicable for 1/4" thick worksurfaces with standard flat edge only.

S319	Cherry
S316	Maple
S323	Medium Walnut

V2 Natural Veneers/Premium Techwood Veneers Closed Pore

V312	Bronze Cherry
V316	Maple
V411	Light Walnut
V415	Peacock Green Walnut
V417	Old English Walnut
V418	Smoked Walnut
V433	Light Fawn Cherry
V436	Medium Brown Cherry
V440	Natural Hemlock
Y871	Iced Sycamore
Y841	Ebony
Y861	Grigio

(all above V2's are flat cut)

V421	Chalk Oak
V423	Light Oak
V425	Amber Oak
V427	Brown Oak

(all V2 Oak's are rift cut)

V439	Straight Anigre
------	-----------------

V2 Natural Veneer with synthetic edge

Options applicable for 1/4" thick worksurfaces with standard flat edge only.

Flat Cut:

R319	Medium Cherry
R315	Light Cherry
R316	Light Maple
R323	Medium Walnut
R415	Peacock Green Walnut
R417	Old English Walnut
R421	Chalk Oak
R427	Brown Oak
R312	Bronze Cherry

V3 Exotic Veneer

V512	Figured Anigre
V513	Graphite Oak (Rift cut)
V514	Makore
V515	Figured Sycamore
V517	Natural Sapele
V518	Natural Chestnut

(all above are quarter cut)

Glass Options:

TEMP	Clear Tempered (G1)
------	---------------------

Architectural Glass Options: (G2)

GL13	Powder
GL8	Wafer
GL6	Block Matrix

Back Painted Glass (G3)

GL11	Back Painted Black
GL15	Back Painted Medium Grey
GL18	Back Painted White

Locks

Black and Silver

Laminate

Matching edge band unless noted otherwise

111	Jet Black
114	Folkstone Grey
115	Medium Grey
117	Soft Grey
118	Bright White
119	Pumice
121	Micro Grey with 114 Folkstone grey edge band
122	Brushed Sand with 119 Pumice edge band
123	Brushed Grey with 128 Fog edge band
124	Medium Chery
125	Natural Maple
126	Natural Cherry
127	Walnut
128	Fog
129	Micro Sand with 119 Pumice edge band

Paint Classifications:

Upcharge as applicable for paint class noted on applicable product pages

P1

111	Jet Black
112	Brown
113	Dark Grey
114	Folkstone Grey
115	Medium Grey
116	Sandstone
117	Soft Grey

P2

611	Beige Mist Metallic
612	Medium Metallic Grey

P3

118	Bright White
613	Silver
PD	Polish Chrome
PT	Brushed Pewter
PN	Black Nickel
AN	
AP	
AU	

See matrix next page for finishes applicable by component

Forbo

851	Biscuit
852	Sky Blue
853	Stone
854	Cinnamon
855	Heather Blue

Mixed Finishes: (where applicable for work surfaces only)

To order mixed finishes, enter four digit finish code as follows:

Use 2 digit prefix to indicate surface finish (laminate)

11	Jet Black
14	Folkstone Grey
17	Soft Grey
18	Bright White
19	Pumice
21	Micro Grey
22	Brushed Sand
23	Brushed Grey
28	Fog
29	Micro Sand

Use 2 digit suffix to indicate edge finish (wood)

12	for V312
16	for V316, Y316
Y9	for Y319
Y3	for Y323
26	for Y326
27	for Y327
29	for Y329
43	for V433
45	for V415
46	for V436
47	for V417
48	for V418
49	for V439
52	for V512
53	for V513
54	for V514
55	for V515
57	for V517
61	for V411
71	for V421
73	for V423
75	for V425
77	for V427

Example:

For a Micro Grey laminate surface with Bronzed Cherry edge, enter finish code 2112

For a Jet Black laminate surface with Light Maple edge, enter finish code 1116

Fabric Options

Grade 10

Bailey II (W359) ø
 Broadcloth (W288)
 Foundation (W351)
 Growth Spurt (W692)
 Newbury (W812) ø
 Solid Crepe (W257) ø
 Symbolic Detail (W693)
 Tailor Made (W133)
 Versatility (W432)

Grade 15

Regency (W210)

Grade 20

Banyan (W443)
 Bauhaus Block (W296A)
 Circle Line (W1146)
 Clarity (W281)
 Criss Cross (W305)
 Devon (W809) ø
 Labyrinth (W352)
 Melbourne (W228)
 Outback (W229)
 Reflect (W884) ø
 Resolution (W280)
 Walkabout (W230)
 Weave Three (W298)

Grade 30

Basket Draft (W249)
 Flow (W565)
 Harmony (W232)
 Interknit (W1090)
 Match Point (W1145)
 Micro (W465)*
 Progression (W403)
 Raku Cloth (W566) ø
 Relay (W1020) ▲

Grade 40

Clarkson (W1218)
 Ornament (W1078)
 Palladium (W1030)
 Sennit (W337)
 Spinoff Nuance (W319)

Grade 45

Casual Elegance (W920)
 Dristi (K872)* ø

*with backing only

▲ Monolithic panels and tackboards only

ø May not be available in all colors.

The following textiles are approved for use on Reff panels. Consult Knoll representative for pricing:

Grade 50

Knoll Hopsack (K1206)
 Ricochet (W498)

Grade 55

Knoll Felt (K1207)
 Transition (W816)

Customers Own Material

Prices for panels that are to be manufactured with a customer supplied fabric will follow Grade 10 panel pricing.

COM fabrics are subject to a testing charge prior to acceptance for use on Reff panels. Panels bearing COM fabrics are subject to extended leadtimes. It is the responsibility of the customer's purchasing agent to ensure COM fabric is supplied for testing and manufacturing. Delays in receiving COM fabric for manufacturing will result in rescheduled delivery dates.

When specifying panel/fabrics use the following format to denote location on a tiled panel.

Side 1		Side 2
1E	Top of Panel	2E
1D		2D
1C		2C
1B		2B
1A	Bottom of Panel	2A

(Side 1 is always the inside of the workstation.)

Panels with beltway one side: assume the beltway is on SIDE 1 of the panel.

Non-Wood Finishes

Finishes	Panel Tiles, Worksurfaces & Components	Panel Top Trims Window Frames	Panel Base Side Plates	Panel Beltway Side Plates*	Leg and Bases	Interaction Style Legs	Pulls	Grommets
	Jet Black	111	111	111	111	111	111	111
Dark grey	n/a	113	113	113	113	113	n/a	113
Medium grey	n/a	115	115	115	115	115	n/a	115
Soft grey	117	117	117	117	117	117	n/a	117
Folkstone grey	114	114	114	114	114	114	n/a	114
Pumice	119	119	119	119	119	119	n/a	119
Sandstone	n/a	116	116	116	116	116	n/a	116
Brown	n/a	112	112	112	112	112	112	112
Medium metallic grey	n/a	612	612	612	612	612	612	612
Silver	n/a	613	613	613	613	613	613	613
Bright White	118	118	118	118	118	118	118	118
Beige metallic mist	n/a	611	611	611	611	611	611	611
Micro Grey *	121	n/a	n/a	n/a	n/a	n/a	n/a	n/a
Brushed Sand *	122	n/a	n/a	n/a	n/a	n/a	n/a	n/a
Brushed Grey *	123	n/a	n/a	n/a	n/a	n/a	n/a	n/a
Fog	128	n/a	n/a	n/a	n/a	n/a	n/a	n/a
Micro Sand *	129	n/a	n/a	n/a	n/a	n/a	n/a	n/a
Plated Finishes								
Satin brass	n/a	n/a	PZ	n/a	PZ	n/a	PZ	PZ
Brushed pewter	n/a	n/a	PT	n/a	PT	n/a	PT	PT
Polished chrome	n/a	n/a	PD	n/a	PD	n/a	n/a	PD

n/a = not available

* = matching edge band not available, also not optional for panel tiles or components, worksurfaces only

Reff Panels

Monolithic

34", 42" and 49" high

Standard Specials Systems

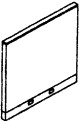
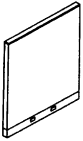
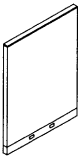
description	h	w	pattern no.	V1	V2	V3
Wood/Wood Regular Acoustics		18"	QR3B0P (11/22/33) 3418 () ()	\$796.	\$817.	\$1,103.
		20"	QR3B0P (11/22/33) 3420 () ()	796.	817.	1,103.
		24"	QR3B0P (11/22/33) 3424 () ()	849.	872.	1,177.
		30"	QR3B0P (11/22/33) 3430 () ()	910.	936.	1,264.
		36"	QR3B0P (11/22/33) 3436 () ()	967.	995.	1,343.
		42"	QR3B0P (11/22/33) 3442 () ()	1,114.	1,146.	1,547.
		48"	QR3B0P (11/22/33) 3448 () ()	1,157.	1,191.	1,607.
	42"	18"	QR3B0P (11/22/33) 4218 () ()	703.	726.	979.
		20"	QR3B0P (11/22/33) 4220 () ()	703.	726.	979.
		24"	QR3B0P (11/22/33) 4224 () ()	715.	734.	992.
		30"	QR3B0P (11/22/33) 4230 () ()	856.	882.	1,192.
		36"	QR3B0P (11/22/33) 4236 () ()	928.	953.	1,287.
		42"	QR3B0P (11/22/33) 4242 () ()	1,035.	936.	1,264.
		48"	QR3B0P (11/22/33) 4248 () ()	1,133.	1,166.	1,575.
		60"	QR3B0P (11/22/33) 4260 () () *	1,233.	1,268.	1,712.
		66"	QR3B0P (11/22/33) 4266 () () *	1,279.	1,316.	1,777.
	49"	18"	QR3B0P (11/22/33) 4918 () ()	782.	804.	1,085.
		20"	QR3B0P (11/22/33) 4920 () ()	782.	804.	1,085.
		24"	QR3B0P (11/22/33) 4924 () ()	804.	882.	1,192.
		30"	QR3B0P (11/22/33) 4930 () ()	967.	995.	1,343.
		36"	QR3B0P (11/22/33) 4936 () ()	1,044.	1,074.	1,449.
		42"	QR3B0P (11/22/33) 4942 () ()	1,153.	1,186.	1,601.
		48"	QR3B0P (11/22/33) 4948 () ()	1,304.	1,337.	1,806.
		60"	QR3B0P (11/22/33) 4960 () () *	1,407.	1,446.	1,952.
		66"	QR3B0P (11/22/33) 4966 () () *	1,453.	1,458.	1,967.
		72"	QR3B0P (11/22/33) 4972 () () *	1,498.	1,541.	2,080.



Order Code	Specification Information	Application Notes
Example: QR3B0PLL3418-A4K	<i>To order please specify pattern number including:</i>	
QR3 Reff Generation 3 Special	1. Top trim profile	1. Top trim profile: A = Flat B = Square C = Bullnose E = Extruded aluminum, anodized finish only
B0 No Beltway	2. Base height	2. Base height: 4 = 4" base height 6 = 6" base height (add \$47 per panel for this option)
P Monolithic panel	3. Knockout option (K = with knockouts, N = without knockouts)	Applicable finishes are listed on page 102 and 103.
LL Laminage on both sides	4. Panel side 1 finish(s) inside	Product on this page will accept wood grain laminate where laminate is currently an option. Panel product is subject to a 10% upcharge on Laminate/Laminate base panel price.
34 34" high	5. Panel side 2 finish(s) outside	
18 18" wide	6. Top trim finish	
(A) Flat style top trim	7. Base finish	
(4) 4" base height	8. <i>Optional:</i> specify (M) for panel frame to be milled for ported components. \$14 list upcharge applicable	
(K) Include knockouts in base		
118 Laminate selection - side 1		All panels on this page accept stacking modules except those indicated with an asterisk.
118 Laminate selection - side 2		6" Raceway option increases panel height by 2 ³ / ₄ ".
V316 Maple (top trim finish)		All panels on this page have no high acoustical option or Beltway option.
118 Bright White (base finish)		Product on this page can be attached to posts 34"H, other 34", 42", 49", 64", and 79" panels without beltway. To attach 34"H panels to Beltway posts over 34"H, order appropriate attachment kit from standard Reff price list.
		79"H hookstrip reveal strips are ordered separately from page the standard Reff price list at no charge.
		* These panel widths do not accept stacking modules.

Reff Panels

Monolithic

64" and 79" high

Standard Specials Systems

description	h	w	pattern no.	V1	V2	V3
Wood/Wood Regular Acoustics		18"	QR3B0P (11/22/33) 6418 () ()	\$931.	\$955.	\$1,290.
		20"	QR3B0P (11/22/33) 6420 () ()	931.	955.	1,290.
		24"	QR3B0P (11/22/33) 6424 () ()	1,016.	1,045.	1,411.
		30"	QR3B0P (11/22/33) 6430 () ()	1,152.	1,185.	1,600.
		36"	QR3B0P (11/22/33) 6436 () ()	1,242.	1,279.	1,727.
		42"	QR3B0P (11/22/33) 6442 () ()	1,376.	1,417.	1,913.
		48"	QR3B0P (11/22/33) 6448 () ()	1,550.	1,596.	2,155.
		60"	QR3B0P (11/22/33) 6460 () () *	1,679.	1,727.	2,330.
		66"	QR3B0P (11/22/33) 6466 () () *	1,737.	1,786.	2,413.
		72"	QR3B0P (11/22/33) 6472 () () *	1,795.	1,846.	2,493.
		18"	QR3B0P (11/22/33) 7918 () () *	1,171.	1,207.	1,629.
		20"	QR3B0P (11/22/33) 7920 () () *	1,168.	1,207.	1,629.
		24"	QR3B0P (11/22/33) 7924 () () *	1,282.	1,320.	1,781.
		30"	QR3B0P (11/22/33) 7930 () () *	1,448.	1,490.	2,011.
		36"	QR3B0P (11/22/33) 7936 () () *	1,575.	1,622.	2,189.
		42"	QR3B0P (11/22/33) 7942 () () *	1,745.	1,795.	2,423.
		48"	QR3B0P (11/22/33) 7948 () () *	1,950.	2,006.	2,707.
		60"	QR3B0P (11/22/33) 7960 () () *	2,098.	2,160.	2,915.
		66"	QR3B0P (11/22/33) 7966 () () *	2,143.	2,203.	2,974.
		72"	QR3B0P (11/22/33) 7972 () () *	2,183.	2,249.	3,037.

Reff System

Order Code	Specification Information	Application Notes
Example: QR3B0PLL3418-A4K	<i>To order please specify pattern number including:</i>	
QR3 Reff Generation 3 Special	1. Top trim profile	1. Top trim profile: A = Flat B = Square C = Bullnose E = Extruded aluminum, anodized finish only
B0 No Beltway	2. Base height	2. Base height: 4 = 4" base height 6 = 6" base height (add \$47 per panel for this option)
P Monolithic panel	3. Knockout option (K = with knockouts, N = without knockouts)	Applicable finishes are listed on page 102 and 103.
LL Laminate on both sides	4. Panel side 1 finish(s) inside	Product on this page will accept wood grain laminate where laminate is currently an option.
34 34" high	5. Panel side 2 finish(s) outside	Panel product is subject to a 10% upcharge on Laminate/Laminate base panel price.
18 18" wide	6. Top trim finish	
(A) Flat style top trim	7. Base finish	
(4) 4" base height	8. <i>Optional:</i> specify (M) for panel frame to be milled for ported components. \$14 list upcharge applicable	
(K) Include knockouts in base		
118 Laminate selection - side 1		All panels on this page accept stacking modules.
118 Laminate selection - side 2		6" Raceway option increases panel height by 2 3/4".
V316 Maple (top trim finish)		All panels on this page have no high acoustical option or Beltway option except those indicated with an asterisk.
118 Bright White (base finish)		Product on this page can be attached to posts 34"H, other 34", 42", 49", 64", and 79" panels without beltway. To attach 34"H panels to Beltway posts over 34"H, order appropriate attachment kit from the standard Reff price list.
		79"H hookstrip reveal strips are ordered separately from page standard Reff price list at no charge.
		* These panel widths do not accept stacking modules.

Reff Panels

Tiled

34", 42" and 49" High

Standard Specials Systems

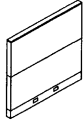
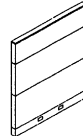
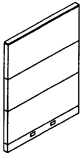
description	h	w	pattern no.	V1	V2	V3
Wood/Wood Regular Acoustics		18"	QR3B0T (11/22/33) 3418 () ()	\$885.	\$911.	\$1,230.
		20"	QR3B0T (11/22/33) 3420 () ()	885.	911.	1,230.
		24"	QR3B0T (11/22/33) 3424 () ()	946.	973.	1,313.
		30"	QR3B0T (11/22/33) 3430 () ()	1,007.	1,034.	1,397.
		36"	QR3B0T (11/22/33) 3436 () ()	1,065.	1,095.	1,479.
		42"	QR3B0T (11/22/33) 3442 () ()	1,211.	1,246.	1,683.
		48"	QR3B0T (11/22/33) 3448 () ()	1,249.	1,285.	1,735.
	42"	18"	QR3B0T (11/22/33) 4218 () ()	995.	1,022.	1,380.
		20"	QR3B0T (11/22/33) 4220 () ()	995.	1,022.	1,380.
		24"	QR3B0T (11/22/33) 4224 () ()	1,057.	1,086.	1,467.
		30"	QR3B0T (11/22/33) 4230 () ()	1,130.	1,161.	1,567.
		36"	QR3B0T (11/22/33) 4236 () ()	1,193.	1,226.	1,655.
		42"	QR3B0T (11/22/33) 4242 () ()	1,331.	1,367.	1,846.
		48"	QR3B0T (11/22/33) 4248 () ()	1,394.	1,434.	1,936.
	49"	18"	QR3B0T (11/22/33) 4918 () ()	1,112.	1,145.	1,546.
		20"	QR3B0T (11/22/33) 4920 () ()	1,112.	1,145.	1,546.
		24"	QR3B0T (11/22/33) 4924 () ()	1,180.	1,213.	1,637.
		30"	QR3B0T (11/22/33) 4930 () ()	1,263.	1,298.	1,752.
		36"	QR3B0T (11/22/33) 4936 () ()	1,331.	1,367.	1,846.
		42"	QR3B0T (11/22/33) 4942 () ()	1,484.	1,527.	2,060.
		48"	QR3B0T (11/22/33) 4948 () ()	1,559.	1,606.	2,167.

Order Code	Specification Information	Application Notes
Example: QR3B0TFF3418-A4K	<i>To order please specify pattern number including:</i>	All panels on this page have no high acoustical option or Beltway option. Product on this page can be attached to posts 34"H, other 34", 42", 49", 64", and 79" panels without beltway. To attach 34" high panels to Beltway posts, order appropriate attachment kits from page standard Reff price list.
QR3 Reff Generation 3 Special	1. Top trim profile 2. Base height 3. Knockout option (K = with knockouts, N = without knockouts)	
B0 No Beltway	4. Panel side 1 finish(s) inside	The panels on this page will accept stacking modules to increase their height on 18" to 48"W panels only. The 60" to 72"W panels will not accept stacking modules on top of themselves.
T Tiled panel	5. Panel side 2 finish(s) outside	
FF Fabric on both sides	6. Top trim finish	79"H hookstrip reveal strips are ordered separately from standard Reff price list at no charge.
34 34" high	7. Base finish	
18 18" wide	8. <i>Optional:</i> specify (M) for panel frame to be milled for ported components. \$14 list upcharge applicable	6" Raceway option increases panel height by 2 3/4".
A Flat style top trim		
4 4" base height		Applicable finishes are listed on page 102 and 103.
K Include knockouts in base		
W281 Fabric selection - side 1		Product on this page will accept wood grain laminate where laminate is currently an option. Panel product is subject to a 10% upcharge on Laminate/Laminate base panel price.
W281 Fabric selection - side 2		
V316 Maple (top trim finish)		
111 Jet Black (base finish)		

Reff Panels

Tiled

64" and 79" High

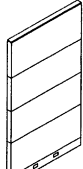
description	h	w	pattern no.	V1	V2	V3
Wood/Wood Regular Acoustics		18"	QR3B0T (11/22/33) 6418 () ()	\$1,301.	\$1,338.	\$1,807.
		20"	QR3B0T (11/22/33) 6420 () ()	1,301.	1,338.	1,807.
		24"	QR3B0T (11/22/33) 6424 () ()	1,379.	1,419.	1,916.
		30"	QR3B0T (11/22/33) 6430 () ()	1,470.	1,511.	2,040.
		36"	QR3B0T (11/22/33) 6436 () ()	1,549.	1,595.	2,152.
		42"	QR3B0T (11/22/33) 6442 () ()	1,737.	1,786.	2,413.
		48"	QR3B0T (11/22/33) 6448 () ()	1,822.	1,875.	2,530.

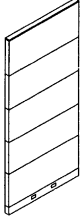
	18"	QR3B0T (11/22/33) 7918 () ()	1,619.	1,665.	2,247.
	20"	QR3B0T (11/22/33) 7920 () ()	1,619.	1,665.	2,247.
	24"	QR3B0T (11/22/33) 7924 () ()	1,711.	1,761.	2,377.
	30"	QR3B0T (11/22/33) 7930 () ()	1,795.	1,846.	2,493.
	36"	QR3B0T (11/22/33) 7936 () ()	1,884.	1,939.	2,617.
	42"	QR3B0T (11/22/33) 7942 () ()	2,108.	2,168.	2,927.
	48"	QR3B0T (11/22/33) 7948 () ()	2,202.	2,266.	3,060.

Order Code

Example:	QR3B0TFF3418-A4K
QR3	Reff Generation 3 Special
B0	No Beltway
T	Tiled panel
FF	Fabric on both sides
34	34" high
18	18" wide
A	Flat style top trim
4	4" base height
K	Include knockouts in base
W281	Fabric selection - side 1
W281	Fabric selection - side 2
V316	Maple (top trim finish)
111	Jet Black (base finish)

To order please specify pattern number including:

1. Top trim profile
2. Base height
3. Knockout option
(K = with knockouts,
N = without knockouts)
4. Panel side 1 finish(s) inside
5. Panel side 2 finish(s) outside
6. Top trim finish
7. Base finish
8. *Optional:* specify (M) for panel frame to be milled for ported components. \$14 list upcharge applicable

1. *Top trim profile:*

- A = Flat
- B = Square
- C = Bullnose
- E = Extruded Aluminum, anodized finish only

2. *Base height:*

- 4 = 4" base height
- 6 = 6" base height (add \$47 per panel)

3. *Tile divider: (E option) applies to both sides*

64" h add per panel:
\$78 for 18w and 20w
\$86 for 24w and 30w
\$96 for 36w and 42w
\$124 for 48w

79" h add per panel:
\$100 for 18w and 20w
\$116 for 24w and 30w
\$124 for 36w and 42w
\$168 for 48w

All panels on this page accept stacking modules.

6" Raceway option increases panel height by 2 3/4".

Applicable finishes are listed on page 102 and 103.

Product on this page will accept wood grain laminate where laminate is currently an option.
Panel product is subject to a 10% upcharge on Laminate/Laminate base panel price.

Application Notes

All panels on this page have no high acoustical option or Beltway option. Product on this page can be attached to posts 34"H, other 34", 42", 49", 64", and 79" panels without beltway. To attach 34" high panels to Beltway posts, order appropriate attachment kits from the standard Reff price list.

The panels on this page will accept stacking modules to increase their height on 18" to 48"W panels only. The 60" to 72"W panels will not accept stacking modules on top of themselves.

79"H hookstrip reveal strips are ordered separately from the standard Reff price list at no charge.

Reff Panels

Stacking modules and Slatwall

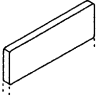
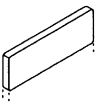
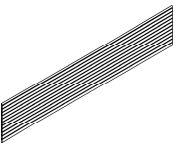
description	height	width	pattern no.	lam.	AA	V1	V2	V3
Laminate/Laminate *,**	8"	18"	QR3S (LL/11/22/33) 0818 () ()	\$275.		\$285.	\$293.	\$396.
Wood/Wood	8"	20"	QR3S (LL/11/22/33) 0820 () ()	275.		285.	293.	396.
Regular Accoustics	8"	24"	QR3S (LL/11/22/33) 0824 () ()	285.		297.	303.	410.
	8"	30"	QR3S (LL/11/22/33) 0830 () ()	315.		328.	336.	454.
	8"	36"	QR3S (LL/11/22/33) 0836 () ()	348.		362.	373.	503.
	8"	42"	QR3S (LL/11/22/33) 0842 () ()	376.		390.	401.	542.
	8"	48"	QR3S (LL/11/22/33) 0848 () ()	403.		418.	431.	583.
Laminate/Laminate *	15"	18"	QR3S (LL/11/22/33) 1518 () ()	368.		383.	395.	533.
Wood/Wood	15"	20"	QR3S (LL/11/22/33) 1520 () ()	368.		383.	395.	533.
Regular Accoustics	15"	24"	QR3S (LL/11/22/33) 1524 () ()	387.		402.	414.	559.
	15"	30"	QR3S (LL/11/22/33) 1530 () ()	428.		445.	457.	617.
	15"	36"	QR3S (LL/11/22/33) 1536 () ()	467.		485.	499.	675.
	15"	42"	QR3S (LL/11/22/33) 1542 () ()	509.		529.	545.	735.
	15"	48"	QR3S (LL/11/22/33) 1548 () ()	546.		567.	584.	788.
Slatwall	15"	18"	QR2 SLAT 1518 ()	207.	247.			
	15"	20"	QR2 SLAT 1520 ()	220.	260.			
	15"	24"	QR2 SLAT 1524 ()	239.	280.			
	15"	30"	QR2 SLAT 1530 ()	287.	338.			
	15"	36"	QR2 SLAT 1536 ()	319.	377.			
	15"	42"	QR2 SLAT 1542 ()	369.	436.			
	15"	48"	QR2 SLAT 1548 ()	417.	493.			

Available in anodized aluminum (AA)& painted finishes
Screws directly to panel frame

Order Code

Example:	QR3SLL0820
QR3	Reff Generation 3
S	Stacking module
LL	Laminate/Laminate
08	8" high
20	20" wide
118	Laminate selection - side 1
118	Laminate selection - side 2

Specification Information

- To order please specify:
1. Pattern number including height and width
 2. Panel side 1 finish
 3. Panel side 2 finish

Product on this page will accept wood grain laminate where laminate is currently an option. Panel product is subject to a 10% upcharge on Laminate/Laminate base panel price.

Application Notes

- * Not for use on 79"H panels.
- * * Suitable only for top of any panel. Cannot be stacked upon.
- 8" module will not accept additional modules on top.
- Use of 8" module on panel heights other than 34" h will require custom end trims and Hi-Lo parts.
- Stacking modules on this page are high acoustic with a hard board septum and fiberglass.

Reff Panels

Midspan Off-set T-connectors

Standard Specials Systems

description	h	pattern no.	list
Mid-Span Connector	42"	QS9G5875	\$312.
To be used with Generation 3 panels only	49"	QS9G5498	335.
	64"	QS9G5499	437.
	79"	QS9G5876	472.
<i>attach mid-span of a panel</i>			
Offset T-connectors	42"	QS994873	430.
	49"	QS9A8003	455.
	64"	QS9A8002	491.
	79"	QS9B2960	527.

Reff System

Order Code

Specification Information

Application Notes

To be used in creating a panel run for visual separation only. Panels running off above connectors **are not loadbearing!**

Spine panel must be 1 piece and not a stackable creation.

Perpendicular panel can be 1 piece made of stackable modules.

Reff Panels

End trim, base drape&base raceway

Standard Specials Systems

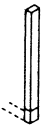
description	h	w	pattern no.	Profile (A/B/C)	Profile (E)	list
 End trim with hookstrip	57"		QR2ES4215() () () ()	\$362.	\$250.	
	57"		QR2ES498() () () ()	362.	250.	
	72"		QR2ES49158() () () ()	441.	283.	
	72"		QR2ES648() () () ()	441.	283.	
1" h base drape&rigidizer	1"	96"	QS990981			166.
2" h base drape&rigidizer	2"	96"	QS9A5986			326.
Base raceway with 2 extra date knockouts	4"	36"	QS9G2425			144.
	4"	42"	QS9G2320			165.
	4"	48"	QS9G2321			171.

Order Code	Specification Information	Application Notes
Example: QR2ES49158-A-6-V316-111 QR2 Reff Generation 2 ES End trim 49158 49+15+8=72" high A Flat profile 6 6" base height N Non electrical base V316 Trim finish, Maple 111 Jet Black (base finish)	<p>To order please specify pattern number including:</p> <p>End trim:</p> <ol style="list-style-type: none"> Trim profile <i>A = flat</i> <i>B = square</i> <i>C = bullnose</i> <i>E = extruded aluminum</i> Base height option <i>4 = 4"</i> <i>6 = 6"</i> Base type <i>E = electrical entry</i> <i>N = standard base</i> Finish, end trim <i>If profile A, B or C specify V1, V2, V3 or painted to match laminate</i> <i>If profile E specify AA-anodized aluminum or painted finish from page 0 excluding silver</i> Finish, end trim base <i>painted or plated finish</i> 	<p>Add \$24 list for each end trim with 6" H base option. Does not apply to hi-lo end trims as they have no base.</p> <p>E profile end trim does not have base detail, but base height 4 or 6 required to determine overall height.</p> <p>End trim is for combination of panel and stackable module.</p> <p>Eg. QR2ES49158 is a 72" high end trim for a 49" h panel + 15" h stackable + 8" h stackable module. End trim for other panel combinations must be quoted thru custom product development.</p> <p>Base drape is for preventing light gap at base of a panel of a panel. Available in 8ft length and can be cut in field. Black finish only.</p> <p>Base raceway has 4 knockouts: 2 knockouts for electrical at standard location, 2 knockouts for date/communication at special location (5 3/4" from each end). Includes 4 standard knockout cover plates.</p> <p>Other panel widths are not available with extra data knockouts.</p>

Reff Panels

U-channel wall starter cover

Standard Specials Systems

description	h	w	d	pattern no.	list
U-channel wall starter cover (does not cover hookstrip)	34"	2 1/2"	13/16"	QRWSU34()()	\$403.
	42"	2 1/2"	13/16"	QRWSU42()()	494.
	49"	2 1/2"	13/16"	QRWSU49()()	578.
	64"	2 1/2"	13/16"	QRWSU64()()	757.
	79"	2 1/2"	13/16"	QRWSU79()()	932.
U-channel wall starter cover (covers hookstrip)	34"	2 1/2"	1 1/16"	QRWSUH34()()	403.
	42"	2 1/2"	1 1/16"	QRWSUH42()()	494.
	49"	2 1/2"	1 1/16"	QRWSUH49()()	578.
	64"	2 1/2"	1 1/16"	QRWSUH64()()	757.
	79"	2 1/2"	1 1/16"	QRWSUH79()()	932.
U-channel wall starter cover Field to ceiling	21"	2 1/2"	1 1/16"	QRFCWSUH21()	256.
	25"	2 1/2"	1 1/16"	QRFCWSUH25()	301.
	37"	2 1/2"	1 1/16"	QRFCWSUH37()	437.

Reff System

Order Code

Example: QRWSUH79-6-111	
QR	Reff
WS	Wall starter
U	U-channel cover
H	Hookstrip portion covered
6	6" base height
111	Paint finish, jet black

Specification Information

To order please specify pattern number including:

1. Base height option
4 = 4"
6 = 6" (add \$24 for this option)
2. Paint finish only

Application Notes

The U-channel is for covering up a wall starter. Hookstrip portion can be covered as well. Please note that if hookstrip portion is covered, panel-hung components and brackets cannot be used.

The U-channel is placed between drywall and wall starter. Slots in channel align with pre-drilled holds on wall on wall starter to allow for in-field leveling. There is an electrical entry at base of channel.

Field to ceiling wall starter cover is intended for 4" h base wall starter only.

Reff Worksurfaces

1 1/4" thick straight rectilinear

Standard Specials Systems

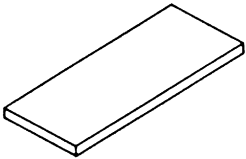
description	d	w	pattern no.	L	M/V1	V2	V3
Straight rectilinear work top 	20"	16"	QRSA161-N-() *	\$350.	\$382.	\$439.	\$593.
		102"	QRSA1021-() ()	686.	742.	853.	1,152.
		108"	QRSA1081-() ()	745.	801.	921.	1,244.
		114"	QRSA1141-() ()	804.	860.	989.	1,335.
		120"	QRSA1201-() ()	863.	919.	1,057.	1,427.
	24"	16"	QRSA162-N-() *	368.	401.	461.	623.
		102"	QRSA1022-() ()	758.	821.	944.	1,275.
		108"	QRSA1082-() ()	817.	880.	1,012.	1,366.
		114"	QRSA1142-() ()	876.	939.	1,080.	1,458.
		120"	QRSA1202-() ()	935.	998.	1,148.	1,549.
	30"	16"	QRSA163-N-() *	402.	437.	503.	678.
		102"	QRSA1023-() ()	805.	874.	1,005.	1,357.
		108"	QRSA1083-() ()	864.	933.	1,073.	1,448.
		114"	QRSA1143-() ()	923.	992.	1,141.	1,540.
		120"	QRSA1203-() ()	982.	1,051.	1,209.	1,632.
	36"	48"	QRSA484-() ()	674.	735.	845.	1,141.
		54"	QRSA544-() ()	697.	761.	875.	1,181.
		78"	QRSA784-() ()	804.	873.	1,004.	1,355.
		84"	QRSA844-() ()	863.	932.	1,072.	1,447.
		90"	QRSA904-() ()	922.	991.	1,140.	1,539.
		96"	QRSA964-() ()	981.	1,050.	1,208.	1,630.
		102"	QRSA1024-() ()	1,040.	1,109.	1,275.	1,722.
		108"	QRSA1084-() ()	1,099.	1,168.	1,343.	1,813.
		114"	QRSA1144-() ()	1,158.	1,227.	1,411.	1,905.
		120"	QRSA1204-() ()	1,217.	1,286.	1,479.	1,997.

* For creating freestanding pedestal using standard Reff pedestal. Counterweights must be ordered separately.

Order Code	Specification Information	Application Notes
Example: QRSA903RL	<i>To order please specify pattern number including:</i>	Products on this page are shipped without hardware which must be ordered separately from the support components section. 1 1/4" tops require support at mid point to reduce spans to 48" or less.
QR Reff Standard Special	1. Top thickness	
S Straight top	2. Grommet option	
A 1 1/4" thick	3. Top finish type	
90 90" wide	4. Top finish	
3 30" deep	5. Grommet finish	
R Recessed grommet location	1. <i>Thickness options:</i> A = 1 1/4"	
L Laminate finish	2. <i>Grommet options:</i> N = No grommets F = Flush front grommet location R = Recessed front (not recommended for 20"D and 24"D tops) A = Alternate location (for 36"D tops only)	
114 Folkstone grey	3. <i>Finish type:</i> L = Laminate M = Wood/laminate mixed 1 = V1 2 = V2 3 = V3	
111 Jet Black (grommet)		
	Product on this page will accept woodgrain laminate where laminate is currently an option. List price for woodgrain laminate options will be current published laminate list price plus 10%.	
	Applicable finishes are listed on page 102 and 103.	
	Knoll accepts no responsibility for special grommet locations which interfere with support or other hardware. All requests for special grommet locations must be approved through custom product development.	
	Actual widths of worksurfaces are 1/8" less than nominal dimension. Actual depth is 1/8" less.	

Reff Worksurfaces

1 1/4" thick straight rectilinear + Post

Standard Specials Systems

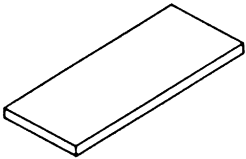
description	d	w	pattern no.	lam.	M/V1	V2	V3
Straight rectilinear work top + Post 	20"	26 1/2"	QRSAP261-()()	\$384.	\$420.	\$483.	\$652.
		32 1/2"	QRSAP321-()()	406.	443.	509.	688.
		38 1/2"	QRSAP381-()()	421.	464.	534.	720.
		44 1/2"	QRSAP441-()()	443.	480.	552.	745.
		50 1/2"	QRSAP501-()()	460.	499.	574.	775.
		56 1/2"	QRSAP561-()()	497.	540.	621.	838.
		62 1/2"	QRSAP621-()()	509.	557.	641.	865.
		68 1/2"	QRSAP681-()()	538.	586.	674.	910.
		74 1/2"	QRSAP741-()()	545.	592.	681.	919.
		80 1/2"	QRSAP801-()()	577.	634.	729.	984.
		86 1/2"	QRSAP861-()()	604.	658.	757.	1,022.
		92 1/2"	QRSAP921-()()	627.	683.	785.	1,060.
98 1/2"	QRSAP981-()()	686.	742.	853.	1,152.		
104 1/2"	QRSAP1041-()()	745.	801.	921.	1,244.		
110 1/2"	QRSAP1101-()()	804.	860.	989.	1,335.		
24"	26 1/2"	QRSAP262-()()	417.	453.	521.	703.	
	32 1/2"	QRSAP322-()()	431.	474.	545.	736.	
	38 1/2"	QRSAP382-()()	448.	487.	560.	756.	
	44 1/2"	QRSAP442-()()	476.	524.	603.	814.	
	50 1/2"	QRSAP502-()()	509.	557.	641.	865.	
	56 1/2"	QRSAP562-()()	549.	599.	689.	930.	
	62 1/2"	QRSAP622-()()	563.	617.	710.	958.	
	68 1/2"	QRSAP682-()()	591.	644.	741.	1,000.	
	74 1/2"	QRSAP742-()()	617.	675.	776.	1,048.	
	80 1/2"	QRSAP802-()()	643.	703.	808.	1,091.	
	86 1/2"	QRSAP862-()()	675.	734.	844.	1,140.	
	92 1/2"	QRSAP922-()()	699.	762.	876.	1,183.	
98 1/2"	QRSAP982-()()	758.	821.	944.	1,275.		
104 1/2"	QRSAP1042-()()	817.	880.	1,012.	1,366.		
110 1/2"	QRSAP1102-()()	876.	939.	1,080.	1,458.		
30"	26 1/2"	QRSAP263-()()	452.	492.	566.	764.	
	32 1/2"	QRSAP323-()()	485.	531.	611.	824.	
	38 1/2"	QRSAP383-()()	505.	551.	634.	855.	

Order Code

Example:	QRSAP263RL
QR	Reff Standard Special
S	Straight top
A	1 1/4" thick
P	Post
26	26 1/2" wide
3	30" deep
R	Recessed grommet location
L	Laminate finish
114	Folkstone grey
111	Jet Black (grommet)

Specification Information

To order please specify pattern number including:

- Top thickness
- Grommet option
- Top finish type
- Top finish
- Grommet finish

1. Thickness options:
A = 1 1/4"

2. Grommet options:
N = No grommets
F = Flush front grommet location
R = Recessed front (not recommended for 20"D and 24"D tops)
A = Alternate location (for 36"D tops only)

3. Finish type:
L = Laminate
M = Wood/laminate mixed
1 = V1
2 = V2
3 = V3

Application Notes

Product on this page will accept woodgrain laminate where laminate is currently an option. List price for woodgrain laminate options will be current published laminate list price plus 10%.

Applicable finishes are listed on page 102 and 103.

Knoll accepts no responsibility for special grommet locations which interfere with support or other hardware. All requests for special grommet locations must be approved through custom product development.

Actual widths of worksurfaces are 1/8" less than nominal dimension. Actual depth is 1/8" less.

Products on this page are shipped without hardware which must be ordered separately from the support components section.

1 1/4" tops require support at mid point to reduce spans to 48" or less.

Reff System

Reff Worksurfaces

1 1/4" thick straight rectilinear + Post

Standard Specials Systems

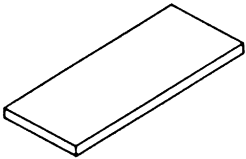
description	d	w	pattern no.	lam.	M/V1	V2	V3
Straight rectilinear work top + Post 	30"	44 1/2"	QRSAP443-()()	\$540.	\$589.	\$677.	\$914.
		50 1/2"	QRSAP503-()()	584.	637.	733.	989.
		56 1/2"	QRSAP563-()()	605.	660.	759.	1,025.
		62 1/2"	QRSAP623-()()	616.	674.	775.	1,046.
		68 1/2"	QRSAP683-()()	634.	690.	793.	1,071.
		74 1/2"	QRSAP743-()()	662.	723.	831.	1,122.
		80 1/2"	QRSAP803-()()	688.	752.	865.	1,167.
		86 1/2"	QRSAP863-()()	721.	786.	904.	1,220.
		92 1/2"	QRSAP923-()()	746.	815.	937.	1,265.
		98 1/2"	QRSAP983-()()	805.	874.	1,005.	1,357.
		104 1/2"	QRSAP1043-()()	864.	933.	1,073.	1,448.
		110 1/2"	QRSAP1103-()()	923.	992.	1,141.	1,540.

Order Code

Example:	QRSAP263RL
QR	Reff Standard Special
S	Straight top
A	1 1/4" thick
P	Post
26	26 1/2" wide
3	30" deep
R	Recessed grommet location
L	Laminate finish
114	Folkstone grey
111	Jet Black (grommet)

Specification Information

To order please specify pattern number including:

1. Top thickness
2. Grommet option
3. Top finish type
4. Top finish
5. Grommet finish

1. Thickness options:
A = 1 1/4"

2. Grommet options:
N = No grommets
F = Flush front grommet location
R = Recessed front (not recommended for 20"D and 24"D tops)
A = Alternate location (for 36"D tops only)

3. Finish type:
L = Laminate
M = Wood/laminate mixed
1 = V1
2 = V2
3 = V3

Application Notes

Product on this page will accept woodgrain laminate where laminate is currently an option. List price for woodgrain laminate options will be current published laminate list price plus 10%.

Applicable finishes are listed on page 102 and 103.

Knoll accepts no responsibility for special grommet locations which interfere with support or other hardware. All requests for special grommet locations must be approved through custom product development.

Actual widths of worksurfaces are 1/16" less than nominal dimension. Actual depth is 1/8" less.

Products on this page are shipped without hardware which must be ordered separately from the support components section.

1 1/4" tops require support at mid point to reduce spans to 48" or less.

Reff Worksurfaces

1 3/4" thick straight rectilinear

Standard Specials Systems

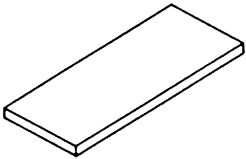
description	d	w	pattern no.	lam.	M/V1	V2	V3
Straight rectilinear work top 	20"	16"	QRSB161-N-()*	\$455.	\$660.	\$759.	\$1,025.
		102"	QRSB1021-()()	900.	1,277.	1,469.	1,983.
		108"	QRSB1081-()()	959.	1,336.	1,536.	2,074.
		114"	QRSB1141-()()	1,018.	1,395.	1,604.	2,166.
		120"	QRSB1201-()()	1,077.	1,454.	1,672.	2,257.
	24"	16"	QRSB162-N-()*	476.	691.	795.	1,073.
		102"	QRSB1022-()()	950.	1,351.	1,554.	2,097.
		108"	QRSB1082-()()	1,009.	1,410.	1,621.	2,189.
		114"	QRSB1142-()()	1,068.	1,469.	1,689.	2,281.
		120"	QRSB1202-()()	1,127.	1,528.	1,757.	2,372.
	30"	16"	QRSB163-N-()*	569.	827.	951.	1,284.
		102"	QRSB1023-()()	995.	1,420.	1,633.	2,205.
		108"	QRSB1083-()()	1,054.	1,479.	1,701.	2,296.
		114"	QRSB1143-()()	1,113.	1,538.	1,769.	2,388.
		120"	QRSB1203-()()	1,172.	1,597.	1,837.	2,479.
	36"	48"	QRSB484-()()	794.	1,154.	1,327.	1,792.
		54"	QRSB544-()()	818.	1,186.	1,364.	1,841.
		78"	QRSB784-()()	964.	1,370.	1,575.	2,127.
		84"	QRSB844-()()	1,023.	1,429.	1,643.	2,219.
		90"	QRSB904-()()	1,082.	1,488.	1,711.	2,310.
96"		QRSB964-()()	1,141.	1,547.	1,779.	2,402.	
102"		QRSB1024-()()	1,200.	1,606.	1,847.	2,493.	
108"		QRSB1084-()()	1,259.	1,665.	1,915.	2,585.	
114"		QRSB1144-()()	1,318.	1,724.	1,983.	2,677.	
120"		QRSB1204-()()	1,377.	1,783.	2,050.	2,768.	

* For creating freestanding pedestal using standard Reff pedestal. Counterweights must be ordered separately.

Order Code

Example:	QRSB903RL
QR	Reff Standard Special
S	Straight top
B	1 3/4" thick
90	90" wide
3	30" deep
R	Recessed grommet location
L	Laminate finish
114	Folkstone grey
111	Jet Black (grommet)

To order please specify pattern number including:

1. Top thickness
 2. Grommet option
 3. Top finish type
 4. Top finish
 5. Grommet finish
1. Thickness options:
B = 1 3/4"
2. Grommet options:
N = No grommets
F = Flush front grommet location
R = Recessed front (not recommended for 20"D and 24"D tops)

3. Finish type:
L = Laminate
M = Wood/laminate mixed
1 = V1
2 = V2
3 = V3

Applicable finishes are listed on page 102 and 103.

Knoll accepts no responsibility for special grommet locations which interfere with support or other hardware. All requests for special grommet locations must be approved through custom product development.

Actual widths of worksurfaces are 1/16" less than nominal dimension. Actual depth is 1/8" less.

1 3/4" thick laminate option is double post formed front and back, all others are edgebanded.

Products on this page are shipped without hardware which must be ordered separately from the support components section in standard Reff price list.

1 3/4" tops require support at mid point to reduce spans to 66" or less.

Mixed finish 1 3/4" tops are not post-formed.

Reff Worksurfaces

1 3/4" thick straight rectilinear + Post

Standard Specials Systems

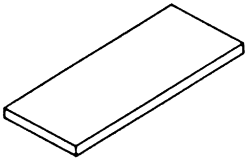
description	d	w	pattern no.	lam.	M/V1	V2	V3
Straight rectilinear work top + Post 	20"	26 1/2"	QRSBP261-()()	\$472.	\$687.	\$790.	\$1,067.
		32 1/2"	QRSBP321-()()	499.	721.	829.	1,119.
		38 1/2"	QRSBP381-()()	539.	781.	898.	1,213.
		44 1/2"	QRSBP441-()()	577.	839.	965.	1,303.
		50 1/2"	QRSBP501-()()	608.	879.	1,011.	1,365.
		56 1/2"	QRSBP561-()()	637.	924.	1,063.	1,435.
		62 1/2"	QRSBP621-()()	664.	968.	1,113.	1,503.
		68 1/2"	QRSBP681-()()	693.	1,005.	1,156.	1,560.
		74 1/2"	QRSBP741-()()	729.	1,057.	1,216.	1,641.
		80 1/2"	QRSBP801-()()	767.	1,113.	1,280.	1,728.
		86 1/2"	QRSBP861-()()	800.	1,166.	1,341.	1,810.
		92 1/2"	QRSBP921-()()	841.	1,218.	1,401.	1,891.
		98 1/2"	QRSBP981-()()	900.	1,277.	1,469.	1,983.
		104 1/2"	QRSBP1041-()()	959.	1,336.	1,536.	2,074.
		110 1/2"	QRSBP1101-()()	1,018.	1,395.	1,604.	2,166.
24"	26 1/2"	QRSBP262-()()	523.	758.	872.	1,177.	
	32 1/2"	QRSBP322-()()	546.	793.	912.	1,231.	
	38 1/2"	QRSBP382-()()	586.	854.	982.	1,326.	
	44 1/2"	QRSBP442-()()	627.	909.	1,045.	1,411.	
	50 1/2"	QRSBP502-()()	655.	950.	1,093.	1,475.	
	56 1/2"	QRSBP562-()()	684.	991.	1,140.	1,539.	
	62 1/2"	QRSBP622-()()	714.	1,035.	1,190.	1,607.	
	68 1/2"	QRSBP682-()()	741.	1,075.	1,236.	1,669.	
	74 1/2"	QRSBP742-()()	779.	1,128.	1,297.	1,751.	
	80 1/2"	QRSBP802-()()	815.	1,182.	1,359.	1,835.	
	86 1/2"	QRSBP862-()()	852.	1,239.	1,425.	1,924.	
	92 1/2"	QRSBP922-()()	891.	1,292.	1,486.	2,006.	
	98 1/2"	QRSBP982-()()	950.	1,351.	1,554.	2,097.	
	104 1/2"	QRSBP1042-()()	1,009.	1,410.	1,621.	2,189.	
	110 1/2"	QRSBP1102-()()	1,068.	1,469.	1,689.	2,281.	
30"	26 1/2"	QRSBP263-()()	588.	856.	984.	1,329.	
	32 1/2"	QRSBP323-()()	611.	887.	1,020.	1,377.	
	38 1/2"	QRSBP383-()()	643.	935.	1,075.	1,452.	

Order Code

Example:	QRSBP503RL
QR	Reff Standare Special
S	Straight top
B	1 3/4" thick
P	Post
50	24" wide
3	30" deep
R	Recessed grommet location
L	Laminate finish
114	Folkstone grey
111	Jet Black (grommet)

Specification Information

To order please specify pattern number including:

1. Top thickness
2. Grommet option
3. Top finish type
4. Top finish
5. Grommet finish

1. Thickness options:
B = 1 3/4"

2. Grommet options:
N = No grommets
F = Flush front grommet location
R = Recessed front (not recommended for 20"D and 24"D tops)

3. Finish type:
L = Laminate
M = Wood/laminate mixed
1 = V1
2 = V2
3 = V3

Applicable finishes are listed on page 102 and 103.

Knoll accepts no responsibility for special grommet locations which interfere with support or other hardware. All requests for special grommet locations must be approved through custom product development.

Actual widths of worksurfaces are 1/16" less than nominal dimension. Actual depth is 1/8" less.

Application Notes

1 3/4" thick laminate option is double post formed front and back, all others are edgebanded.

Products on this page are shipped without hardware which must be ordered separately from the support components section in standard Reff price list.

1 3/4" tops require support at mid point to reduce spans to 66" or less.

Mixed finish 1 3/4" tops are not post-formed.

Reff Worksurfaces

1 3/4" thick straight rectilinear + Post

Standard Specials Systems

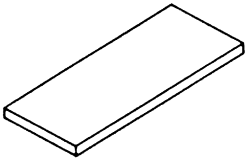
description	d	w	pattern no.	lam.	M/V1	V2	V3
Straight rectilinear work top + Post 	30"	44 1/2"	QRSBP443-()()	\$676.	\$978.	\$1,125.	\$1,518.
		50 1/2"	QRSBP503-()()	707.	1,022.	1,175.	1,587.
		56 1/2"	QRSBP563-()()	730.	1,058.	1,217.	1,643.
		62 1/2"	QRSBP623-()()	760.	1,103.	1,268.	1,712.
		68 1/2"	QRSBP683-()()	789.	1,143.	1,314.	1,775.
		74 1/2"	QRSBP743-()()	826.	1,199.	1,379.	1,861.
		80 1/2"	QRSBP803-()()	865.	1,254.	1,442.	1,947.
		86 1/2"	QRSBP863-()()	899.	1,306.	1,502.	2,028.
		92 1/2"	QRSBP923-()()	936.	1,361.	1,565.	2,113.
		98 1/2"	QRSBP983-()()	995.	1,420.	1,633.	2,205.
		104 1/2"	QRSBP1043-()()	1,054.	1,479.	1,701.	2,296.
		110 1/2"	QRSBP1103-()()	1,113.	1,538.	1,769.	2,388.

Reff System

Order Code

Example:	QRSBP503RL
QR	Reff Standare Special
S	Straight top
B	1 3/4" thick
P	Post
50	24" wide
3	30" deep
R	Recessed grommet location
L	Laminate finish
114	Folkstone grey
111	Jet Black (grommet)

Specification Information

To order please specify pattern number including:

1. Top thickness
2. Grommet option
3. Top finish type
4. Top finish
5. Grommet finish

1. Thickness options:
B = 1 3/4"

2. Grommet options:
N = No grommets
F = Flush front grommet location
R = Recessed front (not recommended for 20"D and 24"D tops)

3. Finish type:
L = Laminate
M = Wood/laminate mixed
1 = V1
2 = V2
3 = V3

Applicable finishes are listed on page 102 and 103.

Knoll accepts no responsibility for special grommet locations which interfere with support or other hardware. All requests for special grommet locations must be approved through custom product development.

Actual widths of worksurfaces are 1/16" less than nominal dimension. Actual depth is 1/8" less.

Application Notes

1 3/4" thick laminate option is double post formed front and back, all others are edgebanded.

Products on this page are shipped without hardware which must be ordered separately from the support components section in standard Reff price list.

1 3/4" tops require support at mid point to reduce spans to 66" or less.

Mixed finish 1 3/4" tops are not post-formed.

Reff Worksurfaces
for calibre file
1 1/4" thick

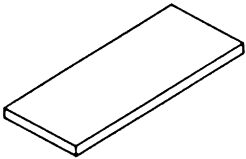
description	d	w	pattern no.	lam.	M/V1	V2	V3
File top, 1 1/4" thick 	18"	30"	QRSAC3018-()()	\$384.	\$420.	\$483.	\$652.
		36"	QRSAC3618-()()	406.	443.	509.	688.
		42"	QRSAC4218-()()	421.	464.	534.	720.
		48"	QRSAC4818-()()	443.	480.	552.	745.
		54"	QRSAC5418-()()	460.	499.	574.	775.
		60"	QRSAC6018-()()	497.	540.	621.	838.
		66"	QRSAC6618-()()	510.	557.	641.	865.
		72"	QRSAC7218-()()	538.	586.	674.	910.
		78"	QRSAC7818-()()	549.	592.	681.	919.
		84"	QRSAC8418-()()	577.	634.	729.	984.
		90"	QRSAC9018-()()	604.	658.	757.	1,022.
		96"	QRSAC9618-()()	627.	683.	785.	1,060.
		102"	QRSAC10218-()()	686.	742.	853.	1,152.
		108"	QRSAC10818-()()	745.	801.	921.	1,244.
	36"	36"	QRSAC3636-()()	627.	683.	785.	1,060.
		42"	QRSAC4236-()()	650.	709.	815.	1,101.
		54"	QRSAC5436-()()	674.	735.	845.	1,141.
		60"	QRSAC6036-()()	697.	761.	875.	1,181.
		66"	QRSAC6636-()()	721.	787.	905.	1,222.
		72"	QRSAC7236-()()	745.	814.	936.	1,264.
		78"	QRSAC7836-()()	804.	873.	1,004.	1,355.
		84"	QRSAC8436-()()	863.	932.	1,072.	1,447.
		90"	QRSAC9036-()()	922.	991.	1,140.	1,539.

Order Code

Example: QRSAC3018
QR Reff Standard Special
S Straight top
A 1 1/4" thick
C For calibre file
30 30" wide
18 18" deep
L Laminate finish
114 Folkstone grey

Specification Information

To order please specify pattern number including:

1. Top thickness
2. Top finish type
3. Top finish

1. Thickness options:
A = 1 1/4"
B = 1 3/4"

3. Finish type:
L = Laminate
M = Wood/laminate mixed
1 = V1
2 = V2
3 = V3

Application Notes

Product on this page will accept woodgrain laminate where laminate is currently an option.
List price for woodgrain laminate options will be current published laminate list price plus 10%.

Applicable finishes are listed on page 102 and 103.

1 3/4" thick laminate option is double post formed front and back, all others are edgebanded.

Products on this page are exact width and depth and have no grommet or drilling.

Mixed finish 1 3/4" tops are not post-formed.

Reff Worksurfaces
for calibre file
1 3/4" thick

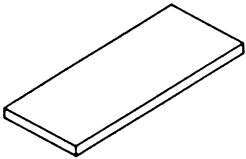
description	d	w	pattern no.	lam.	M/V1	V2	V3
File top, 1 3/4" thick 	18"	30"	QRSBC3018-()()	\$472.	\$687.	\$790.	\$1,067.
		36"	QRSBC3618-()()	499.	721.	829.	1,119.
		42"	QRSBC4218-()()	539.	781.	898.	1,213.
		48"	QRSBC4818-()()	577.	839.	965.	1,303.
		54"	QRSBC5418-()()	608.	879.	1,011.	1,365.
		60"	QRSBC6018-()()	637.	924.	1,063.	1,435.
		66"	QRSBC6618-()()	664.	968.	1,113.	1,503.
		72"	QRSBC7218-()()	693.	1,005.	1,156.	1,560.
		78"	QRSBC7818-()()	729.	1,057.	1,216.	1,641.
		84"	QRSBC8418-()()	767.	1,113.	1,280.	1,728.
		90"	QRSBC9018-()()	800.	1,166.	1,341.	1,810.
		96"	QRSBC9618-()()	841.	1,218.	1,401.	1,891.
		102"	QRSBC10218-()()	900.	1,277.	1,469.	1,983.
		108"	QRSBC10818-()()	959.	1,336.	1,536.	2,074.
	36"	36"	QRSBC3636-()()	747.	1,090.	1,254.	1,692.
		42"	QRSBC4236-()()	771.	1,122.	1,290.	1,742.
		54"	QRSBC5436-()()	794.	1,154.	1,327.	1,792.
		60"	QRSBC6036-()()	818.	1,186.	1,364.	1,841.
		66"	QRSBC6636-()()	841.	1,218.	1,401.	1,891.
		72"	QRSBC7236-()()	905.	1,311.	1,508.	2,035.
		78"	QRSBC7836-()()	964.	1,370.	1,575.	2,127.
		84"	QRSBC8436-()()	1,023.	1,429.	1,643.	2,219.
		90"	QRSBC9036-()()	1,082.	1,488.	1,711.	2,310.

Order Code	Specification Information	Application Notes
Example: QRSBC3018	<i>To order please specify pattern number including:</i>	1 3/4" thick laminate option is double post formed front and back, all others are edgebanded.
QR Reff Standard Special	1. Top thickness	Products on this page are exact width and depth and have no grommet or drilling.
S Straight top	2. Top finish type	Mixed finish 1 3/4" tops are not post-formed.
B 1 3/4" thick	3. Top finish	
C For calibre file	<i>1. Thickness options:</i>	
30 30" wide	A = 1 1/4"	
18 18" deep	B = 1 3/4"	
L Laminate finish	<i>3. Finish type:</i>	
114 Folkstone grey	L = Laminate	
	M = Wood/laminate mixed	
	1 = V1	
	2 = V2	
	3 = V3	

Applicable finishes are listed on page 102 and 103.

1 1/4" thick extended curvilinear corner tops

Left hand

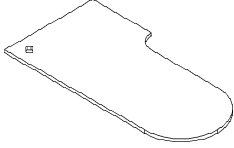
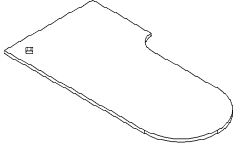
description	w	d	pattern no.	lam.	M/V1	V2	V3
Extended corner worktop, LH 24" deep return, 30" deep rounded 	36"	60"	QRCCDLA23660 () () ()	\$1,909.	\$2,533.	\$2,913.	\$3,932.
		66"	QRCCDLA23666 () () ()	1,988.	2,638.	3,034.	4,095.
		90"	QRCCDLA23690 () () ()	2,237.	2,968.	3,413.	4,608.
	42"	60"	QRCCDLA24260 () () ()	2,125.	2,780.	3,197.	4,316.
		66"	QRCCDLA24266 () () ()	2,165.	2,833.	3,258.	4,398.
		72"	QRCCDLA24272 () () ()	2,205.	2,886.	3,319.	4,481.
		78"	QRCCDLA24278 () () ()	2,244.	2,938.	3,379.	4,561.
		84"	QRCCDLA24284 () () ()	2,327.	3,049.	3,506.	4,734.
		90"	QRCCDLA24290 () () ()	2,371.	3,106.	3,572.	4,822.
		96"	QRCCDLA24296 () () ()	2,414.	3,162.	3,636.	4,909.
	48"	60"	QRCCDLA24860 () () ()	2,302.	2,975.	3,421.	4,619.
		66"	QRCCDLA24866 () () ()	2,342.	3,028.	3,482.	4,701.
		72"	QRCCDLA24872 () () ()	2,382.	3,081.	3,543.	4,783.
		78"	QRCCDLA24878 () () ()	2,421.	3,133.	3,603.	4,864.
		84"	QRCCDLA24884 () () ()	2,504.	3,244.	3,731.	5,036.
		90"	QRCCDLA24890 () () ()	2,548.	3,300.	3,795.	5,123.
		96"	QRCCDLA24896 () () ()	2,591.	3,357.	3,861.	5,212.
	Extended corner worktop, LH 30" deep return, 30" deep rounded 	36"	60"	QRCCDLA33660 () () ()	1,909.	2,533.	2,913.
66"			QRCCDLA33666 () () ()	1,988.	2,638.	3,034.	4,095.
90"			QRCCDLA33690 () () ()	2,237.	2,968.	3,413.	4,608.
42"		60"	QRCCDLA34260 () () ()	2,125.	2,780.	3,197.	4,316.
		66"	QRCCDLA34266 () () ()	2,165.	2,833.	3,258.	4,398.
		72"	QRCCDLA34272 () () ()	2,205.	2,886.	3,319.	4,481.
		78"	QRCCDLA34278 () () ()	2,244.	2,938.	3,379.	4,561.
		84"	QRCCDLA34284 () () ()	2,327.	3,049.	3,506.	4,734.
		90"	QRCCDLA34290 () () ()	2,371.	3,106.	3,572.	4,822.
		96"	QRCCDLA34296 () () ()	2,414.	3,162.	3,636.	4,909.
48"		60"	QRCCDLA34860 () () ()	2,302.	2,975.	3,421.	4,619.
		66"	QRCCDLA34866 () () ()	2,342.	3,028.	3,482.	4,701.
		72"	QRCCDLA34872 () () ()	2,382.	3,081.	3,543.	4,783.
		78"	QRCCDLA34878 () () ()	2,421.	3,133.	3,603.	4,864.
		84"	QRCCDLA34884 () () ()	2,504.	3,244.	3,731.	5,036.
		90"	QRCCDLA34890 () () ()	2,548.	3,300.	3,795.	5,123.
		96"	QRCCDLA34896 () () ()	2,591.	3,357.	3,861.	5,212.

Order Code

Specification Information

Example:	QRCCDLA23660N2
QR	Reff Standard Special
CC	Curved corner
D	D top
L	Left Hand
A	1 1/4" thick
2	24" return
36	36" d at straight edge of corner, 30" across "D"
60	60" wide
N	No grommet
2	V2 finish
V319	Medium Cherry

To order please specify pattern number including:

1. Depth
2. Grommet option
3. Finish type
4. Finish
5. Grommet finish

2. Grommet options:
 N = No grommets
 F = Flush front grommet location

3. Finish type:
 L = Laminate
 M = Mixed (laminated surface with wood edge)
 1 = V1
 2 = V2
 3 = V3

Product on this page will accept woodgrain laminate where laminate is currently an option.
 List price for woodgrain laminate options will be current published laminate list price plus 10%.
 Applicable finishes are listed on page 102 and 103.

Reff Worksurfaces

1 1/4" thick extended curvilinear corner tops

right hand

Standard Specials Systems

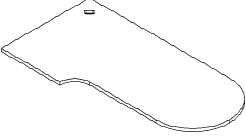
description	w	d	pattern no.	lam.	M/V1	V2	V3
Extended corner worktop, RH 24" deep return, 30" deep rounded 	36"	60"	QRCCDRA23660 () () ()	\$1,909.	\$2,533.	\$2,913.	\$3,932.
		66"	QRCCDRA23666 () () ()	1,988.	2,638.	3,034.	4,095.
		90"	QRCCDRA23690 () () ()	2,237.	2,968.	3,413.	4,608.
	42"	60"	QRCCDRA24260 () () ()	2,125.	2,780.	3,197.	4,316.
		66"	QRCCDRA24266 () () ()	2,165.	2,833.	3,258.	4,398.
		72"	QRCCDRA24272 () () ()	2,205.	2,886.	3,319.	4,481.
		78"	QRCCDRA24278 () () ()	2,244.	2,938.	3,379.	4,561.
		84"	QRCCDRA24284 () () ()	2,327.	3,049.	3,506.	4,734.
		90"	QRCCDRA24290 () () ()	2,371.	3,106.	3,572.	4,822.
		96"	QRCCDRA24296 () () ()	2,414.	3,162.	3,636.	4,909.
	48"	60"	QRCCDRA24860 () () ()	2,302.	2,975.	3,421.	4,619.
		66"	QRCCDRA24866 () () ()	2,342.	3,028.	3,482.	4,701.
		72"	QRCCDRA24872 () () ()	2,382.	3,081.	3,543.	4,783.
		78"	QRCCDRA24878 () () ()	2,421.	3,133.	3,603.	4,864.
		84"	QRCCDRA24884 () () ()	2,504.	3,244.	3,731.	5,036.
		90"	QRCCDRA24890 () () ()	2,548.	3,300.	3,795.	5,123.
		96"	QRCCDRA24896 () () ()	2,591.	3,357.	3,861.	5,212.
	Extended corner worktop, RH 30" deep return, 30" deep rounded 	36"	60"	QRCCDRA33660 () () ()	1,909.	2,533.	2,913.
66"			QRCCDRA33666 () () ()	1,988.	2,638.	3,034.	4,095.
90"			QRCCDRA33690 () () ()	2,237.	2,968.	3,413.	4,608.
42"		60"	QRCCDRA34260 () () ()	2,125.	2,780.	3,197.	4,316.
		66"	QRCCDRA34266 () () ()	2,165.	2,833.	3,258.	4,398.
		72"	QRCCDRA34272 () () ()	2,205.	2,886.	3,319.	4,481.
		78"	QRCCDRA34278 () () ()	2,244.	2,938.	3,379.	4,561.
		84"	QRCCDRA34284 () () ()	2,327.	3,049.	3,506.	4,734.
		90"	QRCCDRA34290 () () ()	2,371.	3,106.	3,572.	4,822.
		96"	QRCCDRA34296 () () ()	2,414.	3,162.	3,636.	4,909.
48"		60"	QRCCDRA34860 () () ()	2,302.	2,975.	3,421.	4,619.
		66"	QRCCDRA34866 () () ()	2,342.	3,028.	3,482.	4,701.
		72"	QRCCDRA34872 () () ()	2,382.	3,081.	3,543.	4,783.
		78"	QRCCDRA34878 () () ()	2,421.	3,133.	3,603.	4,864.
		84"	QRCCDRA34884 () () ()	2,504.	3,244.	3,731.	5,036.
		90"	QRCCDRA34890 () () ()	2,548.	3,300.	3,795.	5,123.
		96"	QRCCDRA34896 () () ()	2,591.	3,357.	3,861.	5,212.

Reff System

Order Code

Example:	QRCCDRA23660N2
QR	Reff Standard Special
CC	Curved corner
D	D top
R	Right Hand
A	1 1/4" thick
2	24" return
36	36" d at straight edge of corner, 30" across "D"
60	60" wide
N	No grommet
2	V2 finish
V319	Medium Cherry

Specification Information

To order please specify pattern number including:

1. Depth
2. Grommet option
3. Finish type
4. Finish
5. Grommet finish

2. Grommet options:
 N = No grommets
 F = Flush front grommet location

3. Finish type:
 L = Laminate
 M = Mixed (laminated surface with wood edge)
 1 = V1
 2 = V2
 3 = V3

Product on this page will accept woodgrain laminate where laminate is currently an option. List price for woodgrain laminate options will be current published laminate list price plus 10%.

Applicable finishes are listed on page 102 and 103.

Reff Worksurfaces
 1 1/4" thick extended straight corner tops
 left and right hand

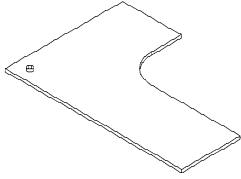
description	d	w	pattern no.	lam.	M/V1	V2	V3
Extended straight corner top, LH curved front corner 12" radius 24" deep return 	54"	36"	QRCEAL223654 () () ()	\$736.	\$1,087.	\$1,250.	\$1,688.
	54"	42"	QRCEAL224254 () () ()	809.	1,200.	1,380.	1,863.
	60"	48"	QRCEAL224860 () () ()	958.	1,434.	1,649.	2,226.
	66"	36"	QRCEAL223666 () () ()	883.	1,318.	1,516.	2,046.
	66"	42"	QRCEAL224266 () () ()	957.	1,434.	1,649.	2,226.
	66"	48"	QRCEAL224866 () () ()	1,031.	1,549.	1,781.	2,405.
	78"	36"	QRCEAL223678 () () ()	942.	1,454.	1,672.	2,257.
	78"	42"	QRCEAL224278 () () ()	1,016.	1,569.	1,804.	2,436.
	78"	48"	QRCEAL224878 () () ()	1,178.	1,781.	2,048.	2,765.
	84"	36"	QRCEAL223684 () () ()	1,001.	1,589.	1,827.	2,467.
	84"	42"	QRCEAL224284 () () ()	1,075.	1,705.	1,961.	2,647.
	90"	36"	QRCEAL223690 () () ()	1,060.	1,725.	1,984.	2,678.
	90"	42"	QRCEAL224290 () () ()	1,134.	1,841.	2,117.	2,858.
	90"	48"	QRCEAL224890 () () ()	1,353.	2,052.	2,360.	3,186.
	96"	36"	QRCEAL223696 () () ()	1,119.	1,861.	2,140.	2,889.
	96"	42"	QRCEAL224296 () () ()	1,193.	1,977.	2,274.	3,069.

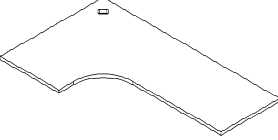
Extended straight corner top, RH curved front corner 12" radius 24" deep return 	54"	36"	QRCEAR223654 () () ()	736.	1,087.	1,250.	1,688.
	54"	42"	QRCEAR224254 () () ()	809.	1,200.	1,380.	1,863.
	60"	48"	QRCEAR224860 () () ()	958.	1,434.	1,649.	2,226.
	66"	36"	QRCEAR223666 () () ()	883.	1,318.	1,516.	2,046.
	66"	42"	QRCEAR224266 () () ()	957.	1,434.	1,649.	2,226.
	66"	48"	QRCEAR224866 () () ()	1,031.	1,549.	1,781.	2,405.
	78"	36"	QRCEAR223678 () () ()	942.	1,454.	1,672.	2,257.
	78"	42"	QRCEAR224278 () () ()	1,016.	1,569.	1,804.	2,436.
	78"	48"	QRCEAR224878 () () ()	1,178.	1,781.	2,048.	2,765.
	84"	36"	QRCEAR223684 () () ()	1,001.	1,589.	1,827.	2,467.
	84"	42"	QRCEAR224284 () () ()	1,075.	1,705.	1,961.	2,647.
	90"	36"	QRCEAR223690 () () ()	1,060.	1,725.	1,984.	2,678.
	90"	42"	QRCEAR224290 () () ()	1,134.	1,841.	2,117.	2,858.
	90"	48"	QRCEAR224890 () () ()	1,353.	2,052.	2,360.	3,186.
	96"	36"	QRCEAR223696 () () ()	1,119.	1,861.	2,140.	2,889.
	96"	42"	QRCEAR224296 () () ()	1,193.	1,977.	2,274.	3,069.

Order Code

Example:	QRCEAL223654N2
QR	Reff Standard Special
C	Corner
E	Extended
A	1 1/4" thick
L	Left Hand
22	24" returns
36	36" d at corner straight edge
54	54" wide
N	No grommet
2	V2 finish
V319	Medium Cherry

Specification Information

To order please specify pattern number including:

1. Return left hand depth
2. Return right hand depth
3. Width
4. Depth
5. Grommet option
6. Finish type
7. Finish
8. Grommet finish

5. Grommet options:

- N = No grommets
- F = Flush front grommet location

6. Finish type:

- L = Laminate
- M = Mixed (laminated surface with wood edge)
- 1 = V1
- 2 = V2
- 3 = V3

Product on this page will accept woodgrain laminate where laminate is currently an option.

List price for woodgrain laminate options will be current published laminate list price plus 10%.

Applicable finishes are listed on page 102 and 103.

Meeting tops

1 1/4" thick

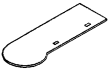
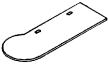
description	w	d	pattern no.	lam.	M/V1	V2	V3
 <p>Worksurface 9-top</p> <p>42" diameter</p>	54"	30"	QRMA9A5430 N () () ()	\$1,679.	\$1,823.	\$2,096.	\$2,830.
	54"	36"	QRMA9A5436 N () () ()	1,679.	1,823.	2,096.	2,830.
	60"	30"	QRMA9A6030 N () () ()	1,703.	1,849.	2,126.	2,871.
	60"	36"	QRMA9A6036 N () () ()	1,703.	1,849.	2,126.	2,871.
	66"	30"	QRMA9A6630 () () () ()	1,726.	1,875.	2,156.	2,911.
	66"	36"	QRMA9A6636 () () () ()	1,726.	1,875.	2,156.	2,911.
	72"	30"	QRMA9A7230 () () () ()	1,750.	1,901.	2,186.	2,951.
	72"	36"	QRMA9A7236 () () () ()	1,750.	1,901.	2,186.	2,951.
	78"	30"	QRMA9A7830 () () () ()	1,774.	1,927.	2,216.	2,992.
	78"	36"	QRMA9A7836 () () () ()	1,774.	1,927.	2,216.	2,992.
	84"	36"	QRMA9A8436 () () () ()	1,823.	1,985.	2,283.	3,082.
	96"	36"	QRMA9A9636 () () () ()	1,847.	2,011.	2,313.	3,122.
 <p>Worksurface P-top</p> <p>42" diameter</p>	54"	30"	QRMPA5430 N () () ()	1,679.	1,823.	2,096.	2,830.
	54"	36"	QRMPA5436 N () () ()	1,679.	1,823.	2,096.	2,830.
	60"	30"	QRMPA6030 N () () ()	1,703.	1,849.	2,126.	2,871.
	60"	36"	QRMPA6036 N () () ()	1,703.	1,849.	2,126.	2,871.
	66"	30"	QRMPA6630 () () () ()	1,726.	1,875.	2,156.	2,911.
	66"	36"	QRMPA6636 () () () ()	1,726.	1,875.	2,156.	2,911.
	72"	30"	QRMPA7230 () () () ()	1,750.	1,901.	2,186.	2,951.
	72"	36"	QRMPA7236 () () () ()	1,750.	1,901.	2,186.	2,951.
	78"	30"	QRMPA7830 () () () ()	1,774.	1,927.	2,216.	2,992.
	78"	36"	QRMPA7836 () () () ()	1,774.	1,927.	2,216.	2,992.
	84"	36"	QRMPA8436 () () () ()	1,823.	1,985.	2,283.	3,082.
	96"	36"	QRMPA9636 () () () ()	1,847.	2,011.	2,313.	3,122.

Order Code	Specification Information	Application Information
Example: QRMPA5430N1	<i>To order please specify pattern number including:</i>	Actual widths of worksurface are 1/16" less than nominal dimension. Actual depth is 1/8" less than nominal dimension.
QR Reff Standard Special	1. Top thickness	Product on this page will accept woodgrain laminate where laminate is currently an option.
M9 Meeting 9-top	2. Width	List price for woodgrain laminate options will be current published laminate list price plus 10%.
A 1 1/4" thick	3. Depth	Applicable finishes are listed on page 102 and 103.
54 54" wide	4. Grommet option	See Planning Guide for standard grommet locations.
30 30" deep	5. Top finish type	Knoll assumes no responsibility for special grommet locations which interfere with support or other hardware.
N No grommet	6. Top finish	
1 V1	7. Grommet finish	
Y311 Beech	<i>1. Thickness options:</i> A = 1 1/4" B = 1 3/4" <i>4. Grommet options:</i> N = No grommet F = Flush front grommet location R = Recessed grommet location <i>5. Finish type:</i> L = Laminate M = Wood/laminate mixed 1 = V1 2 = V2 3 = V3	Refer to Planning Guide for modesty panel size requirements and all other support options. 1 3/4" laminate tops on this page are edge banded to match post-formed contours. Products on this page are shipped without hardware which must be ordered separately from the support components section in standard Reff price list. 1 1/4" tops require support at mid point to reduce 48" spans or less. 1 3/4" tops require support at mid point to reduce spans to 66" or less. Mixed finish 1 3/4" tops are not post-formed.

Meeting tops

1 3/4" thick

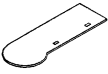
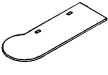
description	w	d	pattern no.	lam.	M/V1	V2	V3
 <p>42" diameter</p>	54"	30"	QRM9B5430 N () () ()	\$1,857.	\$2,274.	\$2,615.	\$3,530.
	54"	36"	QRM9B5436 N () () ()	1,857.	2,274.	2,615.	3,530.
	60"	30"	QRM9B6030 N () () ()	1,881.	2,300.	2,645.	3,571.
	60"	36"	QRM9B6036 N () () ()	1,881.	2,300.	2,645.	3,571.
	66"	30"	QRM9B6630 () () () ()	1,905.	2,326.	2,675.	3,611.
	66"	36"	QRM9B6636 () () () ()	1,905.	2,326.	2,675.	3,611.
	72"	30"	QRM9B7230 () () () ()	1,928.	2,352.	2,705.	3,651.
	72"	36"	QRM9B7236 () () () ()	1,928.	2,352.	2,705.	3,651.
	78"	30"	QRM9B7830 () () () ()	1,952.	2,378.	2,735.	3,692.
	78"	36"	QRM9B7836 () () () ()	1,952.	2,378.	2,735.	3,692.
	84"	36"	QRM9B8436 () () () ()	2,007.	2,451.	2,819.	3,805.
	96"	36"	QRM9B9636 () () () ()	2,031.	2,477.	2,849.	3,846.
 <p>42" diameter</p>	54"	30"	QRMPB5430 N () () ()	1,857.	2,274.	2,615.	3,530.
	54"	36"	QRMPB5436 N () () ()	1,857.	2,274.	2,615.	3,530.
	60"	30"	QRMPB6030 N () () ()	1,881.	2,300.	2,645.	3,571.
	60"	36"	QRMPB6036 N () () ()	1,881.	2,300.	2,645.	3,571.
	66"	30"	QRMPB6630 () () () ()	1,905.	2,326.	2,675.	3,611.
	66"	36"	QRMPB6636 () () () ()	1,905.	2,326.	2,675.	3,611.
	72"	30"	QRMPB7230 () () () ()	1,928.	2,352.	2,705.	3,651.
	72"	36"	QRMPB7236 () () () ()	1,928.	2,352.	2,705.	3,651.
	78"	30"	QRMPB7830 () () () ()	1,952.	2,378.	2,735.	3,692.
	78"	36"	QRMPB7836 () () () ()	2,031.	2,477.	2,849.	3,846.
	84"	36"	QRMPB8436 () () () ()	1,952.	2,378.	2,735.	3,692.
	96"	36"	QRMPB9636 () () () ()	2,007.	2,451.	2,819.	3,805.

Order Code	Specification Information	Application Notes
<p>Example: QRMPB5430N1</p> <p>QR Reff Standard Special</p> <p>MP Meeting P-top</p> <p>B 1 3/4" thick</p> <p>54 54" wide</p> <p>30 30" deep</p> <p>N No grommet</p> <p>1 V1</p> <p>Y311 Beech</p>	<p>To order please specify pattern number including:</p> <ol style="list-style-type: none"> Top thickness Width Depth Grommet option Top finish type Top finish Grommet finish <p>1. Thickness options: A = 1 1/4" B = 1 3/4"</p> <p>4. Grommet options: N = No grommet F = Flush front grommet location R = Recessed grommet location</p> <p>5. Finish type: L = Laminate M = Wood/laminate mixed 1 = V1 2 = V2 3 = V3</p>	<p>Actual widths of worksurface are 1/16" less than nominal dimension. Actual depth is 1/8" less than nominal dimension.</p> <p>Additional spec option required for wrap around panel tops; specify mating trim profile. A = Flat B = Square C = Bullnose E = Extruded Aluminum</p> <p>Applicable finishes are listed on page 102 and 103.</p> <p>See Planning Guide for standard grommet locations.</p> <p>Knoll assumes no responsibility for special grommet locations which interfere with support or other hardware.</p> <p>Refer to Planning Guide for modesty panel size requirements and all other support options.</p> <p>1 3/4" laminate tops on this page are edge banded to match post-formed contours.</p> <p>Products on this page are shipped without hardware which must be ordered separately from the support components section.</p> <p>1 3/4" tops require support at mid point to reduce 48" spans or less.</p> <p>1 3/4" tops require support at mid point to reduce spans to 66" or less.</p> <p>Mixed finish 1 3/4" tops are not post-formed.</p>

Reff Worksurfaces

straight front corner tops

Standard Specials Systems

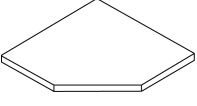
description	Return d	d	Back w	w	pattern no.	lam.	M/V1	V2	V3
1 1/4" thick corner worksurface straight front corners 	24"	30"	36"	36"	QRKA 363623-()()	\$818.	\$917.	\$1,055.	\$1,424.
	24"	30"	36"	42"	QRKA 364223-()()	859.	968.	1,113.	1,503.
	24"	30"	42"	36"	QRKA 423623-()()	859.	968.	1,113.	1,503.
	24"	30"	42"	42"	QRKA 424223-()()	905.	1,020.	1,173.	1,584.
	24"	30"	42"	48"	QRKA 424823-()()	977.	1,103.	1,268.	1,712.
	24"	30"	48"	42"	QRKA 484223-()()	977.	1,103.	1,268.	1,712.
	24"	30"	48"	48"	QRKA 484823-()()	1,027.	1,156.	1,329.	1,795.
	30"	24"	36"	36"	QRKA 363632-()()	818.	917.	1,055.	1,424.
	30"	24"	36"	42"	QRKA 364232-()()	859.	968.	1,113.	1,503.
	30"	24"	42"	36"	QRKA 423632-()()	859.	968.	1,113.	1,503.
	30"	24"	42"	42"	QRKA 424232-()()	905.	1,020.	1,173.	1,584.
	30"	24"	42"	48"	QRKA 424832-()()	977.	1,103.	1,268.	1,712.
	30"	24"	48"	42"	QRKA 484232-()()	977.	1,103.	1,268.	1,712.
	30"	24"	48"	48"	QRKA 484832-()()	1,027.	1,156.	1,329.	1,795.
	30"	30"	42"	42"	QRKA 424233-()()	905.	1,020.	1,173.	1,584.
	30"	30"	48"	48"	QRKA 484833-()()	1,027.	1,156.	1,329.	1,795.

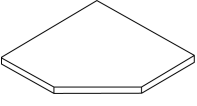
1 3/4" thick corner worksurface straight front corners 	24"	30"	36"	36"	QRKB 363623-()()	977.	1,239.	1,425.	1,924.
	24"	30"	36"	42"	QRKB 364223-()()	1,030.	1,293.	1,487.	2,007.
	24"	30"	42"	36"	QRKB 423623-()()	1,030.	1,293.	1,487.	2,007.
	24"	30"	42"	42"	QRKB 424223-()()	1,087.	1,358.	1,562.	2,108.
	24"	30"	42"	48"	QRKB 424823-()()	1,176.	1,455.	1,673.	2,259.
	24"	30"	48"	42"	QRKB 484223-()()	1,176.	1,455.	1,673.	2,259.
	24"	30"	48"	48"	QRKB 484823-()()	1,233.	1,519.	1,747.	2,358.
	30"	24"	36"	36"	QRKB 363632-()()	977.	1,239.	1,425.	1,924.
	30"	24"	36"	42"	QRKB 364232-()()	1,030.	1,293.	1,487.	2,007.
	30"	24"	42"	36"	QRKB 423632-()()	1,030.	1,293.	1,487.	2,007.
	30"	24"	42"	42"	QRKB 424232-()()	1,087.	1,358.	1,562.	2,108.
	30"	24"	42"	48"	QRKB 424832-()()	1,176.	1,455.	1,673.	2,259.
	30"	24"	48"	42"	QRKB 484232-()()	1,176.	1,455.	1,673.	2,259.
	30"	24"	48"	48"	QRKB 484832-()()	1,233.	1,519.	1,747.	2,358.
	30"	30"	42"	42"	QRKB 424233-()()	1,087.	1,358.	1,562.	2,108.
	30"	30"	48"	48"	QRKB 484833-()()	1,233.	1,519.	1,747.	2,358.

Order Code	Specification Information	Application Notes
Example: QRKB363623N1	<i>To order please specify pattern number including:</i>	Please call Custom Product Development for special grommet locations.
QR Reff Standard Special	1. Top thickness	Knoll accepts no responsibility for special grommet locations which interfere with support hardware.
K Straight front corner	2. Left hand width	
B 1 3/4" top thickness	3. Right hand width	Products on this page are shipped without hardware which must be ordered separately from the support components section.
36 36" wide on left back	4. Return left hand depth	
36 36" wide on right back	5. Return right hand depth	Mixed finish 1 3/4" tops are not post-formed.
2 24" deep on left side	6. Grommet option	
3 30" deep on right side	7. Finish type	
N No grommet	8. Top finish	
1 V1 finish	9. Grommet finish	
Y324 Ash	1. <i>Top thickness:</i> A = 1 1/4" B = 1 3/4"	
	6. <i>Grommet options:</i> N = No grommets F = Standard corner location	
	7. <i>Finish type:</i> L = Laminate M = Wood/laminate mixed 1 = V1 2 = V2 3 = V3	

Reff System

Reff Worksurfaces

curvilinear corner tops

Standard Specials Systems

description	Return d	d	Back w	w	pattern no.	lam.	M/V1	V2	V3
1 1/4" thick corner worksurface curved front corners	24"	30"	36"	36"	QRCA 363623-() ()	\$818.	\$917.	\$1,055.	\$1,424.
	24"	30"	36"	42"	QRCA 364223-() ()	859.	968.	1,113.	1,503.
	24"	30"	42"	36"	QRCA 423623-() ()	859.	968.	1,113.	1,503.
	24"	30"	42"	42"	QRCA 424223-() ()	905.	1,020.	1,173.	1,584.
	24"	30"	42"	48"	QRCA 424823-() ()	977.	1,103.	1,268.	1,712.
	24"	30"	48"	42"	QRCA 484223-() ()	977.	1,103.	1,268.	1,712.
	24"	30"	48"	48"	QRCA 484823-() ()	1,027.	1,156.	1,329.	1,795.
	30"	24"	36"	36"	QRCA 363632-() ()	818.	917.	1,055.	1,424.
	30"	24"	36"	42"	QRCA 364232-() ()	859.	968.	1,113.	1,503.
	30"	24"	42"	36"	QRCA 423632-() ()	859.	968.	1,113.	1,503.
	30"	24"	42"	42"	QRCA 424232-() ()	905.	1,020.	1,173.	1,584.
	30"	24"	42"	48"	QRCA 424832-() ()	977.	1,103.	1,268.	1,712.
	30"	24"	48"	42"	QRCA 484232-() ()	977.	1,103.	1,268.	1,712.
	30"	24"	48"	48"	QRCA 484832-() ()	1,027.	1,156.	1,329.	1,795.
	30"	30"	42"	42"	QRCA 424233-() ()	905.	1,020.	1,173.	1,584.
	30"	30"	48"	48"	QRCA 484833-() ()	1,027.	1,156.	1,329.	1,795.

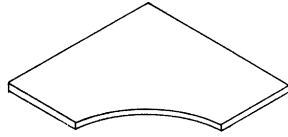

Order Code	Specification Information	Application Notes
Example: QRCA363636N1	<i>To order please specify pattern number including:</i>	Radius of curved front changes with overall top size. See Planning Guide.
QR Reff Standard Special	1. Left hand width	Products on this page are shipped without hardware which must be ordered separately from the support components section.
C Curved front corner	2. Right hand width	
A 1 1/4" thick	3. Return left hand depth	
36 36" wide on left back	4. Return right hand depth	
36 36" wide on right back	5. Grommet option	
2 24" deep on left side	6. Top finish type	
3 30" deep on right side	7. Top finish	
N No grommet	8. Grommet finish	
1 VI finish	5. <i>Grommet options:</i>	Curvilinear worksurfaces only available in 1 1/4" thick.
Y324 Ash	N = No grommets	See Planning Guide for grommet locations.
	F = Standard corner location	
	6. <i>Finish type:</i>	
	L = Laminate	
	M = Wood/laminate mixed	
	1 = V1	
	2 = V2	
	3 = V3	

Actual widths of worksurface are 1/16" less than nominal dimension. Actual depth is 1/8" less than nominal dimension.

Knoll accepts no responsibility for special grommet locations which interfere with support or other hardware.

Please call Custom Product Development for special grommet locations.

Product on this page will accept woodgrain laminate where laminate is currently an option. List price for woodgrain laminate options will be current published laminate list price plus 10%.

Applicable finishes are listed on page 102 and 103.

Reff Worksurfaces

split curvilinear corner tops

Standard Specials Systems

description	Return d	d	Back w	w	pattern no.	lam.	M/V1	V2	V3
1 1/4" thick split curvilinear corner worksurface with 10" D split front	24"	24"	36"	36"	QRCAS 363622-()()	\$1,408.	\$1,507.	\$1,733.	\$2,340.
	24"	24"	42"	42"	QRCAS 424222-()()	1,495.	1,610.	1,851.	2,500.
	24"	24"	48"	48"	QRCAS 484822-()()	1,617.	1,746.	2,008.	2,711.
	30"	30"	42"	42"	QRCAS 424233-()()	1,495.	1,610.	1,851.	2,500.
	30"	30"	48"	48"	QRCAS 484833-()()	1,617.	1,746.	2,008.	2,711.

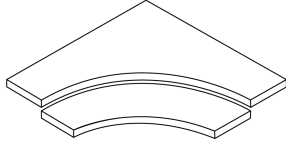

NOTE: Split Top Mechanism to be ordered separately from the Interaction Price List

Order IBST18 split-top mechanism for QRCAS363622, QRCAS424233

Order IBST22 split-top mechanism for QRCAS424222, QRCAS484822

Order IBST28 split-top mechanism for QRCAS484833

Reff System

Order Code	Specification Information	Application Notes
Example: QRCAS363622N1	<i>To order please specify pattern number including:</i>	Radius of curved front changes with overall top size. See Planning Guide.
QR Reff Standard Special	1. Left hand width	Products on this page are shipped without hardware which must be ordered separately from the support components section.
C Curved front corner	2. Right hand width	
A 1 1/4" thick	3. Return left hand depth	
S Split Top	4. Return right hand depth	
36 36" wide on left back	5. Grommet option	
36 36" wide on right back	6. Top finish type	
2 24" deep on left side	7. Top finish	
2 24" deep on right side	8. Grommet finish	
N No grommet	5. <i>Grommet options:</i> N = No grommets F = Standard corner location	Curvilinear worksurfaces only available in 1 1/4" thick.
1 V1 finish		See Planning Guide for grommet locations.
Y324 Ash	6. <i>Finish type:</i> L = Laminate M = Wood/laminate mixed 1 = V1 2 = V2 3 = V3	Actual widths of worksurface are 1/16" less than nominal dimension. Actual depth is 1/8" less than nominal dimension. Knoll accepts no responsibility for special grommet locations which interfere with support or other hardware. Please call Custom Product Development for special grommet locations. Product on this page will accept woodgrain laminate where laminate is currently an option. List price for woodgrain laminate options will be current published laminate list price plus 10%. Applicable finishes are listed on page 102 and 103.

description	d	pattern no.	P1	P2	P3
Cantilever bracket, panel hung	11"	QRBC11 (L/R)	\$97.		
	18"	RBC18 (L/R)	86.	90.	94.

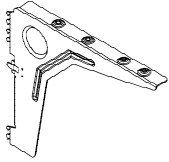

specify paint finish

Corner top corner bracket		RBCC	17.		
---------------------------	--	-------------	-----	--	--



available in black only

Order Code	Specification Information	Application Notes
Example: QRBC11L 115	<i>To order please specify pattern number including:</i> 1. Left or right-hand, where applicable. 2. Finish	Applicable finishes are listed on page 102 and 103.
QR Reff Standard Special		
B Bracket		
C Cantilever		
11 18" deep		
L Left hand		
115 Medium Grey		

Reff Worksurfaces
 Optional edge worksurface tops
 1 1/4" thick curvilinear corner
 2" Waterfall edge detail front only

description	d left	d right	w left	w right	pattern no.	V1	V2	V3
Curved corner work top	20"	20"	48"	48"	QRCAWF484811 () () ()	\$2,362.	\$2,716.	\$3,667.
Profile edge on front only	20"	24"	48"	48"	QRCAWF484812 () () ()	2,443.	2,809.	3,793.
	24"	20"	48"	48"	QRCAWF484821 () () ()	2,443.	2,809.	3,793.
	24"	24"	48"	48"	QRCAWF484822 () () ()	2,600.	2,990.	4,037.

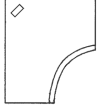

Radii of front edge varies with top dimensions

Order Code	Specification Information	Application Notes
Example: QRCAWF484811F2	<i>To order please specify pattern number including:</i>	Products on this page are shipped without hardware which must be ordered separately from the support components section.
QR Reff Standard Special	1. Grommet option	Curvilinear worksurfaces only available in 1 1/4" thick.
C Curved front corner	2. Top finish type	See Planning Guide for grommet locations.
A 1 1/4" thick	3. Top finish	Waterfall tops cannot be specified with semi-open pore finish.
WF Waterfall front	4. Grommet finish	Knoll assumes no responsibility for special grommet locations which interfere with support or other hardware.
48 48" wide on left back	<i>1. Grommet options:</i>	Waterfall worksurfaces should be specified in a configuration only with other waterfall worksurfaces.
48 48" wide on right back	N = No grommet	Actual widths of worksurface are 1/16" less than nominal dimension. Actual depth is 1/8" less than nominal dimension.
1 20" deep on left side	F = Standard corner location	
1 20" deep on right side	<i>2. Finish type:</i>	
F Standard grommet	1 = V1	
2 V2 finish	2 = V2	
V319 Medium cherry	3 = V3	
111 Jet Black (grommet)	Applicable finishes are listed on page 102 and 103.	
	Products on this page do not accept the following finishes: Y341 Wenge Y342 Medium Teak Y343 Dark Grey Oak	

conference room tops

1 1/4" and 1 3/4" thick round - No Grommets - No Drilling

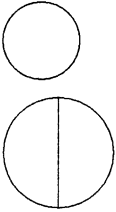
description	h	dia	pattern no.	lam.	M/V1	V2	V3	
Round tops 	1 1/4"	24"	QRTA2424 () ()	\$669.	\$728.	\$837.	\$1,130.	
		30"	QRTA3030 () ()	699.	760.	874.	1,180.	
		54"	QRTA5454 () () *	2,092.	2,274.	2,615.	3,530.	
	* top in two pieces							
	1 3/4"	24"	QRTB2424 () ()	809.	1,169.	1,344.	1,815.	
		30"	QRTB3030 () ()	839.	1,201.	1,381.	1,865.	
54"		QRTB5454 () () *	2,510.	3,142.	3,613.	4,878.		
* top in two pieces								

Order Code

Example: QRTA30302	
QR	Reff Standard Special
T	Rounded top
A	1 1/4" thick
36	36" wide
30	30" deep
2	V2 finish
V319	Medium cherry

Specification Information

To order please specify pattern number including:

1. Top thickness
2. Width
3. Depth
4. Finish type
5. Finish

1. Thickness options:
A = 1 1/4"
B = 1 3/4"

4. Finish type:
L = Laminate
M = Wood/laminate mixed
1 = V1
2 = V2
3 = V3

*Round tops in two pieces.

Application Notes

Top to top brackets included.

See table base matrix in Planning Guide pages 140 and 141.

1 1/4" tops require support at mid point to reduce spans to 48" or less.

Tops have no radius on edges that adjoin.

1 3/4" tops require support at mid point to reduce spans to 66" or less.

Laminate and mixed finish 1 3/4" tops on this page are not post formed.

All tops on this page are without grommets or drillings. The intended use of these products is to provide conference room table options.

Actual widths of worksurface are 1/16" less than nominal dimension. Actual depth is 1/8" less than nominal dimension.

1 1/4" Product on this page will accept woodgrain laminate where laminate is currently an option. List price for woodgrain laminate options will be current published laminate list price plus 10%.

Applicable finishes are listed on page 102 and 103.

Reff Worksurfaces
conference room tops
1 1/4" thick
round and racetrack with 2" waterfall edge

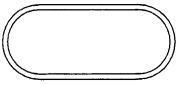
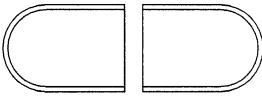
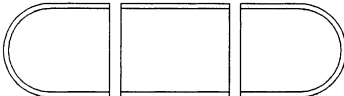
description	w	d	pattern no.	V1	V2	V3
Round top 	48"	48"	QRTAW4848 () ()	\$3,302.	\$3,797.	\$5,126.
Racetrack top- 1 piece 	96"	48"	QRTAW9648 () ()	9,514.	10,941.	14,770.
Racetrack top- 2 piece Profile edge on all sides except on parting lines 	120" 144"	48" 48"	QRTAW12048 () () QRTAW14448 () ()	10,550. 11,452.	12,133. 13,170.	16,379. 17,779.
Racetrack top- 3 piece Profile edge on all sides except on parting lines 	168" 192"	48" 48"	QRTAW16848 () () QRTAW19248 () ()	14,501. 15,404.	16,676. 17,715.	22,513. 23,915.

Order Code	Specification Information	Application Notes
Example: QRTAW96482	<i>To order please specify pattern number including:</i>	All tops on this page are without grommets or drillings. The intended use of these products is to provide conference room table options. Top to top brackets included. Tops have no radius on edges that adjoin. See table base matrix in Planning Guide for base supports recommended. 1 1/4" tops require support at mid point to reduce spans to 48" or less. Waterfall tops cannot be specified with semi-open pore finish.
QR Reff Standard Speical	1. Top thickness 2. Finish type 3. Finish	
T Racetrack top	1. <i>Thickness option:</i> A = 1 1/4"	Actual widths of worksurface are 1/16" less than nominal dimension. Actual depth is 1/8" less than nominal dimension.
A 1 1/4" thick	2. <i>Finish type:</i> 1 = V1 2 = V2 3 = V3	
W Waterfall all sides	Applicable finishes are listed on page 102 and 103.	
96 96" wide	Products on this page do not accept the following finishes: Y341 Wenge Y342 Medium Teak Y343 Dark Grey Oak	
42 42" deep		
2 V2 finish		
V319 Medium cherry		

Reff Worksurfaces
conference room tops
1 1/4" thick
square and rectangular with 2" waterfall edge

Standard Specials Systems

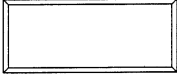
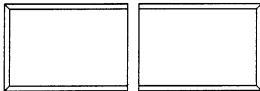
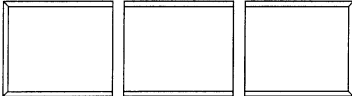
description	w	d	pattern no.	V1	V2	V3
Square top 	48"	48"	QRRAW4848 () ()	\$2,902.	\$3,337.	\$4,505.
Rectangular top- 1 piece 	96"	48"	QRRAW9648 () ()	6,488.	7,461.	10,073.
Rectangular top- 2 piece Profile edge on all sides except on parting lines 	120" 144"	48" 48"	QRRAW12048 () () QRRAW14448 () ()	9,111. 9,988.	10,478. 11,486.	14,145. 15,506.
Rectangular top- 3 piece Profile edge on all sides except on parting lines 	168" 192"	48" 48"	QRRAW16848 () () QRRAW19248 () ()	12,825. 13,700.	14,749. 15,755.	19,911. 21,269.

Order Code

Example: QRRAW96482	
QR	Reff Standard Special
R	Rectangular
A	1 1/4" thick
W	Waterfall all sides
96	96" wide
48	48" deep
2	V2 finish
V319	Medium cherry

Specification Information

To order please specify pattern number including:

1. Top thickness
2. Finish type
3. Finish

1. Thickness option:
A = 1 1/4"

2. Finish type:
1 = V1
2 = V2
3 = V3

Applicable finishes are listed on page 102 and 103.

Products on this page do not accept the following finishes:
 Y341 Wenge
 Y342 Medium Teak
 Y343 Dark Grey Oak

Application Notes

All tops on this page are without grommets or drillings. The intended use of these products is to provide conference room table options.

Top to top brackets included.

Tops have no radius on edges that adjoin.

See table base matrix in Planning Guide for base supports recommended.

1 1/4" tops require support at mid point to reduce spans to 48" or less.

Waterfall tops cannot be specified with semi-open pore finish.

Actual widths of worksurface are 1/16" less than nominal dimension. Actual depth is 1/8" less than nominal dimension.

Reff support components end panels

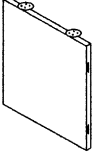
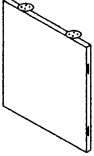
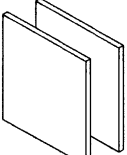
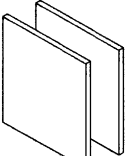
description	d	w	h	pattern no.	lam.	M/V1	V2	V3
Endpanel, for use in building flush or cantilevered worksurfaces. Standard height	1"	35"	26½"	QRE35F-() ()	\$277.	\$457.	\$526.	\$709.
								
Endpanel, for use in building flush or cantilevered worksurfaces. Desk height	1"	35"	28¾"	QREDH35F-() ()	291.	480.	552.	745.
								
Endpanel, for recessed modesty worksurfaces. Standard height	1"	24"	26½"	QRE24-() ()	523.	850.	978.	1,320.
								
	<i>sold in pairs with 3" recess</i>							
Endpanel, for recessed modesty worksurfaces. Desk height	1"	24"	28¾"	QREDH24-() ()	549.	893.	1,027.	1,386.
								
	<i>sold in pairs with 3" recess</i>							

Order Code	Specification Information	Application Notes
Example: QRE35FL118	<i>To order please specify pattern number including:</i>	Product on this page will accept woodgrain laminate where laminate is currently an option. List price for woodgrain laminate options will be current published laminate list price plus 10%.
QR Reff Standard Special	1. <i>Finish type</i>	Glides ship with all supports on this page except the recessed modesty panel.
E End panel	2. <i>Finish</i>	
35 35" panel dimension		Please see Planning Guide for freestanding planning instruction.
F Flush modesty placement		
L Laminate	1. <i>Finish type:</i>	Applicable finishes are listed on page 102 and 103.
118 Bright White	L = Laminate	End panels come with all hardware necessary to attach to tops and each other to build freestanding desks. To join tops to tops or bridge assemblies to desk, hardware must be ordered.
	1 = V1	
	2 = V2	
	3 = V3	

Reff support components modesty panels

description	d	w	h	pattern no.	L	V1	V2	V3
Modesty panels with hardware. ¹⁵ / ₁₆ " actual thickness (standard height)	1"	102"	26 1/2"	QRB102(M/H)(F/R)() ()	\$686.	\$942.	\$1,083.	\$1,462.
	1"	108"	26 1/2"	QRB108(M/H)(F/R)() ()	746.	1,006.	1,156.	1,561.
	1"	114"	26 1/2"	QRB114(M/H)(F/R)() ()	807.	1,069.	1,230.	1,660.
	1"	120"	26 1/2"	QRB120(M/H)(F/R)() ()	867.	1,133.	1,303.	1,759.

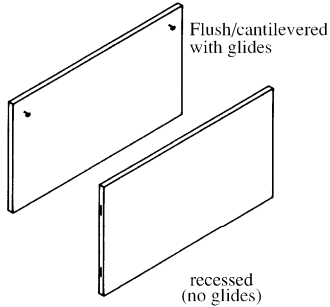

Modesty panels with hardware. ¹⁵ / ₁₆ " actual thickness (desk height)	1"	102"	28 3/8"	QRBDH102M(F/R)() ()	720.	989.	1,137.	1,535.
	1"	108"	28 3/8"	QRBDH108M(F/R)() ()	784.	1,056.	1,214.	1,639.
	1"	114"	28 3/8"	QRBDH114M(F/R)() ()	847.	1,123.	1,291.	1,743.
	1"	120"	28 3/8"	QRBDH120M(F/R)() ()	911.	1,190.	1,368.	1,847.

Short modesty panel (standard height)	1"	28"	26 1/2"	QRB28MR() ()	306.	431.	495.	669.
	1"	34"	26 1/2"	QRB34MR() ()	339.	472.	542.	732.
	1"	46"	26 1/2"	QRB46MR() ()	410.	577.	664.	896.
	1"	58"	26 1/2"	QRB58MR() ()	445.	623.	717.	967.

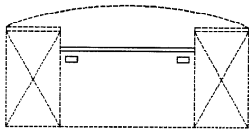

Use of short modesty panel

Pedestals and finished back for pedestal must each be ordered separately

Short modesty comes with attachment brackets to secure modesty panel to sides of pedestals.

Order:

28" modesty for 60" bow top

34" modesty for 66" bow top

46" modesty for 78" bow top

58" modesty for 90" bow top

When ordering 30"d bow top for use with short modesty, specify **recessed** grommet location

When ordering 36"d bow top for use with short modesty, specify **alternate** grommet location

Short modesty panel (desk height)	1"	28"	28 3/8"	QRBDH28MR() ()	321.	452.	520.	702.
	1"	34"	28 3/8"	QRBDH34MR() ()	356.	495.	569.	769.
	1"	46"	28 3/8"	QRBDH46MR() ()	431.	606.	697.	941.
	1"	58"	28 3/8"	QRBDH58MR() ()	467.	654.	752.	1,016.

Example:	QRBDH120MFL114
QR	Reff Standard Special
B	Back panel
DH	Desk height (28 3/8")
120	120"
M	Full height
F	Modesty placement, flush
L	Finish type, laminate
114	Finish, Folkstone grey

To order please specify pattern number including:

1. Modesty type
2. Modesty placement
3. Finish type
4. Finish

1. Modesty type:
M = Full height (26 1/2"H or ²⁸³/₈")
H = Half height

2. Modesty placement:
F = Flush, cantilevered
R = Recessed

3. Finish type:
L = Laminate
1 = V1
2 = V2
3 = V3

Product on this page will accept woodgrain laminate where laminate is currently an option.
List price for woodgrain laminate options will be current published laminate list price plus 10%.

Modesty panels ship with all hardware necessary to attach to tops and each other to build freestanding desks. To join tops to tops or bridge assemblies to desk, hardware must be ordered separately.

Modesty panel lengths are nominal, length changes on option selected.

Glides ship with all supports on this page except the recessed modesty panel.

Please see Reff Planning Guide for freestanding planning instructions.

Reff support components

drum bases

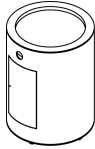
description	dia	h	pattern no.	V1	V2	V3
 Drum base (standard height)	20"	26 1/2"	QR9D5459 ()()	\$4,598.	n/a	n/a
	24"	26 1/2"	QR9C7794 ()()	4,725.	n/a	n/a
	30"	26 1/2"	QR9C7917 ()()	4,901.	n/a	n/a
	36"	26 1/2"	QRSDA3627 ()()	5,077.	5,839.	7,883.
	20"	26 1/2"	QR9C7801 ()()	n/a	5,288.	n/a
	20"	26 1/2"	QR9G6777 ()()	n/a	n/a	7,138.
	24"	26 1/2"	QR9C7798 ()()	n/a	5,433.	n/a
	24"	26 1/2"	QR9G6778 ()()	n/a	n/a	7,335.
	30"	26 1/2"	QR9C7919 ()()	n/a	5,636.	n/a
	30"	26 1/2"	QR9G6779 ()()	n/a	n/a	7,608.

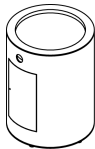
 Drum base (desk height)	20"	28 3/8"	QR9G0413 ()()	4,652.	n/a	n/a
	24"	28 3/8"	QR9G1295 ()()	4,818.	n/a	n/a
	30"	28 3/8"	QR9G2826 ()()	4,987.	n/a	n/a
	36"	28 3/8"	QRSDHDA3628 ()()	5,331.	6,131.	8,277.
	20"	28 3/8"	QR9G1171 ()()	n/a	5,349.	n/a
	20"	28 3/8"	QR9G6780 ()()	n/a	n/a	7,221.
	24"	28 3/8"	QR9G1173 ()()	n/a	5,540.	n/a
	24"	28 3/8"	QR9G6781 ()()	n/a	n/a	7,479.
	30"	28 3/8"	QR9G1499 ()()	n/a	5,735.	n/a
	30"	28 3/8"	QR9G6782 ()()	n/a	n/a	7,742.

Drum base (standard height) No hinged access door	36"	26 1/2"	QRSD3627 ()()	2,892.	3,326.	4,490.
--	-----	---------	-----------------	--------	--------	--------

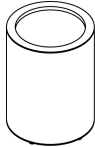

Drum base (desk height) No hinged access door	36"	28 3/8"	QRSDHD3628 ()	3,037.	3,493.	4,716.
--	-----	---------	----------------	--------	--------	--------

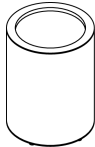

Order Code

Example: QR9C78012 V319
QR9C7801 Reff Standard Special
2 V2 Finish
V319 Medium Cherry

Specification Information

To order please specify pattern number including:

- Finish Type.
1 = V1
2 = V2
3 = V3

- Finish

Applicable finishes are listed on page 102 and 103.

Application Notes

All Drum bases include sandbags for counterweight.

Features for drum with door only:

- 9" w x 16" h piano hinged access door with catch closure hardware & black knob pull.
- 8" dia. cutout at bottom.
- 2" dia. hole located centered above door
- 16" dia. cutout in top of 20" dia. Drum base
- 20" dia. cutout in top of 24" dia. Drum base
- 24" dia. cutout in top of 30" and 36" dia. Drum base

Reff Cabinetry
pedestals, 17" W
wood interiors, standard height

Standard Specials Systems

description	w	d	h	pattern no.	L	V1	V2	V3
Pedestal for UK filing standard height	17"	19"	26 1/2"	QR211JUK-() W () L	\$1,335.	\$1,428.	\$1,642.	\$2,217.
BBF	17"	23"	26 1/2"	QR212JUK-() W () L	1,486.	1,593.	1,832.	2,473.
	17"	29"	26 1/2"	QR213JUK-() W () L	1,618.	1,735.	1,995.	2,694.

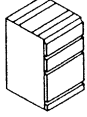

Pedestal for UK filing standard height	17"	19"	26 1/2"	QR211KUK-() W () L	1,243.	1,332.	1,532.	2,068.
FF	17"	23"	26 1/2"	QR212KUK-() W () L	1,466.	1,571.	1,807.	2,439.
	17"	29"	26 1/2"	QR213KUK-() W () L	1,598.	1,715.	1,972.	2,663.

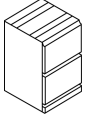

Pedestal back for UK	17"	1"	26 1/2"	QRPAB17UK-() ()	140.	146.	167.	226.
----------------------	-----	----	---------	-------------------	------	------	------	------

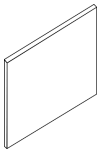

Order Code

Example: **QR211JUKLWDL**

QR	Reff Standard Special
2	26 1/2" H
1	17" wide
1	19" deep
J	Box box file config.
L	Laminate finish
W	Wood interior
D	Metal D-pull
L	Lock hole drilled

Applicable finishes are listed on page 102 and 103.

Specification Information

To order please specify pattern number including:

1. Finish type
2. Pull option
3. Keying instructions
4. Finish

***After specifying product code, provide keying instructions.**

1. *Finish type:*
L = Laminate
1 = V1
2 = V2
3 = V3

2. *Interior options:*
W = Wood

Application Notes

3. *Pull options:*
D = Metal D-pull
J = Routed pull
C = Nickel C-pull (nickel finish only)
S = S-pull (stainless steel finish only)

4. *Lock options:*
L = Drilled to accept lock

6. Refer to page 199 for keying instructions.

Product on this page excluding J-pull option will accept woodgrain laminate where laminate is currently an option.

List price for woodgrain laminate options will be current published laminate list price plus 10%.

Each pedestal with wood drawers includes one pencil tray and two tray dividers in top box drawer.

Pedestals must be ordered with back panel to achieve full depth without a modesty panel.

Pedestals do not come with lock included. Keying instructions must accompany all cabinet orders.

File drawers include file bars for front to back and side to side filing. File drawers do not support bottom loading.

Random locks are factory installed.

Keyalike are field installed using the KnollKey order form.

Each locking pedestal on this page counts for one lock core.

Reff Cabinetry
pedestals, 17" W
wood interiors, desk height

Standard Specials Systems

description	w	d	h	pattern no.	L	V1	V2	V3
Pedestal for UK filing	17"	19"	28 ³ / ₈ "	QR111JUK-() W () L	\$1,402.	\$1,500.	\$1,725.	\$2,329.
desk height	17"	23"	28 ³ / ₈ "	QR112JUK-() W () L	1,559.	1,673.	1,924.	2,597.
BBF	17"	29"	28 ³ / ₈ "	QR113JUK-() W () L	1,698.	1,823.	2,096.	2,830.

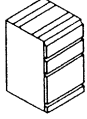

Pedestal for UK filing	17"	19"	28 ³ / ₈ "	QR111KUK-() W () L	1,306.	1,398.	1,608.	2,170.
desk height	17"	23"	28 ³ / ₈ "	QR112KUK-() W () L	1,538.	1,648.	1,895.	2,559.
FF	17"	29"	28 ³ / ₈ "	QR113KUK-() W () L	1,677.	1,801.	2,071.	2,796.

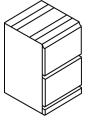

Pedestal back for UK	17"	1"	28 ³ / ₈ "	QRPDHB17UK-() ()	148.	153.	177.	236.
----------------------	-----	----	----------------------------------	--------------------	------	------	------	------

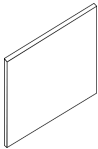

Order Code

Example: **QR211JUKLWDL**

QR	Reff Standard Special
2	26 1/2" H
1	17" wide
1	19" deep
J	Box box file config.
L	Laminate finish
W	Wood interior
D	Metal D-pull
L	Lock hole drilled

Applicable finishes are listed on page 102 and 103.

Specification Information

To order please specify pattern number including:

1. Finish type
2. Pull option
3. Keying instructions
4. Finish

***After specifying product code, provide keying instructions.**

1. *Finish type:*
L = Laminate
1 = V1
2 = V2
3 = V3

2. *Interior options:*
W = Wood

Application Notes

3. *Pull options:*
D = Metal D-pull
J = Routed pull
C = Nickel C-pull (nickel finish only)
S = S-pull (stainless steel finish only)

4. *Lock options:*
L = Drilled to accept lock

6. Refer to page 199 for keying instructions.

Product on this page excluding J-pull option will accept woodgrain laminate where laminate is currently an option.
List price for woodgrain laminate options will be current published laminate list price plus 10%.

Each pedestal with wood drawers includes one pencil tray and two tray dividers in top box drawer.

Pedestals must be ordered with back panel to achieve full depth without a modesty panel.

Pedestals do not come with lock included. Keying instructions must accompany all cabinet orders.

File drawers include file bars for front to back and side to side filing. File drawers do not support bottom loading.

Random locks are factory installed.

Keyalike are field installed using the KnollKey order form.

Each locking pedestal on this page counts for one lock core.

Reff Cabinetry
pedestals, 30" and 36" W
wood interiors

Standard Specials Systems

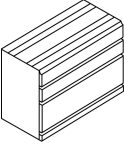
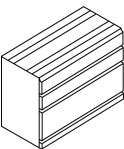
description	w	d	h	pattern no.	L	V1	V2	V3
Pedestal standard height BBF 	30"	19"	26 1/2"	QRP231J-() () L () ()	\$1,725.	\$1,846.	\$2,123.	\$2,866.
	30"	23"	26 1/2"	QRP232J-() () L () ()	1,915.	2,053.	2,361.	3,187.
	36"	19"	26 1/2"	QRP261J-() () L () ()	2,133.	2,282.	2,624.	3,543.
	36"	23"	26 1/2"	QRP262J-() () L () ()	2,346.	2,516.	2,893.	3,906.
Pedestal desk height BBF 	30"	19"	28 3/8"	QRP301J-() () L () ()	1,811.	1,938.	2,229.	3,009.
	30"	23"	28 3/8"	QRP302J-() () L () ()	2,011.	2,156.	2,479.	3,347.
	36"	19"	28 3/8"	QRP361J-() () L () ()	2,240.	2,397.	2,757.	3,721.
	36"	23"	28 3/8"	QRP362J-() () L () ()	2,463.	2,642.	3,038.	4,102.

Order Code

Example:	RP211JLWDL
R	Reff
P	Pedestal
2	26 1/2"H
1	16" wide
1	19" deep
J	Box box file config.
L	Laminate finish
W	Wood interior
D	Metal D-pull
L	Lock hole drilled

Applicable finishes are listed on page 102 and 103.

Specification Information

To order please specify pattern number including:

- Hinge location, where applicable
- Finish type
- Interior option
- Pull option
- Lock option, applicable hinged doors only
- Keying instructions
- Finish

***After specifying product code, provide keying instructions.**

1. Hinge location:
L = Left hand
R = Right hand

2. Finish type:
L = Laminate
1 = V1
2 = V2
3 = V3

3. Interior options:
W = Wood

Application Notes

4. Pull options:
D = Metal D-pull
J = Routed pull
C = Nickel C-pull (nickel finish only)
S = S-pull (stainless steel finish only)

5. Lock options:
L = Drilled to accept lock
N = No drilling

6. Refer to page 199 for keying instructions.

Product on this page excluding J-pull option will accept woodgrain laminate where laminate is currently an option.
List price for woodgrain laminate options will be current published laminate list price plus 10%.

Pedestals must be ordered with back panel to achieve full depth without a modesty panel.

Pedestals do not come with lock included. Keying instructions must accompany all cabinet orders.

Hinge door cabinets have optional lock drilling which can be specified in the cabinet product code.

Mobile pedestals are always equipped with finished backs.

File drawers include file bars for front to back and side to side filing. File drawers do not support bottom loading.

Random locks are factory installed.

Keyalike are field installed using the KnollKey order form.

Each locking pedestal on this page counts for one lock core.

Reff Cabinetry

pedestals, 30" and 36" W

metal interiors

Standard Specials Systems

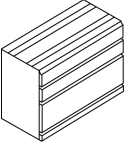
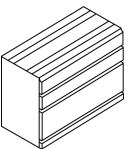
description	w	d	h	pattern no.	L	V1	V2	V3
Pedestal standard height BBF 	30"	19"	26 1/2"	QRP231J-() () L ()	\$1,437.	\$1,540.	\$1,771.	\$2,391.
	30"	23"	26 1/2"	QRP232J-() () L ()	1,477.	1,585.	1,823.	2,461.
	36"	19"	26 1/2"	QRP261J-() () L ()	1,534.	1,643.	1,889.	2,551.
	36"	23"	26 1/2"	QRP262J-() () L ()	1,567.	1,682.	1,934.	2,611.
Pedestal desk height BBF 	30"	19"	28 3/8"	QRP301J-() () L ()	1,509.	1,617.	1,860.	2,510.
	30"	23"	28 3/8"	QRP302J-() () L ()	1,552.	1,664.	1,914.	2,583.
	36"	19"	28 3/8"	QRP361J-() () L ()	1,611.	1,725.	1,984.	2,678.
	36"	23"	28 3/8"	QRP362J-() () L ()	1,645.	1,765.	2,030.	2,740.

Reff System

Order Code	Specification Information	Application Notes
<p>Example: RP211JLWDL</p> <p>R Reff</p> <p>P Pedestal</p> <p>2 26 1/2"H</p> <p>1 16" wide</p> <p>1 19" deep</p> <p>J Box box file config.</p> <p>L Laminate finish</p> <p>W Wood interior</p> <p>D Metal D-pull</p> <p>L Lock hole drilled</p>	<p>To order please specify pattern number including:</p> <ol style="list-style-type: none"> Hinge location, where applicable Finish type Interior option Pull option Lock option, applicable hinged doors only Keying instructions Finish <p>*After specifying product code, provide keying instructions.</p> <p>1. <i>Hinge location:</i> L = Left hand R = Right hand</p> <p>2. <i>Finish type:</i> L = Laminate 1 = V1 2 = V2 3 = V3</p> <p>3. <i>Interior options:</i> M = Metal</p>	<p>4. <i>Pull options:</i> D = Metal D-pull J = Routed pull C = Nickel C-pull (nickel finish only) S = S-pull (stainless steel finish only)</p> <p>5. <i>Lock options:</i> L = Drilled to accept lock N = No drilling</p> <p>6. Refer to page 199 for keying instructions.</p> <p>Product on this page excluding J-pull option will accept woodgrain laminate where laminate is currently an option. List price for woodgrain laminate options will be current published laminate list price plus 10%.</p> <p>Pedestals must be ordered with back panel to achieve full depth without a modesty panel.</p>

Applicable finishes are listed on page 102 and 103.

Pedestals do not come with lock included. Keying instructions must accompany all cabinet orders.

Hinge door cabinets have optional lock drilling which can be specified in the cabinet product code.

Mobile pedestals are always equipped with finished backs.

File drawers include file bars for front to back and side to side filing. File drawers do not support bottom loading.

Random locks are factory installed.

Keyalike are field installed using the KnollKey order form.

Each locking pedestal on this page counts for one lock core.

Reff Cabinetry
 Cabinets (use with 26 1/2" h support components)
 38" high
 wood interior

description	w	d	h	pattern no.	L	V1	V2	V3
3 Drawer lateral file with anit-tip bar device	30"	20"	38"	QRC332F- () () L () ()	\$2,419.	\$3,172.	\$3,648.	\$4,925.
	30"	24"	38"	QRC333F- () () L () ()	2,656.	3,487.	4,010.	5,414.
	36"	20"	38"	QRC362F- () () L () ()	3,026.	3,964.	4,559.	6,154.
	36"	24"	38"	QRC363F- () () L () ()	3,324.	4,355.	5,008.	6,761.

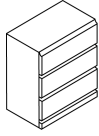

Order Code

Example:	QRC332FLWJL
QR	Reff Standard Special
C	Cabinets
3	38" high
3	30" wide
2	20" deep
F	File drawer
L	Laminate finish type
W	Wood interior
J	Routed pull
L	Lock drilling

Specification Information

To order please specify pattern number including:

1. Hinge location, where applicable
2. Finish type
3. Interior option
4. Pull option
5. Lock option, where applicable
6. Finish, cabinet
7. Finish, pull when applicable
8. Keying instructions

***After specifying product code, provide keying instructions.**

1. Hinge location:
 L = Left hand
 R = Right hand

2. Finish type:
 L = Laminate
 1 = V1
 2 = V2
 3 = V3

3. Interior options:
 W = Wood

4. Pull options:
 D = Metal D-pull
 J = Routed pull
 C = Nickel C-pull (nickel finish only)
 S = S-pull (stainless steel finish only)

5. Lock options:
 L = Lock hole drilled
 N = No lock drilling

8. Refer to page 199 for keying instructions.

Product on this page excluding J-pull option will accept woodgrain laminate where laminate is currently an option.
 List price for woodgrain laminate options will be current published laminate list price plus 10%.

Specify shelf paint finish on open cabinets with metal interiors.

Please note: Shelf adjustability is limited to approximately 2.5" up or down per shelf from predetermined shelf height.

Application Notes

Key alike are field installed using the KnollKey order form. Random locks are factory installed.

Cabinets do not come with lock included. Keying instructions must accompany all cabinet orders.

Hinge door cabinets have optional lock drilling which can be specified in the cabinet product code.

**Note:*
 Wardrobe cabinets do not come equipped with coat rod and boot tray. Please specify separately from standard Reff price list.

File drawers include file bars for front to back and side to side filing.

File drawers do not support bottom loading.

Applicable finishes are listed on page 102 and 103.

Reff Cabinetry
 Cabinets (use with 26¹/₂" h support components)
 38" high
 metal interior

description	width	depth	height	pattern no.	L	V1	V2	V3
3 Drawer lateral file with anit-tip bar device	30"	20"	38"	QRC332F- () () L () ()	\$2,261.	\$2,963.	\$3,407.	\$4,600.
	30"	24"	38"	QRC333F- () () L () ()	2,495.	3,271.	3,762.	5,078.
	36"	20"	38"	QRC362F- () () L () ()	2,867.	3,757.	4,321.	5,833.
	36"	24"	38"	QRC363F- () () L () ()	3,165.	4,151.	4,774.	6,444.

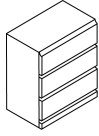

Order Code

Example: QRC332FLWJL	
QR	Reff Standard Special
C	Cabinets
3	38" high
3	30" wide
2	20" deep
F	File drawer
L	Laminate finish type
W	Wood interior
J	Routed pull
L	Lock drilling

Specification Information

To order please specify pattern number including:

- Hinge location, where applicable
- Finish type
- Interior option
- Pull option
- Lock option, where applicable
- Finish, cabinet
- Finish, pull when applicable
- Keying instructions

***After specifying product code, provide keying instructions.**

1. *Hinge location:*
 L = Left hand
 R = Right hand

2. *Finish type:*
 L = Laminate
 1 = V1
 2 = V2
 3 = V3

3. *Interior options:*
 M = Metal

4. *Pull options:*
 D = Metal D-pull
 J = Routed pull
 C = Nickel C-pull (nickel finish only)
 S = S-pull (stainless steel finish only)

5. *Lock options:*
 L = Lock hole drilled
 N = No lock drilling

8. Refer to page 199 for keying instructions.

Product on this page excluding J-pull option will accept woodgrain laminate where laminate is currently an option.
 List price for woodgrain laminate options will be current published laminate list price plus 10%.

Specify shelf paint finish on open cabinets with metal interiors.

Please note: Shelf adjustability is limited to approximately 2.5" up or down per shelf from predetermined shelf height.

Application Notes

Key alike are field installed using the KnollKey order form. Random locks are factory installed.

Cabinets do not come with lock included. Keying instructions must accompany all cabinet orders.

Hinge door cabinets have optional lock drilling which can be specified in the cabinet product code.

**Note:*
 Wardrobe cabinets do not come equipped with coat rod and boot tray. Please specify separately from standard Reff price list.

File drawers include file bars for front to back and side to side filing.

File drawers do not support bottom loading.

Applicable finishes are listed on page 102 and 103.

Reff Cabinetry
 Cabinets (use with 26 1/2" h support components)
 64" high
 wood interior

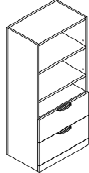
description	w	d	h	pattern no.	L	V1	V2	V3
 Storage open above w/2 adj shelves, FF below	16"	20"	64"	QRC612G- () () L () ()	\$2,232.	\$2,901.	\$3,336.	\$4,504.
	16"	24"	64"	QRC613G- () () L () ()	2,446.	3,178.	3,655.	4,934.
	30"	20"	64"	QRC632G- () () L () ()	2,772.	3,608.	4,149.	5,601.
	30"	24"	64"	QRC633G- () () L () ()	3,058.	3,983.	4,580.	6,184.
	36"	20"	64"	QRC662G- () () L () ()	3,041.	3,959.	4,553.	6,146.
	36"	24"	64"	QRC663G- () () L () ()	3,356.	4,374.	5,030.	6,791.

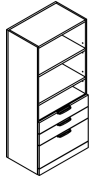
 Storage open above w/2 adj shelves, BBF below	16"	20"	64"	QRC612P- () () L () ()	2,297.	2,983.	3,430.	4,631.
	16"	24"	64"	QRC613P- () () L () ()	2,525.	3,284.	3,777.	5,098.
	30"	20"	64"	QRC632P- () () L () ()	2,666.	3,470.	3,990.	5,387.
	30"	24"	64"	QRC633P- () () L () ()	2,921.	3,803.	4,373.	5,904.
	36"	20"	64"	QRC662P- () () L () ()	2,927.	3,808.	4,379.	5,912.
	36"	24"	64"	QRC663P- () () L () ()	3,201.	4,176.	4,802.	6,483.

Order Code

Example:	QRC332FLWJL
QR	Reff Standard Special
C	Cabinets
3	38" high
3	30" wide
2	20" deep
F	File drawer
L	Laminate finish type
W	Wood interior
J	Routed pull
L	Lock drilling

Specification Information

To order please specify pattern number including:

- Hinge location, where applicable
- Finish type
- Interior option
- Pull option
- Lock option, where applicable
- Finish, cabinet
- Finish, pull when applicable
- Keying instructions

***After specifying product code, provide keying instructions.**

1. Hinge location:
 L = Left hand
 R = Right hand

2. Finish type:
 L = Laminate
 1 = V1
 2 = V2
 3 = V3

3. Interior options:
 W = Wood

4. Pull options:
 D = Metal D-pull
 J = Routed pull
 C = Nickel C-pull (nickel finish only)
 S = S-pull (stainless steel finish only)

5. Lock options:
 L = Lock hole drilled
 N = No lock drilling

8. Refer to page 199 for keying instructions.

Product on this page excluding J-pull option will accept woodgrain laminate where laminate is currently an option.
 List price for woodgrain laminate options will be current published laminate list price plus 10%.

Specify shelf paint finish on open cabinets with metal interiors.

Please note: Shelf adjustability is limited to approximately 2.5" up or down per shelf from predetermined shelf height.

Application Notes

Key alike are field installed using the KnollKey order form. Random locks are factory installed.

Cabinets do not come with lock included. Keying instructions must accompany all cabinet orders.

Hinge door cabinets have optional lock drilling which can be specified in the cabinet product code.

**Note:*
 Wardrobe cabinets do not come equipped with coat rod and boot tray. Please specify separately from standard Reff price list.

File drawers include file bars for front to back and side to side filing.

File drawers do not support bottom loading.

Applicable finishes are listed on page 102 and 103.

Reff Cabinetry
 Cabinets (use with 26 1/2" h support components)
 64" high
 metal interior

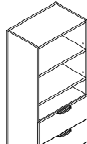
description	w	d	h	pattern no.	L	V1	V2	V3
Storage open above w/2 adj shelves, FF below 	16"	20"	64"	QRC612G-() () L () ()	\$2,100.	\$2,724.	\$3,133.	\$4,229.
	16"	24"	64"	QRC613G-() () L () ()	2,310.	3,003.	3,453.	4,662.
	30"	20"	64"	QRC632G-() () L () ()	2,638.	3,432.	3,947.	5,328.
	30"	24"	64"	QRC633G-() () L () ()	2,926.	3,807.	4,378.	5,910.
	36"	20"	64"	QRC662G-() () L () ()	2,906.	3,782.	4,349.	5,872.
	36"	24"	64"	QRC663G-() () L () ()	3,223.	4,199.	4,829.	6,519.

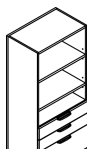
Storage open above w/2 adj shelves, BBF below 	16"	20"	64"	QRC612P-() () L () ()	2,162.	2,807.	3,228.	4,358.
	16"	24"	64"	QRC613P-() () L () ()	2,391.	3,111.	3,578.	4,830.
	30"	20"	64"	QRC632P-() () L () ()	2,531.	3,292.	3,786.	5,111.
	30"	24"	64"	QRC633P-() () L () ()	2,784.	3,626.	4,170.	5,629.
	36"	20"	64"	QRC662P-() () L () ()	2,791.	3,633.	4,178.	5,640.
	36"	24"	64"	QRC663P-() () L () ()	3,069.	3,996.	4,595.	6,204.

Order Code

Example:	QRC332FLWJL
QR	Reff Standard Special
C	Cabinets
3	38" high
3	30" wide
2	20" deep
F	File drawer
L	Laminate finish type
W	Wood interior
J	Routed pull
L	Lock drilling

Specification Information

To order please specify pattern number including:

- Hinge location, where applicable
- Finish type
- Interior option
- Pull option
- Lock option, where applicable
- Finish, cabinet
- Finish, pull when applicable
- Keying instructions

***After specifying product code, provide keying instructions.**

1. Hinge location:
 L = Left hand
 R = Right hand

2. Finish type:
 L = Laminate
 1 = V1
 2 = V2
 3 = V3

3. Interior options:
 M = Metal

4. Pull options:
 D = Metal D-pull
 J = Routed pull
 C = Nickel C-pull (nickel finish only)
 S = S-pull (stainless steel finish only)

5. Lock options:
 L = Lock hole drilled
 N = No lock drilling

8. Refer to page 199 for keying instructions.

Product on this page excluding J-pull option will accept woodgrain laminate where laminate is currently an option.
 List price for woodgrain laminate options will be current published laminate list price plus 10%.
 Specify shelf paint finish on open cabinets with metal interiors.
 Please note: Shelf adjustability is limited to approximately 2.5" up or down per shelf from predetermined shelf height.

Application Notes

Key alike are field installed using the KnollKey order form. Random locks are factory installed.

Cabinets do not come with lock included. Keying instructions must accompany all cabinet orders.

Hinge door cabinets have optional lock drilling which can be specified in the cabinet product code.

**Note:*
 Wardrobe cabinets do not come equipped with coat rod and boot tray. Please specify separately from standard Reff price list.

File drawers include file bars for front to back and side to side filing.

File drawers do not support bottom loading.

Applicable finishes are listed on page 102 and 103.

Reff Cabinetry
 Cabinets (use with 26 1/2" h support components)
 72" high
 wood interior

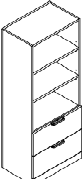
description	w	d	h	pattern no.	L	V1	V2	V3
 Storage open above w/2 adj shelves, FF below	16"	20"	72"	QRC712G-() () L () () ()	\$2,352.	\$3,057.	\$3,516.	\$4,746.
	16"	24"	72"	QRC713G-() () L () () ()	2,584.	3,361.	3,865.	5,218.
	30"	20"	72"	QRC732G-() () L () () ()	2,928.	3,809.	4,380.	5,913.
	30"	24"	72"	QRC733G-() () L () () ()	3,196.	4,165.	4,790.	6,466.
	36"	20"	72"	QRC762G-() () L () () ()	3,161.	4,117.	4,735.	6,392.
	36"	24"	72"	QRC763G-() () L () () ()	3,433.	4,474.	5,145.	6,946.

 Storage open above w/2 adj shelves, BBF below	16"	20"	72"	QRC712P-() () L () () ()	2,431.	3,162.	3,636.	4,909.
	16"	24"	72"	QRC713P-() () L () () ()	2,660.	3,462.	3,981.	5,375.
	30"	20"	72"	QRC732P-() () L () () ()	2,834.	3,689.	4,242.	5,727.
	30"	24"	72"	QRC733P-() () L () () ()	3,103.	4,041.	4,647.	6,274.
	36"	20"	72"	QRC762P-() () L () () ()	3,107.	4,046.	4,653.	6,281.
	36"	24"	72"	QRC763P-() () L () () ()	3,405.	4,437.	5,103.	6,888.

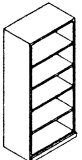
 Cabinet with open shelves	30"	15"	72"	QRC731B-() () () ()	2,329.	3,036.	3,491.	4,713.
	36"	15"	72"	QRC761B-() () () ()	2,609.	3,401.	3,911.	5,280.

Note: Cabinet must be secured to wall to prevent tipping. Hardware is included.

Order Code	Specification Information	Application Notes	
Example: RC732BLMNN R Reff C Cabinets 7 72" high 3 30" wide 2 20" deep B Full bookcase L Laminate finish M Metal interior N No drilling N No drilling	<i>To order please specify pattern number including:</i> 1. Hinge location, where applicable 2. Finish type 3. Interior option 4. Pull option 5. Lock option, where applicable 6. Finish, cabinet 7. Finish, pull when applicable 8. Left hand side of cabinet drilling: N = No drilling Size to drill for each workwall: S0 = 19"H x 15"D S1 = 19"H x 20"D T0 = 23"H x 15"D T1 = 23"H x 20"D 9. Right hand side of cabinet drilling: same as #8 above. 10. Keying instructions *After specifying product code, provide keying instructions.	1. <i>Hinge location:</i> L = Left hand R = Right hand 2. <i>Finish type:</i> L = Laminate 1 = V1 2 = V2 3 = V3 3. <i>Interior options:</i> W = Wood 4. <i>Pull options:</i> D = Metal D-pull J = Routed pull C = Nickel C-pull (nickel finish only) S = S-pull (stainless steel finish only) 5. <i>Lock options:</i> L = Lock hole drilled N = No lock drilling 10. Refer to page 199 for keying instructions. Product on this page excluding J-pull option will accept woodgrain laminate where laminate is currently an option. List price for woodgrain laminate options will be current published laminate list price plus 10%.	Key alike are field installed using the KnollKey order form. Random locks are factory installed. Cabinets do not come with lock included. Keying instructions must accompany all cabinet orders. Hinge door cabinets have optional lock drilling which can be specified in the cabinet product code. Wardrobe cabinets do not come equipped with coat rod and boot tray. Please specify separately from standard Reff price list. File drawers include file bars for front to back and side to side filing. File drawers do not support bottom loading. Applicable finishes are listed on page 102 and 103.

Please note: Shelf adjustability is limited to approximately 2.5" up or down per shelf from predetermined shelf height.

Reff Cabinetry

Cabinets (use with 26 1/2" h support components)

72" high

metal interior

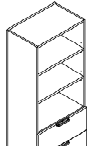
description	w	d	h	pattern no.	L, metal interiors	V1	V2	V3
Storage open above w/2 adj shelves, FF below 	16"	20"	72"	QRC712G- () () L () () ()	\$2,217.	\$2,878.	\$3,310.	\$4,468.
	16"	24"	72"	QRC713G- () () L () () ()	2,422.	3,186.	3,664.	4,946.
	30"	20"	72"	QRC732G- () () L () () ()	2,792.	3,637.	4,183.	5,646.
	30"	24"	72"	QRC733G- () () L () () ()	3,063.	3,989.	4,587.	6,193.
	36"	20"	72"	QRC762G- () () L () () ()	3,026.	3,940.	4,531.	6,117.
	36"	24"	72"	QRC763G- () () L () () ()	3,297.	4,297.	4,942.	6,671.

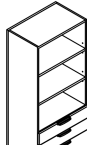
Storage open above w/2 adj shelves, BBF below 	16"	20"	72"	QRC712P- () () L () () ()	2,299.	2,985.	3,433.	4,634.
	16"	24"	72"	QRC713P- () () L () () ()	2,525.	3,284.	3,777.	5,098.
	30"	20"	72"	QRC732P- () () L () () ()	2,698.	3,510.	4,036.	5,449.
	30"	24"	72"	QRC733P- () () L () () ()	2,968.	3,866.	4,446.	6,002.
	36"	20"	72"	QRC762P- () () L () () ()	2,973.	3,871.	4,452.	6,010.
	36"	24"	72"	QRC763P- () () L () () ()	3,272.	4,259.	4,898.	6,612.

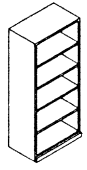
Cabinet with open shelves 	30"	15"	72"	QRC731B- () () () ()	2,171.	2,830.	3,255.	4,394.
	36"	15"	72"	QRC761B- () () () ()	2,450.	3,192.	3,671.	4,956.

Note: Cabinet must be secured to wall to prevent tipping. Hardware is included.

Order Code	Specification Information	Application Notes
Example: RC732BLMNN	<i>To order please specify pattern number including:</i>	Key alike are field installed using the KnollKey order form. Random locks are factory installed.
R Reff	1. Hinge location, where applicable	<p>Cabinets do not come with lock included. Keying instructions must accompany all cabinet orders.</p> <p>Hinge door cabinets have optional lock drilling which can be specified in the cabinet product code.</p> <p>Wardrobe cabinets do not come equipped with coat rod and boot tray. Please specify separately from standard Reff price list.</p> <p>File drawers include file bars for front to back and side to side filing.</p> <p>File drawers do not support bottom loading.</p> <p>Applicable finishes are listed on page 102 and 103.</p>
C Cabinets	2. Finish type	
7 72" high	3. Interior option	
3 30" wide	4. Pull option	
2 20" deep	5. Lock option, where applicable	
B Full bookcase	6. Finish, cabinet	
L Laminate finish	7. Finish, pull when applicable	
M Metal interior	8. Left hand side of cabinet drilling:	
N No drilling	N = No drilling	
N No drilling	Size to drill for each workwall: S0 = 19"H x 15"D S1 = 19"H x 20"D T0 = 23"H x 15"D T1 = 23"H x 20"D	
	9. Right hand side of cabinet drilling: same as #8 above.	
	10. Keying instructions	
	*After specifying product code, provide keying instructions.	
	1. Hinge location: L = Left hand R = Right hand	
	2. Finish type: L = Laminate 1 = V1 2 = V2 3 = V3	
	3. Interior options: M = Metal	
	4. Pull options: D = Metal D-pull J = Routed pull C = Nickel C-pull (nickel finish only) S = S-pull (stainless steel finish only)	
	5. Lock options: L = Lock hole drilled N = No lock drilling	
	10. Refer to page 199 for keying instructions.	
	Product on this page excluding J-pull option will accept woodgrain laminate where laminate is currently an option. List price for woodgrain laminate options will be current published laminate list price plus 10%.	

Please note: Shelf adjustability is limited to approximately 2.5" up or down per shelf from predetermined shelf height.

Reff Cabinetry
 Cabinets (use with 28³/₈" h support components)
 40¹/₂" high
 wood interior

description	w	d	h	pattern no.	L	V1	V2	V3
3 Drawer lateral file with anit-tip bar device	30"	20"	40 ¹ / ₂ "	QRC332DHF () () L () ()	\$2,193.	\$2,875.	\$3,306.	\$4,463.
	30"	24"	40 ¹ / ₂ "	QRC333DHF () () L () ()	2,418.	3,170.	3,646.	4,921.
	36"	20"	40 ¹ / ₂ "	QRC362DHF () () L () ()	2,794.	3,665.	4,215.	5,690.
	36"	24"	40 ¹ / ₂ "	QRC363DHF () () L () ()	3,066.	4,020.	4,623.	6,241.

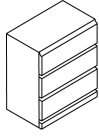

Order Code

Example:	QRC332DHFLWJL
QR	Reff Standard Special
C	Cabinets
3	40 ¹ / ₂ " high
3	30" wide
2	20" deep
DH	Desk height
F	File drawer
L	Laminate finish type
W	Wood interior
J	Routed pull
L	Lock drilling

Specification Notes

To order please specify pattern number including:

1. Finish type
2. Interior option
3. Pull option
4. Finish, cabinet
5. Finish, pull when applicable
6. Keying instructions

***After specifying product code, provide keying instructions.**

1. *Finish type:*
 L = Laminate
 1 = V1
 2 = V2
 2 = V3

2. *Interior options:*
 W = Wood

Application Notes

Key alike are field installed using the KnollKey order form. Random locks are factory installed.

File drawers include file bars for front to back and side to side filing.

Reff Cabinetry
 Cabinets (use with 28^{3/8}" h support components)
 40^{1/2}" high
 metal interior

description	w	d	h	pattern no.	L	V1	V2	V3
3 Drawer lateral file with anit-tip bar device	30"	20"	40 ^{1/2} "	QRC332DHF () () L () ()	\$2,036.	\$2,669.	\$3,069.	\$4,144.
	30"	24"	40 ^{1/2} "	QRC333DHF () () L () ()	2,267.	2,971.	3,417.	4,612.
	36"	20"	40 ^{1/2} "	QRC362DHF () () L () ()	2,629.	3,448.	3,965.	5,353.
	36"	24"	40 ^{1/2} "	QRC363DHF () () L () ()	2,902.	3,805.	4,376.	5,907.

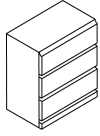

Order Code

Example:	QRC332DHFLWJL
QR	Reff Standard Special
C	Cabinets
3	40 ^{1/2} " high
3	30" wide
2	20" deep
DH	Desk height
F	File drawer
L	Laminate finish type
W	Wood interior
J	Routed pull
L	Lock drilling

Specification Information

To order please specify pattern number including:

1. Finish type
2. Interior option
3. Pull option
4. Finish, cabinet
5. Finish, pull when applicable
6. Keying instructions

***After specifying product code, provide keying instructions.**

1. Finish type:
 L = Laminate
 1 = V1
 2 = V2
 2 = V3

2. Interior options:
 W = Wood

Application Notes

Key alike are field installed using the KnollKey order form. Random locks are factory installed.

File drawers include file bars for front to back and side to side filing.

Reff Cabinetry

Cabinets (use with 28³/₈" h support components)

68" high

wood interior

description	w	d	h	pattern no.	L	V1	V2	V3
Cabinet with hinged doors for coat rod and boot tray*	16"	20"	68"	QRC612DHD (L/R) () W () () ()	\$1,963.	\$2,571.	\$2,957.	\$3,991.
	16"	24"	68"	QRC613DHD (L/R) () W () () ()	2,150.	2,818.	3,241.	4,375.
	30"	20"	68"	QRC632DHD () W () () ()	2,397.	3,141.	3,612.	4,876.
	30"	24"	68"	QRC633DHD () W () () ()	2,469.	3,241.	3,727.	5,032.
	36"	20"	68"	QRC662DHD () W () () ()	2,654.	3,480.	4,002.	5,403.
	36"	24"	68"	QRC663DHD () W () () ()	2,712.	3,579.	4,116.	5,556.

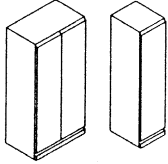

Cabinet with hinged doors and 3 adj. shelves	16"	20"	68"	QRC612DHC (L/R) () () ()	2,241.	2,937.	3,378.	4,560.
	16"	24"	68"	QRC613DHC (L/R) () () ()	2,483.	3,253.	3,741.	5,051.
	30"	20"	68"	QRC632DHC () () ()	2,919.	3,825.	4,399.	5,939.
	30"	24"	68"	QRC633DHC () () ()	3,208.	4,207.	4,838.	6,531.
	36"	20"	68"	QRC662DHC () () ()	3,177.	4,161.	4,785.	6,460.
	36"	24"	68"	QRC663DHC () () ()	3,466.	4,543.	5,224.	7,053.

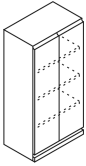

Cabinet with full height doors half wardrobe and half shelves	30"	20"	68"	QRC632DHE (L/R) () () ()	3,366.	4,410.	5,072.	6,847.
	30"	24"	68"	QRC633DHE (L/R) () () ()	3,714.	4,870.	5,600.	7,560.
	36"	20"	68"	QRC662DHE (L/R) () () ()	3,703.	4,850.	5,577.	7,529.
	36"	24"	68"	QRC663DHE (L/R) () () ()	4,085.	5,357.	6,161.	8,317.

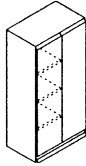

Left hand shown

Order Code

Example:	QRC612DHDLWJN
QR	Reff Standard Special
C	Cabinets
6	68" high
1	16" wide
2	20" deep
DH	Desk height
D	Wardrobe
L	Left hand hinge location
L	Laminate finish type
W	Wood interior
J	Routed pull
N	No lock drilling

Specification Information

To order please specify pattern number including:

- Hinge location, where applicable
- Finish type
- Interior option
- Pull option
- Lock option, where applicable
- Finish, cabinet
- Finish, pull when applicable
- Keying instructions

***After specifying product code, provide keying instructions.**

- Hinge location:**
L = Left hand
R = Right hand
- Finish type:**
L = Laminate
1 = V1
2 = V2
3 = V3
- Interior options:**
W = Wood

- Pull options:**
D = Metal D-pull
J = Routed pull
C = Nickel C-pull (nickel finish only)
S = S-pull (stainless steel finish only)
- Lock options:**
L = Lock hole drilled
N = No lock drilling
- Refer to page 199 for keying instructions.

Product on this page excluding J-pull option will accept woodgrain laminate where laminate is currently an option.
List price for woodgrain laminate options will be current published laminate list price plus 10%.

Specify shelf paint finish on open cabinets with metal interiors.

Please note: Shelf adjustability is limited to approximately 2.5" up or down per shelf from predetermined shelf height.

Application Notes

Key alike are field installed using the KnollKey order form. Random locks are factory installed.

Cabinets do not come with lock included. Keying instructions must accompany all cabinet orders.

Hinge door cabinets have optional lock drilling which can be specified in the cabinet product code.

**Note:*
Wardrobe cabinets do not come equipped with coat rod and boot tray. Please specify separately from standard Reff price list.

File drawers include file bars for front to back and side to side filing.

File drawers do not support bottom loading.

Applicable finishes are listed on page 102 and 103.

Reff Cabinetry

Cabinets (use with 28³/₈" h support components)

68" high

wood interior

description	w	d	h	pattern no.	L	V1	V2	V3
Cabinet with two 24 ¹ / ₄ " doors and two adj. shelves	30"	20"	68"	QRC632DHH () () ()	\$2,620.	\$3,438.	\$3,954.	\$5,338.
	30"	24"	68"	QRC633DHH () () ()	2,877.	3,772.	4,337.	5,855.
	36"	20"	68"	QRC662DHH () () ()	2,877.	3,772.	4,337.	5,855.
	36"	24"	68"	QRC663DHH () () ()	3,133.	4,110.	4,727.	6,381.

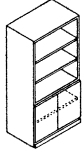

Cabinet with two sets of hinged doors, two pull-out shelves and ventilation. Audio visual cabinet	30"	20"	68"	QRC632DHI () () ()	3,673.	4,814.	5,536.	7,473.
	30"	24"	68"	QRC633DHI () () ()	4,043.	5,298.	6,093.	8,226.
	36"	20"	68"	QRC662DHI () () ()	3,929.	5,152.	5,925.	7,999.
	36"	24"	68"	QRC663DHI () () ()	4,299.	5,637.	6,483.	8,752.

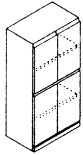

Cabinet with BBF below and hinged doors above	16"	20"	68"	QRC612DHP (L/R) () () ()	2,746.	3,596.	4,136.	5,583.
	16"	24"	68"	QRC613DHP (L/R) () () ()	3,029.	3,970.	4,565.	6,163.
	30"	20"	68"	QRC632DHP () () ()	3,205.	4,200.	4,830.	6,521.
	30"	24"	68"	QRC633DHP () () ()	3,520.	4,613.	5,305.	7,161.
	36"	20"	68"	QRC662DHP () () ()	3,527.	4,619.	5,312.	7,172.
	36"	24"	68"	QRC663DHP () () ()	3,868.	5,075.	5,836.	7,878.

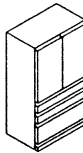

Order Code

Example:	QRC612DHDLWJN
QR	Reff Standard Special
C	Cabinets
6	68" high
1	16" wide
2	20" deep
DH	Desk height
D	Wardrobe
L	Left hand hinge location
L	Laminate finish type
W	Wood interior
J	Routed pull
N	No lock drilling

Specification Information

To order please specify pattern number including:

- Hinge location, where applicable
- Finish type
- Interior option
- Pull option
- Lock option, where applicable
- Finish, cabinet
- Finish, pull when applicable
- Keying instructions

***After specifying product code, provide keying instructions.**

- Hinge location:**
L = Left hand
R = Right hand
- Finish type:**
L = Laminate
1 = V1
2 = V2
3 = V3
- Interior options:**
W = Wood

- Pull options:**
D = Metal D-pull
J = Routed pull
C = Nickel C-pull (nickel finish only)
S = S-pull (stainless steel finish only)
- Lock options:**
L = Lock hole drilled
N = No lock drilling
- Refer to page 199 for keying instructions.

Product on this page excluding J-pull option will accept woodgrain laminate where laminate is currently an option.
List price for woodgrain laminate options will be current published laminate list price plus 10%.

Specify shelf paint finish on open cabinets with metal interiors.

Please note: Shelf adjustability is limited to approximately 2.5" up or down per shelf from predetermined shelf height.

Application Notes

Key alike are field installed using the KnollKey order form. Random locks are factory installed.

Cabinets do not come with lock included. Keying instructions must accompany all cabinet orders.

Hinge door cabinets have optional lock drilling which can be specified in the cabinet product code.

**Note:*
Wardrobe cabinets do not come equipped with coat rod and boot tray. Please specify separately from standard Reff price list.

File drawers include file bars for front to back and side to side filing.

File drawers do not support bottom loading.

Applicable finishes are listed on page 102 and 103.

Reff Cabinetry
 Cabinets (use with 28³/₈" h support components)
 68" high
 metal interior

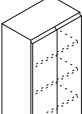
description	w	d	h	pattern no.	L	V1	V2	V3
Cabinet with hinged doors and 3 adj. shelves 	16"	20"	68"	QRC612DHC (L/R)() () ()	\$2,078.	\$2,717.	\$3,125.	\$4,219.
	16"	24"	68"	QRC613DHC (L/R)() () ()	2,316.	3,036.	3,492.	4,714.
	30"	20"	68"	QRC632DHC () () () ()	2,754.	3,611.	4,152.	5,606.
	30"	24"	68"	QRC633DHC () () () ()	3,042.	3,989.	4,587.	6,192.
	36"	20"	68"	QRC662DHC () () () ()	3,010.	3,946.	4,538.	6,126.
	36"	24"	68"	QRC663DHC () () () ()	3,297.	4,325.	4,973.	6,714.

Cabinet with full height doors half wardrobe and half shelves 	30"	20"	68"	QRC632DHE (L/R)() () ()	3,200.	4,192.	4,821.	6,508.
	30"	24"	68"	QRC633DHE (L/R)() () ()	3,549.	4,650.	5,348.	7,219.
	36"	20"	68"	QRC662DHE (L/R)() () ()	3,535.	4,631.	5,326.	7,190.
	36"	24"	68"	QRC663DHE (L/R)() () ()	3,920.	5,140.	5,911.	7,980.

Left hand shown

Order Code

Example: **QRC612DHCLLMJL-114**

QR	Reff Standard Special
C	Cabinets
6	68" high
1	16" wide
2	20" deep
DH	Desk height
C	Hinged door w/ 3 adj. shelves
L	Left hand hinge location
L	Laminate finish type
M	Metal interior
J	Routed pull
L	Locking
114	Finish, Folkstone grey

Specification Information

To order please specify pattern number including:

- Hinge location, where applicable
- Finish type
- Interior option
- Pull option
- Lock option, where applicable
- Finish, cabinet
- Finish, pull when applicable
- Keying instructions

***After specifying product code, provide keying instructions.**

1. Hinge location:
L = Left hand
R = Right hand

2. Finish type:
L = Laminate
1 = V1
2 = V2
3 = V3

3. Interior options:
M = Metal (If laminate case finish-shelves painted to match; if V1,V2 or V3 case finish-shelves painted black; drawer interiors painted black metal)

4. Pull options:
D = Metal D-pull
J = Routed pull
C = Nickel C-pull (nickel finish only)
S = S-pull (stainless steel finish only)

5. Lock options:
L = Lock hole drilled
N = No drilling

8. Refer to page 199 for keying instructions.

Product on this page excluding J-pull option will accept woodgrain laminate where laminate is currently an option.
List price for woodgrain laminate options will be current published laminate list price plus 10%.

Key alike are field installed using the KnollKey order form. Random locks are factory installed.

Please note: Shelf adjustability is limited to approximately 2.5" up or down per shelf from predetermined shelf height.

Application Notes

Specify finish of metal shelves to match laminate.

Cabinets do not come with lock included. Keying instructions must accompany all cabinet orders.

Hinge door cabinets have optional lock drilling which can be specified in the cabinet product code.

*Wardrobe cabinets do not come equipped with coat rod and boot tray. Please specify separately. See page 0.

File drawers include file bars for front to back and side to side filing.

File drawers do not support bottom loading.

Applicable finishes are listed on page 0 and 0.

Reff Cabinetry

Cabinets (use with 28³/₈" h support components)

68" high

metal interior

description	w	d	h	pattern no.	L	V1	V2	V3
Cabinet with two 24 ¹ / ₄ " doors and two adj. shelves	30"	20"	68"	QRC632DHH () () ()	\$2,454.	\$3,220.	\$3,703.	\$4,999.
	30"	24"	68"	QRC633DHH () () ()	2,713.	3,552.	4,085.	5,514.
	36"	20"	68"	QRC662DHH () () ()	2,713.	3,552.	4,085.	5,514.
	36"	24"	68"	QRC663DHH () () ()	2,970.	3,892.	4,476.	6,042.

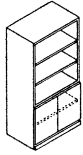

Cabinet with BBF below and hinged doors above	16"	20"	68"	QRC612DHP (L/R) () () ()	2,580.	3,379.	3,886.	5,246.
	16"	24"	68"	QRC613DHP (L/R) () () ()	2,863.	3,755.	4,319.	5,830.
	30"	20"	68"	QRC632DHP () () ()	3,037.	3,980.	4,578.	6,180.
	30"	24"	68"	QRC633DHP () () ()	3,351.	4,394.	5,053.	6,822.
	36"	20"	68"	QRC662DHP () () ()	3,360.	4,401.	5,061.	6,833.
	36"	24"	68"	QRC663DHP () () ()	3,704.	4,852.	5,580.	7,533.

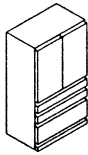

Order Code

Example: **QRC612DHCLLMJL-114**

QR	Reff Standard Special
C	Cabinets
6	68" high
1	16" wide
2	20" deep
DH	Desk height
C	Hinged door w/ 3 adj. shelves
L	Left hand hinge location
L	Laminate finish type
M	Metal interior
J	Routed pull
L	Locking
114	Finish, Folkstone grey

Specification Information

To order please specify pattern number including:

- Hinge location, where applicable
- Finish type
- Interior option
- Pull option
- Lock option, where applicable
- Finish, cabinet
- Finish, pull when applicable
- Keying instructions

***After specifying product code, provide keying instructions.**

1. Hinge location:

L = Left hand
R = Right hand

2. Finish type:

L = Laminate
1 = V1
2 = V2
3 = V3

3. Interior options:

M = Metal (If laminate case finish-shelves painted to match; if V1, V2 or V3 case finish-shelves painted black; drawer interiors painted black metal)

4. Pull options:

D = Metal D-pull
J = Routed pull
C = Nickel C-pull (nickel finish only)
S = S-pull (stainless steel finish only)

5. Lock options:

L = Lock hole drilled
N = No drilling

8. Refer to page 199 for keying instructions.

Product on this page excluding J-pull option will accept woodgrain laminate where laminate is currently an option.

List price for woodgrain laminate options will be current published laminate list price plus 10%.

Key alike are field installed using the KnollKey order form. Random locks are factory installed.

Please note: Shelf adjustability is limited to approximately 2.5" up or down per shelf from predetermined shelf height.

Application Notes

Specify finish of metal shelves to match laminate.

Cabinets do not come with lock included. Keying instructions must accompany all cabinet orders.

Hinge door cabinets have optional lock drilling which can be specified in the cabinet product code.

*Wardrobe cabinets do not come equipped with coat rod and boot tray. Please specify separately. See page 0.

File drawers include file bars for front to back and side to side filing.

File drawers do not support bottom loading.

Applicable finishes are listed on page 0 and 0.

Reff Cabinetry

Cabinets (use with 28³/₈" h support components)

75" high

wood interior

description	w	d	h	pattern no.	L	V1	V2	V3
Cabinet with adjustable shelving for coat rod and boot tray interior	30"	15"	75"	QRC731DHBW () () ()	\$2,446.	\$3,188.	\$3,666.	\$4,949.
	36"	15"	75"	QRC761DHBW () () ()	2,740.	3,571.	4,107.	5,544.

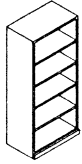

4 adjustable shelves
 Note: Cabinet must be secured to wall to prevent tipping. Hardware is included.

Cabinet with hinged doors for coat rod and boot tray*	16"	20"	75"	QRC712DHD (L/R) () W () () ()	2,164.	2,819.	3,242.	4,376.
	16"	24"	75"	QRC713DHD (L/R) () W () () ()	2,377.	3,096.	3,560.	4,807.

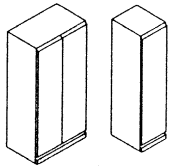

Requires one lock core per cabinet
 Note: Wardrobe cabinets do not come equipped with coat rod and boot tray. Please specify separately from standard Reff price list.

Order Code	Specification Information	Application Notes
Example: QRC731DHBW(2)(V316)	To order please specify pattern number including:	Cabinets on this page are engineered to align with front sets of 28 ³ / ₈ " h pedestals and are intended for "desk height" planning applications. Do not mix products from 26¹/₂" h (standard height) planning model with 28³/₈" h (desk height) planning model in any one configuration. 75" nominal height - actual height 75.125" Shelf adjustability is 2.5" up or down per shelf from equal drilled spacing. File drawers include file bars for front to back and side to side filing. File drawers support bottom loading.
QR Reff Standard Special	5. Lock option (where applicable) Optional hinged door configurations only Drawers always lock drilled L = drilled to accept lock N = no drilling	
C Cabinet	6. Cabinet finish	
7 75" h (nominal)	7. Optional pull finish where applicable	
3 30" w (nominal)	8. Optional drilling to support workwall, left side N = no drilling S0 = 19" h x 15" d S1 = 19" h x 20" d T0 = 23" h x 15" d T1 = 23" h x 20" d	
1 15" d (nominal)	9. Optional drilling to support workwall, right side *drilling options same as #8 above	
DH Desk height	1. Hinge location (where applicable) L = left hand R = right hand	
B Open bookcase	2. Finish type L = laminate 1 = V1 2 = V2 3 = V3	
W Interior option, wood	3. Interior Option W = wood (shelves match case finish or wood drawer interiors)	
2 Finish type, V2	4. Pull Option (where applicable) D = metal D-pull (finish optional) J = routed J-pull (finish matches case) C = nickel finish C-pull (nickel finish only) S = S-pull (stainless steel finish only)	
V316 Finish, light maple		

Applicable finishes are listed on page 102 and 103.

Product on this page excluding J-pull option will accept woodgrain laminate where laminate is currently an option.
 List price for woodgrain laminate options will be current published laminate list price plus 10%.

Cabinets do not come with lock included. Keying instructions must accompany all cabinet orders, refer to page 199.
 Random locks are factory installed. Key-alike are field installed using the KnollKey order form.

Reff Cabinetry

Cabinets (use with 28^{3/8}" h support components)

75" high

wood interior

description	w	d	h	pattern no.	L	V1	V2	V3
Cabinet with hinged door and 4 adj. shelves	16"	20"	75"	QRC712DHC(L/R) () () ()	\$2,506.	\$3,283.	\$3,775.	\$5,096.
	16"	24"	75"	QRC713DHC(L/R) () () ()	2,760.	3,620.	4,163.	5,620.
	30"	20"	75"	QRC732DHC () () ()	3,220.	4,218.	4,850.	6,548.
	30"	24"	75"	QRC733DHC () () ()	3,554.	4,657.	5,355.	7,230.
	36"	20"	75"	QRC762DHC () () ()	3,539.	4,641.	5,337.	7,205.
	36"	24"	75"	QRC763DHC () () ()	3,910.	5,124.	5,893.	7,955.

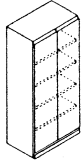

Cabinet with two hinged 24 ^{1/4} " doors and two open adj. shelves	30"	20"	75"	QRC732DHH () () ()	3,090.	4,053.	4,661.	6,292.
	30"	24"	75"	QRC733DHH () () ()	3,398.	4,459.	5,127.	6,922.
	36"	20"	75"	QRC762DHH () () ()	3,382.	4,430.	5,095.	6,878.
	36"	24"	75"	QRC763DHH () () ()	3,690.	4,835.	5,560.	7,506.

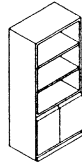

Order Code	Specification Information	Application Notes
Example: QRC731DHBW(2)(V316)	<i>To order please specify pattern number including:</i>	
QR Ref Standard Special		
C Cabinet	1. <i>Hinge location (where applicable)</i> L = left hand R = right hand	
7 75" h (nominal)	2. <i>Finish type</i> L = laminate 1 = V1 2 = V2 3 = V3	
3 30" w (nominal)	3. <i>Interior Option</i> W = wood (shelves match case finish or wood drawer interiors)	
1 15" d (nominal)	4. <i>Pull Option (where applicable)</i> D = metal D-pull (finish optional) J = routed J-pull (finish matches case) C = nickel finish C-pull (nickel finish only) S = S-pull (stainless steel finish only)	
DH Desk height	5. <i>Lock option (where applicable)</i> Optional hinged door configurations only Drawers always lock drilled L = drilled to accept lock N = no drilling	Cabinets on this page are engineered to align with front sets of 28 ^{3/8} "h pedestals and are intended for "desk height" planning applications. Do not mix products from 26^{1/2}"h (standard height) planning model with 28^{3/8}"h (desk height) planning model in any one configuration.
B Open bookcase	6. <i>Cabinet finish</i>	75" nominal height - actual height 75.125"
W Interior option, wood	7. <i>Optional pull finish where applicable</i>	Shelf adjustability is 2.5" up or down per shelf from equal drilled spacing.
2 Finish type, V2	8. <i>Optional drilling to support workwall, left side</i> N = no drilling S0 = 19"h x 15"d S1 = 19"h x 20"d T0 = 23"h x 15"d T1 = 23"h x 20"d	File drawers include file bars for front to back and side to side filing.
V316 Finish, light maple	9. <i>Optional drilling to support workwall, right side</i> *drilling options same as #8 above	File drawers support bottom loading.

Applicable finishes are listed on page 102 and 103.

Product on this page excluding J-pull option will accept woodgrain laminate where laminate is currently an option. List price for woodgrain laminate options will be current published laminate list price plus 10%.

Cabinets do not come with lock included. Keying instructions must accompany all cabinet orders, refer to page 199. Random locks are factory installed. Key-alike are field installed using the KnollKey order form.

Reff Cabinetry
Cabinets (use with 28³/₈" h support components)
75" high
wood interior

description	w	d	h	pattern no.	L	V1	V2	V3
Cabinet with two sets of hinged doors, two pull-out shelves and ventilation. Audio visual cabinet	30"	20"	75"	QRC732DHI () () ()	\$4,071.	\$5,333.	\$6,133.	\$8,280.
	30"	24"	75"	QRC733DHI () () ()	4,493.	5,889.	6,772.	9,143.
	36"	20"	75"	QRC762DHI () () ()	4,415.	5,789.	6,657.	8,987.
	36"	24"	75"	QRC763DHI () () ()	4,876.	6,393.	7,352.	9,925.

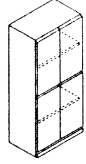

Requires two lock cores per cabinet

Cabinet with BBF below and hinged doors above	16"	20"	75"	QRC712DHP(L/R) () () ()	2,912.	3,818.	4,391.	5,928.
	16"	24"	75"	QRC713DHP(L/R) () () ()	3,197.	4,191.	4,819.	6,506.
	30"	20"	75"	QRC732DHP () () ()	3,412.	4,472.	5,143.	6,943.
	30"	24"	75"	QRC733DHP () () ()	3,746.	4,907.	5,643.	7,619.
	36"	20"	75"	QRC762DHP () () ()	3,750.	4,914.	5,651.	7,629.
	36"	24"	75"	QRC763DHP () () ()	4,120.	5,399.	6,209.	8,382.

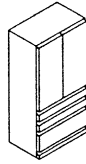

Requires two lock cores per cabinet

Order Code	Specification Information	Application Notes
Example: QRC731DHBW(2)(V316)	<i>To order please specify pattern number including:</i>	
QR Reff Standard Special	5. <i>Lock option (where applicable)</i>	Cabinets on this page are engineered to align with front sets of 28 ³ / ₈ " h pedestals and are intended for "desk height" planning applications. Do not mix products from 26¹/₂" h (standard height) planning model with 28³/₈" h (desk height) planning model in any one configuration. 75" nominal height - actual height 75.125" Shelf adjustability is 2.5" up or down per shelf from equal drilled spacing. File drawers include file bars for front to back and side to side filing. File drawers support bottom loading.
C Cabinet	1. <i>Hinge location (where applicable)</i>	
7 75" h (nominal)	L = left hand	
3 30" w (nominal)	R = right hand	
1 15" d (nominal)	2. <i>Finish type</i>	
DH Desk height	L = laminate	
B Open bookcase	1 = V1	
W Interior option, wood	2 = V2	
2 Finish type, V2	3 = V3	
V316 Finish, light maple	3. <i>Interior Option</i>	
	W = wood (shelves match case finish or wood drawer interiors)	
	4. <i>Pull Option (where applicable)</i>	
	D = metal D-pull (finish optional)	
	J = routed J-pull (finish matches case)	
	C = nickel finish C-pull (nickel finish only)	
	S = S-pull (stainless steel finish only)	
	6. <i>Cabinet finish</i>	
	7. <i>Optional pull finish where applicable</i>	
	8. <i>Optional drilling to support workwall, left side</i>	
	N = no drilling	
	S0 = 19"h x 15"d	
	S1 = 19"h x 20"d	
	T0 = 23"h x 15"d	
	T1 = 23"h x 20"d	
	9. <i>Optional drilling to support workwall, right side</i>	
	*drilling options same as #8 above	
	Product on this page excluding J-pull option will accept woodgrain laminate where laminate is currently an option.	
	List price for woodgrain laminate options will be current published laminate list price plus 10%.	
	Cabinets do not come with lock included. Keying instructions must accompany all cabinet orders, refer to page 199.	
	Random locks are factory installed. Key-alike are field installed using the KnollKey order form.	

Applicable finishes are listed on page 102 and 103.

Reff Cabinetry

Cabinets (use with 28³/₈" h support components)

75" high

metal interior

description	w	d	h	pattern no.	L	V1	V2	V3
Cabinet with adjustable shelving metal interior	30"	15"	75"	QRC731DHBM () () ()	\$2,280.	\$2,972.	\$3,418.	\$4,614.
	36"	15"	75"	QRC761DHBM () () ()	2,572.	3,352.	3,855.	5,204.

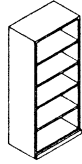

4 adjustable shelves

Note: Cabinet must be secured to wall to prevent tipping. Hardware is included.

Cabinet with hinged door and 4 adj. shelves	16"	20"	75"	QRC712DHC(L/R) () () ()	2,338.	3,062.	3,521.	4,753.
	16"	24"	75"	QRC713DHC(L/R) () () ()	2,596.	3,402.	3,912.	5,281.
	30"	20"	75"	QRC732DHC () () ()	3,052.	4,002.	4,602.	6,213.
	30"	24"	75"	QRC733DHC () () ()	3,386.	4,437.	5,103.	6,889.
	36"	20"	75"	QRC762DHC () () ()	3,374.	4,424.	5,087.	6,868.
	36"	24"	75"	QRC763DHC () () ()	3,744.	4,903.	5,639.	7,612.

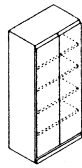

Requires one lock core per cabinet

Shelves painted metal

Order Code	Specification Information	Application Notes
Example: QRC731DHBM(2)(V316)	<i>To order please specify pattern number including:</i>	
QR Ref Standard Special		
C Cabinet	1. <i>Hinge location (where applicable)</i> L = left hand R = right hand	
7 75" h (nominal)	2. <i>Finish type</i> L = laminate 1 = V1 2 = V2 3 = V3	
3 30" w (nominal)	3. <i>Interior Option</i> M = metal (metal shelves or metal drawers) *If laminate case, specify finish of metal shelves to match; if case V1 or V2 finish, shelves are black)	
1 15" d (nominal)	4. <i>Pull Option (where applicable)</i> D = metal D-pull (finish optional) J = routed J-pull (finish matches case) C = nickel finish C-pull (nickel finish only) S = S-pull (stainless steel finish only)	
DH Desk height	5. <i>Lock option (where applicable)</i> Optional hinged door configurations only Drawers always lock drilled L = drilled to accept lock N = no drilling	Cabinets on this page are engineered to align with front sets of 28 ³ / ₈ " h pedestals and are intended for "desk height" planning applications. Do not mix products from 26¹/₂" h (standard height) planning model with 28³/₈" h (desk height) planning model in any one configuration.
B Open bookcase	6. <i>Cabinet finish</i>	75" nominal height - actual height 75.125"
M Interior option, metal	7. <i>Optional pull finish where applicable</i>	Shelf adjustability is 2.5" up or down per shelf from equal drilled spacing.
2 Finish type, V2	8. <i>Optional drilling to support workwall, left side</i> N = no drilling S0 = 19"h x 15"d S1 = 19"h x 20"d T0 = 23"h x 15"d T1 = 23"h x 20"d	File drawers include file bars for front to back and side to side filing.
V316 Finish, light maple	9. <i>Optional drilling to support workwall, right side</i> *drilling options same as #8 above	File drawers support bottom loading.
	Product on this page excluding J-pull option will accept woodgrain laminate where laminate is currently an option. List price for woodgrain laminate options will be current published laminate list price plus 10%.	
	Cabinets do not come with lock included. Keying instructions must accompany all cabinet orders, refer to page 199. Random locks are factory installed. Key-alike are field installed using the KnollKey order form.	

Applicable finishes are listed on page 102 and 103.

Reff Cabinetry

Cabinets (use with 28³/₈" h support components)

75" high

metal interior

description	w	d	h	pattern no.	L	V1	V2	V3
Cabinet with two hinged 24 ¹ / ₄ " doors and two open adj. shelves	30"	20"	75"	QRC732DHH () () ()	\$2,932.	\$3,837.	\$4,413.	\$5,957.
	30"	24"	75"	QRC733DHH () () ()	3,239.	4,240.	4,876.	6,583.
	36"	20"	75"	QRC762DHH () () ()	3,221.	4,218.	4,850.	6,548.
	36"	24"	75"	QRC763DHH () () ()	3,531.	4,621.	5,314.	7,174.

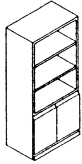

Cabinet with BBF below and hinged doors above	16"	20"	75"	QRC712DHP(L/R) () () ()	2,749.	3,599.	4,139.	5,587.
	16"	24"	75"	QRC713DHP(L/R) () () ()	3,029.	3,970.	4,565.	6,163.
	30"	20"	75"	QRC732DHP () () ()	3,243.	4,250.	4,887.	6,598.
	30"	24"	75"	QRC733DHP () () ()	3,578.	4,690.	5,394.	7,282.
	36"	20"	75"	QRC762DHP () () ()	3,584.	4,697.	5,402.	7,292.
	36"	24"	75"	QRC763DHP () () ()	3,955.	5,178.	5,955.	8,039.

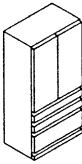

Order Code	Specification Information	Application Notes
Example: QRC731DHBM(2)(V316)	<i>To order please specify pattern number including:</i>	
QR Ref Standard Special	5. <i>Lock option (where applicable)</i>	Cabinets on this page are engineered to align with front sets of 28 ³ / ₈ " h pedestals and are intended for "desk height" planning applications. Do not mix products from 26¹/₂" h (standard height) planning model with 28³/₈" h (desk height) planning model in any one configuration.
C Cabinet	1. <i>Hinge location (where applicable)</i>	75" nominal height - actual height 75.125"
7 75" h (nominal)	L = left hand	Shelf adjustability is 2.5" up or down per shelf from equal drilled spacing.
3 30" w (nominal)	R = right hand	File drawers include file bars for front to back and side to side filing.
1 15" d (nominal)	2. <i>Finish type</i>	File drawers support bottom loading.
DH Desk height	L = laminate	
B Open bookcase	1 = V1	
M Interior option, metal	2 = V2	
2 Finish type, V2	3 = V3	
V316 Finish, light maple	3. <i>Interior Option</i>	
	M = metal (metal shelves or metal drawers)	
	*If laminate case, specify finish of metal shelves to match; if case V1 or V2 finish, shelves are black)	
	4. <i>Pull Option (where applicable)</i>	
	D = metal D-pull (finish optional)	
	J = routed J-pull (finish matches case)	
	C = nickel finish C-pull (nickel finish only)	
	S = S-pull (stainless steel finish only)	
	6. <i>Cabinet finish</i>	
	7. <i>Optional pull finish where applicable</i>	
	8. <i>Optional drilling to support workwall, left side</i>	
	N = no drilling	
	S0 = 19"h x 15"d	
	S1 = 19"h x 20"d	
	T0 = 23"h x 15"d	
	T1 = 23"h x 20"d	
	9. <i>Optional drilling to support workwall, right side</i>	
	*drilling options same as #8 above	
	Product on this page excluding J-pull option will accept woodgrain laminate where laminate is currently an option.	
	List price for woodgrain laminate options will be current published laminate list price plus 10%.	
	Cabinets do not come with lock included. Keying instructions must accompany all cabinet orders, refer to page 199.	
	Random locks are factory installed. Key-alike are field installed using the KnollKey order form.	

Applicable finishes are listed on page 102 and 103.

Reff Overhead storage
*overdesk units, standard height planning model
 use with 1 1/4" worksurfaces and 26 1/2" h support*

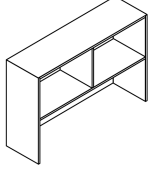
description	d	w	h	doors	pattern no.	lam.	V1	V2	V3
For 1 1/4" worksurfaces Open, 14" deep 	14"	30"	44 1/4"		QROAO30T0 () () () ()	\$1,565.	\$1,956.	\$2,249.	\$3,037.
	14"	36"	44 1/4"		QROAO36T0 () () () ()	1,640.	2,054.	2,362.	3,189.
	14"	42"	44 1/4"		QROAO42T0 () () () ()	1,716.	2,152.	2,475.	3,341.
	14"	48"	44 1/4"		QROAO48T0 () () () ()	1,791.	2,250.	2,588.	3,493.
	14"	54"	44 1/4"		QROAO54T0 () () () ()	1,867.	2,348.	2,700.	3,645.
	14"	66"	44 1/4"		QROAO66T0 () () () ()	2,381.	2,991.	3,440.	4,644.
	14"	78"	44 1/4"		QROAO78T0 () () () ()	2,532.	2,701.	3,106.	4,193.
	14"	84"	44 1/4"		QROAO84T0 () () () ()	2,605.	3,285.	3,778.	5,100.

center divider on 42" and wider.

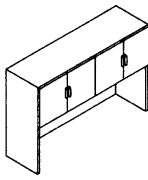
For 1 1/4" worksurfaces Hinged doors, 15" deep 	15"	30"	44 1/4"	2	QROAH30T0 () () () () () ()	2,289.	2,867.	3,297.	4,451.
	15"	36"	44 1/4"	2	QROAH36T0 () () () () () ()	2,423.	3,036.	3,491.	4,713.
	15"	42"	44 1/4"	3	QROAH42T0 () () () () () ()	2,556.	3,205.	3,686.	4,976.
	15"	48"	44 1/4"	3	QROAH48T0 () () () () () ()	2,689.	3,374.	3,880.	5,238.
	15"	54"	44 1/4"	3	QROAH54T0 () () () () () ()	2,823.	3,542.	4,073.	5,499.
	15"	66"	44 1/4"	4	QROAH66T0 () () () () () ()	3,577.	4,480.	5,152.	6,955.
	15"	78"	44 1/4"	4	QROAH78T0 () () () () () ()	3,843.	4,818.	5,541.	7,480.
	15"	84"	44 1/4"	6	QROAH84T0 () () () () () ()	3,977.	4,987.	5,735.	7,742.

Order Code	Specification Information	Application Notes
Example: QROAF30S0LJLBF118 ()	To order please specify pattern number including:	Shipped knocked-down.
QR Reff Standard Special		Open cabinets require no locks.
O Overhead		Tasklights not included.
A For 1 1/4" top mounting	1. Configuration option O = Open H = Hinged door F = Flip door	Tackboard included, fabric railroaded.
F Flip door	2. Width	C, D and S pulls are not available for flip door units.
30 30" wide	3. Storage option S0 = 19"h x 15"d S1 = 19"h x 20"d T0 = 23"h x 15"d T1 = 23"h x 20"d	All flip door cabinets on this page are nominal 19"H not 23"H.
S Standard height	4. Finish type L = Laminate	Open/hinge doors are nominal 23"H, actual 22 3/8".
0 15" deep	1 = V1	Locks are not factory installed.
L Finish type, laminate	2 = V2	Include grommet (black only) in back panel for task light cord. If used in open plan areas specify "no grommet."
J J-pull	3 = V3	Wire manager is included and mounts adjacent to tackboard. Specify color.
L Locks included	5. Pull option for hinged door only D = Metal D-pull (for hinged doors only) J = Routed pull C = Nickel C-pull (nickel finish only, for hinged doors only) S = Stainless steel finish S-pull (stainless steel finish only, for hinged doors only)	
BF Cord escape, back feed	6. Lock option L = Lockhole drilled N = No lock drilling	
118 Finish, Bright White	7. Cord escape option	
(W250) Fabric	8. Finish	
	9. Pull finish where applicable	
	10. Fabric for tackboard	
	Product on this page excluding J-pull option will accept woodgrain laminate where laminate is currently an option. List price for woodgrain laminate options will be current published laminate list price plus 10%.	
	*After specifying product code, provide keying instructions.	
	Overdesk unit will achieve 72" nominal height when used with correct top.	
	The clearance under the overhead to the top of the worksurface is approximately 21 1/4".	
	Applicable finishes are listed on page 102 and 103.	
	Odd numbered hinged door is always on left side, left hinged.	

Reff Overhead storage
overdesk units, standard height planning model
use with 1 1/4" worksurfaces and 26 1/2" h support

description	d	w	h	doors	pattern no.	lam.	V1	V2	V3
For 1 1/4" worksurfaces	15"	30"	44 1/4"	1	QROAF30S0 () () () ()	\$1,509.	\$2,059.	\$2,368.	\$3,197.
Flip doors, 15" deep	15"	36"	44 1/4"	1	QROAF36S0 () () () ()	1,736.	2,367.	2,722.	3,675.
	15"	42"	44 1/4"	1	QROAF42S0 () () () ()	1,962.	2,675.	3,076.	4,153.
	15"	48"	44 1/4"	1	QROAF48S0 () () () ()	2,189.	2,983.	3,430.	4,631.
	15"	54"	44 1/4"	2	QROAF54S0 () () () ()	2,415.	3,291.	3,785.	5,109.
	15"	66"	44 1/4"	2	QROAF66S0 () () () ()	2,869.	4,171.	4,797.	6,475.
	15"	78"	44 1/4"	2	QROAF78S0 () () () ()	3,717.	4,754.	5,467.	7,381.
	15"	90"	44 1/4"	2	QROAF90S0 () () () ()	3,807.	4,883.	5,615.	7,581.

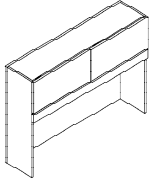

For 1 1/4" worksurfaces	19"	30"	44 1/4"		QROAO30T1 () () () ()	1,657.	2,061.	2,370.	3,200.
Open, 19" deep	19"	36"	44 1/4"		QROAO36T1 () () () ()	1,738.	2,169.	2,494.	3,367.
	19"	42"	44 1/4"		QROAO42T1 () () () ()	1,820.	2,276.	2,617.	3,533.
	19"	48"	44 1/4"		QROAO48T1 () () () ()	1,901.	2,384.	2,742.	3,701.
	19"	54"	44 1/4"		QROAO54T1 () () () ()	1,982.	2,491.	2,865.	3,867.
	19"	66"	44 1/4"		QROAO66T1 () () () ()	2,520.	3,166.	3,641.	4,915.
	19"	78"	44 1/4"		QROAO78T1 () () () ()	2,602.	3,381.	3,888.	5,249.
	19"	84"	44 1/4"		QROAO84T1 () () () ()	2,766.	3,488.	4,011.	5,415.

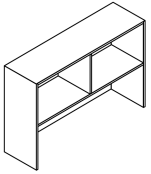

center divider on 42" and wider.

Order Code	Specification Information	Application Notes
Example: QROAF30S0LJLBF118 ()	To order please specify pattern number including:	Shipped knocked-down.
QR Reff Standard Special	1. Configuration option	Open cabinets require no locks.
O Overhead	O = Open	Tasklights not included.
A For 1 1/4" top mounting	H = Hinged door	Tackboard included, fabric railroaded.
F Flip door	F = Flip door	C, D and S pulls are not available for flip door units.
30 30" wide	2. Width	All flip door cabinets on this page are nominal 19"H not 23"H.
S Standard height	3. Storage option	Open/hinge doors are nominal 23"H, actual 22 3/8".
0 15" deep	S0 = 19"h x 15"d	Locks are not factory installed.
L Finish type, laminate	S1 = 19"h x 20"d	Include grommet (black only) in back panel for task light cord. If used in open plan areas specify "no grommet."
J J-pull	T0 = 23"h x 15"d	Wire manager is included and mounts adjacent to tackboard. Specify color.
L Locks included	T1 = 23"h x 20"d	
BF Cord escape, back feed	4. Finish type	
118 Finish, Bright White	L = Laminate	
(W250) Fabric	1 = V1	
	2 = V2	
	3 = V3	
	5. Pull option for hinged door only	
	D = Metal D-pull (for hinged doors only)	
	J = Routed pull	
	C = Nickel C-pull (nickel finish only, for hinged doors only)	
	S = Stainless steel finish S-pull (stainless steel finish only, for hinged doors only)	
	6. Lock option	
	L = Lockhole drilled	
	N = No lock drilling	
	7. Cord escape option	
	8. Finish	
	9. Pull finish where applicable	
	10. Fabric for tackboard	
	Product on this page excluding J-pull option will accept woodgrain laminate where laminate is currently an option.	
	List price for woodgrain laminate options will be current published laminate list price plus 10%.	
	*After specifying product code, provide keying instructions.	
	Overdesk unit will achieve 72" nominal height when used with correct top.	
	The clearance under the overhead to the top of the worksurface is approximately 21 1/4".	
	Applicable finishes are listed on page 102 and 103.	
	Odd numbered hinged door is always on left side, left hinged.	

Reff Overhead storage
overdesk units, standard height planning model
use with 1 1/4" worksurfaces and 26 1/2" h support

description	d	w	h	doors	pattern no.	lam.	V1	V2	V3
For 1 1/4" worksurfaces	20"	30"	44 1/4"	2	QROAH30T1 () () () () () ()	\$2,411.	\$3,020.	\$3,473.	\$4,689.
Hinged doors, 20" deep	20"	36"	44 1/4"	2	QROAH36T1 () () () () () ()	2,555.	3,201.	3,681.	4,970.
	20"	42"	44 1/4"	3	QROAH42T1 () () () () () ()	2,699.	3,383.	3,890.	5,252.
	20"	48"	44 1/4"	3	QROAH48T1 () () () () () ()	2,843.	3,565.	4,100.	5,535.
	20"	54"	44 1/4"	3	QROAH54T1 () () () () () ()	2,987.	3,747.	4,309.	5,817.
	20"	66"	44 1/4"	4	QROAH66T1 () () () () () ()	3,776.	4,729.	5,438.	7,342.
	20"	78"	44 1/4"	4	QROAH78T1 () () () () () ()	3,920.	5,094.	5,858.	7,908.
	20"	84"	44 1/4"	6	QROAH84T1 () () () () () ()	4,207.	5,276.	6,067.	8,191.

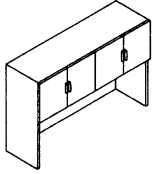

For 1 1/4" worksurfaces	20"	30"	44 1/4"	1	QROAF30S1 () () () ()	1,608.	2,191.	2,520.	3,402.
Flip doors, 20" deep	20"	36"	44 1/4"	1	QROAF36S1 () () () ()	1,846.	2,515.	2,892.	3,905.
	20"	42"	44 1/4"	1	QROAF42S1 () () () ()	2,083.	2,838.	3,264.	4,406.
	20"	48"	44 1/4"	1	QROAF48S1 () () () ()	2,320.	3,161.	3,635.	4,907.
	20"	54"	44 1/4"	2	QROAF54S1 () () () ()	2,557.	3,485.	4,008.	5,410.
	20"	66"	44 1/4"	2	QROAF66S1 () () () ()	3,030.	4,404.	5,065.	6,837.
	20"	78"	44 1/4"	2	QROAF78S1 () () () ()	3,929.	5,028.	5,782.	7,806.
	20"	90"	44 1/4"	2	QROAF90S1 () () () ()	4,031.	5,172.	5,948.	8,030.

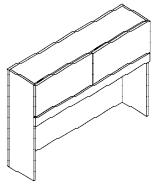

Order Code	Specification Information	Application Notes
Example: QROAF30S0LJLBF118()	To order please specify pattern number including:	Shipped knocked-down.
QR Reff Standard Special		Open cabinets require no locks.
O Overhead	1. Configuration option	Tasklights not included.
A For 1 1/4" top mounting	O = Open	Tackboard included, fabric railroaded.
F Flip door	H = Hinged door	C, D and S pulls are not available for flip door units.
30 30" wide	F = Flip door	All flip door cabinets on this page are nominal 19"H not 23"H.
S Standard height	2. Width	Open/hinge doors are nominal 23"H, actual 22 3/8".
0 15" deep	3. Storage option	Locks are not factory installed.
L Finish type, laminate	S0 = 19"h x 15"d	Include grommet (black only) in back panel for task light cord. If used in open plan areas specify "no grommet."
J J-pull	S1 = 19"h x 20"d	Wire manager is included and mounts adjacent to tackboard. Specify color.
L Locks included	T0 = 23"h x 15"d	
BF Cord escape, back feed	T1 = 23"h x 20"d	
118 Finish, Bright White	4. Finish type	
(W250) Fabric	L = Laminate	
	1 = V1	
	2 = V2	
	3 = V3	
	5. Pull option for hinged door only	
	D = Metal D-pull (for hinged doors only)	
	J = Routed pull	
	C = Nickel C-pull (nickel finish only, for hinged doors only)	
	S = Stainless steel finish S-pull (stainless steel finish only, for hinged doors only)	
	6. Lock option	
	L = Lockhole drilled	
	N = No lock drilling	
	7. Cord escape option	
	8. Finish	
	9. Pull finish where applicable	
	10. Fabric for tackboard	
	Product on this page excluding J-pull option will accept woodgrain laminate where laminate is currently an option.	
	List price for woodgrain laminate options will be current published laminate list price plus 10%.	
	*After specifying product code, provide keying instructions.	
	Overdesk unit will achieve 72" nominal height when used with correct top.	
	The clearance under the overhead to the top of the worksurface is approximately 21 1/4".	
	Applicable finishes are listed on page 102 and 103.	
	Odd numbered hinged door is always on left side, left hinged.	

Reff Overhead storage
*overdesk units, standard height planning model
 use with 1³/₄" worksurfaces and 26¹/₂"h support*

description	d	w	h	doors	pattern no.	lam.	V1	V2	V3
For 1 ³ / ₄ " worksurfaces Open, 14" deep	14"	30"	43 ³ / ₄ "		QROB030T0 () () () ()	\$1,429.	\$1,809.	\$2,080.	\$2,808.
	14"	36"	43 ³ / ₄ "		QROB036T0 () () () ()	1,543.	1,952.	2,245.	3,030.
	14"	42"	43 ³ / ₄ "		QROB042T0 () () () ()	1,658.	2,095.	2,409.	3,252.
	14"	48"	43 ³ / ₄ "		QROB048T0 () () () ()	1,772.	2,237.	2,573.	3,473.
	14"	54"	43 ³ / ₄ "		QROB054T0 () () () ()	1,887.	2,380.	2,737.	3,695.
	14"	66"	43 ³ / ₄ "		QROB066T0 () () () ()	2,392.	3,027.	3,481.	4,699.
	14"	78"	43 ³ / ₄ "		QROB078T0 () () () ()	2,621.	3,312.	3,809.	5,142.
	14"	84"	43 ³ / ₄ "		QROB084T0 () () () ()	2,735.	3,455.	3,973.	5,364.

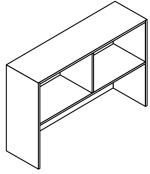

center divider on 42" and wider.

For 1 ³ / ₄ " worksurfaces Hinged doors, 15" deep	15"	30"	43 ³ / ₄ "	2	QROBH30T0 () () () () () ()	2,316.	2,896.	3,330.	4,496.
	15"	36"	43 ³ / ₄ "	2	QROBH36T0 () () () () () ()	2,451.	3,067.	3,527.	4,762.
	15"	42"	43 ³ / ₄ "	3	QROBH42T0 () () () () () ()	2,585.	3,238.	3,724.	5,027.
	15"	48"	43 ³ / ₄ "	3	QROBH48T0 () () () () () ()	2,720.	3,409.	3,920.	5,292.
	15"	54"	43 ³ / ₄ "	3	QROBH54T0 () () () () () ()	2,854.	3,580.	4,117.	5,558.
	15"	66"	43 ³ / ₄ "	4	QROBH66T0 () () () () () ()	3,618.	4,530.	5,210.	7,033.
	15"	78"	43 ³ / ₄ "	4	QROBH78T0 () () () () () ()	3,887.	4,873.	5,604.	7,565.
	15"	84"	43 ³ / ₄ "	6	QROBH84T0 () () () () () ()	4,020.	5,045.	5,802.	7,832.

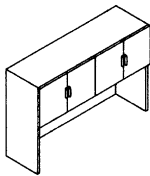

Order Code	Specification Information	Application Notes
Example: QROBF30S0LJLBF118()	To order please specify pattern number including:	Shipped knocked-down.
QR Reff Standard Special	1. Configuration option	Open cabinets require no locks.
O Overhead	O = Open	Tasklights not included.
B For 1 ³ / ₄ " top mounting	H = Hinged door	Tackboard included, fabric railroded.
F Flip door	F = Flip door	C, D and S pulls are not available for flip door units.
30 30" wide	2. Width	All flip door cabinets on this page are nominal 19"H not 23"H.
S Standard height	3. Storage option	Open/hinge doors are nominal 23"H, actual 22 ³ / ₈ ".
0 15" deep	S0 = 19"h x 15"d	Locks are not factory installed.
L Finish type, laminate	S1 = 19"h x 20"d	Include grommet (black only) in back panel for task light cord. If used in open plan areas specify "no grommet."
J J-pull	T0 = 23"h x 15"d	Wire manager is included and mounts adjacent to tackboard. Specify color.
L Locks included	T1 = 23"h x 20"d	
BF Cord escape, back feed	4. Finish type	
118 Finish, Bright White	L = Laminate	
(W250) Fabric	1 = V1	
	2 = V2	
	3 = V3	
	5. Pull option for hinged door only	
	D = Metal D-pull (for hinged doors only)	
	J = Routed pull	
	C = Nickel C-pull (nickel finish only, for hinged doors only)	
	S = Stainless steel finish S-pull (stainless steel finish only, for hinged doors only)	
	6. Lock option	
	L = Lockhole drilled	
	N = No lock drilling	
	7. Cord escape option	
	8. Finish	
	9. Pull finish where applicable	
	10. Fabric for tackboard	
	*After specifying product code, provide keying instructions.	
	Overdesk unit will achieve 72" nominal height when used with correct top.	
	The clearance under the overhead to the top of the worksurface is approximately 20 ³ / ₄ ".	
	Applicable finishes are listed on page 102 and 103.	
	Odd numbered hinged door is always on left side, left hinged.	

Reff Overhead storage
overdesk units, standard height planning model
use with 1 3/4" worksurfaces and 26 1/2" h support

description	d	w	h	doors	pattern no.	lam.	V1	V2	V3
For 1 3/4" worksurfaces	15"	30"	43 3/4"	1	QROBF30S0 () () () ()	\$1,522.	\$2,079.	\$2,391.	\$3,228.
Flip doors, 15" deep	15"	36"	43 3/4"	1	QROBF36S0 () () () ()	1,752.	2,392.	2,751.	3,714.
	15"	42"	43 3/4"	1	QROBF42S0 () () () ()	1,982.	2,705.	3,111.	4,200.
	15"	48"	43 3/4"	1	QROBF48S0 () () () ()	2,213.	3,017.	3,470.	4,684.
	15"	54"	43 3/4"	2	QROBF54S0 () () () ()	2,443.	3,330.	3,829.	5,170.
	15"	66"	43 3/4"	2	QROBF66S0 () () () ()	2,902.	4,219.	4,852.	6,550.
	15"	78"	43 3/4"	2	QROBF78S0 () () () ()	3,759.	4,804.	5,525.	7,458.
	15"	90"	43 3/4"	2	QROBF90S0 () () () ()	3,852.	4,943.	5,684.	7,674.

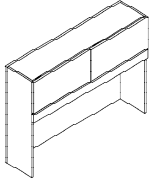

For 1 3/4" worksurfaces	19"	30"	43 3/4"		QROBO30T1 () () () ()	1,752.	2,183.	2,510.	3,389.
Open, 19" deep	19"	36"	43 3/4"		QROBO36T1 () () () ()	1,815.	2,268.	2,608.	3,521.
	19"	42"	43 3/4"		QROBO42T1 () () () ()	1,877.	2,353.	2,706.	3,653.
	19"	48"	43 3/4"		QROBO48T1 () () () ()	1,940.	2,438.	2,804.	3,785.
	19"	54"	43 3/4"		QROBO54T1 () () () ()	2,002.	2,523.	2,901.	3,917.
	19"	66"	43 3/4"		QROBO66T1 () () () ()	2,550.	3,203.	3,683.	4,973.
	19"	78"	43 3/4"		QROBO78T1 () () () ()	2,676.	3,374.	3,880.	5,238.
	19"	84"	43 3/4"		QROBO84T1 () () () ()	2,739.	3,459.	3,978.	5,370.

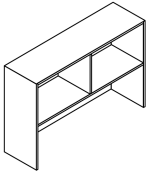

center divider on 42" and wider.

Order Code	Specification Information	Application Notes
Example: QROBF30S0LJLBF118()	To order please specify pattern number including:	Shipped knocked-down.
QR Reff Standard Special	1. Configuration option	Open cabinets require no locks.
O Overhead	O = Open	Tasklights not included.
B For 1 3/4" top mounting	H = Hinged door	Tackboard included, fabric railroded.
F Flip door	F = Flip door	C, D and S pulls are not available for flip door units.
30 30" wide	2. Width	All flip door cabinets on this page are nominal 19"H not 23"H.
S Standard height	3. Storage option	Open/hinge doors are nominal 23"H, actual 22 3/8".
0 15" deep	S0 = 19"h x 15"d	Locks are not factory installed.
L Finish type, laminate	S1 = 19"h x 20"d	Include grommet (black only) in back panel for task light cord. If used in open plan areas specify "no grommet."
J J-pull	T0 = 23"h x 15"d	Wire manager is included and mounts adjacent to tackboard. Specify color.
L Locks included	T1 = 23"h x 20"d	
BF Cord escape, back feed	4. Finish type	
118 Finish, Bright White	L = Laminate	
(W250) Fabric	1 = V1	
	2 = V2	
	3 = V3	
	5. Pull option for hinged door only	
	D = Metal D-pull (for hinged doors only)	
	J = Routed pull	
	C = Nickel C-pull (nickel finish only, for hinged doors only)	
	S = Stainless steel finish S-pull (stainless steel finish only, for hinged doors only)	
	6. Lock option	
	L = Lockhole drilled	
	N = No lock drilling	
	7. Cord escape option	
	8. Finish	
	9. Pull finish where applicable	
	10. Fabric for tackboard	
	*After specifying product code, provide keying instructions.	
	Overdesk unit will achieve 72" nominal height when used with correct top.	
	The clearance under the overhead to the top of the worksurface is approximately 20 3/4".	
	Applicable finishes are listed on page 102 and 103.	
	Odd numbered hinged door is always on left side, left hinged.	

Reff Overhead storage
*overdesk units, standard height planning model
 use with 1³/₄" worksurfaces and 26¹/₂"h support*

description	d	w	h	doors	pattern no.	lam.	V1	V2	V3
For 1 ³ / ₄ " worksurfaces	20"	30"	43 ³ / ₄ "	2	QROBH30T1 () () () () () ()	\$2,441.	\$3,042.	\$3,498.	\$4,723.
Hinged doors, 20" deep	20"	36"	43 ³ / ₄ "	2	QROBH36T1 () () () () () ()	2,587.	3,227.	3,711.	5,010.
	20"	42"	43 ³ / ₄ "	3	QROBH42T1 () () () () () ()	2,732.	3,413.	3,925.	5,299.
	20"	48"	43 ³ / ₄ "	3	QROBH48T1 () () () () () ()	2,877.	3,598.	4,138.	5,586.
	20"	54"	43 ³ / ₄ "	3	QROBH54T1 () () () () () ()	3,022.	3,783.	4,350.	5,873.
	20"	66"	43 ³ / ₄ "	4	QROBH66T1 () () () () () ()	3,820.	4,783.	5,500.	7,426.
	20"	78"	43 ³ / ₄ "	4	QROBH78T1 () () () () () ()	4,110.	5,153.	5,926.	8,000.
	20"	84"	43 ³ / ₄ "	4	QROBH84T1 () () () () () ()	4,254.	5,338.	6,139.	8,287.

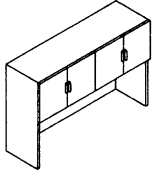

For 1 ³ / ₄ " worksurfaces	20"	30"	43 ³ / ₄ "	1	QROBF30S1 () () () ()	1,630.	2,217.	2,550.	3,442.
Flip doors, 20" deep	20"	36"	43 ³ / ₄ "	1	QROBF36S1 () () () ()	1,869.	2,543.	2,924.	3,948.
	20"	42"	43 ³ / ₄ "	1	QROBF42S1 () () () ()	2,109.	2,869.	3,299.	4,454.
	20"	48"	43 ³ / ₄ "	1	QROBF48S1 () () () ()	2,348.	3,194.	3,673.	4,959.
	20"	54"	43 ³ / ₄ "	2	QROBF54S1 () () () ()	2,588.	3,520.	4,048.	5,465.
	20"	66"	43 ³ / ₄ "	2	QROBF66S1 () () () ()	3,066.	4,453.	5,121.	6,913.
	20"	78"	43 ³ / ₄ "	2	QROBF78S1 () () () ()	3,978.	5,088.	5,851.	7,899.
	20"	90"	43 ³ / ₄ "	2	QROBF90S1 () () () ()	4,079.	5,231.	6,016.	8,121.

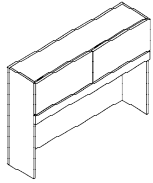

Order Code	Specification Information	Application Notes
Example: QROBF30S0LJLBF118()	To order please specify pattern number including:	Shipped knocked-down.
QR Reff Standard Special	1. Configuration option	Open cabinets require no locks.
O Overhead	O = Open	Tasklights not included.
B For 1 ³ / ₄ " top mounting	H = Hinged door	Tackboard included, fabric railroded.
F Flip door	F = Flip door	C, D and S pulls are not available for flip door units.
30 30" wide	2. Width	All flip door cabinets on this page are nominal 19"H not 23"H.
S Standard height	3. Storage option	Open/hinge doors are nominal 23"H, actual 22 ³ / ₈ ".
0 15" deep	S0 = 19"h x 15"d	Locks are not factory installed.
L Finish type, laminate	S1 = 19"h x 20"d	Include grommet (black only) in back panel for task light cord. If used in open plan areas specify "no grommet."
J J-pull	T0 = 23"h x 15"d	Wire manager is included and mounts adjacent to tackboard. Specify color.
L Locks included	T1 = 23"h x 20"d	
BF Cord escape, back feed	4. Finish type	
118 Finish, Bright White	L = Laminate	
(W250) Fabric	1 = V1	
	2 = V2	
	3 = V3	
	5. Pull option for hinged door only	
	D = Metal D-pull (for hinged doors only)	
	J = Routed pull	
	C = Nickel C-pull (nickel finish only, for hinged doors only)	
	S = Stainless steel finish S-pull (stainless steel finish only, for hinged doors only)	
	6. Lock option	
	L = Lockhole drilled	
	N = No lock drilling	
	7. Cord escape option	
	8. Finish	
	9. Pull finish where applicable	
	10. Fabric for tackboard	
	*After specifying product code, provide keying instructions.	
	Overdesk unit will achieve 72" nominal height when used with correct top.	
	The clearance under the overhead to the top of the worksurface is approximately 20 ³ / ₄ ".	
	Applicable finishes are listed on page 102 and 103.	
	Odd numbered hinged door is always on left side, left hinged.	

Reff Overhead storage
overdesk units, desk height planning model
use with 1 1/4" worksurfaces and 28 3/8" h support

description	d	w	h	doors	pattern no.	lam.	V1	V2	V3
For 1 1/4" worksurfaces Open, 14" deep	14"	30"	45 1/2"		QROAO30T0DH () () ()	\$1,643.	\$2,054.	\$2,362.	\$3,189.
	14"	36"	45 1/2"		QROAO36T0DH () () ()	1,723.	2,157.	2,481.	3,349.
	14"	42"	45 1/2"		QROAO42T0DH () () ()	1,802.	2,260.	2,599.	3,509.
	14"	48"	45 1/2"		QROAO48T0DH () () ()	1,881.	2,363.	2,717.	3,669.
	14"	54"	45 1/2"		QROAO54T0DH () () ()	1,960.	2,466.	2,836.	3,828.
	14"	66"	45 1/2"		QROAO66T0DH () () ()	2,500.	3,141.	3,612.	4,876.
	14"	78"	45 1/2"		QROAO78T0DH () () ()	2,659.	3,347.	3,849.	5,196.
	14"	84"	45 1/2"		QROAO84T0DH () () ()	2,735.	3,449.	3,966.	5,355.

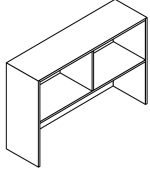

center divider on 42" and wider.

Order Code	Specification Information	Application Notes
Example: QROAO30T0DHLBF118()	<i>To order please specify pattern number including:</i>	<p>Products on this page are engineered to align with 75" h cabinets. Be sure storage dimension options and drilling options correspond accordingly. For storage options below the work surface, specify 28 3/8" h products. ; do not mix products from 26 1/2" h (standard height) planning model with 28 3/8" h (desk height) planning model in any one configuration.</p> <p>Overdesk unit will achieve 75" nominal height - actual height 75.125", when used with correct thickness of top.</p> <p>Clearance below overhead storage to top of work surface is approximately 23 1/8" h.</p> <p>Applicable finishes are listed on page 102 and 103.</p> <p>Odd numbered hinged door is always on left side, left hinged.</p>
QR Reff Standard Special	1. <i>Configuration option (embedded in pattern number)</i> O = Open H = Hinged doors F = Flip doors	
O Overhead	2. <i>Storage option (embedded in pattern number)</i> S0 = 19" h x 15" d S1 = 19" h x 20" d T0 = 23" h x 15" d T1 = 23" h x 20" d	
A For mounting on 1 1/4" thick top	3. <i>Finish type</i> L = laminate 1 = V1 2 = V2 3 = V3	
O Open	4. <i>Pull option</i> (Optional hinged door configurations only) D = metal D-pull (finish optional) J = routed J-pull (finish matches case) C = nickel finish C-pull (nickel finish only) S = S-pull (stainless steel finish only)	
30 30" wide	5. <i>Lock option</i> (Optional hinged door configurations only) L = drilled to accept lock N = no drilling	
T 23" h storage	6. <i>Tasklight cord escape</i> BF = back feed FF = front feed	
0 15" d storage	7. <i>Finish</i>	
DH desk height, 75" height overall	8. <i>Optional pull finish, where applicable</i>	
L Finish type, laminate	9. <i>Fabric for tackboard</i>	
BF Cord escape, back feed	Product on this page excluding J-pull option will accept woodgrain laminate where laminate is currently an option. List price for woodgrain laminate options will be current published laminate list price plus 10%.	
118 Finish, Bright White	Overdesk units do not come with lock included. Keying instructions must accompany all orders, refer to page 199. Random locks are factory installed. Key-alike are field installed using the KnollKey order form.	
() Fabric selection	Products on this page shipped knocked-down. Tasklights not included. Tackboard included, fabric orientation applied railroaded. Wire manager included and mounts adjacent to tackboard. Specify color. Include grommet (black only) in back panel for tasklight cord. If used in open plan areas, specify "no grommet"	

dimensions noted nominal

Reff Overhead storage
overdesk units, desk height planning model
use with 1 1/4" worksurfaces and 28 3/8" h support

description	d	w	h	doors	pattern no.	lam.	V1	V2	V3
For 1 1/4" worksurfaces	15"	30"	45 1/2"	2	QROAH30T0DH () () () () ()	\$2,404.	\$3,011.	\$3,463.	\$4,675.
Hinged doors, 15" deep	15"	36"	45 1/2"	2	QROAH36T0DH () () () () ()	2,544.	3,188.	3,666.	4,949.
	15"	42"	45 1/2"	3	QROAH42T0DH () () () () ()	2,683.	3,365.	3,870.	5,224.
	15"	48"	45 1/2"	3	QROAH48T0DH () () () () ()	2,824.	3,542.	4,073.	5,499.
	15"	54"	45 1/2"	3	QROAH54T0DH () () () () ()	2,964.	3,719.	4,277.	5,774.
	15"	66"	45 1/2"	4	QROAH66T0DH () () () () ()	3,756.	4,704.	5,410.	7,303.
	15"	78"	45 1/2"	4	QROAH78T0DH () () () () ()	4,036.	5,059.	5,818.	7,854.
	15"	84"	45 1/2"	6	QROAH84T0DH () () () () ()	4,176.	5,236.	6,021.	8,129.

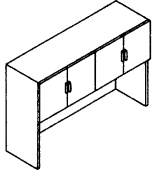

Order Code	Specification Information	Application Notes
Example: QROAO30T0DHLBF118()	To order please specify pattern number including:	<p>Products on this page are engineered to align with 75" h cabinets. Be sure storage dimension options and drilling options correspond accordingly. For storage options below the work surface, specify 28 3/8" h products. ; do not mix products from 26 1/2" h (standard height) planning model with 28 3/8" h (desk height) planning model in any one configuration.</p> <p>Overdesk unit will achieve 75" nominal height - actual height 75.125", when used with correct thickness of top.</p> <p>Clearance below overhead storage to top of work surface is approximately 23 1/8" h.</p> <p>Applicable finishes are listed on page 102 and 103.</p> <p>Odd numbered hinged door is always on left side, left hinged.</p>
QR Reff Standard Special	1. Configuration option (embedded in pattern number) O = Open H = Hinged doors F = Flip doors	
O Overhead	2. Storage option (embedded in pattern number) S0 = 19" h x 15" d S1 = 19" h x 20" d T0 = 23" h x 15" d T1 = 23" h x 20" d	
A For mounting on 1 1/4" thick top	3. Finish type L = laminate	
O Open	4. Pull option (Optional hinged door configurations only) D = metal D-pull (finish optional) J = routed J-pull (finish matches case) C = nickel finish C-pull (nickel finish only) S = S-pull (stainless steel finish only)	
30 30" wide	5. Lock option (Optional hinged door configurations only) L = drilled to accept lock N = no drilling	
T 23" h storage	6. Tasklight cord escape BF = back feed FF = front feed	
0 15" d storage	7. Finish	
DH desk height, 75" height overall	8. Optional pull finish, where applicable	
L Finish type, laminate	9. Fabric for tackboard	
BF Cord escape, back feed	Product on this page excluding J-pull option will accept woodgrain laminate where laminate is currently an option. List price for woodgrain laminate options will be current published laminate list price plus 10%.	
118 Finish, Bright White	Overdesk units do not come with lock included. Keying instructions must accompany all orders, refer to page 199. Random locks are factory installed. Key-alike are field installed using the KnollKey order form.	
() Fabric selection	Products on this page shipped knocked-down. Tasklights not included. Tackboard included, fabric orientation applied railroaded. Wire manager included and mounts adjacent to tackboard. Specify color. Include grommet (black only) in back panel for tasklight cord. If used in open plan areas, specify "no grommet"	

dimensions noted nominal

Reff Overhead storage
overdesk units, desk height planning model
use with 1 1/4" worksurfaces and 28 3/8" h support

description	d	w	h	doors	pattern no.	lam.	V1	V2	V3
For 1 1/4" worksurfaces	15"	30"	45 1/2"	1	QROAF30S0DH() () () ()	\$1,585.	\$2,162.	\$2,486.	\$3,357.
Flip doors, 15" deep	15"	36"	45 1/2"	1	QROAF36S0DH() () () ()	1,823.	2,485.	2,858.	3,858.
	15"	42"	45 1/2"	1	QROAF42S0DH() () () ()	2,060.	2,809.	3,230.	4,361.
	15"	48"	45 1/2"	1	QROAF48S0DH() () () ()	2,299.	3,132.	3,602.	4,862.
	15"	54"	45 1/2"	2	QROAF54S0DH() () () ()	2,536.	3,456.	3,974.	5,365.
	15"	66"	45 1/2"	2	QROAF66S0DH() () () ()	3,013.	4,380.	5,037.	6,800.
	15"	78"	45 1/2"	2	QROAF78S0DH() () () ()	3,903.	4,992.	5,741.	7,750.
	15"	90"	45 1/2"	2	QROAF90S0DH() () () ()	3,997.	5,127.	5,896.	7,960.

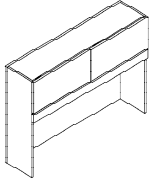

Order Code	Specification Information	Application Notes
Example: QROAO30T0DHLBF118()	To order please specify pattern number including:	<p>Products on this page are engineered to align with 75" h cabinets. Be sure storage dimension options and drilling options correspond accordingly. For storage options below the work surface, specify 28 3/8" h products. ; do not mix products from 26 1/2" h (standard height) planning model with 28 3/8" h (desk height) planning model in any one configuration.</p> <p>Overdesk unit will achieve 75" nominal height - actual height 75.125", when used with correct thickness of top.</p> <p>Clearance below overhead storage to top of work surface is approximately 23 1/8" h.</p> <p>Applicable finishes are listed on page 102 and 103.</p> <p>Odd numbered hinged door is always on left side, left hinged.</p>
QR Reff Standard Special		
O Overhead	1. Configuration option (embedded in pattern number) O = Open H = Hinged doors F = Flip doors	
A For mounting on 1 1/4" thick top	2. Storage option (embedded in pattern number) S0 = 19" h x 15" d S1 = 19" h x 20" d T0 = 23" h x 15" d T1 = 23" h x 20" d	
O Open	3. Finish type L = laminate	
30 30" wide	4. Pull option (Optional hinged door configurations only) D = metal D-pull (finish optional) J = routed J-pull (finish matches case) C = nickel finish C-pull (nickel finish only) S = S-pull (stainless steel finish only)	
T 23" h storage	5. Lock option (Optional hinged door configurations only) L = drilled to accept lock N = no drilling	
0 15" d storage	6. Tasklight cord escape BF = back feed FF = front feed	
DH desk height, 75" height overall	7. Finish	
L Finish type, laminate	8. Optional pull finish, where applicable	
BF Cord escape, back feed	9. Fabric for tackboard	
118 Finish, Bright White	Product on this page excluding J-pull option will accept woodgrain laminate where laminate is currently an option. List price for woodgrain laminate options will be current published laminate list price plus 10%.	
() Fabric selection	Overdesk units do not come with lock included. Keying instructions must accompany all orders, refer to page 199. Random locks are factory installed. Key-alike are field installed using the KnollKey order form.	
	Products on this page shipped knocked-down.	
	Tasklights not included.	
	Tackboard included, fabric orientation applied railroaded.	
	Wire manager included and mounts adjacent to tackboard. Specify color.	
	Include grommet (black only) in back panel for tasklight cord. If used in open plan areas, specify "no grommet"	

dimensions noted nominal

Reff Overhead storage
overdesk units, desk height planning model
use with 1 1/4" worksurfaces and 28 3/8" h support

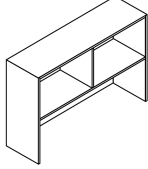
description	d	w	h	doors	pattern no.	lam.	V1	V2	V3
For 1 1/4" worksurfaces Open, 19" deep 	19"	30"	45 1/2"		QROAO30T1DH () () ()	\$1,739.	\$2,165.	\$2,490.	\$3,361.
	19"	36"	45 1/2"		QROAO36T1DH () () ()	1,825.	2,277.	2,619.	3,535.
	19"	42"	45 1/2"		QROAO42T1DH () () ()	1,910.	2,390.	2,749.	3,710.
	19"	48"	45 1/2"		QROAO48T1DH () () ()	1,997.	2,503.	2,878.	3,886.
	19"	54"	45 1/2"		QROAO54T1DH () () ()	2,082.	2,616.	3,008.	4,061.
	19"	66"	45 1/2"		QROAO66T1DH () () ()	2,647.	3,324.	3,823.	5,161.
	19"	78"	45 1/2"		QROAO78T1DH () () ()	2,732.	3,550.	4,082.	5,511.
	19"	84"	45 1/2"		QROAO84T1DH () () ()	2,904.	3,662.	4,211.	5,685.

center divider on 42" and wider.

Order Code	Specification Information	Application Notes
Example: QROAO30T0DHLBF118()	<i>To order please specify pattern number including:</i>	Products on this page are engineered to align with 75" h cabinets. Be sure storage dimension options and drilling options correspond accordingly. For storage options below the work surface, specify 28 3/8" h products. ; do not mix products from 26 1/2" h (standard height) planning model with 28 3/8" h (desk height) planning model in any one configuration. Overdesk unit will achieve 75" nominal height - actual height 75.125", when used with correct thickness of top. Clearance below overhead storage to top of work surface is approximately 23 1/8" h. Applicable finishes are listed on page 102 and 103. Odd numbered hinged door is always on left side, left hinged.
QR Reff Standard Special	1. <i>Configuration option (embedded in pattern number)</i> O = Open H = Hinged doors F = Flip doors	
O Overhead	2. <i>Storage option (embedded in pattern number)</i> S0 = 19" h x 15" d S1 = 19" h x 20" d T0 = 23" h x 15" d T1 = 23" h x 20" d	
A For mounting on 1 1/4" thick top	3. <i>Finish type</i> L = laminate 1 = V1 2 = V2 3 = V3	
O Open	4. <i>Pull option</i> (Optional hinged door configurations only) D = metal D-pull (finish optional) J = routed J-pull (finish matches case) C = nickel finish C-pull (nickel finish only) S = S-pull (stainless steel finish only)	
30 30" wide	5. <i>Lock option</i> (Optional hinged door configurations only) L = drilled to accept lock N = no drilling	
T 23" h storage	6. <i>Tasklight cord escape</i> BF = back feed FF = front feed	
0 15" d storage	7. <i>Finish</i>	
DH desk height, 75" height overall	8. <i>Optional pull finish, where applicable</i>	
L Finish type, laminate	9. <i>Fabric for tackboard</i> Product on this page excluding J-pull option will accept woodgrain laminate where laminate is currently an option. List price for woodgrain laminate options will be current published laminate list price plus 10%. Overdesk units do not come with lock included. Keying instructions must accompany all orders, refer to page 199. Random locks are factory installed. Key-alike are field installed using the KnollKey order form. Products on this page shipped knocked-down. Tasklights not included. Tackboard included, fabric orientation applied railroaded. Wire manager included and mounts adjacent to tackboard. Specify color. Include grommet (black only) in back panel for tasklight cord. If used in open plan areas, specify "no grommet"	
BF Cord escape, back feed		
118 Finish, Bright White		
() Fabric selection		

dimensions noted nominal

Reff Overhead storage
overdesk units, desk height planning model
use with 1 1/4" worksurfaces and 28 3/8" h support

description	d	w	h	doors	pattern no.	lam.	V1	V2	V3
For 1 1/4" worksurfaces	20"	30"	45 1/2"	2	QROAH30T1DH () () () () ()	\$2,531.	\$3,171.	\$3,647.	\$4,923.
Hinged doors, 20" deep	20"	36"	45 1/2"	2	QROAH36T1DH () () () () ()	2,682.	3,361.	3,865.	5,218.
	20"	42"	45 1/2"	3	QROAH42T1DH () () () () ()	2,833.	3,552.	4,085.	5,514.
	20"	48"	45 1/2"	3	QROAH48T1DH () () () () ()	2,984.	3,743.	4,304.	5,811.
	20"	54"	45 1/2"	3	QROAH54T1DH () () () () ()	3,136.	3,934.	4,524.	6,108.
	20"	66"	45 1/2"	4	QROAH66T1DH () () () () ()	3,965.	4,966.	5,711.	7,710.
	20"	78"	45 1/2"	4	QROAH78T1DH () () () () ()	4,116.	5,349.	6,151.	8,304.
	20"	84"	45 1/2"	6	QROAH84T1DH () () () () ()	4,417.	5,540.	6,371.	8,601.

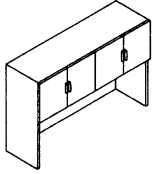

Order Code	Specification Information	Application Notes
Example: QROAO30T0DHLBF118()	To order please specify pattern number including:	<p>Products on this page are engineered to align with 75" h cabinets. Be sure storage dimension options and drilling options correspond accordingly. For storage options below the work surface, specify 28 3/8" h products. ; do not mix products from 26 1/2" h (standard height) planning model with 28 3/8" h (desk height) planning model in any one configuration.</p> <p>Overdesk unit will achieve 75" nominal height - actual height 75.125", when used with correct thickness of top.</p> <p>Clearance below overhead storage to top of work surface is approximately 23 1/8" h.</p> <p>Applicable finishes are listed on page 102 and 103.</p> <p>Odd numbered hinged door is always on left side, left hinged.</p>
QR Reff Standard Special	1. Configuration option (embedded in pattern number) O = Open H = Hinged doors F = Flip doors	
O Overhead	2. Storage option (embedded in pattern number) S0 = 19" h x 15" d S1 = 19" h x 20" d T0 = 23" h x 15" d T1 = 23" h x 20" d	
A For mounting on 1 1/4" thick top	3. Finish type L = laminate	
O Open	4. Pull option (Optional hinged door configurations only) D = metal D-pull (finish optional) J = routed J-pull (finish matches case) C = nickel finish C-pull (nickel finish only) S = S-pull (stainless steel finish only)	
30 30" wide	5. Lock option (Optional hinged door configurations only) L = drilled to accept lock N = no drilling	
T 23" h storage	6. Tasklight cord escape BF = back feed FF = front feed	
0 15" d storage	7. Finish	
DH desk height, 75" height overall	8. Optional pull finish, where applicable	
L Finish type, laminate	9. Fabric for tackboard	
BF Cord escape, back feed	Product on this page excluding J-pull option will accept woodgrain laminate where laminate is currently an option. List price for woodgrain laminate options will be current published laminate list price plus 10%.	
118 Finish, Bright White	Overdesk units do not come with lock included. Keying instructions must accompany all orders, refer to page 199. Random locks are factory installed. Key-alike are field installed using the KnollKey order form.	
() Fabric selection	Products on this page shipped knocked-down. Tasklights not included. Tackboard included, fabric orientation applied railroaded. Wire manager included and mounts adjacent to tackboard. Specify color. Include grommet (black only) in back panel for tasklight cord. If used in open plan areas, specify "no grommet"	

dimensions noted nominal

Reff Overhead storage
overdesk units, desk height planning model
use with 1 1/4" worksurfaces and 28 3/8" h support

description	d	w	h	doors	pattern no.	lam.	V1	V2	V3
For 1 1/4" worksurfaces	20"	30"	45 1/2"	1	QROAF30S1DH () () () ()	\$1,689.	\$2,301.	\$2,646.	\$3,572.
Flip doors, 20" deep	20"	36"	45 1/2"	1	QROAF36S1DH () () () ()	1,938.	2,640.	3,036.	4,099.
	20"	42"	45 1/2"	1	QROAF42S1DH () () () ()	2,187.	2,980.	3,427.	4,626.
	20"	48"	45 1/2"	1	QROAF48S1DH () () () ()	2,436.	3,319.	3,817.	5,153.
	20"	54"	45 1/2"	2	QROAF54S1DH () () () ()	2,685.	3,659.	4,208.	5,681.
	20"	66"	45 1/2"	2	QROAF66S1DH () () () ()	3,181.	4,624.	5,318.	7,179.
	20"	78"	45 1/2"	2	QROAF78S1DH () () () ()	4,126.	5,279.	6,071.	8,196.
	20"	90"	45 1/2"	2	QROAF90S1DH () () () ()	4,233.	5,431.	6,246.	8,432.

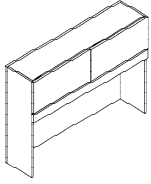

Order Code	Specification Information	Application Notes
Example: QROAO30T0DHLBF118()	To order please specify pattern number including:	<p>Products on this page are engineered to align with 75" h cabinets. Be sure storage dimension options and drilling options correspond accordingly. For storage options below the work surface, specify 28 3/8" h products. ; do not mix products from 26 1/2" h (standard height) planning model with 28 3/8" h (desk height) planning model in any one configuration.</p> <p>Overdesk unit will achieve 75" nominal height - actual height 75.125", when used with correct thickness of top.</p> <p>Clearance below overhead storage to top of work surface is approximately 23 1/8" h.</p> <p>Applicable finishes are listed on page 102 and 103.</p> <p>Odd numbered hinged door is always on left side, left hinged.</p>
QR Reff Standard Special	1. Configuration option (embedded in pattern number) O = Open H = Hinged doors F = Flip doors	
O Overhead	2. Storage option (embedded in pattern number) S0 = 19" h x 15" d S1 = 19" h x 20" d T0 = 23" h x 15" d T1 = 23" h x 20" d	
A For mounting on 1 1/4" thick top	3. Finish type L = laminate	
O Open	4. Pull option (Optional hinged door configurations only) D = metal D-pull (finish optional) J = routed J-pull (finish matches case) C = nickel finish C-pull (nickel finish only) S = S-pull (stainless steel finish only)	
30 30" wide	5. Lock option (Optional hinged door configurations only) L = drilled to accept lock N = no drilling	
T 23" h storage	6. Tasklight cord escape BF = back feed FF = front feed	
0 15" d storage	7. Finish	
DH desk height, 75" height overall	8. Optional pull finish, where applicable	
L Finish type, laminate	9. Fabric for tackboard	
BF Cord escape, back feed	Product on this page excluding J-pull option will accept woodgrain laminate where laminate is currently an option. List price for woodgrain laminate options will be current published laminate list price plus 10%.	
118 Finish, Bright White	Overdesk units do not come with lock included. Keying instructions must accompany all orders, refer to page 199. Random locks are factory installed. Key-alike are field installed using the KnollKey order form.	
() Fabric selection	Products on this page shipped knocked-down. Tasklights not included. Tackboard included, fabric orientation applied railroaded. Wire manager included and mounts adjacent to tackboard. Specify color. Include grommet (black only) in back panel for tasklight cord. If used in open plan areas, specify "no grommet"	

dimensions noted nominal

Reff Overhead storage
overdesk units, desk height planning model
use with 1³/₄" worksurfaces and 28³/₈"h support

description	d	w	h	doors	pattern no.	L	V1	V2	V3
For 1 ³ / ₄ " worksurfaces	14"	30"	45"		QROBO30T0DH () () ()	\$1,501.	\$1,899.	\$2,184.	\$2,948.
Open, 14" deep	14"	36"	45"		QROBO36T0DH () () ()	1,620.	2,049.	2,356.	3,181.
	14"	42"	45"		QROBO42T0DH () () ()	1,741.	2,199.	2,529.	3,414.
	14"	48"	45"		QROBO48T0DH () () ()	1,861.	2,349.	2,701.	3,647.
	14"	54"	45"		QROBO54T0DH () () ()	1,981.	2,499.	2,874.	3,880.
	14"	66"	45"		QROBO66T0DH () () ()	2,511.	3,178.	3,655.	4,934.
	14"	78"	45"		QROBO78T0DH () () ()	2,752.	3,478.	4,000.	5,400.
	14"	84"	45"		QROBO84T0DH () () ()	2,872.	3,628.	4,172.	5,632.

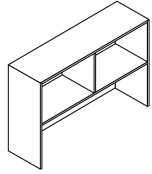

center divider on 42" and wider.

Order Code	Specification Information	Application Notes
Example: QROBO30T0DHLBF118()	<i>To order please specify pattern number including:</i>	
QR Reff Standard Special		
O Overhead	1. <i>Configuration option (embedded in pattern number)</i> O = Open H = Hinged doors F = Flip doors	6. <i>Tasklight cord escape</i> BF = back feed FF = front feed
B For mounting on 1 ³ / ₄ " thick top	2. <i>Storage option (embedded in pattern number)</i> S0 = 19"h x 15"d S1 = 19"h x 20"d T0 = 23"h x 15"d T1 = 23"h x 20"d	7. <i>Finish</i>
O Open	3. <i>Finish type</i> L = laminate 1 = V1 2 = V2 3 = V3	8. <i>Optional pull finish, where applicable</i>
30 30" wide	4. <i>Pull option</i> (Optional hinged door configurations only) D = metal D-pull (finish optional) J = routed J-pull (finish matches case) C = nickel finish C-pull (nickel finish only) S = S-pull (stainless steel finish only)	9. <i>Fabric for tackboard</i>
T 23"h storage		Overdesk units do not come with lock included. Keying instructions must accompany all orders, refer to page 199. Random locks are factory installed. Key-alike are field installed using the KnollKey order form.
0 15"d storage		Products on this page shipped knocked-down.
DH desk height, 75" height overall		Tasklights not included.
L Finish type, laminate		Tackboard included, fabric orientation applied railroaded.
BF Cord escape, back feed		Wire manager included and mounts adjacent to tackboard. Specify color.
118 Finish, Bright White		Include grommet (black only) in back panel for tasklight cord. If used in open plan areas, specify "no grommet"
() Fabric selection	5. <i>Lock option</i> (Optional hinged door configurations only) L = drilled to accept lock N = no drilling	Products on this page are engineered to align with 75"h cabinets. Be sure storage dimension options and drilling options correspond accordingly. For storage options below the worksurface, specify 28 ³ / ₈ "h products; do not mix products from 26¹/₂"h (standard height) planning model with 28³/₈"h (desk height) planning model in any one configuration.

dimensions noted nominal

Overdesk unit will achieve 75" nominal height - actual height 75.125", when used with correct thickness of top.

Clearance below overhead storage to top of worksurface is approximately 22⁵/₈"h.

Applicable finishes are listed on page 102 and 103.

Odd numbered hinged door is always on left side, left hinged.

Reff Overhead storage
overdesk units, desk height planning model
use with 1³/₄" worksurfaces and 28³/₈"h support

description	d	w	h	doors	pattern no.	L	V1	V2	V3
For 1 ³ / ₄ " worksurfaces	15"	30"	45"	2	QROBH30T0DH () () () () ()	\$2,432.	\$3,041.	\$3,497.	\$4,721.
Hinged doors, 15" deep	15"	36"	45"	2	QROBH36T0DH () () () () ()	2,574.	3,220.	3,703.	4,999.
	15"	42"	45"	3	QROBH42T0DH () () () () ()	2,715.	3,400.	3,910.	5,279.
	15"	48"	45"	3	QROBH48T0DH () () () () ()	2,856.	3,579.	4,116.	5,556.
	15"	54"	45"	3	QROBH54T0DH () () () () ()	2,997.	3,759.	4,323.	5,836.
	15"	66"	45"	4	QROBH66T0DH () () () () ()	3,798.	4,757.	5,471.	7,385.
	15"	78"	45"	4	QROBH78T0DH () () () () ()	4,082.	5,117.	5,885.	7,944.
	15"	84"	45"	4	QROBH84T0DH () () () () ()	4,221.	5,297.	6,092.	8,224.

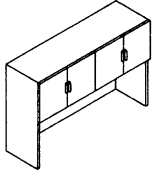

Order Code	Specification Information	Application Notes
Example: QROBO30T0DHLBF118()	<i>To order please specify pattern number including:</i>	
QR Reff Standard Special	1. <i>Configuration option (embedded in pattern number)</i>	6. <i>Tasklight cord escape</i>
O Overhead	O = Open	BF = back feed
B For mounting on 1 ³ / ₄ " thick top	H = Hinged doors	FF = front feed
O Open	F = Flip doors	7. <i>Finish</i>
30 30" wide	2. <i>Storage option (embedded in pattern number)</i>	8. <i>Optional pull finish, where applicable</i>
T 23"h storage	S0 = 19"h x 15"d	9. <i>Fabric for tackboard</i>
0 15"d storage	S1 = 19"h x 20"d	
DH desk height, 75" height overall	T0 = 23"h x 15"d	Overdesk units do not come with lock included. Keying instructions must accompany all orders, refer to page 199. Random locks are factory installed. Key-alike are field installed using the KnollKey order form.
L Finish type, laminate	T1 = 23"h x 20"d	Products on this page shipped knocked-down.
BF Cord escape, back feed	3. <i>Finish type</i>	Tasklights not included.
118 Finish, Bright White	L = laminate	Tackboard included, fabric orientation applied railroaded.
() Fabric selection	1 = V1	Wire manager included and mounts adjacent to tackboard. Specify color.
	2 = V2	Include grommet (black only) in back panel for tasklight cord. If used in open plan areas, specify "no grommet"
	3 = V3	
	4. <i>Pull option</i>	
	(Optional hinged door configurations only)	
	D = metal D-pull (finish optional)	
	J = routed J-pull (finish matches case)	
	C = nickel finish C-pull (nickel finish only)	
	S = S-pull (stainless steel finish only)	
	5. <i>Lock option</i>	
	(Optional hinged door configurations only)	
	L = drilled to accept lock	
	N = no drilling	

dimensions noted nominal

Products on this page are engineered to align with 75"h cabinets. Be sure storage dimension options and drilling options correspond accordingly. For storage options below the worksurface, specify 28³/₈"h products; **do not mix products from 26¹/₂"h (standard height) planning model with 28³/₈"h (desk height) planning model in any one configuration.**

Overdesk unit will achieve 75" nominal height - actual height 75.125", when used with correct thickness of top.

Clearance below overhead storage to top of worksurface is approximately 22⁵/₈"h.

Applicable finishes are listed on page 102 and 103.

Odd numbered hinged door is always on left side, left hinged.

Reff Overhead storage
overdesk units, desk height planning model
use with 1³/₄" worksurfaces and 28³/₈"h support

description	d	w	h	doors	pattern no.	L	V1	V2	V3
For 1 ³ / ₄ " worksurfaces	15"	30"	45"	1	QROBF30S0DH () () () ()	\$1,599.	\$2,183.	\$2,510.	\$3,389.
Flip doors, 15" deep	15"	36"	45"	1	QROBF36S0DH () () () ()	1,840.	2,511.	2,888.	3,898.
	15"	42"	45"	1	QROBF42S0DH () () () ()	2,082.	2,840.	3,266.	4,409.
	15"	48"	45"	1	QROBF48S0DH () () () ()	2,323.	3,168.	3,643.	4,918.
	15"	54"	45"	2	QROBF54S0DH () () () ()	2,565.	3,496.	4,020.	5,428.
	15"	66"	45"	2	QROBF66S0DH () () () ()	3,047.	4,429.	5,093.	6,876.
	15"	78"	45"	2	QROBF78S0DH () () () ()	3,947.	5,044.	5,801.	7,831.
	15"	90"	45"	2	QROBF90S0DH () () () ()	4,044.	5,190.	5,969.	8,057.

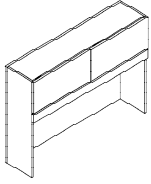

Order Code	Specification Information	Application Notes
Example: QROBO30T0DHLBF118 ()	<i>To order please specify pattern number including:</i>	
QR Reff Standard Special	1. <i>Configuration option (embedded in pattern number)</i>	6. <i>Tasklight cord escape</i> BF = back feed FF = front feed
O Overhead	O = Open	7. <i>Finish</i>
B For mounting on 1 ³ / ₄ " thick top	H = Hinged doors	8. <i>Optional pull finish, where applicable</i>
O Open	F = Flip doors	9. <i>Fabric for tackboard</i>
30 30" wide	2. <i>Storage option (embedded in pattern number)</i>	Overdesk units do not come with lock included. Keying instructions must accompany all orders, refer to page 199. Random locks are factory installed. Key-alike are field installed using the KnollKey order form.
T 23"h storage	S0 = 19"h x 15"d	Products on this page shipped knocked-down.
0 15"d storage	S1 = 19"h x 20"d	Tasklights not included.
DH desk height, 75" height overall	T0 = 23"h x 15"d	Tackboard included, fabric orientation applied railroaded.
L Finish type, laminate	T1 = 23"h x 20"d	Wire manager included and mounts adjacent to tackboard. Specify color.
BF Cord escape, back feed	3. <i>Finish type</i>	Include grommet (black only) in back panel for tasklight cord. If used in open plan areas, specify "no grommet"
118 Finish, Bright White	L = laminate	
() Fabric selection	1 = V1	
	2 = V2	
	3 = V3	
	4. <i>Pull option</i> (Optional hinged door configurations only)	
	D = metal D-pull (finish optional)	
	J = routed J-pull (finish matches case)	
	C = nickel finish C-pull (nickel finish only)	
	S = S-pull (stainless steel finish only)	
	5. <i>Lock option</i> (Optional hinged door configurations only)	
	L = drilled to accept lock	
	N = no drilling	

dimensions noted nominal

Products on this page are engineered to align with 75"h cabinets. Be sure storage dimension options and drilling options correspond accordingly. For storage options below the worksurface, specify 28³/₈"h products; **do not mix products from 26¹/₂"h (standard height) planning model with 28³/₈"h (desk height) planning model in any one configuration.**

Overdesk unit will achieve 75" nominal height - actual height 75.125", when used with correct thickness of top.

Clearance below overhead storage to top of worksurface is approximately 22⁵/₈"h.

Applicable finishes are listed on page 102 and 103.

Odd numbered hinged door is always on left side, left hinged.

Reff Overhead storage
overdesk units, desk height planning model
use with 1³/₄" worksurfaces and 28³/₈"h support

description	d	w	h	doors	pattern no.	L	V1	V2	V3
For 1 ³ / ₄ " worksurfaces Open, 19" deep	19"	30"	45"		QROBO30T1DH () () ()	\$1,840.	\$2,292.	\$2,636.	\$3,558.
	19"	36"	45"		QROBO36T1DH () () ()	1,906.	2,381.	2,738.	3,697.
	19"	42"	45"		QROBO42T1DH () () ()	1,972.	2,471.	2,842.	3,836.
	19"	48"	45"		QROBO48T1DH () () ()	2,037.	2,560.	2,944.	3,974.
	19"	54"	45"		QROBO54T1DH () () ()	2,103.	2,649.	3,046.	4,113.
	19"	66"	45"		QROBO66T1DH () () ()	2,677.	3,363.	3,867.	5,221.
	19"	78"	45"		QROBO78T1DH () () ()	2,810.	3,542.	4,073.	5,499.
	19"	84"	45"		QROBO84T1DH () () ()	2,876.	3,632.	4,177.	5,639.

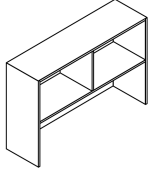

center divider on 42" and wider.

Order Code	Specification Information	Application Notes
Example: QROBO30T0DHLBF118()	To order please specify pattern number including:	<p>Products on this page are engineered to align with 75" h cabinets. Be sure storage dimension options and drilling options correspond accordingly. For storage options below the worksurface, specify 28³/₈" h products; do not mix products from 26¹/₂" h (standard height) planning model with 28³/₈" h (desk height) planning model in any one configuration.</p> <p>Overdesk unit will achieve 75" nominal height - actual height 75.125", when used with correct thickness of top.</p> <p>Clearance below overhead storage to top of worksurface is approximately 22⁵/₈" h.</p> <p>Applicable finishes are listed on page 102 and 103.</p> <p>Odd numbered hinged door is always on left side, left hinged.</p>
QR Reff Standard Special		
O Overhead		
B For mounting on 1 ³ / ₄ " thick top		
O Open		
30 30" wide		
T 23" h storage		
0 15" d storage		
DH desk height, 75" height overall		
L Finish type, laminate		
BF Cord escape, back feed		
118 Finish, Bright White		
() Fabric selection		
	<p>1. Configuration option (embedded in pattern number) O = Open H = Hinged doors F = Flip doors</p> <p>2. Storage option (embedded in pattern number) S0 = 19" h x 15" d S1 = 19" h x 20" d T0 = 23" h x 15" d T1 = 23" h x 20" d</p> <p>3. Finish type L = laminate 1 = V1 2 = V2 3 = V3</p> <p>4. Pull option (Optional hinged door configurations only) D = metal D-pull (finish optional) J = routed J-pull (finish matches case) C = nickel finish C-pull (nickel finish only) S = S-pull (stainless steel finish only)</p> <p>5. Lock option (Optional hinged door configurations only) L = drilled to accept lock N = no drilling</p> <p>6. Tasklight cord escape BF = back feed FF = front feed</p> <p>7. Finish</p> <p>8. Optional pull finish, where applicable</p> <p>9. Fabric for tackboard</p> <p>Overdesk units do not come with lock included. Keying instructions must accompany all orders, refer to page 199. Random locks are factory installed. Key-alike are field installed using the KnollKey order form.</p> <p>Products on this page shipped knocked-down.</p> <p>Tasklights not included.</p> <p>Tackboard included, fabric orientation applied railroaded.</p> <p>Wire manager included and mounts adjacent to tackboard. Specify color.</p> <p>Include grommet (black only) in back panel for tasklight cord. If used in open plan areas, specify "no grommet"</p>	

dimensions noted nominal

Reff Overhead storage
overdesk units, desk height planning model
use with 1³/₄" worksurfaces and 28³/₈"h support

description	d	w	h	doors	pattern no.	L	V1	V2	V3
For 1 ³ / ₄ " worksurfaces	20"	30"	45"	2	QROBH30T1DH () () () () ()	\$2,563.	\$3,194.	\$3,673.	\$4,959.
Hinged doors, 20" deep	20"	36"	45"	2	QROBH36T1DH () () () () ()	2,716.	3,389.	3,897.	5,261.
	20"	42"	45"	3	QROBH42T1DH () () () () ()	2,869.	3,583.	4,120.	5,563.
	20"	48"	45"	3	QROBH48T1DH () () () () ()	3,021.	3,778.	4,345.	5,865.
	20"	54"	45"	3	QROBH54T1DH () () () () ()	3,173.	3,972.	4,568.	6,167.
	20"	66"	45"	4	QROBH66T1DH () () () () ()	4,011.	5,022.	5,775.	7,797.
	20"	78"	45"	4	QROBH78T1DH () () () () ()	4,315.	5,411.	6,223.	8,401.
	20"	84"	45"	6	QROBH84T1DH () () () () ()	4,466.	5,605.	6,446.	8,702.

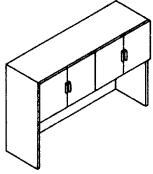

Order Code	Specification Information	Application Notes
Example: QROBO30T0DHLBF118()	<i>To order please specify pattern number including:</i>	
QR Reff Standard Special	1. <i>Configuration option (embedded in pattern number)</i>	6. <i>Tasklight cord escape</i> BF = back feed FF = front feed
O Overhead	O = Open	7. <i>Finish</i>
B For mounting on 1 ³ / ₄ " thick top	H = Hinged doors	8. <i>Optional pull finish, where applicable</i>
O Open	F = Flip doors	9. <i>Fabric for tackboard</i>
30 30" wide	2. <i>Storage option (embedded in pattern number)</i>	Overdesk units do not come with lock included. Keying instructions must accompany all orders, refer to page 199. Random locks are factory installed. Key-alike are field installed using the KnollKey order form.
T 23"h storage	S0 = 19"h x 15"d	Products on this page shipped knocked-down.
0 15"d storage	S1 = 19"h x 20"d	Tasklights not included.
DH desk height, 75" height overall	T0 = 23"h x 15"d	Tackboard included, fabric orientation applied railroaded.
L Finish type, laminate	T1 = 23"h x 20"d	Wire manager included and mounts adjacent to tackboard. Specify color.
BF Cord escape, back feed	3. <i>Finish type</i>	Include grommet (black only) in back panel for tasklight cord. If used in open plan areas, specify "no grommet"
118 Finish, Bright White	L = laminate	
() Fabric selection	1 = V1	
	2 = V2	
	3 = V3	
	4. <i>Pull option</i> (Optional hinged door configurations only)	
	D = metal D-pull (finish optional)	
	J = routed J-pull (finish matches case)	
	C = nickel finish C-pull (nickel finish only)	
	S = S-pull (stainless steel finish only)	
	5. <i>Lock option</i> (Optional hinged door configurations only)	
	L = drilled to accept lock	
	N = no drilling	

dimensions noted nominal

Products on this page are engineered to align with 75"h cabinets. Be sure storage dimension options and drilling options correspond accordingly. For storage options below the worksurface, specify 28³/₈"h products; **do not mix products from 26¹/₂"h (standard height) planning model with 28³/₈"h (desk height) planning model in any one configuration.**

Overdesk unit will achieve 75" nominal height - actual height 75.125", when used with correct thickness of top.

Clearance below overhead storage to top of worksurface is approximately 22⁵/₈"h.

Applicable finishes are listed on page 102 and 103.

Odd numbered hinged door is always on left side, left hinged.

Reff Overhead storage
overdesk units, desk height planning model
use with 1³/₄" worksurfaces and 28³/₈"h support

description	d	w	h	doors	pattern no.	L	V1	V2	V3
For 1 ³ / ₄ " worksurfaces	20"	30"	45"	1	QROBF30S1DH () () () ()	\$1,711.	\$2,328.	\$2,677.	\$3,614.
Flip doors, 20" deep	20"	36"	45"	1	QROBF36S1DH () () () ()	1,962.	2,670.	3,070.	4,145.
	20"	42"	45"	1	QROBF42S1DH () () () ()	2,214.	3,012.	3,464.	4,676.
	20"	48"	45"	1	QROBF48S1DH () () () ()	2,466.	3,354.	3,857.	5,207.
	20"	54"	45"	2	QROBF54S1DH () () () ()	2,718.	3,696.	4,250.	5,738.
	20"	66"	45"	2	QROBF66S1DH () () () ()	3,219.	4,676.	5,377.	7,259.
	20"	78"	45"	2	QROBF78S1DH () () () ()	4,177.	5,343.	6,144.	8,295.
	20"	90"	45"	2	QROBF90S1DH () () () ()	4,283.	5,492.	6,316.	8,526.

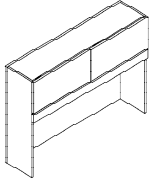

Order Code	Specification Information	Application Notes
Example: QROBO30T0DHLBF118 ()	<i>To order please specify pattern number including:</i>	
QR Reff Standard Special	1. <i>Configuration option (embedded in pattern number)</i>	6. <i>Tasklight cord escape</i> BF = back feed FF = front feed
O Overhead	O = Open	7. <i>Finish</i>
B For mounting on 1 ³ / ₄ " thick top	H = Hinged doors	8. <i>Optional pull finish, where applicable</i>
O Open	F = Flip doors	9. <i>Fabric for tackboard</i>
30 30" wide	2. <i>Storage option (embedded in pattern number)</i>	Overdesk units do not come with lock included. Keying instructions must accompany all orders, refer to page 199. Random locks are factory installed. Key-alike are field installed using the KnollKey order form.
T 23"h storage	S0 = 19"h x 15"d	Products on this page shipped knocked-down.
0 15"d storage	S1 = 19"h x 20"d	Tasklights not included.
DH desk height, 75" height overall	T0 = 23"h x 15"d	Tackboard included, fabric orientation applied railroaded.
L Finish type, laminate	T1 = 23"h x 20"d	Wire manager included and mounts adjacent to tackboard. Specify color.
BF Cord escape, back feed	3. <i>Finish type</i>	Include grommet (black only) in back panel for tasklight cord. If used in open plan areas, specify "no grommet"
118 Finish, Bright White	L = laminate	
() Fabric selection	1 = V1	
	2 = V2	
	3 = V3	
	4. <i>Pull option</i> (Optional hinged door configurations only)	
	D = metal D-pull (finish optional)	
	J = routed J-pull (finish matches case)	
	C = nickel finish C-pull (nickel finish only)	
	S = S-pull (stainless steel finish only)	
	5. <i>Lock option</i> (Optional hinged door configurations only)	
	L = drilled to accept lock	
	N = no drilling	

dimensions noted nominal

Products on this page are engineered to align with 75"h cabinets. Be sure storage dimension options and drilling options correspond accordingly. For storage options below the worksurface, specify 28³/₈"h products; **do not mix products from 26¹/₂"h (standard height) planning model with 28³/₈"h (desk height) planning model in any one configuration.**

Overdesk unit will achieve 75" nominal height - actual height 75.125", when used with correct thickness of top.

Clearance below overhead storage to top of worksurface is approximately 22⁵/₈"h.

Applicable finishes are listed on page 102 and 103.

Odd numbered hinged door is always on left side, left hinged.

Reff Overhead storage panel hung and wall hung cabinets

Standard Specials Systems

description	h	w	d	locks req'd	doors	pattern no.	L	V1	V2	V3
Panel hung overhead cabinet (hinged door, no back)	19"	24"	14"	1	2	QROPH24S0 () () () ()	\$1,560.	\$1,610.	\$1,851.	\$2,500.
		42"	14"	2	3	QROPH42S0 () () () ()	2,052.	2,117.	2,435.	3,287.
		48"	14"	2	3	QROPH48S0 () () () ()	2,185.	2,255.	2,593.	3,501.
		54"	14"	2	3	QROPH54S0 () () () ()	2,224.	2,299.	2,644.	3,569.
		84"	14"	3	5	QROPH84S0 () () () ()	3,001.	3,100.	3,565.	4,813.

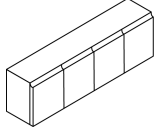

description	h	w	d	locks req'd	doors	pattern no.	L	V1	V2	V3
Wall hung overhead cabinet (hinged door, with back)	19"	24"	15"	1	2	QROMH24S0 () () () ()	2,850.	2,944.	3,386.	4,571.
		42"	15"	2	3	QROMH42S0 () () () ()	3,279.	3,383.	3,890.	5,252.
		48"	15"	2	3	QROMH48S0 () () () ()	3,390.	3,499.	4,024.	5,432.
		54"	15"	2	3	QROMH54S0 () () () ()	3,407.	3,520.	4,048.	5,465.
		66"	15"	2	4	QROMH66S0 () () () ()	3,605.	3,725.	4,284.	5,783.
		78"	15"	2	4	QROMH78S0 () () () ()	4,171.	4,308.	4,954.	6,688.
		84"	15"	3	6	QROMH84S0 () () () ()	4,643.	4,797.	5,517.	7,447.
		90"	15"	3	6	QROMH90S0 () () () ()	4,879.	5,041.	5,797.	7,826.
		96"	15"	3	6	QROMH96S0 () () () ()	5,115.	5,285.	6,078.	8,205.

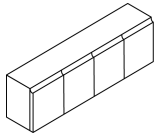

Order Code

Example:	QROPH24S0DLL
QR	Reff Standard Special
O	Overhead
P	Panel hung
H	Hinge door
24	24" wide
S	Standard height, 19"h
0	15" deep
D	D-pull
L	Lock hole drilled
L	Laminate finish

Specification Information

- To order please specify pattern number including:
- Configuration option (*embedded in pattern no.*)
H = Hinged door
O = Open
F = Flip door
 - Storage option (*embedded in pattern no.*)
S0 = 19"h x 14"d open/15"d hinged door
T0 = 23"h x 14"d open/15"d hinged door
 - Finish type
 - Pull option *applicable hinged doors only*
 - Lock option
 - Finish, case
 - Finish, pull when applicable
 - Keying instructions

***After specifying product code, provide keying instructions.**

Dimensions are nominal.

Product not available where prices do not appear.

3. *Finish type options:*

- L = Laminate
- 1 = V1 techwood
- 2 = V2 conventional veneer
- 3 = V3 exotic veneer

4. *Pull Options:*

D = Metal D-pull for hinged door only

J = Routed pull

C = Nickel finish C-pull for hinged door only (nickel finish only)

S = Stainless steel finish S-pull for hinged door only (stainless steel finish only)

5. *Lock options:*

L = Lock hole drilled

N = No lockdrilling

8. Refer to page 199 for keying instructions.

Product on this page excluding J-pull option will accept woodgrain laminate where laminate is currently an option.

List price for woodgrain laminate options will be current published laminate list price plus 10%.

Applicable finishes are listed on page 102 and 103.

Sliding rails order separately on page from Reff price list.

Application Notes

Panel-hung cabinets are shipped knocked-down. Wall-hung overhead cabinets are shipped assembled.

Open cabinets require no locks.

Tasklights are not included.

D-Pulls are not available for flip door units.

Hardware included for overhead cabinets.

The manufacturer does not take responsibility for the installation or the security of cabinets to the wall.

***Keying instructions must accompany all cabinet orders.**

Panel-hung overheads come with no backs.

Random keys are factory installed.

Order overheads with a KnollKey order form.

Reff Overhead storage

Standard Specials Systems

open hutch wood interior

description	h	w	d	pattern no.	L	V1	V2	V3
Hutch for 1 1/4" top, 26 1/2" h component	44 1/4"	30"	14"	QROAO30BW () ()	\$1,831.	\$2,400.	\$2,760.	\$3,726.
	44 1/4"	36"	14"	QROAO36BW () ()	2,015.	2,643.	3,039.	4,103.

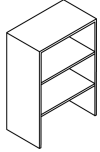

No baseboard
No bottom shelf
2 adjustable shelves

Hutch for 1 1/4" top, 28 3/8" h component	45 1/2"	30"	14"	QROAO30DHBW () ()	1,923.	2,520.	2,898.	3,912.
	45 1/2"	36"	14"	QROAO36DHBW () ()	2,116.	2,775.	3,191.	4,308.

No baseboard
No bottom shelf
2 adjustable shelves

Hutch for 1 3/4" top, 26 1/2" h component	43 3/4"	30"	14"	QROBO30BW () ()	1,831.	2,400.	2,760.	3,726.
	43 3/4"	36"	14"	QROBO36BW () ()	2,015.	2,643.	3,039.	4,103.

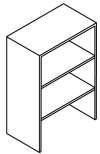

No baseboard
No bottom shelf
2 adjustable shelves

Hutch for 1 3/4" top, 28 3/8" h component	45"	30"	14"	QROBO30DHBW () ()	1,923.	2,520.	2,898.	3,912.
	45"	36"	14"	QROBO36DHBW () ()	2,116.	2,775.	3,191.	4,308.

No baseboard
No bottom shelf
2 adjustable shelves

Order Code	Specification Information	Application Notes
Example: QROAO30BW(2)(V316)	<i>To order please specify pattern number including:</i>	Product on this page will accept woodgrain laminate where laminate is currently an option.
QR Reff Standard Special		List price for woodgrain laminate options will be current published laminate list price plus 10%.
O Overhead storage	1. <i>Interior Option</i>	14" deep gable aligns with the gable depth of standard 15" deep overdesk.
A for 1 1/4" top	W = wood (shelves match case finish or wood drawer interiors)	
O Open hutch	2. <i>Finish type</i>	Shelf adjustability is 2.5" up or down per shelf from equal drilled spacing.
30 30" w (nominal)	L = laminate	
B Bookcase	1 = V1	
W Interior option, wood	2 = V2	
2 Finish type, V2	3 = V3	
V316 Finish, light maple	3. <i>Cabinet finish</i>	

*open hutch
metal interior*

description	h	w	d	pattern no.	L	V1	V2	V3
Hutch for 1 1/4" top, 26 1/2" h component	44 1/4"	30"	14"	QROAO30BM () ()	\$1,676.	\$2,194.	\$2,523.	\$3,406.
	44 1/4"	36"	14"	QROAO36BM () ()	1,854.	2,434.	2,799.	3,779.

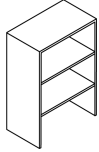

No baseboard
No bottom shelf
2 adjustable shelves

Hutch for 1 1/4" top, 28 3/8" h component	45 1/2"	30"	14"	QROAO30DHBM () ()	1,759.	2,303.	2,648.	3,575.
	45 1/2"	36"	14"	QROAO36DHBM () ()	1,947.	2,556.	2,939.	3,968.

No baseboard
No bottom shelf
2 adjustable shelves

Hutch for 1 3/4" top, 26 1/2" h component	43 3/4"	30"	14"	QROBO30BM () ()	1,676.	2,194.	2,523.	3,406.
	43 3/4"	36"	14"	QROBO36BM () ()	1,854.	2,434.	2,799.	3,779.

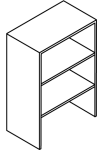

No baseboard
No bottom shelf
2 adjustable shelves

Hutch for 1 3/4" top, 28 3/8" h component	45"	30"	14"	QROBO30DHBM () ()	1,759.	2,303.	2,648.	3,575.
	45"	36"	14"	QROBO36DHBM () ()	1,947.	2,556.	2,939.	3,968.

No baseboard
No bottom shelf
2 adjustable shelves

Order Code	Specification Information	Application Notes
Example: QROAO30BM(2)(V316)	<i>To order please specify pattern number including:</i>	Product on this page will accept woodgrain laminate where laminate is currently an option.
QR Reff Standard Special	1. <i>Interior Option</i>	List price for woodgrain laminate options will be current published laminate list price plus 10%.
O Overhead storage	M = metal shelves	14" deep gable aligns with the gable depth of standard 15" deep overdesk.
A for 1 1/4" top	*If laminate case, finish of metal shelves to match; if case V1 or V2 finish, shelves are black)	Shelf adjustability is 2.5" up or down per shelf from equal drilled spacing.
O Open hutch	2. <i>Finish type</i>	
30 30" w (nominal)	L = laminate	
B Bookcase	1 = V1	
M Interior option, metal	2 = V2	
2 Finish type, V2	3 = V3	
V316 Finish, light maple	3. <i>Cabinet finish</i>	

Reff Overhead storage

T5 Task Light for Reff

Daisy Chain

description	type	w	d	h	pattern no.	Standard	Advanced
Task Light, starter 9 ft. cord, fused male plug 1 ft. cord, female plug	Use with 24" and wider overhead	19"	4"	1 1/2"	RTL5E19()DCS()Q	\$389.	n/a
	Use with 30" and wider overhead	25"	4"	1 1/2"	RTL5E25()DCS()Q	395.	507.
	Use with 42" and wider overhead	37"	4"	1 1/2"	RTL5E37()DCS()Q	400.	527.
	Use with 60" and wider overhead	49"	4"	1 1/2"	RTL5E49()DCS()Q	405.	542.
	Use with 72" and wider overhead	61"	4"	1 1/2"	RTL5E61()DCS()Q	420.	558.
	Use with 84" and wider overhead	73"	4"	1 1/2"	RTL5E73()DCS()Q	445.	573.
	Use with 96" and wider overhead	85"	4"	1 1/2"	RTL5E85()DCS()Q	522.	589.

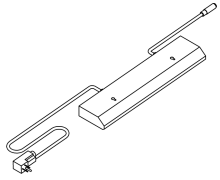

left hand shown

Task Light, adder 2 ft. cord, male plug 1 ft. cord, female plug	Use with 24" and wider overhead	19"	4"	1 1/2"	RTL5E19()DCA()Q	421.	n/a
	Use with 30" and wider overhead	25"	4"	1 1/2"	RTL5E25()DCA()Q	427.	539.
	Use with 42" and wider overhead	37"	4"	1 1/2"	RTL5E37()DCA()Q	432.	559.
	Use with 60" and wider overhead	49"	4"	1 1/2"	RTL5E49()DCA()Q	437.	574.
	Use with 72" and wider overhead	61"	4"	1 1/2"	RTL5E61()DCA()Q	452.	590.
	Use with 84" and wider overhead	73"	4"	1 1/2"	RTL5E73()DCA()Q	477.	605.
	Use with 96" and wider overhead	85"	4"	1 1/2"	RTL5E85()DCA()Q	554.	621.

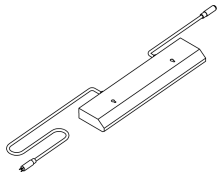

left hand shown

Task Light, ender 2 ft. cord, male plug	Use with 24" and wider overhead	19"	4"	1 1/2"	RTL5E19()DCE()Q	308.	n/a
	Use with 30" and wider overhead	25"	4"	1 1/2"	RTL5E25()DCE()Q	314.	426.
	Use with 42" and wider overhead	37"	4"	1 1/2"	RTL5E37()DCE()Q	319.	446.
	Use with 60" and wider overhead	49"	4"	1 1/2"	RTL5E49()DCE()Q	324.	461.
	Use with 72" and wider overhead	61"	4"	1 1/2"	RTL5E61()DCE()Q	339.	477.
	Use with 84" and wider overhead	73"	4"	1 1/2"	RTL5E73()DCE()Q	364.	492.
	Use with 96" and wider overhead	85"	4"	1 1/2"	RTL5E85()DCE()Q	441.	508.

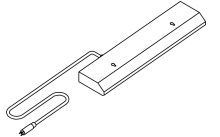

left hand shown

Order Code	Specification Information	Application Notes
Example: RTL5E19SDCSLQ RTL Task Light T5 T5 lamp E Electronic ballast 19 Width S Standard DC Daisy chain S Starter L Left handed Q Special	Specify: Width - Task Lights mount in cabinets and shelves at least 5" wider than light width. 1. Type: (S) Standard (A) Advanced 2. Handedness L= Left handed (male plug on user's left side) R=Right handed (male plug on user's right side) All housings are black.	Task lights mount into the recess in the underside of overhead cabinets and shelves at least 5" wider than task light width. Task lights include T5 cool white (4100K) fluorescent lamp, electronic ballast, prismatic lens, rocker switch, one cord exit management clip and mounting hardware. Cord management clips must be ordered separately. Task lights are TCLP compliant and meet requirements of California Title 24. Advanced task lights are fitted with ballast and lamp compliant with LEED requirements.

description	w	h	pattern no.	list
Panel hung tackboard Note: Fabric railroaded	24"	24"	QRPHTB2424 ()	\$315.
	36"	24"	QRPHTB3624 ()	387.
	48"	24"	QRPHTB4824 ()	472.
	54"	24"	QRPHTB5424 ()	514.
	60"	24"	QRPHTB6024 ()	557.
	72"	24"	QRPHTB7224 ()	642.
available in all standard grades of fabric				
Wall hung tackboard Note: Fabric railroaded Velcro supplied	24"	24"	QRWHTB2424 ()	349.
	54"	24"	QRWHTB5424 ()	505.
	60"	24"	QRWHTB6024 ()	548.
	72"	24"	QRWHTB7224 ()	632.
available in all standard grades of fabric				

Order Code

Specification Information

Application Notes

To order please specify:

1. Pattern number
2. Fabric (Tackboards)

Finishes**L - Laminate**

Matching edge band unless noted otherwise

117	Soft Grey
118	Bright White
114	Folkstone Grey
111	Jet Black
119	Pumice
121	Micro Grey with 114 Folkstone grey edge band
122	Brushed Sand with 119 Pumice edge band
123	Brushed Grey with 128 Fog edge band
128	Fog
129	Micro Sand with 119 Pumice edge band
124	Medium Cherry
125	Natural Maple
126	Natural Cherry
127	Walnut

V1 - Techwood Closed Pore

Y316	Maple
Y319	Cherry
Y323	Medium Walnut
Y326	Dark Mahogany
Y327	Light Oak
Y329	Medium Oak
Y341	Wenge
Y342	Medium Teak
Y343	Dark Grey Oak
Y344	Espresso
Y851	Black Oak
Y811	Natural
Y821	Blond Maple
Y831	Light Cherry

V2 – Natural veneer

V312	Bronze Cherry
V316	Maple
V411	Light Walnut
V415	Peacock Green Walnut
V417	Old English Walnut
V418	Smoked Walnut
V433	Light Fawn Cherry
V436	Medium Brown Cherry
<i>(all above V2's are flat cut)</i>	
V421	Chalk Oak
V423	Light Oak
V425	Amber Oak
V427	Brown Oak
Y439	Straight Anigre
<i>(all V2 Oaks are rift cut)</i>	

V3 – Exotic veneer

V512	Figured Anigre
V514	Makore
V515	Figured Sycamore
V513	Graphite Oak (rift cut)
V517	Natural Sapele
<i>(all V3s are quarter cut)</i>	

Paint

P1	
111	Jet Black
112	Brown
113	Dark Grey
114	Folkstone Grey
115	Medium Grey
116	Sandstone
117	Soft Grey
P2	
611	Beige Mist Metallic
612	Medium Metallic Grey
P3	
118	Bright White
613	Silver

Anodized

AA	Anodized Aluminum
----	-------------------

Plated

PT	Brushed Pewter
----	----------------

Glass G1

TEMP	Clear Tempered
------	----------------

Architectural Glass G2

GL6	Block Matrix
GL13	Powder

Mixed Finishes: (where applicable for work surfaces only)

To order mixed finishes, enter four digit finish code as follows:

Use 2 digit prefix to indicate surface finish (laminate)

11	Jet Black
14	Folkstone Grey
17	Soft Grey
18	Bright White
19	Pumice
21	Micro Grey
22	Brushed Sand
23	Brushed Grey
28	Fog
29	Micro Sand

Use 2 digit suffix to indicate edge finish (wood)

12	for V312
16	for V316, Y316
Y9	for Y319
Y3	for Y323
26	for Y326
27	for Y327
29	for Y329
43	for V433
45	for V415
46	for V436
47	for V417
48	for V418
52	for V512
53	for V513
54	for V514
55	for V515
57	for V517
61	for V411
71	for V421
73	for V423
75	for V425
77	for V427

Example:

For a Micro Grey laminate surface with Bronzed Cherry edge, enter finish code 2112

For a Jet Black laminate surface with Light Maple edge, enter finish code 1116

Conference room top

1 1/4" Thick - No grommet, no drilling

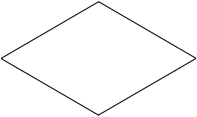
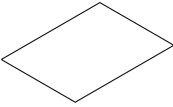
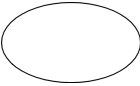
description	w	d	dia.	pattern no.	L	M	V1	V2	V3
Square top - tapered 4 sides 	30"	30"		QAW1T43030 () ()	\$752.	\$1,030.	\$1,030.	\$1,185.	\$1,599.
	36"	36"		QAW1T43636 () ()	827.	1,133.	1,133.	1,303.	1,759.
	42"	42"		QAW1T44242 () ()	952.	1,304.	1,304.	1,500.	2,025.
	48"	48"		QAW1T44848 () ()	1,096.	1,502.	1,502.	1,727.	2,331.
Rectangular top - tapered 4 sides 	48"	30"		QAW1T44830 () ()	988.	1,354.	1,354.	1,557.	2,101.
	60"	30"		QAW1T46030 () ()	1,084.	1,485.	1,485.	1,708.	2,306.
	72"	30"		QAW1T47230 () ()	1,179.	1,615.	1,615.	1,858.	2,508.
	72"	36"		QAW1T47236 () ()	1,225.	1,678.	1,678.	1,930.	2,605.
Round top - tapered edge 			24"	QAW1TR24 () ()	955.	1,308.	1,308.	1,505.	2,031.
			30"	QAW1TR30 () ()	986.	1,351.	1,351.	1,553.	2,097.
			36"	QAW1TR36 () ()	1,017.	1,393.	1,393.	1,602.	2,163.
			42"	QAW1TR42 () ()	1,102.	1,510.	1,510.	1,736.	2,344.
			48"	QAW1TR48 () ()	1,256.	1,721.	1,721.	1,979.	2,671.

Order Code

Example:	QAW1T43030-V-V316
QA	AutoStrada
W	Worksurface
1	Generation 1
T4	Tapered edge 4 sides
30	30" wide
30	30" deep
V	Surface type, veneer
V316	Maple

Specification Information

To order please specify pattern number including:

1. Width
2. Depth
3. Surface type
L = Laminat
M = Mixed, Laminat surface/V1, V2 or V3 edge
V = V1, V2 or V3
4. Finish, Surface
 Laminat, Mixed, V1, V2 or V3 finish

Application Notes

5. Finish, Edge
Must be same as surface finish unless M surface type specified, then must be V1, V2 or V3 finish

Product on this page will accept wood grain laminate where laminate is currently an option.
 List price for wood grain laminate options will be current published laminate list price plus 10%.

Grommets are not optional for tables.

Stiffener included with rectangular tables 60"w and over.

Note: Metal inserts are required in order to create freestanding tables. Table legs must be positioned in accordance with BIFMA guidelines.

AutoStrada Cabinets

Freestanding cabinets for private office

Standard Specials Systems

description	h	w	d	pattern no.	L	V1	V2	V3
File drawers (2) with hinged doors and wood shelves above	70"	30"	24"	QACG722WE () ()	\$3,928.	\$5,093.	\$6,036.	\$8,148.
	70"	36"	24"	QACG723WE () ()	4,038.	5,236.	6,204.	8,376.
	84"	30"	24"	QACG822WE () ()	4,615.	5,980.	7,086.	9,566.
	84"	36"	24"	QACG823WE () ()	4,744.	6,147.	7,284.	9,834.

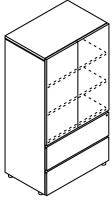

description	h	w	d	pattern no.	L	V1	V2	V3
Wardrobe, with hinged door	70"	16"	24"	QACDL720 () ()	2,811.	3,514.	4,164.	5,622.
	70"	16"	24"	QACDR720 () ()	2,811.	3,514.	4,164.	5,622.
	70"	19"	24"	QACDL721 () ()	2,811.	3,514.	4,164.	5,622.
	70"	19"	24"	QACDR721 () ()	2,811.	3,514.	4,164.	5,622.
	84"	16"	24"	QACDL820 () ()	3,356.	4,225.	5,007.	6,759.
	84"	16"	24"	QACDR820 () ()	3,356.	4,225.	5,007.	6,759.
	84"	19"	24"	QACDL821 () ()	3,356.	4,225.	5,007.	6,759.
	84"	19"	24"	QACDR821 () ()	3,356.	4,225.	5,007.	6,759.



Order Code	Specification Information	Application Notes
Example: QACG722WE316AAAA	<i>To order please specify pattern number including:</i>	
QA AutoStrada		
C Cabinet		
G 2 file drawers below, hinged doors above	1. Height 7 = 70" h 8 = 84" h	Cabinets on this page are styled for the private office and include aluminum feet detail which is optional addition to lower storage beginning on page 0. Specify 70" h cabinets for use with single high overhead storage and 84" h cabinets for use with double high overhead storage.
7 70" high	2. Width 2 = 30" wide 3 = 36" wide	
2 24" deep	3. Interior & shelf W = wood drawer interior and wood shelves	No pull in hinged doors.
2 30" wide	4. Extruded aluminum pull E = extruded aluminum pull (default)	84" high cabinets include wall cleat for stability.
W Wood interior only		Hinged doors feature touch latches and do not lock. Sliding doors do not lock. File drawers dilled for locks, keying instructions must accompany order.
E Extruded Aluminum Pull		Coat rod included in wardrobes.
V316 Finish, Maple	5. Finish <i>Laminate, V1, V2 or V3 finish</i>	
AA Finish, trim & pull, anodized aluminum	6. Finish, Aluminum trim (trim & if pull) AA - Anodized aluminum or painted finish option from page 0 excluding silver	
AA Finish, cabinet feet, anodized alum	7. Finish, cabinet feet AA - Anodized aluminum or painted finish option from page 0 excluding silver	
	See page 0 for finish options applicable.	
	Product on this page will accept wood grain laminate where laminate is currently an option. List price for wood grain laminate options will be current published laminate list price plus 10%.	

AutoStrada Lower Storage

Wood or laminate case

Standard Specials Systems

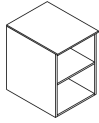
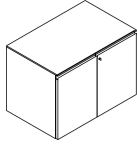
description	type	h	w	d	pattern no.	L	V1	V2	V3
Lower storage, open with an adj. shelf 	19" deep	26"	16"	19"	QAFPO10W ()	\$885.	\$947.	\$1,089.	\$1,470.
	19" deep	26"	19"	19"	QAFPO11W ()	885.	947.	1,089.	1,470.
	19" deep	26"	30"	19"	QAFPO12W ()	1,068.	1,142.	1,314.	1,774.
	19" deep	26"	36"	19"	QAFPO13W ()	1,358.	1,454.	1,672.	2,257.
	23" deep	26"	16"	23"	QAFPO20W ()	1,031.	1,103.	1,269.	1,712.
	23" deep	26"	19"	23"	QAFPO21W ()	1,031.	1,103.	1,269.	1,712.
	23" deep	26"	30"	23"	QAFPO22W ()	1,240.	1,327.	1,526.	2,060.
	23" deep	26"	36"	23"	QAFPO23W ()	1,576.	1,686.	1,939.	2,617.
Lower storage, full height hinged doors 	19" deep	26"	16"	19"	QAFDDL10 () ()W ()	1,044.	1,117.	1,284.	1,734.
	19" deep	26"	16"	19"	QAFDDR10 () ()W ()	1,044.	1,117.	1,284.	1,734.
	19" deep	26"	19"	19"	QAFDDL11 () ()W ()	1,044.	1,117.	1,284.	1,734.
	19" deep	26"	19"	19"	QAFDDR11 () ()W ()	1,044.	1,117.	1,284.	1,734.
	19" deep	26"	30"	19"	QAFDDL12 () ()W ()	1,226.	1,312.	1,509.	2,037.
	19" deep	26"	36"	19"	QAFDDL13 () ()W ()	1,517.	1,623.	1,867.	2,520.
	23" deep	26"	16"	23"	QAFDDL20 () ()W ()	1,190.	1,273.	1,464.	1,976.
	23" deep	26"	16"	23"	QAFDDR20 () ()W ()	1,190.	1,273.	1,464.	1,976.
	23" deep	26"	19"	23"	QAFDDL21 () ()W ()	1,190.	1,273.	1,464.	1,976.
	23" deep	26"	19"	23"	QAFDDR21 () ()W ()	1,190.	1,273.	1,464.	1,976.
	23" deep	26"	30"	23"	QAFDDL22 () ()W ()	1,399.	1,497.	1,722.	2,324.
	23" deep	26"	36"	23"	QAFDDL23 () ()W ()	1,734.	1,856.	2,134.	2,881.

Example: **QAFPO10W-114**

QA	AutoStrada
F	Floor standing
P	Pedestal
O	Open with an adj. shelf
W	Wood interior only
1	20" deep nominal
0	16" wide
114	Finish, Folkstone grey

To order please specify pattern number including:

- Hand (applicable 16" and 19" wide units)
L = hinges on left
R = hinges on right
- Depth
1 = 20" deep
2 = 24" deep
- Width
0 = 16" wide
1 = 19" wide
2 = 30" wide
3 = 36" wide
4 = 42" wide
- Pull
E = Extruded aluminum pull
P = Extruded aluminum protruding pull

- Lock option
L = drilled for locks
N = not drilled for locks
- Interior
W = wood interior (only)
- Finish
Laminate, V1, V2 or V3 finish
- Finish, pull
Anodized aluminum or painted finish options listed on page 0 excluding silver.

Optional lock drilled to be specified. If drilled for locks selected, keying instructions must accompany order.

See page 0 for finish options applicable.

Product on this page will accept wood grain laminate where laminate is currently an option. List price for wood grain laminate options will be current published laminate list price plus 10%.

Units on this page include a finished sub-top and anti-tip spacer. Height to underside of worksurface including anti-tip spacer is 27" h. Optional work surface stand-offs (to use in place of anti-tip spacer) are specified separately from page 0.

Primary finished top required in freestanding applications, ordered separately when item stands alone.

Note: Optional cabinet feet are recommended when units used in free-standing applications to achieve overall desk height of 29⁵/₈" (see page 0).

Note: Above pedestals do not allow for 2 rows of binder storage.

AutoStrada T5 Task Light Daisy Chain

Standard Specials Systems

description	type	w	d	h	pattern no.	Standard	Advanced
Task Light, starter 9 ft. cord, fused male plug 1 ft. cord, female plug	Use with 24" and wider overhead	19"	4"	1 1/2"	AL1T5E19()DCS()Q	\$397.	n/a
	Use with 30" and wider overhead	25"	4"	1 1/2"	AL1T5E25()DCS()Q	402.	518.
	Use with 42" and wider overhead	37"	4"	1 1/2"	AL1T5E37()DCS()Q	407.	538.
	Use with 60" and wider overhead	49"	4"	1 1/2"	AL1T5E49()DCS()Q	412.	554.
	Use with 72" and wider overhead	61"	4"	1 1/2"	AL1T5E61()DCS()Q	428.	570.
	Use with 84" and wider overhead	73"	4"	1 1/2"	AL1T5E73()DCS()Q	454.	587.
	Use with 96" and wider overhead	85"	4"	1 1/2"	AL1T5E85()DCS()Q	533.	603.

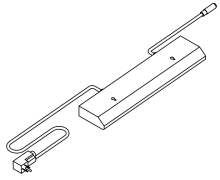

left hand shown

Task Light, adder 2 ft. cord, male plug 1 ft. cord, female plug	Use with 24" and wider overhead	19"	4"	1 1/2"	AL1T5E19()DCA()Q	429.	n/a
	Use with 30" and wider overhead	25"	4"	1 1/2"	AL1T5E25()DCA()Q	434.	550.
	Use with 42" and wider overhead	37"	4"	1 1/2"	AL1T5E37()DCA()Q	439.	570.
	Use with 60" and wider overhead	49"	4"	1 1/2"	AL1T5E49()DCA()Q	444.	586.
	Use with 72" and wider overhead	61"	4"	1 1/2"	AL1T5E61()DCA()Q	460.	602.
	Use with 84" and wider overhead	73"	4"	1 1/2"	AL1T5E73()DCA()Q	486.	619.
	Use with 96" and wider overhead	85"	4"	1 1/2"	AL1T5E85()DCA()Q	565.	635.

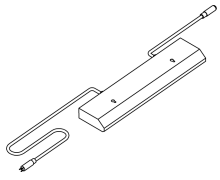

left hand shown

Task Light, ender 2 ft. cord, male plug	Use with 24" and wider overhead	19"	4"	1 1/2"	AL1T5E19()DCE()Q	316.	n/a
	Use with 30" and wider overhead	25"	4"	1 1/2"	AL1T5E25()DCE()Q	321.	437.
	Use with 42" and wider overhead	37"	4"	1 1/2"	AL1T5E37()DCE()Q	326.	457.
	Use with 60" and wider overhead	49"	4"	1 1/2"	AL1T5E49()DCE()Q	331.	473.
	Use with 72" and wider overhead	61"	4"	1 1/2"	AL1T5E61()DCE()Q	347.	489.
	Use with 84" and wider overhead	73"	4"	1 1/2"	AL1T5E73()DCE()Q	373.	506.
	Use with 84" and wider overhead	85"	4"	1 1/2"	AL1T5E85()DCE()Q	452.	522.

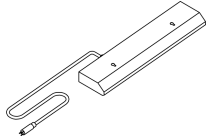

left hand shown

Order Code	Specification Information	Application Notes
Example: AL1T5E19SDCSLQ	<i>Specify:</i>	Task lights mount into the recess in the underside of overhead cabinets and shelves at least 5" wider than task light width.
AL1 AutoStrada Task Light	Width - Task Lights mount in cabinets and shelves at least 5" wider than light width.	Task Light fit to overhead cabinets without the use of filler panels.
T5 T5 lamp	1. Type: (S) Standard (A) Advanced	All lights feature two screw-mounting keyholes.
E Electronic ballast	2. Handedness L= Left handed (male plug on user's left side) R=Right handed (male plug on user's right side)	Task lights include T5 cool white (4100K) fluorescent lamp, electronic ballast, prismatic lens, rocker switch, one cord exit management clip and mounting hardware.
19 Width	All housings are black.	Task lights are TCLP compliant and meet requirements of California Title 24.
S Standard		Advanced task lights are fitted with ballast and lamp compliant with LEED requirements.
DC Daisy chain		
S Starter		
L Left handed		
Q Special		

T5 Task Light for Reuter Overhead Storage Daisy Chain

description	type	w	d	h	pattern no.	Standard	Advanced
Task Light, starter 9 ft. cord, fused male plug 1 ft. cord, female plug	Use with 24" and wider overhead	19"	4"	1 1/2"	RTAT5E19()DCS()Q	\$351.	n/a
	Use with 30" and wider overhead	25"	4"	1 1/2"	RTAT5E25()DCS()Q	367.	533.
	Use with 42" and wider overhead	37"	4"	1 1/2"	RTAT5E37()DCS()Q	385.	554.
	Use with 60" and wider overhead	49"	4"	1 1/2"	RTAT5E49()DCS()Q	406.	570.
	Use with 66" and wider overhead	61"	4"	1 1/2"	RTAT5E61()DCS()Q	423.	588.

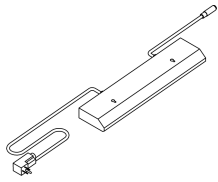

left hand shown

Task Light, adder 2 ft. cord, male plug 1 ft. cord, female plug	Use with 24" and wider overhead	19"	4"	1 1/2"	RTAT5E19()DCA()Q	383.	n/a
	Use with 30" and wider overhead	25"	4"	1 1/2"	RTAT5E25()DCA()Q	399.	565.
	Use with 42" and wider overhead	37"	4"	1 1/2"	RTAT5E37()DCA()Q	417.	586.
	Use with 60" and wider overhead	49"	4"	1 1/2"	RTAT5E49()DCA()Q	438.	602.
	Use with 66" and wider overhead	61"	4"	1 1/2"	RTAT5E61()DCA()Q	455.	620.

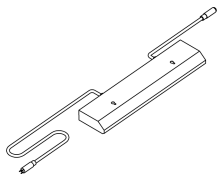

left hand shown

Task Light, ender 2 ft. cord, male plug	Use with 24" and wider overhead	19"	4"	1 1/2"	RTAT5E19()DCE()Q	270.	n/a
	Use with 30" and wider overhead	25"	4"	1 1/2"	RTAT5E25()DCE()Q	286.	452.
	Use with 42" and wider overhead	37"	4"	1 1/2"	RTAT5E37()DCE()Q	304.	473.
	Use with 60" and wider overhead	49"	4"	1 1/2"	RTAT5E49()DCE()Q	325.	489.
	Use with 66" and wider overhead	61"	4"	1 1/2"	RTAT5E61()DCE()Q	342.	507.

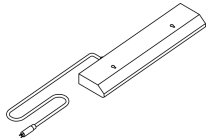

left hand shown

Order Code	Specification Information	Application Notes
Example: RTAT5E19SDCSLQ	<i>Specify:</i>	Task lights mount into the recess in the underside of overhead cabinets and shelves at least 5" wider than task light width.
RTA Task Light	Width - Task Lights mount in cabinets and shelves at least 5" wider than light width.	Task lights include T5 cool white (4100K) fluorescent lamp, electronic ballast, prismatic lens, rocker switch, one cord exit management clip and mounting hardware.
T5 T5 lamp	1. Type: (S) Standard (A) Advanced	Task lights are TCLP compliant and meet requirements of California Title 24.
E Electronic ballast	2. Handedness L= Left handed (male plug on user's left side) R=Right handed (male plug on user's right side)	Advanced task lights are fitted with ballast and lamp compliant with LEED requirements.
19 Width	All housings are black.	
S Standard		
DC Daisy chain		
S Starter		
L Left handed		
Q Special		

The Graham Collection T5 Task Light

Daisy Chain

Standard Specials Systems

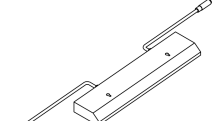
description	type	w	d	h	pattern no.	Standard	Advanced
Task Light, starter 9 ft. cord, fused male plug 1 ft. cord, female plug 	Use with 24" and wider overhead	19"	4"	1 1/2"	GTLT5E19()DCS()Q	\$400.	n/a
	Use with 30" and wider overhead	25"	4"	1 1/2"	GTLT5E25()DCS()Q	406.	524.
	Use with 42" and wider overhead	37"	4"	1 1/2"	GTLT5E37()DCS()Q	412.	544.
	Use with 60" and wider overhead	49"	4"	1 1/2"	GTLT5E49()DCS()Q	417.	560.
	Use with 72" and wider overhead	61"	4"	1 1/2"	GTLT5E61()DCS()Q	432.	577.
	Use with 84" and wider overhead	73"	4"	1 1/2"	GTLT5E73()DCS()Q	458.	594.
	Use with 96" and wider overhead	85"	4"	1 1/2"	GTLT5E85()DCS()Q	538.	609.

left hand shown

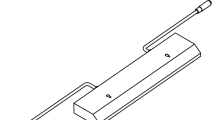
Task Light, adder 2 ft. cord, male plug 1 ft. cord, female plug 	Use with 24" and wider overhead	19"	4"	1 1/2"	GTLT5E19()DCA()Q	432.	n/a
	Use with 30" and wider overhead	25"	4"	1 1/2"	GTLT5E25()DCA()Q	438.	556.
	Use with 42" and wider overhead	37"	4"	1 1/2"	GTLT5E37()DCA()Q	444.	576.
	Use with 60" and wider overhead	49"	4"	1 1/2"	GTLT5E49()DCA()Q	449.	592.
	Use with 72" and wider overhead	61"	4"	1 1/2"	GTLT5E61()DCA()Q	464.	609.
	Use with 84" and wider overhead	73"	4"	1 1/2"	GTLT5E73()DCA()Q	490.	626.
	Use with 96" and wider overhead	85"	4"	1 1/2"	GTLT5E85()DCA()Q	570.	641.

left hand shown

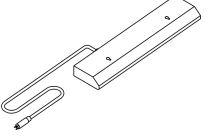
Task Light, ender 2 ft. cord, male plug 	Use with 24" and wider overhead	19"	4"	1 1/2"	GTLT5E19()DCE()Q	319.	n/a
	Use with 30" and wider overhead	25"	4"	1 1/2"	GTLT5E25()DCE()Q	325.	443.
	Use with 42" and wider overhead	37"	4"	1 1/2"	GTLT5E37()DCE()Q	331.	463.
	Use with 60" and wider overhead	49"	4"	1 1/2"	GTLT5E49()DCE()Q	336.	479.
	Use with 72" and wider overhead	61"	4"	1 1/2"	GTLT5E61()DCE()Q	351.	496.
	Use with 84" and wider overhead	73"	4"	1 1/2"	GTLT5E73()DCE()Q	377.	513.
	Use with 96" and wider overhead	85"	4"	1 1/2"	GTLT5E85()DCE()Q	457.	528.

left hand shown

Order Code	Specification Information	Application Notes
Example: GTLT5E19SDCSLQ	<i>Specify:</i>	T5 tasklights are TCLP compliant and meet requirements of California Title 24.
G Graham Collection	Width - Task Lights mount in cabinets and shelves at least 5" wider than light width.	T5 tasklight include T5 cool white (4100K) fluorescent lamp; electronic ballast, prismatic lens, rocker switch, one cord exit management clip and mounting hardware.
TL Task light	1. Type: (S) Standard (A) Advanced	* Advanced tasklights are fitted with ballast and lamp compliant with LEED requirements.
T5 T5 lamp	2. Handedness L= Left handed (male plug on user's left side) R=Right handed (male plug on user's right side)	
E Electronic ballast		
19 Width		
S Standard		
DC Daisy chain		
S Starter		
L Left handed		
Q Special		

All housings are black.

Alpha-Numeric Index

<i>pattern no.</i>	<i>page</i>	<i>pattern no.</i>	<i>page</i>	<i>pattern no.</i>	<i>page</i>	<i>pattern no.</i>	<i>page</i>
AA1EPS80Q	32	D1BD7848SRQ	18	D1L4866DDNQ	15	DIR3918NQ	7
AL1T5E19	184	D1BD8448DLQ	18	D1L4872DDNQ	15	DIR3924NQ	8
AL1T5E25	184	D1BD8448DRQ	18	D1L4878DSNQ	16	DIR3930NQ	9
AL1T5E37	184	D1BD8448SLQ	18	D1L4878SDNQ	16	DIR3936NQ	10
AL1T5E49	184	D1BD8448SRQ	18	D1L4878SSNQ	14	DIR4236NQ	10
AL1T5E61	184	D1C4230GQ	13	D1L4884DDNQ	15	DIR4518NQ	7
AL1T5E73	184	D1C4230NQ	13	D1L4884DSNQ	16	DIR4524NQ	8
AL1T5E85	184	D1C4836GQ	13	D1L4884SDNQ	16	DIR4530NQ	9
AW1-CS2412Q	90	D1C4836NQ	13	D1L4896DDNQ	15	DIR4536NQ	10
AW1-CS3012Q	90	D1CRR30Q	18	D1L4896DSNQ	16	DIR4836NQ	10
AW1-CS4212Q	90	D1CS3624GQ	13	D1L4896SSNQ	14	DIR5118NQ	7
AW1-CS5412Q	90	D1CS3624NQ	13	D1L5436DSNQ	16	DIR5124NQ	8
AW1-CS6612Q	90	D1D3024NQ	17	D1L5436SDNQ	16	DIR5130NQ	9
AW1-F2430Q	90	D1D3030NQ	17	D1L5436SSNQ	14	DIR5136NQ	10
AW1-F3030Q	90	D1D3624NQ	17	D1L5442SSNQ	14	DIR5436NQ	10
AW1-F4230Q	90	D1D3630NQ	17	D1L5448SSNQ	14	DIR5718NQ	7
AW1-F5430Q	90	D1D5424NQ	17	D1L6036SSNQ	14	DIR5724NQ	8
AW1-F6630Q	90	D1D5430NQ	17	D1L6042DDNQ	15	DIR5730NQ	9
AW1-F7830Q	90	D1D5436NQ	17	D1L6048DDNQ	15	DIR5736NQ	10
AW1-S2430Q	90	D1D6024NQ	17	D1L6642DDNQ	15	DIR6318NQ	7
AW1-S3030Q	90	D1D6036NQ	17	D1L6642DSNQ	16	DIR6324NQ	8
AW1-S4230Q	90	D1D6624NQ	17	D1L6642SDNQ	16	DIR6330NQ	9
AW1-S5424Q	90	D1D6636NQ	17	D1L6648DDNQ	15	DIR6336NQ	10
AW1-S5430Q	90	D1D7224NQ	17	D1L7236SSNQ	14	DIR6918NQ	7
AW1-S6630Q	90	D1D7824NQ	17	D1L7242DDNQ	15	DIR6924NQ	8
AW1-S7824Q	90	D1D7830NQ	17	D1L7248DDNQ	15	DIR6930NQ	9
AW1-S7830Q	90	D1D7836NQ	17	D1L7836SSNQ	14	DIR6936NQ	10
AX1E28Q	32	D1D8424NQ	17	D1L8442SSNQ	14	DIR7518NQ	7
AX1E80Q	32	D1D8430NQ	17	D1L8448DDNQ	15	DIR7524NQ	8
CE10236Q	39	D1D8436NQ	17	D1L8448DSNQ	16	DIR7530NQ	9
CE11418Q	39	D1D9624NQ	17	D1L8448SDNQ	16	DIR7536NQ	10
CE11436Q	39	D1D9630NQ	17	D1L9648DDNQ	15	DIR7836NQ	10
CE12036Q	39	D1D9636NQ	17	D1L9648SSNQ	14	DIR8118NQ	7
CE4836Q	39	D1L3648DSNQ	16	D1P5430NQ	18	DIR8124NQ	8
CE5436Q	39	D1L3648SDNQ	16	D1P6030NQ	18	DIR8130NQ	9
CE6618Q	39	D1L3648SSNQ	14	D1P7836NQ	18	DIR8136NQ	10
CE6636Q	39	D1L3654SDNQ	16	D1P8430NQ	18	DIR8436NQ	10
CE7818Q	39	D1L3654SSNQ	14	D1P9030NQ	18	DIR8718NQ	7
CE7836Q	39	D1L3660SSNQ	14	DIR10224NQ	8	DIR8724NQ	8
CE9618Q	39	D1L3672SSNQ	14	DIR10230NQ	9	DIR8730NQ	9
CE9636Q	39	D1L3678SSNQ	14	DIR10236NQ	10	DIR8736NQ	10
D195430NQ	18	D1L4242DDNQ	15	DIR10824NQ	8	DIR9036NQ	10
D196030NQ	18	D1L4242DSNQ	16	DIR10830NQ	9	DIR9318NQ	7
D197836NQ	18	D1L4242SDNQ	16	DIR10836NQ	10	DIR9324NQ	8
D198430NQ	18	D1L4248DSNQ	16	DIR11430NQ	9	DIR9330NQ	9
D199030NQ	18	D1L4248SDNQ	16	DIR11436NQ	10	DIR9336NQ	10
D1BD5448DLQ	17	D1L4248SSNQ	14	DIR12024NQ	8	DIR9636NQ	10
D1BD5448DRQ	17	D1L4254SSNQ	14	DIR12030NQ	9	DIR9918NQ	7
D1BD5448SLQ	17	D1L4260DDNQ	15	DIR12036NQ	10	DIR9924NQ	8
D1BD5448SRQ	17	D1L4266DDNQ	15	DIR1818NQ	7	DIR9930NQ	9
D1BD6048DLQ	17	D1L4266DSNQ	16	DIR2118NQ	7	DIR9936NQ	10
D1BD6048DRQ	17	D1L4266SDNQ	16	DIR2124NQ	8	DIW302430NQ	12
D1BD6048SLQ	18	D1L4272DDNQ	15	DIR2718NQ	7	DIW303024NQ	11
D1BD6048SRQ	18	D1L4272DSNQ	16	DIR2724NQ	8	DIW361824NQ	12
D1BD7242DLQ	18	D1L4272SDNQ	16	DIR2730NQ	9	DIW362418NQ	11
D1BD7242DRQ	18	D1L4284SSNQ	14	DIR3036NQ	10	DIW482436NQ	12
D1BD7242SLQ	18	D1L4836SSNQ	14	DIR3318NQ	7	DIW483624NQ	11
D1BD7242SRQ	18	D1L4842SDNQ	16	DIR3324NQ	8	DIW542430NQ	12
D1BD7848DLQ	18	D1L4842SSNQ	14	DIR3330NQ	9	DIW543024NQ	11
D1BD7848DRQ	18	D1L4854SSNQ	14	DIR3336NQ	10	DIW601830NQ	12
D1BD7848SLQ	18	D1L4860DDNQ	15	DIR3636NQ	10	DIW602430NQ	12

<i>pattern no.</i>	<i>page</i>	<i>pattern no.</i>	<i>page</i>	<i>pattern no.</i>	<i>page</i>	<i>pattern no.</i>	<i>page</i>
D1W602436NQ	12	DE(OE/OT)PM24Q	22	DT1BYD8442Q	19	GTLT5E61	186
D1W603018NQ	11	DE(OE/OT)PM30Q	22	DT1BYD902430Q	19	GTLT5E73	186
D1W603024NQ	11	DE(OE/OT)PM36Q	22	DT1BYD9036Q	19	GTLT5E85	186
D1W603624NQ	11	DE(OE/OT)PM42Q	22	DT1BYD9042Q	19	LL2T5E19	101
D1W662430NQ	12	DE(OE/OT)PM48Q	22	DT1BYD962430Q	19	LL2T5E25	101
D1W662436NQ	12	DE(OE/OT)RBI56Q	25	DT1BYD9636Q	19	LL2T5E37	101
D1W663024NQ	11	DE(OE/OT)VPIJQ	24	DT1BYD9642Q	19	LL2T5E49	101
D1W663624NQ	11	DES(OE/OT)BPCNPQ	23	EL4T5E19	40	LU1-C4242DD-Q	87
D1W723036NQ	12	DES(OE/OT)BPCWPQ	23	EL4T5E25	40	LU1-C4242DS-Q	86
D1W723630NQ	11	DES(OE/OT)BPJ18NPQ	23	EL4T5E37	40	LU1-C4242SD-Q	86
D1W782430NQ	12	DES(OE/OT)BPJ18WPQ	23	EL4T5E49	40	LU1-C4248DD-Q	87
D1W782436NQ	12	DES(OE/OT)BPJ24NPQ	23	EP1DL36LQ	28	LU1-C4248DS-Q	86
D1W783024NQ	11	DES(OE/OT)BPJ24WPQ	23	EP1DL36RQ	28	LU1-C4248SD-Q	86
D1W783624NQ	11	DES(OE/OT)BPJ30NPQ	23	EP1DL42LQ	28	LU1-C4248SS-Q	86
D1W842436NQ	12	DES(OE/OT)BPJ30WPQ	23	EP1DL42RQ	28	LU1-C4260DD-Q	87
D1W843624NQ	11	DES(OE/OT)BPJ36NPQ	23	EP1DL48LQ	29	LU1-C4260DS-Q	86
D1W902430NQ	12	DES(OE/OT)BPJ36WPQ	23	EP1DL48RQ	29	LU1-C4260SD-Q	86
D1W903024NQ	11	DES(OE/OT)BPJ42NPQ	23	EP1SDOLQ	29	LU1-C4260SS-Q	86
D1W962430NQ	12	DES(OE/OT)BPJ42WPQ	23	EP1SDORQ	29	LU1-C4266DD-Q	87
D1W962436NQ	12	DES(OE/OT)BPJ48NPQ	23	EP1SDSLQ	29	LU1-C4266DS-Q	86
D1W963024NQ	11	DES(OE/OT)BPJ48WPQ	23	EP1SDSRQ	29	LU1-C4266SD-Q	86
D1W963036NQ	12	DES(OE/OT)BPJ54WPQ	23	EP3DL36LQ	30	LU1-C4266SS-Q	86
D1W963624NQ	11	DES(OE/OT)BPJ60WPQ	23	EP3DL36RQ	30	LU1-C4272DD-Q	87
D1W963630NQ	11	DES(OE/OT)BPJ66WPQ	23	EP3DL42LQ	30	LU1-C4272DS-Q	86
DB1BD48DLQ	17	DES(OE/OT)BPJ72WPQ	23	EP3DL42RQ	30	LU1-C4272SD-Q	86
DB1BD48DRQ	17	DES(OE/OT)BPJ78WPQ	23	EP3DL48LQ	31	LU1-C4272SS-Q	86
DE0DRAQ	22	DES(OE/OT)BPJ84WPQ	23	EP3DL48RQ	31	LU1-C4842DD-Q	87
DE0DRBQ	22	DES(OE/OT)BPJ96WPQ	23	EP3SDOLQ	31	LU1-C4842DS-Q	86
DE0DRCQ	22	DL3T5E19	26	EP3SDORQ	31	LU1-C4842SD-Q	86
DE0DRXQ	22	DL3T5E25	26	EP3SDSLQ	31	LU1-C4842SS-Q	86
DE(OE/OT)BI56(L/R)Q	25	DL3T5E37	26	EP3SDSRQ	31	LU1-C4860DD-Q	87
DE(OE/OT)BPM301Q	23	DL3T5E49	26	EW12418CQ	33	LU1-C4866DD-Q	87
DE(OE/OT)BPM302Q	23	DP5CHQ	20	EW12418Q	33	LU1-C4866DS-Q	86
DE(OE/OT)BPM361Q	23	DS1AS18Q	20	EW14236CQ	33	LU1-C4866SD-Q	86
DE(OE/OT)BPM362Q	23	DS1AS24Q	20	EW14236Q	33	LU1-C4866SS-Q	86
DE(OE/OT)BPM421Q	23	DS1AS30Q	20	EW16615Q	33	LU1-C4872DD-Q	87
DE(OE/OT)BPM422Q	23	DS1AS36Q	20	EW1(9/P)6030Q	36	LU1-C6042DD-Q	87
DE(OE/OT)BPM481Q	23	DS1AS42Q	20	EW1(9/P)9636Q	36	LU1-C6042DS-Q	86
DE(OE/OT)BPM482Q	23	DS1AS48Q	20	EW1BD3672S	34	LU1-C6042SD-Q	86
DE(OE/OT)CH144Q	25	DS1AS54Q	20	EW1BD4860D	34	LU1-C6042SS-Q	86
DE(OE/OT)PCNPQ	22	DS1AS60Q	20	EW1BD4872D	34	LU1-C6048DD-Q	87
DE(OE/OT)PCWPQ	22	DS1AS66Q	20	EW1BD6036S	34	LU1-C6642DD-Q	87
DE(OE/OT)PJ120WPQ	24	DS1AS72Q	20	EW1BD6048D	34	LU1-C6642DS-Q	86
DE(OE/OT)PJ126WPQ	24	DS3WMC1430Q	20	EW1BS3672D	34	LU1-C6642SD-Q	86
DE(OE/OT)PJ138WPQ	24	DS3WMC1433Q	20	EW1BS3678S	34	LU1-C6642SS-Q	86
DE(OE/OT)PJ144WPQ	24	DS3WMC1436Q	20	EW1BS4272S	34	LU1-C6648DD-Q	87
DE(OE/OT)PJ18NPQ	22	DS3WMC1442Q	20	EW1BS6060S	34	LU1-C6648DS-Q	86
DE(OE/OT)PJ18WPQ	22	DS3WMC1448Q	20	EW1BS7236D	34	LU1-C6648SD-Q	86
DE(OE/OT)PJ24NPQ	22	DS3WMC2130Q	20	EW1BS7242S	34	LU1-C6648SS-Q	86
DE(OE/OT)PJ24WPQ	22	DS3WMC2133Q	20	EW1BS7836S	34	LU1-C7242DD-Q	87
DE(OE/OT)PJ30NPQ	22	DS3WMC2136Q	20	EW1CC4215EEQ	35	LU1-C7242DS-Q	86
DE(OE/OT)PJ30WPQ	22	DS3WMC2142Q	20	EW1CC4215EQ	35	LU1-C7242SD-Q	86
DE(OE/OT)PJ36NPQ	22	DS3WMC2148Q	20	EW1CC4215Q	35	LU1-C7242SS-Q	86
DE(OE/OT)PJ36WPQ	22	DT1BYD602430Q	19	EW1CC482430GQ	35	LU1-C7248DD-Q	87
DE(OE/OT)PJ42NPQ	22	DT1BYD6036Q	19	EW1CC483024GQ	35	LU1-J24A-(L/R)-Q	88
DE(OE/OT)PJ42WPQ	22	DT1BYD662430Q	19	EW1CC483030GQ	35	LU1-J30A-(L/R)-Q	88
DE(OE/OT)PJ48NPQ	22	DT1BYD6636Q	19	EW3(9/P)6630Q	38	LU1-J36A-(L/R)-Q	88
DE(OE/OT)PJ48WPQ	22, 24	DT1BYD722430Q	19	EW3BS3678S	37	LU1-J42A-(L/R)-Q	88
DE(OE/OT)PJ54WPQ	22, 24	DT1BYD7236Q	19	EW3BS7836S	37	LU1-J48A-(L/R)-Q	88
DE(OE/OT)PJ60WPQ	22, 24	DT1BYD7242Q	19	EW3CC483024GQ	37	LU1-J54A-(L/R)-Q	88
DE(OE/OT)PJ66WPQ	22	DT1BYD782430Q	19	EW3D7230Q	38	LU1-J60A-(L/R)-Q	88
DE(OE/OT)PJ72WPQ	22	DT1BYD7836Q	19	GTLT5E19	186	LU1-J66A-(L/R)-Q	88
DE(OE/OT)PJ78WPQ	22	DT1BYD7842Q	19	GTLT5E25	186	LU1-J72A-(L/R)-Q	88
DE(OE/OT)PJ84WPQ	22	DT1BYD842430Q	19	GTLT5E37	186	LU1-J78A-(L/R)-Q	88
DE(OE/OT)PJ96WPQ	22	DT1BYD8436Q	19	GTLT5E49	186	LU1-J84A-(L/R)-Q	88

<i>pattern no.</i>	<i>page</i>	<i>pattern no.</i>	<i>page</i>	<i>pattern no.</i>	<i>page</i>	<i>pattern no.</i>	<i>page</i>
LU1-J90A-(L/R)-Q	88	LU1-S2018-B-Q	80	LU1-S6224-A-Q	81	LU1-S9836-B-Q	83
LU1-J96A-(L/R)-Q	88	LU1-S2024-A-Q	81	LU1-S6224-B-Q	81	LU1-W30A-(L/R)-Q	89
LU1-P72SA-L-Q	85	LU1-S2024-B-Q	81	LU1-S6230-A-Q	82	LU1-W36A-(L/R)-Q	89
LU1-P72SA-R-Q	85	LU1-S2030-A-Q	82	LU1-S6230-B-Q	82	LU1-W42A-(L/R)-Q	89
LU1-P78DA-L-Q	85	LU1-S2030-B-Q	82	LU1-S6236-A-Q	83	LU1-W48A-(L/R)-Q	89
LU1-P78DA-R-Q	85	LU1-S2418-A-Q	76	LU1-S6236-B-Q	83	LU1-W54A-(L/R)-Q	89
LU1-R6636B-(L/R)-Q	84	LU1-S2418-B-Q	76	LU1-S6636-A-Q	79	LU1-W60A-(L/R)-Q	89
LU1-R7836B-(L/R)-Q	84	LU1-S2430-A-Q	78	LU1-S6636-B-Q	79	LU1-W66A-(L/R)-Q	89
LU1-R8730B-(L/R)-Q	84	LU1-S2430-B-Q	78	LU1-S6818-A-Q	80	LU1-W72A-(L/R)-Q	89
LU1-R9036B-(L/R)-Q	84	LU1-S2618-A-Q	80	LU1-S6818-B-Q	80	LU1-W78A-(L/R)-Q	89
LU1-S10218-A-Q	76	LU1-S2618-B-Q	80	LU1-S6824-A-Q	81	LU1-W84A-(L/R)-Q	89
LU1-S10218-B-Q	76	LU1-S2624-A-Q	81	LU1-S6824-B-Q	81	LU1-W90A-(L/R)-Q	89
LU1-S10224-A-Q	77	LU1-S2624-B-Q	81	LU1-S6830-A-Q	82	LU1-W96A-(L/R)-Q	89
LU1-S10224-B-Q	77	LU1-S2630-A-Q	82	LU1-S6830-B-Q	82	LV3-D64-(L/R)	99
LU1-S10230-A-Q	78	LU1-S2630-B-Q	82	LU1-S6836-A-Q	83	LV3-S18S-(L/R)	99
LU1-S10230-B-Q	78	LU1-S3218-A-Q	80	LU1-S6836-B-Q	83	LV3-S56-(L/R)	99
LU1-S10236-A-Q	79	LU1-S3218-B-Q	80	LU1-S7236-A-Q	79	LV3-W64-(L/R)	99
LU1-S10236-B-Q	79	LU1-S3224-A-Q	81	LU1-S7236-B-Q	79	MC1-30H1	47, 48
LU1-S10418-A-Q	80	LU1-S3224-B-Q	81	LU1-S7418-A-Q	80	MC1-30H1V	48
LU1-S10418-B-Q	80	LU1-S3230-A-Q	82	LU1-S7418-B-Q	80	MC1-30S2	45, 46
LU1-S10424-A-Q	81	LU1-S3230-B-Q	82	LU1-S7424-A-Q	81	MC1-30S2V	46
LU1-S10424-B-Q	81	LU1-S3636-A-Q	79	LU1-S7424-B-Q	81	MC1-39H1	47, 48
LU1-S10430-A-Q	82	LU1-S3636-B-Q	79	LU1-S7430-A-Q	82	MC1-39H1V	48
LU1-S10430-B-Q	82	LU1-S3818-A-Q	80	LU1-S7430-B-Q	82	MC1-39S2	45, 46
LU1-S10436-A-Q	83	LU1-S3818-B-Q	80	LU1-S7436-A-Q	83	MC1-39S2V	46
LU1-S10436-B-Q	83	LU1-S3824-A-Q	81	LU1-S7436-B-Q	83	MC1-42H1	47, 48
LU1-S10830-A-Q	78	LU1-S3824-B-Q	81	LU1-S7836-A-Q	79	MC1-42H1V	48
LU1-S10830-B-Q	78	LU1-S3830-A-Q	82	LU1-S7836-B-Q	79	MC1-42S2	45, 46
LU1-S10836-A-Q	79	LU1-S3830-B-Q	82	LU1-S8018-A-Q	80	MC1-42S2V	46
LU1-S10836-B-Q	79	LU1-S3836-A-Q	83	LU1-S8018-B-Q	80	MC1-48H1	47, 48
LU1-S11018-A-Q	80	LU1-S3836-B-Q	83	LU1-S8024-A-Q	81	MC1-48H1V	48
LU1-S11018-B-Q	80	LU1-S4236-A-Q	79	LU1-S8024-B-Q	81	MC1-48S2	45, 46
LU1-S11024-A-Q	81	LU1-S4236-B-Q	79	LU1-S8030-A-Q	82	MC1-48S2V	46
LU1-S11024-B-Q	81	LU1-S4418-A-Q	80	LU1-S8030-B-Q	82	MC1-56H1	47, 48
LU1-S11030-A-Q	82	LU1-S4418-B-Q	80	LU1-S8036-A-Q	83	MC1-56H1V	48
LU1-S11030-B-Q	82	LU1-S4424-A-Q	81	LU1-S8036-B-Q	83	MC1-56S2	45, 46
LU1-S11036-A-Q	83	LU1-S4424-B-Q	81	LU1-S8436-A-Q	79	MC1-56S2V	46
LU1-S11036-B-Q	83	LU1-S4430-A-Q	82	LU1-S8436-B-Q	79	MC1-64S2	45, 46
LU1-S11418-A-Q	76	LU1-S4430-B-Q	82	LU1-S8618-A-Q	80	MC1-64S2V	46
LU1-S11418-B-Q	76	LU1-S4436-A-Q	83	LU1-S8618-B-Q	80	MC1-74H1	47, 48
LU1-S11424-A-Q	77	LU1-S4436-B-Q	83	LU1-S8624-A-Q	81	MC1-74H1V	48
LU1-S11424-B-Q	77	LU1-S4836-A-Q	79	LU1-S8624-B-Q	81	MC1-74S2	45, 46
LU1-S11430-A-Q	78	LU1-S4836-B-Q	79	LU1-S8630-A-Q	82	MC1-74S2V	46
LU1-S11430-B-Q	78	LU1-S5018-A-Q	80	LU1-S8630-B-Q	82	MC1-80H1	47, 48
LU1-S11436-A-Q	79	LU1-S5018-B-Q	80	LU1-S8636-A-Q	83	MC1-80H1V	48
LU1-S11436-B-Q	79	LU1-S5024-A-Q	81	LU1-S8636-B-Q	83	MC1-80S2	45, 46
LU1-S11618-A-Q	80	LU1-S5024-B-Q	81	LU1-S9036-A-Q	79	MC1-80S2V	46
LU1-S11618-B-Q	80	LU1-S5030-A-Q	82	LU1-S9036-B-Q	79	MC1-C30Q	49
LU1-S11624-A-Q	81	LU1-S5030-B-Q	82	LU1-S9218-A-Q	80	MC1-C39Q	49
LU1-S11624-B-Q	81	LU1-S5036-A-Q	83	LU1-S9218-B-Q	80	MC1-C42Q	49
LU1-S11630-A-Q	82	LU1-S5036-B-Q	83	LU1-S9224-A-Q	81	MC1-C48Q	49
LU1-S11630-B-Q	82	LU1-S5436-A-Q	79	LU1-S9224-B-Q	81	MC1-C56Q	49
LU1-S11636-A-Q	83	LU1-S5436-B-Q	79	LU1-S9230-A-Q	82	MC1-C64Q	49
LU1-S11636-B-Q	83	LU1-S5618-A-Q	80	LU1-S9230-B-Q	82	MC1-C74Q	49
LU1-S12030-A-Q	78	LU1-S5618-B-Q	80	LU1-S9236-A-Q	83	MC1-C80Q	49
LU1-S12030-B-Q	78	LU1-S5624-A-Q	81	LU1-S9236-B-Q	83	MK4-K10226-P/V-Q	92
LU1-S12036-A-Q	79	LU1-S5624-B-Q	81	LU1-S9636-A-Q	79	MK4-K10826-P/V-Q	92
LU1-S12036-B-Q	79	LU1-S5630-A-Q	82	LU1-S9636-B-Q	79	MK4-K11426-P/V-Q	92
LU1-S1818-A-Q	76	LU1-S5630-B-Q	82	LU1-S9818-A-Q	80	MK4-K12026-P/V-Q	92
LU1-S1818-B-Q	76	LU1-S5636-A-Q	83	LU1-S9818-B-Q	80	MK4-K1826-P/V-Q	92
LU1-S1824-A-Q	77	LU1-S5636-B-Q	83	LU1-S9824-A-Q	81	MK4-K2426-P/V-Q	92
LU1-S1824-B-Q	77	LU1-S6036-A-Q	79	LU1-S9824-B-Q	81	MK4-K3026-P/V-Q	92
LU1-S1830-A-Q	78	LU1-S6036-B-Q	79	LU1-S9830-A-Q	82	MK4-K3626-P/V-Q	92
LU1-S1830-B-Q	78	LU1-S6218-A-Q	80	LU1-S9830-B-Q	82	MK4-K4226-P/V-Q	92
LU1-S2018-A-Q	80	LU1-S6218-B-Q	80	LU1-S9836-A-Q	83	MK4-K4826-P/V-Q	92

<i>pattern no.</i>	<i>page</i>	<i>pattern no.</i>	<i>page</i>	<i>pattern no.</i>	<i>page</i>	<i>pattern no.</i>	<i>page</i>
MK4-K5426-P/V-Q	92	MP3-W2624-C/S/T-Q	44	MU1-C4272SD-Q	72	MU1-R6636-E-Q	70
MK4-K8426-P/V-Q	92	MP3-W2630-C/S/T-Q	44	MU1-C4272SS-Q	72	MU1-R6636-R-Q	70
MK4-K9026-P/V-Q	92	MP3-W2636-C/S/T-Q	44	MU1-C4842DD-Q	73	MU1-R7836-B-Q	70
MK4-K9626-P/V-Q	92	MP3-W2642-C/S/T-Q	44	MU1-C4842DS-Q	73	MU1-R7836-E-Q	70
MK4-R10226-P/V-L/R-Q	93	MP3-W2648-C/S/T-Q	44	MU1-C4842SD-Q	72	MU1-R7836-R-Q	70
MK4-R10826-P/V-L/R-Q	93	MP3-W2660-C/S/T-Q	44	MU1-C4842SS-Q	72	MU1-R8730-B-Q	70
MK4-R11426-P/V-L/R-Q	93	MPTIEDOWN	49	MU1-C4860DD-Q	73	MU1-R8730-E-Q	70
MK4-R12026-P/V-L/R-Q	93	MS2-U10213-H-Q	96	MU1-C4866DD-Q	73	MU1-R8730-R-Q	70
MK4-R1826-P/V-L/R-Q	93	MS2-U10213-Q	96	MU1-C4866DS-Q	73	MU1-R9036-B-Q	70
MK4-R2426-P/V-L/R-Q	93	MS2-U10813-H-Q	96	MU1-C4866SD-Q	72	MU1-R9036-E-Q	70
MK4-R5426-P/V-L/R-Q	93	MS2-U10813-Q	96	MU1-C4866SS-Q	72	MU1-R9036-R-Q	70
MK4-R7826-P/V-L/R-Q	93	MS2-U11413-H-Q	96	MU1-C4872DD-Q	73	MU1-S10218-A-Q	62
MK4-R8426-P/V-L/R-Q	93	MS2-U11413-Q	96	MU1-C6042DD-Q	73	MU1-S10218-B-Q	62
MK4-R9026-P/V-L/R-Q	93	MS2-U12013-H-Q	96	MU1-C6042DS-Q	73	MU1-S10224-A-Q	63
MK4-R9626-P/V-L/R-Q	93	MS2-U12013-Q	96	MU1-C6042SD-Q	72	MU1-S10224-B-Q	63
MK4-T10226-P/V-Q	92	MS2-U5413-H-Q	96	MU1-C6042SS-Q	72	MU1-S10230-A-Q	64
MK4-T10826-P/V-Q	92	MS2-U5413-Q	96	MU1-C6048DD-Q	73	MU1-S10230-B-Q	64
MK4-T11426-P/V-Q	92	MS2-U9613-H-Q	96	MU1-C6642DD-Q	73	MU1-S10236-B-Q	65
MK4-T12026-P/V-Q	92	MS2-U9613-Q	96	MU1-C6642DS-Q	73	MU1-S10236-R-Q	65
MK4-T1826-P/V-Q	92	MS2-W10213-H-Q	95	MU1-C6642SD-Q	72	MU1-S10418-A-Q	66
MK4-T2426-P/V-Q	92	MS2-W10213-Q	95	MU1-C6642SS-Q	72	MU1-S10418-B-Q	66
MK4-T3026-P/V-Q	92	MS2-W10813-H-Q	95	MU1-C6648DD-Q	73	MU1-S10424-A-Q	67
MK4-T3626-P/V-Q	92	MS2-W10813-Q	95	MU1-C6648DS-Q	73	MU1-S10424-B-Q	67
MK4-T4226-P/V-Q	92	MS2-W11413-H-Q	95	MU1-C6648SD-Q	72	MU1-S10430-A-Q	68
MK4-T4826-P/V-Q	92	MS2-W11413-Q	95	MU1-C6648SS-Q	72	MU1-S10430-B-Q	68
MK4-T5426-P/V-Q	92	MS2-W12013-H-Q	95	MU1-C7242DD-Q	73	MU1-S10436-B-Q	69
MK4-T8426-P/V-Q	92	MS2-W12013-Q	95	MU1-C7242DS-Q	73	MU1-S10436-R-Q	69
MK4-T9026-P/V-Q	92	MS2-W5413-H-Q	95	MU1-C7242SD-Q	72	MU1-S10818-A-Q	62
MK4-T9626-P/V-Q	92	MS2-W5413-Q	95	MU1-C7242SS-Q	72	MU1-S10818-B-Q	62
MK4-V2448-P/V-Q	91	MS2-W9613-H-Q	95	MU1-C7248DD-Q	73	MU1-S10824-A-Q	63
MK4-V2648-P/V-Q	91	MS2-W9613-Q	95	MU1-J24A-L-Q	74	MU1-S10824-B-Q	63
MK4-X2448-P/V-Q	91	MT1-30S2	50, 51	MU1-J24A-R-Q	74	MU1-S10830-A-Q	64
MK4-X2648-P/V-Q	91	MT1-30S2V	51	MU1-J30A-L-Q	74	MU1-S10830-B-Q	64
MM3-IS42F-Q	94	MT1-39S2	50, 51	MU1-J30A-R-Q	74	MU1-S10836-B-Q	65
MM3-IS48F-Q	94	MT1-39S2V	51	MU1-J36A-L-Q	74	MU1-S10836-R-Q	65
MM3-IS54F-Q	94	MT1-42S2	50, 51	MU1-J36A-R-Q	74	MU1-S11018-A-Q	66
MM3-IS54R-Q	94	MT1-42S2V	51	MU1-J42A-L-Q	74	MU1-S11018-B-Q	66
MM3-IS84F-Q	94	MT1-48S2	50, 51	MU1-J42A-R-Q	74	MU1-S11024-A-Q	67
MM3-IS84R-Q	94	MT1-48S2V	51	MU1-J48A-L-Q	74	MU1-S11024-B-Q	67
MM3-IS90F-Q	94	MT1-56S2	50, 51	MU1-J48A-R-Q	74	MU1-S11030-A-Q	68
MM3-IS90R-Q	94	MT1-56S2V	51	MU1-J54A-L-Q	74	MU1-S11030-B-Q	68
MM3-IS96F-Q	94	MT1-64S2	50, 51	MU1-J54A-R-Q	74	MU1-S11036-B-Q	69
MM3-IS96R-Q	94	MT1-64S2V	51	MU1-J60A-L-Q	74	MU1-S11036-R-Q	69
MN2T5E19	100	MT1-74S2	50, 51	MU1-J60A-R-Q	74	MU1-S11418-A-Q	62
MN2T5E25	100	MT1-74S2V	51	MU1-J66A-L-Q	74	MU1-S11418-B-Q	62
MN2T5E37	100	MT1-80S2	50, 51	MU1-J66A-R-Q	74	MU1-S11424-A-Q	63
MN2T5E49	100	MT1-80S2V	51	MU1-J72A-L-Q	74	MU1-S11424-B-Q	63
MO8-24	97	MT5-CS2	49	MU1-J72A-R-Q	74	MU1-S11430-A-Q	64
MO8-N24	97	MU1-C4242DD-Q	73	MU1-J78A-L-Q	74	MU1-S11430-B-Q	64
MP2-CPP	49	MU1-C4242DS-Q	73	MU1-J78A-R-Q	74	MU1-S11436-B-Q	65
MP3-W0818-C/S/T-Q	44	MU1-C4242SD-Q	72	MU1-J84A-L-Q	74	MU1-S11436-R-Q	65
MP3-W0824-C/S/T-Q	44	MU1-C4248DD-Q	73	MU1-J84A-R-Q	74	MU1-S11618-A-Q	66
MP3-W0830-C/S/T-Q	44	MU1-C4248DS-Q	73	MU1-J90A-L-Q	74	MU1-S11618-B-Q	66
MP3-W0836-C/S/T-Q	44	MU1-C4248SD-Q	72	MU1-J90A-R-Q	74	MU1-S11624-A-Q	67
MP3-W0842-C/S/T-Q	44	MU1-C4248SS-Q	72	MU1-J96A-L-Q	74	MU1-S11624-B-Q	67
MP3-W0848-C/S/T-Q	44	MU1-C4260DD-Q	73	MU1-J96A-R-Q	74	MU1-S11630-A-Q	68
MP3-W0860-C/S/T-Q	44	MU1-C4260DS-Q	73	MU1-P66DA-L-Q	71	MU1-S11630-B-Q	68
MP3-W1418-C/S/T-Q	44	MU1-C4260SD-Q	72	MU1-P66DA-R-Q	71	MU1-S11636-B-Q	69
MP3-W1424-C/S/T-Q	44	MU1-C4260SS-Q	72	MU1-P66SA-L-Q	71	MU1-S11636-R-Q	69
MP3-W1430-C/S/T-Q	44	MU1-C4266DD-Q	73	MU1-P66SA-R-Q	71	MU1-S12018-A-Q	62
MP3-W1436-C/S/T-Q	44	MU1-C4266DS-Q	73	MU1-P72DA-L-Q	71	MU1-S12018-B-Q	62
MP3-W1442-C/S/T-Q	44	MU1-C4266SD-Q	72	MU1-P72DA-R-Q	71	MU1-S12024-A-Q	63
MP3-W1448-C/S/T-Q	44	MU1-C4266SS-Q	72	MU1-P78SA-L-Q	71	MU1-S12024-B-Q	63
MP3-W1460-C/S/T-Q	44	MU1-C4272DD-Q	73	MU1-P78SA-R-Q	71	MU1-S12030-A-Q	64
MP3-W2618-C/S/T-Q	44	MU1-C4272DS-Q	73	MU1-R6636-B-Q	70	MU1-S12030-B-Q	64

<i>pattern no.</i>	<i>page</i>	<i>pattern no.</i>	<i>page</i>	<i>pattern no.</i>	<i>page</i>	<i>pattern no.</i>	<i>page</i>
MU1-S12036-B-Q	65	MU1-S5436-R-Q	65	MU1-S8636-R-Q	69	MW2-S10836-B-Q	57
MU1-S12036-R-Q	65	MU1-S5618-A-Q	66	MU1-S9018-A-Q	62	MW2-S10836-R-Q	57
MU1-S1818-A-Q	62	MU1-S5618-B-Q	66	MU1-S9018-B-Q	62	MW2-S11018-A-Q	58
MU1-S1818-B-Q	62	MU1-S5624-A-Q	67	MU1-S9036-B-Q	65	MW2-S11018-B-Q	58
MU1-S1824-A-Q	63	MU1-S5624-B-Q	67	MU1-S9036-R-Q	65	MW2-S11024-A-Q	59
MU1-S1824-B-Q	63	MU1-S5630-A-Q	68	MU1-S9218-A-Q	66	MW2-S11024-B-Q	59
MU1-S1830-A-Q	64	MU1-S5630-B-Q	68	MU1-S9218-B-Q	66	MW2-S11030-A-Q	60
MU1-S1830-B-Q	64	MU1-S5636-B-Q	69	MU1-S9224-A-Q	67	MW2-S11030-B-Q	60
MU1-S2018-A-Q	66	MU1-S5636-R-Q	69	MU1-S9224-B-Q	67	MW2-S11036-B-Q	61
MU1-S2018-B-Q	66	MU1-S6018-A-Q	62	MU1-S9230-A-Q	68	MW2-S11036-R-Q	61
MU1-S2024-A-Q	67	MU1-S6036-B-Q	65	MU1-S9230-B-Q	68	MW2-S11418-A-Q	54
MU1-S2024-B-Q	67	MU1-S6036-R-Q	65	MU1-S9236-B-Q	69	MW2-S11418-B-Q	54
MU1-S2030-A-Q	68	MU1-S6218-A-Q	66	MU1-S9236-R-Q	69	MW2-S11424-A-Q	55
MU1-S2030-B-Q	68	MU1-S6218-B-Q	66	MU1-S9618-A-Q	62	MW2-S11424-B-Q	55
MU1-S2418-A-Q	62	MU1-S6224-A-Q	67	MU1-S9618-B-Q	62	MW2-S11430-A-Q	56
MU1-S2430-A-Q	64	MU1-S6224-B-Q	67	MU1-S9636-B-Q	65	MW2-S11430-B-Q	56
MU1-S2430-B-Q	64	MU1-S6230-A-Q	68	MU1-S9636-R-Q	65	MW2-S11436-B-Q	57
MU1-S2618-A-Q	66	MU1-S6230-B-Q	68	MU1-S9818-A-Q	66	MW2-S11436-R-Q	57
MU1-S2618-B-Q	66	MU1-S6236-B-Q	69	MU1-S9818-B-Q	66	MW2-S11618-A-Q	58
MU1-S2624-A-Q	67	MU1-S6236-R-Q	69	MU1-S9824-A-Q	67	MW2-S11618-B-Q	58
MU1-S2624-B-Q	67	MU1-S6618-A-Q	62	MU1-S9824-B-Q	67	MW2-S11624-A-Q	59
MU1-S2630-A-Q	68	MU1-S6636-B-Q	65	MU1-S9830-A-Q	68	MW2-S11624-B-Q	59
MU1-S2630-B-Q	68	MU1-S6636-R-Q	65	MU1-S9830-B-Q	68	MW2-S11630-A-Q	60
MU1-S3018-A-Q	62	MU1-S6818-A-Q	66	MU1-S9836-B-Q	69	MW2-S11630-B-Q	60
MU1-S3218-A-Q	66	MU1-S6818-B-Q	66	MU1-S9836-R-Q	69	MW2-S11636-B-Q	61
MU1-S3218-B-Q	66	MU1-S6824-A-Q	67	MU1-W30A-L-Q	75	MW2-S11636-R-Q	61
MU1-S3224-A-Q	67	MU1-S6824-B-Q	67	MU1-W30A-R-Q	75	MW2-S12018-A-Q	54
MU1-S3224-B-Q	67	MU1-S6830-A-Q	68	MU1-W54A-L-Q	75	MW2-S12018-B-Q	54
MU1-S3230-A-Q	68	MU1-S6830-B-Q	68	MU1-W54A-R-Q	75	MW2-S12024-A-Q	55
MU1-S3230-B-Q	68	MU1-S6836-B-Q	69	MU1-W60A-L-Q	75	MW2-S12024-B-Q	55
MU1-S3618-A-Q	62	MU1-S6836-R-Q	69	MU1-W60A-R-Q	75	MW2-S12030-A-Q	56
MU1-S3636-B-Q	65	MU1-S7218-A-Q	62	MU1-W66A-L-Q	75	MW2-S12030-B-Q	56
MU1-S3636-R-Q	65	MU1-S7236-B-Q	65	MU1-W66A-R-Q	75	MW2-S12036-B-Q	57
MU1-S3818-A-Q	66	MU1-S7236-R-Q	65	MU1-W72A-L-Q	75	MW2-S12036-R-Q	57
MU1-S3818-B-Q	66	MU1-S7418-A-Q	66	MU1-W72A-R-Q	75	MW2-S1818-A-Q	54
MU1-S3824-A-Q	67	MU1-S7418-B-Q	66	MU1-W78A-L-Q	75	MW2-S1818-B-Q	54
MU1-S3824-B-Q	67	MU1-S7424-A-Q	67	MU1-W78A-R-Q	75	MW2-S1824-A-Q	55
MU1-S3830-A-Q	68	MU1-S7424-B-Q	67	MU1-W84A-L-Q	75	MW2-S1824-B-Q	55
MU1-S3830-B-Q	68	MU1-S7430-A-Q	68	MU1-W84A-R-Q	75	MW2-S1830-A-Q	56
MU1-S3836-B-Q	69	MU1-S7430-B-Q	68	MU1-W90A-L-Q	75	MW2-S1830-B-Q	56
MU1-S3836-R-Q	69	MU1-S7436-B-Q	69	MU1-W90A-R-Q	75	MW2-S2018-A-Q	58
MU1-S4218-A-Q	62	MU1-S7436-R-Q	69	MU1-W96A-L-Q	75	MW2-S2018-B-Q	58
MU1-S4236-B-Q	65	MU1-S7818-A-Q	62	MU1-W96A-R-Q	75	MW2-S2024-A-Q	59
MU1-S4236-R-Q	65	MU1-S7818-B-Q	62	MW2-S10218-A-Q	54	MW2-S2024-B-Q	59
MU1-S4418-A-Q	66	MU1-S7836-B-Q	65	MW2-S10218-B-Q	54	MW2-S2030-A-Q	60
MU1-S4418-B-Q	66	MU1-S7836-R-Q	65	MW2-S10224-A-Q	55	MW2-S2030-B-Q	60
MU1-S4424-A-Q	67	MU1-S8018-A-Q	66	MW2-S10224-B-Q	55	MW2-S2418-A-Q	54
MU1-S4424-B-Q	67	MU1-S8018-B-Q	66	MW2-S10230-A-Q	56	MW2-S2418-B-Q	54
MU1-S4430-A-Q	68	MU1-S8024-A-Q	67	MW2-S10230-B-Q	56	MW2-S2430-A-Q	56
MU1-S4430-B-Q	68	MU1-S8024-B-Q	67	MW2-S10236-B-Q	57	MW2-S2430-B-Q	56
MU1-S4436-B-Q	69	MU1-S8030-A-Q	68	MW2-S10236-R-Q	57	MW2-S2618-A-Q	58
MU1-S4436-R-Q	69	MU1-S8030-B-Q	68	MW2-S10418-A-Q	58	MW2-S2618-B-Q	58
MU1-S4818-A-Q	62	MU1-S8036-B-Q	69	MW2-S10418-B-Q	58	MW2-S2624-A-Q	59
MU1-S4836-B-Q	65	MU1-S8036-R-Q	69	MW2-S10424-A-Q	59	MW2-S2624-B-Q	59
MU1-S4836-R-Q	65	MU1-S8418-A-Q	62	MW2-S10424-B-Q	59	MW2-S2630-A-Q	60
MU1-S5018-A-Q	66	MU1-S8418-B-Q	62	MW2-S10430-A-Q	60	MW2-S2630-B-Q	60
MU1-S5018-B-Q	66	MU1-S8436-B-Q	65	MW2-S10430-B-Q	60	MW2-S3018-A-Q	54
MU1-S5024-A-Q	67	MU1-S8436-R-Q	65	MW2-S10436-B-Q	61	MW2-S3218-A-Q	58
MU1-S5024-B-Q	67	MU1-S8618-A-Q	66	MW2-S10436-R-Q	61	MW2-S3218-B-Q	58
MU1-S5030-A-Q	68	MU1-S8618-B-Q	66	MW2-S10818-A-Q	54	MW2-S3224-A-Q	59
MU1-S5030-B-Q	68	MU1-S8624-A-Q	67	MW2-S10818-B-Q	54	MW2-S3224-B-Q	59
MU1-S5036-B-Q	69	MU1-S8624-B-Q	67	MW2-S10824-A-Q	55	MW2-S3230-A-Q	60
MU1-S5036-R-Q	69	MU1-S8630-A-Q	68	MW2-S10824-B-Q	55	MW2-S3230-B-Q	60
MU1-S5418-A-Q	62	MU1-S8630-B-Q	68	MW2-S10830-A-Q	56	MW2-S3618-A-Q	54
MU1-S5436-B-Q	65	MU1-S8636-B-Q	69	MW2-S10830-B-Q	56	MW2-S3636-B-Q	57

<i>pattern no.</i>	<i>page</i>	<i>pattern no.</i>	<i>page</i>	<i>pattern no.</i>	<i>page</i>	<i>pattern no.</i>	<i>page</i>
MW2-S3636-R-Q	57	MW2-S7424-A-Q	59	QACC822WE	182	QR212JUK	136
MW2-S3818-A-Q	58	MW2-S7424-B-Q	59	QACC823WE	182	QR212KUK	136
MW2-S3818-B-Q	58	MW2-S7430-A-Q	60	QAFPD12	183	QR213JUK	136
MW2-S3824-A-Q	59	MW2-S7430-B-Q	60	QAFPD13	183	QR213KUK	136
MW2-S3824-B-Q	59	MW2-S7436-B-Q	61	QAFPD22	183	QR2ES4215	110
MW2-S3830-A-Q	60	MW2-S7436-R-Q	61	QAFPD23	183	QR2ES49158	110
MW2-S3830-B-Q	60	MW2-S7818-A-Q	54	QAFPD10	183	QR2ES498	110
MW2-S3836-B-Q	61	MW2-S7818-B-Q	54	QAFPD11	183	QR2ES648	110
MW2-S3836-R-Q	61	MW2-S8018-A-Q	58	QAFPD120	183	QR3B0P (11/22/33) 3418	104
MW2-S4218-A-Q	54	MW2-S8018-B-Q	58	QAFPD121	183	QR3B0P (11/22/33) 3420	104
MW2-S4236-B-Q	57	MW2-S8024-A-Q	59	QAFPD10	183	QR3B0P (11/22/33) 3424	104
MW2-S4236-R-Q	57	MW2-S8024-B-Q	59	QAFPD11	183	QR3B0P (11/22/33) 3430	104
MW2-S4418-A-Q	58	MW2-S8030-A-Q	60	QAFPD20	183	QR3B0P (11/22/33) 3436	104
MW2-S4418-B-Q	58	MW2-S8030-B-Q	60	QAFPD21	183	QR3B0P (11/22/33) 3442	104
MW2-S4424-A-Q	59	MW2-S8036-B-Q	61	QAFPO10W	183	QR3B0P (11/22/33) 3448	104
MW2-S4424-B-Q	59	MW2-S8036-R-Q	61	QAFPO11W	183	QR3B0P (11/22/33) 4218	104
MW2-S4430-A-Q	60	MW2-S8418-A-Q	54	QAFPO12W	183	QR3B0P (11/22/33) 4220	104
MW2-S4430-B-Q	60	MW2-S8418-B-Q	54	QAFPO13W	183	QR3B0P (11/22/33) 4224	104
MW2-S4436-B-Q	61	MW2-S8436-B-Q	57	QAFPO20W	183	QR3B0P (11/22/33) 4230	104
MW2-S4436-R-Q	61	MW2-S8436-R-Q	57	QAFPO21W	183	QR3B0P (11/22/33) 4236	104
MW2-S4818-A-Q	54	MW2-S8618-A-Q	58	QAFPO22W	183	QR3B0P (11/22/33) 4242	104
MW2-S4836-B-Q	57	MW2-S8618-B-Q	58	QAFPO23W	183	QR3B0P (11/22/33) 4248	104
MW2-S4836-R-Q	57	MW2-S8624-A-Q	59	QAW1T43030	181	QR3B0P (11/22/33) 4260	104
MW2-S5018-A-Q	58	MW2-S8624-B-Q	59	QAW1T43636	181	QR3B0P (11/22/33) 4266	104
MW2-S5018-B-Q	58	MW2-S8630-A-Q	60	QAW1T44242	181	QR3B0P (11/22/33) 4272	104
MW2-S5024-A-Q	59	MW2-S8630-B-Q	60	QAW1T44830	181	QR3B0P (11/22/33) 4918	104
MW2-S5024-B-Q	59	MW2-S8636-B-Q	61	QAW1T44848	181	QR3B0P (11/22/33) 4920	104
MW2-S5030-A-Q	60	MW2-S8636-R-Q	61	QAW1T46030	181	QR3B0P (11/22/33) 4924	104
MW2-S5030-B-Q	60	MW2-S9018-A-Q	54	QAW1T47230	181	QR3B0P (11/22/33) 4930	104
MW2-S5036-B-Q	61	MW2-S9018-B-Q	54	QAW1T47236	181	QR3B0P (11/22/33) 4936	104
MW2-S5036-R-Q	61	MW2-S9036-B-Q	57	QAW1TR24	181	QR3B0P (11/22/33) 4942	104
MW2-S5418-A-Q	54	MW2-S9036-R-Q	57	QAW1TR30	181	QR3B0P (11/22/33) 4948	104
MW2-S5436-B-Q	57	MW2-S9218-A-Q	58	QAW1TR36	181	QR3B0P (11/22/33) 4960	104
MW2-S5436-R-Q	57	MW2-S9218-B-Q	58	QAW1TR42	181	QR3B0P (11/22/33) 4966	104
MW2-S5618-A-Q	58	MW2-S9224-A-Q	59	QAW1TR48	181	QR3B0P (11/22/33) 4972	104
MW2-S5618-B-Q	58	MW2-S9224-B-Q	59	QDMRD6436(L/R)()(-)L	52	QR3B0P (11/22/33) 6418	105
MW2-S5624-A-Q	59	MW2-S9230-A-Q	60	QDMRD6436(L/R)()(-)N	52	QR3B0P (11/22/33) 6420	105
MW2-S5624-B-Q	59	MW2-S9230-B-Q	60	QDMRD6442(L/R)()(-)L	52	QR3B0P (11/22/33) 6424	105
MW2-S5630-A-Q	60	MW2-S9236-B-Q	61	QDMRD6442(L/R)()(-)N	52	QR3B0P (11/22/33) 6430	105
MW2-S5630-B-Q	60	MW2-S9236-R-Q	61	QDMRD6448(L/R)()(-)L	52	QR3B0P (11/22/33) 6436	105
MW2-S5636-B-Q	61	MW2-S9618-A-Q	54	QDMRD6448(L/R)()(-)N	52	QR3B0P (11/22/33) 6442	105
MW2-S5636-R-Q	61	MW2-S9618-B-Q	54	QDMRD7836(L/R)()(-)L	52	QR3B0P (11/22/33) 6448	105
MW2-S6018-A-Q	54	MW2-S9636-B-Q	57	QDMRD7836(L/R)()(-)N	52	QR3B0P (11/22/33) 6460	105
MW2-S6036-B-Q	57	MW2-S9636-R-Q	57	QDMRD7842(L/R)()(-)L	52	QR3B0P (11/22/33) 6466	105
MW2-S6036-R-Q	57	MW2-S9818-A-Q	58	QDMRD7842(L/R)()(-)N	52	QR3B0P (11/22/33) 6472	105
MW2-S6218-A-Q	58	MW2-S9818-B-Q	58	QDMRD7848(L/R)()(-)L	52	QR3B0P (11/22/33) 7918	105
MW2-S6218-B-Q	58	MW2-S9824-A-Q	59	QDMRD7848(L/R)()(-)N	52	QR3B0P (11/22/33) 7920	105
MW2-S6224-A-Q	59	MW2-S9824-B-Q	59	QDMRDFT36	52	QR3B0P (11/22/33) 7924	105
MW2-S6224-B-Q	59	MW2-S9830-A-Q	60	QDMRDFT42	52	QR3B0P (11/22/33) 7930	105
MW2-S6230-A-Q	60	MW2-S9830-B-Q	60	QDMRDFT48	52	QR3B0P (11/22/33) 7936	105
MW2-S6230-B-Q	60	MW2-S9836-B-Q	61	QR111JUK	137	QR3B0P (11/22/33) 7942	105
MW2-S6236-B-Q	61	MW2-S9836-R-Q	61	QR111KUK	137	QR3B0P (11/22/33) 7948	105
MW2-S6236-R-Q	61	MZ1-B2415	98	QR112JUK	137	QR3B0P (11/22/33) 7960	105
MW2-S6618-A-Q	54	MZ1-B2419	98	QR112KUK	137	QR3B0P (11/22/33) 7966	105
MW2-S6818-A-Q	58	MZ1-B2422	98	QR113JUK	137	QR3B0P (11/22/33) 7972	105
MW2-S6818-B-Q	58	QACDL720	182	QR113KUK	137	QR3B0T (11/22/33) 3418	106
MW2-S6824-A-Q	59	QACDL721	182	QR2 SLAT 1518	108	QR3B0T (11/22/33) 3420	106
MW2-S6824-B-Q	59	QACDL820	182	QR2 SLAT 1520	108	QR3B0T (11/22/33) 3424	106
MW2-S6830-A-Q	60	QACDL821	182	QR2 SLAT 1524	108	QR3B0T (11/22/33) 3430	106
MW2-S6830-B-Q	60	QACDR720	182	QR2 SLAT 1530	108	QR3B0T (11/22/33) 3436	106
MW2-S6836-B-Q	61	QACDR721	182	QR2 SLAT 1536	108	QR3B0T (11/22/33) 3442	106
MW2-S6836-R-Q	61	QACDR820	182	QR2 SLAT 1542	108	QR3B0T (11/22/33) 3448	106
MW2-S7218-A-Q	54	QACDR821	182	QR2 SLAT 1548	108	QR3B0T (11/22/33) 4218	106
MW2-S7418-A-Q	58	QACC722WE	182	QR211JUK	136	QR3B0T (11/22/33) 4220	106
MW2-S7418-B-Q	58	QACC723WE	182	QR211KUK	136	QR3B0T (11/22/33) 4224	106

<i>pattern no.</i>	<i>page</i>	<i>pattern no.</i>	<i>page</i>	<i>pattern no.</i>	<i>page</i>	<i>pattern no.</i>	<i>page</i>
QR3B0T (11/22/33) 4230	106	QRBC11 (L/R)	128	QRC713DHD (L/R)	152	QRCCDLA24278	120
QR3B0T (11/22/33) 4236	106	QRBDH102M(F/R)	134	QRC713DHP(L/R)	154, 156	QRCCDLA24284	120
QR3B0T (11/22/33) 4242	106	QRBDH108M(F/R)	134	QRC713G	144, 145	QRCCDLA24290	120
QR3B0T (11/22/33) 4248	106	QRBDH114M(F/R)	134	QRC713P	144, 145	QRCCDLA24296	120
QR3B0T (11/22/33) 4918	106	QRBDH120M(F/R)	134	QRC731B	144, 145	QRCCDLA24860	120
QR3B0T (11/22/33) 4920	106	QRBDH28MR	134	QRC731DHBM	155	QRCCDLA24866	120
QR3B0T (11/22/33) 4924	106	QRBDH34MR	134	QRC731DHBW	152	QRCCDLA24872	120
QR3B0T (11/22/33) 4930	106	QRBDH46MR	134	QRC732DHC	153, 155	QRCCDLA24878	120
QR3B0T (11/22/33) 4936	106	QRBDH58MR	134	QRC732DHH	153, 156	QRCCDLA24884	120
QR3B0T (11/22/33) 4942	106	QRC332DHF	146, 147	QRC732DHI	154	QRCCDLA24890	120
QR3B0T (11/22/33) 4948	106	QRC332F	140, 141	QRC732DHP	154, 156	QRCCDLA24896	120
QR3B0T (11/22/33) 6418	107	QRC333DHF	146, 147	QRC732G	144, 145	QRCCDLA33660	120
QR3B0T (11/22/33) 6420	107	QRC333F	140, 141	QRC732P	144, 145	QRCCDLA33666	120
QR3B0T (11/22/33) 6424	107	QRC362DHF	146, 147	QRC733DHC	153, 155	QRCCDLA33690	120
QR3B0T (11/22/33) 6430	107	QRC362F	140, 141	QRC733DHH	153, 156	QRCCDLA34260	120
QR3B0T (11/22/33) 6436	107	QRC363DHF	146, 147	QRC733DHI	154	QRCCDLA34266	120
QR3B0T (11/22/33) 6442	107	QRC363F	140, 141	QRC733DHP	154, 156	QRCCDLA34272	120
QR3B0T (11/22/33) 6448	107	QRC612DHC (L/R)	148, 150	QRC733G	144, 145	QRCCDLA34278	120
QR3B0T (11/22/33) 7918	107	QRC612DHD (L/R)	148	QRC733P	144, 145	QRCCDLA34284	120
QR3B0T (11/22/33) 7920	107	QRC612DHP (L/R)	149, 151	QRC761B	144, 145	QRCCDLA34290	120
QR3B0T (11/22/33) 7924	107	QRC612G	142, 143	QRC761DHBM	155	QRCCDLA34296	120
QR3B0T (11/22/33) 7930	107	QRC612P	142, 143	QRC761DHBW	152	QRCCDLA34860	120
QR3B0T (11/22/33) 7936	107	QRC613DHC (L/R)	148, 150	QRC762DHC	153, 155	QRCCDLA34866	120
QR3B0T (11/22/33) 7942	107	QRC613DHD (L/R)	148	QRC762DHH	153, 156	QRCCDLA34872	120
QR3B0T (11/22/33) 7948	107	QRC613DHP (L/R)	149, 151	QRC762DHI	154	QRCCDLA34878	120
QR3S (LL/11/22/33) 0818	108	QRC613G	142, 143	QRC762DHP	154, 156	QRCCDLA34884	120
QR3S (LL/11/22/33) 0820	108	QRC613P	142, 143	QRC762G	144, 145	QRCCDLA34890	120
QR3S (LL/11/22/33) 0824	108	QRC632DHC	148, 150	QRC762P	144, 145	QRCCDLA34896	120
QR3S (LL/11/22/33) 0830	108	QRC632DHD	148	QRC763DHC	153, 155	QRCCDLA23660	121
QR3S (LL/11/22/33) 0836	108	QRC632DHE (L/R)	148, 150	QRC763DHH	153, 156	QRCCDLA23666	121
QR3S (LL/11/22/33) 0842	108	QRC632DHH	149, 151	QRC763DHI	154	QRCCDLA23690	121
QR3S (LL/11/22/33) 0848	108	QRC632DHI	149	QRC763DHP	154, 156	QRCCDLA24260	121
QR3S (LL/11/22/33) 1518	108	QRC632DHP	149, 151	QRC763G	144, 145	QRCCDLA24266	121
QR3S (LL/11/22/33) 1520	108	QRC632G	142, 143	QRC763P	144, 145	QRCCDLA24272	121
QR3S (LL/11/22/33) 1524	108	QRC632P	142, 143	QRCA 363623	126	QRCCDLA24278	121
QR3S (LL/11/22/33) 1530	108	QRC633DHC	148, 150	QRCA 363632	126	QRCCDLA24284	121
QR3S (LL/11/22/33) 1536	108	QRC633DHD	148	QRCA 364223	126	QRCCDLA24290	121
QR3S (LL/11/22/33) 1542	108	QRC633DHE (L/R)	148, 150	QRCA 364232	126	QRCCDLA24296	121
QR3S (LL/11/22/33) 1548	108	QRC633DHH	149, 151	QRCA 423623	126	QRCCDLA24860	121
QR9C7794	135	QRC633DHI	149	QRCA 423632	126	QRCCDLA24866	121
QR9C7798	135	QRC633DHP	149, 151	QRCA 424223	126	QRCCDLA24872	121
QR9C7801	135	QRC633G	142, 143	QRCA 424232	126	QRCCDLA24878	121
QR9C7917	135	QRC633P	142, 143	QRCA 424233	126	QRCCDLA24884	121
QR9C7919	135	QRC662DHC	148, 150	QRCA 424823	126	QRCCDLA24890	121
QR9D5459	135	QRC662DHD	148	QRCA 424832	126	QRCCDLA24896	121
QR9G0413	135	QRC662DHE (L/R)	148, 150	QRCA 484223	126	QRCCDLA33660	121
QR9G1171	135	QRC662DHH	149, 151	QRCA 484232	126	QRCCDLA33666	121
QR9G1173	135	QRC662DHI	149	QRCA 484823	126	QRCCDLA33690	121
QR9G1295	135	QRC662DHP	149, 151	QRCA 484832	126	QRCCDLA34260	121
QR9G1499	135	QRC662G	142, 143	QRCA 484833	126	QRCCDLA34266	121
QR9C2826	135	QRC662P	142, 143	QRCA 484833	126	QRCCDLA34266	121
QR9C6777	135	QRC663DHC	148, 150	QRCA 484833	126	QRCCDLA34272	121
QR9C6778	135	QRC663DHD	148	QRCA 484833	126	QRCCDLA34278	121
QR9C6779	135	QRC663DHE (L/R)	148, 150	QRCA 484833	126	QRCCDLA34284	121
QR9C6780	135	QRC663DHH	149, 151	QRCA 484833	126	QRCCDLA34290	121
QR9C6781	135	QRC663DHI	149	QRCA 484833	126	QRCCDLA34296	121
QR9C6782	135	QRC663DHP	149, 151	QRCAWF484811	129	QRCCDLA34860	121
QRB102(M/H)(F/R)	134	QRC663G	142, 143	QRCAWF484812	129	QRCCDLA34866	121
QRB108(M/H)(F/R)	134	QRC663P	142, 143	QRCAWF484821	129	QRCCDLA34872	121
QRB114(M/H)(F/R)	134	QRC712DHC(L/R)	153, 155	QRCAWF484822	129	QRCCDLA34878	121
QRB120(M/H)(F/R)	134	QRC712DHD (L/R)	152	QRCCDLA23660	120	QRCCDLA34884	121
QRB28MR	134	QRC712DHP(L/R)	154, 156	QRCCDLA23666	120	QRCCDLA34890	121
QRB34MR	134	QRC712G	144, 145	QRCCDLA23690	120	QRCCDLA34896	121
QRB46MR	134	QRC712P	144, 145	QRCCDLA24260	120	QRCEAL223654	122
QRB58MR	134	QRC713DHC(L/R)	153, 155	QRCCDLA24266	120	QRCEAL223666	122
				QRCCDLA24272	120	QRCEAL223678	122

<i>pattern no.</i>	<i>page</i>	<i>pattern no.</i>	<i>page</i>	<i>pattern no.</i>	<i>page</i>	<i>pattern no.</i>	<i>page</i>
QRCEAL223684	122	QRKB 484823	125	QROAF48S1	159	QROA036T1DH	166
QRCEAL223690	122	QRKB 484832	125	QROAF48S1DH	168	QROA042T0	157
QRCEAL223696	122	QRKB 484833	125	QROAF54S0	158	QROA042TODH	163
QRCEAL224254	122	QRM9A5430 N	123	QROAF54S0DH	165	QROA042T1	158
QRCEAL224266	122	QRM9A5436 N	123	QROAF54S1	159	QROA042T1DH	166
QRCEAL224278	122	QRM9A6030 N	123	QROAF54S1DH	168	QROA048T0	157
QRCEAL224284	122	QRM9A6036 N	123	QROAF66S0	158	QROA048TODH	163
QRCEAL224290	122	QRM9A6630	123	QROAF66S0DH	165	QROA048T1	158
QRCEAL224296	122	QRM9A6636	123	QROAF66S1	159	QROA048T1DH	166
QRCEAL224860	122	QRM9A7230	123	QROAF66S1DH	168	QROA054T0	157
QRCEAL224866	122	QRM9A7236	123	QROAF78S0	158	QROA054TODH	163
QRCEAL224878	122	QRM9A7830	123	QROAF78S0DH	165	QROA054T1	158
QRCEAL224890	122	QRM9A7836	123	QROAF78S1	159	QROA054T1DH	166
QRCEAR223654	122	QRM9A8436	123	QROAF78S1DH	168	QROA066T0	157
QRCEAR223666	122	QRM9A9636	123	QROAF90S0	158	QROA066TODH	163
QRCEAR223678	122	QRM9B5430 N	124	QROAF90S0DH	165	QROA066T1	158
QRCEAR223684	122	QRM9B5436 N	124	QROAF90S1	159	QROA066T1DH	166
QRCEAR223690	122	QRM9B6030 N	124	QROAF90S1DH	168	QROA078T0	157
QRCEAR223696	122	QRM9B6036 N	124	QROAH30T0	157	QROA078TODH	163
QRCEAR224254	122	QRM9B6630	124	QROAH30T0DH	164	QROA078T1	158
QRCEAR224266	122	QRM9B6636	124	QROAH30T1	159	QROA078T1DH	166
QRCEAR224278	122	QRM9B7230	124	QROAH30T1DH	167	QROA084T0	157
QRCEAR224284	122	QRM9B7236	124	QROAH36T0	157	QROA084TODH	163
QRCEAR224290	122	QRM9B7830	124	QROAH36T0DH	164	QROA084T1	158
QRCEAR224296	122	QRM9B7836	124	QROAH36T1	159	QROA084T1DH	166
QRCEAR224860	122	QRM9B8436	124	QROAH36T1DH	167	QROBF30S0	161
QRCEAR224866	122	QRM9B9636	124	QROAH42T0	157	QROBF30S0DH	171
QRCEAR224878	122	QRMPA5430 N	123	QROAH42T0DH	164	QROBF30S1	162
QRCEAR224890	122	QRMPA5436 N	123	QROAH42T1	159	QROBF30S1DH	174
QRE24	133	QRMPA6030 N	123	QROAH42T1DH	167	QROBF36S0	161
QRE35F	133	QRMPA6036 N	123	QROAH48T0	157	QROBF36S0DH	171
QREDH24	133	QRMPA6630	123	QROAH48T0DH	164	QROBF36S1	162
QREDH35F	133	QRMPA6636	123	QROAH48T1	159	QROBF36S1DH	174
QRFTCWSUH21	111	QRMPA7230	123	QROAH48T1DH	167	QROBF42S0	161
QRFTCWSUH25	111	QRMPA7236	123	QROAH54T0	157	QROBF42S0DH	171
QRFTCWSUH37	111	QRMPA7830	123	QROAH54T0DH	164	QROBF42S1	162
QRKA 363623	125	QRMPA7836	123	QROAH54T1	159	QROBF42S1DH	174
QRKA 363632	125	QRMPA8436	123	QROAH54T1DH	167	QROBF48S0	161
QRKA 364223	125	QRMPA9636	123	QROAH66T0	157	QROBF48S0DH	171
QRKA 364232	125	QRMPB5430 N	124	QROAH66T0DH	164	QROBF48S1	162
QRKA 423623	125	QRMPB5436 N	124	QROAH66T1	159	QROBF48S1DH	174
QRKA 423632	125	QRMPB6030 N	124	QROAH66T1DH	167	QROBF54S0	161
QRKA 424223	125	QRMPB6036 N	124	QROAH78T0	157	QROBF54S0DH	171
QRKA 424232	125	QRMPB6630	124	QROAH78T0DH	164	QROBF54S1	162
QRKA 424233	125	QRMPB6636	124	QROAH78T1	159	QROBF54S1DH	174
QRKA 424823	125	QRMPB7230	124	QROAH78T1DH	167	QROBF66S0	161
QRKA 424832	125	QRMPB7236	124	QROAH84T0	157	QROBF66S0DH	171
QRKA 484223	125	QRMPB7830	124	QROAH84T0DH	164	QROBF66S1	162
QRKA 484232	125	QRMPB7836	124	QROAH84T1	159	QROBF66S1DH	174
QRKA 484823	125	QRMPB8436	124	QROAH84T1DH	167	QROBF78S0	161
QRKA 484832	125	QRMPB9636	124	QROA030BM	177	QROBF78S0DH	171
QRKA 484833	125	QROAF30S0	158	QROA030BW	176	QROBF78S1	162
QRKB 363623	125	QROAF30S0DH	165	QROA030DHBM	177	QROBF78S1DH	174
QRKB 363632	125	QROAF30S1	159	QROA030DHBW	176	QROBF90S0	161
QRKB 364223	125	QROAF30S1DH	168	QROA030T0	157	QROBF90S0DH	171
QRKB 364232	125	QROAF36S0	158	QROA030T0DH	163	QROBF90S1	162
QRKB 423623	125	QROAF36S0DH	165	QROA030T1	158	QROBF90S1DH	174
QRKB 423632	125	QROAF36S1	159	QROA030T1DH	166	QROBH30T0	160
QRKB 424223	125	QROAF36S1DH	168	QROA036BM	177	QROBH30TODH	170
QRKB 424232	125	QROAF42S0	158	QROA036BW	176	QROBH30T1	162
QRKB 424233	125	QROAF42S0DH	165	QROA036DHBM	177	QROBH30T1DH	173
QRKB 424823	125	QROAF42S1	159	QROA036DHBW	176	QROBH36T0	160
QRKB 424832	125	QROAF42S1DH	168	QROA036T0	157	QROBH36TODH	170
QRKB 484223	125	QROAF48S0	158	QROA036T0DH	163	QROBH36T1	162
QRKB 484232	125	QROAF48S0DH	165	QROA036T1	158	QROBH36T1DH	173

<i>pattern no.</i>	<i>page</i>	<i>pattern no.</i>	<i>page</i>	<i>pattern no.</i>	<i>page</i>	<i>pattern no.</i>	<i>page</i>
QROBH42T0	160	QROMH42S0	175	QRSAC4218	118	QRSB1023	115
QROBH42T0DH	170	QROMH48S0	175	QRSAC4236	118	QRSB1024	115
QROBH42T1	162	QROMH54S0	175	QRSAC4818	118	QRSB1081	115
QROBH42T1DH	173	QROMH66S0	175	QRSAC5418	118	QRSB1082	115
QROBH48T0	160	QROMH78S0	175	QRSAC5436	118	QRSB1083	115
QROBH48T0DH	170	QROMH84S0	175	QRSAC6018	118	QRSB1084	115
QROBH48T1	162	QROMH90S0	175	QRSAC6036	118	QRSB1141	115
QROBH48T1DH	173	QROMH96S0	175	QRSAC6618	118	QRSB1142	115
QROBH54T0	160	QROPH24S0	175	QRSAC6636	118	QRSB1143	115
QROBH54T0DH	170	QROPH42S0	175	QRSAC7218	118	QRSB1144	115
QROBH54T1	162	QROPH48S0	175	QRSAC7236	118	QRSB1201	115
QROBH54T1DH	173	QROPH54S0	175	QRSAC7818	118	QRSB1202	115
QROBH66T0	160	QROPH84S0	175	QRSAC7836	118	QRSB1203	115
QROBH66T0DH	170	QRP231J	138, 139	QRSAC8418	118	QRSB1204	115
QROBH66T1	162	QRP232J	138, 139	QRSAC8436	118	QRSB161-N	115
QROBH66T1DH	173	QRP261J	138, 139	QRSAC9018	118	QRSB162-N	115
QROBH78T0	160	QRP262J	138, 139	QRSAC9036	118	QRSB163-N	115
QROBH78T0DH	170	QRP301J	138, 139	QRSAC9618	118	QRSB484	115
QROBH78T1	162	QRP302J	138, 139	QRSAP1041	113	QRSB544	115
QROBH78T1DH	173	QRP361J	138, 139	QRSAP1042	113	QRSB784	115
QROBH84T0	160	QRP362J	138, 139	QRSAP1043	114	QRSB844	115
QROBH84T0DH	170	QRPAB17UK	136	QRSAP1101	113	QRSB904	115
QROBH84T1	162	QRPDHB17UK	137	QRSAP1102	113	QRSB964	115
QROBH84T1DH	173	QRPHTB2424	179	QRSAP1103	114	QRSBC10218	119
QROBO30BM	177	QRPHTB3624	179	QRSAP261	113	QRSBC10818	119
QROBO30BW	176	QRPHTB4824	179	QRSAP262	113	QRSBC3018	119
QROBO30DHBM	177	QRPHTB5424	179	QRSAP263	113	QRSBC3618	119
QROBO30DHBW	176	QRPHTB6024	179	QRSAP321	113	QRSBC3636	119
QROBO30T0	160	QRPHTB7224	179	QRSAP322	113	QRSBC4218	119
QROBO30T0DH	169	QRRAW12048	132	QRSAP323	113	QRSBC4236	119
QROBO30T1	161	QRRAW14448	132	QRSAP381	113	QRSBC4818	119
QROBO30T1DH	172	QRRAW16848	132	QRSAP382	113	QRSBC5418	119
QROBO36BM	177	QRRAW19248	132	QRSAP383	113	QRSBC5436	119
QROBO36BW	176	QRRAW4848	132	QRSAP441	113	QRSBC6018	119
QROBO36DHBM	177	QRRAW9648	132	QRSAP442	113	QRSBC6036	119
QROBO36DHBW	176	QRSA1021	112	QRSAP443	114	QRSBC6618	119
QROBO36T0	160	QRSA1022	112	QRSAP501	113	QRSBC6636	119
QROBO36T0DH	169	QRSA1023	112	QRSAP502	113	QRSBC7218	119
QROBO36T1	161	QRSA1024	112	QRSAP503	114	QRSBC7236	119
QROBO36T1DH	172	QRSA1081	112	QRSAP561	113	QRSBC7818	119
QROBO42T0	160	QRSA1082	112	QRSAP562	113	QRSBC7836	119
QROBO42T0DH	169	QRSA1083	112	QRSAP563	114	QRSBC8418	119
QROBO42T1	161	QRSA1084	112	QRSAP621	113	QRSBC8436	119
QROBO42T1DH	172	QRSA1141	112	QRSAP622	113	QRSBC9018	119
QROBO48T0	160	QRSA1142	112	QRSAP623	114	QRSBC9036	119
QROBO48T0DH	169	QRSA1143	112	QRSAP681	113	QRSBC9618	119
QROBO48T1	161	QRSA1144	112	QRSAP682	113	QRSBP1041	116
QROBO48T1DH	172	QRSA1201	112	QRSAP683	114	QRSBP1042	116
QROBO54T0	160	QRSA1202	112	QRSAP741	113	QRSBP1043	117
QROBO54T0DH	169	QRSA1203	112	QRSAP742	113	QRSBP1101	116
QROBO54T1	161	QRSA1204	112	QRSAP743	114	QRSBP1102	116
QROBO54T1DH	172	QRSA161-N	112	QRSAP801	113	QRSBP1103	117
QROBO66T0	160	QRSA162-N	112	QRSAP802	113	QRSBP261	116
QROBO66T0DH	169	QRSA163-N	112	QRSAP803	114	QRSBP262	116
QROBO66T1	161	QRSA484	112	QRSAP861	113	QRSBP263	116
QROBO66T1DH	172	QRSA544	112	QRSAP862	113	QRSBP321	116
QROBO78T0	160	QRSA784	112	QRSAP863	114	QRSBP322	116
QROBO78T0DH	169	QRSA844	112	QRSAP921	113	QRSBP323	116
QROBO78T1	161	QRSA904	112	QRSAP922	113	QRSBP381	116
QROBO78T1DH	172	QRSA964	112	QRSAP923	114	QRSBP382	116
QROBO84T0	160	QRSAC10218	118	QRSAP981	113	QRSBP383	116
QROBO84T0DH	169	QRSAC10818	118	QRSAP982	113	QRSBP441	116
QROBO84T1	161	QRSAC3018	118	QRSAP983	114	QRSBP442	116
QROBO84T1DH	172	QRSAC3618	118	QRSB1021	115	QRSBP443	117
QROMH24S0	175	QRSAC3636	118	QRSB1022	115	QRSBP501	116

<i>pattern no.</i>	<i>page</i>	<i>pattern no.</i>	<i>page</i>
QRSBP502	116	QS9C5498	109
QRSBP503	117	QS9C5499	109
QRSBP561	116	QS9C5875	109
QRSBP562	116	QS9C5876	109
QRSBP563	117	RBC18 (L/R)	128
QRSBP621	116	RBCC	128
QRSBP622	116	RTAT5E19	185
QRSBP623	117	RTAT5E25	185
QRSBP681	116	RTAT5E37	185
QRSBP682	116	RTAT5E49	185
QRSBP683	117	RTAT5E61	185
QRSBP741	116	RTLT5E19	178
QRSBP742	116	RTLT5E25	178
QRSBP743	117	RTLT5E37	178
QRSBP801	116	RTLT5E49	178
QRSBP802	116	RTLT5E61	178
QRSBP803	117	RTLT5E73	178
QRSBP861	116	RTLT5E85	178
QRSBP862	116		
QRSBP863	117		
QRSBP921	116		
QRSBP922	116		
QRSBP923	117		
QRSBP981	116		
QRSBP982	116		
QRSBP983	117		
QRSD3627	135		
QRSDA3627	135		
QRSDHD3628	135		
QRSDHDA3628	135		
QRTA2424	130		
QRTA3030	130		
QRTA5454	130		
QRTAW12048	131		
QRTAW14448	131		
QRTAW16848	131		
QRTAW19248	131		
QRTAW4848	131		
QRTAW9648	131		
QRTB2424	130		
QRTB3030	130		
QRTB5454	130		
QRWHTB2424	179		
QRWHTB5424	179		
QRWHTB6024	179		
QRWHTB7224	179		
QRWSU34	111		
QRWSU42	111		
QRWSU49	111		
QRWSU64	111		
QRWSU79	111		
QRWSUH34	111		
QRWSUH42	111		
QRWSUH49	111		
QRWSUH64	111		
QRWSUH79	111		
QS990981	110		
QS994873	109		
QS9A5986	110		
QS9A8002	109		
QS9A8003	109		
QS9B2960	109		
QS9C2320	110		
QS9C2321	110		
QS9C2425	110		

Selling Policy

	<p>This Selling Policy supercedes all previous selling policies. Prices, discounts and product offerings are subject to change without notice.</p>
Terms & Conditions of Sales	<p>Sales by Knoll, Inc. or Knoll North America Corp. ("Seller") of Knoll Product Lines (hereinafter "Products") within the United States and Canada are made only on the terms which are contained in this Selling Policy. Seller hereby gives notice of its objection to any different or additional terms and conditions. This sale is expressly conditional upon Purchaser's assent to the terms and conditions set forth below. Additional terms and conditions may apply to KnollStudio and KnollTextiles orders. These terms and conditions may be modified or supplemented only by a written document signed by an authorized representative of Seller. These terms and conditions supercede any prior and/or contemporaneous agreements or correspondence between Purchaser and Seller. Written quotations expire thirty (30) days from the date of issuance and can be withdrawn by written notice anytime during that period. Where Purchaser and Seller have entered into the Knoll Electronic Terms and Conditions, all orders, acknowledgements, invoices and other business communications placed or transmitted in accordance with the Knoll Electronic Terms and Conditions shall be deemed to be in writing and signed and shall be valid for all purposes as if they were originated and maintained in documentary form.</p>
Ordering Information	<p>All orders must be in writing. The product pattern number(s) contained on Seller's order acknowledgement shall be the final expression of the order.</p>
Order Confirmation	<p>A purchase order is not binding on Seller until Purchaser has received Seller's order confirmation or acknowledgment.</p>
Pricing Policies	<p>List prices are subject to change without notice.</p> <p>List prices shall be those prices in effect on the date of receipt of a complete purchase order unless shipment is requested more than ninety (90) days after order entry in which case prices in effect on the date of shipment apply. List prices include specified freight costs. Unless specified in writing by Seller, no other charges are included in Seller's list prices.</p>
Taxes	<p>All sales, use, excise and other taxes applicable to the sale of the Products shall be paid by Purchaser. If Purchaser claims an exemption from any tax, Purchaser shall submit to Seller the appropriate exemption certificates.</p>
Terms of Payment	<p>Payment for one hundred percent (100%) of the net order amount is due within thirty (30) days of the date of invoice, which is issued upon shipment. In case of any discrepancies, such as shortages, and Seller is notified in writing within ten (10) days of receipt of Product, only that portion may be deducted and the balance paid. For orders greater than \$100,000 net, a fifty percent (50%) deposit is due at the time of order placement, with the remainder due within thirty (30) days of the date of invoice.</p> <p>KnollStudio orders less than \$2,000 require payment for one hundred percent (100%) of the net order amount (including any applicable sales tax and charges for inside delivery, special packaging, etc.), due at time of order placement. For KnollStudio orders greater than \$2,000, a one-half (50%) deposit is due at time of order placement with the remainder (including any applicable sales tax and charges for inside delivery, special packaging, etc.) due prior to shipment.</p> <p>If, in the judgment of Seller, Purchaser's financial condition does not justify the terms of the payment, Seller may require full or partial payment in advance.</p> <p>Past due accounts shall be charged one and one-half percent (1.5%) per month, or the highest rate permitted by law, whichever is less, and will be added to the outstanding balance. In the event Purchaser defaults on payment, Purchaser shall be liable for all collection costs, including reasonable attorney's fees and costs.</p>
Changes and Cancellation	<p>Purchase orders may not be changed or cancelled, in whole or in part, without prior written consent of Seller. Changes may effect delivery dates. Expenses incurred because of changes shall be charged to Purchaser. In the event of cancellations, Purchaser will be liable for reasonable cancellation charges established by Seller. Orders for special Product, orders including "COM" (hereinafter defined) material and orders pursuant to expedited delivery programs, may not be canceled.</p>
Freight Prepaid	<p>Freight is prepaid and included in the price of all Products, except KnollTextiles, within the 48 contiguous United States for orders placed with Knoll, Inc. and within Canada, excluding the Yukon, Northwest Territories, Nunavut and Newfoundland for orders placed with Knoll North America Corp. Packing is tested for rigorous motion and transportation but is not guaranteed to protect furniture from conditions over which the Seller has no control. If special packaging is required for any reason, please consult with your sales representative or dealer. Seller shall select the method of shipment and routing. All shipments shall be tailgate deliveries. Freight for all KnollTextiles orders is prepaid and added to the invoice.</p>
Delivery/Freight Charges	<p>Shipments outside the contiguous 48 United States and Canada shall be shipped F.O.B. Origin.</p> <p>For shipments outside the contiguous United States and Canada, Purchaser is responsible for the cost of freight from point of embarkation, including any handling and transportation charges incidental to loading at the point of departure and unloading at the final destination.</p> <p>Conditions beyond the control of Seller, including weather, available facilities and traffic conditions, may affect exact time of delivery. Seller shall not be responsible for specific carrier delivery date or time unless it has made a specific delivery commitment, in writing.</p> <p>Nonstandard methods of shipment and/or additional services are available upon request. Purchaser will be billed for the differential cost of any special services in excess of standard surface carrier freight costs. Premium charges, at Purchaser's request, will be added for airfreight, exclusive use of vehicle and extra, export or special packaging. Accessorial charges will be added for inside delivery, extra labor, reassignment and redelivery.</p> <p>Partial shipments may be made and invoiced by Seller.</p>
Claims	<p>All shipments for all Knoll Products within the contiguous United States and Canada are F.O.B. Origin. Risk of loss passes to Purchaser at time of delivery to carrier. Purchaser shall inspect all Products upon receipt and notify Seller within ten (10) working days after receipt of any damage or defects which are, or should be, apparent from an inspection of the Product and its packaging. Failure of Purchaser to make a claim against carrier or notify Seller during the ten (10) working day period shall constitute acceptance of the Products and waiver of any apparent defects, errors or shortages. Seller will agree to repair or replace Product damaged in shipment if Purchaser has notified Seller of freight damage within ten (10) working days after receipt and assigns its rights against the carrier.</p>
Seller's Security Interest	<p>Until Seller receives the full payment for the Product, Seller shall have a security interest in the Product. Purchaser agrees to perform all acts, including but not limited to the execution and filing of documentation, which may be necessary to perfect and assure the security interest of Seller.</p>
Returns	<p>The return of Products without a written authorization by Seller shall not be accepted. To receive authorization for Product return, please call Customer Service. All Products that are returned pursuant to a valid authorization shall be subject to a twenty-five percent (25%) of list restocking charge. Products not currently offered for sale by Seller (including COM) shall not be authorized for return. All returned Products must be unused, in original condition and in the original Seller packing cartons. No refund or credit shall be given for damaged Products.</p>
Held Orders/Storage	<p>If Purchaser requests that an order be held or delayed, prices and terms and conditions in effect at the time of shipment shall apply. If Purchaser requests a delay after the time when Seller can defer production, Purchaser will be invoiced for the Product, payable in accordance with standard terms, when the order is ready for shipment. Seller may transfer the Product to storage, in which case all expenses incurred in connection with storage, including demurrage, preparation for storage, storage charges and handling shall be payable by Purchaser upon submission of invoices by Seller. Risk of loss to the Product shall pass to the Purchaser upon delivery of the Product into storage.</p>

Selling Policy

Customer's Own Material	<p>A Purchaser who requests a fabric or other surface material not standard to Seller's line of Products ("COM") must submit samples of the requested material to Seller prior to entry of a purchaser order. Seller shall determine if the material is suitable to its manufacturing processes and meets any requirements of Underwriters Laboratories. If the COM is acceptable, Seller will then establish a price for using the COM or the Product in question. For a description of the procedures for submitting samples and testing, contact customer resources or your sales representative. Seller shall have no responsibility for the appearance, condition, performance, durability, colorfastness or any other physical attribute of the COM. Purchaser shall indemnify and hold Seller harmless for any damages, injuries or losses arising out of or related to use of the COM on the Product.</p>
Warranty	<p>Seller warrants to the original Purchaser only that the Products Seller manufactures and sells to Purchaser are free of defects in workmanship and materials, during the applicable warranty period set forth below.</p> <p>Warranty period set forth below is for 24-hour, 7 days a week, multi shift use.</p> <p>Should any failure to conform with this limited warranty appear to a Product listed below during the applicable warranty period from the date of shipment, Seller shall, upon prompt written notice, repair or replace, at its option and costs, the affected part or parts.</p> <p><i>Product and Period of Warranty</i></p> <p><i>Lifetime: AutoStrada, Calibre, Crinion Open Table, Currents, Dividends Horizon, Equity, Morrison, Reff laminate, Series 2 Storage, Template, Antenna Workspaces</i> and other non-wood components (except cascade edge worksurfaces, operational parts, controls, electrical, Lighting, <i>Series 2 Veneer Front Storage</i>, special or custom products, see below)</p> <p><i>10 Years: AutoStrada, Crinion Open Table, Reff</i> wood components, <i>Series 2 Veneer Front Storage, Antenna Workspaces</i> wood components, <i>Wood Casegoods (Magnusson, The Graham Collection)</i> (except wood casegoods upholstered surfaces, see below), <i>Interaction</i> tables (except height adjustment mechanisms for <i>Counterforce</i>, crank-adjustable, and split-top tables and worksurfaces, see below), <i>Reuter</i> overheads, <i>Reuter</i> vertical storage, <i>KnollExtra</i> Sapper Monitor Arm Collection, Adjustable keyboard mechanisms and platforms, Communication Boards (except fabric board textiles, see below), Smokador collection (except leathers, see below), and Orchestra Universal Systems Accessories, <i>Bulldog, Chadwick, Essentials Work Chairs, Generation by Knoll</i> work chair, <i>Life, Moment, RPM</i> and <i>Sapper</i> seating structural and operational parts, controls, casters, pneumatic cylinders, seat and back suspension material (except seating upholstery, textiles and leathers, finishes and labor, see below). Labor to repair <i>Generation by Knoll</i> work chair.</p> <p><i>5 Years:</i> Operational parts, controls, electrical, Lighting (except light ballasts, bulbs and power supply, see below), cascade edge worksurfaces, special or custom product, wood veneer products, <i>Currents</i> handerank, <i>Interaction Counterforce, Interaction</i> crank-adjustable, and split-top mechanisms, <i>KnollStudio, KnollExtra</i> Wishbone and Zorro monitor supports, CPU storage and all universal storage drawers, <i>Spark Series</i> seating structural parts, (except seating upholstery, textiles, finishes and labor, see below).</p> <p><i>3 Years: Bulldog, Chadwick, Essentials Work Chairs, Life, Moment, RPM, Sapper</i> seating upholstery, textiles and leathers, finishes and labor to repair, <i>Generation by Knoll</i> work chair seating upholstery, textiles and leathers, and finishes, <i>Spark Series</i> seating upholstery and textiles. Fabric boards textiles and Smokador Collection leathers.</p> <p><i>2 Years:</i> All other <i>KnollExtra</i> product</p> <p><i>1 Year:</i> Light ballasts, bulbs and power supply, seating upholstered ampads and soft ampads, <i>Spark Series</i> seating finishes and labor to repair, wood casegoods upholstered surfaces.</p> <p>This warranty does not apply to:</p> <ul style="list-style-type: none">• Damage caused by a carrier other than the Seller.• Normal wear and tear or acts or omissions of parties other than Seller (including user modification, improper use or installation of Products).• COM or other third party materials applied to Products.• Products not installed by or under the auspices of a Knoll Dealer.• Dramatic temperature variations or exposure to unusual conditions.• Except as specifically noted above, textiles and upholstery supplied by <i>KnollTextiles</i> (consult current <i>KnollTextiles</i> price list for applicable warranty). <p>Natural variations occurring in wood, marble, and leather shall not be considered defects, and the Seller does not guarantee the colorfastness or matching of the colors, grains or textures, or surface hardness of such materials. The Seller also does not guarantee the colorfastness of fiberglass panel surfaces. THE EXPRESS WARRANTIES CONTAINED HEREIN ARE IN LIEU OF ALL OTHER WARRANTIES, EXPRESS OR IMPLIED, INCLUDING ANY WARRANTIES OF MERCHANTABILITY AND FITNESS FOR PARTICULAR PURPOSE AND ALL OTHER WARRANTIES ARISING FROM COURSE OF DEALING OR USAGE OF TRADE.</p> <p>The remedies provided above are the Purchaser's sole remedies for any failure of Seller to comply with its obligations regarding the workmanship of its Products. Correction of any nonconformity in the manner and for the period of time provided shall constitute complete fulfillment of all liabilities of Seller, with respect to or arising out of the Product furnished hereunder.</p>
Delay/Force Majeure	<p>Seller shall not be liable for failure to perform or for delay in performance due to fire, flood, strike or other labor difficulty, act of God, act of any governmental authority or of the Purchaser, riot, embargo, fuel or energy shortage, wrecks or delay in transportation, inability to obtain necessary labor, materials or manufacturing facilities from usual sources or failure of suppliers to meet their contractual obligations, or due to any cause beyond its reasonable control. If any such event occurs, Seller may extend delivery dates by a period of time necessary to overcome the effect of such delay, allocate available Product or cancel any purchase order.</p>
Compliance with Law	<p>PURCHASER IS SOLELY RESPONSIBLE FOR COMPLIANCE WITH ALL APPLICABLE FEDERAL, STATE AND LOCAL LAWS, ORDINANCES, REGULATIONS, RULES AND STANDARDS RELATING TO THE INSTALLATION, MAINTENANCE, USE AND OPERATION OF THE PRODUCTS.</p>
Patents	<p>Subject to the following provisions, Seller shall, at its own expense, defend or, at its option, settle any claim, suit or proceeding brought against the Purchaser, and/or its vendees, mediate and immediate, so far as based on an allegation that any Product or any part thereof furnished hereunder constitutes a direct or a contributory infringement of any claim of any patent of the United States or Canada. This obligation shall be effective only if Purchaser shall have made all payments then due hereunder and if Seller is notified promptly in writing and given authority, information and assistance for the defense of said claim, suit or proceeding. Seller shall pay all damages and costs awarded in such suit or proceedings so defended.</p> <p>The foregoing indemnity does not apply to the following:</p> <ul style="list-style-type: none">• Products supplied according to a design other than that of Seller, and which is required by the Purchaser.• Combination of the Product with another product not furnished hereunder unless Seller is a contributory infringer.• Any settlements of a suit or proceeding made without Seller's written consent.
Limitations of Liability	<p>SELLER, ITS CONTRACTORS, AUTHORIZED DEALERS AND SUBCONTRACTORS OR SUPPLIERS OF ANY TIER SHALL NOT BE LIABLE TO PURCHASER FOR ANY SPECIAL, INDIRECT, INCIDENTAL OR CONSEQUENTIAL DAMAGES ARISING FROM A BREACH OF THIS AGREEMENT.</p> <p>Purchaser's remedies set forth herein are exclusive and the liability of Seller with respect to the breach of this agreement or any contract entered into between the parties pursuant hereto shall not exceed the price of the Product or part on which such liability is based.</p>

KnollKey Lock Program

KnollKey Lock Program General Information

Following is the KnollKey lock policy, applicable to all products.

Knoll furniture can be ordered keyed-alike or random keyed. Key-alike and random keying instructions cannot be mixed on any single order. Only one of the two instructions can be used on an individual order. When an order is submitted with mixed (key-alike and random) instructions, Knoll will release the order as key-alike only and lock cores will have to be specified separately.

Key-alike

For the convenience of the user, furniture may be keyed alike at no charge. Write "Key-alike" in the description of your purchase order for any pedestal, overhead, file or other item you wish to have keyed alike.

Using the key-alike instructions, order cores and keys as line items on your purchase order. Do NOT submit a key-alike form. The Knoll East Greenville Lock Center will select key numbers from the standard range of K 001 - K 250. Key numbers will not be repeated unless over 250 sets are ordered. Lock cores keyed-alike will ship separately from the product, ready for field installation.

There is no charge for key-alike orders if placed with the furniture order.

IF THE KEY-ALIKE ORDER IS NOT PLACED AT LEAST TWO WEEKS PRIOR TO THE FURNITURE SHIP DATE, A \$50 HANDLING CHARGE AND AIR FREIGHT CHARGES WILL APPLY.

If product is ordered and shipped random-keyed, additional lock cores for key-alike are billable.

Random-Keying

To specify product keyed-random, write "key-random" in the product description. Random-keyed product is shipped with the lock core factory installed. A shrouded key is included. Random means no effort has been made to match key numbers, or to make them different.

Keys

A Knoll shrouded key is shipped with every lock core. 250 Key numbers are available. For numbers above 250, contact Custom Product Development. Additional keys and key blanks are available. See service parts for more information.

Master Keying

Knoll locks can be controlled by means of a master key. There is no additional per-lock charge for master keying. A letter of approval from the client must accompany orders for master keys.

Installing Lock Cores

Lock cores can be installed or removed in the field by using a change key. Cores must be in the unlocked position to be removed. See service parts for change key pattern number and pricing.

Lock Distribution

All orders for key-alike lock cores/keys are packaged and shipped from the East Greenville Lock Center, regardless of where the pedestals, overhead, or other units are produced. Random keyed product will have cores factory-installed.

How to Specify Key-Alike

Following is an example of how to specify key-alike for a cluster of 10 workstations.

Step 1 - Using the project floorplan, count the number of locks in each workstation.

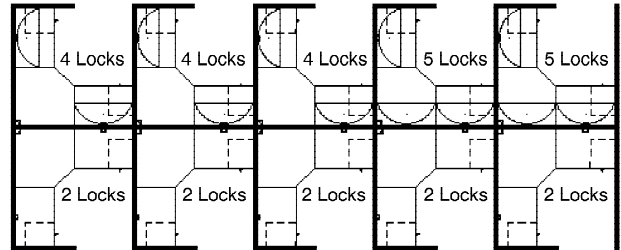

Step 2 - Count the number of workstations with the same quantity of locks. Group together the workstations with a like number of locks.

5 workstations with 2 locks per station
3 workstations with 4 locks per station
2 workstations with 5 locks per station

Step 3 - For the first group (5 sets of 2 locks), enter the number of workstations in the quantity column.

Qty	Pattern #	Description	Unit List	Ext. List
5				

Step 4 - Then enter the pattern number "KSPEC_ _" and add a suffix for the number of locks for that group (i.e., for 2 locks per station, add the suffix "2"). Up to 30 lock cores are available in a set (i.e., KSPEC 30).

Qty	Pattern #	Description	Unit List	Ext. List
5	KSPEC 2	Set of 2 cores/keys	N / C	N / C

Step 5 - Repeat for other groups.

Qty	Pattern #	Description	Unit List	Ext. List
5	KSPEC 2	Set of 2 cores/keys	N / C	N / C
3	KSPEC 4	Set of 4 cores/keys	N / C	N / C
2	KSPEC 5	Set of 5 cores/keys	N / C	N / C

Your Key instructions are complete.

Knoll will select key numbers for each set from 250 available numbers. Additional key numbers are available through Custom Product Development. **For additions to existing installations, specify desired key numbers in the description.**

Service Parts

Pattern #	Description	List Price
KKEY_ _ _	Shrouded Key Specify key number desired	\$5
KBLANK	Shrouded Key Blank	\$5
KSPECB_ _ _	Retrofit Universal Core/Key Specify key number desired	\$18
KCHANGE	Change Key	\$5
KMASTER*	Master Key	\$5

*Note: A letter of approval on company letterhead from the client must accompany all orders for master keys.

General Ordering Information

The Products

This guide encompasses all standard products for this product group.

Sizes

Dimensions listed in this guide are indicated as:

H = height

W = width

D = depth

Dia. = diameter

Rad. = radius

Pricing

All prices shown are list.

How to Order

Select pattern numbers and quantities required for your complete installation. Product questions can be addressed in the specific sections of this guide or by contacting your sales representative or customer resource representative at 1-800-343-5665.

Next, select options (if required), along with colors and finishes appropriate to each product. Reference the Finishes and Fabrics pages for color designations.

On large installations, an item's "designated area" can be specified to assist in product organization and handling.

To expedite complete / correct entry of your order, be certain all pattern numbers, quantities, colors and area identifications are completely specified. Also, include complete purchase order numbers, bill-to and ship-to addresses, a contact name and specific factory shipping dates required.

Mail all orders to:

Knoll, Inc.

1235 Water Street

P.O. Box 157

East Greenville, PA 18041

Attention: Order Entry

Once your order is entered at Knoll, an acknowledgment will be mailed to you. You will be advised of your scheduled shipping date within five days of the original acknowledgment. If it is necessary to revise your order, please contact your customer resource representative.

Sustainability Statement

Sustainable design is a key component of Knoll's environmental focus. Our commitment to social responsibility and a healthy environment has prompted us to further articulate our longstanding environmental programs and, with encouragement and support from our colleagues in the industry, we have re-energized our focus on such "green" initiatives as life cycle analysis and LEED™ certification. Knoll is proud to have contributed to projects that have received LEED certification from the U.S. Green Building Council.

For the latest information on Knoll products that help our customers achieve LEED certification, log on to knoll.com, click on "About Knoll" and then "Environmental Focus."