

AUTOSTRADA

Price List
March 2014

Knoll
Knoll
Knoll

EERO SAARINEN: FURNITURE FOR EVERYMAN



Knoll

Introduction	Knoll and Sustainable Design	4
	AutoStrada Basics	5
	AutoStrada Materials and Details	6
	AutoStrada Finishes	7
	AutoStrada Fabric Options	9
	AutoStrada Paint and Laminate Finishes Matrix	10
Applied Wall	Introduction	11
	Planning the applied wall system	12
	Specifying the applied wall system	13
	Applied wall frames	14
	Horizontal channels	15
	Wall trim and corners	20
	Wall covers	22
	Display shelves	36
	Glass shelves	37
	Bookshelves	38
	Open overhead cabinets	39
	Sliding door overhead cabinets with glass doors	40
	Sliding door overhead cabinets with laminate or veneer doors	41
	Hinged door overhead cabinets	42
	Overhead storage mounting kits	43
	Power and wire management	44
	Accessories	46
Spine and linkable screens	Service Wall frames	47
	Wall crown and base trim covers	48
	Structural base cover kits	51
	Access covers	53
	Spine ends and connectors	58
	End Starters	66
	Panel system starters and T-ends	70
	Power components, spine	78
	Add up glass panels, for spine	81
	Linkable screens and windows	82
	Gallery Screens	88
	Glass Gallery Screens	89
	Panels	Tiled/Monolithic - mono side only with base raceway
Mono/Mono - exterior hard side no raceway		96
Tiled/Monolithic - both sides with base raceway		100
Tiled one side/Slatwall combo other		106
Slatwall/Fabric combo both sides - both sides with base raceway		110
Frameless glass add-ups for panels		111
Glass Gallery Screens		113
Posts, panels		114
Trim, panels		126
Power distribution components for one side raceway panels		130
Power distribution components		131
AutoStrada Ported Panel Components		136

Medians	42" Medians with binder depth top shelf	138
	42" Medians with binder depth top shelf cont'd	139
	42" Medians with legal depth top shelf	140
	42" Medians with legal depth top shelf cont'd	141
	42" Medians with double end gable	142
	42" Medians with double end gable cont'd	143
	42" Median storage, binder depth	144
	42" Median storage, legal depth	145
	49" Medians with binder depth top shelf	146
	49" Medians with binder depth top shelf cont'd	147
	49" Medians with legal depth top shelf	148
	49" Medians with legal depth top shelf cont'd	149
	49" Medians with double end gable	150
	49" Medians with double end gable cont'd	151
	49" Median storage, binder depth	152
	49" Median storage, legal depth	153
	Bridges	42" Bridge units
49" Bridge units		155
Top shelves for bridges		156
Window kits for bridges		158
Cabinets	Storage Anchored Cabinets, w/BBF and FF configurations	159
	Storage Anchored Cabinets, with hinged door configurations	161
	Storage Anchored Cabinets, w/ Wardrobe and BBF	163
	Storage Anchored Cabinets, w/ Wardrobe and FF	164
	Storage Anchored Cabinets w/front and back access	165
	Storage Anchored Cabinets, front access	171
	Storage Anchored brackets	174
	Storage anchored cabinet trim	175
	Freestanding Cabinets for private office	176
	Freestanding Cabinets for open plan use with metal case pedestals	180
Lower Storage	Metal case	181
	Wood or laminate case	186
	Box shelf	195
Overhead Storage	Overhead storage, wood cases	196
	Reuter flat front overhead cabinet	215
	Reuter overhead cabinet mounting options	216
	Task Lights for Reuter Overhead Storage	217
	Task Lights	218
	Reuter T5 mounting kit	219
Worksurfaces	Credenza Top Glass Divider	221
	Flush, user edge tapered	222
	Cord drop, user edge tapered	225
	Rectilinear, user and approach edges tapered	228
	Rectilinear for C-Leg and T-Leg bases	230
	Wedge, user and approach edges tapered	231
	Peninsula, user and approach edges tapered	232
	Peninsulas	233
	Tables	239
	Table desks	241
	Transaction tops	243
	Transaction Top Brackets	244
	Support Components	Spine-based support
Linkable screen mounted worksurface support		246
Panel hung worksurface support		247
Worksurface support		248
Stiffeners		255
Accessories	Tackboard sections for medians and bridges	256
	Slatwall sections for medians and bridges	257
	Wall hung tackboards	258
	Worksurface stand-offs and cabinet feet	259

Crinion Open Table	Introduction	261
	Specifications	262
	Crinion Open Table Finishes	263
	Worksurfaces with center hinged power access	264
	Worksurfaces with edge grommet	265
	Worksurfaces with cord drop	266
	End counters	267
	Extended end counters	268
	File tops	270
	Complete base assemblies fixed height 24" D dual	271
	Complete base assemblies fixed height 24" D single sided	272
	Complete base assemblies fixed height 30" D dual	273
	Complete base assemblies fixed height 30" D single sided	274
	Complete base assemblies adjustable height 30" D dual	275
	Complete base assemblies adjustable height 30" D single sided	276
	Complete base assemblies fixed height 36" D dual	277
	Complete base assemblies fixed height 36" D single sided	278
	Complete base assemblies adjustable height 36" D dual	279
	Complete base assemblies adjustable height 36" D single sided	280
	Top channels	281
	Beams for single sided or dual tables	282
	Beams for dual tables	283
	Beams for single sided tables	284
	End legs, intermediate leg sets for dual tables	285
	End legs, intermediate leg sets for single sided tables	287
	End panels for dual tables and single sided tables, painted	288
	End panels for dual tables and single sided tables, laminate and veneer	289
	Beam trusses	290
	Worksurface support	291
	Modular Raceway	293
	Hardwire Raceway	299
	Cable tray and cable clips	300
	Beam mounted cable trays and cable baskets	301
	Center screens	302
	Shelves, adapters and buttresses for slatwall screens	304
	Side screens	305
	Return screens	307
	Dual end screens	309
	Single sided end screen	311
	Frameless glass Add up	313
	Morrison Network privacy screens	314
Wall Mounting of Knoll Products		315
Alpha-Numeric Index		317
Selling Policy		335
KnollKey Lock Program		337
General Ordering Information		338

Knoll and Sustainable Design

Each year Knoll sets key initiatives in our journey to sustainability. We are members of a global consortium on energy, have adopted a scientific, metrics-based approach to sustainable product design, and maintain a leadership position in establishing universal, verifiable, sustainability standards for our industry.

Knoll promotes independent third-party certification because it provides the most impartial and trustworthy foundation for industry-wide environmental compliance. Certification by established and respected third parties ensures that all manufacturers are held to the same high standards and that customers can trust a company's declaration about the environmental benefits of its products. Knoll third-party partners include: the International Standards Organization (ISO); Forest Stewardship Council (FSC®); Rainforest Alliance; GREENGUARD® Environmental Institute; and The Business and Institutional Furniture Manufacturer's Association (BIFMA) level® certification from Scientific Certification Systems (SCS).

In addition, Knoll is aligned with the U.S. Green Building Council and can help companies, healthcare organizations and educational institutions achieve Leadership in Energy and Environmental Design (LEED®) workplace certification.

Global Climate Change

- Knoll is a sponsor of the Clinton Global Initiative, which brings together a community of global leaders to devise and implement solutions to some of the world's most pressing challenges, including environmental change.
- Knoll has a comprehensive Energy Management Program to increase energy efficiency in products and processes.

Life Cycle Assessment (LCA) Tool

- Life Cycle Assessment is a science-based measurement of a product's environmental impacts throughout its life cycle, from raw materials sourcing through manufacture, shipping, use and re-use or end-of-life. LCA enables cradle-to-cradle implementation of sustainable practices.
- Knoll has partnered with The Green Standard.org to develop an affordable, universal ISO-compliant computer-based LCA tool that can be used by the entire contract furniture industry and is partnering on the development of an Environmental Product Declaration System (EPDs) for Knoll products. EPDs are verified documents containing LCA results and additional environmental performance information about a product.

Setting Industry Standards

- Knoll partners with MTS (The Institute for Market Transformation to Sustainability) to develop the SMaRT® Consensus Sustainable Products Standards, a set of consensus-based sustainable product standards based on the LEED® model, for all building products, fabric, apparel, flooring and carpet. MTS, the developer of SMaRT®, is an accredited American National Standards Institute (ANSI) standard developer.
- Knoll also partners with BIFMA (Business and Institutional Furniture Manufacturers Association) to promote level® sustainability standards for the contract furniture industry.
- Knoll has established FSC® (Forest Stewardship Council) certified wood as the standard for general office open plan office systems, casegoods and tables.
- Knoll has launched Full Circle, a resource recovery program developed with ANEW, to help customers extend the life cycle of surplus furniture, fixtures and equipment (FF&E) in an economically, socially and environmentally responsible manner.
- Our goal is to encourage all manufacturers in the contract furniture industry and related industries to adopt standards that will lead to sustainable products and practices.

For more information about Knoll and sustainable design, visit knoll.com/environment.

Introduction

With a commitment to innovation and modern aesthetics, Knoll sets the standard for the environment in which people work. AutoStrada is one of the most comprehensive office concepts to be developed by Knoll. Evolving workplace needs are met with innovative design, from private offices to collaborative spaces for team interaction.

AutoStrada addresses any office combination with a consistent aesthetic of high quality materials and carefully detailed design. Whether an office requires a high-performance open plan system, refined architectural case goods, progressive private office furniture, or a collaborative “big table” concept, AutoStrada provides a solution.

AutoStrada is a planning approach that combines furniture and interior architecture for both open plan and private offices spaces.

AutoStrada is a premium, one-source design.

AutoStrada is the definition of the most advanced technology management capabilities.

AutoStrada is modern. It is absolute design with a strong, basic design premise.

The Planning Models

Four AutoStrada planning models offer one set of continuous, intelligent, solutions-oriented capabilities.

Four ways AutoStrada redefines space:

- Spine-based planning
- Storage-anchored planning
- Collaborative table-based planning
- Architectural office planning

Any one environment could include solutions provided by any mix or all of the four planning models. Diverse planning models meet cross-cultural workplace environments everywhere.

AS1 AutoStrada spine based planning

AutoStrada spine based planning provides wall-like architectural order to office interiors and offers high performance technological support. The spine supports continuous off-module attachment of workspaces, storage components, KnollExtra accessories, and perpendicular linkable screens or panels to define workstations. The spine also manages and distributes power and communications throughout clusters of workstations, enabling convenient outlets at desk height and unobstructed access to cabling.

Spines can be built to any one foot increment of length and can be freestanding with outriggers to support cantilevered workspaces and overhead storage. Spines may also be integrated with attached panels or screens for support and enclosure. T-ends enable the spine to extend to absorb the dimensional gain of attached panels.

Spine covers include veneer, laminate, dry-erase marker, tackable fabric, integral shelves, slat wall and integral cable tray surfaces. Spines are available in three horizons--39”H, 48”H and 64”H--and may be fitted with frameless glass add ups for additional privacy above any of four crown profiles.

Linkable screens are available in tackable upholstered or glazed panels and windows, with a complete range of connectors that also support workspaces and storage.

AS2 AutoStrada storage anchored planning

AutoStrada storage anchored planning redefines the open office architecture with aesthetic and functional alternatives to conventional panel-based systems. Storage anchored planning begins with the anchor cabinet to which either AutoStrada panels or wood or laminate surrounds are attached to create individual or shared work areas. Storage anchored planning combines the performance of systems furniture with elegant details more like custom millwork.

AutoStrada panels feature a laminate or veneer tiled grid to the floor, with aluminum reveals between tiles on the exterior, and fabric or fabric and slat wall surfaces on the inside of the workstation. Interior base raceway distributes power and communications throughout a cluster with outlets only on the inside of the panels. AutoStrada panel heights enable seated access (42”H), seated privacy (49”H) or standing privacy (64”H). Frameless glass add ups can be added to panels for additional privacy. Connectors support workspaces, overhead storage or shelves and KnollExtra paper management and technology support tools.

AutoStrada surrounds, in veneer or laminate surface, are ideal for raised floor environments and a visual alternative to panels. Median surrounds or median storage form the backbone to which bridges and anchor cabinets are attached. Medians include a back panel, one or two end gables, a counter surface and a workspace or shelves. Bridges include a back panel and workspace. AutoStrada surrounds typically describe workstation boundaries at a 49” horizon.

AS3 AutoStrada wall based planning

AutoStrada wall based planning integrates freestanding and wall supported storage, desks and tables to build distinctive workspaces in private offices and walled collaborative areas.

AutoStrada Applied Walls add systems performance to built walls, enabling various surface materials and off module support for shelves, overheads and workspaces. Applied wall is either 69”H or 84”H, in any 6” increment of width. Horizontal channels contain interchangeable inserts like veneer, marker surface, fabric, glass, slat wall or recessed covers, and accept brackets for a variety of accessories at any point. Wall frames transfer most of the supported load directly to the floor.

AutoStrada overheads and tackboards can also be directly attached to most built walls. Freestanding AutoStrada cabinets for private offices are available in 70” and 84” horizons.

AS4 AutoStrada collaborative planning

AutoStrada collaborative planning is based on the Crinion Open Table, which creates open shared workspaces for groups from two to ten or more at a continuous workspace “bench”. Designed to support teams of people Crinion Open Table is ideal for trading rooms, libraries and conference rooms.

Crinion Open Table offers a unique alternative to traditional workstations, with continuous cantilevered workspaces, unobstructed kneespace, convenient, capable power and communications distribution, and optional desktop privacy screens. An extremely strong structure supports workspaces up to 36”d each side and virtually unlimited in length.

Crinion Open Table may be complemented with AutoStrada metal or wood storage, or Calibre files and cabinets as parallel file banks or as returns.

Materials

AutoStrada offers a range of exceptional materials and finishes, including premium grade hardwood veneers, Techwood, laminate, clear anodized aluminum, and architectural glass.

Veneers are all hand selected to best showcase the beauty of natural grain. Every effort is made to ensure that Knoll veneers are the best that can be sourced in quality of color, consistency and size. Natural variations of wood are not considered to be defects. The natural process of color change in real wood products is part of the beauty and unique character of the material. Knoll expects wood to patina over time.

Techwood is a genuine wood veneer which has been enhanced by technology to provide color and grain consistency.

High recycled content aluminum is used in the manufacture of aluminum components.

High-pressure laminate surface materials have been selected for their durability and low maintenance.

FSC (Forest Stewardship Council) certified materials are available by request.

Construction details

All AutoStrada worksurfaces are 1 1/4" thick and are a 3 ply solid construction. Worksurfaces are available in rectilinear and wedge shapes. The distinctive 3/8" tapered edge can be specified on just the user side or also on the approach side. Worksurfaces can be specified "full depth" with or without grommets, or with a 3/8" cord drop along the back with a centered edge grommet.

Worksurfaces appear to "float" 1" above lower storage components. Pedestals and legs can support a worksurface height of 28 1/4"H (typically in open plan) or 29 5/8" (in private offices). The higher worksurface height requires wood pedestals equipped with cabinet feet.

Pedestals and overhead storage are available in either metal or wood case. Wood pedestals have full extension file drawer slides with bottom-loadable steel floor and 3/4 extension slides all wood construction box drawers.

Wood or laminate case cabinets with hinged doors and adjustable shelves require doors to be removed to adjust shelving; alternatively a special request 170° hinge package is available to retrofit cabinets in the field.

Metal pedestals and Reuter overhead storage cabinets with flat front are durable steel construction with painted, laminate or veneer drawer fronts.

Metal pedestals feature full width protruding aluminum pull. Metal pedestals have all full extension personal, data and file drawer slides.

Wood cases incorporate 3 ply construction and components are finished on all sides. Core material is 45lb density particleboard. Wood drawers feature dovetail joinery details. File drawers have steel floor and are bottom loadable. Wood drawers feature full width anodized aluminum recessed or protruding pull. File drawers include file bars to support letter or legal suspended filing in either direction.

Freestanding private office cabinets are supported by cylindrical extruded aluminum feet which match an optional worksurface standoff detail.

Spine, linkable screens, panels, legs and metal storage offer 1" or greater levelling capacity. Wood storage has 1/2" levelling.

Cable management

AutoStrada incorporates discreet and concealed wire management as well as four or six circuit power distribution in all four planning models, supporting low to very high technology requirements. Storage anchored surrounds, designed for raised floor environments, are the only planning type that does not have power distribution capability.

Leg design

AutoStrada support legs are a refined shape in clear anodized aluminum finish. Legs feature either lockable casters or a unique glide sleeve that allows leveling without exposed glide threads. A pair of straight legs or one 9" wide leg can support one end of a worksurface when the other end is spine-supported, panel-supported or joined to a perpendicular worksurface with AT2TB brackets. If distance between support spans over 48", additional support is required.

Two pairs of straight legs may also be specified to create a freestanding table in combination with an AutoStrada worksurface not to exceed 72" x 30" with a corresponding stiffener.

Locks

All pedestals and cabinets with drawers are supplied with a ganglock mechanism in place. In addition, cabinets 30" wide and over with drawers have an interlock anti-tip feature to prevent the opening of a second drawer when one is already open. Drawer fronts and door fronts where applicable are routed to receive the lock itself. Keying instructions for key alike must accompany all orders and are field installed. Products are shipped from the factory with random locks or lock plugs for key-alike orders.

Representative Dimensions

All dimensions in this price list are nominal and for representative purposes only. For specific build dimensions please consult specification planning tools or contact your Customer Service representative.

Line drawings in this price list are strictly for quick product identification.

Wood Finishes

V1 Techwood

Natural Edge	Synthetic Edge	Finish
Y316	S316	Maple
Y319	S319	Cherry
Y323	S323	Medium Walnut
Y326	S326	Dark Mahogany
Y329	S329	Medium Oak
Y342	S342	Medium Teak *
Y344	S344	Espresso
Y811	S811	Natural
Y821	S821	Blond Maple
Y831	S831	Light Cherry
Y851	S851	Black Oak
Y881	S881	Light Walnut
Y882	S882	Dove Grey

V2 Natural Veneers / Premium Techwood

Natural Edge	Synthetic Edge	Finish
V312	R312	Bronze Cherry
V316	R316	Maple
V319	R319	Medium Cherry
V411	R411	Light Walnut
V412	R412	Natural Cherry
V413	R413	Sand Oak (Open pore)
V414	R414	Natural Oak
V415	R415	Peacock Green Walnut
V417	R417	Old English Walnut
V421	R421	Chalk Oak
V423	R423	Light Oak
V433	R433	Light Fawn Cherry
V436	R436	Medium Brown Cherry
V439	R439	Straight Anigre

V2 Natural Veneers / Premium Techwood (cont.)

Natural Edge	Synthetic Edge	Finish
V440	R440	Natural Hemlock (QC)
Y841	S841	Ebony (Open pore)*
Y861	S861	Grigio (Open pore)*

V3 Premium Veneer

Natural Edge	Synthetic Edge	Finish
V512	R512	Figured Anigre
V514	R514	Makore
V515	R515	Figured Sycamore
V517	R517	Natural Sapele
V518	R518	Natural Chestnut

***Note:** Finishes with * are NOT available on Reff Optional Edges and Waterfall Edges.

Note: All finishes shift in color over time, this natural aging process varies by material.

Laminates

Note: Matching edge band unless noted otherwise

Laminate	Edge Band
111	Jet Black
114	Folkstone Grey
115	Medium Grey
117	Soft Grey
118	Bright White
119	Pumice
121	Micro Grey with 114 Folkstone grey edge band
122	Brushed Sand with 119 Pumice edge band
123	Brushed Grey with 128 Fog edge band
128	Fog
129	Micro Sand with 119 Pumice edge band

Wood Grain Laminates

124	Medium Cherry *
125	Natural Maple *
126	Natural Cherry *
127	Walnut *

*Woodgrain Laminate. Not available on all components.

Important Note:

Wood grain direction depends on the width of the product.

For any vertical surface, ie; modesty panels, overheads and hutches, **up to 60"** wide, the grain direction will be **vertical**. For any vertical surface **greater than 60"** wide, the grain direction is **horizontal**.

up to 60" (vertical)

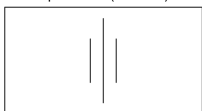

60" greater (horizontal)

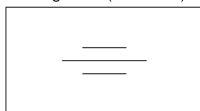

Mixed Finishes: (where applicable for work surfaces only)

Use 2 digit prefix to indicate surface finish

Laminate Surfaces	Surface
11	Jet Black
14	Folkstone Grey
15	Medium Grey
17	Soft Grey
18	Bright White
19	Pumice
21	Micro Grey
22	Brushed Sand
23	Brushed Grey
28	Fog
29	Micro Sand

Use 2 digit suffix to indicate wood edge finishes

V1 Edges

Y3	Y323
Y9	Y319
16	Y316
26	Y326
29	Y329
44	Y344
62	Y342
81	Y811
82	Y821
83	Y831
85	Y851

V2 Edges

12	V312
16	V316
39	V439
40	V440
43	V433
45	V415
46	V436
47	V417
61	V411
71	V421
73	V423
84	Y841
86	Y861

V3 Edges

52	V512
54	V514
55	V515
57	V517
58	V518

Note:

To order mixed finishes, enter four digit finish code as follows:

For example:

For a Micro Grey laminate surface with Bronzed Cherry edge. enter finish code: 2112

For a Jet Black laminate surface with Light Maple edge, enter finish code: 1116

Paint**P1**

- 111 Jet Black
- 112 Brown
- 113 Dark Grey
- 114 Folkstone Grey
- 115 Medium Grey
- 116 Sandstone
- 117 Soft Grey
- 118 Bright White

P2

- 611 Beige Mist Metallic
- 612 Medium Metallic Grey

P3

- 613 Silver

Anodized

- AA Anodized Aluminum

Plated

- PT Brushed Pewter

Glass G1

- TEMP Clear Tempered

Architectural Glass G2

- GL6 Block Matrix
- GL13 Powder

Forbo

- 851 Biscuit
- 852 Sky Blue
- 853 Stone
- 854 Cinnamon
- 855 Heather Blue

Fabric Options*Grade 10*

Annex (W1360) ●
 Broadcloth II (W1619)
 Element (W1077) ●
 Foundation (W351)
 Growth Spurt (W692)
 Skylark (W1718)
 Symbolic Detail (W693)
 Tailor made II (W1610)
 Versatility (W432)

Grade 20

Bauhaus Block (W296A)
 Circle Line (W1146)
 Clarity (W281)
 Criss Cross (W305)
 Logic (W1318)
 Neamtic II (W1620)
 Photon II (W1695)
 Reflect (W884) ø
 Resolution (W280)
 Weave Three (W298)

Grade 30

Basket Draft (W249)
 Flow (W565)
 Harmony (W232)
 Interknit (W1090)
 Match Point (W1145)
 Micro (W465) *
 Relay (W1020) ▲

Grade 40

Amplify (W1215) ●
 Bandwidth (W1219) ●
 Clarkson (W1218)
 Ornament (W1078)
 Palladium (W1030)

Grade 45

Monarch (K1149) - (not available on Linkable Screens)

Grade 50

Presto (K1000) ●
 Trophy (K1709) ●
 versa (K1698)

Grade 55

Ransom (K1298) ●
 Transition (W816)

**with backing only*

▲ Monolithic panels, linkable screens and tackboards only

● Linkable screens and add ups only

ø May not be available in all colors.

Customers Own Material

Prices for panels that are to be manufactured with a customer supplied fabric will follow Grade 10 panel pricing. Customer's Own Material is subject to an application testing fee of \$750 per fabric and a \$2500 fee for UL testing. Panels bearing COM fabrics are subject to extended leadtimes. It is the responsibility of the customer's purchasing agent to ensure COM fabric is supplied for testing and manufacturing. Delays in receiving COM fabric for manufacturing will result in rescheduled delivery dates.

	All standard Paint Finishes	AA or all paints except Silver	Laminate Horizontal Surfaces	Laminate Vertical Surfaces	Anodized Aluminum Only
AS1 Spine Based	standard crown covers	spine base trim covers	worksurfaces	structural base covers	
	structural base covers	slat wall covers	tables	access covers	
	outlet covers	integral shelves		fronts for metal pedestals	
	spine connectors	flat crown covers		fronts for Reuter overheads	
	metal pedestals and fronts	flat crown covers		box shelves	
	Reuter cases and fronts	straight legs			
		wide legs			
AS2 Storage Anchored	slat wall, panel	panel top trim	worksurfaces	all laminate pedestals	top trim wider than 96"
	panel raceway covers	panel reveals		anchor cabinets	
		storage reveals		medians	
		pulls		bridges	
				tiles, panels	
AS3 Applied Wall & private office components	wall covers	horizontal channels up to 96"	worksurfaces	wall covers	horizontal channels wider than 96"
	coat hook	slat wall covers	tables	freestanding storage	
	picture hook	recess covers	applied wall shelves	wall hung overheads	
	bookends	end trim			
		cable tray			
		marker tray			
		display shelf			
AS4 Crinion Open Table	end legs	hinged access	worksurfaces, tapered edge and post formed		beams
	intermediate legs	top channel up to 96"			top channel longer than 96"
	cantilevers	screen frames			

Finish code	Finish name	Paint grade	All standard Paint Finishes	AA or all paints except Silver	Laminate Horizontal Surfaces	Laminate Vertical Surfaces	Anodized Aluminum Only
611	Beige Mist Metallic	P2	•	•			
118	Bright White	P1	•	•	•	•	
112	Brown	P1	•	•			
123	Brushed Grey				▲		
122	Brushed Sand				▲		
113	Dark Grey	P1	•	•			
128	Fog				•	•	
114	Folkstone Grey	P1	•	•	•	•	
111	Jet Black	P1	•	•	•	•	
115	Medium Grey	P1	•	•			
612	Medium Metallic Grey	P2	•	•			
121	Micro Grey				▲		
129	Micro Sand				▲		
119	Pumice				•	•	
116	Sandstone	P1	•	•			
613	Silver	P3	•				
117	Soft Grey	P1	•	•	•	•	
812	Easy Grey*						
813	Trim Grey*						
AA	Anodized Aluminum			•			•
LW	Markerboard White **						

Notes:

▲ All laminates have matching edge bands except:
 123 Brushed Grey has 128 Fog edge
 122 Brushed Sand has 119 Pumice edge
 121 Micro Grey has 114 Folkstone grey edge
 129 Micro Sand has 119 Pumice edge

* Easy Grey and Trim grey integral colors only available for
 Compact crown covers
 Linkable screen trim
 Linkable screen top caps
 Spine end connector top caps

** Markerboard white is available only on AS1 spine access covers, AS3 Applied Wall covers and AS4 screens.

Introduction

AutoStrada Applied Wall System is designed for systems performance in built wall environments. Applied Wall enables a variety of interchangeable wall surface materials, continuous support for worksurfaces, shelves and overhead storage, power distribution and integrated wire management. Applied Wall System supports AutoStrada components in private offices and collaborative work spaces, while transmitting much of the weight load directly to the floor.

Applied Wall System includes:

- wall mount frames which stand on leveling glides and are secured to built walls
- horizontal channels that are attached to the frames
- covers that insert between the channels
- shelves and overhead storage components that can be engaged anywhere along the channels
- cable tray, worksurface support brackets and accessories

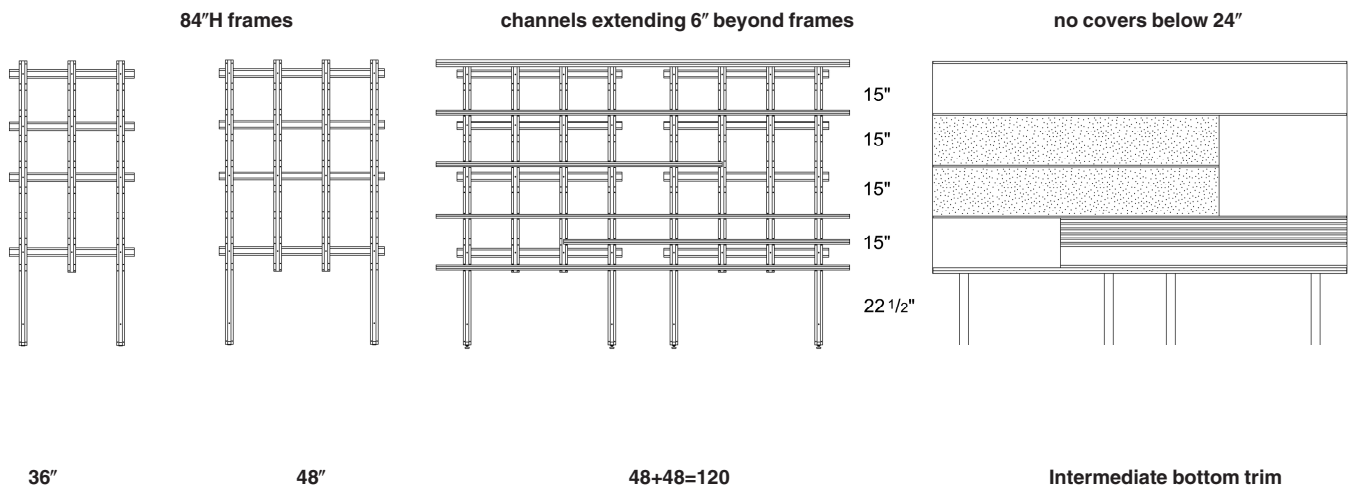
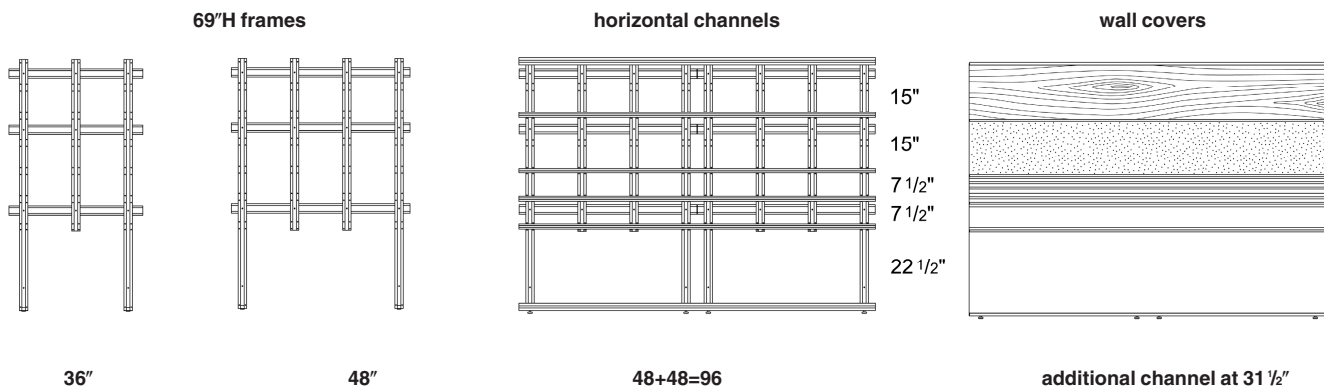

Frames

Wall mount frames are available in 69" and 84" horizons, 36" or 48" wide. Frames are steel weldments that include two or three horizontal rails through which frames are bolted to the vertical structure of the built wall. Adjacent frames can be leveled and shims enable each frame to be made plumb. At each side are vertical frame members with leveling glides. Between the side frame members are one or two intermediate studs that extend from approximately 24" above the floor to the top of the frame.

Channels

Channels are painted or natural anodized aluminum extrusions that hold covers and feature a continuous curved slot into which components and brackets are inserted. Channels are attached to the frames at each side member and stud with a bracket above and below. Channels do not need to align with frame widths and can extend up to 6" beyond the side of a frame.

Top channels, 36"-144" in width in 6" increments, attach only at the top of the frame and finish off the top of the assembly. Intermediate channels, 24"-144" in 6" increments of width, attach typically every 15" below the top channel, but may also be set at 7 1/2" or 22 1/2" increments to accommodate specific purpose covers such as slat wall or markerboards. Bottom channels, 36"-144" in 6" increments of width, attach only at the base of a wall frame to support covers below worksurface height (between 1 1/2" and 24" above the floor). If no covers are planned below 24" no bottom channel is required but intermediate bottom trim cover and vertical frame covers are recommended to enclose the structural frame.

Covers

Wall covers are designed to insert between channels and may be interchanged without removing channels. Covers are optional and not required behind overhead storage cabinets or below worksurface height, for example. The scope of wall covers includes:

- 7 1/2"H recess covers for surface-mounted plugmold and voice/data outlets, normally mounted just below worksurface height, with optional cable trays
- 7 1/2"H slat wall covers to support KnollExtra accessories
- 15" and 22 1/2"H tackable linoleum covers
- 7 1/2", 15", 22 1/2" and 30"H veneer, laminate, paint, fabric, tackable fabric covers
- 7 1/2", 15", 22 1/2", 30", 45" H marker.

All covers are available from 24"-96" in 6" increments of width except laminate and marker, 24"-72".

Components

- 5 1/2" deep display shelves in painted or clear anodized aluminum, 24"-72" wide in 6" increments
- 9" deep, 1/2" thick glass shelves and 12" deep plastic laminate or wood veneer bookshelves, 24"-72" wide, designed to align with the bottom of an adjacent cabinet,
- 9" deep glass and 12" deep plastic or veneer bookshelves to align with the top of an adjacent cabinet,
- open overhead storage units in plastic laminate or wood veneer, 18"-96" wide
- overhead storage units with solid or glass sliding doors, 42"-96" wide in 6" increments
- fully enclosed overhead storage units with hinged doors, 18"-96" wide,
- Reuter overhead storage, task lights and fascias for wood overhead storage,
- grommets for wall covers, surface mounted plugmold raceway and cable trays,
- support brackets for the back or end of a worksurface, and
- accessories such as coat hook, picture hook, marker tray, notepad, and horizontal/vertical wire manager clips.

Other cover sets

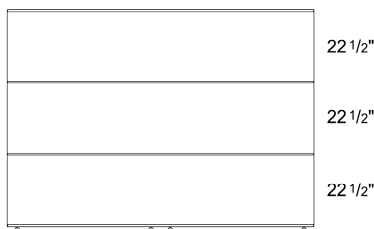

69" frames

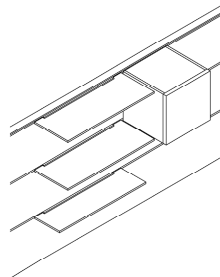

Upper shelf, lower shelf, glass shelf and overhead

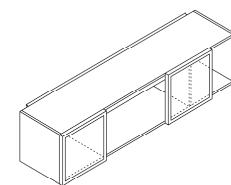

sliding doors

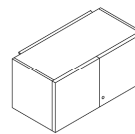

hinged doors

display wall with marker surface

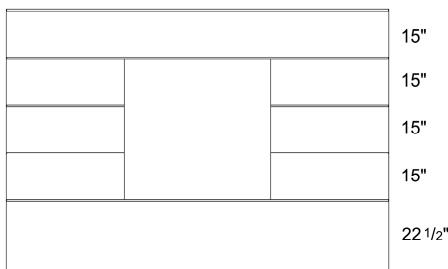

84" frames

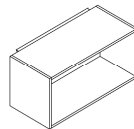

open overhead

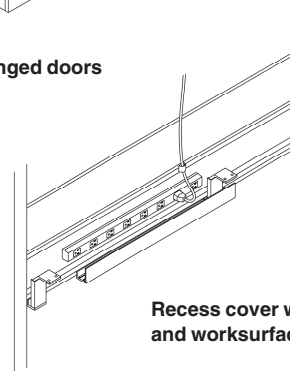

Recess cover with cable tray and worksurface brackets

How to specify Applied Wall

1. Plan frames to support the height and width of the intended overall wall system. Frames can be installed side-by-side or as much as 12" apart to provide adequate structure for horizontal channels up to 6" wider than the frame on each side. For example, a 10' length of channels and wall covers can be supported by three 36" wide frames or by two 48" wide frames.
2. Specify horizontal channels at each level required for covers and overhead storage or shelves. A top channel is always required and intermediate channels may be attached to the frame at any 7 1/2" increment above 24", 31 1/2", 39", 46 1/2", 54", 61 1/2", or 69" above the floor.
3. Typically intermediate channels are planned at 24", 39" and 54" to support 15"h covers. An additional channel at 31 1/2" will enable 7 1/2"h covers above and below worksurface height for slat wall and power/wire management. Horizontal channels can be planned the full width of the wall or may be segmented to allow taller covers such as a markerboard in specific locations. Alternatively intermediate channels may be planned at 24" and 46 1/2" on a 69"H frame to support all 22 1/2" H covers.
4. Specify bottom channel to support 22 1/2"H covers between floor and 24". Specify intermediate bottom trim and vertical frame covers if leaving the frame open below 24".
5. Specify end trim if end of wall is visible and specify corner connectors, if any.
6. Specify functional covers such as recess cover, the mounting location for surface mounted power distribution and voice/data outlets, and slat wall covers. Also specify tackable or marker surface covers. Then fill in the wall with decorative covers such as wood veneer, plastic laminate, non-tackable fabric, or backpainted glass. If planning a bookshelf the cover below the shelf cannot be glass. Covers are not required behind overhead storage cabinets.
7. Specify overhead storage: display shelves at 31 1/2" or 39", lower bookshelves at 54" and upper bookshelves at 69" to align with adjacent overhead storage cabinets. Specify open, partially open or fully enclosed overhead storage in veneer or laminate surface. Overhead storage cabinets usually hang from a channel at 69" and bear against a channel at 54" above the floor.
8. Specify power and cable trays. Power is distributed by a surface mounted plugmold raceway with ten simplex outlets, available in three configurations: one- circuit three-wire, two-circuit four wire, or two-circuit six wire. A 24" wide plugmold with eight simplex outlets is also available. Raceways are always hardwired to the building power supply by an electrical contractor. Contractor will punch a hole through the recess cover behind the plugmold to connect from the wall to the plugmold. Recess cover also accommodates voice/data outlets and cable grommets are available to line a punched hole.
9. Specify worksurface supports. Worksurface support brackets can be attached to the channel at 24" above the floor or may be attached within a cable tray at the same level.
10. Add accessories.

Customer's Responsibility:**Attachment of AutoStrada Applied Wall System to built walls**



It is the responsibility of the customer and their structural engineer/architect to verify that the permanent built wall (studs, blocks, solid masonry, or other) to which the Applied Wall System is intended to be attached is designed to support the load bearing standards set forth below. It is also the responsibility of the customer and their structural engineer/architect to specify the fasteners and method for attaching the frames to the built wall and confirm that the installers have followed these specifications. For local standards and additional requirements such as seismic the customer should consult local building and safety codes.

Design loads:

69"H Applied wall: 240#/foot of width. Assume four 60 lb. vertical loads spaced evenly between 24" and 69" above the floor, with the load centered 11" from the built wall.
 84"H Applied wall: 300#/foot of width. Assume five 60 lb. vertical loads spaced evenly between 24" and 84" above the floor, with the load centered 11" from the built wall.

Warning/Disclaimer

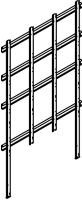
Knoll is not responsible for the attachment method of the Applied Wall System product, which is the responsibility of the customer and its structural engineer/architect. Knoll is not responsible for the cost of preparing an existing wall nor the additional cost for a new wall to make them appropriate for the installation of the Applied Wall System product. Failure to properly attach the Applied Wall System to a wall capable of supporting the loads listed above can lead to property damage and/or personal injury.

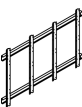
description	h	w	d	pattern number	black
69"H frames 	69"	36"	1 1/4"	AAWS F6936	\$545.
	69"	48"	1 1/4"	AAWS F6948	678.
84"H frames 	84"	36"	1 1/4"	AAWS F8436	612.
	84"	48"	1 1/4"	AAWS F8448	745.
22 1/2" add on frames 	22 1/2"	36"	1 1/4"	AAWS F2236	297.
	22 1/2"	48"	1 1/4"	AAWS F2248	345.
30" add on frames 	30"	36"	1 1/4"	AAWS F3036	326.
	30"	48"	1 1/4"	AAWS F3048	363.

Order Code

Example:	AAWS F6936
A	AutoStrada
AWS	Applied wall system
F	Wall frame
69	Height
36	Width

Specification Information

Applied wall frames are painted black

Application Notes

Wall frames attach to built walls to provide level, vertical structure for complete applied wall system assemblies. Wall frames include two leveling glides, studs on 14" centers, and horizontal beams.

Knoll does not supply or recommend specific hardware to fasten frame to built wall.

Add on frames add 22 1/2" or 30" of height to 69" or 84" frames (or other add on frames). Add on frames include stacking hardware.

Horizontal channels

Top channels

description	h	w	d	pattern number	painting	aluminum
Top channel 	1"	36"	1"	AAWS TC 036 ()	\$74.	\$74.
	1"	42"	1"	AAWS TC 042 ()	85.	85.
	1"	48"	1"	AAWS TC 048 ()	98.	98.
	1"	54"	1"	AAWS TC 054 ()	119.	119.
	1"	60"	1"	AAWS TC 060 ()	124.	124.
	1"	66"	1"	AAWS TC 066 ()	131.	131.
	1"	72"	1"	AAWS TC 072 ()	136.	136.
	1"	78"	1"	AAWS TC 078 ()	149.	149.
	1"	84"	1"	AAWS TC 084 ()	161.	161.
	1"	90"	1"	AAWS TC 090 ()	174.	174.
	1"	96"	1"	AAWS TC 096 ()	180.	180.
	1"	102"	1"	AAWS TC 102 ()	n/a	185.
	1"	108"	1"	AAWS TC 108 ()	n/a	198.
	1"	114"	1"	AAWS TC 114 ()	n/a	206.
	1"	120"	1"	AAWS TC 120 ()	n/a	211.
	1"	126"	1"	AAWS TC 126 ()	n/a	216.
	1"	132"	1"	AAWS TC 132 ()	n/a	235.
	1"	138"	1"	AAWS TC 138 ()	n/a	241.
	1"	144"	1"	AAWS TC 144 ()	n/a	246.

Order Code

Example:	AAWS TC 036 AA
A	AutoStrada
AWS	Applied wall system
TC	Top channel
036	Width
AA	Finish

Specification Information

AA- Anodized Aluminum.
 All standard painted finishes except 613 Silver also available for channels up to 96" wide.

Application Notes

Top channel attaches only at the top of wall frames to provide continuous slot for component support and retention for top of wall covers. Top channel encloses top of frames to within 1/4" of the built wall for cord passage.
 Specify top channel in length to match overall length of applied wall covers, or in shorter segments. Top channel can extend past wall frame up to 6" on each end.

Horizontal channels

Top Up channels

description	h	w	d	pattern number	painting	aluminum
Top Up channel	1"	36"	1"	AAWS TU 036 ()	\$179.	\$179.
	1"	42"	1"	AAWS TU 042 ()	209.	209.
	1"	48"	1"	AAWS TU 048 ()	237.	237.
	1"	54"	1"	AAWS TU 054 ()	285.	285.
	1"	60"	1"	AAWS TU 060 ()	297.	297.
	1"	66"	1"	AAWS TU 066 ()	309.	309.
	1"	72"	1"	AAWS TU 072 ()	320.	320.
	1"	78"	1"	AAWS TU 078 ()	331.	331.
	1"	84"	1"	AAWS TU 084 ()	536.	536.
	1"	90"	1"	AAWS TU 090 ()	536.	536.
	1"	96"	1"	AAWS TU 096 ()	536.	536.
	1"	102"	1"	AAWS TU 102 ()	n/a	563.
	1"	108"	1"	AAWS TU 108 ()	n/a	563.
	1"	114"	1"	AAWS TU 114 ()	n/a	563.
	1"	120"	1"	AAWS TU 120 ()	n/a	563.
	1"	126"	1"	AAWS TU 126 ()	n/a	578.
	1"	132"	1"	AAWS TU 132 ()	n/a	578.
	1"	138"	1"	AAWS TU 138 ()	n/a	578.
	1"	144"	1"	AAWS TU 144 ()	n/a	578.

Order Code	Specification Information	Application Notes
Example: AAWS TU 073 AA	AA- Anodized Aluminum.	Top Up channels are an alternative to top channels at the top of wall frames or add on frames.
A AutoStrada	All standard painted finishes except Silver also available for channels up to 96" wide.	Top Up channel enables covers to be mounted above the applied wall. Specify ceiling channel separately to retain top of covers mounted above frames.
AWS Applied wall system		Top Up channel provides continuous slot for component support, retains top of covers on frame and bottom of covers mounted above frame.
TU Top Up channel		Top Up channel encloses top of frames to within 1/4" of the built wall for cord passage. Specify Top Up channel in length to match overall length of applied wall covers, or in shorter segments. Top Up channel can extend past wall frame up to 6" on each end.
072 Width		
AA Finish		

Horizontal channels

Ceiling channels

description	h	w	d	pattern number	painted	aluminum
Ceiling channel	1"	36"	1"	AAWS CC 036 ()	\$149.	\$149.
	1"	42"	1"	AAWS CC 042 ()	167.	167.
	1"	48"	1"	AAWS CC 048 ()	184.	184.
	1"	54"	1"	AAWS CC 054 ()	202.	202.
	1"	60"	1"	AAWS CC 060 ()	220.	220.
	1"	66"	1"	AAWS CC 066 ()	237.	237.
	1"	72"	1"	AAWS CC 072 ()	255.	255.
	1"	78"	1"	AAWS CC 078 ()	285.	285.
	1"	84"	1"	AAWS CC 084 ()	416.	416.
	1"	90"	1"	AAWS CC 090 ()	416.	416.
	1"	96"	1"	AAWS CC 096 ()	416.	416.
	1"	102"	1"	AAWS CC 102 ()	n/a	440.
	1"	108"	1"	AAWS CC 108 ()	n/a	440.
	1"	114"	1"	AAWS CC 114 ()	n/a	440.
	1"	120"	1"	AAWS CC 120 ()	n/a	440.
	1"	126"	1"	AAWS CC 126 ()	n/a	464.
	1"	132"	1"	AAWS CC 132 ()	n/a	464.
	1"	138"	1"	AAWS CC 138 ()	n/a	464.
	1"	144"	1"	AAWS CC 144 ()	n/a	464.

Order Code

Example:	AAWS CC 036 AA
A	AutoStrada
AWS	Applied wall system
CC	Ceiling channel
036	Width
AA	Finish

Specification Information

AA- Anodized Aluminum.
 All standard painted finishes except Silver also available for channels up to 96" wide.

Application Notes

Ceiling channels are fastened directly to the building wall to retain the top of covers up to 30"H mounted above wall frames with Top Up channel.
 Ceiling channels do not accept brackets for applied wall storage, shelves or accessories.
 Specify ceiling channels in lengths to match overall width of covers mounted above frames or in shorter segments.

Knoll does not supply or recommend specific hardware for fastening ceiling channel to building wall.

Horizontal channels
Intermediate channels

description	h	w	d	pattern number	painting	aluminum
Intermediate channel 	1"	24"	1"	AAWS IC 024 ()	\$62.	\$62.
	1"	30"	1"	AAWS IC 030 ()	69.	69.
	1"	36"	1"	AAWS IC 036 ()	74.	74.
	1"	42"	1"	AAWS IC 042 ()	85.	85.
	1"	48"	1"	AAWS IC 048 ()	92.	92.
	1"	54"	1"	AAWS IC 054 ()	110.	110.
	1"	60"	1"	AAWS IC 060 ()	119.	119.
	1"	66"	1"	AAWS IC 066 ()	124.	124.
	1"	72"	1"	AAWS IC 072 ()	131.	131.
	1"	78"	1"	AAWS IC 078 ()	144.	144.
	1"	84"	1"	AAWS IC 084 ()	167.	167.
	1"	90"	1"	AAWS IC 090 ()	174.	174.
	1"	96"	1"	AAWS IC 096 ()	180.	180.
	1"	102"	1"	AAWS IC 102 ()	n/a	185.
	1"	108"	1"	AAWS IC 108 ()	n/a	190.
	1"	114"	1"	AAWS IC 114 ()	n/a	198.
	1"	120"	1"	AAWS IC 120 ()	n/a	211.
	1"	126"	1"	AAWS IC 126 ()	n/a	223.
	1"	132"	1"	AAWS IC 132 ()	n/a	235.
	1"	138"	1"	AAWS IC 138 ()	n/a	241.
1"	144"	1"	AAWS IC 144 ()	n/a	246.	

Order Code

Example: AAWS IC 024 AA
A AutoStrada
AWS Applied wall system
IC Intermediate channel
024 Width
AA Finish

Specification Information

AA- Anodized Aluminum or any painted finish except 613 silver. Painted finish is not available on channels wider than 96".

Application Notes

Intermediate channels attach to wall frames to provide continuous slot for component support and retention for top and bottom of wall covers. Horizontal channels attach to wall frames at predetermined mounting locations depending on what height covers and overhead storage are planned on wall surface: 24", 31 1/2", 39", 46 1/2", 54", 61 1/2", 69" above the floor.

Specify channels in length to match overall length of applied wall covers, or in shorter segments. Intermediate channels can extend past wall frame up to 6" on each end. Channels include mounting hardware to attach to wall frame studs.

Horizontal channels

Bottom channels

description	h	w	d	pattern number	painting	aluminum
Bottom channel	1"	36"	1"	AAWS BC 036 ()	\$62.	\$62.
	1"	42"	1"	AAWS BC 042 ()	69.	69.
	1"	48"	1"	AAWS BC 048 ()	74.	74.
	1"	54"	1"	AAWS BC 054 ()	85.	85.
	1"	60"	1"	AAWS BC 060 ()	92.	92.
	1"	66"	1"	AAWS BC 066 ()	98.	98.
	1"	72"	1"	AAWS BC 072 ()	104.	104.
	1"	78"	1"	AAWS BC 078 ()	110.	110.
	1"	84"	1"	AAWS BC 084 ()	124.	124.
	1"	90"	1"	AAWS BC 090 ()	131.	131.
	1"	96"	1"	AAWS BC 096 ()	136.	136.
	1"	102"	1"	AAWS BC 102 ()	n/a	144.
	1"	108"	1"	AAWS BC 108 ()	n/a	149.
	1"	114"	1"	AAWS BC 114 ()	n/a	154.
	1"	120"	1"	AAWS BC 120 ()	n/a	161.
	1"	126"	1"	AAWS BC 126 ()	n/a	167.
	1"	132"	1"	AAWS BC 132 ()	n/a	174.
	1"	138"	1"	AAWS BC 138 ()	n/a	180.
	1"	138"	1"	AAWS BC 144 ()	n/a	185.

Order Code

Example:	AAWS BC 036 AA
A	AutoStrada
AWS	Applied wall system
BC	Bottom channel
036	Width
AA	Finish

Specification Information

AA - Anodized Aluminum or any painted finish except 613 Silver.

Painted finish is not available on channels wider than 96".

Application Notes

Bottom channels attach to bottom of wall frames to retain bottom of wall covers planned below 24". Specify channels in length to match overall length of applied wall covers, or in shorter segments. Bottom channels can extend past wall frame up to 6" on each end.

Includes hardware.

Bottom channel is not required if no covers are planned below intermediate channel mounted at 24" above floor. Specify intermediate bottom trim and vertical frame covers to cover exposed studs at bottom of each wall frame.

Wall trim and corners

End trims, intermediate trim

AutoStrada

description	type	h	w	d	pattern no.	painting or easy grey	painting or aluminum
	69"H frame	69"	1/8"	2 1/4"	AAWS ET 69 ()		\$110.
	84"H frame	84"	1/8"	2 1/4"	AAWS ET 84 ()		149.
	69"H + 22" add on	91 1/2"	1/8"	2 1/4"	AAWS ET 91 ()		173.
	69"H + 30" add on	99"	1/8"	2 1/4"	AAWS ET 99 ()		184.
	84"H + 22" add on	106 1/2"	1/8"	2 1/4"	AAWS ET 106 ()		209.
	84"H + 30" add on	114"	1/8"	2 1/4"	AAWS ET 114 ()		220.
	Field Modifiable	144"	1/8"	2 1/4"	AAWS ET 144 ()		255.
Wall end trim for frames open below 24"	69"H frame, open base	69"	1/8"	2 1/4"	AAWS ETO 69 ()		85.
	84"H frame, open base	84"	1/8"	2 1/4"	AAWS ETO 84 ()		104.
Intermediate trim cover		1 1/8"	144"	3/4"	AAWS IBT ()		108.
Vertical frame covers (pair)		21"	2 1/2"	2"	AAWS VFC ()		48.

Order Code	Specification Information	Application
Example: AAWS ET 69 AA		
A AutoStrada	Intermediate bottom trim and Vertical frame covers are available in Easy Grey (812) or any standard painted finish except 613 Silver.	Wall end trim encloses exposed end of applied wall frame and add on frames. If no wall covers are planned below 24" datum specify corresponding wall end trims for open base: 48"h for 69" h frames or 63"h for 84" h frames.
AWS Applied wall system		
ET End trim	All end trim inside and outside covers are available in AA anodized aluminum or any standard paint finish except 613 Silver.	
69 Width		
AA Finish	All standard painted finishes except silver are also available for all end trims up to 91"H.	If no covers are planned below 24" datum specify optional intermediate bottom trim, which may be cut on site to overall width of applied wall, and one pair of vertical frame covers to cover exposed studs of each wall frame.

Wall trim and corners

Inside and outside corners

description	type	h	w	d	pattern no.	list	aluminum
Inside corner	69"H frame	69"	2 1/4"	2 1/4"	AAWSIL69 ()		\$149.
	84"H frame	84"	2 1/4"	2 1/4"	AAWSIL84 ()		190.
	69"H + 22 1/2" add on	91 1/2"	2 1/4"	2 1/4"	AAWSIL91 ()		261.
	69"H + 30" add on	99"	2 1/4"	2 1/4"	AAWSIL99 ()		261.
	84"H + 22 1/2" add on	106 1/2"	2 1/4"	2 1/4"	AAWSIL106 ()		261.
	84"H + 30" add on	114"	2 1/4"	2 1/4"	AAWSIL114 ()		261.
	Field Modifiable	144"	2 1/4"	2 1/4"	AAWSIL144 ()		261.
Inside corner for frames open below 24"	69"H frame, open base	48"	2 1/4"	2 1/4"	AAWSILO69 ()		119.
	84"H frame, open base	63"	2 1/4"	2 1/4"	AAWSILO84 ()		144.



Outside corner	69"H frame	69"	2 1/4"	2 1/4"	AAWSOL69 ()		235.
	84"H frame	84"	2 1/4"	2 1/4"	AAWSOL84 ()		297.
	69"H + 22 1/2"H add on	91 1/2"	2 1/4"	2 1/4"	AAWSOL91 ()		445.
	69"H + 30"H add on	99"	2 1/4"	2 1/4"	AAWSOL99 ()		445.
	84"H + 22 1/2"H add on	106 1/2"	2 1/4"	2 1/4"	AAWSOL106 ()		445.
	84"H + 30"H add on	114"	2 1/4"	2 1/4"	AAWSOL114 ()		445.
	Field modifiable	144"	2 1/4"	2 1/4"	AAWSOL144 ()		445.
Outside corner for frames open below 24"	69"H frame, open base	48"	2 1/4"	2 1/4"	AAWSOLO69 ()		174.
	84"H frame, open base	63"	2 1/4"	2 1/4"	AAWSOLO84 ()		216.



Order Code

Example: AAWS IL 69 AA	
A	AutoStrada
AWS	Applied wall system
IL	Inside corner
69	Width
AA	Finish

Specification Information

AA - Anodized Aluminum.
All standard painted finishes except silver are also available for all end trims up to 91"H.

Application Notes

Inside corners and outside corners align and enclose the 90° junction of two wall frames or wall frames plus add on frames.

Frames must match in height.

Inside and outside corners require 2 1/4" square planning footprint.

Wall covers

Recess surface

description	h	w	d	pattern no.	easy grey	or painted	aluminum	or painted
Recess cover 	7 1/2"	24"	3/4"	AAWS C0724 R ()				\$85.
	7 1/2"	30"	3/4"	AAWS C0730 R ()				98.
	7 1/2"	36"	3/4"	AAWS C0736 R ()				110.
	7 1/2"	42"	3/4"	AAWS C0742 R ()				124.
	7 1/2"	48"	3/4"	AAWS C0748 R ()				134.
	7 1/2"	54"	3/4"	AAWS C0754 R ()				155.
	7 1/2"	60"	3/4"	AAWS C0760 R ()				167.
	7 1/2"	66"	3/4"	AAWS C0766 R ()				179.
	7 1/2"	72"	3/4"	AAWS C0772 R ()				188.
	7 1/2"	78"	3/4"	AAWS C0778 R ()				200.
	7 1/2"	84"	3/4"	AAWS C0784 R ()				212.
	7 1/2"	90"	3/4"	AAWS C0790 R ()				234.
	7 1/2"	96"	3/4"	AAWS C0796 R ()				244.
Recess end trim (pair)	6 1/2"	1/2"	3/4"	AAWS RET ()				33.



Order Code	Specification Information	Application
Example: AAWS C0724 R AA	Recess covers are available in AA anodized aluminum or any standard painted finish except 613 Silver.	Recess covers provide mounting location for continuous, surface-mounted plugmold strip or voice/data outlets. Recess covers are typically mounted below or just above desk height (24"-35 1/2" above floor).
A AutoStrada	Recess end trim is 812 Easy Grey or any standard painted finish except 613 Silver.	Recess covers insert between intermediate channels and are secured in position with screws.
AWS Applied wall system		Recess covers are extruded, clear anodized aluminum surface.
C Cover		Recess cover should be at least 6" wider than 60" plugmold or 24" plugstrip to be mounted.
07 Height		Recess end trim encloses the ends of a recess cover where it meets any other cover type.
24 Width		Recess end trim kit includes one left hand and one right hand trim.
R Recess cover		Recess end trim is not required where recess cover meets wall end trim, corner connector or another recess cover.
AA Finish		

Wall covers

Slatwall surface

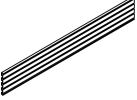
description	h	w	d	pattern no.	painting or aluminum
Slatwall cover 	7 1/2"	24"	1/2"	AAWS C0724 S ()	\$98.
	7 1/2"	30"	1/2"	AAWS C0730 S ()	110.
	7 1/2"	36"	1/2"	AAWS C0736 S ()	124.
	7 1/2"	42"	1/2"	AAWS C0742 S ()	136.
	7 1/2"	48"	1/2"	AAWS C0748 S ()	149.
	7 1/2"	54"	1/2"	AAWS C0754 S ()	174.
	7 1/2"	60"	1/2"	AAWS C0760 S ()	185.
	7 1/2"	66"	1/2"	AAWS C0766 S ()	198.
	7 1/2"	72"	1/2"	AAWS C0772 S ()	211.
	7 1/2"	78"	1/2"	AAWS C0778 S ()	223.
	7 1/2"	84"	1/2"	AAWS C0784 S ()	235.
	7 1/2"	90"	1/2"	AAWS C0790 S ()	259.
	7 1/2"	96"	1/2"	AAWS C0796 S ()	272.

Order Code

Example:	AAWS C0724 S AA
A	AutoStrada
AWS	Applied wall system
C	Cover
07	Height
24	Width
S	Slatwall cover
AA	Finish

Specification Information

AA - Anodized Aluminum only.
 Slatwall covers are available in AA anodized aluminum or any standard painted finish except 613 Silver.



Application

Slatwall covers provide four continuous, horizontal slots to accept a variety of KnollExtra paper management accessories and flat screen monitor arms. Slatwall covers are typically installed just above desk height (31 1/2 - 39" above floor).
 Slatwall covers insert between intermediate channels and are secured in position with screws. Slatwall covers are extruded, clear anodized aluminum surface.

Slatwall covers will support flat panel monitor arms with varying weight limitations based on mounting and application. Please refer to the KnollExtra price list for comprehensive mounting and weight limitation information by application.

Wall covers

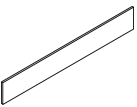
Marker surface

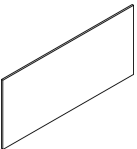
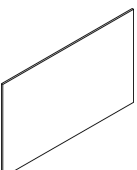
description	h	w	d	pattern no.	list
Marker cover, 7 1/2"H 	7 1/2"	24"	1/2"	AAWS C0724 M ()	\$74.
	7 1/2"	30"	1/2"	AAWS C0730 M ()	81.
	7 1/2"	36"	1/2"	AAWS C0736 M ()	86.
	7 1/2"	42"	1/2"	AAWS C0742 M ()	94.
	7 1/2"	48"	1/2"	AAWS C0748 M ()	98.
	7 1/2"	54"	1/2"	AAWS C0754 M ()	103.
	7 1/2"	60"	1/2"	AAWS C0760 M ()	108.
	7 1/2"	66"	1/2"	AAWS C0766 M ()	114.
	7 1/2"	72"	1/2"	AAWS C0772 M ()	121.
Marker cover, 15"H 	15"	24"	1/2"	AAWS C1524 M ()	97.
	15"	30"	1/2"	AAWS C1530 M ()	107.
	15"	36"	1/2"	AAWS C1536 M ()	119.
	15"	42"	1/2"	AAWS C1542 M ()	128.
	15"	48"	1/2"	AAWS C1548 M ()	141.
	15"	54"	1/2"	AAWS C1554 M ()	153.
	15"	60"	1/2"	AAWS C1560 M ()	163.
	15"	66"	1/2"	AAWS C1566 M ()	174.
	15"	72"	1/2"	AAWS C1572 M ()	182.
Marker cover, 22 1/2"H 	22 1/2"	24"	1/2"	AAWS C2224 M ()	121.
	22 1/2"	30"	1/2"	AAWS C2230 M ()	135.
	22 1/2"	36"	1/2"	AAWS C2236 M ()	157.
	22 1/2"	42"	1/2"	AAWS C2242 M ()	173.
	22 1/2"	48"	1/2"	AAWS C2248 M ()	186.
	22 1/2"	54"	1/2"	AAWS C2254 M ()	201.
	22 1/2"	60"	1/2"	AAWS C2260 M ()	234.
	22 1/2"	66"	1/2"	AAWS C2266 M ()	240.
	22 1/2"	72"	1/2"	AAWS C2272 M ()	244.
Marker cover, 30"H 	30"	24"	1/2"	AAWS C3024 M ()	141.
	30"	30"	1/2"	AAWS C3030 M ()	163.
	30"	36"	1/2"	AAWS C3036 M ()	186.
	30"	42"	1/2"	AAWS C3042 M ()	207.
	30"	48"	1/2"	AAWS C3048 M ()	226.
	30"	54"	1/2"	AAWS C3054 M ()	249.
	30"	60"	1/2"	AAWS C3060 M ()	270.
	30"	66"	1/2"	AAWS C3066 M ()	288.
	30"	72"	1/2"	AAWS C3072 M ()	308.

Order Code	
Example: AAWS C0724 M LW	
A	AutoStrada
AWS	Applied wall system
C	Cover
07	Height
24	Width
M	Marker cover
LW	Finish

Specification Information
LW - Markerboard surface

Application
Markerboard cover is a white, dry-erase surface that fits flush with adjacent wall covers. Marker covers insert between channels set at the corresponding height differences.

Wall covers

Marker surface

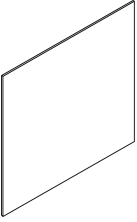
description	h	w	d	pattern no.	list
Marker cover, 45"H 	45"	24"	1/2"	AAWS C4524 M ()	\$187.
	45"	30"	1/2"	AAWS C4530 M ()	215.
	45"	36"	1/2"	AAWS C4536 M ()	261.
	45"	42"	1/2"	AAWS C4542 M ()	289.
	45"	48"	1/2"	AAWS C4548 M ()	318.
	45"	54"	1/2"	AAWS C4554 M ()	350.
	45"	60"	1/2"	AAWS C4560 M ()	375.
	45"	66"	1/2"	AAWS C4566 M ()	405.
	45"	72"	1/2"	AAWS C4572 M ()	435.

Order Code

Example:	AAWS C0724 M LW
A	AutoStrada
AWS	Applied wall system
C	Cover
07	Height
24	Width
M	Marker cover
LW	Finish

Specification Information

LW - Markerboard surface

Application

Markerboard cover is a white, dry-erase surface that fits flush with adjacent wall covers. Marker covers insert between channels set at the corresponding height differences.

Wall covers

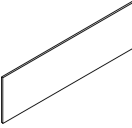
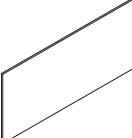

Tackable linoleum

description	h	w	d	pattern no.	list
Linoleum cover, 15"H 	15"	24"	1/2"	AAWS C1524 L ()	\$157.
	15"	30"	1/2"	AAWS C1530 L ()	187.
	15"	36"	1/2"	AAWS C1536 L ()	225.
	15"	42"	1/2"	AAWS C1542 L ()	254.
	15"	48"	1/2"	AAWS C1548 L ()	290.
	15"	54"	1/2"	AAWS C1554 L ()	326.
	15"	60"	1/2"	AAWS C1560 L ()	364.
	15"	66"	1/2"	AAWS C1566 L ()	395.
	15"	72"	1/2"	AAWS C1572 L ()	431.
	15"	78"	1/2"	AAWS C1578 L ()	467.
	15"	84"	1/2"	AAWS C1584 L ()	503.
	15"	90"	1/2"	AAWS C1590 L ()	532.
15"	96"	1/2"	AAWS C1596 L ()	569.	
Linoleum cover, 22 1/2"H 	22 1/2"	24"	1/2"	AAWS C2224 L ()	219.
	22 1/2"	30"	1/2"	AAWS C2230 L ()	265.
	22 1/2"	36"	1/2"	AAWS C2236 L ()	315.
	22 1/2"	42"	1/2"	AAWS C2242 L ()	364.
	22 1/2"	48"	1/2"	AAWS C2248 L ()	418.
	22 1/2"	54"	1/2"	AAWS C2254 L ()	472.
	22 1/2"	60"	1/2"	AAWS C2260 L ()	527.
	22 1/2"	66"	1/2"	AAWS C2266 L ()	569.
	22 1/2"	72"	1/2"	AAWS C2272 L ()	624.
	22 1/2"	78"	1/2"	AAWS C2278 L ()	673.
	22 1/2"	84"	1/2"	AAWS C2284 L ()	726.
	22 1/2"	90"	1/2"	AAWS C2290 L ()	776.
22 1/2"	96"	1/2"	AAWS C2296 L ()	836.	

Order Code	Specification Information	Application
Example: AAWS C0724 L 851	851 Forbo #2186	Linoleum covers insert between horizontal channels to provide tackable, non-upholstered surface. Linoleum covers are tackable with 1/2" pushpins. Linoleum surface is firm enough to permit open shelf brackets to bear against face of cover.
A AutoStrada	852 Forbo #2162	
AWS Applied wall system	853 Forbo #2182	
C Cover	854 Forbo #2166	
07 Height	855 Forbo #2204	
24 Width	856 Forbo #2202	
L Tackable linoleum		
851 Finish		

Wall covers

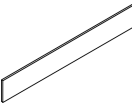
Tackable upholstered

description	h	w	d	pattern no.	Grade								
					10	15	20	30	35	40	45	50	55
Tackable upholstered cover, 7 1/2"H 	7 1/2"	24"	1/2"	AAWS C0724 A ()	\$83.	\$85.	\$87.	\$95.	\$97.	\$100.	\$102.	\$108.	\$116.
	7 1/2"	30"	1/2"	AAWS C0730 A ()	90.	94.	96.	101.	103.	105.	107.	116.	122.
	7 1/2"	36"	1/2"	AAWS C0736 A ()	97.	100.	102.	106.	108.	110.	114.	122.	128.
	7 1/2"	42"	1/2"	AAWS C0742 A ()	110.	114.	116.	118.	120.	123.	124.	128.	134.
	7 1/2"	48"	1/2"	AAWS C0748 A ()	126.	128.	130.	131.	133.	135.	137.	140.	145.
	7 1/2"	54"	1/2"	AAWS C0754 A ()	138.	140.	142.	144.	145.	148.	149.	153.	157.
	7 1/2"	60"	1/2"	AAWS C0760 A ()	152.	153.	154.	156.	157.	162.	163.	167.	172.
	7 1/2"	66"	1/2"	AAWS C0766 A ()	164.	167.	168.	170.	172.	174.	176.	179.	183.
	7 1/2"	72"	1/2"	AAWS C0772 A ()	177.	179.	181.	182.	183.	186.	187.	190.	196.
Tackable upholstered cover, 15"H 	15"	24"	1/2"	AAWS C1524 A ()	127.	128.	130.	131.	133.	135.	137.	138.	147.
	15"	30"	1/2"	AAWS C1530 A ()	150.	152.	153.	154.	156.	159.	162.	163.	172.
	15"	36"	1/2"	AAWS C1536 A ()	175.	176.	177.	179.	181.	183.	185.	186.	194.
	15"	42"	1/2"	AAWS C1542 A ()	199.	200.	201.	204.	206.	209.	210.	211.	220.
	15"	48"	1/2"	AAWS C1548 A ()	224.	225.	226.	228.	229.	233.	234.	235.	243.
	15"	54"	1/2"	AAWS C1554 A ()	246.	248.	249.	252.	253.	256.	258.	259.	266.
	15"	60"	1/2"	AAWS C1560 A ()	271.	274.	275.	278.	279.	282.	283.	285.	291.
	15"	66"	1/2"	AAWS C1566 A ()	297.	298.	300.	301.	302.	306.	307.	309.	316.
	15"	72"	1/2"	AAWS C1572 A ()	320.	321.	322.	323.	324.	328.	329.	332.	342.

Order Code	Specification Information	Application
Example: AAWS C0724 A 288-6	See finish page for Knoll textile selections.	Tackable upholstered covers insert between horizontal channels to provide tackable, fabric surface. Covers are tackable with 1/2" pushpins.
A AutoStrada		
AWS Applied wall system		Fabric is railroaded. Open shelves cannot be positioned immediately above tackable fabric covers. Tackable core is not firm enough to permit open shelf brackets to bear against face of cover.
C Cover		
07 Height		
24 Width		
A Tackable upholstered		
288-6 Fabric		

Wall covers

Tackable upholstered

AutoStrada

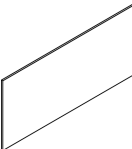
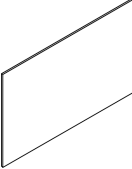
description	h	w	d	pattern no.	Grade								
					10	15	20	30	35	40	45	50	55
Tackable upholstered cover, 22½"H 	22½"	24"	½"	AAWS C2224 A ()	\$179.	\$183.	\$186.	\$189.	\$194.	\$199.	\$204.	\$211.	\$224.
	22½"	30"	½"	AAWS C2230 A ()	217.	222.	226.	229.	233.	237.	241.	249.	261.
	22½"	36"	½"	AAWS C2236 A ()	254.	259.	262.	265.	271.	277.	280.	287.	300.
	22½"	42"	½"	AAWS C2242 A ()	292.	297.	302.	306.	309.	314.	317.	324.	337.
	22½"	48"	½"	AAWS C2248 A ()	329.	334.	338.	344.	350.	354.	357.	364.	375.
	22½"	54"	½"	AAWS C2254 A ()	369.	372.	379.	382.	385.	391.	395.	402.	414.
	22½"	60"	½"	AAWS C2260 A ()	407.	412.	416.	419.	425.	428.	433.	440.	451.
	22½"	66"	½"	AAWS C2266 A ()	445.	449.	454.	459.	463.	467.	470.	478.	490.
	22½"	72"	½"	AAWS C2272 A ()	484.	488.	491.	495.	501.	504.	508.	516.	528.
Tackable upholstered cover, 30"H 	30"	24"	½"	AAWS C3024 A ()	324.	329.	332.	336.	344.	350.	355.	359.	379.
	30"	30"	½"	AAWS C3030 A ()	393.	398.	400.	404.	409.	414.	419.	425.	443.
	30"	36"	½"	AAWS C3036 A ()	461.	465.	467.	470.	475.	480.	486.	490.	510.
	30"	42"	½"	AAWS C3042 A ()	526.	530.	532.	538.	543.	547.	551.	556.	579.
	30"	48"	½"	AAWS C3048 A ()	594.	597.	599.	603.	609.	616.	620.	624.	643.
	30"	54"	½"	AAWS C3054 A ()	661.	665.	667.	671.	675.	679.	685.	690.	710.
	30"	60"	½"	AAWS C3060 A ()	725.	728.	731.	737.	742.	746.	752.	756.	777.
	30"	66"	½"	AAWS C3066 A ()	791.	797.	799.	804.	809.	814.	821.	824.	844.
	30"	72"	½"	AAWS C3072 A ()	859.	862.	865.	869.	874.	880.	887.	890.	911.

Order Code	Specification Information
Example: AAWS C0724 A 288-6	
A AutoStrada	
AWS Applied wall system	
C Cover	
07 Height	
24 Width	
A Tackable upholstered	
288-6 Fabric	

See finish page for Knoll textile selections.

Application



Tackable upholstered covers insert between horizontal channels to provide tackable, fabric surface. Covers are tackable with ½" pushpins.

Fabric is railroaded.

Open shelves cannot be positioned immediately above tackable fabric covers. Tackable core is not firm enough to permit open shelf brackets to bear against face of cover.

Wall covers

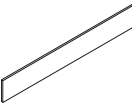
Non-tackable upholstered

description	h	w	d	pattern no.	Grade									
					10	15	20	30	35	40	45	50	55	
Non-tackable upholstered cover, 7 1/2"H 	7 1/2"	24"	1/2"	AAWS C0724 F ()	\$83.	\$85.	\$87.	\$95.	\$97.	\$100.	\$102.	\$108.	\$116.	
	7 1/2"	30"	1/2"	AAWS C0730 F ()	90.	94.	96.	101.	103.	105.	107.	116.	122.	
	7 1/2"	36"	1/2"	AAWS C0736 F ()	97.	100.	102.	106.	108.	110.	114.	122.	128.	
	7 1/2"	42"	1/2"	AAWS C0742 F ()	103.	105.	107.	111.	116.	119.	121.	128.	134.	
	7 1/2"	48"	1/2"	AAWS C0748 F ()	108.	110.	114.	120.	122.	124.	127.	134.	140.	
	7 1/2"	54"	1/2"	AAWS C0754 F ()	116.	119.	121.	126.	128.	131.	133.	140.	146.	
	7 1/2"	60"	1/2"	AAWS C0760 F ()	122.	124.	127.	132.	134.	136.	138.	146.	152.	
	7 1/2"	66"	1/2"	AAWS C0766 F ()	128.	131.	133.	137.	140.	142.	145.	152.	157.	
	7 1/2"	72"	1/2"	AAWS C0772 F ()	134.	136.	138.	144.	146.	148.	150.	157.	164.	
	7 1/2"	78"	1/2"	AAWS C0778 F ()	140.	142.	145.	149.	152.	154.	156.	164.	171.	
	7 1/2"	84"	1/2"	AAWS C0784 F ()	146.	148.	150.	155.	157.	161.	163.	171.	176.	
	7 1/2"	90"	1/2"	AAWS C0790 F ()	152.	154.	156.	162.	164.	167.	170.	176.	182.	
7 1/2"	96"	1/2"	AAWS C0796 F ()	157.	161.	163.	168.	171.	173.	175.	182.	187.		
Non-tackable upholstered cover, 15"H 	15"	24"	1/2"	AAWS C1524 F ()	105.	108.	110.	120.	122.	124.	128.	131.	136.	
	15"	30"	1/2"	AAWS C1530 F ()	119.	122.	124.	132.	134.	136.	140.	142.	148.	
	15"	36"	1/2"	AAWS C1536 F ()	131.	134.	136.	144.	146.	148.	152.	154.	161.	
	15"	42"	1/2"	AAWS C1542 F ()	142.	146.	148.	155.	157.	161.	164.	167.	173.	
	15"	48"	1/2"	AAWS C1548 F ()	154.	157.	161.	168.	171.	173.	176.	179.	184.	
	15"	54"	1/2"	AAWS C1554 F ()	167.	171.	173.	180.	182.	184.	187.	189.	196.	
	15"	60"	1/2"	AAWS C1560 F ()	179.	182.	184.	190.	193.	196.	200.	202.	209.	
	15"	66"	1/2"	AAWS C1566 F ()	189.	193.	196.	204.	207.	209.	213.	215.	222.	
	15"	72"	1/2"	AAWS C1572 F ()	202.	207.	209.	216.	219.	222.	225.	227.	233.	
	15"	78"	1/2"	AAWS C1578 F ()	215.	219.	222.	228.	230.	233.	236.	238.	244.	
	15"	84"	1/2"	AAWS C1584 F ()	227.	230.	233.	240.	242.	244.	248.	251.	256.	
	15"	90"	1/2"	AAWS C1590 F ()	238.	242.	244.	252.	254.	256.	260.	262.	268.	
15"	96"	1/2"	AAWS C1596 F ()	251.	254.	256.	263.	265.	268.	274.	277.	282.		

Order Code	Specification Information	Application
Example: AAWS C0724 F 288-6	See finish page for Knoll textile selections.	Non-tackable upholstered covers insert between horizontal channels to provide fabric surface.
A AutoStrada		
AWS Applied wall system	Fabric is railroaded.	Wood core is firm enough to permit open shelf brackets to bear against face of cover.
C Cover		
07 Height		
24 Width		
F Non-tackable upholstered		
288-6 Fabric		

Wall covers

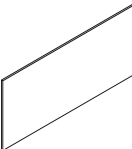
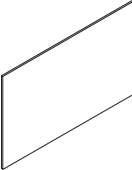

Non-tackable upholstered

description	h	w	d	pattern no.	Grade									
					10	15	20	30	35	40	45	50	55	
Non-tackable upholstered cover, 22 1/2"H 	22 1/2"	24"	1/2"	AAWS C2224 F ()	\$144.	\$149.	\$153.	\$164.	\$171.	\$176.	\$182.	\$193.	\$213.	
	22 1/2"	30"	1/2"	AAWS C2230 F ()	157.	167.	171.	181.	186.	192.	199.	211.	229.	
	22 1/2"	36"	1/2"	AAWS C2236 F ()	175.	183.	186.	198.	204.	210.	216.	228.	245.	
	22 1/2"	42"	1/2"	AAWS C2242 F ()	190.	200.	204.	215.	222.	227.	233.	244.	262.	
	22 1/2"	48"	1/2"	AAWS C2248 F ()	209.	217.	222.	231.	237.	243.	249.	261.	281.	
	22 1/2"	54"	1/2"	AAWS C2254 F ()	226.	234.	237.	248.	254.	260.	265.	280.	297.	
	22 1/2"	60"	1/2"	AAWS C2260 F ()	242.	251.	254.	264.	271.	279.	284.	295.	314.	
	22 1/2"	66"	1/2"	AAWS C2266 F ()	259.	266.	271.	283.	288.	293.	301.	312.	329.	
	22 1/2"	72"	1/2"	AAWS C2272 F ()	278.	285.	288.	300.	306.	311.	317.	328.	350.	
	22 1/2"	78"	1/2"	AAWS C2278 F ()	292.	302.	306.	316.	321.	327.	333.	348.	365.	
	22 1/2"	84"	1/2"	AAWS C2284 F ()	310.	318.	321.	332.	338.	347.	354.	364.	382.	
	22 1/2"	90"	1/2"	AAWS C2290 F ()	326.	334.	338.	353.	358.	363.	368.	381.	399.	
22 1/2"	96"	1/2"	AAWS C2296 F ()	345.	355.	358.	367.	372.	380.	385.	398.	416.		
Non-tackable upholstered cover, 30"H 	30"	24"	1/2"	AAWS C3024 F ()	164.	173.	176.	187.	200.	207.	213.	219.	236.	
	30"	30"	1/2"	AAWS C3030 F ()	185.	193.	198.	210.	223.	228.	234.	240.	258.	
	30"	36"	1/2"	AAWS C3036 F ()	208.	216.	220.	231.	243.	249.	255.	261.	281.	
	30"	42"	1/2"	AAWS C3042 F ()	229.	237.	241.	253.	264.	271.	279.	284.	302.	
	30"	48"	1/2"	AAWS C3048 F ()	251.	259.	262.	277.	287.	292.	300.	306.	322.	
	30"	54"	3/4"	AAWS C3054 F ()	274.	282.	285.	297.	309.	315.	320.	326.	347.	
	30"	60"	1/2"	AAWS C3060 F ()	293.	303.	307.	318.	329.	336.	344.	352.	367.	
	30"	66"	1/2"	AAWS C3066 F ()	316.	323.	327.	342.	355.	360.	365.	370.	390.	
	30"	72"	1/2"	AAWS C3072 F ()	337.	348.	353.	363.	373.	381.	388.	393.	410.	
	30"	78"	1/2"	AAWS C3078 F ()	361.	368.	371.	384.	397.	402.	408.	414.	434.	
	30"	84"	1/2"	AAWS C3084 F ()	382.	391.	395.	406.	418.	425.	431.	437.	454.	
	30"	90"	1/2"	AAWS C3090 F ()	404.	412.	416.	428.	440.	445.	451.	459.	475.	
	30"	96"	1/2"	AAWS C3096 F ()	426.	435.	438.	449.	463.	468.	473.	479.	498.	

Order Code	Specification Information	Application
Example: AAWS C0724 F 288-6	See finish page for Knoll textile selections.	Non-tackable upholstered covers insert between horizontal channels to provide fabric surface.
A AutoStrada		
AWS Applied wall system		
C Cover		Fabric is railroaded.
07 Height		Wood core is firm enough to permit open shelf brackets to bear against face of cover.
24 Width		
F Non-tackable upholstered		
288-6 Fabric		

Wall covers

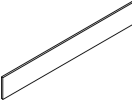
Laminate or Veneer surface

description	h	w	d	pattern no.	L	V1	V2	V3
Laminate or Veneer cover, 7 1/2"H 	7 1/2"	24"	1/2"	AAWS C0724 ()	\$69.	\$155.	\$188.	\$255.
	7 1/2"	30"	1/2"	AAWS C0730 ()	76.	164.	192.	266.
	7 1/2"	36"	1/2"	AAWS C0736 ()	79.	167.	194.	289.
	7 1/2"	42"	1/2"	AAWS C0742 ()	83.	173.	204.	314.
	7 1/2"	48"	1/2"	AAWS C0748 ()	87.	177.	210.	333.
	7 1/2"	54"	1/2"	AAWS C0754 ()	93.	183.	217.	358.
	7 1/2"	60"	1/2"	AAWS C0760 ()	98.	187.	226.	381.
	7 1/2"	66"	1/2"	AAWS C0766 ()	101.	190.	231.	401.
	7 1/2"	72"	1/2"	AAWS C0772 ()	105.	194.	238.	424.
	7 1/2"	78"	1/2"	AAWS C0778 ()	n/a	200.	245.	447.
	7 1/2"	84"	1/2"	AAWS C0784 ()	n/a	205.	253.	468.
	7 1/2"	90"	1/2"	AAWS C0790 ()	n/a	211.	261.	491.
	7 1/2"	96"	1/2"	AAWS C0796 ()	n/a	215.	266.	513.
Laminate or Veneer cover, 15"H 	15"	24"	1/2"	AAWS C1524 ()	85.	176.	209.	329.
	15"	30"	1/2"	AAWS C1530 ()	95.	185.	224.	375.
	15"	36"	1/2"	AAWS C1536 ()	103.	192.	236.	417.
	15"	42"	1/2"	AAWS C1542 ()	113.	202.	251.	462.
	15"	48"	1/2"	AAWS C1548 ()	123.	214.	266.	508.
	15"	54"	1/2"	AAWS C1554 ()	133.	226.	288.	550.
	15"	60"	1/2"	AAWS C1560 ()	141.	234.	298.	596.
	15"	66"	1/2"	AAWS C1566 ()	150.	243.	311.	639.
	15"	72"	1/2"	AAWS C1572 ()	157.	251.	323.	679.
	15"	78"	1/2"	AAWS C1578 ()	n/a	260.	338.	723.
	15"	84"	1/2"	AAWS C1584 ()	n/a	268.	355.	764.
	15"	90"	1/2"	AAWS C1590 ()	n/a	279.	367.	810.
	15"	96"	1/2"	AAWS C1596 ()	n/a	288.	381.	854.

Order Code

Example:	AAWS C0724 118
A	AutoStrada
AWS	Applied wall system
C	Cover
07	Height
24	Width
118	Finish

Specification Information

See finish page for laminate and veneer finish codes.

Product on this page will accept wood grain laminate where laminate is currently an option.

Application

Veneer or laminate covers insert between horizontal channels.

Techwood and natural veneer grain direction is horizontal.

Wall covers

Laminate or Veneer surface

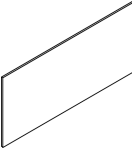
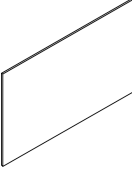
description	h	w	d	pattern no.	L	V1	V2	V3
Laminate or Veneer cover, 22 1/2"H 	22 1/2"	24"	1/2"	AAWS C2224 ()	\$105.	\$196.	\$240.	\$421.
	22 1/2"	30"	1/2"	AAWS C2230 ()	119.	210.	256.	472.
	22 1/2"	36"	1/2"	AAWS C2236 ()	138.	231.	288.	556.
	22 1/2"	42"	1/2"	AAWS C2242 ()	150.	243.	309.	622.
	22 1/2"	48"	1/2"	AAWS C2248 ()	161.	256.	328.	682.
	22 1/2"	54"	1/2"	AAWS C2254 ()	172.	267.	352.	745.
	22 1/2"	60"	1/2"	AAWS C2260 ()	200.	284.	371.	816.
	22 1/2"	66"	1/2"	AAWS C2266 ()	204.	295.	391.	873.
	22 1/2"	72"	1/2"	AAWS C2272 ()	208.	308.	410.	936.
	22 1/2"	78"	1/2"	AAWS C2278 ()	n/a	320.	433.	1,000.
	22 1/2"	84"	1/2"	AAWS C2284 ()	n/a	333.	451.	1,066.
	22 1/2"	90"	1/2"	AAWS C2290 ()	n/a	349.	472.	1,132.
22 1/2"	96"	1/2"	AAWS C2296 ()	n/a	362.	492.	1,192.	
Laminate or Veneer cover, 30"H 	30"	24"	1/2"	AAWS C3024 ()	123.	214.	266.	509.
	30"	30"	1/2"	AAWS C3030 ()	140.	234.	297.	596.
	30"	36"	1/2"	AAWS C3036 ()	162.	256.	328.	683.
	30"	42"	1/2"	AAWS C3042 ()	177.	271.	358.	769.
	30"	48"	1/2"	AAWS C3048 ()	191.	290.	383.	853.
	30"	54"	1/2"	AAWS C3054 ()	213.	313.	416.	941.
	30"	60"	1/2"	AAWS C3060 ()	227.	328.	443.	1,029.
	30"	66"	1/2"	AAWS C3066 ()	241.	349.	470.	1,110.
	30"	72"	1/2"	AAWS C3072 ()	258.	365.	497.	1,194.
	30"	78"	1/2"	AAWS C3078 ()	n/a	379.	525.	1,279.
	30"	84"	1/2"	AAWS C3084 ()	n/a	399.	550.	1,361.
	30"	90"	1/2"	AAWS C3090 ()	n/a	415.	580.	1,447.
30"	96"	1/2"	AAWS C3096 ()	n/a	432.	604.	1,531.	

Order Code

Example:	AAWS C0724 118
A	AutoStrada
AWS	Applied wall system
C	Cover
07	Height
24	Width
118	Finish

Specification Information

See finish page for laminate and veneer finish codes.

Product on this page will accept wood grain laminate where laminate is currently an option.



Application

Veneer or laminate covers insert between horizontal channels.

Techwood and natural veneer grain direction is horizontal.

Wall covers

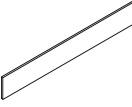
Painted surface

description	h	w	d	pattern no.	paint
Painted cover, 7 1/2"H 	7 1/2"	24"	1/2"	AAWS C0724 P ()	\$131.
	7 1/2"	30"	1/2"	AAWS C0730 P ()	132.
	7 1/2"	36"	1/2"	AAWS C0736 P ()	133.
	7 1/2"	42"	1/2"	AAWS C0742 P ()	164.
	7 1/2"	48"	1/2"	AAWS C0748 P ()	167.
	7 1/2"	54"	1/2"	AAWS C0754 P ()	168.
	7 1/2"	60"	1/2"	AAWS C0760 P ()	199.
	7 1/2"	66"	1/2"	AAWS C0766 P ()	201.
	7 1/2"	72"	1/2"	AAWS C0772 P ()	202.
	7 1/2"	78"	1/2"	AAWS C0778 P ()	206.
	7 1/2"	84"	1/2"	AAWS C0784 P ()	237.
	7 1/2"	90"	1/2"	AAWS C0790 P ()	240.
7 1/2"	96"	1/2"	AAWS C0796 P ()	241.	
Painted cover, 15"H 	15"	24"	1/2"	AAWS C1524 P ()	138.
	15"	30"	1/2"	AAWS C1530 P ()	142.
	15"	36"	1/2"	AAWS C1536 P ()	146.
	15"	42"	1/2"	AAWS C1542 P ()	180.
	15"	48"	1/2"	AAWS C1548 P ()	183.
	15"	54"	1/2"	AAWS C1554 P ()	185.
	15"	60"	1/2"	AAWS C1560 P ()	220.
	15"	66"	1/2"	AAWS C1566 P ()	224.
	15"	72"	1/2"	AAWS C1572 P ()	227.
	15"	78"	1/2"	AAWS C1578 P ()	230.
	15"	84"	1/2"	AAWS C1584 P ()	264.
	15"	90"	1/2"	AAWS C1590 P ()	268.
15"	96"	1/2"	AAWS C1596 P ()	274.	

Order Code

Example:	AAWS C0724 P 118
A	AutoStrada
AWS	Applied wall system
C	Cover
07	Height
24	Width
P	Painted surface
118	Finish

Specification Information

See finish page for painted finish codes.

Application

Painted wood covers insert between horizontal channels.
 Painted covers are powder coat or wet spray on medium density fiberboard.

Wall covers

Painted surface

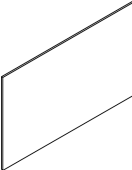
description	h	w	d	pattern no.	paint
Painted cover, 22 1/2"H 	22 1/2"	24"	1/2"	AAWS C2224 P ()	\$146.
	22 1/2"	30"	1/2"	AAWS C2230 P ()	152.
	22 1/2"	36"	1/2"	AAWS C2236 P ()	156.
	22 1/2"	42"	1/2"	AAWS C2242 P ()	190.
	22 1/2"	48"	1/2"	AAWS C2248 P ()	196.
	22 1/2"	54"	1/2"	AAWS C2254 P ()	202.
	22 1/2"	60"	1/2"	AAWS C2260 P ()	237.
	22 1/2"	66"	1/2"	AAWS C2266 P ()	242.
	22 1/2"	72"	1/2"	AAWS C2272 P ()	248.
	22 1/2"	78"	1/2"	AAWS C2278 P ()	253.
	22 1/2"	84"	1/2"	AAWS C2284 P ()	290.
	22 1/2"	90"	1/2"	AAWS C2290 P ()	295.
22 1/2"	96"	1/2"	AAWS C2296 P ()	301.	
Painted cover, 30"H 	30"	24"	1/2"	AAWS C3024 P ()	153.
	30"	30"	1/2"	AAWS C3030 P ()	161.
	30"	36"	1/2"	AAWS C3036 P ()	168.
	30"	42"	1/2"	AAWS C3042 P ()	206.
	30"	48"	1/2"	AAWS C3048 P ()	211.
	30"	54"	1/2"	AAWS C3054 P ()	219.
	30"	60"	1/2"	AAWS C3060 P ()	255.
	30"	66"	1/2"	AAWS C3066 P ()	262.
	30"	72"	1/2"	AAWS C3072 P ()	268.
	30"	78"	1/2"	AAWS C3078 P ()	278.
	30"	84"	1/2"	AAWS C3084 P ()	316.
	30"	90"	1/2"	AAWS C3090 P ()	321.
30"	96"	1/2"	AAWS C3096 P ()	328.	

Order Code

Example:	AAWS C0724 P 118
A	AutoStrada
AWS	Applied wall system
C	Cover
07	Height
24	Width
P	Painted surface
118	Finish

Specification Information

See finish page for painted finish codes.

Application

Painted wood covers insert between horizontal channels.
 Painted covers are powder coat or wet spray on medium density fiberboard.

Wall covers

Backpainted glass surface

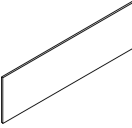
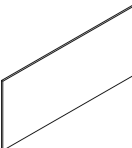
description	h	w	pattern no.	881	882
Backpainted glass, 15"H 	15"	24"	AAWS C1524 G ()	\$290.	\$354.
	15"	30"	AAWS C1530 G ()	338.	400.
	15"	36"	AAWS C1536 G ()	389.	448.
	15"	42"	AAWS C1542 G ()	437.	497.
	15"	48"	AAWS C1548 G ()	485.	545.
	15"	54"	AAWS C1554 G ()	532.	595.
	15"	60"	AAWS C1560 G ()	583.	642.
	15"	66"	AAWS C1566 G ()	630.	690.
Backpainted glass, 22 1/2"H 	22 1/2"	24"	AAWS C2224 G ()	382.	462.
	22 1/2"	30"	AAWS C2230 G ()	454.	527.
	22 1/2"	36"	AAWS C2236 G ()	521.	595.
	22 1/2"	42"	AAWS C2242 G ()	595.	668.
	22 1/2"	48"	AAWS C2248 G ()	662.	751.
	22 1/2"	54"	AAWS C2254 G ()	726.	836.
	22 1/2"	60"	AAWS C2260 G ()	800.	920.
	22 1/2"	66"	AAWS C2266 G ()	866.	1,005.
	22 1/2"	72"	AAWS C2272 G ()	933.	1,092.

Order Code

Example:	AAWS C1524 G 881
A	AutoStrada
AWS	Applied wall system
C	Cover
15	Height
24	Width
G	Backpainted glass
881	Finish

Specification Information

Backpainted glass is 4mm thick.
 Specify glass surface:
 881 sea glass white
 882 star white

Sea glass has natural glass tint.
 Star glass has low lead content for pure white appearance.

Application

Backpainted glass covers insert between horizontal channels to provide nearly opaque glass surface. Glass covers may be used as dry-erase marker surface.

Bookshelves cannot be mounted in channel directly above glass cover.

description	h	w	d	pattern no.	price	material
Display shelf	1"	6"	5 1/2"	AAWS DS0605 ()	\$83.	aluminum
	1"	24"	5 1/2"	AAWS DS2405 ()	219.	aluminum
	1"	30"	5 1/2"	AAWS DS3005 ()	230.	aluminum
	1"	36"	5 1/2"	AAWS DS3605 ()	248.	aluminum
	1"	42"	5 1/2"	AAWS DS4205 ()	274.	aluminum
	1"	48"	5 1/2"	AAWS DS4805 ()	290.	aluminum
	1"	54"	5 1/2"	AAWS DS5405 ()	315.	aluminum
	1"	60"	5 1/2"	AAWS DS6005 ()	326.	aluminum
	1"	66"	5 1/2"	AAWS DS6605 ()	338.	aluminum
	1"	72"	5 1/2"	AAWS DS7205 ()	354.	aluminum

Order Code



Example:	AAWS DS2405 AA
A	AutoStrada
AWS	Applied wall system
DS	Display shelf
24	Width
05	Depth
AA	Finish

Specification Information

AA - Anodized Aluminum or any standard painted finish except 613 Silver.

Application

Display shelf is natural anodized aluminum extrusion with integral bracket detail that engages into horizontal channel at any point. Display shelves are typically mounted in channels at 31 1/2" or 39" above the floor. Display shelf can be mounted in channel between glass covers.

description	h	w	d	pattern no.	list	glass
Powder glass lower shelf 	1 1/2"	24"	9"	AAWS LS2409 G () ()		\$509.
	1 1/2"	30"	9"	AAWS LS3009 G () ()		545.
	1 1/2"	36"	9"	AAWS LS3609 G () ()		590.
	1 1/2"	42"	9"	AAWS LS4209 G () ()		636.
	1 1/2"	48"	9"	AAWS LS4809 G () ()		684.
	1 1/2"	54"	9"	AAWS LS5409 G () ()		739.
	1 1/2"	60"	9"	AAWS LS6009 G () ()		786.
	1 1/2"	66"	9"	AAWS LS6609 G () ()		843.
	1 1/2"	72"	9"	AAWS LS7209 G () ()		898.
Powder glass upper shelf 	1 1/2"	24"	9"	AAWS US2409 G () ()		509.
	1 1/2"	30"	9"	AAWS US3009 G () ()		545.
	1 1/2"	36"	9"	AAWS US3609 G () ()		590.
	1 1/2"	42"	9"	AAWS US4209 G () ()		636.
	1 1/2"	48"	9"	AAWS US4809 G () ()		684.
	1 1/2"	54"	9"	AAWS US5409 G () ()		739.
	1 1/2"	60"	9"	AAWS US6009 G () ()		786.
	1 1/2"	66"	9"	AAWS US6609 G () ()		843.
	1 1/2"	72"	9"	AAWS US7209 G () ()		898.
Book ends (pair)	7"	5"	7"	AAWS BE ()	67.	

Order Code

Example:	AAWS LS2409 G GL13 AA
A	AutoStrada
AWS	Applied wall system
LS	Shelf
24	Width
09	Depth
G	Glass
GL13	Glass finish
AA	Support finish

Specification Information

GL13 - Powder glass only.
 Glass platform is available in AA anodized aluminum or any standard painted finish except Silver.
 Bookends are available in any standard painted finish.

Application



Glass shelves are supported by a 5 1/2" deep aluminum platform with integral bracket detail that engages into horizontal channel at any point.
 Specify lower shelf for most applications to align with bottom of adjacent overhead storage cabinet. Specify upper shelf only to align with top of adjacent overhead storage cabinet.
 Shelf bracket bears against surface of cover below so it cannot be positioned above glass or tackable fabric covers.

Book ends rest on glass shelf at any point to contain books or binders.

Bookshelves

lamine and veneer

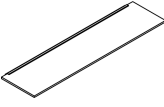
AutoStrada

description	h	w	d	pattern no.	list	L	V1	V2	V3
Laminate or veneer lower shelf 	1 1/2"	24"	12"	AAWS LS2412 () ()		\$224.	\$300.	\$345.	\$465.
	1 1/2"	30"	12"	AAWS LS3012 () ()		246.	329.	381.	512.
	1 1/2"	36"	12"	AAWS LS3612 () ()		271.	363.	417.	560.
	1 1/2"	42"	12"	AAWS LS4212 () ()		294.	395.	452.	610.
	1 1/2"	48"	12"	AAWS LS4812 () ()		316.	426.	489.	661.
	1 1/2"	54"	12"	AAWS LS5412 () ()		389.	520.	598.	806.
	1 1/2"	60"	12"	AAWS LS6012 () ()		364.	488.	560.	758.
	1 1/2"	66"	12"	AAWS LS6612 () ()		389.	520.	598.	806.
	1 1/2"	72"	12"	AAWS LS7212 () ()		413.	550.	633.	855.
Laminate or veneer upper shelf 	1 1/2"	24"	12"	AAWS US2412 () ()		224.	300.	345.	465.
	1 1/2"	30"	12"	AAWS US3012 () ()		246.	329.	381.	512.
	1 1/2"	36"	12"	AAWS US3612 () ()		271.	363.	417.	560.
	1 1/2"	42"	12"	AAWS US4212 () ()		294.	395.	452.	610.
	1 1/2"	48"	12"	AAWS US4812 () ()		316.	426.	489.	661.
	1 1/2"	54"	12"	AAWS US5412 () ()		389.	520.	598.	806.
	1 1/2"	60"	12"	AAWS US6012 () ()		364.	488.	560.	758.
	1 1/2"	66"	12"	AAWS US6612 () ()		389.	520.	598.	806.
	1 1/2"	72"	12"	AAWS US7212 () ()		413.	550.	633.	855.
Book ends (pair)	7"	5"	7"	AAWS BE ()	67.				

Order Code

Example:	AAWS LS2412 118 AA
A	Autostrada
AWS	Applied wall system
LS	Shelf
24	Width
12	Depth
118	Shelf finish
AA	Support finish

Specification Information

Shelf platform is available in AA anodized aluminum or any standard painted finish except 613 Silver.

Bookends are available in any standard painted finish.

See finish page for laminate and veneer finish codes.

Product on this page will accept wood grain laminate where laminate is currently an option.

Application

Laminate and veneer bookshelves are supported by a 5 1/2" deep aluminum platform with integral bracket detail that engages into horizontal channel at any point. Specify lower shelf for most applications to align with bottom of adjacent overhead storage cabinet. Specify upper shelf only to align with top of adjacent overhead storage cabinet. Shelf bracket bears against surface of cover below so it cannot be positioned above glass or tackable fabric covers.

Book ends rest on bookshelf at any point to contain books or binders.

Open overhead cabinets

Laminate or wood veneer

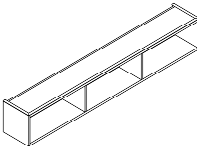
description	h	w	d	pattern no.	L	V1	V2	V3
Open overhead, binder depth  96" w shown	15"	18"	14 1/4"	AAWS OBO 18 ()()	\$1,575.	\$1,682.	\$1,940.	\$2,521.
	15"	24"	14 1/4"	AAWS OBO 24 ()()	1,617.	1,726.	1,988.	2,583.
	15"	30"	14 1/4"	AAWS OBO 30 ()()	1,662.	1,772.	2,036.	2,649.
	15"	36"	14 1/4"	AAWS OBO 36 ()()	1,707.	1,819.	2,090.	2,715.
	15"	42"	14 1/4"	AAWS OBO 42 ()()	1,750.	1,863.	2,143.	2,787.
	15"	48"	14 1/4"	AAWS OBO 48 ()()	1,798.	1,913.	2,202.	2,863.
	15"	54"	14 1/4"	AAWS OBO 54 ()()	1,892.	2,011.	2,317.	3,010.
	15"	60"	14 1/4"	AAWS OBO 60 ()()	1,986.	2,109.	2,430.	3,161.
	15"	66"	14 1/4"	AAWS OBO 66 ()()	2,040.	2,175.	2,497.	3,248.
	15"	72"	14 1/4"	AAWS OBO 72 ()()	2,098.	2,237.	2,566.	3,337.
	15"	78"	14 1/4"	AAWS OBO 78 ()()	2,200.	2,348.	2,695.	3,503.
	15"	84"	14 1/4"	AAWS OBO 84 ()()	2,265.	2,418.	2,776.	3,609.
	15"	90"	14 1/4"	AAWS OBO 90 ()()	2,335.	2,492.	2,861.	3,717.
	15"	96"	14 1/4"	AAWS OBO 96 ()()	2,403.	2,565.	2,946.	4,136.
	Open overhead, legal depth	15"	18"	17 1/4"	AAWS OGO 18 ()()	1,701.	1,819.	2,091.
15"		24"	17 1/4"	AAWS OGO 24 ()()	1,746.	1,866.	2,144.	2,790.
15"		30"	17 1/4"	AAWS OGO 30 ()()	1,795.	1,914.	2,201.	2,862.
15"		36"	17 1/4"	AAWS OGO 36 ()()	1,843.	1,965.	2,256.	2,935.
15"		42"	17 1/4"	AAWS OGO 42 ()()	1,891.	2,011.	2,316.	3,010.
15"		48"	17 1/4"	AAWS OGO 48 ()()	1,941.	2,065.	2,377.	3,092.
15"		54"	17 1/4"	AAWS OGO 54 ()()	2,042.	2,173.	2,502.	3,252.
15"		60"	17 1/4"	AAWS OGO 60 ()()	2,146.	2,281.	2,626.	3,412.
15"		66"	17 1/4"	AAWS OGO 66 ()()	2,202.	2,348.	2,699.	3,509.
15"		72"	17 1/4"	AAWS OGO 72 ()()	2,262.	2,416.	2,774.	3,605.
15"		78"	17 1/4"	AAWS OGO 78 ()()	2,378.	2,537.	2,913.	3,785.
15"		84"	17 1/4"	AAWS OGO 84 ()()	2,448.	2,611.	2,999.	3,899.
15"		90"	17 1/4"	AAWS OGO 90 ()()	2,522.	2,688.	3,090.	4,014.
15"		96"	17 1/4"	AAWS OGO 96 ()()	2,598.	2,771.	3,182.	4,136.

Order Code	Specification Information	Application
Example: AAWS OBO 18 118 115	See finish page for laminate and veneer finish codes.	Open overhead cabinets include continuous mounting extrusion that engages into top or intermediate channel at any point.
A AutoStrada	Product on this page will accept wood grain laminate where laminate is currently an option.	Open overhead cabinets are binder height.
AWS Applied wall system	Top trim may be specified in AA anodized aluminum or any standard painted finish except Silver.	Overhead cabinets also include anti-dislodgement brackets that engage into intermediate channel below cabinet.
OBO Open overhead cabinet	Mounting extrusions and anti dislodgement brackets match the AA trim or are black paint with any painted finish trim.	Overhead cabinets normally mount between 54" and 69" above the floor.
18 Width		
118 Laminate or veneer		
115 Trim finish		

Sliding door overhead cabinets with glass doors

Laminate or wood veneer

AutoStrada

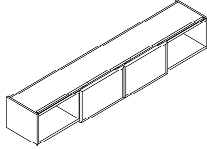
description	h	w	d	pattern no.	L	V1	V2	V3
 <p>96" w shown</p>	15"	42"	15 1/4"	AAWS OBR 42 () ()	\$3,253.	\$3,496.	\$4,385.	\$5,261.
	15"	48"	15 1/4"	AAWS OBR 48 () ()	3,353.	3,610.	4,520.	5,427.
	15"	54"	15 1/4"	AAWS OBR 54 () ()	3,453.	3,725.	4,653.	5,585.
	15"	60"	15 1/4"	AAWS OBR 60 () ()	3,554.	3,842.	4,787.	5,745.
	15"	66"	15 1/4"	AAWS OBR 66 () ()	3,651.	3,957.	4,923.	5,908.
	15"	72"	15 1/4"	AAWS OBR 72 () ()	3,750.	4,071.	5,056.	6,070.
	15"	78"	15 1/4"	AAWS OBR 78 () ()	3,940.	4,275.	5,311.	6,374.
	15"	84"	15 1/4"	AAWS OBR 84 () ()	4,057.	4,403.	5,471.	6,563.
	15"	90"	15 1/4"	AAWS OBR 90 () ()	4,179.	4,534.	5,635.	6,762.
	15"	96"	15 1/4"	AAWS OBR 96 () ()	4,307.	4,671.	5,804.	6,966.
Open/Sliding door(s) glass, legal depth	15"	42"	18 1/4"	AAWS OGR 42 () ()	3,511.	3,778.	4,734.	5,677.
	15"	48"	18 1/4"	AAWS OGR 48 () ()	3,617.	3,901.	4,879.	5,854.
	15"	54"	18 1/4"	AAWS OGR 54 () ()	3,726.	4,323.	5,026.	6,030.
	15"	60"	18 1/4"	AAWS OGR 60 () ()	3,833.	4,150.	5,172.	6,206.
	15"	66"	18 1/4"	AAWS OGR 66 () ()	3,945.	4,273.	5,316.	6,378.
	15"	72"	18 1/4"	AAWS OGR 72 () ()	4,051.	4,394.	5,463.	6,556.
	15"	78"	18 1/4"	AAWS OGR 78 () ()	4,254.	4,617.	5,737.	6,884.
	15"	84"	18 1/4"	AAWS OGR 84 () ()	4,383.	4,756.	5,908.	7,091.
	15"	90"	18 1/4"	AAWS OGR 90 () ()	4,512.	4,897.	6,085.	7,305.
	15"	96"	18 1/4"	AAWS OGR 96 () ()	4,649.	5,044.	6,269.	7,522.

Order Code	Specification Information	Application
Example: AAWS ORB 42 118 GL13 AA	See finish page for laminate, veneer and glass finish codes.	Sliding door overhead cabinets include continuous mounting extrusion that engages into top or intermediate channel at any point. Overhead cabinets also include anti-dislodgement brackets that engage into intermediate channel below cabinet. Overhead cabinets normally mount between 54" and 69" above the floor.
A AutoStrada	Product on this page will accept wood grain laminate where laminate is currently an option.	Overhead cabinets are binder height.
AWS Applied wall system	Trim finish is AA anodized aluminum or any standard painted finish except 613 Silver.	No locks.
ORB Sliding glass door binder depth overhead	Mounting extrusion and anti dislodgement brackets match the AA trim or are black paint with any painted finish trim.	
42 Width		
118 Case finish		
GL13 Glass finish		
AA Trim finish		

Sliding door overhead cabinets with laminate or veneer doors

Laminate or wood veneer

AutoStrada

Applied Wall

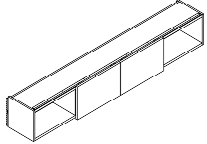
description	h	w	d	pattern no.	L	V1	V2	V3
Open/Sliding door(s) laminate or veneer, binder depth  96" w shown	15"	42"	15 1/4"	AAWS OBS 42 () ()	\$2,724.	\$2,942.	\$3,739.	\$4,861.
	15"	48"	15 1/4"	AAWS OBS 48 () ()	2,810.	3,040.	3,854.	5,010.
	15"	54"	15 1/4"	AAWS OBS 54 () ()	2,894.	3,135.	3,969.	5,160.
	15"	60"	15 1/4"	AAWS OBS 60 () ()	2,975.	3,230.	4,083.	5,309.
	15"	66"	15 1/4"	AAWS OBS 66 () ()	3,062.	3,325.	4,198.	5,458.
	15"	72"	15 1/4"	AAWS OBS 72 () ()	3,144.	3,421.	4,313.	5,608.
	15"	78"	15 1/4"	AAWS OBS 78 () ()	3,301.	3,594.	4,530.	5,890.
	15"	84"	15 1/4"	AAWS OBS 84 () ()	3,399.	3,700.	4,668.	6,065.
	15"	90"	15 1/4"	AAWS OBS 90 () ()	3,502.	3,814.	4,805.	6,246.
	15"	96"	15 1/4"	AAWS OBS 96 () ()	3,606.	3,926.	4,949.	6,436.
Open/Sliding door(s) laminate or veneer, legal depth	15"	42"	18 1/4"	AAWS OGS 42 () ()	2,943.	3,174.	4,049.	5,248.
	15"	48"	18 1/4"	AAWS OGS 48 () ()	3,037.	3,279.	4,168.	5,410.
	15"	54"	18 1/4"	AAWS OGS 54 () ()	3,125.	3,384.	4,289.	5,572.
	15"	60"	18 1/4"	AAWS OGS 60 () ()	3,214.	3,488.	4,409.	5,732.
	15"	66"	18 1/4"	AAWS OGS 66 () ()	3,306.	3,594.	4,534.	5,896.
	15"	72"	18 1/4"	AAWS OGS 72 () ()	3,395.	3,694.	4,662.	6,057.
	15"	78"	18 1/4"	AAWS OGS 78 () ()	3,566.	3,879.	4,894.	6,360.
	15"	84"	18 1/4"	AAWS OGS 84 () ()	3,671.	3,998.	5,039.	6,549.
	15"	90"	18 1/4"	AAWS OGS 90 () ()	3,782.	4,116.	5,189.	6,748.
	15"	96"	18 1/4"	AAWS OGS 96 () ()	3,896.	4,240.	5,347.	6,949.

Order Code	Specification Information	Application
Example: AAWS OBS 42 118 AA A AutoStrada AWS Applied wall system OBS Sliding solid door binder depth overhead 42 Width 118 Finish AA Trim finish	See finish page for laminate and veneer finish codes. Product on this page will accept wood grain laminate where laminate is currently an option. Trim finish is AA anodized aluminum or any standard painted finish except 613 Silver. Mounting extrusion and anti dislodgement bracket match the AA trim or are black paint with any painted finish trim.	Sliding door overhead cabinets include continuous mounting extrusion that engages into top or intermediate channel at any point. Overhead cabinets also include anti-dislodgement brackets that engage into intermediate channel below cabinet. Overhead cabinets normally mount between 54" and 69" above the floor. Sliding door overheads are not available with locks. Overhead cabinets are binder height. No locks.

Hinged door overhead cabinets

Laminate or wood veneer

AutoStrada

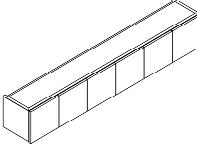
description	h	w	d	#drs/locks	pattern no.	L	V1	V2	V3
Hinged door overhead binder depth  96" w shown	15"	18"	15 1/4"	1/1	AAWS OBD 18L () ()	\$2,164.	\$2,304.	\$2,644.	\$3,439.
	15"	18"	15 1/4"	1/1	AAWS OBD 18R () ()	2,164.	2,304.	2,644.	3,439.
	15"	24"	15 1/4"	2/1	AAWS OBD 24 () ()	2,288.	2,434.	2,793.	3,636.
	15"	30"	15 1/4"	2/1	AAWS OBD 30 () ()	2,418.	2,574.	2,957.	3,847.
	15"	36"	15 1/4"	2/1	AAWS OBD 36 () ()	2,555.	2,721.	3,131.	4,070.
	15"	42"	15 1/4"	3/2	AAWS OBD 42 () ()	2,574.	2,744.	3,153.	4,097.
	15"	48"	15 1/4"	3/2	AAWS OBD 48 () ()	2,623.	2,791.	3,216.	4,179.
	15"	54"	15 1/4"	3/2	AAWS OBD 54 () ()	2,761.	2,938.	3,382.	4,396.
	15"	60"	15 1/4"	4/2	AAWS OBD 60 () ()	2,893.	3,077.	3,540.	4,602.
	15"	66"	15 1/4"	4/2	AAWS OBD 66 () ()	2,976.	3,173.	3,647.	4,744.
	15"	72"	15 1/4"	4/2	AAWS OBD 72 () ()	3,059.	3,257.	3,746.	4,867.
	15"	78"	15 1/4"	5/3	AAWS OBD 78 () ()	3,214.	3,428.	3,935.	5,118.
	15"	84"	15 1/4"	5/3	AAWS OBD 84 () ()	3,309.	3,532.	4,054.	5,271.
	15"	90"	15 1/4"	6/3	AAWS OBD 90 () ()	3,406.	3,637.	4,177.	5,430.
	15"	96"	15 1/4"	6/3	AAWS OBD 96 () ()	3,512.	3,746.	4,301.	5,592.
Hinged door overhead legal depth	15"	18"	18 1/4"	1/1	AAWS OGD 18L () ()	2,338.	2,487.	2,854.	3,712.
	15"	18"	18 1/4"	1/1	AAWS OGD 18R () ()	2,338.	2,487.	2,854.	3,712.
	15"	24"	18 1/4"	2/1	AAWS OGD 24 () ()	2,469.	2,629.	3,020.	3,927.
	15"	30"	18 1/4"	2/1	AAWS OGD 30 () ()	2,610.	2,779.	3,195.	4,153.
	15"	36"	18 1/4"	2/1	AAWS OGD 36 () ()	2,760.	2,939.	3,381.	4,393.
	15"	42"	18 1/4"	3/2	AAWS OGD 42 () ()	2,780.	2,975.	3,405.	4,425.
	15"	48"	18 1/4"	3/2	AAWS OGD 48 () ()	2,834.	3,013.	3,470.	4,515.
	15"	54"	18 1/4"	3/2	AAWS OGD 54 () ()	2,984.	3,172.	3,649.	4,748.
	15"	60"	18 1/4"	4/2	AAWS OGD 60 () ()	3,123.	3,324.	3,824.	4,971.
	15"	66"	18 1/4"	4/2	AAWS OGD 66 () ()	3,216.	3,427.	3,941.	5,122.
	15"	72"	18 1/4"	4/2	AAWS OGD 72 () ()	3,304.	3,516.	4,047.	5,259.
	15"	78"	18 1/4"	5/3	AAWS OGD 78 () ()	3,473.	3,703.	4,249.	5,527.
	15"	84"	18 1/4"	5/3	AAWS OGD 84 () ()	3,576.	3,815.	4,378.	5,692.
	15"	90"	18 1/4"	6/3	AAWS OGD 90 () ()	3,683.	3,928.	4,512.	5,861.
	15"	96"	18 1/4"	6/3	AAWS OGD 96 () ()	3,792.	4,047.	4,645.	6,039.

Order Code	Specification Information	Application
Example: AAWS OBD 24 L 118 AA A AutoStrada AWS Applied wall system OBD Hinged door binder depth overhead 24 Width L Lock 118 Case & matching door finish AA Trim finish	See finish page for laminate and veneer finish codes. Product on this page will accept wood grain laminate where laminate is currently an option. Trim finish is AA anodized aluminum or any standard painted finish except 613 Silver. Mounting extrusion and anti dislodgement brackets match the AA trim or are black paint with any painted finish trim.	Hinged door overhead cabinets include continuous mounting extrusion that engages into top or intermediate channel at any point. Overhead cabinets also include anti-dislodgement brackets that engage into intermediate channel below cabinet. Overhead cabinets normally mount between 54" and 69" above the floor. Overhead cabinets are binder height.

Overhead storage mounting kits

Adapters for Reuter and wall-attached wood overheads

AutoStrada

Applied Wall

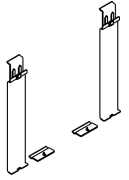
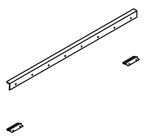
description	type	w	pattern no.	finished	black or AA
Reuter overhead storage downmount kit	Applied Wall		AAWS RO MK ()	\$194.	
					
Adapter kit for wood overhead storage		18"	AAWS WOMK 18 ()		94.
		24"	AAWS WOMK 24 ()		99.
		30"	AAWS WOMK 30 ()		103.
		36"	AAWS WOMK 36 ()		110.
		42"	AAWS WOMK 42 ()		118.
		48"	AAWS WOMK 48 ()		123.
		54"	AAWS WOMK 54 ()		128.
		60"	AAWS WOMK 60 ()		134.
		66"	AAWS WOMK 66 ()		139.
		72"	AAWS WOMK 72 ()		156.
		78"	AAWS WOMK 78 ()		166.
		84"	AAWS WOMK 84 ()		173.
		90"	AAWS WOMK 90 ()		179.
		96"	AAWS WOMK 96 ()		184.

Order Code

Example:	AAWS WOMK 18 AA
A	AutoStrada
AWS	Applied wall system
WOMK	Wall mount bracket kit
18	Width
AA	Finish

Specification Information

For Reuter overhead downmount brackets - see finish page for painted finish code options.

Adapter kits for wood overheads are available in AA anodized aluminum or 111 black only.

Application



Reuter overhead storage downmount kit adapts Reuter flat front or curved front cabinets to attach to top or intermediate channel. Kit includes two anti-dislodgement brackets that engage into intermediate channel below the cabinet.

Adapter kit for wood overhead storage converts AutoStrada wall-attached single-high overhead cabinets to mount on the applied wall system.

Power and wire management

Cable trays and worksurface supports

AutoStrada

description	application	h	w	d	pattern no.	list	painting or aluminum
 Cable tray		2 1/4"	24"	1 3/4"	AAWS CT24 ()		\$74.
		2 1/4"	30"	1 3/4"	AAWS CT30 ()		80.
		2 1/4"	36"	1 3/4"	AAWS CT36 ()		92.
		2 1/4"	42"	1 3/4"	AAWS CT42 ()		104.
		2 1/4"	48"	1 3/4"	AAWS CT48 ()		119.
		2 1/4"	54"	1 3/4"	AAWS CT54 ()		136.
		2 1/4"	60"	1 3/4"	AAWS CT60 ()		144.
		2 1/4"	66"	1 3/4"	AAWS CT66 ()		149.
		2 1/4"	72"	1 3/4"	AAWS CT72 ()		154.
 End support bracket	28 3/8"H worksurface	3"	2"		AAWS BE27 ()	124.	
	29 5/8"H worksurface	4"	2"		AAWS BE28 ()	124.	

Order Code

Example: AAWS CT24 AA	
A	AutoStrada
AWS	Applied Wall System
CT	Cable tray
24	Width
AA	Finish

Specification Information

Cable trays are available in AA - Anodized Aluminum or any standard painted finish except 613 Silver.

End support brackets are available in all standard paint finishes.

Application

Cable trays mount anywhere along any intermediate channel, and are typically installed below worksurface height in the channel 24" above the floor.

End support brackets also directly engage into intermediate channel at 24" above floor to support back edge or one end of worksurface.

When combined with recess cover above cable tray is effectively expanded from 1 3/4" to 2 1/2" deep.



End support brackets include a flat base plate to engage into a slot in the base of the cable tray.

Power and wire management

Surface mounted plugmold raceway

AutoStrada

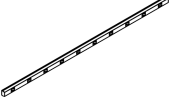
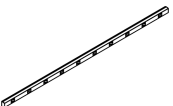
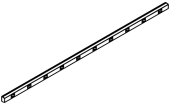
Applied Wall

description	h	w	d	pattern no.	aluminum
Plugmold, single circuit (3 wire, grey outlets) 	1 1/2"	60"	1 1/8"	AAWS RPM1 05 ()	\$428.
Plugmold, two circuits (4 wire, grey outlets shared neutral and ground) 	1 1/2"	60"	1 1/8"	AAWS RPM2 05 ()	536.
Plugmold, isolated (6 wire, gray + orange outlets independent neutral and ground) 	1 1/2"	60"	1 1/8"	AAWS RPM2I 05 ()	536.
Plugstrip, two circuits (4 wire, grey + orange outlets shared neutral and ground) 	1 1/2"	28"	1 1/8"	AAWS RPM2 02 ()	261.

Order Code

Example:	AAWS RPM1 05 AA
A	AutoStrada
AWS	Applied Wall System
RPM1	Plugmold raceway, one circuit
05	width
AA	Finish, Aluminum

Specification Information

AA - Aluminum only available finish.

Plugmold is 60" wide with outlets every 6" (ten simplex outlets total).

Plugstrip is 28" wide with outlets every 3" (eight outlets total).





Application

Plugmold is surface mounted raceway for one or two circuits. Plugmold includes ten simplex outlets, anodized aluminum covers and end caps. Plugmold may be linked or trimmed to length on site.

Plugstrip includes eight simplex outlets.

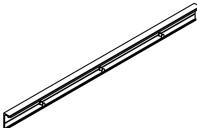
Plugstrip mounts to 30" or wider recess cover.

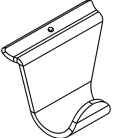
Power supply must be made by an electrical contractor, including hardwire connection from junction box in building to back side of plugmold raceway. Typically contractor punches a hole for connection through a recess cover positioned just above a junction box in the building wall.

description	h	w	d	pattern no.	list	paint painted or aluminum	black or AA only
Marker tray 	3/4"	24"	2 1/2"	AAWS MT24 ()		\$66.	
	3/4"	30"	2 1/2"	AAWS MT30 ()		72.	
	3/4"	36"	2 1/2"	AAWS MT36 ()		77.	
	3/4"	42"	2 1/2"	AAWS MT42 ()		82.	
	3/4"	48"	2 1/2"	AAWS MT48 ()		87.	
	3/4"	54"	2 1/2"	AAWS MT54 ()		111.	
	3/4"	60"	2 1/2"	AAWS MT60 ()		120.	
	3/4"	66"	2 1/2"	AAWS MT66 ()		126.	
	3/4"	72"	2 1/2"	AAWS MT72 ()		132.	
Easel pad holder 	2"	28"	1 1/8"	AAWS EASEL ()			101.
Picture hook 	1"	1 1/4"	1"	AAWS PH ()			22.
Coat hook 	2"	2 1/2"	1 1/2"	AAWS CH ()			22.
Wire manager clips (10/pk) 	3/4"	3/8"	3/4"	AAWS WMC	12.		
Cable grommet (10/pk) 	1 1/4"		1 1/4"	AAWS CG	10.		

Order Code

Example:	AAWS MT24 AA
A	AutoStrada
AWS	Applied wall system
MT	Marker tray
24	Width
AA	Finish

Specification Information

- Markertray is available in AA anodized aluminum or any standard painted finish except 613 Silver.
- Easel pad holder is available in AA anodized aluminum or 111 black only.
- Picture hook and Coat hook are available in all standard painted finishes.
- Wire manager clips are easy grey plastic.
- Cable grommets are black plastic.

Application Notes

Applied wall system accessories include integral bracket detail that engages into top or intermediate channels at any point.

Easel pad holder includes three studs to hang standard 27"x34" easel pads on inside and outside face of bracket.

Wire manager clips may be used for horizontal or vertical wire management of lamp cords on the face of the applied wall.



Cable grommet is 1 1/4" diameter trim ring for 1" diameter hole which may be punched in recess covers to route data/communications cables from inside of applied wall to the surface.

Service Wall frames

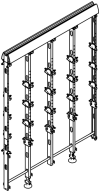
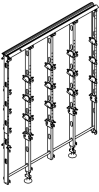

Standard and compact crown

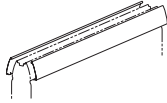
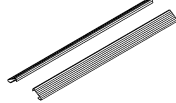
description	type	w	d	h	pattern number	black	list
 Wall frame, standard crown	39"H	48"	5"	43"	APF1 3948	\$540.	
		60"	5"	43"	APF1 3960	621.	
		72"	5"	43"	APF1 3972	770.	
	48"H	48"	5"	52"	APF1 4848	595.	
		60"	5"	52"	APF1 4860	680.	
		72"	5"	52"	APF1 4872	849.	
	64"H	48"	5"	68"	APF1 6448	707.	
		60"	5"	68"	APF1 6460	809.	
		72"	5"	68"	APF1 6472	1,013.	
 Wall frame, compact crown	39"H	48"	5"	40"	APFA1 3948	433.	
		60"	5"	40"	APFA1 3960	497.	
		72"	5"	40"	APFA1 3972	613.	
	48"H	48"	5"	49"	APFA1 4848	474.	
		60"	5"	49"	APFA1 4860	543.	
		72"	5"	49"	APFA1 4872	679.	
	64"H	48"	5"	65"	APFA1 6448	566.	
		60"	5"	65"	APFA1 6460	646.	
		72"	5"	65"	APFA1 6472	809.	
Acoustical inserts	39"H		2"	34"	APA 39		31.
	48"H		2"	43"	APA 48		37.
	64"H		2"	59"	APA 64		50.

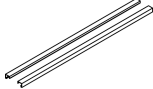
Order Code	Specification Information	Application
Example: APFA1 3948	Wall frame pattern numbers begin with APF (standard crown) and APFA (compact crown) prefixes.	Service Wall frames are the structural component of spine-based planning. Specify frames in any combination of widths to create the overall wall length required.
APF Spine frame		Crown is bored to accept stackable add-up panels at 3" increments.
A compact crown		Service Wall frames include two levelling feet with 2" travel, 12" from each side edge.
1 Generation	<i>Specify:</i>	
39 Height	<i>Fifth position: height</i>	
48 Width	39 39"H	Frames include vertical studs every 12" on center, with cover mounting clips and cable manager inserts on both sides. Frames also include 4"H or 1" top crown with continuous channel for add-up panels. 4"H standard crown frames include shaped crowns for upmounting shelves or overhead storage cabinets, canopy lighting at any point. Compact crown frames feature a slim profile crown with downmounting capability only.
	48 48"H	
	64 64"H	
	<i>Seventh position: width</i>	
	48 48"W	
	60 60"W	
	72 72"W	
	All Service Wall frames include 3" diameter, 2" levelling glides and one set of connectors to adjacent frame or wall connector. Frames are black painted finish.	Acoustical inserts fit between studs in Service Wall frame to increase control of sound transmission. Inserts are bagged in heights corresponding to wall frame. Specify four inserts for 48"W frame, five for 60"W frame, and six for 72"W frame. Service Walls with acoustical inserts have been tested to STC 33. Inserts do not affect the NRC rating of the wall which is .40.
		Specify crown covers, raceway covers, structural base covers, and wall covers for each face of Service Wall frame, and specify power components separately.

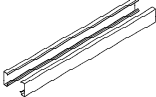
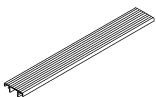
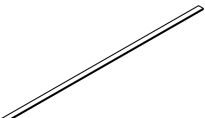

description	type	w	d	h	pattern number	paint	list	anodized alum
Crown covers (pair)	standard 	48"	5"	4"	APT 48 ()		\$38.	
		60"	5"	4"	APT 60 ()		46.	
		72"	5"	4"	APT 72 ()		51.	
		(specify painted finish)						
compact crown, integral color 	48"	5"	1"	APTA 48 ()			60.	
	60"	5"	1"	APTA 60 ()			72.	
	72"	5"	1"	APTA 72 ()			123.	
flat, low profile 	48"	5"	1"	APTL 48 ()		85.		85.
	60"	5"	1"	APTL 60 ()		107.		107.
	72"	5"	1"	APTL 72 ()		129.		129.
	96"	5"	1"	APTL 96 ()		173.		173.
	120"	5"	1"	APTL 120 ()		n/a		215.
(finish default AA, anodized aluminum)								
flat, high profile 	48"	5"	1 1/4"	APTH 48 ()		85.		85.
	60"	5"	1 1/4"	APTH 60 ()		107.		107.
	72"	5"	1 1/4"	APTH 72 ()		129.		129.
	96"	5"	1 1/4"	APTH 96 ()		173.		173.
	120"	5"	1 1/4"	APTH 120 ()		n/a		215.
(finish default AA, anodized aluminum)								

Order Code	Specification Information	Application
Example: APRA 480 AA		
APR A Base trim	Service Wall crown pattern numbers begin with APT- (standard) and APTA- (compact) prefix, then frame width.	Crown, base trim, and structural base covers are required for every wall frame in corresponding widths. Covers are specified in pairs to cover both sides of a frame.
48 Width		
0 Outlet openings	Standard crown covers are available in painted finish. Please specify painted finish from paint options listed on page 8.	Crown top caps are optional fillers for the crown where no add-up panels are planned. Standard crown end caps are included with all connectors. Compact crown end caps must be ordered individually or in kits of 10.
AA Finish	Compact crown covers are available in Integral light grey (812 Easy grey) or dark grey (813 Trim grey) plastic. Flat crown covers are available in clear anodized aluminum or painted finish options listed on page 8 excluding silver. Base trim covers begin with APRA- prefix, then frame width. Base trim covers are available in clear anodized aluminum or painted finish options listed on page 8 excluding silver.	Specify painted finish for standard crown end caps. Specify light grey (812 Easy Grey) or dark grey (813 Trim Grey) integral color for crown top cap and Sloped compact crown end cap.
		Flat crown covers in high profile are designed for 48" h spine to align with attached AutoStrada 49" h panels. In all other applications, specify low profile crown covers. Flat crown end caps in corresponding low or high profile are ordered separately as individual units. Flat crown end caps are required for all connectors except flat ends.

description	type	w	d	h	pattern number	paint	list	anodized alum
 Base trim covers (pair)	no outlets	48"	–	4"	APRA 480 ()	\$145.		\$145.
		60"	–	4"	APRA 600 ()	174.		174.
		72"	–	4"	APRA 720 ()	209.		209.
 Crown top cap	integral color only, plastic	24"	2"	–	APT1 C24 ()		9.	
		36"	2"	–	APT1 C36 ()		17.	
		48"	2"	–	APT1 C48 ()		28.	
		60"	2"	–	APT1 C60 ()		31.	
		72"	2"	–	APT1 C72 ()		38.	
 Crown top cap, metal	default finish AA, anodized aluminum	24"	2"	–	APTA C24 ()	31.		31.
		36"	2"	–	APTA C36 ()	38.		38.
		48"	2"	–	APTA C48 ()	46.		46.
		60"	2"	–	APTA C60 ()	52.		52.
		72"	2"	–	APTA C72 ()	63.		63.
Crown end cap	standard (replacement part)				APT ()		5.	
	 compact				APTA CC1 ()		15.	
	 compact (kit of 10)				APTA CC ()		124.	

Spine and linkable screens

Order Code	Specification Information	Application
Example: APRA 480 AA APR A Base trim 48 Width 0 Outlet openings AA Finish	<p>Service Wall crown pattern numbers begin with APT- (standard) and APTA- (compact) prefix, then frame width.</p> <p>Standard crown covers are available in painted finish. Please specify painted finish from paint options listed on page 8.</p> <p>Compact crown covers are available in Integral light grey (812 Easy grey) or dark grey (813 Trim grey) plastic.</p> <p>Flat crown covers are available in clear anodized aluminum or painted finish options listed on page 8 excluding silver.</p> <p>Base trim covers begin with APRA- prefix, then frame width. Base trim covers are available in clear anodized aluminum or painted finish options listed on page 8 excluding silver.</p>	<p>Crown, base trim, and structural base covers are required for every wall frame in corresponding widths. Covers are specified in pairs to cover both sides of a frame.</p> <p>Crown top caps are optional fillers for the crown where no add-up panels are planned. Standard crown end caps are included with all connectors. Compact crown end caps must be ordered individually or in kits of 10.</p> <p>Specify painted finish for standard crown end caps.</p> <p>Specify light grey (812 Easy Grey) or dark grey (813 Trim Grey) integral color for crown top cap and Sloped compact crown end cap.</p>
		<p>Flat crown covers in high profile are designed for 48" h spine to align with attached AutoStrada 49" h panels. In all other applications, specify low profile crown covers.</p> <p>Flat crown end caps in corresponding low or high profile are ordered separately as individual units.</p> <p>Flat crown end caps are required for all connectors except flat ends.</p>

description	type	w	d	h	pattern number	paint	list	anodized alum
Crown end cap, metal	flat, low profile				APTL ()		\$36.	
					specify painted finish			
	flat, high profile				APTH ()		\$36.	
					specify painted finish			

Order Code	Specification Information	Application
Example: APRA 480 AA		
APR A Base trim	Service Wall crown pattern numbers begin with APT- (standard) and APTA- (compact) prefix, then frame width.	Crown, base trim, and structural base covers are required for every wall frame in corresponding widths. Covers are specified in pairs to cover both sides of a frame.
48 Width		
0 Outlet openings	Standard crown covers are available in painted finish. Please specify painted finish from paint options listed on page 8.	Crown top caps are optional fillers for the crown where no add-up panels are planned. Standard crown end caps are included with all connectors. Compact crown end caps must be ordered individually or in kits of 10.
AA Finish	Compact crown covers are available in Integral light grey (812 Easy grey) or dark grey (813 Trim grey) plastic. Flat crown covers are available in clear anodized aluminum or painted finish options listed on page 8 excluding silver. Base trim covers begin with APRA- prefix, then frame width. Base trim covers are available in clear anodized aluminum or painted finish options listed on page 8 excluding silver.	Specify painted finish for standard crown end caps. Specify light grey (812 Easy Grey) or dark grey (813 Trim Grey) integral color for crown top cap and Sloped compact crown end cap.

Structural base cover kits

Painted steel surface (pair)

description	type	width	depth	height	pattern number	paint
Structural base covers (pair)	painted steel	48"	1"	16"	APCA AZ48S()	\$288.
		60"	1"	16"	APCA AZ60S()	335.
		72"	1"	16"	APCA AZ72S()	396.

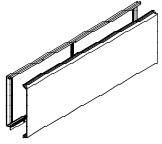

Order Code

Example:	APCA AZ48S 118
APCA	Autostrada wall cover
AZ	Attachment zone
48	Width
S	Steel
118	Finish

Specification Information

Structural base cover kit pattern numbers begin with APCA AZ prefix, then cover width.

Starting at tenth position specify paint finish

Please specify painted finish for structural base covers from paint options listed on page 8.

Application Notes

Structural base covers are required for every wall frame in corresponding widths. Covers are specified in pairs to cover both sides of a frame.

Structural base covers bolt to each side of the wall frame up to 21"H for structure and continuous attachment capability.

Structural base cover kits

Veneer and laminate surface (pair)

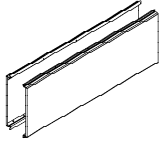

description	type	width	depth	height	pattern number	L	V1	V2	V3
Structural base covers (pair)	anodized aluminum or painted trim	48"	1"	16"	APCA AZ48 () ()	\$817.	\$920.	\$999.	\$1,358.
		60"	1"	16"	APCA AZ60 () ()	902.	1,005.	1,098.	1,537.
		72"	1"	16"	APCA AZ72 () ()	938.	1,028.	1,153.	1,673.



Order Code	Specification Information	Application Notes
Example: APCA AZ48 V312 AA		
APCA AutoStrada wall cover	Structural base cover kit pattern numbers begin with APCA AZ prefix, then cover width.	Structural base covers are required for every Service Wall frame in corresponding widths. Covers are specified in pairs to cover both sides of a Service Wall.
AZ Attachment zone	Starting at ninth position specify laminate, veneer or techwood finish	
48 Width	Product on this page will accept wood grain laminate where laminate is currently an option.	Structural base covers bolt to each side of the Service Wall frame up to 21"H for structure and continuous attachment capability.
V312 Cover finish	Laminate and veneer covers have an anodized aluminum or painted trim at the top and bottom of each cover. Painted finish options listed on page 8 excluding silver.	
AA Trim finish		

Access covers

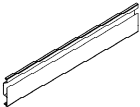
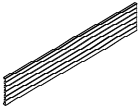
Slatwall, cable tray and outlets covers

description	height	depth	width	pattern number	list	textured
9"H cable tray covers 	9"	1"	12"	APCA 0912 C ()	\$82.	
		1"	24"	APCA 0924 C ()	99.	
		1"	36"	APCA 0936 C ()	113.	
		1"	48"	APCA 0948 C ()	149.	
		1"	60"	APCA 0960 C ()	190.	
		1"	72"	APCA 0972 C ()	231.	
9"H slatwall covers 	9"	1"	12"	APCA 0912 S ()	72.	
		1"	24"	APCA 0924 S ()	84.	
		1"	36"	APCA 0936 S ()	101.	
		1"	48"	APCA 0948 S ()	130.	
		1"	60"	APCA 0960 S ()	165.	
		1"	72"	APCA 0972 S ()	201.	
Outlets cover 	9"	1"	12"	APCA OC () ()		81.

Order Code

Example:	APCA 0948C AA
APCA	Autostrada wall cover
09	Height
48	Width
C	Type
AA	Finish

Specification Information

Cable tray and slatwall covers are aluminum with an anodized or painted finish.

Outlets covers are painted plastic with anodized aluminum or painted extrusion on the top and bottom.

Please specify painted finish for outlets cover face from paint options listed on page 8.

Application Notes

Cable tray mounts from 21" - 30" only on any Service Wall frame. Adjacent trays form continuous, easily accessible cable management at worksurface or table height. Shorter segments provide local cable management below outlet modules. Covers may span across a straight Service Wall frame connection.

Bottom half of cable tray cover permits cables to be managed on surface of studs with one cable holder (55 CAT5 cables) or two clips (28 cables).

Slatwall supports KnollExtra task lights, monitor arms, paper trays, file holders and other accessories.

Slatwall covers will support flat panel monitor arms with varying weight limitations based on mounting and application. Please refer to the KnollExtra price list for comprehensive mounting and weight limitation information by application.

Locate outlets covers on Service Wall frames before specifying other Service Wall covers.

Outlets cover mounts between 21" and 30" (below standard desk height), 30" - 39" (above desk height) or 39" - 48" on Service Wall frame.

Outlets cover is 12" wide, and mounts anywhere on Service Wall frame between 21" and 48" above the floor. Outlets cover corresponds to power components (specified separately) mounted on Service Wall frame.

Outlets covers have four openings for power or PDC outlets. Specify outlet fillers for unused outlet openings in cover.

Access covers

Hardwire outlets and covers

description	height	depth	width	pattern number	list
Hardwire outlets cover	9"	1"	12"	APCA HOC () ()	\$79.

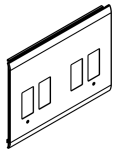

Hardwire outlet box, desk height				AR1 HOB	220.
				AR1 HOB2	291.

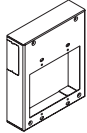

Order Code	Specification Information	Application Notes
Example: APCA HOC 613 AA		
APCA AutoStrada wall cover	Hardwire outlets covers are painted steel with anodized aluminum or painted extrusion top and bottom.	For hardwire power applications (required in City of Chicago) specify hardwire outlets cover and hardwire outlets box, instead of standard outlets covers and modular power components. Do not specify cable tray covers at same level as hardwire power.
H Hardwire	Please specify painted finish for outlets cover face from paint options listed on page 8.	Hardwire outlet box accepts two Decora-style duplex outlets, and includes mounting brackets for one face of Service Wall between 21" and 48"H. Two quad hardwire outlet box accepts four duplex outlets on one face.
OC Outlets cover	Painted finish option for hardwire outlets cover trim listed on page 8 excluding silver.	Outlet boxes include openings to permit continuous lay-in wiring with Wiremold® raceway. Electrical contractor supplies infeed cable, Wiremold 2400®, and duplex outlets. Outlet boxes can be planned back to back, with distribution on one side of Service Wall.
613 Cover Finish		NOTE: Currents cable tray access covers and all AutoStrada access covers cannot be used in the same 9"H zone as the Wiremold raceway as the Wiremold will not fit behind the covers.
AA Trim Finish		Outlets covers have four openings for power or PDC outlets. Specify outlet fillers for unused outlet openings in cover.

Access covers

Integral shelf

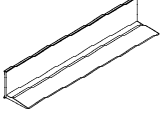
description	height	width of shelf	pattern number	list	L	V1	V2	V3
Integral shelf covers 	9"	21"	APSA 0921 ()()		\$627.	\$691.	\$704.	\$751.
		24"	APSA 0924 ()()		627.	691.	704.	751.
		33"	APSA 0933 ()()		711.	777.	791.	857.
		36"	APSA 0936 ()()		711.	777.	791.	857.
		45"	APSA 0945 ()()		762.	832.	852.	934.
		48"	APSA 0948 ()()		762.	832.	852.	934.
		57"	APSA 0957 ()()		843.	916.	937.	1,035.
		60"	APSA 0960 ()()		843.	916.	937.	1,035.
		69"	APSA 0969 ()()		907.	983.	1,006.	1,121.
	72"	APSA 0972 ()()		907.	983.	1,006.	1,121.	
	16"	21"	APSA 1621 ()()		642.	702.	720.	799.
		24"	APSA 1624 ()()		642.	702.	720.	799.
		33"	APSA 1633 ()()		722.	788.	813.	922.
		36"	APSA 1636 ()()		722.	788.	813.	922.
		45"	APSA 1645 ()()		784.	854.	880.	1,021.
		48"	APSA 1648 ()()		784.	854.	880.	1,021.
		57"	APSA 1657 ()()		869.	942.	974.	1,148.
		60"	APSA 1660 ()()		869.	942.	974.	1,148.
		69"	APSA 1669 ()()		935.	1,011.	1,048.	1,250.
72"		APSA 1672 ()()		935.	1,011.	1,048.	1,250.	

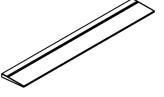
Integral shelves 	21"	ADS 0821 ()	368.
	24"	ADS 0824 ()	368.
	33"	ADS 0833 ()	421.
	36"	ADS 0836 ()	421.
	45"	ADS 0845 ()	465.
	48"	ADS 0848 ()	465.
	57"	ADS 0857 ()	522.
	60"	ADS 0860 ()	522.
	69"	ADS 0869 ()	568.
72"	ADS 0872 ()	568.	

Order Code	Specification Information	Application Notes
Example: APSA 0948 118 AA		
APSA Autostrada integral shelf cover	Please specify laminate, V1, V2 or V3 finish for Service Wall cover from finish options listed on page 8.	Service Wall covers enclose frames between 21"H and the top crown. Covers may be specified in any combination of widths corresponding to the total Service Wall length. Covers may span across a straight Service Wall frame connection.
09 Height	Product on this page will accept wood grain laminate where laminate is currently an option.	Integral shelves may be added to any laminate, marker or veneer spine cover. Holes for fasteners must be drilled through bottom extrusion and cover on site.
48 Width	Shelf is extruded aluminum with an anodized or painted finish.	
118 Cover Ffinish	Painted finish option for integral shelf cover trim and integral shelf listed on page 8excluding silver.	
AA Shelf and Trim Finish		The integral shelf cover features a full width 8" deep display shelf crafted in anodized or painted aluminum. The cover is also available with a shelf that is 3" less wide than full module to accommodate a panel connected to the Service Wall.

Access covers
Laminate, marker and veneer

description	height	width	pattern number	L	V1	V2	V3
Access covers 	9"	12"	APCA 0912 () ()	\$293.	\$344.	\$359.	\$397.
		24"	APCA 0924 () ()	310.	362.	379.	453.
		36"	APCA 0936 () ()	343.	394.	418.	518.
		48"	APCA 0948 () ()	356.	408.	437.	563.
		60"	APCA 0960 () ()	384.	437.	474.	628.
		72"	APCA 0972 () ()	402.	459.	496.	678.
	16"	12"	APCA 1612 () ()	298.	352.	372.	441.
		24"	APCA 1624 () ()	323.	375.	402.	524.
		36"	APCA 1636 () ()	359.	411.	448.	614.
		48"	APCA 1648 () ()	379.	430.	475.	691.
		60"	APCA 1660 () ()	419.	470.	523.	786.
		72"	APCA 1672 () ()	441.	493.	555.	866.
	18"	12"	APCA 1812 () ()	303.	353.	373.	451.
		24"	APCA 1824 () ()	330.	378.	409.	545.
		36"	APCA 1836 () ()	363.	415.	456.	645.
		48"	APCA 1848 () ()	389.	440.	489.	729.
		60"	APCA 1860 () ()	426.	476.	534.	831.
		72"	APCA 1872 () ()	452.	508.	573.	924.
	27"	12"	APCA 2712 () ()	313.	368.	390.	508.
		24"	APCA 2724 () ()	346.	401.	440.	635.
		36"	APCA 2736 () ()	396.	451.	506.	781.
48"		APCA 2748 () ()	425.	477.	542.	896.	
60"		APCA 2760 () ()	473.	526.	605.	1,042.	
72"		APCA 2772 () ()	506.	558.	649.	1,167.	

Order Code

Example:	APCA 0948 V312 AA
APCA	Autostrada wall cover
09	Height
48	Width
V312	Cover Finish
AA	Trim Finish

Specification Information

Please specify laminate, V1, V2 or V3 finish for access covers from finish options listed on page 8.

Product on this page will accept wood grain laminate where laminate is currently an option.

Specify finish code: LW for markerboard surface.

Painted finish option for trim listed on page 8 excluding silver.

Application Notes

Service Wall covers enclose frames between 21"H and the top crown. Covers may be specified in any combination of widths corresponding to the total Service Wall length. Covers may span across a straight Service Wall frame connection.

For active surfaces with access to cables and power/data/communications outlets, specify 9" and 16"H segmented covers as described in Specification Information.

Access covers

Tackable upholstered

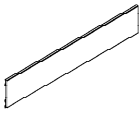



description	height	depth	width	pattern number	10	15	20	30	35	40	45	50	55
Access covers 	9"	1"	12"	APCA 0912 A () ()	\$123.	\$125.	\$126.	\$130.	\$134.	\$138.	\$142.	\$149.	\$157.
		1"	24"	APCA 0924 A () ()	150.	152.	153.	157.	159.	165.	166.	171.	184.
		1"	36"	APCA 0936 A () ()	166.	170.	171.	177.	179.	183.	184.	188.	199.
		1"	48"	APCA 0948 A () ()	187.	191.	192.	194.	199.	201.	202.	210.	220.
		1"	60"	APCA 0960 A () ()	201.	204.	209.	212.	216.	220.	224.	226.	237.
		1"	72"	APCA 0972 A () ()	n/a	225.	n/a	n/a	n/a	n/a	n/a	n/a	n/a
	16"	1"	12"	APCA 1612 A () ()	132.	137.	139.	149.	154.	158.	165.	174.	194.
		1"	24"	APCA 1624 A () ()	170.	177.	178.	187.	194.	200.	202.	215.	237.
		1"	36"	APCA 1636 A () ()	188.	194.	198.	204.	215.	220.	225.	234.	258.
		1"	48"	APCA 1648 A () ()	211.	217.	219.	228.	236.	241.	244.	256.	279.
		1"	60"	APCA 1660 A () ()	231.	236.	237.	246.	255.	263.	266.	276.	298.
		1"	72"	APCA 1672 A () ()	n/a	256.	n/a	n/a	n/a	n/a	n/a	n/a	n/a
	18"	1"	12"	APCA 1812 A () ()	147.	151.	153.	164.	170.	178.	181.	191.	215.
		1"	24"	APCA 1824 A () ()	172.	178.	181.	191.	198.	202.	209.	217.	240.
		1"	36"	APCA 1836 A () ()	192.	198.	200.	210.	217.	225.	227.	236.	261.
		1"	48"	APCA 1848 A () ()	235.	238.	241.	253.	259.	267.	268.	279.	305.
		1"	60"	APCA 1860 A () ()	235.	238.	241.	253.	259.	267.	268.	279.	305.
		1"	72"	APCA 1872 A () ()	n/a	261.	n/a	n/a	n/a	n/a	n/a	n/a	n/a
27"	1"	12"	APCA 2712 A () ()	165.	173.	178.	192.	201.	212.	217.	233.	267.	
	1"	24"	APCA 2724 A () ()	193.	201.	209.	220.	233.	241.	244.	261.	296.	
	1"	36"	APCA 2736 A () ()	216.	226.	231.	241.	255.	266.	268.	283.	320.	
	1"	48"	APCA 2748 A () ()	240.	250.	256.	268.	279.	288.	293.	309.	344.	
	1"	60"	APCA 2760 A () ()	265.	275.	277.	291.	304.	311.	317.	331.	365.	
	1"	72"	APCA 2772 A () ()	n/a	293.	n/a	n/a	n/a	n/a	n/a	n/a	n/a	

Spine and linkable screens

Order Code	Specification Information	Application Notes
Example: APCA 0948A W210 AA APCA Autostrada wall cover 09 Height 48 Width A Surface type W210 Fabric AA Trim Finish	<p>For active face of 39"H Service Wall frame, specify two 9"H covers. For passive face (along corridor or wall) specify one 18" cover.</p> <p>For active face of 48"H Service Wall frame, specify three 9"H covers or one 9"H and one 18"H cover. For passive face, specify 27"H cover.</p> <p>For active face of 64"H Service Wall frame, specify three 9"H covers and one 16"H cover or one 9"H, one 18"H, and one 16"H cover. For passive face, specify one 27" and one 16"H cover.</p> <p>For full fabric surface between 5" and 21", order upholstered attachment zone cover.</p> <p>Surface type: A tackable upholstered</p>	<p>Tackable upholstered Service Wall covers enclose Service Wall frames between 21" and the top crown. Covers incorporate a tackable, acoustical core in the same outward profile as other upholstered covers. Specify widths corresponding to Service Wall frame width, or in any 12" increment to accommodate 12"W outlets covers or slatwall covers. Covers may span across a straight Service Wall frame connection. For active surfaces with access to cables and power/data/communications outlets, specify 9" and 16"H segmented covers as described in Specification Information.</p> <p>For passive Service Wall surfaces (corridors or conference areas) specify 18"H or 27"H covers in place of two or three 9"H covers.</p> <p>18"H covers may also be specified above 9"H covers including outlets covers below desk height on 48" or 64"H Service Walls.</p> <p>Service Wall with upholstered tackable covers has been tested to NRC .40 and STC 22.</p> <p>When ordering 60" or wider covers, please check width of fabric specified.</p>

Spine ends and connectors





Flat ends

description	type	height	depth	pattern no.	painting
Flat end	 standard crown	39"	5"	AX1A F39 () ()	\$118.
		48"	5"	AX1A F48 () ()	134.
		64"	5"	AX1A F64 () ()	149.
	 compact crown	39"	5"	AX1A C39 ()	118.
		48"	5"	AX1A C48 ()	134.
		64"	5"	AX1A C64 ()	149.
	 low profile flat crown	39"	5"	AX1A EL39 ()	118.
		48"	5"	AX1A EL48 ()	134.
		64"	5"	AX1A EL64 ()	147.
 high profile flat crown	39"	5"	AX1A EH39 ()	118.	
	48"	5"	AX1A EH48 ()	134.	
	64"	5"	AX1A EH64 ()	147.	

Order Code	Specification Information	Application Notes
Example: AX1A C48 118	For flat ends specify:	Flat end finishes end of corresponding height Service Wall when end of Service Wall is supported by outriggers or perpendicular screens or panels. Flat ends include end cover for compact crown or standard crown, as specified.
AX1A AutoStrada connector	<i>Starting seventh position:</i> painted finish for outside trim cover and raceway cover	High-low straight connectors join Service Wall of different heights in a straight line.
C Type	<i>Starting eleventh position:</i> painted finish for crown end cap	Straight connector is replacement hardware kit to join Service Wall frames of the same height end to end. Kit includes four barrel-shape connectors and hardware.
48 Height	Please specify painted finishes from paint finish options listed on page 8.	
118 vertical cover finish		

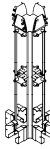
Spine ends and connectors

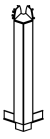
Corner, T, X, V and Y connections

description	type	height	width	depth	pattern number	list
90° connector	 T connector	39"	6"	7"	AX1A T39 () ()	\$383.
		48"	6"	7"	AX1A T48 () ()	460.
		64"	6"	7"	AX1A T64 () ()	538.
	 X connector	39"	7"	7"	AX1A X39 ()	383.
		48"	7"	7"	AX1A X48 ()	418.
		64"	7"	7"	AX1A X64 ()	460.
	 L connector	39"	6"	6"	AX1A L39 () ()	383.
		48"	6"	6"	AX1A L48 () ()	460.
		64"	6"	6"	AX1A L64 () ()	538.
120° connector	 V connector	39"	5 1/2"	5 1/2"	AX1A V39 () ()	383.
		48"	5 1/2"	5 1/2"	AX1A V48 () ()	460.
		64"	5 1/2"	5 1/2"	AX1A V64 () ()	538.
	 Y connector	39"	6 1/2"	5 1/2"	AX1A Y39 () ()	383.
		48"	6 1/2"	5 1/2"	AX1A Y48 () ()	460.
		64"	6 1/2"	5 1/2"	AX1A Y64 () ()	538.

Order Code

Example:	AX1A L48 118
AX1A	AutoStrada connector
L	Type
48	Height
118	vertical cover finish

Specification Information

For L, T, V and Y connectors specify:

Seventh position:
painted finish for vertical trim cover and raceway cover

Eighth position, and X connectors:
painted finish for top cap and standard crown end caps

Please specify painted finish as applicable from paint options listed on page 8.

Application Notes

L, T, and X connectors join Service Wall frames at 90° angles and include vertical trim covers, top cap and standard crown end caps, and one spare set of straight connectors.

When ordering connectors for the Service Wall with compact crown, specify crown end caps separately.

V and Y connectors join Service Wall frames at 120° angles and include vertical trim covers, topcap and standard crown end caps.

Spine ends and connectors

Outriggers and spine starters

description	type	height	width	depth	pattern number	list
Outrigger 	deep	21"	3"	15"	AA1ORD()	\$181.
	standard	21"	3"	8"	AA1OR()	132.
Service Wall starter	39"	39"		2"	AX1 SWS39 ()	118.
	48"	48"		2"	AX1 SWS48 ()	132.
	64"	64"		2"	AX1 SWS64 ()	151.
Straight connector kit (replacement)		–	–	–	AX1 S	24.
High low straight connector for spine with standard crown only	48 - 39"	48"		5"	AX1 HLS4839 ()()	209.
	64 - 39"	64"		5"	AX1 HLS6439 ()()	354.
	64 - 48"	64"		5"	AX1 HLS6448 ()()	238.

Order Code

Example: AA1 ORD 118
AA1 Accessory
ORD Outrigger deep
118 Finish

Specification Information



Please specify painted finish as applicable from finish options listed on page 8.

Application Notes

Outrigger connects to structural base cover at any point. Outriggers (or perpendicular systems panels) are required every 8' and adjacent to flat end for adequate support. Specify deep outriggers when cantilevering 24"D worksurfaces without adjacent perpendicular systems panels or spine wall connectors.

Service Wall starter connects Service Wall to building wall.

Spine end connectors for linkable screens and Morrison panels

description	application	h	w	d	pattern no.	list
 Spine end connector	39" h spine	39"	5"	1/2"	AX1SEC3939 () () ()	\$253.
	48" h spine	48"	5"	1/2"	AX1SEC4848 () () ()	265.
	64" h spine	64"	5"	1/2"	AX1SEC6464 () () ()	317.
Spine end connector to top of compact 1" h crown	39" h spine	40"	5"	1/2"	AX1SEC4039 L () ()	253.
	48" h spine	49"	5"	1/2"	AX1SEC4948 L () ()	265.
	64" h spine	65"	5"	1/2"	AX1SEC6564 L () ()	317.
 Spine end connector to top of Currents 4" h crown	39" h spine	43"	5"	1/2"	AX1SEC4339 C () ()	253.
	48" h spine	52"	5"	1/2"	AX1SEC5248 C () ()	265.
	64" h spine	68"	5"	1/2"	AX1SEC6864 C () ()	317.
Inside base trim cover for Currents raceway		4"	5"		AX1SECBT ()	50.

Order Code	Specification Information	Application Notes
Example: AX1 SEC 3939 L 613 613 812 AX1 Spine connector SEC Type 39 Connector height 39 Spine height L Crown type 613 Crown end cap finish 613 Vertical cover finish 812 Top cap finish	For spine end connectors specify: 1.Crown type C=Currents standard 4" h L=low profile flat 1" H=high profile flat 1 1/4" F=compact crown 1" 2.Crown end cap finish Standard, low and high profile flat and compact crown end caps are available in all standard paint finishes and 813 Trim Grey. Compact crown end caps are also available in 812 Easy Grey. 3.Vertical cover finish: All standard paint finishes 4.Top cap for vertical cover: 812=Easy Grey 813=Trim Grey And all standard paint finishes Spine end connectors on this page align with spine base covers ^{13/16"} above the floor.	Spine end connectors are complete vertical cover and top trim for the end of an AutoStrada or Currents spine. Side edges of end connectors accept end starters for linkable screens and other systems panels of the same height or lower. Spine end connectors include painted aluminum cover with beveled top cap and the specified flat, compact, or standard crown end cap. Spine end connectors to top of compact crown are a visual alternative that replaces the crown end cap with a taller aluminum end cover and flat top cap. Spine end connectors to top of Currents crown are recommended when attaching any end started panel that is between the nominal height of the spine and the actual height with crown, such as 42" h panel to 39" h spine with 4" h crown. Spine end connectors to top of Currents crown enclose the end of spine and standard crown and include flat top cap and inside top trim cover.

Spine ends and connectors
*High-low spine end connectors
 for linkable screens and Morrison panels*

description	application	h	w	d	pattern no.	list
	42" h panel/39" h spine	39"	5"	1/2"	AX1SEC4239 () ()	\$253.
	48" h panel/39" h spine	48"	5"	1/2"	AX1SEC4839 () ()	265.
	56" h panel/39" h spine	56"	5"	1/2"	AX1SEC5639 () ()	305.
	64" h panel/39" h spine	64"	5"	1/2"	AX1SEC6439 () ()	317.
	56" h panel/48" h spine	56"	5"	1/2"	AX1SEC5648 () ()	305.
	64" h panel/48" h spine	64"	5"	1/2"	AX1SEC6448 () ()	317.
	80" h panel/48" h spine	80"	5"	1/2"	AX1SEC8048 () ()	482.
	80" h panel/64" h spine	80"	5"	1/2"	AX1SEC8064 () ()	461.
Inside base trim cover for Currents raceway		4"	5"		AX1SECBT ()	50.

Order Code	Specification Information	Application Notes
Example: AX1 SEC 6448 613 812 AX1 Spine connector SEC Type 64 Panel height 48 Spine height 613 Painted finish 613 Trim finish	For spine end connectors specify: 1. Vertical cover finish: All standard paint finishes 2. Top cap for vertical cover 812=Easy Grey 813=Trim Grey And all standard painted finishes Spine end connectors on this page align with spine base covers ¹³ / ₁₆ " above the floor.	High low spine end connectors are complete end cover and trim for an AutoStrada or Currents spine, when attached panels are taller than the spine. High low spine end connectors match the height of the attached linkable screen or Morrison panel. Side edges of spine end connectors accept end starters for linkable screens and Morrison panels of the same height or lower. High low spine end connectors include painted aluminum outside cover with flat top cap and inside cover over the end of the spine. Inside base trim for Currents raceway is recommended to finish inside of any spine end connector when combined with standard Currents recessed base raceway covers. Base trim is not required with AutoStrada spine base covers.

Note: 42" h panel/39" h spine combination (AX1SEC4239) can only be specified with compact or flat crown versions of the spine. For combination of 39" h spine with standard 4" h crown and 42" h panels specify AX1SEC4339C () ().

Spine end connectors for AutoStrada and Reff panels and Gallery screens

Spine and linkable screens

description	application	h	w	d	pattern no.	list
Spine end connector	34" panel or 39" screen/39"h spine	39"	5"	1/2"	AX1SEA3939 () () ()	\$253.
	34"-42" panel or 39"-49" screen/48"h spine	48"	5"	1/2"	AX1SEA4848 () () ()	265.
	34"-49" panel or screen/64"h spine	64"	5"	1/2"	AX1SEA4964 () () ()	317.
	42" panel/39"h spine + 1 1/4" crown	42"	5"	1/2"	AX1SEA4239 () ()	253.
	42" panel/39"h spine + 4" crown	43"	5"	1/2"	AX1SEA4339 C () ()	253.
	49" panel /39" spine	49"	5"	1/2"	AX1SEA4939 () ()	265.
	49" panel or screen/48"h spine + 1 1/4" crown	49"	5"	1/2"	AX1SEA4948 () ()	279.
	49" panel or screen/48"h spine + 4" crown	52"	5"	1/2"	AX1SEA5248 C () ()	265.
	64" panel/39"h spine	64"	5"	1/2"	AX1SEA6439 () ()	317.
	64" panel/48"h spine	64"	5"	1/2"	AX1SEA6448 () ()	317.
	64" panel/64"h spine + 1 1/4" crown	65"	5"	1/2"	AX1SEA6464 () ()	317.
	64" panel/64"h spine + 4" crown	68"	5"	1/2"	AX1SEA6864 C () ()	317.
	79" panel/48"h spine	79"	5"	1/2"	AX1SEA7948 () ()	482.
79" panel/64"h spine	79"	5"	1/2"	AX1SEA7964 () ()	461.	
Inside base trim cover for Currents raceway		4"	5"		AX1SECBT ()	50.

Order Code	Specification Information	Application Notes
Example: AX1 SEA 4239 613 613 812	<p>For spine end connectors when panels are lower than spine specify crown type and finish for crown end cap.</p> <p>1. Crown type: C=Currents standard 4"h L=low profile flat 1"h H=high profile flat 1 1/4"h F=compact 1"h</p> <p>2. All crown end caps are available in all painted finishes.</p> <p>For all spine end connectors specify vertical cover and top trim finish.</p> <p>3. Vertical cover finish: All standard paint finishes</p> <p>4. Top trim for vertical cover: 812=Easy Grey 813=Trim Grey And all standard paint finishes</p> <p>End connectors on this page begin 1/2" above floor.</p>	<p>Spine end connectors are complete end cover and trim for an AutoStrada or Currents spine. Side edges of spine end connectors accept end starters for AutoStrada or Reff panels or Gallery screens.</p> <p>In most cases spine end connectors match the height of the attached panel. When attached panel is lower than the spine, the spine end connector is as high as the nominal height of the spine and the crown requires an end cap.</p> <p>When attached panel is between the nominal height of the spine and the top of the Currents 4"h crown, spine end connector must cover the entire height of the spine with crown.</p> <p>Spine end connectors include painted outside cover with flat top cap and inside cover (where applicable) over the end of the spine.</p> <p>Inside base trim for Currents raceway is recommended to finish inside when combined with standard Currents recessed base raceway covers. Base trim is not required with AutoStrada spine base covers.</p>
AX1 Spine connector		
SEA Type		
42 Panel height		
39 Spine height		
613 Painted finish		
613 Trim finish		
812 Top trim finish		

Spine end connectors for Dividends Horizon panels and screens

description	application	h	w	d	pattern no.	list
Spine end connector	36" h panel/39" h spine	39"	5"	1/2"	AX1SED3939 () () ()	\$253.
	36" h-42" h panel/ 48" h spine	48"	5"	1/2"	AX1SED4848 () () ()	265.
	36" h-64" h panel/ 64" h spine	64"	5"	1/2"	AX1SED6464 () () ()	317.
	42" h panel/ 39" h spine + 1" crown	42"	5"	1/2"	AX1SED4239 () ()	253.
	42" h panel/ 39" h spine + 4" crown	43"	5"	1/2"	AX1SED4339C () ()	253.
	50" h panel/ 39" h spine	50"	5"	1/2"	AX1SED5039 () ()	265.
	50" h panel/ 48" h spine + 1" crown	50"	5"	1/2"	AX1SED5048 () ()	279.
	50" h panel/ 48" h spine + 4" crown	52"	5"	1/2"	AX1SED5248C () ()	265.
	57" h panel/ 39" h spine	57"	5"	1/2"	AX1SED5739 () ()	305.
	57" h panel/ 48" h spine	57"	5"	1/2"	AX1SED5748 () ()	305.
	64" h panel/ 39" h spine	64"	5"	1/2"	AX1SED6439 () ()	317.
	64" h panel/ 48" h spine	64"	5"	1/2"	AX1SED6448 () ()	317.
	78" h panel/ 48" h spine	78"	5"	1/2"	AX1SED7848 () ()	482.
78" h panel/ 64" h spine	78"	5"	1/2"	AX1SED7864 () ()	461.	
Inside base trim cover for Currents raceway		4"	5"		AX1SECBT ()	50.

Order Code	Specification Information	Application Notes
Example: AX1 SED 6448 613 812	For spine end connectors with panel lower than spine specify crown type and finish for crown end cap. 1. Crown type: C=Currents standard 4" h L=low profile flat 1" h H=high profile flat 1 1/4" h F=compact 1" h 2. All crown end caps are available in all painted finishes. For all spine end connectors specify vertical cover and top trim finish: 3. Vertical cover finish: All standard paint finishes 4. Top cap for vertical cover: 812=Easy Grey 813=Trim Grey And all standard painted finishes	Spine end connectors are complete end cover and trim for an AutoStrada or Currents spine. Side edges of spine end connectors accept end starters for Dividends Horizon panels and screens. In most cases spine end connectors match the height of the attached Dividends Horizon panel/screen. When attached panel/screen is lower than the spine, the spine end connector is as high as the nominal height of the spine and the crown requires an end cap. Specify low profile flat metal crown covers to align with a 50" h Dividends Horizon panel/screen.
AX1 Spine connector		
SED Type		
64 Panel height		
48 Spine height		
613 Vertical cover finish		
812 Top cap finish	When attached panel/screen is between the nominal height of the spine and the top of the Currents 4" h crown, spine end connector must cover the entire height of the spine with crown. Spine end connectors include painted aluminum outside cover with flat top cap and inside cover (where applicable) over the end of the spine. Inside base trim for Currents raceway is recommended to finish inside when combined with standard Currents recessed base raceway covers. Base trim is not required with AutoStrada spine base covers.	



End connectors on this page begin 1/2" above floor.

3 1/2" spine extender kit for use with ceiling infeed or panels

description	application	h	w	d	pattern no.	list
Spine extender kit for use with Currents Spine	39"h spine	39"	5"	4"	AX1SX39 C (L/C/P)() ()	\$519.
	48"h spine	48"	5"	4"	AX1SX48 C (L/C/P)() ()	537.
	64"h spine	64"	5"	4"	AX1SX64 C (L/C/P)() ()	634.
Spine extender kit for use with AutoStrada Spine	39"h spine	39"	5"	4"	AX1SX39 A (L/C/P)() ()	634.
	48"h spine	48"	5"	4"	AX1SX48 A (L/C/P)() ()	651.
	64"h spine	64"	5"	4"	AX1SX64 A (L/C/P)() ()	755.

Order Code	Specification Information	Application Notes
Example: AX1 SX 48 AL 613 613	For all 3 1/2" spine extenders specify spine base type:	Spine extenders include brackets, side and top trim covers between the end of a spine and any spine end connector to add 3 1/2" to the length of a spine.
AX1 Spine connector	A AutoStrada C Currents	This extension can also make up for the dimensional gain of one Dividends Horizon panel or screen in the middle of a cluster of workstations.
SX Type		
48 Spine height	Then specify crown end type.	Spine end connector must be specified separately to finish off face of spine extender.
A Spine type	L=Flat low/high profile metal crown end cap C=Standard and compact sloped end cap	
L Crown end type	P=Power Pole	Spine extender dimension matches that of the Currents 3 1/2" x 5" ceiling infeed panel which may be added between nominal spine height and ceiling for connection to building power, data and communications supply.
613 Vertical finish	Then specify finish for vertical trim covers, all standard painted finishes.	In most cases the spine end connector matches the height of the attached Dividends Horizon panel or screen, but the extending area is only as high as the nominal height of the spine (bottom of crown) so the crown always requires an end cap.
613 Base trim finish		When attached panel or screen is lower than the spine, the spine end connector should be the same height as the nominal height of the spine.
613 Top cap finish	Then specify base cover finish. AutoStrada spine base covers are clear anodized aluminum (AA) or painted finish excluding silver. Currents spine raceway covers are available in any painted finish only. Then specify top cap finish (if applicable).	

To attach linkable screens or Morrison panels to spine end connector

description	application	h	w	d	pattern no.	00	02	04
End starters for linkable screens 	30" h screen	25"	1"	1/2" - 4 1/2"	AX1LES30 () () ()	\$152.	\$165.	\$177.
	39" h screen	34"	1"	1/2" - 4 1/2"	AX1LES39 () () ()	165.	177.	197.
	48" h screen	43"	1"	1/2" - 4 1/2"	AX1LES48 () () ()	190.	215.	240.
	64" h screen	59"	1"	1/2" - 4 1/2"	AX1LES64 () () ()	223.	259.	297.
End starters for Morrison panels 	30" h panel	30"	1"	1/2" - 4 1/2"	AX1MES30 () () ()	158.	165.	177.
	39" h panel	39"	1"	1/2" - 4 1/2"	AX1MES39 () () ()	190.	197.	215.
	42" h panel	42"	1"	1/2" - 4 1/2"	AX1MES42 () () ()	190.	197.	223.
	48" h panel	48"	1"	1/2" - 4 1/2"	AX1MES48 () () ()	197.	202.	230.
	56" h panel	56"	1"	1/2" - 4 1/2"	AX1MES56 () () ()	230.	253.	286.
	64" h panel	64"	1"	1/2" - 4 1/2"	AX1MES64 () () ()	230.	253.	286.
	80" h panel	80"	1"	1/2" - 4 1/2"	AX1MES80 () () ()	329.	379.	456.
End starter top cap for Morrison panel with linkable screen trim	00, 02 or 04 offset		1"	2 1/4"	AX1LES E ()	11.	11.	n/a

Order Code	Specification Information	Application Notes
Example: AX1 LES48 02 613 812	For spine end starters specify:	End starters connect a linkable screen or panel to either side of a spine end connector of the same height or taller.
AX1 Spine connector	1.Configuration	End starters for linkable screens and Morrison panels include connector track and top cap.
L for linkable screens	00=Flush	For Morrison panels that have linkable screen trim also specify end starter linkable screen end cap.
ES End starter	02=Offset one panel	End starters are available in three configurations: flush with end of spine or offset one or two screen/panel thickness beyond end of spine.
48 Panel height	04=Offset two panels	
02 Offset	2.Paint finish for end starter: All standard paint finishes	
613 Painted finish	3.Trim finish for top cap: 812=Easy Grey 813=Trim Grey Or all standard paint finishes for Morrison top cap.	
812 Trim finish	End starters on this page align with spine base covers 13/16" above the floor.	
		For full access to entire width of spine surface specify end starters offset one panel thickness (02 suffix).
		For a cluster of two workstations with one screen or panel between specify one end starter offset two panel thicknesses (04 suffix) and one offset one thickness (02 suffix).
		For a cluster of three workstations (two intermediate panels) specify two end starters offset two panel thicknesses (04 suffix).
		For a cluster of four workstations (three intermediate panels) extend the spine 12" and specify two flush end starters (00 suffix).
		When specifying an end starter top cap for a Morrison panel with linkable screen trim, note that the 02 offset top cap will also work in an 04 offset application.

To attach AutoStrada or Reff panels to spine end connector

description	application	h	w	d	pattern no.	00	02	04
End starters for AutoStrada or Reff panels	34" h panel	34"	1"	1/2" - 4 1/2"	AX1AES34 () () () ()	\$410.	\$410.	\$448.
	42" h panel	42"	1"	1/2" - 4 1/2"	AX1AES42 () () () ()	516.	516.	565.
	49" h panel	49"	1"	1/2" - 4 1/2"	AX1AES49 () () () ()	534.	534.	584.
	64" h panel	64"	1"	1/2" - 4 1/2"	AX1AES64 () () () ()	646.	646.	707.
	79" h panel	79"	1"	1/2" - 4 1/2"	AX1AES79 () () () ()	987.	987.	1,112.

Spine and linkable screens

Order Code	Specification Information	Application Notes
Example: AX1 AES49 02 24 E 812 AA	For spine end starters specify:	
AX1 Spine connector	1. Configuration	End starters connect a panel to either side of a spine end connector of the same height or taller. End starters include hookstrip and top cap. Specify first adjacent panel top cap width and type.
A for AutoStrada panels	00=Inset flush	
ES End starter	02=Offset one panel	
49 Panel height	04=Offset two panels	For a cluster of two workstations (one intermediate panel) specify one end starter offset two panel thicknesses (04 suffix).
02 Offset	2. Adjoining panel width (18, 20, 24, 30, 36, 42, 48)	For a cluster of three workstations (two intermediate panels) specify two end starters offset two panel thicknesses (04).
24 Panel width	3. Trim profile	For a cluster of four workstations (three intermediate panels) extend the spine 12" and specify two inset end starters (00 suffix).
E Trim profile	A=Flat	
812 Vertical cover finish	B=Square	
AA Top trim finish	C=Bullnose	
	E=AutoStrada	End starters on this page start 1/2" above the floor.
	4. Vertical cover finish	
	All standard paint finishes	
	5. Top trim	
	AutoStrada:	
	AA Clear anodized aluminum and all core paint finishes except silver.	
	Reff:	
	All core paint finishes	

End Starters

To attach Gallery screens to spine end connector

description	application	height	width	depth	pattern no.	00	01	02
End starters for Gallery screens	39"h or 49"h screen	39"	1"	1/2" - 3"	AX1GES39 () ()	\$187.	\$155.	\$155.
	49"h screen	48"	1"	1/2" - 3"	AX1GES48 () ()	212.	161.	175.

Order Code	Specification Information	Application Notes
Example: AX1GES 48 02 613	For spine end starters specify:	End starters connect a 1" thick Gallery screen to either side of spine end connector of the same height or taller.
AX1 Spine connector	1.Configuration	End starters are available in three configurations: flush with end of spine or offset one or two screen thicknesses beyond end of spine.
G Thin screens	00=Flush	
ES End starter	01=Offset one panel	Offset end starters compensate for the dimensional gain of Gallery screens attached to the spine.
48 Panel height	02=Offset two panels	
02 Offset	2.Finish:	
613 Painted finish	All standard paint finishes	
	End starters on this page start 1/2" above the floor.	

To attach Dividends Horizon panels and screens to spine end connector

description	application	h	w	d	pattern no.	list
End starters for Dividends Horizon panels and screens	36"h panel, flush, left end of Service Wall	36"	1"	3"	AX1DHES3600L(5)()	\$201.
	36"h panel, flush, right end of Service Wall	36"	1"	3"	AX1DHES3600R(5)()	201.
	36"h panel, offset 1 panel thickness, left end of Service Wall	36"	1"	3"	AX1DHES3603L(5)()	201.
	36"h panel, offset 1 panel thickness, right end of Service Wall	36"	1"	3"	AX1DHES3603R(5)()	201.
	42"h panel, flush, left end of Service Wall	42"	1"	3"	AX1DHES4200L(5)()	201.
	42"h panel, flush, right end of Service Wall	42"	1"	3"	AX1DHES4200R(5)()	201.
	42"h panel, offset 1 panel thickness, left end of Service Wall	42"	1"	3"	AX1DHES4203L(5)()	201.
	42"h panel, offset 1 panel thickness, right end of Service Wall	42"	1"	3"	AX1DHES4203R(5)()	201.
	50"h panel, flush, left end of Service Wall	50"	1"	3"	AX1DHES5000L(5)()	201.
	50"h panel, flush, right end of Service Wall	50"	1"	3"	AX1DHES5000R(5)()	201.
	50"h panel, offset 1 panel thickness, left end of Service Wall	50"	1"	3"	AX1DHES5003L(5)()	201.
	50"h panel, offset 1 panel thickness, right end of Service Wall	50"	1"	3"	AX1DHES5003R(5)()	201.
	57"h panel, flush, left end of Service Wall	57"	1"	3"	AX1DHES5700L(5)()	201.
	57"h panel, flush, right end of Service Wall	57"	1"	3"	AX1DHES5700R(5)()	201.
	57"h panel, offset 1 panel thickness, left end of Service Wall	57"	1"	3"	AX1DHES5703L(5)()	201.
	57"h panel, offset 1 panel thickness, right end of Service Wall	57"	1"	3"	AX1DHES5703R(5)()	201.
	64"h panel, flush, left end of Service Wall	64"	1"	3"	AX1DHES6400L(5)()	201.
	64"h panel, flush, right end of Service Wall	64"	1"	3"	AX1DHES6400R(5)()	201.
	64"h panel, offset 1 panel thickness, left end of Service Wall	64"	1"	3"	AX1DHES6403L(5)()	201.
	64"h panel, offset 1 panel thickness, right end of Service Wall	64"	1"	3"	AX1DHES6403R(5)()	201.

Spine and linkable screens

Order Code	Specification Information	Application Notes
Example: AX1 DHES 36 00 L (5)	1. Offset	End starters connect a Dividends Horizon panel or screen to either side of a same height or taller spine end connector. End starters for Dividends Horizon panels and screens include specified end top cap.
AX1 Spine connector	00=Flush	
DH Dividends Horizon	03=Offset 1 panel thickness	End starters may be positioned in either of two configurations: flush with end of spine or offset one panel thickness beyond end of spine. For full access to entire width of spine surface, position end starters offset one panel thickness.
ES End starter	2. Top cap type	
36 Panel height	5=Metal flat	For a single workstation (0 intermediate panels), specify 2 spine end connectors and 2 end starters positioned offset by 1 panel thickness. For a cluster of 2 workstations (1 intermediate panel), specify 1 panel starter, 2 spine end connectors, 1 spine extender, and 2 end starters positioned offset by 1 panel thickness. For a cluster of 3 workstations, (2 intermediate panels), extend the spine another 12", specify 2 panel starters, 2 spine end connectors, and 2 end starters positioned flush. For a cluster of 4 workstations (3 intermediate panels), extend the spine 12" and specify 3 panel starters, 2 spine end connectors, and 2 end starters (1 end starter flush and the other offset by 1 panel thickness). For a cluster of 5 workstations (4 intermediate panels) extend the spine by 12" and specify 4 panel starters, 2 spine end connectors, and 2 end starters positioned offset by 1 panel thickness.
00 Offset	3. Paint finish	
5 Top cap type	All standard paint finishes	
613 Painted finish		

Panel system starters and T-ends

Linkable screen panel starters

description	type	width	depth	height	pattern number	paint	
	Morrison and linkable screen panel starters	30"H panel	4"	1"	26"	AA1MPS30()	\$118.
	39"H panel/screen	4"	1"	35"	AA1MPS39()	118.	
	42"H panel	4"	1"	38"	AA1MPS42()	118.	
	48"H panel/screen	4"	1"	44"	AA1MPS48()	124.	
	56"H panel	4"	1"	52"	AA1MPS56()	129.	
	64"H panel/screen	4"	1"	60"	AA1MPS64()	134.	
	74"H panel	4"	1"	70"	AA1MPS74()	139.	
	80"H panel	4"	1"	76"	AA1MPS80()	139.	
	Morrison raceway shroud	2 1/4"	3"	4"	AA1MRS()	50.	
	panel/screen top clip				AA2 MTC ()	59.	
Linkable screen starter fillers	39"H linkable screen	1"	2"	18"	AA1CET39 ()	42.	
48"H linkable screen	1"	2"	27"	AA1CET48 ()	47.		
64"H linkable screen	1"	2"	43"	AA1CET64 ()	59.		

Order Code	Specification Information	Application Notes
Example: AA1 MPS48 3		
AA1 Accessory	Please specify painted finish for panel starters, Morrison raceway shroud and end trim from paint finish options listed on page 8.	Panel starters attach perpendicular panels or linkable screens to Service Wall structural base covers (5" - 21"H).
M Morrison		
PS Panel starter	Linkable screen fillers are trim grey or easy grey integral color.	Panel starters include clamp bracket to any height Service Wall and full height connector track with modified top wedge block.
48 Panel height		Top clip connects panel connector track to Service Wall crown. Specify top clip for added stiffness of panels higher than 48" or whenever cantilevering components from panel. Top clip is not compatible with end trim.
V3 Finish		Specify raceway shroud if connecting power from Service Wall to Morrison panel.
		Linkable screen fillers are optional fillers for linkable screen starters. End trims may interfere with easy access to Service Wall covers.

Panel system starters and T-ends

Morrison panel/linkable screen T-ends

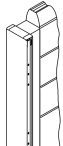
description	type	width	depth	height	pattern number	extension, 0 or 1 1/8	extension, 3 1/2
 T ends for Currents screens and linkable screens	39" screen/39" spine	2 1/4"-5 3/4"	7"	39"	AX2 C3939 () ()	\$802.	\$900.
	48" screen/39" spine	2 1/4"-5 3/4"	7"	48"	AX2 C4839 () ()	932.	1,028.
	48" screen/48" spine	2 1/4"-5 3/4"	7"	48"	AX2 C4848 () ()	867.	963.
	64" screen/39" spine	2 1/4"-5 3/4"	7"	64"	AX2 C6439 () ()	1,062.	1,156.
	64" screen/48" spine	2 1/4"-5 3/4"	7"	64"	AX2 C6448 () ()	997.	1,092.
	64" screen/64" spine	2 1/4"-5 3/4"	7"	64"	AX2 C6464 () ()	997.	1,092.

description	type	width	depth	height	pattern number	extension, 0 or 1 1/8	extension, 3 1/2
 T ends for Morrison panels	39" panel/39" spine	6"	7"	39"	AX1 M3939 () ()	802.	900.
	42" panel/39" spine	6"	7"	42"	AX1 M4239 () ()	867.	963.
	48" panel/39" spine	6"	7"	48"	AX1 M4839 () ()	932.	1,028.
	48" panel/48" spine	6"	7"	48"	AX1 M4848 () ()	867.	963.
	56" panel/39" spine	6"	7"	56"	AX1 M5639 () ()	997.	1,092.
	56" panel/48" spine	6"	7"	56"	AX1 M5648 () ()	932.	1,028.
	64" panel/39" spine	6"	7"	64"	AX1 M6439 () ()	1,062.	1,156.
	64" panel/48" spine	6"	7"	64"	AX1 M6448 () ()	997.	1,092.
	64" panel/64" spine	6"	7"	64"	AX1 M6464 () ()	997.	1,092.
	80" panel/39" spine	6"	7"	80"	AX1 M8039 () ()	1,284.	1,413.
	80" panel/48" spine	6"	7"	80"	AX1 M8048 () ()	1,284.	1,413.
	80" panel/64" spine	6"	7"	80"	AX1 M8064 () ()	1,284.	1,413.

description	type	extension, 0 or 1 1/8	extension, 3 1/2
 T-end raceway adapter kit	1 1/8" extension	AX1 RF1 ()	51.
	3 1/2" extension	AX1 RF3 ()	75.

description	type	extension, 0 or 1 1/8	extension, 3 1/2
 T-end raceway end cover	AA1 ARE ()	29.	29.

Order Code	Specification Information	Application Notes
Example: AX1 M6448 3 613 613 AX1 Spine connector M Morrison 64 Morrison height 48 Spine height 3 Extension 613 Top cap finish 613 Vertical trim cover	T ends begin with AX1-prefix. Fourth position indicates attached panel system: C Linkable screen M Morrison panel Fifth position: height of panel. Seventh position: height of service wall. Ninth position: extension at end of spine. 0 0" extension 1 1 1/8" extension 3 3 1/2" extension Please specify painted finish for Morrison top cap, crown end, vertical trim cover, raceway cover and T end vertical cover from from paint finish options listed on page 8. When ordering T-ends for the Service Wall, specify crown end caps separately.	T-end encloses the end of a Service Wall and connects to linkable screens or panels on one or both sides. T-ends include Morrison-style top trim for the 7" wide connection to panels or screens. Currents T-end includes 5" and 6" wide trim and two end caps. Morrison T-end includes 7" wide trim. Use 5" wide trim and two end caps when connecting Currents screens on both sides. Use 6" wide trim and one end cap when connecting to Currents screens on one side only. Specify Morrison end connector separately to finish side edge without a connected screen. Use 7" wide trim when connecting to Morrison panels. Specify Morrison end counter, top cap and raceway cover kits separately to finish side edge of Morrison T-ends without a connected panel. T-ends for linkable screens and Morrison panels capture the end of the Service Wall (no extension) or extend the Service Wall 1 1/8" or 3 1/2". This extension enables precise planning of multiple workstations and intermediate screens or panels between workstations. Specify two 0" T-ends for a single workstation on each side (no intermediate screens). Specify two 1 1/8" T-ends for one intermediate screen, one 1 1/8" and one 3 1/2" for two screens, and two 3 1/2" for three intermediate screens. T-ends with 3 1/2" extension have removable inside covers and accept ceiling infeed panel. The Raceway Adapter kit finishes the bottom of a T-end with the Autostrada base trim profile. No adapter kit is necessary for 0" T-ends.

Panel system starters and T-ends

AutoStrada and Reff panel starters and T-ends

AutoStrada

description	type	pattern number	list	extension, 0 or 1 1/8	extension, 3 1/2
 AutoStrada or Reff panel starter	34"H (includes AA1RTC bracket)	AA1RPS34 ()()	\$135.		
	42"H (includes AA1RTC bracket)	AA1RPS42 ()()	235.		
	49"H (includes AA1RTC bracket)	AA1RPS49 ()()	241.		
	64"H (includes AA1RTC bracket)	AA1RPS64 ()()	257.		
	79"H (includes AA1RTC bracket)	AA1RPS79 ()()	267.		

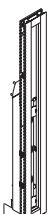
description	type	pattern number	list	extension, 0 or 1 1/8	extension, 3 1/2
 T-end frame for AutoStrada or Reff panels	42" panel to 39" spine frame	AX1 R34239 ()()		963.	1,062.
	49" panel to 39" spine frame	AX1 R34939 ()()		974.	1,073.
	49" panel to 48" spine frame	AX1 R34948 ()()		913.	1,008.
	64" panel to 39" spine frame	AX1 R36439 ()()		1,077.	1,173.
	64" panel to 48" spine frame	AX1 R36448 ()()		1,014.	1,112.
	64" panel to 64" spine frame	AX1 R36464 ()()		1,014.	1,112.
	79" panel to 39" spine frame	AX1 R37939 ()()		1,086.	1,184.
	79" panel to 48" spine frame	AX1 R37948 ()()		1,021.	1,118.
	79" panel to 64" spine frame	AX1 R37964 ()()		989.	1,086.

description	type	pattern number	list	extension, 0 or 1 1/8	extension, 3 1/2
T-end frame for AutoStrada panel without base raceway	42" panel to 39" spine frame	AX1 A34239 ()()		963.	1,062.
	49" panel to 39" spine frame	AX1 A34939 ()()		974.	1,073.
	49" panel to 48" spine frame	AX1 A34948 ()()		913.	1,008.
	64" panel to 39" spine frame	AX1 A36439 ()()		1,077.	1,173.

Order Code	Specification Information	Application Notes
Example: AA1-RPS6448E613AA	For T-end specify extension at end of spine, then paint finish.	Panel starters attach perpendicular AutoStrada panels to Service Wall.
AA1 Accessory	Extension at end of spine:	Panel starter includes clamp bracket to structural base cover, top clip, and vertical extrusion corresponding to AutoStrada panel height.
R Reff/AutoStrada	0 0" extension	T-end encloses the end of a Service Wall and connects to perpendicular AutoStrada panels on one or both sides.
PS Panel starter	1 1 1/8" extension	Specify AutoStrada end connector to finish side edge without a connected wall.
64 Panel height	3 3 1/2" extensions	Specify T-end with 0", 1 1/8", or 3 1/2" of extension to accommodate the "creep" of panels between workstations on each side of Service Wall.
48 Adjoining panel width	<i>Specify following for panel starter:</i>	Specify two 0" T-ends for a single workstation on each side (no intermediate panels).
E Panel top trim profile	1. Adjoining panel width (panel starter includes extended panel top trim for panel attached to starter)	Specify two 1 1/8" T-ends for one intermediate panel, one 1 1/8" and one 3 1/2" for two panels, and two 3 1/2" for three intermediate panels.
613 Finish, panel starter	2. Top trim profile of adjoining panel E = Extruded aluminum top trim	T-ends with 3 1/2" extension have removable inside covers and accept ceiling infeed panel.
AA Panel top trim finish	3. Painted finish for panel starter	Finish options for AA1RTC() top clip: 118 White 111 Black 613 Silver
	4. Top trim finish Anodized aluminum or painted finish	To complete T - end solution, must specify frame, crown end cap, raceway extender and cover set.
	Please specify painted finish for panel starters and inside covers of T-end from paint finish options listed on page 8.	

Panel system starters and T-ends

AutoStrada and Reff panel starters and T-ends

AutoStrada

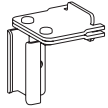

description	type	pattern number	list	extension, 0 or 1 1/8	extension, 3 1/2
T-end frame for AutoStrada panel without base raceway	64" panel to 48" spine frame	AX1 A36448()		\$1,014.	\$1,112.
	64" panel to 64" spine frame	AX1 A36464()		1,014.	1,112.
Top clip (replacement part)		AA1RTC()	96.		



Spine and linkable screens

Order Code	Specification Information	Application Notes
Example: AA1-RPS6448E613AA	For T-end specify extension at end of spine, then paint finish. Extension at end of spine:	Panel starters attach perpendicular AutoStrada panels to Service Wall. Panel starter includes clamp bracket to structural base cover, top clip, and vertical extrusion corresponding to AutoStrada panel height.
AA1 Accessory	0 0" extension	Specify two 0" T-ends for a single workstation on each side (no intermediate panels).
R Reff/AutoStrada	1 1 1/8" extension	
PS Panel starter	3 3 1/2" extensions	
64 Panel height		Specify two 1 1/8" T-ends for one intermediate panel, one 1 1/8" and one 3 1/2" for two panels, and two 3 1/2" for three intermediate panels.
48 Adjoining panel width		T-ends with 3 1/2" extension have removable inside covers and accept ceiling infeed panel.
E Panel top trim profile	<i>Specify following for panel starter:</i>	Finish options for AA1RTC() top clip:
613 Finish, panel starter	1. Adjoining panel width (panel starter includes extended panel top trim for panel attached to starter)	118 White
AA Panel top trim finish	2. Top trim profile of adjoining panel E = Extruded aluminum top trim	111 Black
	3. Painted finish for panel starter	613 Silver
	4. Top trim finish Anodized aluminum or painted finish	
	Please specify painted finish for panel starters and inside covers of T-end from paint finish options listed on page 8.	To complete T - end solution, must specify frame, crown end cap, raceway extender and cover set.

T-end fabric and wood cover sets (AutoStrada or Reff panels)

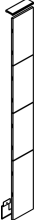
description	type	height	pattern number	list
 Monolithic cover set	Fabric	42"	R3B0P0F4207	\$149.
		49"	R3B0P0F4907	170.
		64"	R3B0P0F6407	199.
		79"	R3B0P0F7907	228.
	L/V1/V2/V3	42"	R3B0P0H4207	153.
		49"	R3B0P0H4907	174.
		64"	R3B0P0H6407	205.
		79"	R3B0P0H7907	233.
 Tiled cover set	Fabric	42"	R3B0T0F4207	149.
		49"	R3B0T0F4907	170.
		64"	R3B0T0F6407	199.
		79"	R3B0T0F7907	228.
	L/V1/V2/V3	42"	R3B0T0H4207	153.
		49"	R3B0T0H4907	174.
		64"	R3B0T0H6407	205.
		79"	R3B0T0H7907	233.
 Tiled cover set, no base raceway	L/V1/V2/V3	42"	R3R0T0H4207	177.
		49"	R3R0T0H4907	201.
		64"	R3R0T0H6407	235.

Order Code

Example: R3B0P0F4207 E 4
R3B Generation 3
0P0F Monolithic
42 Panel height
07 Width
E Top trim profile
4 4" base height
W359- Fabric
AA Trim finish
111 Outside base finish
111 Inside base finish

Specification Information

See Reff System for full selection of painted finishes, fabrics and wood veneers for T-end cover sets.

Specify:

1. Top trim profile
2. Panel finishes
3. Top trim finish
4. Base finish

Top trim profile:

E Extruded Aluminum

Base height:

4 4" base height

Application Notes

Specify covers in monolithic or tiled sets to complete T-end frames for AutoStrada or Reff panel.

Monolithic cover sets include a raceway cover and a single snap-in panel above.

Tiled sets include raceway cover and segmented tiles corresponding to adjacent AutoStrada or Reff tiled panels.

AutoStrada or Reff tiled module horizontal reveals are at nominal 19", 34", 49" and 64" above the floor and do not align with service wall cover reveals.

Please see page 8 for list of applicable finishes.

Panel system starters and T-ends

Gallery screen starters

description	h	w	d	pattern no.	list
Gallery screen starter	21"	3"	1"	AA1GPS ()	\$136.
Screen-to-worksurface bracket				AG1B	33.

Order Code

Example:	AA1 GPS 613
AA1	Accessory
G	For thin screens
PS	Panel starter
613	Painted finish

Specification Information

For intermediate gallery screen starters specify any standard painted finish.

Screen to worksurface bracket is black painted finish.

Application Notes

Gallery screen starter attaches thin screen to structural base cover of AutoStrada spine or Currents service wall. Specify Gallery screen to have through holes for starter bracket.

Screen-to-worksurface bracket is required to stabilize Gallery screens by connecting to adjacent worksurface. Specify one bracket for each screen.

Panel system starters and T-ends



Dividends Horizon panel and screen starters

description	application	h	w	d	pattern no.	list
Service Wall starters for Dividends Horizon panels and screens	36" high Dividends Horizon Panel or Screen	36"	1"	3"	AA1DHPS36(5)()	\$329.
	42" high Dividends Horizon Panel or Screen	42"	1"	3"	AA1DHPS42(5)()	329.
	50" high Dividends Horizon Panel or Screen	50"	1"	3"	AA1DHPS50(5)()	329.
	57" high Dividends Horizon Panel or Screen	57"	1"	3"	AA1DHPS57(5)()	329.
	64" high Dividends Horizon Panel or Screen	64"	1"	3"	AA1DHPS64(5)()	329.
Top clip for Dividends Horizon panels and screens to lower Service Wall	Top clip for Dividends Horizon Panel/Screen to Service Wall				AA1DHTC()	86.

Order Code	Specification Information	Application Notes
Example: AA1 DHPS 36 (5)	1.Top cap type 5=Metal flat	Panel/screen starter includes a clamp bracket that attaches to the structural base cover of the Service Wall to start a Dividends panel/screen run perpendicular to the face of the Service Wall anywhere other than at the end of the Service Wall.
AA1 Accessory	2.Paint finish All standard paint finishes	
DH Dividends Horizon		Top clip, which secures top edge of panel to underside of Service Wall crown, is required in addition to panel starter for stability of 57" or higher panels or 50"H panels with cantilevered shelves overhead storage.
PS Panel starter		
36 Panel height		
5 Top cap type		
613 Painted finish		

Panel system starters and T-ends

Universal panel starter and T-end

description	width	depth	height	pattern number	paint
 Universal T-end adapter	2-6"	7"	39"	AA1UA39()	\$83.
	2-6"	7"	48"	AA1UA48()	101.
	2-6"	7"	64"	AA1UA64()	111.
 Universal panel starters	3"	1"	39"	AA1UPS39()	187.
	3"	1"	48"	AA1UPS48()	202.
	3"	1"	64"	AA1UPS64()	215.
 Universal top clip				AA2 UTC ()	81.

Order Code

Example:	AA1 UPS48 111
AA1	Accessory
UPS	Panel starter
48	Panel height
111	Finish

Specification Information

Please specify painted finish for universal end and panel starters from paint finish options listed on page 8.

Application Notes

Universal adapters and starters integrate other panel systems with the Service Wall. Vertical surface accepts architectural wall starter of most other systems.

T-end adapters include connector to corresponding height T-end for linkable screen (specified separately).

Panel starter includes clamp bracket to structural base cover on Service Wall.

Top clip gives added stability to attached panels of the same height or higher than the Service Wall.

Power components, spine

2+2 power components

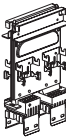
description	type	w	d	h	pattern number	black	orange (-O) or orange triangle (-T)	no finish
Desk height outlet module	21-48"H	5"	-	6"	AR1 EOM			\$172.
								
Central switch	21-48"H				AR1-ELS-B			478.
Duplex outlet	Circuit A				AR1 DA	42.		
	Circuit B				AR1 DB	42.		
	Circuit X				AR1 DX	42.	47.	
	Circuit Y				AR1 DY	42.	47.	
Power infeeds, modular	Desk height power	85"			AR1 EPI5			198.
	Ceiling infeed	145"			AR1 EPIC			246.
Hardwire base infeeds (NYC)	One connector				AR1 EPH1			329.
	Two connectors				AR1 EPH2			493.
Transitional connectors for Morrison or Reff	12"	61"			AR1 ET1			181.
	36"	85"			AR1 ET3			230.
	60"	109"			AR1 ET5			263.
	96"	133"			AR1 ET8			293.
Jumper cable	12"	37"			AR1 EJ1			99.
	24"	49"			AR1 EJ2			130.
	36"	61"			AR1 EJ3			149.
	48"	73"			AR1 EJ4			162.
	60"	85"			AR1 EJ5			181.
	72"	97"			AR1 EJ6			198.
	96"	121"			AR1 EJ8			230.
	120"	145"			AR1 EJ10			262.
	144"	169"			AR1 EJ12			293.

Order Code

Example: AR1 EOM	
AR1	Power component
E	2+2
OM	Outlet module

Application Notes

Autostrada power components distribute four 20-amp circuits at desk height: two convenience circuits and two protected circuits, with separate grounds and heavy duty #10 neutrals. Power may be distributed point-to-point between outlet modules at or below desk height. Outlet modules accept two duplex outlets on each face and four jumper cables to connect to other modules or infeed power.

Modular desk-height outlet module mounts between frame studs at any height from 21" - 48", above or below adjacent worksurfaces. Each 12"W Service Wall frame bay can accept two outlet housings (up to four duplex outlets on each side) side by side.

Central switch controls three outlets inside Service Wall frame for task or ambient lights. Switch occupies right-hand outlet opening in outlets cover on one side of wall.

Switches cannot be positioned back-to-back in combination with an outlet module. Central switch includes white rocker switch, connector to adjacent outlet module, and three simplex outlets on circuit B (2+2 or 3+3).

Outlet modules accept two duplex outlets on each face. Specify outlets with black face for convenience circuits. Specify orange face or black with orange triangle for protected circuits with separate ground and neutral in building power supply.

Desk height power infeed connects from floor box to outlets module in Service Wall. Infeed includes 85" conduit with a 6" pigtail. Ceiling infeed connects from ceiling mounted box to desk height outlet module. Specify ceiling infeed panel separately.

Hardwire base infeed is approved for installations in the City of New York. Infeed includes junction box for base raceway and connector to outlet module.

Jumper cables join power from outlet module to outlet module. Application dimension is distance between modules.

Transitional connectors connect power from Service Wall to powered Morrison or Reff panels attached to the Service Wall. Application dimension suggests distance from outlet to panel. Transitional connectors have watertight conduit between modular ends. Do not specify transitional connectors in City of New York installations.

Power components, spine

3+3 power components

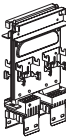
description	type	w	d	h	pattern number	black	orange (-O) or orange triangle (-T)	no finish
Desk-height outlet module	21"-48"H	6"	1"	9"	AR1 TOM			\$198.
								
Central switch	21-48"H				AR1-ELS-B			478.
Duplex outlet	Circuit A				AR1 DA	42.		
	Circuit B				AR1 DB	42.		
	Circuit C				AR1 DC	42.		
	Circuit X				AR1 DX	42.	47.	
	Circuit Y				AR1 DY	42.	47.	
	Circuit Z				AR1 DZ	42.	47.	
Power infeeds	Desk height power	85"			AR1 TPI5			230.
	Ceiling infeed	145"			AR1 TPIC			280.
Hardwire base infeeds (NYC)	One connector				AR1 TPH1			363.
	Two connectors				AR1 TPH2			561.
Transitional connectors for Morrison or Reff	12"	61"			AR1 TT1			214.
	36"	85"			AR1 TT3			263.
	60"	109"			AR1 TT5			293.
	96"	133"			AR1 TT8			329.
Jumper cable	120"				AR1 TJ10			293.
	12"	37"			AR1 TJ1			113.
	24"	49"			AR1 TJ2			149.
	36"	61"			AR1 TJ3			181.
	48"	73"			AR1 TJ4			198.
	60"	85"			AR1 TJ5			214.
	72"	97"			AR1 TJ6			230.
	96"	121"			AR1 TJ8			262.
	144" wall	169"			AR1 TJ12			328.

Spine and linkable screens

Order Code

Example:	AR1 TOM
AR1	Power component
T	3+3
OM	Outlet module

Application Notes

AutoStrada power components distribute six 20-amp circuits at desk height or wall base: three convenience circuits and three protected circuits, with separate grounds and heavy-duty #10 neutrals.

Service Wall power may be distributed point-to-point between outlet modules at desk height or in the base raceway. Outlet modules and power rails accept two duplex outlets on each face and four connector/jumper cables.

Modular desk-height outlet module mounts between Service Wall frame studs at any height from 21" - 48", above or below adjacent worksurfaces. Each 12"W frame bay can accept two outlet housings (up to four duplex outlets on each side.)

Central switch controls three outlets inside Service Wall frame for task or ambient lights. Switch occupies right-hand outlet opening in outlets cover on one side of Service Wall.

Central switch includes white rocker switch, connector to adjacent outlet module, and three simplex outlets on circuit B (2+2 or 3+3).

Outlet modules and power rails accept two duplex outlets on each face. Specify outlets with black face for convenience circuits. Specify orange face or black with orange triangle for protected circuits with separate ground and neutral in building power supply.

description	width	depth	height	pattern number	no finish	paint
High capacity cable holders (10)	1"	3/4"	2 1/2"	AR1 HCC H10	\$34.	



Cable clips for wall studs (100)	1/4"	1/2"	1 1/2"	AR1 PCC 100	82.	
----------------------------------	------	------	--------	--------------------	-----	--



Ceiling infeed panel for stabilizer end cabinet or T-end with 3 1/2" extension	5"	48"	APX CIP4 ()	502.
	5"	72"	APX CIP6 ()	587.
	5"	96"	APX CIP8 ()	671.

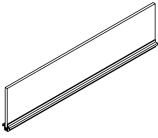
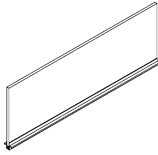
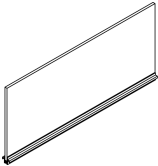

Order Code	Specification Information	Application Notes
Example: AR1 PCC 100	Cable clips and cable managers are black plastic.	Specify cable clips, approximately 50 per Service Wall frame to support and manage cables on the face of studs in the Service Wall frame.
AR1 Raceway	Cable holders are light grey plastic.	Each clip manages up to 14 Category 5 or fiber optic cables; four clips attach between 21"-30", 30"-39", 39"-48"; six between 48"-64"H. Only two clips fit behind a cable tray cover at the 21"-30" height.
PCC Cable clip	Please specify painted finish for ceiling infeed panel from paint finish options listed on page 8.	Specify high capacity cable holders approximately 20 per Service Wall frame to support and manage larger bundles of cables. Each holds up to 55 Cat 5 cables; two holders attach to studs at each 9" level; three holders at the 16" level of a 64"H wall. Only one holder fits behind a cable tray cover at the 21"-30" height (upside down).
100 Size/Quantity		Raceway cable managers are U-shape cable supports that snap into the underside of the Service Wall frame. Plan one per foot foot to contain data cables or power jumpers in the base raceway. Ceiling infeed panel attaches to end of Service Wall adjacent to Currents, Morrison, or Reff T-end panel with 3 1/2" extension. Center channel, 2" x 2 1/2", accommodates one or two power infeed cables. Each side channel is 1 1/2" x 3 1/2" lay-in cable raceway, for continuous lay-in cabling from ceiling to Service Wall surface. Specify ceiling infeed separately.

description	type	width	depth	height	pattern number	clear tempered	powder
Add up panels	 frameless glass, 8"h	24"	1/2"	8"	AUA1 0824 G () ()	\$269.	\$328.
		36"	1/2"	8"	AUA1 0836 G () ()	306.	439.
		48"	1/2"	8"	AUA1 0848 G () ()	396.	548.
		60"	1/2"	8"	AUA1 0860 G () ()	487.	706.
		72"	1/2"	8"	AUA1 0872 G () ()	548.	853.
	 frameless glass, 12"h	24"	1/2"	12"	AUA1 1224 G () ()	322.	370.
		36"	1/2"	12"	AUA1 1236 G () ()	457.	523.
		48"	1/2"	12"	AUA1 1248 G () ()	581.	671.
		60"	1/2"	12"	AUA1 1260 G () ()	709.	820.
		72"	1/2"	12"	AUA1 1272 G () ()	841.	966.
	 frameless glass, 15"h	24"	1/2"	15"	AUA1 1524 G () ()	328.	577.
		36"	1/2"	15"	AUA1 1536 G () ()	457.	639.
		48"	1/2"	15"	AUA1 1548 G () ()	584.	919.
		60"	1/2"	15"	AUA1 1560 G () ()	719.	1,036.
		72"	1/2"	15"	AUA1 1572 G () ()	847.	1,213.

Order Code	Specification Information	Application Notes
Example: AUA1 1248 G TEMP AA AUA1 Autostrada add up panel 12 Height 48 Width G Type TEMP Glass Finish AA Trim Finish	Add up type: G Glass Glass add-ups are available with the following glass options: TEMP Clear tempered GL13 Powder Specify wide add-up panels for use on long Service Wall and Fence runs.	Add-up panels add acoustical privacy and light control above any height Service Wall. Anodized aluminum or painted base frame inserts in center of any Service Wall crown and is secured by bolts within crown. Frameless glass add-ups can be positioned at any 3" increment in standard or compact crown with any cover type.

- Any height add up can be used on any height AutoStrada or Currents Service Wall or Fence.
- 8"h Add ups are designed primarily for use on 39"h spine with 1"h crown to create a 48"h horizon.
 - 12"h Add ups are designed for use on 48"h spine for a 61" horizon with 1"h crown or a 64" horizon with 4"h crown.
 - 15"h Add ups are designed primarily for use on 48"h spine with 1"h crown for a 64" horizon.

Linkable screens and windows

Upholstered

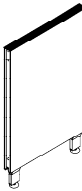
description	type	height	depth	width	pattern number	10	15	20	30	35	40	45	50	55
	30"H	30"	2 1/4"	18"	AP1L 3018 N () () ()	\$261.	\$296.	\$315.	\$366.	\$383.	\$410.	\$410.	\$459.	\$511.
		30"	2 1/4"	24"	AP1L 3024 N () () ()	302.	342.	363.	422.	441.	473.	525.	552.	583.
		30"	2 1/4"	30"	AP1L 3030 N () () ()	330.	375.	396.	462.	483.	515.	575.	605.	638.
		30"	2 1/4"	36"	AP1L 3036 N () () ()	378.	427.	449.	522.	544.	582.	646.	682.	719.
		30"	2 1/4"	42"	AP1L 3042 N () () ()	434.	486.	514.	597.	622.	668.	739.	778.	817.
		30"	2 1/4"	48"	AP1L 3048 N () () ()	476.	537.	563.	653.	681.	730.	808.	851.	896.
		30"	2 1/4"	60"	AP1L 3060 N () () ()	562.	631.	667.	765.	855.	945.	n/a	n/a	n/a
		30"	2 1/4"	72"	AP1L 3072 N () () ()	n/a	786.	n/a	n/a	n/a	n/a	n/a	n/a	n/a
39"H	39"	2 1/4"	18"	AP1L 3918 N () () ()	316.	352.	367.	421.	439.	464.	513.	538.	563.	
	39"	2 1/4"	24"	AP1L 3924 N () () ()	358.	395.	416.	476.	494.	526.	579.	607.	638.	
	39"	2 1/4"	30"	AP1L 3930 N () () ()	385.	431.	449.	515.	538.	569.	627.	661.	692.	
	39"	2 1/4"	36"	AP1L 3936 N () () ()	433.	479.	504.	576.	599.	636.	702.	737.	773.	
	39"	2 1/4"	42"	AP1L 3942 N () () ()	486.	541.	568.	648.	676.	720.	795.	831.	870.	
	39"	2 1/4"	48"	AP1L 3948 N () () ()	529.	588.	618.	706.	736.	781.	861.	905.	948.	
	39"	2 1/4"	60"	AP1L 3960 N () () ()	617.	683.	719.	818.	854.	909.	1,000.	n/a	n/a	
	39"	2 1/4"	72"	AP1L 3972 N () () ()	n/a	826.	n/a	n/a	n/a	n/a	n/a	n/a	n/a	
48"H	48"	2 1/4"	18"	AP1L 4818 N () () ()	369.	410.	432.	491.	513.	545.	601.	631.	665.	
	48"	2 1/4"	24"	AP1L 4824 N () () ()	418.	464.	488.	558.	581.	619.	679.	712.	749.	
	48"	2 1/4"	30"	AP1L 4830 N () () ()	454.	505.	530.	605.	632.	673.	739.	775.	814.	
	48"	2 1/4"	36"	AP1L 4836 N () () ()	511.	566.	595.	678.	706.	753.	828.	868.	912.	
	48"	2 1/4"	42"	AP1L 4842 N () () ()	573.	635.	669.	763.	798.	847.	932.	978.	1,026.	
	48"	2 1/4"	48"	AP1L 4848 N () () ()	623.	692.	728.	830.	865.	919.	1,012.	1,064.	1,117.	
	48"	2 1/4"	60"	AP1L 4860 N () () ()	725.	807.	847.	968.	1,007.	1,071.	1,179.	n/a	n/a	
	48"	2 1/4"	72"	AP1L 4872 N () () ()	n/a	983.	n/a	n/a	n/a	n/a	n/a	n/a	n/a	
64"H	64"	2 1/4"	18"	AP1L 6418 A () () ()	480.	536.	561.	639.	669.	708.	780.	818.	861.	
	64"	2 1/4"	24"	AP1L 6424 A () () ()	529.	588.	618.	706.	736.	781.	861.	905.	948.	
	64"	2 1/4"	30"	AP1L 6430 A () () ()	595.	662.	693.	796.	826.	877.	968.	1,013.	1,065.	
	64"	2 1/4"	36"	AP1L 6436 A () () ()	641.	714.	752.	859.	895.	950.	1,046.	1,098.	1,153.	
	64"	2 1/4"	42"	AP1L 6442 A () () ()	708.	786.	828.	945.	987.	1,049.	1,153.	1,214.	1,272.	
	64"	2 1/4"	48"	AP1L 6448 A () () ()	760.	844.	884.	1,010.	1,056.	1,120.	1,233.	1,296.	1,358.	
	64"	2 1/4"	60"	AP1L 6460 A () () ()	861.	955.	1,003.	1,146.	1,193.	1,270.	1,397.	n/a	n/a	

Order Code	Specification Information	Application Notes
Example: AP1L 3948N 15 812 AA	Linkable screens include top cap and 4"H x 2 1/2"W extruded aluminum legs with levellers.	Linkable screens divide workstations perpendicular to Service Wall where base raceway is not required. Linkable screens connect to the Service Wall with screen starters and to each other with screen connectors. Specify starters and connectors separately.
AP1 AutoStrada		
L Linkable screen		
39 Height	Top cap is integral color trim grey or easy grey.	39"H screens align with the underside of either compact or standard crown on 39"H Service Wall. 39"H screens enable seated visual access.
48 Width		
N Core	Legs are available in clear anodized aluminum or painted finish options list on page 8 excluding silver.	48"H screens align with the underside of either compact or standard crown on 48"H Service Wall. 48"H screens provide some seated privacy.
15 Fabric Grade		
812 Trim Color		
AA Leg Finish		Linkable screens with connectors can end support or cantilever worksurfaces, upmount or downmount overhead storage, with brackets designed for Morrison panel mounting.
		30"H upholstered screens are primarily intended for use in combination with 18"H windows, connected to other 48"H screens with 48"H screen connectors.
		64"H screens align with the underside of either compact or standard crown on 64"H Service Wall. 64"H screens provide seated privacy, and include a high-acoustical core for improved sound absorption.

Linkable screens and windows

Glazed

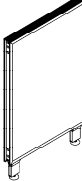
description	type	width	depth	height	pattern number	clear tempered	architectural
	39"H	18"	2 1/4"	39"	AP1L 3918G () ()	\$598.	\$735.
		24"	2 1/4"	39"	AP1L 3924G () ()	643.	826.
		30"	2 1/4"	39"	AP1L 3930G () ()	719.	948.
		36"	2 1/4"	39"	AP1L 3936G () ()	739.	1,020.
		42"	2 1/4"	39"	AP1L 3942G () ()	797.	1,125.
		48"	2 1/4"	39"	AP1L 3948G () ()	824.	1,201.
	48"H	18"	2 1/4"	48"	AP1L 4818G () ()	648.	821.
		24"	2 1/4"	48"	AP1L 4824G () ()	698.	932.
		30"	2 1/4"	48"	AP1L 4830G () ()	765.	1,062.
		36"	2 1/4"	48"	AP1L 4836G () ()	807.	1,162.
		42"	2 1/4"	48"	AP1L 4842G () ()	866.	1,284.
		48"	2 1/4"	48"	AP1L 4848G () ()	902.	1,378.
	64"H	18"	2 1/4"	64"	AP1L 6418G () ()	745.	984.
		24"	2 1/4"	64"	AP1L 6424G () ()	811.	1,134.
		30"	2 1/4"	64"	AP1L 6430G () ()	888.	1,291.
		36"	2 1/4"	64"	AP1L 6436G () ()	930.	1,422.
		42"	2 1/4"	64"	AP1L 6442G () ()	1,007.	1,583.
		48"	2 1/4"	64"	AP1L 6448G () ()	1,052.	1,709.

Spine and linkable screens

Order Code	Specification Information	Application Notes																		
<p>Example: AP1L 3948G GL6 AA 812 AA</p> <table border="1"> <tr><td>AP1</td><td>AutoStrada</td></tr> <tr><td>L</td><td>Linkable screen</td></tr> <tr><td>39</td><td>Height</td></tr> <tr><td>48</td><td>Width</td></tr> <tr><td>G</td><td>Glazed</td></tr> <tr><td>GL6</td><td>Glass Type</td></tr> <tr><td>AA</td><td>Frame Finish</td></tr> <tr><td>812</td><td>Trim Color</td></tr> <tr><td>AA</td><td>Leg Finish</td></tr> </table>	AP1	AutoStrada	L	Linkable screen	39	Height	48	Width	G	Glazed	GL6	Glass Type	AA	Frame Finish	812	Trim Color	AA	Leg Finish	<p>Glazed linkable screens include top cap and two 4"H x 2 1/2"W extruded aluminum legs with levellers. Top cap is integral color trim grey or easy grey. Window frame is anodized aluminum or painted extrusions.</p> <p>Frame and legs are available in clear anodized aluminum or painted finish options listed on page 8 excluding silver.</p> <p>Glass is tempered clear. Architectural glass is available in powder or block matrix finishes.</p> <p>TEMP Clear Tempered GL6 Block Matrix GLI3 Powder</p>	<p>Linkable screens divide workstations perpendicular to Service Wall where base raceway is not required. Linkable screens connect to the Service Wall with screen starters and to each other with screen connectors. Specify starters and connectors separately.</p> <p>Glazed linkable screens feature nearly flush glazing on one surface and a perimeter frame of anodized or painted aluminum. Glazed linkable screens with connectors can end support or cantilever worksurfaces with brackets designed for Morrison panel mounting.</p> <p>39"H screens align with the underside of either compact or standard crown on 39"H Service Wall. 39"H screens enable seated visual access.</p> <p>48"H screens align with the underside of either compact or standard crown on 48"H Service Wall. 48"H screens provide some seated privacy.</p> <p>64"H screens align with the underside of either compact or standard crown on 64"H Service Wall.</p>
AP1	AutoStrada																			
L	Linkable screen																			
39	Height																			
48	Width																			
G	Glazed																			
GL6	Glass Type																			
AA	Frame Finish																			
812	Trim Color																			
AA	Leg Finish																			

Linkable screens and windows

Windows for linkable screens

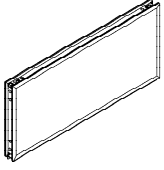
description	type	width	height	pattern number	clear tempered	architectural
Window 	16"H	24"	16"	AP1W 1624G () ()	\$487.	\$506.
		30"	16"	AP1W 1630G () ()	538.	557.
		36"	16"	AP1W 1636G () ()	601.	624.
		42"	16"	AP1W 1642G () ()	647.	675.
		48"	16"	AP1W 1648G () ()	719.	747.
		60"	16"	AP1W 1660G () ()	795.	825.
		72"	16"	AP1W 1672G () ()	907.	942.
	18"H	24"	18"	AP1W 1824G () ()	505.	525.
		30"	18"	AP1W 1830G () ()	556.	579.
		36"	18"	AP1W 1836G () ()	623.	647.
		42"	18"	AP1W 1842G () ()	674.	700.
		48"	18"	AP1W 1848G () ()	743.	773.
		60"	18"	AP1W 1860G () ()	861.	896.
		72"	18"	AP1W 1872G () ()	1,057.	1,098.
	22"H	24"	22"	AP1W 2224G () ()	523.	543.
		30"	22"	AP1W 2230G () ()	576.	598.
		36"	22"	AP1W 2236G () ()	645.	673.
		42"	22"	AP1W 2242G () ()	697.	724.
		48"	22"	AP1W 2248G () ()	766.	799.
		60"	22"	AP1W 2260G () ()	890.	925.
		72"	22"	AP1W 2272G () ()	1,099.	1,143.
25"H	24"	25"	AP1W 2524G () ()	541.	561.	
	30"	25"	AP1W 2530G () ()	595.	618.	
	36"	25"	AP1W 2536G () ()	669.	695.	
	42"	25"	AP1W 2542G () ()	721.	749.	
	48"	25"	AP1W 2548G () ()	794.	824.	
	60"	25"	AP1W 2560G () ()	917.	953.	
	72"	25"	AP1W 2572G () ()	1,143.	1,189.	

Order Code	Specification Information	Application Notes
Example: AP1W 1624G GL6 AA AP1 AutoStrada linkable screen W Window 16 Height 24 Width G Surface Type GL6 Glass Finish AA Frame Finish	Window frame is anodized aluminum or painted extrusions. Painted finish option listed on page 8 excluding silver. Glass is tempered clear. Architectural glass is available in powder or block matrix finishes. TEMP Clear Tempered GL6 Block Matrix GL13 Powder	Windows add on to linkable screens to build partially glazed screens. Linkable screens with windows connect to the Service Wall with screen starters and to each other with screen connectors. Specify starters and connectors in the same height as the combination of screen and window. Windows feature nearly flush glazing on one surface and a perimeter frame of anodized or painted aluminum.

Specify 16"H windows on 48"H linkable screens and connect with 64"H connectors.

Specify 18"H windows on 30"H linkable screens and connect with 48"H connectors.

Specify 25"H windows on 39"H linkable screens and connect with 64"H connectors.

Linkable screens and windows

Connectors and trim

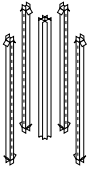
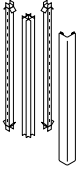
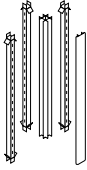
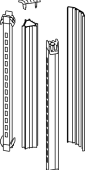
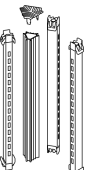
description	type	height	depth	width	pattern number	no finish	integral color	list
90° connector	4-way X 	39"	2 1/4"	2 1/4"	AC1 39X4 ()	\$239.		
		48"	2 1/4"	2 1/4"	AC1 48X4 ()	266.		
		64"	2 1/4"	2 1/4"	AC1 64X4 ()	297.		
	2-way L 	39"	2"		AC1 39L2 ()			161.
		48"	2"		AC1 48L2 ()			170.
		64"	2"		AC1 64L2 ()			182.
	3-way T 	39"	2"		AC1 39T3 ()			205.
		48"	2"		AC1 48T3 ()			215.
		64"	2"		AC1 64T3 ()			231.
120° connector	2-way V 	39"			AC1 39V2 ()			179.
		48"			AC1 48V2 ()			186.
		64"			AC1 64V2 ()			204.
	3-way Y 	39"			AC1 39Y3 ()			218.

Order Code

Example: AC1 39L2 812
AC1 Linkable screen connector
39 Height
L2 90° 2-way L
812 Finish

Specification Information

All top and vertical trim is easy grey (812) or trim grey (813) integral color surface.

Connector post is painted black extrusion.

Carpet grips are black integral color surface.

Linkable screen feet are anodized aluminum or painted finish option listed on page 8 excluding silver.

Application Notes

Connectors join linkable screens in straight, 90° or 120° post configurations.

Linkable screen connectors include connector tracks, universal posts and top and vertical trim (where required).

Connector tracks have cantilever slots for worksurface and storage support.

L, T and X connectors include a universal post and 2, 3 or 4 connector tracks and top cap.





End trim may be specified instead of an end connector if cantilever capability is not required.

Carpet grips snap into linkable screen glides to prevent components from sliding. Glide rotates in carpet grip to permit levelling.

Non-skid grips snap into glides to prevent sliding on hard surface floors.

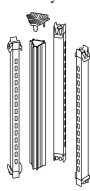
Linkable screens and windows

Connectors and trim

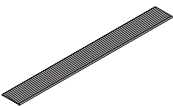
description	type	height	depth	width	pattern number	no finish	integral color	list
120° connector	3-way Y	48"			AC1 48Y3 ()			\$227.
		64"			AC1 64Y3 ()			243.
								
Connector track	No trim	39"	–	–	MC1-39S1	53.		
		48"	–	–	MC1-48S1	61.		
		64"	–	–	MC1-64S1	65.		
								
End connector	with connector track	30"			ACA1 30E1 ()			69.
		39"			ACA1 39E1 ()			72.
		48"			ACA1 48E1 ()			84.
		64"			ACA1 64E1 ()			98.
								
linkable screen end trim (no connector)		30"			AA1 30E ()			43.
		39"			AA1 39E ()			45.
		48"			AA1 48E ()			47.
		64"			AA1 64E ()			48.
								
top trim, linkable screen (replacement)				18"	AA1 T18 ()			12.
				24"	AA1 T24 ()			15.
				30"	AA1 T30 ()			24.
				36"	AA1 T36 ()			26.
				42"	AA1 T42 ()			27.
				48"	AA1 T48 ()			29.
				60"	AA1 T60 ()			32.
								

Order Code

Example: AC1 39L2 812
AC1 Linkable screen connector
39 Height
L2 90° 2-way L
812 Finish

Specification Information

All top and vertical trim is easy grey (812) or trim grey (813) integral color surface.

Connector post is painted black extrusion.

Carpet grips are black integral color surface.

Linkable screen feet are anodized aluminum or painted finish option listed on page 8 excluding silver.

Application Notes

Connectors join linkable screens in straight, 90° or 120° post configurations.

Linkable screen connectors include connector tracks, universal posts and top and vertical trim (where required).

Connector tracks have cantilever slots for worksurface and storage support.

L, T and X connectors include a universal post and 2, 3 or 4 connector tracks and top cap.



End trim may be specified instead of an end connector if cantilever capability is not required.

Carpet grips snap into linkable screen glides to prevent components from sliding. Glide rotates in carpet grip to permit levelling.

Non-skid grips snap into glides to prevent sliding on hard surface floors.

Linkable screens and windows

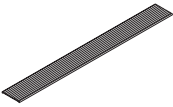
Connectors and trim

description	type	height	depth	width	pattern number	no finish	integral color	list
top trim, linkable screen (replacement)				72"	AA1 T72 ()			\$35.
								
linkable screen feet, pair	replacement part				APA1 LF ()			71.
								
Raceway cover for Currents end connector or end trim on Morrison panel					AA1RE()			31.
Non-skid pads (set of 10)					AA1NSK			37.
Carpet grips (set of 10)					MM2-CG			23.

Order Code	Specification Information	Application Notes
Example: AC1 39L2 812		
AC1 Linkable screen connector	All top and vertical trim is easy grey (812) or trim grey (813) integral color surface.	Connectors join linkable screens in straight, 90° or 120° post configurations.
39 Height	Connector post is painted black extrusion.	Linkable screen connectors include connector tracks, universal posts and top and vertical trim (where required).
L2 90° 2-way L	Carpet grips are black integral color surface.	Connector tracks have cantilever slots for worksurface and storage support.
812 Finish	Linkable screen feet are anodized aluminum or painted finish option listed on page 8 excluding silver.	L, T and X connectors include a universal post and 2, 3 or 4 connector tracks and top cap.
		End trim may be specified instead of an end connector if cantilever capability is not required.
		Carpet grips snap into linkable screen glides to prevent components from sliding. Glide rotates in carpet grip to permit levelling.
		Non-skid grips snap into glides to prevent sliding on hard surface floors.

description	application	h	w	d	pattern no.	L	V1	V2	V3
Gallery screens	39" high	39"	20"	1"	AG1B3920 () ()	\$341.	\$427.	\$548.	\$925.
	39" high	39"	24"	1"	AG1B3924 () ()	383.	465.	613.	1,071.
	39" high	39"	30"	1"	AG1B3930 () ()	427.	504.	675.	1,236.
	39" high	39"	36"	1"	AG1B3936 () ()	469.	543.	738.	1,401.
	39" high	39"	42"	1"	AG1B3942 () ()	512.	582.	801.	1,566.
	39" high	39"	48"	1"	AG1B3948 () ()	554.	621.	863.	1,730.
	39" high	39"	54"	1"	AG1B3954 () ()	597.	661.	929.	1,895.
	39" high	39"	60"	1"	AG1B3960 () ()	639.	699.	991.	2,059.
	39" high	39"	66"	1"	AG1B3966 () ()	682.	738.	1,056.	2,221.
	39" high	39"	72"	1"	AG1B3972 () ()	724.	777.	1,118.	2,388.
	39" high	39"	78"	1"	AG1B3978 () ()	766.	816.	1,180.	2,550.
	39" high	39"	84"	1"	AG1B3984 () ()	811.	855.	1,246.	2,715.
	39" high	39"	90"	1"	AG1B3990 () ()	853.	894.	1,308.	2,881.
	39" high	39"	96"	1"	AG1B3996 () ()	895.	933.	1,371.	3,044.
	49" high	49"	20"	1"	AG1B4920 () ()	444.	517.	676.	1,139.
	49" high	49"	24"	1"	AG1B4924 () ()	487.	556.	749.	1,285.
	49" high	49"	30"	1"	AG1B4930 () ()	529.	596.	822.	1,486.
	49" high	49"	36"	1"	AG1B4936 () ()	573.	634.	895.	1,687.
	49" high	49"	42"	1"	AG1B4942 () ()	616.	674.	968.	1,889.
	49" high	49"	48"	1"	AG1B4948 () ()	658.	712.	1,041.	2,087.
	49" high	49"	54"	1"	AG1B4954 () ()	700.	752.	1,114.	2,289.
	49" high	49"	60"	1"	AG1B4960 () ()	743.	788.	1,187.	2,491.
	49" high	49"	66"	1"	AG1B4966 () ()	784.	829.	1,259.	2,689.
	49" high	49"	72"	1"	AG1B4972 () ()	828.	867.	1,332.	2,892.
	49" high	49"	78"	1"	AG1B4978 () ()	869.	907.	1,406.	3,092.
	49" high	49"	84"	1"	AG1B4984 () ()	914.	945.	1,479.	3,295.
	49" high	49"	90"	1"	AG1B4990 () ()	956.	986.	1,551.	3,495.
	49" high	49"	96"	1"	AG1B4996 () ()	998.	1,024.	1,626.	3,697.

Order Code	Specification Information	Application Notes
Example: AG1 B 4948L N 115 AG1 Gallery screen B Back screen 49 Height 48 Width L End starter N No attachment 115 Finish	For Gallery screens specify: 1.Planning application, L=Screen at left end of Service Wall (from inside face of screen) R=Screen at right end of Service Wall S=Intermediate screen attached to face of Service Wall 2.Then specify other end application: A=Attach to anchor cabinet (49"H screen only) N=No attachment 3.Then specify finish, all standard laminates for vertical applications, all standard Techwoods and natural veneers. Gallery screens include black leveling glides with 1" range. Starting point for screens is 1/2" above floor.	Gallery screens attach to AutoStrada or Currents Service Wall and adjacent worksurfaces to define workspaces. Gallery screens are 1" thick, solid wood core, self-edged in laminate, Techwood or natural veneer. 39"H screens correspond in height to 39"H Service Wall (underside of any crown). 49"H screens correspond in height to 49"H Anchor cabinet and to 48"H Service Wall with compact or flat crown. Gallery screens are specified by application: inserts for end starter (attach to left or right end of Service Wall) or through holes for screen starter (intermediate screen attachment to face of Service Wall) on one end. Inserts enable either 39"H or 48"H end starter to attach to inside face of 49"H screens. Other end of 39"H screen is always "N", no attachment. Other end of 49"H screen can have provisions for attachment to 49"H Anchor cabinet or no attachment. Gallery screens must be stabilized by screen-to-worksurface bracket or attachment to Anchor cabinet.

description	application	pattern no.	AA	P1	P2	P3	G2	G3
Panel attachment kit for glass gallery screen	for 42" h panel attachment	A1GGPC4234(L/R)()	\$756.	\$643.	\$643.	\$681.		
	for 46" h panel attachment	A1GGPC4934(L/R)()	756.	643.	643.	681.		
Spine attachment kit for glass gallery screen	mid span/ off modular	A1GGSPSC30(L/R)()	788.	670.	670.	708.		
	spine end starter	A1GGSE30(L/R)()()	766.	652.	652.	691.		
Glass, for panel based	for 42" h x 60" w	A1PGG4260()					1,376.	1,853.
	for 42" h x 72" w	A1PGG4272()					1,596.	2,210.
	for 49" h x 60" w	A1PGG4960()					1,580.	2,150.
	for 49" h x 72" w	A1PGG4972()					1,841.	2,522.
Glass, for spine based	for 48" h x 60" w	A1SGG4860()					1,529.	2,075.
	for 48" h x 72" w	A1SGG4872()					1,779.	2,435.

Spine and linkable screens

Order Code	Specification Information	Application Notes
Example: A1GGPC4234		
A AutoStrada	1.L/R- Left or right hand connection If left hand, worksurface on right side of glass If right hand, worksurface on left side of glass	Glass Gallery Screen Panel attachment kit includes finished connection to panel post and end capture for glass.
1 Generation 1		
GG Gallery screen, glass		
PC Panel post connector		Glass Gallery Screen Spine attachment kit includes finished connection to spine and end capture for glass.
42 42" h panel attachment (includes Hi/low trim)	2.Finish divider capture AA and all core paint options except 613	
34 34" high nominal		
(L/R) Left or right hand connection	<i>Glass Finish</i> G2=Architectural G3=Color	Glass to align top of panel insert, below top trim for panel base.
() Finish divider, capture		Glass to align top of Service Wall cover, below crown or at horizontal channel at nominal 48" high if 64" Service Wall.

Tiled/Monolithic - mono side only with base raceway
Tiled one side - Laminate/Monolithic side - fabric

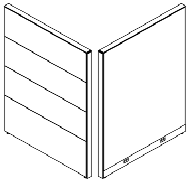
description	h	w	pattern no.	Grade							
				10	15	20	30	35	40	45	
Tiled laminate one side, fabric monolithic other side (tiled side without base raceway)  <i>both sides 64x48 shown, 49" h with three tiles; 34" h with two tiles; 42" h 3 tiles/ top tile 7" h</i>	34"	18"	R3R1AFL3418 () () () () () ()	\$720.	\$732.	\$766.	\$813.	\$843.	\$899.	\$926.	
		24"	R3R1AFL3424 () () () () () ()	766.	782.	818.	860.	894.	947.	977.	
		30"	R3R1AFL3430 () () () () () ()	824.	838.	875.	916.	948.	1,005.	1,034.	
		36"	R3R1AFL3436 () () () () () ()	877.	889.	926.	968.	999.	1,056.	1,082.	
		42"	R3R1AFL3442 () () () () () ()	1,008.	1,022.	1,057.	1,100.	1,132.	1,186.	1,215.	
		48"	R3R1AFL3448 () () () () () ()	1,042.	1,057.	1,092.	1,135.	1,166.	1,221.	1,250.	
		42"	18"	R3R1AFL4218 () () () () () ()	799.	821.	865.	926.	964.	1,031.	1,070.
			24"	R3R1AFL4224 () () () () () ()	854.	877.	924.	981.	1,021.	1,084.	1,126.
			30"	R3R1AFL4230 () () () () () ()	915.	938.	983.	1,043.	1,081.	1,147.	1,188.
			36"	R3R1AFL4236 () () () () () ()	974.	996.	1,043.	1,103.	1,142.	1,204.	1,248.
		42"	R3R1AFL4242 () () () () () ()	1,095.	1,118.	1,163.	1,222.	1,262.	1,328.	1,368.	
		48"	R3R1AFL4248 () () () () () ()	1,156.	1,181.	1,224.	1,284.	1,325.	1,386.	1,430.	
	49"	18"	R3R1AFL4918 () () () () () ()	888.	909.	964.	1,029.	1,075.	1,156.	1,197.	
		24"	R3R1AFL4924 () () () () () ()	948.	969.	1,024.	1,088.	1,138.	1,217.	1,260.	
		30"	R3R1AFL4930 () () () () () ()	1,023.	1,043.	1,097.	1,162.	1,210.	1,292.	1,333.	
		36"	R3R1AFL4936 () () () () () ()	1,082.	1,107.	1,160.	1,223.	1,273.	1,350.	1,393.	
		42"	R3R1AFL4942 () () () () () ()	1,220.	1,242.	1,296.	1,361.	1,408.	1,488.	1,532.	
		48"	R3R1AFL4948 () () () () () ()	1,288.	1,307.	1,364.	1,429.	1,477.	1,558.	1,598.	
	64"	18"	R3R1AFL6418 () () () () () ()	1,016.	1,045.	1,118.	1,202.	1,271.	1,374.	1,431.	
		24"	R3R1AFL6424 () () () () () ()	1,084.	1,116.	1,186.	1,273.	1,336.	1,441.	1,502.	
		30"	R3R1AFL6430 () () () () () ()	1,167.	1,197.	1,272.	1,356.	1,419.	1,527.	1,584.	
		36"	R3R1AFL6436 () () () () () ()	1,240.	1,272.	1,341.	1,428.	1,490.	1,597.	1,655.	
		42"	R3R1AFL6442 () () () () () ()	1,412.	1,440.	1,514.	1,597.	1,662.	1,769.	1,827.	
		48"	R3R1AFL6448 () () () () () ()	1,484.	1,514.	1,584.	1,669.	1,737.	1,841.	1,899.	

Order Code	Specification Information	Application Notes
Example: R3R1AFL3418EAA4K 613W359-118N	<i>To order please specify pattern number including:</i>	Monolithic side with base raceway only. Tiled side inserts extended to the floor. Be sure to specify power rails for panels with one sided base raceways.
R3 AutoStrada w/generation 3 frame	1. Height	
R1 Base raceway monolithic side only	2. Width	
A Tiled one side, Monolithic other	3. Extruded Aluminum Top Trim <i>E - default</i>	Tiled side includes panel reveals between laminate inserts. Aluminum vertical hookstrip cover ordered separately.
F Fabric, monolithic side	4. Finish, Aluminum trim (top trim and tile dividers/reveals) <i>Anodized aluminum or painted finish options listed on page 10 excluding silver.</i>	Panels are not for use with medians, storage medians or bridges.
L Laminate, tiled side	5. Base raceway height <i>4 = 4" h, default</i>	Black PVC hookstrip reveals should be ordered for monolithic side from Reff price list.
34 34" high	6. Knock-out option <i>K = with knock-outs</i> <i>N = no knock-outs</i>	
18 18" wide	7. Base raceway finish <i>painted or plated finish options only</i>	Panels on this page will accept standard Reff System stacking window modules.
E Extruded Aluminum top trim	8. Fabric selection	
AA Top Trim anodized aluminum finish	9. Finish, Laminate	
4 4" high base raceway	10. Milled for ported components <i>M = milled for (\$15 list upcharge applicable)</i> <i>N = not milled for</i>	Product on this page will accept wood grain laminate where laminate is currently an option.
K Knock-outs in base raceway		
613 Finish, base raceway		
W359- Finish, fabric		
118 Finish, Bright White		
N Not milled for ported components	See page 8 for finish options applicable.	

Tiled/Monolithic - mono side only with base raceway
 Tiled one side - V1 Techwood/Monolithic - fabric

description	h	w	pattern no.	Grade						
				10	15	20	30	35	40	45
Tiled V1 techwood one side, fabric monolithic other side (tiled side without base raceway)	34"	18"	R3R1AF13418 () () () () () () ()	\$739.	\$754.	\$790.	\$835.	\$865.	\$918.	\$950.
		24"	R3R1AF13424 () () () () () () ()	795.	808.	846.	888.	918.	976.	1,004.
	30"	R3R1AF13430 () () () () () () ()	850.	864.	901.	943.	977.	1,032.	1,061.	
	36"	R3R1AF13436 () () () () () () ()	901.	915.	951.	994.	1,025.	1,082.	1,112.	
	42"	R3R1AF13442 () () () () () () ()	1,043.	1,054.	1,090.	1,134.	1,165.	1,221.	1,250.	
	48"	R3R1AF13448 () () () () () () ()	1,073.	1,089.	1,126.	1,168.	1,202.	1,255.	1,285.	
	42"	18"	R3R1AF14218 () () () () () () ()	821.	843.	890.	948.	988.	1,054.	1,095.
		24"	R3R1AF14224 () () () () () () ()	881.	903.	948.	1,008.	1,048.	1,114.	1,155.
		30"	R3R1AF14230 () () () () () () ()	945.	969.	1,015.	1,073.	1,114.	1,176.	1,219.
		36"	R3R1AF14236 () () () () () () ()	1,004.	1,026.	1,071.	1,130.	1,171.	1,234.	1,278.
42"		R3R1AF14242 () () () () () () ()	1,130.	1,155.	1,201.	1,262.	1,301.	1,364.	1,407.	
48"		R3R1AF14248 () () () () () () ()	1,187.	1,211.	1,258.	1,316.	1,355.	1,422.	1,461.	
49"		18"	R3R1AF14918 () () () () () () ()	912.	935.	989.	1,054.	1,103.	1,182.	1,227.
		24"	R3R1AF14924 () () () () () () ()	977.	997.	1,051.	1,118.	1,164.	1,249.	1,291.
	30"	R3R1AF14930 () () () () () () ()	1,050.	1,071.	1,127.	1,194.	1,241.	1,320.	1,363.	
	36"	R3R1AF14936 () () () () () () ()	1,117.	1,136.	1,194.	1,255.	1,306.	1,385.	1,429.	
	42"	R3R1AF14942 () () () () () () ()	1,262.	1,284.	1,336.	1,399.	1,449.	1,532.	1,576.	
	48"	R3R1AF14948 () () () () () () ()	1,330.	1,350.	1,404.	1,471.	1,519.	1,600.	1,644.	
64"	18"	R3R1AF16418 () () () () () () ()	1,049.	1,078.	1,150.	1,236.	1,304.	1,410.	1,468.	
	24"	R3R1AF16424 () () () () () () ()	1,120.	1,149.	1,219.	1,307.	1,374.	1,483.	1,538.	
	30"	R3R1AF16430 () () () () () () ()	1,204.	1,232.	1,306.	1,392.	1,455.	1,567.	1,624.	
	36"	R3R1AF16436 () () () () () () ()	1,275.	1,306.	1,378.	1,465.	1,531.	1,639.	1,698.	
	42"	R3R1AF16442 () () () () () () ()	1,453.	1,484.	1,555.	1,643.	1,708.	1,815.	1,872.	
	48"	R3R1AF16448 () () () () () () ()	1,531.	1,558.	1,630.	1,717.	1,783.	1,892.	1,951.	

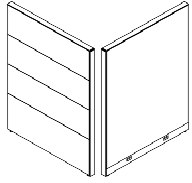

both sides 64x48 shown, 49" h with three tiles; 34" h with two tiles; 42" h 3 tiles/ top tile 7" h

Panels

Order Code	Specification Information	Application Notes
Example: R3R1AF13418EAA4K 613W359-Y319N	To order please specify pattern number including:	Monolithic side with base raceway only. Tiled side inserts extended to the floor. Be sure to specify power rails for panels with one sided base raceways.
R3 AutoStrada w/generation 3 frame	1. Height	
R1 Base raceway monolithic side only	2. Width	
A Tiled one side, Monolithic other	3. Extruded Aluminum Top Trim <i>E - default</i>	Tiled side includes panel reveals between V1 inserts. Aluminum vertical hookstrip cover ordered separately.
F Fabric, monolithic side	4. Finish, Aluminum trim (top trim and tile dividers/reveals) <i>Anodized aluminum or painted finish options listed on page 10 excluding silver.</i>	Panels are not for use with medians, storage medians or bridges.
1 V1 Techwood, tiled side	5. Base raceway height <i>4 = 4" h, default</i>	Black PVC hookstrip reveals should be ordered for monolithic side from Reff price list.
34 34" high	6. Knock-out option <i>K = with knock-outs</i> <i>N = no knock-outs</i>	Panels on this page will accept standard Reff System stacking window modules.
18 18" wide	7. Base raceway finish <i>painted or plated finish options only</i>	
E Extruded Aluminum top trim	8. Fabric selection	
AA Top Trim anodized aluminum finish	9. Finish, V1 Techwood	
4 4" high base raceway	10. Milled for ported components <i>M = milled for (\$15 list upcharge applicable)</i> <i>N = not milled for</i>	
K Knock-outs in base raceway		
613 Finish, base raceway		
W359- Finish, fabric		
Y319 Finish, Cherry		
N Not milled for ported components	See page 8 for finish options applicable.	

Tiled/Monolithic - mono side only with base raceway
Tiled one side - V2 Natural/Monolithic - fabric

description	h	w	pattern no.	Grade							
				10	15	20	30	35	40	45	
Tiled V2 natural one side, fabric monolithic other side (tiled side without base raceway)	34"	18"	R3R1AF23418 (X)(X)(X)(X)(X)	\$755.	\$772.	\$807.	\$850.	\$884.	\$936.	\$964.	
		24"	R3R1AF23424 (X)(X)(X)(X)(X)	809.	826.	862.	905.	936.	991.	1,021.	
		30"	R3R1AF23430 (X)(X)(X)(X)(X)	865.	882.	916.	960.	992.	1,048.	1,075.	
		36"	R3R1AF23436 (X)(X)(X)(X)(X)	917.	934.	971.	1,014.	1,046.	1,099.	1,128.	
		42"	R3R1AF23442 (X)(X)(X)(X)(X)	1,060.	1,071.	1,110.	1,151.	1,182.	1,240.	1,270.	
		48"	R3R1AF23448 (X)(X)(X)(X)(X)	1,096.	1,112.	1,146.	1,190.	1,222.	1,276.	1,306.	
		42"	18"	R3R1AF24218 (X)(X)(X)(X)(X)	838.	860.	905.	964.	1,005.	1,069.	1,113.
			24"	R3R1AF24224 (X)(X)(X)(X)(X)	899.	919.	968.	1,026.	1,066.	1,129.	1,172.
			30"	R3R1AF24230 (X)(X)(X)(X)(X)	961.	986.	1,032.	1,091.	1,129.	1,197.	1,236.
			36"	R3R1AF24236 (X)(X)(X)(X)(X)	1,026.	1,050.	1,095.	1,155.	1,196.	1,260.	1,303.
		42"	R3R1AF24242 (X)(X)(X)(X)(X)	1,153.	1,174.	1,221.	1,280.	1,320.	1,385.	1,427.	
		48"	R3R1AF24248 (X)(X)(X)(X)(X)	1,213.	1,234.	1,283.	1,343.	1,381.	1,446.	1,488.	
	49"	18"	R3R1AF24918 (X)(X)(X)(X)(X)	934.	955.	1,008.	1,072.	1,122.	1,204.	1,249.	
		24"	R3R1AF24924 (X)(X)(X)(X)(X)	994.	1,018.	1,071.	1,136.	1,186.	1,268.	1,311.	
		30"	R3R1AF24930 (X)(X)(X)(X)(X)	1,073.	1,096.	1,151.	1,217.	1,267.	1,346.	1,388.	
		36"	R3R1AF24936 (X)(X)(X)(X)(X)	1,138.	1,161.	1,215.	1,283.	1,330.	1,410.	1,453.	
		42"	R3R1AF24942 (X)(X)(X)(X)(X)	1,284.	1,305.	1,358.	1,423.	1,473.	1,554.	1,596.	
		48"	R3R1AF24948 (X)(X)(X)(X)(X)	1,354.	1,377.	1,429.	1,497.	1,542.	1,626.	1,668.	
	64"	18"	R3R1AF26418 (X)(X)(X)(X)(X)	1,070.	1,099.	1,172.	1,260.	1,325.	1,430.	1,490.	
		24"	R3R1AF26424 (X)(X)(X)(X)(X)	1,141.	1,171.	1,242.	1,330.	1,395.	1,501.	1,560.	
		30"	R3R1AF26430 (X)(X)(X)(X)(X)	1,226.	1,255.	1,328.	1,415.	1,478.	1,587.	1,645.	
		36"	R3R1AF26436 (X)(X)(X)(X)(X)	1,305.	1,332.	1,404.	1,491.	1,556.	1,666.	1,722.	
		42"	R3R1AF26442 (X)(X)(X)(X)(X)	1,486.	1,515.	1,586.	1,671.	1,739.	1,846.	1,904.	
		48"	R3R1AF26448 (X)(X)(X)(X)(X)	1,558.	1,587.	1,660.	1,746.	1,812.	1,921.	1,979.	

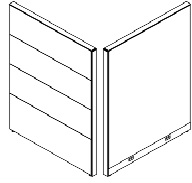

both sides 64x48 shown, 49" h with three tiles; 34" h with two tiles; 42" h 3 tiles/ top tile 7" h

Order Code	Specification Information	Application Notes
Example: R3R1AF23418EAA4K613W359-V316N	<i>To order please specify pattern number including:</i>	Monolithic side with base raceway only. Tiled side inserts extended to the floor. Be sure to specify power rails for panels with one sided base raceways.
R3 AutoStrada w/generation 3 frame	1. Height	
R1 Base raceway monolithic side only	2. Width	
A Tiled one side, Monolithic other	3. Extruded Aluminum Top Trim <i>E - default</i>	Tiled side includes panel reveals between V2 inserts. Aluminum vertical hookstrip cover ordered separately.
F Fabric, monolithic side	4. Finish, Aluminum trim (top trim and tile dividers/reveals) <i>Anodized aluminum or painted finish options listed on page 10 excluding silver.</i>	Panels are not for use with medians, storage medians or bridges.
2 V2 Natural, tiled side	5. Base raceway height <i>4 = 4" h, default</i>	Black PVC hookstrip reveals should be ordered for monolithic side from Reff price list.
34 34" high	6. Knock-out option <i>K = with knock-outs</i> <i>N = no knock-outs</i>	Panels on this page will accept standard Reff System stacking window modules.
18 18" wide	7. Base raceway finish <i>painted or plated finish options only</i>	
E Extruded Aluminum top trim	8. Fabric selection	
AA Top Trim anodized aluminum finish	9. Finish, V2 Natural	
4 4" high base raceway	10. Milled for ported components <i>M = milled for (\$15 list upcharge applicable)</i> <i>N = not milled for</i>	
K Knock-outs in base raceway		
613 Finish, base raceway		
W359- Finish, fabric		
V316 Finish, Maple		
N Not milled for ported components	See page 8 for finish options applicable.	

Tiled/Monolithic - mono side only with base raceway
 Tiled one side - V3 Exotic/Monolithic - fabric

description	h	w	pattern no.	Grade						
				10	15	20	30	35	40	45
Tiled V3 exotic one side, fabric monolithic other side (tiled side without base raceway)	34"	18"	R3R1AF33418 () () () () () ()	\$1,005.	\$1,023.	\$1,070.	\$1,128.	\$1,171.	\$1,241.	\$1,276.
		24"	R3R1AF33424 () () () () () ()	1,073.	1,093.	1,142.	1,199.	1,241.	1,311.	1,348.
		30"	R3R1AF33430 () () () () () ()	1,149.	1,165.	1,214.	1,272.	1,314.	1,383.	1,422.
		36"	R3R1AF33436 () () () () () ()	1,217.	1,234.	1,284.	1,337.	1,380.	1,452.	1,490.
		42"	R3R1AF33442 () () () () () ()	1,397.	1,416.	1,461.	1,519.	1,562.	1,631.	1,669.
		48"	R3R1AF33448 () () () () () ()	1,446.	1,467.	1,515.	1,569.	1,610.	1,682.	1,719.
	42"	18"	R3R1AF34218 () () () () () ()	1,142.	1,165.	1,212.	1,272.	1,311.	1,377.	1,420.
		24"	R3R1AF34224 () () () () () ()	1,223.	1,248.	1,294.	1,353.	1,390.	1,456.	1,499.
		30"	R3R1AF34230 () () () () () ()	1,312.	1,336.	1,381.	1,440.	1,481.	1,544.	1,588.
		36"	R3R1AF34236 () () () () () ()	1,398.	1,423.	1,468.	1,529.	1,568.	1,632.	1,673.
		42"	R3R1AF34242 () () () () () ()	1,569.	1,591.	1,636.	1,698.	1,738.	1,801.	1,843.
		48"	R3R1AF34248 () () () () () ()	1,650.	1,673.	1,720.	1,780.	1,818.	1,886.	1,926.
49"	18"	R3R1AF34918 () () () () () ()	1,244.	1,273.	1,344.	1,427.	1,491.	1,596.	1,653.	
	24"	R3R1AF34924 () () () () () ()	1,326.	1,354.	1,426.	1,510.	1,575.	1,679.	1,738.	
	30"	R3R1AF34930 () () () () () ()	1,429.	1,457.	1,530.	1,611.	1,675.	1,783.	1,839.	
	36"	R3R1AF34936 () () () () () ()	1,515.	1,539.	1,610.	1,696.	1,759.	1,864.	1,922.	
	42"	R3R1AF34942 () () () () () ()	1,699.	1,726.	1,797.	1,879.	1,944.	2,051.	2,108.	
	48"	R3R1AF34948 () () () () () ()	1,794.	1,820.	1,890.	1,977.	2,038.	2,142.	2,200.	
64"	18"	R3R1AF36418 () () () () () ()	1,432.	1,472.	1,567.	1,676.	1,761.	1,904.	1,979.	
	24"	R3R1AF36424 () () () () () ()	1,528.	1,562.	1,658.	1,770.	1,853.	1,997.	2,071.	
	30"	R3R1AF36430 () () () () () ()	1,636.	1,672.	1,765.	1,879.	1,966.	2,108.	2,182.	
	36"	R3R1AF36436 () () () () () ()	1,739.	1,774.	1,869.	1,981.	2,065.	2,207.	2,283.	
	42"	R3R1AF36442 () () () () () ()	1,972.	2,009.	2,105.	2,217.	2,300.	2,441.	2,518.	
	48"	R3R1AF36448 () () () () () ()	2,070.	2,108.	2,200.	2,311.	2,397.	2,538.	2,614.	

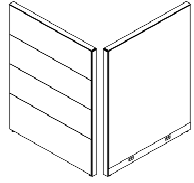

both sides 64x48 shown, 49" h with three tiles; 34" h with two tiles; 42" h 3 tiles/ top tile 7" h

Panels

Order Code	Specification Information	Application Notes
Example: R3R1AF33418EAA4K 613W359-V515N	<i>To order please specify pattern number including:</i>	Monolithic side with base raceway only. Tiled side inserts extended to the floor. Be sure to specify power rails for panels with one sided base raceways.
R3	AutoStrada w/generation 3 frame	
R1	Base raceway monolithic side only	Tiled side includes panel reveals between V3
A	Tiled one side, Monolithic other	inserts. Aluminum vertical hookstrip cover ordered separately.
F	Fabric, monolithic side	
3	V3 Exotic, tiled side	Panels are not for use with medians, storage medians or bridges.
34	34" high	
18	18" wide	Black PVC hookstrip reveals should be ordered for monolithic side from Reff price list.
E	Extruded Aluminum top trim	
AA	Top Trim anodized aluminum finish	Panels on this page will accept standard Reff System stacking window modules.
4	4" high base raceway	
K	Knock-outs in base raceway	
613	Finish, base raceway	
W359-	Finish, fabric	
V515	Finish, Quartered Clear Figured Sycamore	
N	Not milled for ported components	

- Height
- Width
- Extruded Aluminum Top Trim
E - default
- Finish, Aluminum trim (top trim and tile dividers/reveals)
Anodized aluminum or painted finish options listed on page 10 excluding silver.
- Base raceway height
4 = 4" h, default
- Knock-out option
K = with knock-outs
N = no knock-outs
- Base raceway finish
painted or plated finish options only
- Fabric selection
- Finish, V3 Exotic
- Milled for ported components
M = milled for (\$15 list upcharge applicable)
N = not milled for

See page 8 for finish options applicable.

Tiled/Monolithic - mono side only with base raceway
 Tiled one side - Laminate / Laminate
 34" and 42"h

description	h	w	pattern no.	L
Tiled/Monolithic - tiled side no raceway	34"	18"	R3R1ALL3418 () () () () () ()	\$638.
Laminate outside/Laminate inside		24"	R3R1ALL3424 () () () () () ()	695.
		30"	R3R1ALL3430 () () () () () ()	777.
		36"	R3R1ALL3436 () () () () () ()	840.
		42"	R3R1ALL3442 () () () () () ()	864.
		48"	R3R1ALL3448 () () () () () ()	907.
	42"	18"	R3R1ALL4218 () () () () () ()	674.
		24"	R3R1ALL4224 () () () () () ()	733.
		30"	R3R1ALL4230 () () () () () ()	823.
		36"	R3R1ALL4236 () () () () () ()	888.
		42"	R3R1ALL4242 () () () () () ()	977.
		48"	R3R1ALL4248 () () () () () ()	1,094.

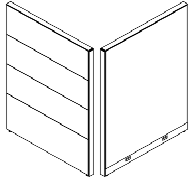

both sides 64x48 shown, 49"h with three tiles; 34"h with two tiles; 42"h 3 tiles/ top tile 7"h

Order Code	Specification Information	Application Notes
Example: R3R1ALL4218EAA4K 613W359-118N	To order please specify pattern number including:	Laminate finish insert extended to the floor. Be sure to specify power rails for panels with one sided base raceways.
R3 AutoStrada w/generation 3 frame	1. Height	
R1 Base raceway monolithic side only	2. Width	
A Monolithic	3. Extruded Aluminum Top Trim <i>E - default</i>	Aluminum vertical hookstrip cover ordered separately.
L Laminate, interior side	4. Finish, Aluminum top trim <i>Anodized aluminum or painted finish options listed on page 10 excluding silver.</i>	Panels are not for use with medians, storage medians or bridges.
L Laminate, exterior side	5. Base raceway height <i>4 = 4"h, default</i>	Black PVC hookstrip reveals should be ordered for fabric side from Reff price list.
42 42" high	6. Knock-out option <i>K = with knock-outs N = no knock-outs</i>	Panels on this page will accept standard Reff System stacking window modules.
18 18" wide	7. Base raceway finish <i>painted or plated finish options only</i>	
E Extruded Aluminum top trim	8. Finish, Laminate	
AA Top Trim anodized aluminum finish	9. Finish, Laminate	Product on this page will accept wood grain laminate where laminate is currently an option.
4 4" high base raceway	10. Milled for ported components <i>M = milled for (\$15 list upcharge applicable) N = not milled for</i>	
K Knock-outs in base raceway		
613 Finish, base raceway		
118 Finish, Bright White		
118 Finish, Bright White		
N Not milled for ported components	See page 8 for finish options applicable.	

Tiled/Monolithic - mono side only with base raceway
 Tiled one side - Laminate / Laminate
 49" and 64"h

description	h	w	pattern no.	L
Tiled/Monolithic - tiled side no raceway	49"	18"	R3R1ALL4918 () () () () () ()	\$801.
Laminate outside/Laminate inside		24"	R3R1ALL4924 () () () () () ()	873.
		30"	R3R1ALL4930 () () () () () ()	976.
		36"	R3R1ALL4936 () () () () () ()	1,056.
		42"	R3R1ALL4942 () () () () () ()	1,160.
		48"	R3R1ALL4948 () () () () () ()	1,299.
	64"	18"	R3R1ALL6418 () () () () () ()	890.
		24"	R3R1ALL6424 () () () () () ()	970.
		30"	R3R1ALL6430 () () () () () ()	1,087.
		36"	R3R1ALL6436 () () () () () ()	1,174.
		42"	R3R1ALL6442 () () () () () ()	1,292.
		48"	R3R1ALL6448 () () () () () ()	1,446.

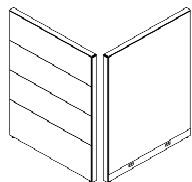

both sides 64x48 shown, 49"h with three tiles; 34"h with two tiles; 42"h 3 tiles/ top tile 7"h

Panels

Order Code	Specification Information	Application Notes
Example: R3R1ALL4218EAA4K 613W359-118N	To order please specify pattern number including:	Laminate finish insert extended to the floor. Be sure to specify power rails for panels with one sided base raceways.
R3 AutoStrada w/generation 3 frame	1. Height	
R1 Base raceway monolithic side only	2. Width	
A Monolithic	3. Extruded Aluminum Top Trim <i>E - default</i>	Aluminum vertical hookstrip cover ordered separately.
L Laminate, interior side	4. Finish, Aluminum top trim <i>Anodized aluminum or painted finish options listed on page 10 excluding silver.</i>	Panels are not for use with medians, storage medians or bridges.
L Laminate, exterior side	5. Base raceway height <i>4 = 4" high, default</i>	Black PVC hookstrip reveals should be ordered for fabric side from Reff price list.
42 42" high	6. Knock-out option <i>K = with knock-outs N = no knock-outs</i>	Panels on this page will accept standard Reff System stacking window modules.
18 18" wide	7. Base raceway finish <i>painted or plated finish options only</i>	
E Extruded Aluminum top trim	8. Finish, Laminate	
AA Top Trim anodized aluminum finish	9. Finish, Laminate	Product on this page will accept wood grain laminate where laminate is currently an option.
4 4" high base raceway	10. Milled for ported components <i>M = milled for (\$15 list upcharge applicable) N = not milled for</i>	
K Knock-outs in base raceway		
613 Finish, base raceway		
118 Finish, Bright White		
118 Finish, Bright White		
N Not milled for ported components	See page 8 for finish options applicable.	

Mono/Mono - exterior hard side no raceway Laminate outside / Fabric inside

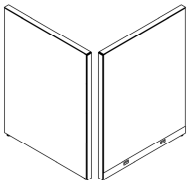
description	h	w	pattern no.	Grade							
				10	15	20	30	35	40	45	
Monolithic laminate exterior no raceway, interior fabric with raceway  <i>both sides 49x48 shown</i>	42"	18"	R3R1PFL4218 () () () () () () ()	\$503.	\$515.	\$537.	\$582.	\$617.	\$657.	\$685.	
		24"	R3R1PFL4224 () () () () () () ()	511.	521.	543.	589.	623.	664.	693.	
		30"	R3R1PFL4230 () () () () () () ()	614.	622.	647.	692.	726.	765.	798.	
		36"	R3R1PFL4236 () () () () () () ()	664.	673.	696.	742.	777.	818.	846.	
		42"	R3R1PFL4242 () () () () () () ()	746.	755.	777.	826.	860.	902.	930.	
		48"	R3R1PFL4248 () () () () () () ()	812.	821.	843.	890.	927.	967.	996.	
		49"	18"	R3R1PFL4918 () () () () () () ()	557.	574.	599.	655.	692.	738.	770.
			24"	R3R1PFL4924 () () () () () () ()	612.	625.	652.	707.	746.	795.	826.
			30"	R3R1PFL4930 () () () () () () ()	692.	707.	731.	790.	827.	876.	907.
			36"	R3R1PFL4936 () () () () () () ()	747.	761.	789.	843.	882.	931.	962.
		42"	R3R1PFL4942 () () () () () () ()	824.	838.	864.	922.	960.	1,010.	1,041.	
		48"	R3R1PFL4948 () () () () () () ()	928.	941.	969.	1,029.	1,065.	1,116.	1,147.	

Order Code	Specification Information	Application Notes
Example: R3R1PFL4218EAA4K 613W359-118N	<i>To order please specify pattern number including:</i>	Interior fabric side with base raceway, exterior monolithic laminate finish insert extended to the floor. Be sure to specify power rails for panels with one sided base raceways.
R3 AutoStrada w/generation 3 frame	1. Height	
R1 Base raceway monolithic side only	2. Width	
P Monolithic	3. Extruded Aluminum Top Trim <i>E - default</i>	Aluminum vertical hookstrip cover ordered separately.
F Fabric, interior side	4. Finish, Aluminum top trim <i>Anodized aluminum or painted finish options listed on page 10 excluding silver.</i>	Panels are not for use with medians, storage medians or bridges.
L Laminate, exterior side	5. Base raceway height <i>4 = 4" h, default</i>	Black PVC hookstrip reveals should be ordered for fabric side from Reff price list.
42 42" high	6. Knock-out option <i>K = with knock-outs N = no knock-outs</i>	Panels on this page will accept standard Reff System stacking window modules.
18 18" wide	7. Base raceway finish <i>painted or plated finish options only</i>	Product on this page will accept wood grain laminate where laminate is currently an option.
E Extruded Aluminum top trim	8. Fabric selection	
AA Top Trim anodized aluminum finish	9. Finish, Laminate	
4 4" high base raceway	10. Milled for ported components <i>M = milled for (\$15 list upcharge applicable) N = not milled for</i>	
K Knock-outs in base raceway		
613 Finish, base raceway		
W359- Finish, fabric		
118 Finish, Bright White	See page 8 for finish options applicable.	
N Not milled for ported components		

Mono/Mono - exterior hard side no raceway

VI Techwood outside / Fabric inside

description	h	w	pattern no.	Grade							
				10	15	20	30	35	40	45	
Monolithic VI techwood exterior no raceway, interior fabric with raceway	42"	18"	R3R1PF14218 () () () () () () ()	\$598.	\$613.	\$636.	\$688.	\$731.	\$777.	\$810.	
		24"	R3R1PF14224 () () () () () () ()	604.	618.	643.	695.	736.	782.	816.	
		30"	R3R1PF14230 () () () () () () ()	729.	739.	766.	821.	862.	909.	941.	
		36"	R3R1PF14236 () () () () () () ()	789.	801.	828.	881.	920.	970.	1,004.	
		42"	R3R1PF14242 () () () () () () ()	887.	899.	927.	979.	1,022.	1,069.	1,103.	
		48"	R3R1PF14248 () () () () () () ()	964.	976.	1,004.	1,057.	1,100.	1,146.	1,181.	
		49"	18"	R3R1PF14918 () () () () () () ()	665.	681.	711.	775.	820.	874.	911.
			24"	R3R1PF14924 () () () () () () ()	727.	744.	773.	839.	883.	938.	976.
			30"	R3R1PF14930 () () () () () () ()	828.	844.	874.	940.	985.	1,042.	1,078.
			36"	R3R1PF14936 () () () () () () ()	886.	904.	935.	998.	1,045.	1,099.	1,137.
		42"	R3R1PF14942 () () () () () () ()	980.	997.	1,030.	1,095.	1,139.	1,197.	1,232.	
		48"	R3R1PF14948 () () () () () () ()	1,103.	1,121.	1,153.	1,218.	1,264.	1,320.	1,358.	

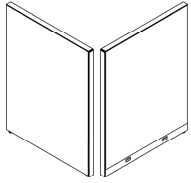

both sides 49x48 shown

Order Code	Specification Information	Application Notes
Example: R3R1PF14218EAA4K 613W359-Y319N	<i>To order please specify pattern number including:</i>	Interior fabric side with base raceway, exterior monolithic V1 insert extended to the floor. Be sure to specify power rails for panels with one sided base raceways.
R3	AutoStrada w/generation 3 frame	
R1	Base raceway monolithic side only	
P	Monolithic, both sides	Aluminum vertical hookstrip cover ordered separately.
F	Fabric, inside	Panels are not for use with medians, storage medians or bridges.
1	VI Techwood, outside	
42	42" high	
18	18" wide	Black PVC hookstrip reveals should be ordered for fabric side from Reff price list.
E	Extruded Aluminum top trim	
AA	Top Trim anodized aluminum finish	Panels on this page will accept standard Reff System stacking window modules.
4	4" high base raceway	
K	Knock-outs in base raceway	
613	Finish, base raceway	
W359-	Finish, fabric	
Y319	Finish, Cherry	
N	Not milled for ported components	

1. Height
2. Width
3. Extruded Aluminum Top Trim
E - default
4. Finish, Aluminum top trim
Anodized aluminum or painted finish options listed on page 10 excluding silver.
5. Base raceway height
4 = 4" h, default
6. Knock-out option
K = with knock-outs
N = no knock-outs
7. Base raceway finish
painted or plated finish options only
8. Fabric selection
9. Finish, VI Techwood
10. Milled for ported components
M = milled for (\$15 list upcharge applicable)
N = not milled for

See page 8 for finish options applicable.

Mono/Mono - exterior hard side no raceway
V2 Natural veneer outside / Fabric inside

description	h	w	pattern no.	Grade						
				10	15	20	30	35	40	45
Monolithic V2 natural veneer exterior no raceway, interior fabric with raceway	42"	18"	R3R1PF24218 () () () () () ()	\$612.	\$622.	\$649.	\$699.	\$743.	\$789.	\$823.
		24"	R3R1PF24224 () () () () () ()	619.	630.	657.	708.	751.	798.	830.
		30"	R3R1PF24230 () () () () () ()	744.	754.	781.	836.	879.	922.	957.
		36"	R3R1PF24236 () () () () () ()	804.	815.	843.	896.	938.	985.	1,018.
		42"	R3R1PF24242 () () () () () ()	905.	915.	943.	996.	1,042.	1,086.	1,121.
		48"	R3R1PF24248 () () () () () ()	986.	996.	1,025.	1,080.	1,122.	1,168.	1,203.
	49"	18"	R3R1PF24918 () () () () () ()	677.	693.	725.	789.	832.	887.	924.
		24"	R3R1PF24924 () () () () () ()	739.	756.	786.	853.	898.	951.	989.
		30"	R3R1PF24930 () () () () () ()	840.	858.	888.	953.	996.	1,052.	1,090.
		36"	R3R1PF24936 () () () () () ()	904.	919.	951.	1,017.	1,062.	1,118.	1,156.
	42"	R3R1PF24942 () () () () () ()	998.	1,017.	1,049.	1,116.	1,159.	1,214.	1,253.	
	48"	R3R1PF24948 () () () () () ()	1,127.	1,144.	1,175.	1,242.	1,288.	1,345.	1,382.	

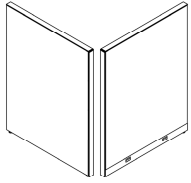

both sides 49x48 shown

Order Code	Specification Information	Application Notes
Example: R3R1PF24218EAA4K 613W359-V316N	To order please specify pattern number including:	Interior fabric side with base raceway, exterior monolithic V2 finish insert extended to the floor. Be sure to specify power rails for panels with one sided base raceways.
R3 AutoStrada w/generation 3 frame	1. Height	
R1 Base raceway monolithic side only	2. Width	
P Monolithic	3. Extruded Aluminum Top Trim <i>E - default</i>	Aluminum vertical hookstrip cover ordered separately.
F Fabric, monolithic interior	4. Finish, Aluminum top trim <i>Anodized aluminum or painted finish options listed on page 10 excluding silver.</i>	Panels are not for use with medians, storage medians or bridges.
2 V2 Natural, monolithic exterior	5. Base raceway height <i>4 = 4" h, default</i>	Black PVC hookstrip reveals should be ordered for fabric side from Reff price list.
42 42" high	6. Knock-out option <i>K = with knock-outs</i> <i>N = no knock-outs</i>	Panels on this page will accept standard Reff System stacking window modules.
18 18" wide	7. Base raceway finish <i>painted or plated finish options only</i>	
E Extruded Aluminum top trim	8. Fabric selection	
AA Top Trim anodized aluminum finish	9. Finish, V2 Natural	
4 4" high base raceway	10. Milled for ported components <i>M = milled for (\$15 list upcharge applicable)</i> <i>N = not milled for</i>	
K Knock-outs in base raceway		
613 Finish, base raceway	See page 8 for finish options applicable.	
W359- Finish, fabric		
V316 Finish, Maple		
N Not milled for ported components		

Mono/Mono - exterior hard side no raceway
V3 Exotic veneer outside / Fabric inside

description	h	w	pattern no.	Grade							
				10	15	20	30	35	40	45	
Monolithic V3 exotic veneer exterior no raceway, interior fabric with raceway	42"	18"	R3R1PF34218 (X)(X)(X)(X)(X)	\$824.	\$836.	\$861.	\$913.	\$956.	\$999.	\$1,036.	
		24"	R3R1PF34224 (X)(X)(X)(X)(X)	837.	847.	874.	925.	969.	1,015.	1,048.	
		30"	R3R1PF34230 (X)(X)(X)(X)(X)	1,006.	1,018.	1,046.	1,097.	1,139.	1,186.	1,219.	
		36"	R3R1PF34236 (X)(X)(X)(X)(X)	1,089.	1,100.	1,128.	1,180.	1,223.	1,271.	1,305.	
		42"	R3R1PF34242 (X)(X)(X)(X)(X)	1,229.	1,241.	1,270.	1,322.	1,364.	1,411.	1,445.	
		48"	R3R1PF34248 (X)(X)(X)(X)(X)	1,343.	1,354.	1,382.	1,434.	1,479.	1,525.	1,559.	
		49"	18"	R3R1PF34918 (X)(X)(X)(X)(X)	912.	931.	959.	1,024.	1,068.	1,124.	1,162.
			24"	R3R1PF34924 (X)(X)(X)(X)(X)	998.	1,018.	1,048.	1,114.	1,158.	1,213.	1,251.
			30"	R3R1PF34930 (X)(X)(X)(X)(X)	1,137.	1,156.	1,186.	1,252.	1,296.	1,351.	1,388.
			36"	R3R1PF34936 (X)(X)(X)(X)(X)	1,226.	1,243.	1,274.	1,341.	1,384.	1,440.	1,479.
		42"	R3R1PF34942 (X)(X)(X)(X)(X)	1,359.	1,377.	1,407.	1,474.	1,519.	1,575.	1,611.	
		48"	R3R1PF34948 (X)(X)(X)(X)(X)	1,533.	1,551.	1,583.	1,648.	1,694.	1,749.	1,789.	

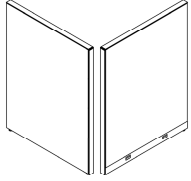

both sides 49x48 shown

Order Code	Specification Information	Application Notes
Example: R3R1PF34218EAA4K 613W359-V515N	<i>To order please specify pattern number including:</i>	Interior fabric side with base raceway, exterior monolithic V3 finish insert extended to the floor. Be sure to specify power rails for panels with one sided base raceways.
R3 AutoStrada w/generation 3 frame	1. Height	
R1 Base raceway monolithic side only	2. Width	
P Monolithic	3. Extruded Aluminum Top Trim <i>E - default</i>	Aluminum vertical hookstrip cover ordered separately.
F Fabric, interior side	4. Finish, Aluminum top trim <i>Anodized aluminum or painted finish options listed on page 10 excluding silver.</i>	Panels are not for use with medians, storage medians or bridges.
3 V3 Exotic, exterior side	5. Base raceway height <i>4 = 4" h, default</i>	Black PVC hookstrip reveals should be ordered for fabric side from Reff price list.
42 42" high	6. Knock-out option <i>K = with knock-outs N = no knock-outs</i>	Panels on this page will accept standard Reff System stacking window modules.
18 18" wide	7. Base raceway finish <i>painted or plated finish options only</i>	
E Extruded Aluminum top trim	8. Fabric selection	
AA Top Trim anodized aluminum finish	9. Finish, V3 Exotic	
4 4" high base raceway	10. Milled for ported components <i>M = milled for (\$15 list upcharge applicable) N = not milled for</i>	
K Knock-outs in base raceway		
613 Finish, base raceway		
W359- Finish, fabric		
V515 Finish, Quartered Clear Figured Sycamore	See page 8 for finish options applicable.	
N Not milled for ported components		

Tiled/Monolithic - both sides with base raceway
 Tiled one side - Laminate/Monolithic side - fabric

description	h	w	pattern no.	Grade						
				10	15	20	30	35	40	45
Tiled laminate one side, fabric monolithic other side (both sides w/ base raceway)	34"	18"	R3R2AFL3418 () () () () () ()	\$720.	\$732.	\$766.	\$813.	\$843.	\$899.	\$926.
		24"	R3R2AFL3424 () () () () () ()	766.	782.	818.	860.	894.	947.	977.
	30"	R3R2AFL3430 () () () () () ()	824.	838.	875.	916.	948.	1,005.	1,034.	
	36"	R3R2AFL3436 () () () () () ()	877.	889.	926.	968.	999.	1,056.	1,082.	
	42"	R3R2AFL3442 () () () () () ()	1,008.	1,022.	1,057.	1,100.	1,132.	1,186.	1,215.	
	48"	R3R2AFL3448 () () () () () ()	1,042.	1,057.	1,092.	1,135.	1,166.	1,221.	1,250.	
	49"	18"	R3R2AFL4918 () () () () () ()	888.	909.	964.	1,029.	1,075.	1,156.	1,197.
		24"	R3R2AFL4924 () () () () () ()	948.	969.	1,024.	1,088.	1,138.	1,217.	1,260.
		30"	R3R2AFL4930 () () () () () ()	1,023.	1,043.	1,097.	1,162.	1,210.	1,292.	1,333.
		36"	R3R2AFL4936 () () () () () ()	1,082.	1,107.	1,160.	1,223.	1,273.	1,350.	1,393.
42"		R3R2AFL4942 () () () () () ()	1,220.	1,242.	1,296.	1,361.	1,408.	1,488.	1,532.	
48"		R3R2AFL4948 () () () () () ()	1,288.	1,307.	1,364.	1,429.	1,477.	1,558.	1,598.	
64"	18"	R3R2AFL6418 () () () () () ()	1,016.	1,045.	1,118.	1,202.	1,271.	1,374.	1,431.	
	24"	R3R2AFL6424 () () () () () ()	1,084.	1,116.	1,186.	1,273.	1,336.	1,441.	1,502.	
	30"	R3R2AFL6430 () () () () () ()	1,167.	1,197.	1,272.	1,356.	1,419.	1,527.	1,584.	
	36"	R3R2AFL6436 () () () () () ()	1,240.	1,272.	1,341.	1,428.	1,490.	1,597.	1,655.	
	42"	R3R2AFL6442 () () () () () ()	1,412.	1,440.	1,514.	1,597.	1,662.	1,769.	1,827.	
	48"	R3R2AFL6448 () () () () () ()	1,484.	1,514.	1,584.	1,669.	1,737.	1,841.	1,899.	

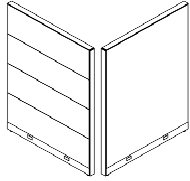

both sides 64x48 shown, 49" h with three tiles; 34" h with two tiles

Order Code	Specification Information	Application Notes
Example: R3R2AFL3418EAA4K 613W359-118N	To order please specify pattern number including:	Tiled side includes aluminum panel reveals between laminate inserts. Aluminum vertical hookstrip cover ordered separately.
R3 AutoStrada w/generation 3 frame	1. Height	
R2 Base raceway both sides	2. Width	
A Tiled one side, Monolithic other	3. Extruded Aluminum Top Trim <i>E - default</i>	Panels are not for use with medians, storage medians or bridges.
F Fabric, monolithic side	4. Finish, Aluminum trim (top trim and tile dividers/reveals)	Black PVC hookstrip reveals should be ordered for monolithic side from Reff price list.
L Laminate, tiled side	<i>Anodized aluminum or painted finish options listed on page 10 excluding silver.</i>	
34 34" high	5. Base raceway height <i>4 = 4" h, default</i>	Panels on this page will accept standard Reff System stacking window modules.
18 18" wide	6. Knock-out option <i>K = with knock-outs N = no knock-outs</i>	Product on this page will accept wood grain laminate where laminate is currently an option.
E Extruded Aluminum top trim	7. Base raceway finish <i>painted or plated finish options only</i>	
AA Top Trim anodized aluminum finish	8. Fabric selection	
4 4" high base raceway	9. Finish, Laminate	
K Knock-outs in base raceway	10. Milled for ported components <i>M = milled for (\$15 list upcharge applicable) N = not milled for</i>	
613 Finish, base raceway		
W359- Finish, fabric		
118 Finish, laminate tile side		
N Not milled for ported components	See page 8 for finish options applicable.	

Tiled/Monolithic - both sides with base raceway
 Tiled one side - V1 Techwood/Monolithic - fabric

description	h	w	pattern no.	Grade						
				10	15	20	30	35	40	45
Tiled V1 techwood one side, fabric monolithic other side (both sides w/ base raceway)	34"	18"	R3R2AF13418 () () () () () () ()	\$739.	\$754.	\$790.	\$835.	\$865.	\$918.	\$950.
		24"	R3R2AF13424 () () () () () () ()	795.	808.	846.	888.	918.	976.	1,004.
		30"	R3R2AF13430 () () () () () () ()	850.	864.	901.	943.	977.	1,032.	1,061.
		36"	R3R2AF13436 () () () () () () ()	901.	915.	951.	994.	1,025.	1,082.	1,112.
		42"	R3R2AF13442 () () () () () () ()	1,043.	1,054.	1,090.	1,134.	1,165.	1,221.	1,250.
		48"	R3R2AF13448 () () () () () () ()	1,073.	1,089.	1,126.	1,168.	1,202.	1,255.	1,285.
	49"	18"	R3R2AF14918 () () () () () () ()	912.	935.	989.	1,054.	1,103.	1,182.	1,227.
		24"	R3R2AF14924 () () () () () () ()	977.	997.	1,051.	1,118.	1,164.	1,249.	1,291.
		30"	R3R2AF14930 () () () () () () ()	1,050.	1,071.	1,127.	1,194.	1,241.	1,320.	1,363.
		36"	R3R2AF14936 () () () () () () ()	1,117.	1,136.	1,194.	1,255.	1,306.	1,385.	1,429.
		42"	R3R2AF14942 () () () () () () ()	1,262.	1,284.	1,336.	1,399.	1,449.	1,532.	1,576.
		48"	R3R2AF14948 () () () () () () ()	1,330.	1,350.	1,404.	1,471.	1,519.	1,600.	1,644.
	64"	18"	R3R2AF16418 () () () () () () ()	1,049.	1,078.	1,150.	1,236.	1,304.	1,410.	1,468.
24"		R3R2AF16424 () () () () () () ()	1,120.	1,149.	1,219.	1,307.	1,374.	1,483.	1,538.	
30"		R3R2AF16430 () () () () () () ()	1,204.	1,232.	1,306.	1,392.	1,455.	1,567.	1,624.	
36"		R3R2AF16436 () () () () () () ()	1,275.	1,306.	1,378.	1,465.	1,531.	1,639.	1,698.	
42"		R3R2AF16442 () () () () () () ()	1,453.	1,484.	1,555.	1,643.	1,708.	1,815.	1,872.	
48"		R3R2AF16448 () () () () () () ()	1,531.	1,558.	1,630.	1,717.	1,783.	1,892.	1,951.	

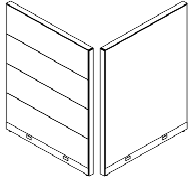

both sides 64x48 shown, 49" h with three tiles; 34" h with two tiles

Panels

Order Code	Specification Information	Application Notes
Example: R3R2AF13418EAA4K 613W359-Y319N	To order please specify pattern number including:	Tiled side includes panel reveals between V1 inserts. Aluminum vertical hookstrip cover ordered separately.
R3 AutoStrada w/generation 3 frame	1. Height	
R2 Base raceway both sides	2. Width	
A Tiled one side, Monolithic other	3. Extruded Aluminum Top Trim <i>E - default</i>	Panels are not for use with medians, storage medians or bridges.
F Fabric, monolithic side	4. Finish, Aluminum trim (top trim and tile dividers/reveals)	Black PVC hookstrip reveals should be ordered for monolithic side from Reff price list.
1 V1 Techwood, tiled side	<i>Anodized aluminum or painted finish options listed on page 10 excluding silver.</i>	
34 34" high	5. Base raceway height <i>4 = 4" h, default</i>	Panels on this page will accept standard Reff System stacking window modules.
18 18" wide	6. Knock-out option <i>K = with knock-outs N = no knock-outs</i>	
E Extruded Aluminum top trim	7. Base raceway finish <i>painted or plated finish options only</i>	
AA Top Trim anodized aluminum finish	8. Fabric selection	
4 4" high base raceway	9. Finish, V1 Techwood	
K Knock-outs in base raceway	10. Milled for ported components <i>M = milled for (\$15 list upcharge applicable) N = not milled for</i>	
613 Finish, base raceway		
W359- Finish, fabric		
Y319 Finish, Cherry		
N Not milled for ported components	See page 8 for finish options applicable.	

Tiled/Monolithic - both sides with base raceway
 Tiled one side - V2 Natural/Monolithic - fabric

description	h	w	pattern no.	Grade							
				10	15	20	30	35	40	45	
Tiled V2 natural one side, fabric monolithic other side (both sides w/ base raceway)	34"	18"	R3R2AF23418 (X)(X)(X)(X)(X)	\$755.	\$772.	\$807.	\$850.	\$884.	\$936.	\$964.	
		24"	R3R2AF23424 (X)(X)(X)(X)(X)	809.	826.	862.	905.	936.	991.	1,021.	
		30"	R3R2AF23430 (X)(X)(X)(X)(X)	865.	882.	916.	960.	992.	1,048.	1,075.	
		36"	R3R2AF23436 (X)(X)(X)(X)(X)	917.	934.	971.	1,014.	1,046.	1,099.	1,128.	
		42"	R3R2AF23442 (X)(X)(X)(X)(X)	1,060.	1,071.	1,110.	1,151.	1,182.	1,240.	1,270.	
		48"	R3R2AF23448 (X)(X)(X)(X)(X)	1,096.	1,112.	1,146.	1,190.	1,222.	1,276.	1,306.	
		49"	18"	R3R2AF24918 (X)(X)(X)(X)(X)	934.	955.	1,008.	1,072.	1,122.	1,204.	1,249.
			24"	R3R2AF24924 (X)(X)(X)(X)(X)	994.	1,018.	1,071.	1,136.	1,186.	1,268.	1,311.
			30"	R3R2AF24930 (X)(X)(X)(X)(X)	1,073.	1,096.	1,151.	1,217.	1,267.	1,346.	1,388.
			36"	R3R2AF24936 (X)(X)(X)(X)(X)	1,138.	1,161.	1,215.	1,283.	1,330.	1,410.	1,453.
		42"	R3R2AF24942 (X)(X)(X)(X)(X)	1,284.	1,305.	1,358.	1,423.	1,473.	1,554.	1,596.	
		48"	R3R2AF24948 (X)(X)(X)(X)(X)	1,354.	1,377.	1,429.	1,497.	1,542.	1,626.	1,668.	
	64"	18"	R3R2AF26418 (X)(X)(X)(X)(X)	1,070.	1,099.	1,172.	1,260.	1,325.	1,430.	1,490.	
		24"	R3R2AF26424 (X)(X)(X)(X)(X)	1,141.	1,171.	1,242.	1,330.	1,395.	1,501.	1,560.	
		30"	R3R2AF26430 (X)(X)(X)(X)(X)	1,226.	1,255.	1,328.	1,415.	1,478.	1,587.	1,645.	
		36"	R3R2AF26436 (X)(X)(X)(X)(X)	1,305.	1,332.	1,404.	1,491.	1,556.	1,666.	1,722.	
		42"	R3R2AF26442 (X)(X)(X)(X)(X)	1,486.	1,515.	1,586.	1,671.	1,739.	1,846.	1,904.	
		48"	R3R2AF26448 (X)(X)(X)(X)(X)	1,558.	1,587.	1,660.	1,746.	1,812.	1,921.	1,979.	

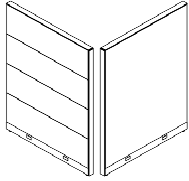

both sides 64x48 shown, 49" h with three tiles; 34" h with two tiles

Order Code	Specification Information	Application Notes
Example: R3R2AF23418EAA4K 613W359-V316N	To order please specify pattern number including:	Tiled side includes panel reveals between V2 inserts. Aluminum vertical hookstrip cover ordered separately.
R3 AutoStrada w/generation 3 frame	1. Height	
R2 Base raceway both sides	2. Width	
A Tiled one side, Monolithic other	3. Extruded Aluminum Top Trim <i>E - default</i>	Panels are not for use with medians, storage medians or bridges.
F Fabric, monolithic side	4. Finish, Aluminum trim (top trim and tile dividers/reveals)	Black PVC hookstrip reveals should be ordered for monolithic side from Reff price list.
2 V2 Natural, tiled side	<i>Anodized aluminum or painted finish options listed on page 10 excluding silver.</i>	
34 34" high	5. Base raceway height <i>4 = 4" h, default</i>	Panels on this page will accept standard Reff System stacking window modules.
18 18" wide	6. Knock-out option <i>K = with knock-outs N = no knock-outs</i>	
E Extruded Aluminum top trim	7. Base raceway finish <i>painted or plated finish options only</i>	
AA Top Trim anodized aluminum finish	8. Fabric selection	
4 4" high base raceway	9. Finish, V2 Natural	
K Knock-outs in base raceway	10. Milled for ported components <i>M = milled for (\$15 list upcharge applicable) N = not milled for</i>	
613 Finish, base raceway		
W359- Finish, fabric		
V316 Finish, Maple		
N Not milled for ported components	See page 8 for finish options applicable.	

Tiled/Monolithic - both sides with base raceway
 Tiled one side - V3 Exotic/Monolithic - fabric

description	h	w	pattern no.	Grade						
				10	15	20	30	35	40	45
Tiled V3 exotic one side, fabric monolithic other side (both sides w/ base raceway)	34"	18"	R3R2AF33418 () () () () () () ()	\$1,005.	\$1,023.	\$1,070.	\$1,128.	\$1,171.	\$1,241.	\$1,276.
		24"	R3R2AF33424 () () () () () () ()	1,073.	1,093.	1,142.	1,199.	1,241.	1,311.	1,348.
		30"	R3R2AF33430 () () () () () () ()	1,149.	1,165.	1,214.	1,272.	1,314.	1,383.	1,422.
		36"	R3R2AF33436 () () () () () () ()	1,217.	1,234.	1,284.	1,337.	1,380.	1,452.	1,490.
		42"	R3R2AF33442 () () () () () () ()	1,397.	1,416.	1,461.	1,519.	1,562.	1,631.	1,669.
	48"	R3R2AF33448 () () () () () () ()	1,446.	1,467.	1,515.	1,569.	1,610.	1,682.	1,719.	
	49"	18"	R3R2AF34918 () () () () () () ()	1,244.	1,273.	1,344.	1,427.	1,491.	1,596.	1,653.
		24"	R3R2AF34924 () () () () () () ()	1,326.	1,354.	1,426.	1,510.	1,575.	1,679.	1,738.
		30"	R3R2AF34930 () () () () () () ()	1,429.	1,457.	1,530.	1,611.	1,675.	1,783.	1,839.
		36"	R3R2AF34936 () () () () () () ()	1,515.	1,539.	1,610.	1,696.	1,759.	1,864.	1,922.
42"		R3R2AF34942 () () () () () () ()	1,699.	1,726.	1,797.	1,879.	1,944.	2,051.	2,108.	
48"	R3R2AF34948 () () () () () () ()	1,794.	1,820.	1,890.	1,977.	2,038.	2,142.	2,200.		
64"	18"	R3R2AF36418 () () () () () () ()	1,432.	1,472.	1,567.	1,676.	1,761.	1,904.	1,979.	
	24"	R3R2AF36424 () () () () () () ()	1,528.	1,562.	1,658.	1,770.	1,853.	1,997.	2,071.	
	30"	R3R2AF36430 () () () () () () ()	1,636.	1,672.	1,765.	1,879.	1,966.	2,108.	2,182.	
	36"	R3R2AF36436 () () () () () () ()	1,739.	1,774.	1,869.	1,981.	2,065.	2,207.	2,283.	
	42"	R3R2AF36442 () () () () () () ()	1,972.	2,009.	2,105.	2,217.	2,300.	2,441.	2,518.	
	48"	R3R2AF36448 () () () () () () ()	2,070.	2,108.	2,200.	2,311.	2,397.	2,538.	2,614.	

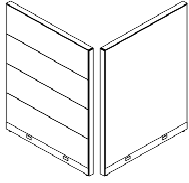

both sides 64x48 shown, 49" h with three tiles; 34" h with two tiles

Panels

Order Code	Specification Information	Application Notes
Example: R3R2AF33418EAA4K613W359-V515N	To order please specify pattern number including:	Tiled side includes panel reveals between V3 inserts. Aluminum vertical hookstrip cover ordered separately.
R3 AutoStrada w/generation 3 frame	1. Height	
R2 Base raceway both sides	2. Width	
A Tiled one side, Monolithic other	3. Extruded Aluminum Top Trim <i>E - default</i>	Panels are not for use with medians, storage medians or bridges.
F Fabric, monolithic side	4. Finish, Aluminum trim (top trim and tile dividers/reveals) <i>Anodized aluminum or painted finish options listed on page 10 excluding silver.</i>	Black PVC hookstrip reveals should be ordered for monolithic side from Reff price list.
3 V3 Exotic, tiled side	5. Base raceway height <i>4 = 4" h, default</i>	Panels on this page will accept standard Reff System stacking window modules.
34 34" high	6. Knock-out option <i>K = with knock-outs</i>	
18 18" wide	<i>N = no knock-outs</i>	
E Extruded Aluminum top trim	7. Base raceway finish <i>painted or plated finish options only</i>	
AA Top Trim anodized aluminum finish	8. Fabric selection	
4 4" high base raceway	9. Finish, V3 Exotic	
K Knock-outs in base raceway	10. Milled for ported components <i>M = milled for (\$15 list upcharge applicable)</i>	
613 Finish, base raceway	<i>N = not milled for</i>	
W359- Finish, fabric		
V515 Finish, Quartered Clear Figured Sycamore		
N Not milled for ported components	See page 8 for finish options applicable.	

Tiled/Monolithic - both sides with base raceway
 Tiled one side - Laminate/Laminate
 34" and 42"h

description	h	w	pattern no.	L
Tiled/Monolithic - both sides with base raceway	34"	18"	R3R2ALL3418 () () () () () ()	\$782.
Laminate outside/Laminate inside		24"	R3R2ALL3424 () () () () () ()	853.
		30"	R3R2ALL3430 () () () () () ()	953.
		36"	R3R2ALL3436 () () () () () ()	1,032.
		42"	R3R2ALL3442 () () () () () ()	1,062.
		48"	R3R2ALL3448 () () () () () ()	1,093.
	42"	18"	R3R2ALL4218 () () () () () ()	942.
		20"	R3R2ALL4220 () () () () () ()	942.
		24"	R3R2ALL4224 () () () () () ()	1,029.
		30"	R3R2ALL4230 () () () () () ()	1,150.
		36"	R3R2ALL4236 () () () () () ()	1,243.
		42"	R3R2ALL4242 () () () () () ()	1,279.
		48"	R3R2ALL4248 () () () () () ()	1,320.

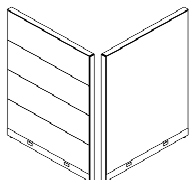

both sides 64x48 shown, 49"h with three tiles; 34"h with two tiles

Order Code	Specification Information	Application Notes
Example: R3R2ALL3418EAA4K 613W359-V515N	To order please specify pattern number including:	Panels are not for use with medians, storage medians or bridges.
R3 AutoStrada w/generation 3 frame	1. Height	Black PVC hookstrip reveals should be ordered for monolithic side from Reff price list.
R2 Base raceway both sides	2. Width	
A Tiled one side, Monolithic other	3. Extruded Aluminum Top Trim <i>E - default</i>	Panels on this page will accept standard Reff System stacking window modules.
L Laminate	4. Finish, Aluminum trim (top trim and tile dividers/reveals) <i>Anodized aluminum or painted finish options listed on page 10 excluding silver.</i>	Product on this page will accept wood grain laminate where laminate is currently an option.
L Laminate	5. Base raceway height <i>4 = 4"h, default</i>	
34 34" high	6. Knock-out option <i>K = with knock-outs</i> <i>N = no knock-outs</i>	
18 18" wide	7. Base raceway finish <i>painted or plated finish options only</i>	
E Extruded Aluminum top trim	8. Finish, Laminate	
AA Top Trim anodized aluminum finish	9. Finish, Laminate	
4 4" high base raceway	10. Milled for ported components <i>M = milled for (\$15 list upcharge applicable)</i> <i>N = not milled for</i>	
K Knock-outs in base raceway		
613 Finish, base raceway		
118 Finish, Laminate		
118 Finish, Laminate		
N Not milled for ported components	See page 8 for finish options applicable.	

Tiled/Monolithic - both sides with base raceway
 Tiled one side - Laminate/Laminate
 49" and 64"h

description	h	w	pattern no.	L
Tiled/Monolithic - both sides with base raceway	49"	18"	R3R2ALL4918 () () () () () ()	\$984.
Laminate outside/Laminate inside		24"	R3R2ALL4924 () () () () () ()	1,073.
		30"	R3R2ALL4930 () () () () () ()	1,201.
		36"	R3R2ALL4936 () () () () () ()	1,298.
		42"	R3R2ALL4942 () () () () () ()	1,337.
		48"	R3R2ALL4948 () () () () () ()	1,377.
	64"	18"	R3R2ALL6418 () () () () () ()	1,224.
		24"	R3R2ALL6424 () () () () () ()	1,335.
		30"	R3R2ALL6430 () () () () () ()	1,496.
		36"	R3R2ALL6436 () () () () () ()	1,614.
		42"	R3R2ALL6442 () () () () () ()	1,662.
		48"	R3R2ALL6448 () () () () () ()	1,731.

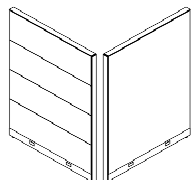

both sides 64x48 shown, 49"h with three tiles; 34"h with two tiles

Panels

Order Code	Specification Information	Application Notes
Example: R3R2ALL3418EAA4K 613W359-V515N	To order please specify pattern number including:	Panels are not for use with medians, storage medians or bridges.
R3 AutoStrada w/generation 3 frame	1. Height	Black PVC hookstrip reveals should be ordered for monolithic side from Reff price list.
R2 Base raceway both sides	2. Width	Panels on this page will accept standard Reff System stacking window modules.
A Tiled one side, Monolithic other	3. Extruded Aluminum Top Trim <i>E - default</i>	Product on this page will accept wood grain laminate where laminate is currently an option.
L Laminate	4. Finish, Aluminum trim (top trim and tile dividers/reveals) <i>Anodized aluminum or painted finish options listed on page 10 excluding silver.</i>	
L Laminate	5. Base raceway height <i>4 = 4"h, default</i>	
34 34" high	6. Knock-out option <i>K = with knock-outs N = no knock-outs</i>	
18 18" wide	7. Base raceway finish <i>painted or plated finish options only</i>	
E Extruded Aluminum top trim	8. Finish, Laminate	
AA Top Trim anodized aluminum finish	9. Finish, Laminate	
4 4" high base raceway	10. Milled for ported components <i>M = milled for (\$15 list upcharge applicable) N = not milled for</i>	
K Knock-outs in base raceway		
613 Finish, base raceway	See page 8 for finish options applicable.	
118 Finish, Laminate		
118 Finish, Laminate		
N Not milled for ported components		

Tiled one side/Slatwall combo other
Tiled one side - Laminate/Slatwall and Fabric other side

description	h	w	pattern no.	Grade							
				10	15	20	30	35	40	45	
Tiled laminate one side, slatwall/fabric other side (tiled side without base raceway)	42"	18"	R3R1CXL4218 () () () () () () () ()	\$1,076.	\$1,092.	\$1,130.	\$1,186.	\$1,220.	\$1,277.	\$1,307.	
		24"	R3R1CXL4224 () () () () () () () ()	1,191.	1,205.	1,246.	1,299.	1,335.	1,390.	1,426.	
		30"	R3R1CXL4230 () () () () () () () ()	1,303.	1,322.	1,360.	1,412.	1,447.	1,505.	1,539.	
		36"	R3R1CXL4236 () () () () () () () ()	1,419.	1,434.	1,474.	1,527.	1,562.	1,619.	1,653.	
		42"	R3R1CXL4242 () () () () () () () ()	1,534.	1,550.	1,587.	1,642.	1,678.	1,736.	1,766.	
		48"	R3R1CXL4248 () () () () () () () ()	1,650.	1,665.	1,702.	1,758.	1,793.	1,851.	1,881.	
		49"	18"	R3R1CXL4918 () () () () () () () ()	1,234.	1,254.	1,299.	1,354.	1,396.	1,467.	1,503.
			24"	R3R1CXL4924 () () () () () () () ()	1,367.	1,384.	1,431.	1,486.	1,528.	1,597.	1,636.
			30"	R3R1CXL4930 () () () () () () () ()	1,501.	1,517.	1,564.	1,619.	1,660.	1,732.	1,767.
			36"	R3R1CXL4936 () () () () () () () ()	1,632.	1,652.	1,698.	1,753.	1,794.	1,866.	1,902.
		42"	R3R1CXL4942 () () () () () () () ()	1,765.	1,783.	1,828.	1,886.	1,926.	1,996.	2,033.	
		48"	R3R1CXL4948 () () () () () () () ()	1,899.	1,917.	1,964.	2,020.	2,060.	2,131.	2,168.	
	64"	18"	R3R1CXL6418 () () () () () () () ()	1,366.	1,389.	1,453.	1,525.	1,581.	1,673.	1,723.	
		24"	R3R1CXL6424 () () () () () () () ()	1,544.	1,569.	1,631.	1,705.	1,762.	1,853.	1,903.	
		30"	R3R1CXL6430 () () () () () () () ()	1,723.	1,747.	1,810.	1,882.	1,940.	2,031.	2,081.	
		36"	R3R1CXL6436 () () () () () () () ()	1,903.	1,926.	1,988.	2,062.	2,118.	2,210.	2,261.	
		42"	R3R1CXL6442 () () () () () () () ()	2,081.	2,105.	2,168.	2,241.	2,297.	2,390.	2,440.	
		48"	R3R1CXL6448 () () () () () () () ()	2,261.	2,284.	2,346.	2,421.	2,477.	2,570.	2,620.	

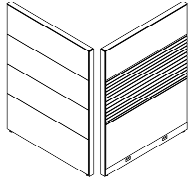

both sides 64x48 shown, 42" & 49" h do not have insert above slatwall section

Order Code	Specification Information	Application Notes
Example: R3R1CXL4218EAA4K613W359-118AA	<i>To order please specify pattern number including:</i>	Tiled side includes panel reveals between laminate inserts. Aluminum vertical hookstrip cover ordered separately. Tiled side inserts extend to the floor, there is no base raceway on this panel side. Be sure to specify power rails for panels with one sided base raceways.
R3 AutoStrada w/generation 3 frame	1. Height	Panels with slatwall one or both sides do not accommodate ported power or data modules
R1 Base raceway slatwall combo side only	2. Width	42" and 49" h panels on this page will not accept frameless glass add-ups.
C Tiled one side, Slatwall combo other	3. Extruded Aluminum Top Trim <i>E - default</i>	Slatwall stiffener bracket recommended when installing multiple Wishbone monitor arms. See page 110.
X Fabric/Slatwall combo side	4. Finish, Aluminum trim (top trim and tile dividers/reveals) <i>Anodized aluminum or painted finish options listed on page 10 excluding silver.</i>	Product on this page will accept wood grain laminate where laminate is currently an option.
L Laminate, tiled side	5. Base raceway height <i>4 = 4" h, default</i>	
42 42" high	6. Knock-out option <i>K = with knock-outs</i> <i>N = no knock-outs</i>	
18 18" wide	7. Base raceway finish <i>painted or plated finish options only</i>	
E Extruded Aluminum top trim	8. Fabric selection	
AA Top Trim anodized aluminum finish	9. Finish, Laminate	
4 4" high base raceway	10. Finish, Slatwall <i>Anodized aluminum or painted finish options listed on page 10 excluding silver</i>	Black PVC hookstrip reveals should be ordered for panel side with slatwall.
K Knock-outs in base raceway		Panels on this page will accept standard Reff System stacking window modules.
613 Finish, base raceway		
W359- Finish, Fabric (combo side)		
118 Finish, Bright white (tiled side)	See page 8 for finish options applicable.	
AA Finish, Slatwall		

Tiled one side - V1 Techwood/Slatwall and Fabric other side

description	h	w	pattern no.	Grade							
				10	15	20	30	35	40	45	
Tiled V1 techwood one side, slatwall/fabric other side (tiled side without base raceway)	42"	18"	R3R1CX14218 (X)(X)(X)(X)(X)(X)	\$1,533.	\$1,549.	\$1,587.	\$1,643.	\$1,676.	\$1,738.	\$1,767.	
		24"	R3R1CX14224 (X)(X)(X)(X)(X)(X)	1,652.	1,667.	1,707.	1,760.	1,797.	1,853.	1,888.	
		30"	R3R1CX14230 (X)(X)(X)(X)(X)(X)	1,770.	1,785.	1,825.	1,878.	1,916.	1,972.	2,005.	
		36"	R3R1CX14236 (X)(X)(X)(X)(X)(X)	1,889.	1,904.	1,943.	1,998.	2,033.	2,089.	2,122.	
		42"	R3R1CX14242 (X)(X)(X)(X)(X)(X)	2,007.	2,024.	2,062.	2,115.	2,153.	2,210.	2,242.	
		48"	R3R1CX14248 (X)(X)(X)(X)(X)(X)	2,121.	2,136.	2,178.	2,231.	2,266.	2,324.	2,356.	
		49"	18"	R3R1CX14918 (X)(X)(X)(X)(X)(X)	1,694.	1,714.	1,759.	1,815.	1,855.	1,927.	1,966.
			24"	R3R1CX14924 (X)(X)(X)(X)(X)(X)	1,830.	1,849.	1,895.	1,953.	1,996.	2,064.	2,102.
			30"	R3R1CX14930 (X)(X)(X)(X)(X)(X)	1,968.	1,985.	2,033.	2,088.	2,132.	2,202.	2,240.
			36"	R3R1CX14936 (X)(X)(X)(X)(X)(X)	2,107.	2,122.	2,172.	2,226.	2,267.	2,338.	2,376.
		42"	R3R1CX14942 (X)(X)(X)(X)(X)(X)	2,242.	2,262.	2,306.	2,365.	2,406.	2,476.	2,512.	
		48"	R3R1CX14948 (X)(X)(X)(X)(X)(X)	2,381.	2,399.	2,446.	2,502.	2,544.	2,615.	2,652.	
	64"	18"	R3R1CX16418 (X)(X)(X)(X)(X)(X)	1,940.	1,966.	2,027.	2,102.	2,157.	2,251.	2,300.	
		24"	R3R1CX16424 (X)(X)(X)(X)(X)(X)	2,132.	2,156.	2,219.	2,293.	2,350.	2,444.	2,492.	
		30"	R3R1CX16430 (X)(X)(X)(X)(X)(X)	2,322.	2,346.	2,411.	2,485.	2,540.	2,635.	2,685.	
		36"	R3R1CX16436 (X)(X)(X)(X)(X)(X)	2,514.	2,539.	2,602.	2,675.	2,733.	2,827.	2,877.	
		42"	R3R1CX16442 (X)(X)(X)(X)(X)(X)	2,707.	2,732.	2,793.	2,869.	2,923.	3,018.	3,068.	
		48"	R3R1CX16448 (X)(X)(X)(X)(X)(X)	2,898.	2,921.	2,985.	3,059.	3,116.	3,207.	3,256.	

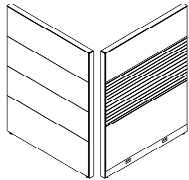

both sides 64x48 shown, 42" & 49" h do not have insert above slatwall section

Panels

Order Code	Specification Information	Application Notes
Example: R3R1CX14218EAA4K 613W359-Y319AA	<i>To order please specify pattern number including:</i>	Tiled side includes panel reveals between V1 inserts. Aluminum vertical hookstrip cover ordered separately. Tiled side inserts extend to the floor, there is no base raceway on this panel side. Be sure to specify power rails for panels with one sided base raceways.
R3 AutoStrada w/generation 3 frame	1. Height	Panels with slatwall one or both sides do not accommodate ported power or data modules 42" and 49" h panels on this page will not accept frameless glass add-ups. Slatwall stiffener bracket recommended when installing multiple Wishbone monitor arms. See page 110.
R1 Base raceway slatwall combo side only	2. Width	
C Tiled one side, Slatwall combo other	3. Extruded Aluminum Top Trim	
X Fabric/Slatwall combo side	<i>E - default</i>	
1 V1 Techwood, tiled side	4. Finish, Aluminum trim (top trim and tile dividers/reveals)	
42 42" high	<i>Anodized aluminum or painted finish options listed on page 10 excluding silver.</i>	
18 18" wide	5. Base raceway height	
E Extruded Aluminum top trim	<i>4 = 4" h, default</i>	
AA Top Trim anodized aluminum finish	6. Knock-out option	
4 4" high base raceway	<i>K = with knock-outs</i>	
K Knock-outs in base raceway	<i>N = no knock-outs</i>	
613 Finish, base raceway	7. Base raceway finish	Panels on this page will accept standard Reff System stacking window modules.
W359- Finish, Fabric (combo side)	<i>Painted or plated finish options only</i>	
Y319 Finish, Cherry (tiled side)	8. Fabric selection	
AA Finish, Slatwall	9. Finish, V1 Techwood	
	10. Finish, Slatwall	
	<i>Anodized aluminum or painted finish options listed on page 10 excluding silver</i>	
	See page 8 for finish options applicable.	

Tiled one side - V2 Natural/Slatwall and Fabric other side

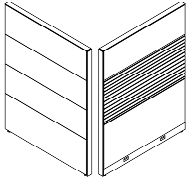
description	h	w	pattern no.	Grade								
				10	15	20	30	35	40	45		
Tiled V2 natural one side, slatwall/fabric other side (tiled side without base raceway)		18"	R3R1CX24218	() () () () () () ()	\$1,595.	\$1,610.	\$1,650.	\$1,705.	\$1,741.	\$1,798.	\$1,830.	
		24"	R3R1CX24224	() () () () () () ()	1,730.	1,745.	1,784.	1,839.	1,873.	1,931.	1,966.	
		30"	R3R1CX24230	() () () () () () ()	1,863.	1,878.	1,918.	1,972.	2,008.	2,065.	2,099.	
		36"	R3R1CX24236	() () () () () () ()	1,998.	2,012.	2,052.	2,108.	2,141.	2,200.	2,232.	
		42"	R3R1CX24242	() () () () () () ()	2,132.	2,149.	2,186.	2,241.	2,278.	2,335.	2,367.	
		48"	R3R1CX24248	() () () () () () ()	2,265.	2,281.	2,320.	2,375.	2,411.	2,468.	2,501.	
		49"	18"	R3R1CX24918	() () () () () () ()	1,764.	1,784.	1,830.	1,888.	1,929.	1,999.	2,035.
		24"	R3R1CX24924	() () () () () () ()	1,922.	1,940.	1,985.	2,043.	2,083.	2,155.	2,191.	
		30"	R3R1CX24930	() () () () () () ()	2,076.	2,097.	2,141.	2,198.	2,241.	2,309.	2,346.	
		36"	R3R1CX24936	() () () () () () ()	2,233.	2,252.	2,297.	2,355.	2,397.	2,468.	2,506.	
42"	R3R1CX24942	() () () () () () ()	2,390.	2,409.	2,453.	2,511.	2,553.	2,622.	2,661.			
48"	R3R1CX24948	() () () () () () ()	2,546.	2,565.	2,614.	2,668.	2,710.	2,781.	2,819.			
64"	18"	R3R1CX26418	() () () () () () ()	2,035.	2,062.	2,122.	2,198.	2,255.	2,346.	2,397.		
24"	R3R1CX26424	() () () () () () ()	2,252.	2,279.	2,339.	2,417.	2,472.	2,564.	2,615.			
30"	R3R1CX26430	() () () () () () ()	2,469.	2,493.	2,557.	2,632.	2,689.	2,781.	2,831.			
36"	R3R1CX26436	() () () () () () ()	2,687.	2,710.	2,773.	2,848.	2,903.	2,998.	3,048.			
42"	R3R1CX26442	() () () () () () ()	2,902.	2,927.	2,988.	3,065.	3,120.	3,213.	3,267.			
48"	R3R1CX26448	() () () () () () ()	3,119.	3,143.	3,204.	3,281.	3,337.	3,429.	3,481.			

both sides 64x48 shown, 42" & 49" h do not have insert above slatwall section

Order Code	Specification Information	Application Notes
Example: R3R1CX24218EAA4K 613W359-V316AA	To order please specify pattern number including:	Tiled side includes panel reveals between V2 inserts. Aluminum vertical hookstrip cover ordered separately. Tiled side inserts extend to the floor, there is no base raceway on this panel side. Be sure to specify power rails for panels with one sided base raceways.
R3 AutoStrada w/generation 3 frame	1. Height	Panels with slatwall one or both sides do not accommodate ported power or data modules
R1 Base raceway slatwall combo side only	2. Width	42" and 49" h panels on this page will not accept frameless glass add-ups.
C Tiled one side, Slatwall combo other	3. Extruded Aluminum Top Trim E - default	Slatwall stiffener bracket recommended when installing multiple Wishbone monitor arms. See page 110.
X Fabric/Slatwall combo side	4. Finish, Aluminum trim (top trim and tile dividers/reveals) Anodized aluminum or painted finish options listed on page 10 excluding silver.	
2 V2 Natural, tiled side	5. Base raceway height 4 = 4" h, default	Slatwall/fabric side combination: Slatwall above worksurface is nominally 15" h for 42" high panels, and 22 1/2" h for both 49" and 64" high panels. Fabric insert begins at just below worksurface height to the base raceway. (64" high panels also have a fabric insert above the slatwall section).
42 42" high	6. Knock-out option K = with knock-outs N = no knock-outs	Black PVC hookstrip reveals should be ordered for panel side with slatwall.
18 18" wide	7. Base raceway finish painted or plated finish options only	Panels on this page will accept standard Reff System stacking window modules.
E Extruded Aluminum top trim	8. Fabric selection	
AA Top Trim anodized aluminum finish	9. Finish, V2 Natural	
4 4" high base raceway	10. Finish, Slatwall Anodized aluminum or painted finish options listed on page 10 excluding silver	
K Knock-outs in base raceway		
613 Finish, base raceway		
W359- Finish, Fabric (combo side)		
V316 Finish, Maple (tiled side)	See page 8 for finish options applicable.	
AA Finish, Slatwall		

Tiled one side/Slatwall combo other

Tiled one side - V3 Exotic/Slatwall and Fabric other side

description	h	w	pattern no.	Grade							
				10	15	20	30	35	40	45	
Tiled V3 exotic one side, slatwall/fabric other side (tiled side without base raceway)	42"	18"	R3R1CX34218 () () () () () () () () ()	\$2,102.	\$2,121.	\$2,173.	\$2,243.	\$2,290.	\$2,366.	\$2,407.	
		24"	R3R1CX34224 () () () () () () () () ()	2,276.	2,294.	2,344.	2,418.	2,464.	2,538.	2,581.	
		30"	R3R1CX34230 () () () () () () () () ()	2,448.	2,469.	2,521.	2,591.	2,638.	2,712.	2,756.	
		36"	R3R1CX34236 () () () () () () () () ()	2,622.	2,646.	2,695.	2,764.	2,811.	2,886.	2,929.	
		42"	R3R1CX34242 () () () () () () () () ()	2,800.	2,819.	2,869.	2,940.	2,986.	3,063.	3,103.	
		48"	R3R1CX34248 () () () () () () () () ()	2,973.	2,990.	3,044.	3,115.	3,162.	3,235.	3,279.	
		49"	18"	R3R1CX34918 () () () () () () () () ()	2,326.	2,351.	2,412.	2,484.	2,539.	2,631.	2,677.
			24"	R3R1CX34924 () () () () () () () () ()	2,528.	2,553.	2,615.	2,687.	2,742.	2,832.	2,880.
			30"	R3R1CX34930 () () () () () () () () ()	2,732.	2,756.	2,818.	2,887.	2,944.	3,033.	3,086.
			36"	R3R1CX34936 () () () () () () () () ()	2,936.	2,960.	3,020.	3,095.	3,146.	3,240.	3,288.
		42"	R3R1CX34942 () () () () () () () () ()	3,139.	3,163.	3,224.	3,297.	3,351.	3,440.	3,493.	
		48"	R3R1CX34948 () () () () () () () () ()	3,344.	3,365.	3,427.	3,501.	3,557.	3,647.	3,695.	
	64"	18"	R3R1CX36418 () () () () () () () () ()	2,690.	2,721.	2,803.	2,900.	2,973.	3,095.	3,160.	
		24"	R3R1CX36424 () () () () () () () () ()	2,971.	3,002.	3,087.	3,181.	3,253.	3,376.	3,439.	
		30"	R3R1CX36430 () () () () () () () () ()	3,252.	3,285.	3,364.	3,463.	3,537.	3,656.	3,722.	
		36"	R3R1CX36436 () () () () () () () () ()	3,535.	3,566.	3,647.	3,744.	3,818.	3,936.	4,006.	
		42"	R3R1CX36442 () () () () () () () () ()	3,815.	3,850.	3,930.	4,026.	4,100.	4,222.	4,287.	
		48"	R3R1CX36448 () () () () () () () () ()	4,098.	4,130.	4,210.	4,308.	4,380.	4,503.	4,566.	

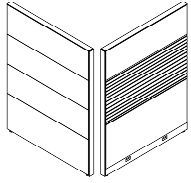

both sides 64x48 shown, 42" & 49" h do not have insert above slatwall section

Order Code	Specification Information	Application Notes
Example: R3R1CX34218EAA4K 613W359-V515AA	To order please specify pattern number including:	Tiled side includes panel reveals between V3 inserts.
R3 AutoStrada w/generation 3 frame	1. Height	Aluminum vertical hookstrip cover ordered separately. Tiled side inserts extend to the floor, there is no base raceway on this panel side.
R1 Base raceway slatwall combo side only	2. Width	Be sure to specify power rails for panels with one sided base raceways.
C Tiled one side, Slatwall combo other	3. Extruded Aluminum Top Trim <i>E - default</i>	Slatwall/fabric side combination: Slatwall above worksurface is nominally 15" h for 42" high panels, and 22 1/2" h for both 49" and 64" high panels. Fabric insert begins at just below worksurface height to the base raceway. (64" high panels also have a fabric insert above the slatwall section).
X Fabric/Slatwall combo side	4. Finish, Aluminum trim (top trim and tile dividers/reveals)	Black PVC hookstrip reveals should be ordered for panel side with slatwall.
3 V3 Exotic, tiled side	<i>Anodized aluminum or painted finish options listed on page 10 excluding silver.</i>	Panels on this page will accept standard Reff System stacking window modules.
42 42" high	5. Base raceway height <i>4 = 4" h, default</i>	
18 18" wide	6. Knock-out option <i>K = with knock-outs N = no knock-outs</i>	
E Extruded Aluminum top trim	7. Base raceway finish <i>painted or plated finish options only</i>	
AA Top Trim anodized aluminum finish	8. Fabric selection	
4 4" high base raceway	9. Finish, V3 Exotic	
K Knock-outs in base raceway	10. Finish, Slatwall <i>Anodized aluminum or painted finish options listed on page 10 excluding silver</i>	
613 Finish, base raceway		
W359- Finish, Fabric (combo side)	See page 8 for finish options applicable.	
V515 Finish, Quartered Clear Figured Sycamore (tiled side)		
AA Finish, Slatwall		

Slatwall/Fabric combo both sides - both sides with base raceway

AutoStrada

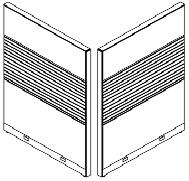
description	h	w	pattern no.	Grade	10	15	20	30	35	40	45	list
Slatwall/Fabric both sides (base raceway both sides)  <i>both sides 64x48 shown, 42"h and 49"h do not have inserts above slatwall sections</i>	42"	18"	R3R2SXX4218 () () () () () () () () () ()	\$1,214.	\$1,244.	\$1,321.	\$1,430.	\$1,503.	\$1,619.	\$1,684.		
	24"		R3R2SXX4224 () () () () () () () () () ()	1,326.	1,358.	1,434.	1,542.	1,614.	1,732.	1,797.		
	30"		R3R2SXX4230 () () () () () () () () () ()	1,439.	1,471.	1,546.	1,655.	1,728.	1,843.	1,907.		
	36"		R3R2SXX4236 () () () () () () () () () ()	1,551.	1,582.	1,660.	1,767.	1,841.	1,955.	2,022.		
	42"		R3R2SXX4242 () () () () () () () () () ()	1,662.	1,694.	1,771.	1,879.	1,953.	2,066.	2,133.		
	48"		R3R2SXX4248 () () () () () () () () () ()	1,779.	1,810.	1,888.	1,997.	2,066.	2,184.	2,248.		
	49"	18"	R3R2SXX4918 () () () () () () () () () ()	1,499.	1,535.	1,629.	1,742.	1,826.	1,967.	2,040.		
	24"		R3R2SXX4924 () () () () () () () () () ()	1,639.	1,673.	1,767.	1,879.	1,966.	2,107.	2,180.		
	30"		R3R2SXX4930 () () () () () () () () () ()	1,775.	1,813.	1,906.	2,020.	2,105.	2,243.	2,319.		
	36"		R3R2SXX4936 () () () () () () () () () ()	1,916.	1,953.	2,045.	2,157.	2,242.	2,382.	2,456.		
	42"		R3R2SXX4942 () () () () () () () () () ()	2,054.	2,089.	2,185.	2,295.	2,381.	2,521.	2,597.		
	48"		R3R2SXX4948 () () () () () () () () () ()	2,191.	2,229.	2,322.	2,435.	2,520.	2,659.	2,735.		
	64"	18"	R3R2SXX6418 () () () () () () () () () ()	1,538.	1,589.	1,715.	1,863.	1,977.	2,163.	2,263.		
	24"		R3R2SXX6424 () () () () () () () () () ()	1,684.	1,736.	1,857.	2,008.	2,120.	2,306.	2,407.		
	30"		R3R2SXX6430 () () () () () () () () () ()	1,828.	1,878.	2,002.	2,154.	2,265.	2,450.	2,552.		
	36"		R3R2SXX6436 () () () () () () () () () ()	1,973.	2,025.	2,151.	2,296.	2,411.	2,598.	2,696.		
	42"		R3R2SXX6442 () () () () () () () () () ()	2,118.	2,168.	2,293.	2,444.	2,555.	2,742.	2,842.		
48"		R3R2SXX6448 () () () () () () () () () ()	2,263.	2,311.	2,436.	2,585.	2,698.	2,885.	2,985.			
Slatwall Stiffener Bracket	42"		ASWRB42									360.
	49"		ASWRB49									454.
	64"		ASWRB64									480.
	79"		ASWRB79									505.

Order Code	Specification Information	Application Notes
Example: R3R2SXX4218EAA4K 613W359-W359-AA	<i>To order please specify pattern number including:</i>	Slatwall/fabric combination: Slatwall above worksurface is nominally 15"h for 42" high panels; and 22 1/2"h for both 49" and 64" high panels. Fabric insert begins just below worksurface height to base raceway. (64" high panels also have a fabric insert above the slatwall section.)
R3 AutoStrada w/generation 3 frame	1. Height	Panels with slatwall one or both sides do not accommodate ported power or data modules.
R2 Base raceway both sides	2. Width	
S Slatwall/Fabric combo both sides	3. Extruded Aluminum Top Trim <i>E - default</i>	42" and 49" panels on this page will not accept frameless glass add-ups.
X Fabric/Slatwall combo side 1	4. Finish, Aluminum trim (top trim and tile dividers/reveals) <i>Anodized aluminum or painted finish options listed on page 10 excluding silver.</i>	
X Fabric/Slatwall combo side 2	5. Base raceway height <i>4 = 4" h, default</i>	Black PVC hookstrip reveals should be ordered for both panel sides with slatwall.
42 42" high	6. Knock-out option <i>K = with knock-outs</i> <i>N = no knock-outs</i>	Panels on this page will accept standard Reff System stacking window modules.
18 18" wide	7. Base raceway finish <i>painted or plated finish options only</i>	
E Extruded Aluminum top trim	8. Fabric selection (side 1)	
AA Top Trim anodized aluminum finish	9. Fabric selection (side 2)	
4 4" high base raceway	10. Finish, Slatwall <i>Anodized aluminum or painted finish options listed on page 10 excluding silver</i>	
K Knock-outs in base raceway		
613 Finish, base raceway	See page 8 for finish options applicable.	
W359- Finish, Fabric (side 1)		
W359- Finish, Fabric (side 2)		
AA Finish, Slatwall		

description	w	d	pattern no.	clear temp	GL13	list
Frameless glass add-up 8"h, for panels	18"		R3GAU0818 () ()	\$296.	\$370.	
	20"		R3GAU0820 () ()	315.	400.	
	24"		R3GAU0824 () ()	334.	434.	
	30"		R3GAU0830 () ()	371.	492.	
	36"		R3GAU0836 () ()	407.	551.	
	42"		R3GAU0842 () ()	469.	639.	
	48"		R3GAU0848 () ()	485.	681.	
Frameless glass add-up 12"h, for panels	18"		R3GAU1218 () ()	323.	443.	
	20"		R3GAU1220 () ()	352.	486.	
	24"		R3GAU1224 () ()	372.	532.	
	30"		R3GAU1230 () ()	417.	616.	
	36"		R3GAU1236 () ()	463.	698.	
	42"		R3GAU1242 () ()	536.	810.	
	48"		R3GAU1248 () ()	561.	879.	
Frameless glass add-up 15"h, for panels	18"		R3GAU1518 () ()	334.	471.	
	20"		R3GAU1520 () ()	363.	522.	
	24"		R3GAU1524 () ()	389.	571.	
	30"		R3GAU1530 () ()	436.	665.	
	36"		R3GAU1536 () ()	484.	756.	
	42"		R3GAU1542 () ()	560.	881.	
	48"		R3GAU1548 () ()	593.	955.	
Frameless glass add-up 8"h, for panels for hi/lo condition no post involved	18"		R3GAUHL0818 () ()	296.	370.	
	20"		R3GAUHL0820 () ()	315.	400.	
	24"		R3GAUHL0824 () ()	334.	434.	
	30"		R3GAUHL0830 () ()	371.	492.	
	36"		R3GAUHL0836 () ()	407.	551.	
	42"		R3GAUHL0842 () ()	469.	639.	
	48"		R3GAUHL0848 () ()	485.	681.	

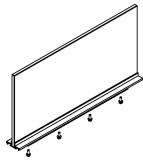

Panels

Order Code	Specification Information	Application Notes
Example: R3GAU0818GL13AA	<i>To order please specify pattern number including:</i>	<i>To order please specify pattern number including configuration condition:</i>
R3 AutoStrada w/generation 3 frame	1. Height 08 = 42"h panel with add-up will align with top of 49"h panel 12 = 49"h panel with add-up will align with 48"h spine with spine add-up (overall height 61" nominal) 15 = add-up will align with tile segments of 34"h, 49"h or 64"h panels (ie: 34"h panel with add-up align to 49"h panel)	1 = add-up on one side of post 2 = add-ups on two sides of post 3 = add-ups on three sides of post (applicable T and X post caps) 4 = add-ups on four sides of post (applicable X post caps only)
GAU Glass add-up	2. Width	Finish: Anodized aluminum or painted finish options as listed on page 8 excluding silver
08 height	3. Glass Finish <i>TEMP</i> = clear tempered glass <i>GL13</i> = powder	
18 width	4. Finish, capture/trim <i>Anodized aluminum or painted finish options listed on page 8 excluding silver</i>	
GL13 glass finish, powder		
AA finish, capture/trim		

description	w	d	pattern no.	clear temp	GL13	list
Frameless glass add-up 12”h, for panels for hi/lo condition no post involved	18”		R3GAUHL1218 () ()	\$323.	\$443.	
	20”		R3GAUHL1224 () ()	352.	486.	
	24”		R3GAUHL1230 () ()	372.	532.	
	30”		R3GAUHL1230 () ()	417.	616.	
	36”		R3GAUHL1236 () ()	463.	698.	
	42”		R3GAUHL1242 () ()	536.	810.	
	48”		R3GAUHL1248 () ()	561.	879.	
Frameless glass add-up 15”h, for panels for hi/lo condition no post involved	18”		R3GAUHL1518 () ()	334.	471.	
	20”		R3GAUHL1520 () ()	363.	522.	
	24”		R3GAUHL1524 () ()	389.	571.	
	30”		R3GAUHL1530 () ()	436.	665.	
	36”		R3GAUHL1536 () ()	484.	756.	
	42”		R3GAUHL1542 () ()	560.	881.	
	48”		R3GAUHL1548 () ()	593.	955.	
Add-up Alignment Clip, pack of 10			R3AUAC10			31.

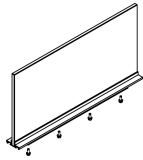

Alignment clips recommended to ensure glass alignment of add-up modules in side by side applications

Order Code	Specification Information	Application Notes
Example: R3GAU0818GL13AA R3 AutoStrada w/generation 3 frame GAU Glass add-up 08 height 18 width GL13 glass finish, powder AA finish, capture/trim	<p><i>To order please specify pattern number including:</i></p> <ol style="list-style-type: none"> Height 08 = 42”h panel with add-up will align with top of 49”h panel 12 = 49”h panel with add-up will align with 48”h spine with spine add-up (overall height 61” nominal) 15 = add-up will align with tile segments of 34”h, 49”h or 64”h panels (ie: 34”h panel with add-up align to 49”h panel) Width Glass Finish <i>TEMP = clear tempered glass</i> <i>GL13 = powder</i> Finish, capture/trim <i>Anodized aluminum or painted finish options listed on page 8 excluding silver</i> 	<p>Frameless glass add-ups only for use with non-progressive tile construction panels with at least one side fabric tiles.</p> <p>Panel frames are not pre-drilled to accept frameless glass add-ups. Frame requires drilling on site for installation.</p> <p>Frameless glass add-ups must correspond to width of panel securing to. Do not span multiple panels with one longer glass add-up.</p> <p>Frameless glass add-ups can not be installed on panel when panel attached to storage anchored cabinet.</p> <p><i>To order please specify pattern number including configuration condition:</i></p> <p>1 = add-up on one side of post 2 = add-ups on two sides of post 3 = add-ups on three sides of post (applicable T and X post caps) 4 = add-ups on four sides of post (applicable X post caps only)</p> <p>Finish: Anodized aluminum or painted finish options as listed on page 8 excluding silver</p>

description	application	pattern no.	AA	P1	P2	P3	G1	G2	G3
Panel attachment kit for glass gallery screen	for 42" h panel attachment	A1GGPC4234(L/R)()	\$756.	\$643.	\$643.	\$681.			
	for 46" h panel attachment	A1GGPC4934(L/R)()	756.	643.	643.	681.			
Spine attachment kit for glass gallery screen	mid span/ off modular	A1GGSPSC30(L/R)()	788.	670.	670.	708.			
	spine end starter	A1GGSE30(L/R)() ()	766.	652.	652.	691.			
Glass, for panel based	for 42" h x 60" w	A1PGG4260()					912.	1,376.	1,853.
	for 42" h x 72" w	A1PGG4272()					1,045.	1,596.	2,210.
	for 49" h x 60" w	A1PGG4960()					1,032.	1,580.	2,150.
	for 49" h x 72" w	A1PGG4972()					1,186.	1,841.	2,522.
Glass, for spine based	for 48" h x 60" w	A1SGG4860()					1,004.	1,529.	2,075.
	for 48" h x 72" w	A1SGG4872()					1,151.	1,779.	2,435.

Example:	A1GGPC4234
A	AutoStrada
1	Generation 1
GG	Gallery screen, glass
PC	Panel post connector
42	42" h panel attachment (includes Hi/low trim)
34	34" high nominal
(L/R)	Left or right hand connection
()	Finish divider, capture

1.L/R- Left or right hand connection
 If left hand, worksurface on right side of glass
 If right hand, worksurface on left side of glass

2.Finish divider capture
 AA and all core paint options except 613

Glass Finish
 G1=Clear Temp glass
 G2=Architectural
 G3=Color

Glass Gallery Screen Panel attachment kit includes finished connection to panel post and end capture for glass.

Glass Gallery Screen Spine attachment kit includes finished connection to spine and end capture for glass.

Glass to align top of panel insert, below top trim for panel base.

Glass to align top of spine cover, below crown or at horizontal channel at nominal 48" high if 64" spine.

Posts, panels

T post

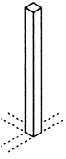
description	h	pattern no.	list
 T post, tiled laminate (no base plate)	34"	R3R0TTL34 () () ()	\$233.
	42"	R3R0TTL42 () () ()	257.
	49"	R3R0TTL49 () () ()	290.
	64"	R3R0TTL64 () () ()	321.
T post, tiled V1 techwood (no base plate)	34"	R3R0TT134 () () ()	246.
	42"	R3R0TT142 () () ()	269.
	49"	R3R0TT149 () () ()	305.
	64"	R3R0TT164 () () ()	338.
T post, tiled V2 natural (no base plate)	34"	R3R0TT234 () () ()	270.
	42"	R3R0TT242 () () ()	296.
	49"	R3R0TT249 () () ()	333.
	64"	R3R0TT264 () () ()	370.
T post, tiled V3 exotic (no base plate)	34"	R3R0TT334 () () ()	354.
	42"	R3R0TT342 () () ()	386.
	49"	R3R0TT349 () () ()	437.
	64"	R3R0TT364 () () ()	483.
T post, monolithic V1 techwood (no base plate)	42"	R3R0TP142 () () ()	269.
	49"	R3R0TP149 () () ()	305.

Order Code	Specification Information	Application Notes
Example: R3R0TTL34E2AA118	<i>To order please specify pattern number including:</i>	5. Finish, Aluminum trim (top cap and reveals) <i>Anodized aluminum or painted finish options listed on page 10 excluding silver</i>
R3 AutoStrada w/generation 3 post	1. Surface <i>L = Painted to match laminate</i>	* Painted to match laminate.
R0 No base raceway exposed	<i>V1 = V1 Techwood</i>	
T T post	<i>V2 = V2 Natural</i>	
T Tiled	<i>V3 = V3 Exotic</i>	
L Laminate match	2. Height	6. Finish, Tiles <i>Laminate *, V1, V2 or V3 finish</i>
34 34" high	3. Extruded aluminum top cap <i>E = default</i>	See page 8 for finish options applicable.
E Extruded aluminum top cap	4. Top Cap Configuration <i>1 = Regular L, finished 2 adjacent sides</i>	
2 Regular T cap configuration	<i>2 = Regular T, finished one side</i>	
AA Finish, top cap and reveal	<i>3 = Regular X, no sides finished</i>	
118 Finish, tiles	<i>4 = Hi/Lo cap at direction change, finished 3 sides</i>	
	<i>5 = Hi/Lo cap in line, finished 2 opposite sides</i>	

Posts, panels

T post

description	h	pattern no.	list
T post, monolithic V2 natural (no base plate)	42"	R3R0TP242 () () ()	\$296.
	49"	R3R0TP249 () () ()	333.
T post, monolithic laminate (no base plate)	42"	R3R0TPL42 () () ()	257.
	49"	R3R0TPL49 () () ()	290.
T post, monolithic V3 exotic (no base plate)	42"	R3R0TP342 () () ()	386.
	49"	R3R0TP349 () () ()	437.

Order Code	Specification Information	Application Notes
Example: R3R0TTL34E2AA118	<i>To order please specify pattern number including:</i>	
R3 AutoStrada w/generation 3 post	1. Surface <i>L = Painted to match laminate</i>	5. Finish, Aluminum trim (top cap and reveals) <i>Anodized aluminum or painted finish options listed on page 10 excluding silver</i>
R0 No base raceway exposed	<i>V1 = V1 Techwood</i>	6. Finish, Tiles <i>Laminate *, V1, V2 or V3 finish</i>
T T post	<i>V2 = V2 Natural</i>	
T Tiled	<i>V3 = V3 Exotic</i>	See page 8 for finish options applicable.
L Laminate match	2. Height	
34 34" high	3. Extruded aluminum top cap <i>E = default</i>	
E Extruded aluminum top cap	4. Top Cap Configuration <i>1 = Regular L, finished 2 adjacent sides</i>	
2 Regular T cap configuration	<i>2 = Regular T, finished one side</i>	
AA Finish, top cap and reveal	<i>3 = Regular X, no sides finished</i>	
118 Finish, tiles	<i>4 = Hi/Lo cap at direction change, finished 3 sides</i>	
	<i>5 = Hi/Lo cap in line, finished 2 opposite sides</i>	

Posts, panels

L post, no base plates

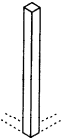
description	h	pattern no.	list
 L post, tiled (to match) laminate (no base plate)	34"	R3R0LTL34 () () () ()	\$194.
	42"	R3R0LTL42 () () () ()	290.
	49"	R3R0LTL49 () () () ()	321.
	64"	R3R0LTL64 () () () ()	358.
	Tiled laminate both sides		
L post, tiled V1 techwood (no base plate)	34"	R3R0LT134 () () () ()	205.
	42"	R3R0LT142 () () () ()	305.
	49"	R3R0LT149 () () () ()	338.
	64"	R3R0LT164 () () () ()	374.
	Tiled V1 both sides		
L post, tiled V2 natural (no base plate)	34"	R3R0LT234 () () () ()	224.
	42"	R3R0LT242 () () () ()	333.
	49"	R3R0LT249 () () () ()	370.
	64"	R3R0LT264 () () () ()	411.
	Tiled V2 both sides		
L post, tiled V3 exotic (no base plate)	34"	R3R0LT334 () () () ()	289.
	42"	R3R0LT342 () () () ()	437.
	49"	R3R0LT349 () () () ()	483.
	64"	R3R0LT364 () () () ()	534.
	Tiled V3 both sides		
L post, monolithic (to match) laminate (no base plate)	42"	R3R0LPL42 () () () ()	290.
	49"	R3R0LPL49 () () () ()	321.

Order Code	Specification Information	Application Notes
Example: R3R0LTL34E1AA118	<i>To order please specify pattern number including:</i>	5. Post cover configuration
R3 AutoStrada w/generation 3 post	1. Finish type tiles <i>L = Painted to match laminate</i>	1 = 1 piece (same finish both sides)
R0 No base raceway exposed	<i>V1 = V1 Techwood</i>	2 = 2 piece (same or different finish per side)
L L post	<i>V2 = V2 Natural</i>	6. Finish, Aluminum trim (top cap and reveals)
T Tiled (both faces)	<i>V3 = V3 Exotic</i>	<i>Anodized aluminum or painted finish options listed on page 10 excluding silver</i>
L Laminate match	2. Height	7. Finish, Side 1
34 34" high	3. Extruded aluminum top cap <i>E = default</i>	<i>Laminate *, V1, V2 or V3 finish</i>
E Extruded aluminum top cap	4. Top Cap Configuration <i>1 = Regular L, finished 2 adjacent sides</i>	8. Finish, Side 2 (side 2 finish applicable only when 2 piece post cover configuration selected)
1 Regular L cap configuration	<i>2 = Regular T, finished one side</i>	<i>Laminate *, V1, V2, or V3 finish</i>
AA Finish, top cap and reveal	<i>3 = Regular X, no sides finished</i>	
118 Finish, tiles	<i>4 = Hi/Lo cap at direction change, finished 3 sides</i>	
	<i>5 = Hi/Lo cap in line, finished 2 opposite sides</i>	
		See page 8 for finish options applicable.

Posts, panels

L post, no base plates

description	h	pattern no.	list
L post, monolithic V1 techwood (no base plate)	42"	R3R0LP142 () () () ()	\$305.
	49"	R3R0LP149 () () () ()	338.
L post, monolithic V2 natural (no base plate)	42"	R3R0LP242 () () () ()	333.
	49"	R3R0LP249 () () () ()	370.
L post, monolithic V3 exotic (no base plate)	42"	R3R0LP342 () () () ()	437.
	49"	R3R0LP349 () () () ()	483.

Order Code	Specification Information	Application Notes
Example: R3R0LTL34E1AA118	<i>To order please specify pattern number including:</i>	
R3 AutoStrada w/generation 3 post	1. Finish type tiles <i>L = Painted to match laminate</i>	5. Post cover configuration 1 = 1 piece (same finish both sides) 2 = 2 piece (same or different finish per side)
R0 No base raceway exposed	<i>V1 = V1 Techwood</i>	6. Finish, Aluminum trim (top cap and reveals) <i>Anodized aluminum or painted finish options listed on page 10 excluding silver</i>
L L post	<i>V2 = V2 Natural</i>	7. Finish, Side 1 <i>Laminate *, V1, V2 or V3 finish</i>
T Tiled (both faces)	2. Height	8. Finish, Side 2 (side 2 finish applicable only when 2 piece post cover configuration selected) <i>Laminate *, V1, V2, or V3 finish</i>
L Laminate match	3. Extruded aluminum top cap <i>E = default</i>	
34 34" high	4. Top Cap Configuration <i>1 = Regular L, finished 2 adjacent sides</i>	
E Extruded aluminum top cap	<i>2 = Regular T, finished one side</i>	
1 Regular L cap configuration	<i>3 = Regular X, no sides finished</i>	
AA Finish, top cap and reveal	<i>4 = Hi/Lo cap at direction change, finished 3 sides</i>	
118 Finish, tiles	<i>5 = Hi/Lo cap in line, finished 2 opposite sides</i>	

See page 8 for finish options applicable.

Posts, panels

L post, one face only w/base plate

description	h	pattern no.	list
L post, tiled laminate left face w/o base, fabric/mono right face w/base	34"	R3R1LALL34 () () () () () ()	\$194.
	42"	R3R1LALL42 () () () () () ()	290.
	49"	R3R1LALL49 () () () () () ()	321.
	64"	R3R1LALL64 () () () () () ()	358.

Laminate side 1, fabric side 2

L post, tiled laminate right face w/o base, fabric/mono left face w/base	34"	R3R1LARL34 () () () () () ()	194.
	42"	R3R1LARL42 () () () () () ()	290.
	49"	R3R1LARL49 () () () () () ()	321.
	64"	R3R1LARL64 () () () () () ()	358.



Fabric side 1, laminate side 2

L post, tiled V1 techwood left face w/o base, fabric/mono right face w/base	34"	R3R1LAL134 () () () () () ()	205.
	42"	R3R1LAL142 () () () () () ()	305.
	49"	R3R1LAL149 () () () () () ()	338.
	64"	R3R1LAL164 () () () () () ()	374.

V1 side 1, fabric side 2

L post, tiled V1 techwood right face w/o base, fabric/mono left face w/base	34"	R3R1LAR134 () () () () () ()	205.
	42"	R3R1LAR142 () () () () () ()	305.
	49"	R3R1LAR149 () () () () () ()	338.
	64"	R3R1LAR164 () () () () () ()	374.



Fabric side 1, V1 side 2

Order Code	Specification Information	Application Notes
Example: R3R1LALL34E1AA4N 613118W359-	To order please specify pattern number including:	6. Finish, Aluminum trim (top cap and reveals) Anodized aluminum or painted finish options listed on page 10 excluding silver
R3 AutoStrada w/generation 3 post	1. Tiled side L = Tiled left face, monolithic right face R = Tiled right face, monolithic left face	7. Base height 4 = 4" h, default
R1 Base raceway, mono side	2. Finish type tiled side L = Painted to match laminate V1 = V1 Techwood V2 = V2 Natural V3 = V3 Exotic	8. Base infeed - applicable for face with base plate only N = None F = Base infeed fabric face side
L L post	3. Height	9. Finish, base raceway
A Tiled one side/Mono other	4. Extruded aluminum top cap E = default	10. Finish, Side 1 If side 1 tiled specify laminate *, V1, V2 or V3 finish; If side 1 monolithic specify fabric
L Left face tiled	5. Top Cap Configuration 1 = Regular L, finished 2 adjacent sides 2 = Regular T, finished one side 3 = Regular X, no sides finished 4 = Hi/Lo cap at direction change, finished 3 sides 5 = Hi/Lo cap in line, finished 2 opposite sides	11. Finish, Side 2 If side 2 tiled specify laminate *, V1, V2 or V3 finish; If side 2 monolithic specify fabric
L Laminate match		
34 34" high		
E Extruded aluminum top cap		
1 Regular L cap configuration		
AA Finish, top cap and reveal		
4 4" high base		
N No base infeed		
613 Finish, base plate		
118 Finish, tiles		
W359- Finish, fabric (mono side)		

Posts, panels

L post, one face only w/base plate

description	h	pattern no.	list
L post, tiled V2 natural left face w/o base, fabric/mono right face w/base	34"	R3R1LAL234 () () () () () ()	\$224.
	42"	R3R1LAL242 () () () () () ()	333.
	49"	R3R1LAL249 () () () () () ()	370.
	64"	R3R1LAL264 () () () () () ()	411.

V2 side 1, fabric side 2

L post, tiled V2 natural right face w/o base, fabric/mono left face w/base	34"	R3R1LAR234 () () () () () ()	224.
	42"	R3R1LAR242 () () () () () ()	333.
	49"	R3R1LAR249 () () () () () ()	370.
	64"	R3R1LAR264 () () () () () ()	411.



Fabric side 1, V2 side 2

L post, tiled V3 exotic left face w/o base, fabric/mono right face w/base	34"	R3R1LAL334 () () () () () ()	289.
	42"	R3R1LAL342 () () () () () ()	437.
	49"	R3R1LAL349 () () () () () ()	483.
	64"	R3R1LAL364 () () () () () ()	534.

V3 side 1, fabric side 2



L post, tiled V3 exotic right face w/o base, fabric/mono left face w/base	34"	R3R1LAR334 () () () () () ()	289.
	42"	R3R1LAR342 () () () () () ()	437.
	49"	R3R1LAR349 () () () () () ()	483.
	64"	R3R1LAR364 () () () () () ()	534.



Fabric side 1, V3 side 2

Order Code	Specification Information	Application Notes
Example: R3R1LALL34E1AA4N 613118W359-	To order please specify pattern number including:	Aluminum vertical hookstrip cover ordered separately.
R3 AutoStrada w/generation 3 post	1. Tiled side <i>L = Tiled left face, monolithic right face</i> <i>R = Tiled right face, monolithic left face</i>	* Painted to match laminate.
R1 Base raceway, mono side	2. Finish type tiled side <i>L = Painted to match laminate</i> <i>V1 = V1 Techwood</i> <i>V2 = V2 Natural</i> <i>V3 = V3 Exotic</i>	See page 8 for finish options applicable.
L L post	3. Height	
A Tiled one side/Mono other	4. Extruded aluminum top cap <i>E = default</i>	
L Left face tiled	5. Top Cap Configuration <i>1 = Regular L, finished 2 adjacent sides</i> <i>2 = Regular T, finished one side</i> <i>3 = Regular X, no sides finished</i> <i>4 = Hi/Lo cap at direction change, finished 3 sides</i> <i>5 = Hi/Lo cap in line, finished 2 opposite sides</i>	
L Laminate match	6. Finish, Aluminum trim (top cap and reveals) <i>Anodized aluminum or painted finish options listed on page 10 excluding silver</i>	
34 34" high	7. Base height <i>4 = 4" h, default</i>	
E Extruded aluminum top cap	8. Base infeed - applicable for face with base plate only <i>N = None</i> <i>F = Base infeed fabric face side</i>	
1 Regular L cap configuration	9. Finish, base raceway	
AA Finish, top cap and reveal	10. Finish, Side 1 <i>If side 1 tiled specify laminate *, V1, V2 or V3 finish;</i> <i>If side 1 monolithic specify fabric</i>	
4 4" high base	11. Finish, Side 2 <i>If side 2 tiled specify laminate *, V1, V2 or V3 finish;</i> <i>If side 2 monolithic specify fabric</i>	
N No base infeed		
613 Finish, base plate		
118 Finish, tiles		
W359- Finish, fabric (mono side)		

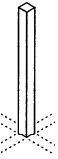
Posts, panels x and straight posts

description	h	pattern no.	list
 X post, universal aluminum top cap	34"	R3X34E ()	\$220.
	42"	R3X42E ()	237.
	49"	R3X49E ()	254.
	64"	R3X64E ()	285.
 Straight post, tiled laminate face w/o base, fabric/mono face w/base	34"	R3R1SAL34 () () () () ()	194.
	42"	R3R1SAL42 () () () () ()	290.
	49"	R3R1SAL49 () () () () ()	321.
	64"	R3R1SAL64 () () () () ()	358.
Straight post, tiled V1 techwood face w/o base, fabric/mono face w/base	34"	R3R1SA134 () () () () ()	205.
	42"	R3R1SA142 () () () () ()	305.
	49"	R3R1SA149 () () () () ()	338.
	64"	R3R1SA164 () () () () ()	374.
Straight post, tiled V2 natural face w/o base, fabric/mono face w/base	34"	R3R1SA234 () () () () ()	224.
	42"	R3R1SA242 () () () () ()	333.
	49"	R3R1SA249 () () () () ()	370.
	64"	R3R1SA264 () () () () ()	411.

Order Code	Order Code	Specification Information
Example: R3X34E3AA	Example: R3R1SAL34E1AA4 N613118W359-	<i>To order please specify pattern number including:</i>
R3 AutoStrada w/generation 3 Post	R3 AutoStrada w/generation 3 Post	1. Post type <i>X = X post S = Straight post</i>
X X post	R1 Base raceway, fabric mono side	2. Tiled surface type (applicable straight posts only, embedded in pattern number) <i>L = Painted to match laminate 1 = V1 Techwood 2 = V2 Natural 3 = V3 Exotic</i>
34 34" high	S Straight post	3. Height
E Extruded aluminum top cap	A Tiled one face/mono other	4. Extruded aluminum top cap <i>E = default</i>
3 Regular X cap configuration	L Tiled face, Laminate match	5. Top Cap Configuration <i>1 = Regular L, finished 2 adjacent sides 2 = Regular T, finished one side 3 = Regular X, no sides finished 4 = Hi/Lo cap at direction change, finished 3 sides 5 = Hi/Lo cap in line, finished 2 opposite sides</i>
AA Finish, aluminum top cap	34 34" high	6. Finish, Aluminum top cap and reveals <i>Anodized aluminum or painted finish options listed on page 10 excluding silver</i>
	E Extruded aluminum top cap	7. Base height <i>4 = 4" h, default</i>
	1 Reg L cap config	8. Base infeed (applicable straight posts only) <i>N = None F = Base infeed fabric face side</i>
	AA Finish, aluminum top cap & reveal	9. Finish, base raceway (applicable straight posts only)
	4 4" high base	10. Finish, Tiled side <i>Laminate *, V1, V2 or V3 finish</i>
	N No base infeed	11. Finish, mono side <i>Fabric selection</i>
	613 Finish, base raceway	See page 8 for finish options applicable.
	118 Finish, tiled side	Aluminum vertical hookstrip cover ordered separately.
	W359- Finish, mono side	* Painted to match laminate.

Posts, panels *x and straight posts*

description	h	pattern no.	list
Straight post, tiled V3 exotic face w/o base, fabric/mono face w/base	34"	R3R1SA334 () () () () ()	\$289.
	42"	R3R1SA342 () () () () ()	437.
	49"	R3R1SA349 () () () () ()	483.
	64"	R3R1SA364 () () () () ()	534.
Straight post, monolithic (to match) laminate (no base plate)	42"	R3R0SPL42 () () ()	290.
	49"	R3R0SPL49 () () ()	321.
Straight post, monolithic V1 techwood (no base plate)	42"	R3R0SP142 () () ()	305.
	49"	R3R0SP149 () () ()	338.
Straight post, monolithic V2 natural (no base plate)	42"	R3R0SP242 () () ()	333.
	49"	R3R0SP249 () () ()	370.
Straight post, monolithic V3 exotic (no base plate)	42"	R3R0SP342 () () ()	437.
	49"	R3R0SP349 () () ()	483.

Order Code	Order Code	Specification Information
Example: R3X34E3AA	Example: R3R1SAL34E1AA4 N613118W359-	<i>To order please specify pattern number including:</i>
R3 AutoStrada w/generation 3 Post	R3 AutoStrada w/generation 3 Post	6. Finish, Aluminum top cap and reveals <i>Anodized aluminum or painted finish options listed on page 10 excluding silver</i>
X X post	R1 Base raceway, fabric mono side	7. Base height <i>4 = 4" h, default</i>
34 34" high	S Straight post	8. Base infeed (applicable straight posts only) <i>N = None</i>
E Extruded aluminum top cap	A Tiled one face/mono other	9. Finish, base raceway (applicable straight posts only)
3 Regular X cap configuration	L Tiled face, Laminate match	10. Finish, Tiled side <i>Laminate *, V1, V2 or V3 finish</i>
AA Finish, aluminum top cap	34 34" high	11. Finish, mono side <i>Fabric selection</i>
	E Extruded aluminum top cap	See page 8 for finish options applicable.
	1 Reg L cap config	Aluminum vertical hookstrip cover ordered separately.
	AA Finish, aluminum top cap & reveal	* Painted to match laminate.
	4 4" high base	
	N No base infeed	
	613 Finish, base raceway	
	118 Finish, tiled side	
	W359- Finish, mono side	
		1. Post type <i>X = X post</i> <i>S = Straight post</i>
		2. Tiled surface type (applicable straight posts only, embedded in pattern number) <i>L = Painted to match laminate</i> <i>1 = V1 Techwood</i> <i>2 = V2 Natural</i> <i>3 = V3 Exotic</i>
		3. Height
		4. Extruded aluminum top cap <i>E = default</i>
		5. Top Cap Configuration <i>1 = Regular L, finished 2 adjacent sides</i> <i>2 = Regular T, finished one side</i> <i>3 = Regular X, no sides finished</i> <i>4 = Hi/Lo cap at direction change, finished 3 sides</i> <i>5 = Hi/Lo cap in line, finished 2 opposite sides</i>

Posts, panels

120° post, tiled

description	h	pattern no.	list
120° post, tiled (to match) laminate (no base plate)	34"	R3R0120VTL34() () () () ()	\$653.
	42"	R3R0120VTL42() () () () ()	743.
	49"	R3R0120VTL49() () () () ()	766.
	64"	R3R0120VTL64() () () () ()	909.
Tiled laminate both sides			
120° post, tiled V1 techwood (no base plate)	34"	R3R0120VT134() () () () ()	665.
	42"	R3R0120VT142() () () () ()	754.
	49"	R3R0120VT149() () () () ()	778.
	64"	R3R0120VT164() () () () ()	919.
Tiled V1 both sides			
120° post, tiled V2 techwood (no base plate)	34"	R3R0120VT234() () () () ()	681.
	42"	R3R0120VT242() () () () ()	771.
	49"	R3R0120VT249() () () () ()	797.
	64"	R3R0120VT264() () () () ()	938.
Tiled V2 both sides			
120° post, tiled V3 techwood (no base plate)	34"	R3R0120VT334() () () () ()	714.
	42"	R3R0120VT342() () () () ()	805.
	49"	R3R0120VT349() () () () ()	830.
	64"	R3R0120VT364() () () () ()	971.
Tiled V3 both sides			

Order Code	Specification Information	Application Notes
Example: R3R0120VTL34E1AA118	<i>To order please specify pattern number including:</i>	5. Post cover configuration 1 = 1 piece
R3 AutoStrada w/generation 3 post	1. Height	Aluminum vertical hookstrip cover ordered separately.
RO No base raceway exposed	2. Finish type tiles <i>L = Painted to match laminate</i> <i>V1 = V1 Techwood</i> <i>V2 = V2 Natural</i> <i>V3 = V3 Exotic</i>	* Painted to match laminate.
120V V post	<i>F = Fabric</i>	
T Tiled (both faces)	3. Extruded aluminum top cap <i>E = default</i>	
L Laminate match	4. Top Cap Configuration <i>1 = Regular L, finished 2 adjacent sides</i> <i>2 = Regular T, finished one side</i> <i>3 = Regular X, no sides finished</i> <i>4 = Hi/Lo cap at direction change, finished 3 sides</i> <i>5 = Hi/Lo cap in line, finished 2 opposite sides</i>	6. Finish, Aluminum trim (top cap and reveals) <i>Anodized aluminum or painted finish options listed on page 10 excluding silver</i>
34 34" high		7. Finish, <i>Laminate *, V1, V2, V3 finish or Fabric</i>
E Extruded aluminum top cap		See page 8 for finish options applicable.
1 Regular L cap configuration		
AA Finish, top cap and reveal		
118 Finish, tiles		

Posts, panels

120° post, monolithic

description	h	pattern no.	list
120° post, monolithic (to match laminate (no base plate))	34"	R3R0120VPL34() () () () ()	\$591.
	42"	R3R0120VPL42() () () () ()	620.
	49"	R3R0120VPL49() () () () ()	644.
	64"	R3R0120VPL64() () () () ()	725.
Monolithic laminate both sides			
120° post, monolithic V1 techwood (no base plate)	34"	R3R0120VP134() () () () ()	602.
	42"	R3R0120VP142() () () () ()	630.
	49"	R3R0120VP149() () () () ()	655.
	64"	R3R0120VP164() () () () ()	735.
Monolithic V1 both sides			
120° post, monolithic V2 techwood (no base plate)	34"	R3R0120VP234() () () () ()	620.
	42"	R3R0120VP242() () () () ()	647.
	49"	R3R0120VP249() () () () ()	672.
	64"	R3R0120VP264() () () () ()	753.
Monolithic V2 both sides			
120° post, monolithic V3 techwood (no base plate)	34"	R3R0120VP334() () () () ()	653.
	42"	R3R0120VP342() () () () ()	681.
	49"	R3R0120VP349() () () () ()	705.
	64"	R3R0120VP364() () () () ()	786.
Monolithic V3 both sides			

Panels

Order Code	Specification Information	Application Notes
Example: R3R0135VT34E1AA118	<i>To order please specify pattern number including:</i>	5. Post cover configuration 1 = 1 piece
R3 AutoStrada w/generation 3 post	1. Height	Aluminum vertical hookstrip cover ordered separately.
R0 No base raceway exposed	2. Finish type tiles <i>L = Painted to match laminate</i>	* Painted to match laminate.
135V V post	<i>V1 = V1 Techwood</i>	
T Tiled (both faces)	<i>V2 = V2 Natural</i>	
L Laminate match	<i>V3 = V3 Exotic</i>	
34 34" high	<i>F = Fabric</i>	
E Extruded aluminum top cap	3. Extruded aluminum top cap <i>E = default</i>	6. Finish, Aluminum trim (top cap and reveals) <i>Anodized aluminum or painted finish options listed on page 10 excluding silver</i>
1 Regular L cap configuration	4. Top Cap Configuration <i>1 = Regular L, finished 2 adjacent sides</i>	7. Finish, <i>Laminate *, V1, V2, V3 finish or Fabric</i>
AA Finish, top cap and reveal	<i>2 = Regular T, finished one side</i>	See page 8 for finish options applicable.
118 Finish, tiles	<i>3 = Regular X, no sides finished</i>	
	<i>4 = Hi/Lo cap at direction change, finished 3 sides</i>	
	<i>5 = Hi/Lo cap in line, finished 2 opposite sides</i>	

Posts, panels

135° post, tiled

description	h	pattern no.	list
135° post, tiled (to match) laminate (no base plate)	34"	R3R0135VTL34() () () () ()	\$610.
	42"	R3R0135VTL42() () () () ()	655.
	49"	R3R0135VTL49() () () () ()	696.
	64"	R3R0135VTL64() () () () ()	803.
Tiled laminate both sides			
<hr/>			
135° post, tiled V1 techwood (no base plate)	34"	R3R0135VT134() () () () ()	621.
	42"	R3R0135VT142() () () () ()	667.
	49"	R3R0135VT149() () () () ()	707.
	64"	R3R0135VT164() () () () ()	813.
Tiled V1 both sides			
<hr/>			
135° post, tiled V2 techwood (no base plate)	34"	R3R0135VT234() () () () ()	636.
	42"	R3R0135VT242() () () () ()	683.
	49"	R3R0135VT249() () () () ()	725.
	64"	R3R0135VT264() () () () ()	831.
Tiled V2 both sides			
<hr/>			
135° post, tiled V3 techwood (no base plate)	34"	R3R0135VT334() () () () ()	671.
	42"	R3R0135VT342() () () () ()	718.
	49"	R3R0135VT349() () () () ()	758.
	64"	R3R0135VT364() () () () ()	864.
Tiled V3 both sides			

Order Code	Specification Information	Application Notes
Example: R3R0135VTL34E1AA118	<i>To order please specify pattern number including:</i>	5. Post cover configuration 1 = 1 piece
R3 AutoStrada w/generation 3 post	1. Height	Aluminum vertical hookstrip cover ordered separately.
RO No base raceway exposed	2. Finish type tiles <i>L = Painted to match laminate</i> <i>V1 = V1 Techwood</i> <i>V2 = V2 Natural</i> <i>V3 = V3 Exotic</i>	* Painted to match laminate.
135V V post	<i>F = Fabric</i>	
T Tiled (both faces)	3. Extruded aluminum top cap <i>E = default</i>	
L Laminate match	4. Top Cap Configuration <i>1 = Regular L, finished 2 adjacent sides</i> <i>2 = Regular T, finished one side</i> <i>3 = Regular X, no sides finished</i> <i>4 = Hi/Lo cap at direction change, finished 3 sides</i> <i>5 = Hi/Lo cap in line, finished 2 opposite sides</i>	6. Finish, Aluminum trim (top cap and reveals) <i>Anodized aluminum or painted finish options listed on page 10 excluding silver</i>
34 34" high		7. Finish, <i>Laminate *, V1, V2, V3 finish or Fabric</i>
E Extruded aluminum top cap		See page 8 for finish options applicable.
1 Regular L cap configuration		
AA Finish, top cap and reveal		
118 Finish, tiles		

Posts, panels

135° post, monolithic

description	h	pattern no.	list
135° post, monolithic (to match laminate (no base plate))	34"	R3R0135VPL34() () () ()	\$691.
	42"	R3R0135VPL42() () () ()	850.
	49"	R3R0135VPL49() () () ()	860.
	64"	R3R0135VPL64() () () ()	1,048.
Monolithic laminate both sides			
135° post, monolithic V1 techwood (no base plate)	34"	R3R0135VP134() () () ()	702.
	42"	R3R0135VP142() () () ()	861.
	49"	R3R0135VP149() () () ()	870.
	64"	R3R0135VP164() () () ()	1,060.
Monolithic V1 both sides			
135° post, monolithic V2 techwood (no base plate)	34"	R3R0135VP234() () () ()	720.
	42"	R3R0135VP242() () () ()	879.
	49"	R3R0135VP249() () () ()	888.
	64"	R3R0135VP264() () () ()	1,076.
Monolithic V2 both sides			
135° post, monolithic V3 techwood (no base plate)	34"	R3R0135VP334() () () ()	753.
	42"	R3R0135VP342() () () ()	911.
	49"	R3R0135VP349() () () ()	920.
	64"	R3R0135VP364() () () ()	1,110.
Monolithic V3 both sides			

Panels

Order Code	Specification Information	Application Notes
Example: R3R0135VT34E1AA118	<i>To order please specify pattern number including:</i>	
R3 AutoStrada w/generation 3 post	1. Height	5. Post cover configuration 1 = 1 piece
RO No base raceway exposed	2. Finish type tiles <i>L = Painted to match laminate</i> <i>V1 = V1 Techwood</i> <i>V2 = V2 Natural</i> <i>V3 = V3 Exotic</i>	6. Finish, Aluminum trim (top cap and reveals) <i>Anodized aluminum or painted finish options listed on page 10 excluding silver</i>
135V V post	<i>F = Fabric</i>	7. Finish, <i>Laminate *, V1, V2, V3 finish or Fabric</i>
T Tiled (both faces)	3. Extruded aluminum top cap <i>E = default</i>	See page 8 for finish options applicable.
L Laminate match	4. Top Cap Configuration <i>1 = Regular L, finished 2 adjacent sides</i> <i>2 = Regular T, finished one side</i> <i>3 = Regular X, no sides finished</i> <i>4 = Hi/Lo cap at direction change, finished 3 sides</i> <i>5 = Hi/Lo cap in line, finished 2 opposite sides</i>	Aluminum vertical hookstrip cover ordered separately. * Painted to match laminate.
34 34" high		
E Extruded aluminum top cap		
1 Regular L cap configuration		
AA Finish, top cap and reveal		
118 Finish, tiles		

Trim, panels
aluminum reveals

description	h	w	pattern no.	AA or paint
Aluminum hookstrip cover condition including stacking modules without exposed 4" raceway	33.5"		R2AHCN34 ()	\$69.
	41.5"		R2AHCN42 ()	84.
	48.5"		R2AHCN49 ()	98.
	63.5"		R2AHCN64 ()	130.
	78.5"		R2AHCN79 ()	165.
Aluminum hookstrip cover condition including stacking modules with 4"h base raceway.	30"		R2AHCR34 ()	70.
	38"		R2AHCR42 ()	85.
	45"		R2AHCR49 ()	100.
	60"		R2AHCR64 ()	133.
	75"		R2AHCR79 ()	167.
Alum horizontal reveal for between base panel and stacking window module		18"	R2AHWR18 ()	42.
		20"	R2AHWR20 ()	42.
		24"	R2AHWR24 ()	44.
		30"	R2AHWR30 ()	45.
		36"	R2AHWR36 ()	49.
		42"	R2AHWR42 ()	51.
Alum horizontal reveal for between two stacking window modules or between stacking and window modules or between two stacking modules		18"	R2AHBW18 ()	42.
		20"	R2AHBW20 ()	42.
		24"	R2AHBW24 ()	44.
		30"	R2AHBW30 ()	45.
		36"	R2AHBW36 ()	49.
		42"	R2AHBW42 ()	51.
Alum horizontal reveal for between base panel and stacking module (FL/F1/F2)		18"	R2AHSR18 ()	42.
		20"	R2AHSR20 ()	42.
		24"	R2AHSR24 ()	44.
		30"	R2AHSR30 ()	45.
		36"	R2AHSR36 ()	49.
		42"	R2AHSR42 ()	51.
	48"	R2AHSR48 ()	57.	

Order Code	Specification Information	Application Notes
Example: R2AHCN34 AA	<i>To order please specify pattern number including:</i> 1. Height or 2. Width 3. Finish <i>Anodized aluminum or painted finish options listed on page 8 excluding silver</i>	Aluminum hookstrip covers best suited for hard side (laminare, V1, V2 or V3) of panels only. Not recommended for fabric tiled side of panels. Recommend use on outside of stations/clusters only. When and where aluminum vertical hookstrip cover installed, forfeit panel hung capability.
R2 AutoStrada/Reff		
A Aluminum		
HC Hookstrip cover		
N No exposed raceway		
34 for 34"h		
AA Finish, anodized aluminum		

Trim, panels end trim and post trim

description	height	to height	width	pattern no.	list
 Aluminum end trim (full height), w/hookstrip	34"			A1FHETE34 ()	\$141.
	42"			A1FHETE42 ()	165.
	49"			A1FHETE49 ()	188.
	64"			A1FHETE64 ()	212.

 Aluminum end trim for Hi/Lo w/hookstrip (no post involved)	34"	42"		A1HLETE3442 ()	124.
	34"	49"		A1HLETE3449 ()	126.
	34"	64"		A1HLETE3464 ()	130.
	42"	49"		A1HLETE4249 ()	124.
	42"	64"		A1HLETE4264 ()	126.
	49"	64"		A1HLETE4964 ()	130.

 Post cover trim for Hi/Lo (post involved)	34"	42"		A1HLPTE3442 ()	33.
	34"	49"		A1HLPTE3449 ()	48.
	34"	64"		A1HLPTE3464 (F/T)() ()	97.
	42"	49"		A1HLPTE4249 ()	33.
	42"	64"		A1HLPTE4264 (F/T)() ()	81.
	49"	64"		A1HLPTE4964 ()	48.

Finish options fabric, V1, V2, V3 or painted to match laminate only, not available in AA anodized aluminum.

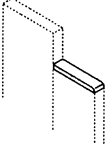
 Alum Top Trim for Hi/Lo condition, no post involved			18"	AHLTTE18 ()	24.
			20"	AHLTTE20 ()	27.
			24"	AHLTTE24 ()	30.
			30"	AHLTTE30 ()	35.
			36"	AHLTTE36 ()	46.
			42"	AHLTTE42 ()	47.
			48"	AHLTTE48 ()	63.

Order Code	Specification Information	Application Notes
Example: A1HLETE3442AA	To order please specify pattern number including:	
A AutoStrada		3. If (T) for tiled cover set, specify tile divider finish B - Black reveal E - painted silver to match AA extruded aluminum panel reveal or painted finish options list on page 8
1 Generation 1	1. Hi/Lo Condition ETE = End trim, no post w/hookstrip, height changes does not involve a post PTE = Post end trim, height change involves post	Aluminum end trim (full height), with hookstrip does not have base plate detail.
HL Hi/Lo		Post cover trim for hi/lo conditions are available in choice of fabric, V1, V2, V3 or painted to match laminate finishes only.
ET End Trim		
E Extruded Aluminum Profile		
3442 34"h to 42"h	2. Hi/Lo Height 3442 = 34"h to 42"h 3449 = 34"h to 49"h 3464 = 34"h to 64"h * 4249 = 42"h to 49"h 4264 = 42"h to 64"h * 4964 = 49"h to 64"h	4. Finish If end trim: Anodized aluminum or painted finish options listed on page 10 excluding silver
AA Finish, anodized aluminum		If post cover trim: () fabric, V1, V2, V3 or painted to match laminate
	*Applicable for post cover trim: Specify (F) for full monolithic cover or (T) for tiled cover set.	See page 8 for finish options applicable.

Trim, panels
full length top trim

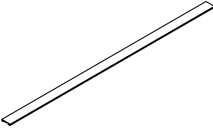
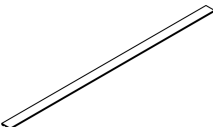
description	width	pattern no.	paint	AA
Continuous run top trim 	60"	A1CRTT60 ()	\$88.	\$88.
	66"	A1CRTT66 ()	88.	88.
	72"	A1CRTT72 ()	96.	96.
	78"	A1CRTT78 ()	96.	96.
	84"	A1CRTT84 ()	108.	108.
	90"	A1CRTT90 ()	145.	145.
	96"	A1CRTT96 ()	145.	145.
	102"	A1CRTT102 ()	n/a	156.
	108"	A1CRTT108 ()	n/a	156.
	114"	A1CRTT114 ()	n/a	156.
	120"	A1CRTT120 ()	n/a	156.
	126"	A1CRTT126 ()	n/a	165.
	132"	A1CRTT132 ()	n/a	165.
	138"	A1CRTT138 ()	n/a	172.
	144"	A1CRTT144 ()	n/a	172.
Continuous run top trim for Hi/Lo conditions 	60"	A1CHLTT60 ()	88.	88.
	66"	A1CHLTT66 ()	88.	88.
	72"	A1CHLTT72 ()	96.	96.
	78"	A1CHLTT78 ()	96.	96.
	84"	A1CHLTT84 ()	108.	108.
	90"	A1CHLTT90 ()	145.	145.
	96"	A1CHLTT96 ()	145.	145.
	102"	A1CHLTT102 ()	n/a	156.
	108"	A1CHLTT108 ()	n/a	156.
	114"	A1CHLTT114 ()	n/a	156.
	120"	A1CHLTT120 ()	n/a	156.
	126"	A1CHLTT126 ()	n/a	165.
	132"	A1CHLTT132 ()	n/a	165.
	138"	A1CHLTT138 ()	n/a	172.
	144"	A1CHLTT144 ()	n/a	172.

Order Code

Example:	A1CRTT60AA
A	AutoStrada
1	Generation 1
CR	Continuous Run
TT	Top Trim
60	60" wide
AA	Finish, anodized aluminum

Specification Information

To order please specify pattern number including:

1. Width
2. Finish, where applicable
Up to and including 96" w AA anodized aluminum or painted finish options listed on page 8 excluding silver

Only available in AA-anodized aluminum over 96" w

Application Notes

Continuous run top trim for spanning multiple panels with one piece of trim. Continuous run top trim ships with "W" clips which secures trim to panel frame.

Trim, panels

panel trim and install aids

description	type	h	pattern no.	list
Hookstrip cover strips, black flexible PVC	15 pcs/pack	79"	RHSCN15	\$0.
	70 pcs/pack	79"	RHSCN70	0.
	250 pcs/pack	79"	RHSCN250	0.
cut to size to fit during installation recommended use interior of station or where aluminum vertical reveals not installed				
Panel alignment kits	panel-to-panel		RSPABPP	7.
	window-to-panel		RSPABPW	7.
	window-to-window		RSPABWW	7.
	stacking module-to-panel		R3SPABPT	7.
	stacking module-to-stacking module		R3SPABTT	7.
	window-to-stacking module		R3SPABTW	7.
Panel leveling plates	10 pcs/pack		APLP10	42.
	25 pcs/pack		APLP25	94.
Carpet grippers	10 pcs/pack		R2CG	21.

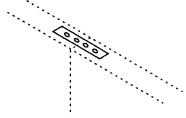

Panels

Order Code	Specification Information	Application Notes
Example: APLP10	<i>To order please specify pattern number including:</i> 1. Pack quantity required	Panel leveling plates are for installation aid only. The plate fits on top of the hookstrip connecting two panels and spans the joint between the panels. Simply drop the plate in the cavity between the two panels, tighten top wedges as you would normally during installation. The dimension and shape will force panel alignment. Remove the plate and proceed onto the next connection.
A AutoStrada		
P Panel		
L Leveling		
P Plates		
10 Pack of 10		Panel alignment kits are required for stacking modules and long panel runs. Panel alignment kits are required at the highest point of each panel and stacking module connection. They are recommended when panels are supporting overhead storage. One alignment bracket required for every two panels. Please refer to Reff planning guide, page 45 for additional information.

description	type	h	w	d	pattern no.	list
Power rail for panel with one side only base raceway (8 wire)	24" panel	2"	6"	2"	RR3-E24S	\$158.
	30" panel	2"	12"	2"	RR3-E30S	182.
	36" panel	2"	18"	2"	RR3-E36S	199.
	42" panel	2"	24"	2"	RR3-E42S	215.
	48" panel	2"	30"	2"	RR3-E48S	220.

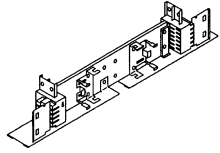

Power rail for panel with one side only base raceway (10 wire)	24" panel	2"	6"	2"	RR3-T24S	190.
	30" panel	2"	12"	2"	RR3-T30S	208.
	36" panel	2"	18"	2"	RR3-T36S	220.
	42" panel	2"	24"	2"	RR3-T42S	241.
	48" panel	2"	30"	2"	RR3-T48S	246.

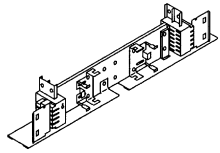

Order Code

Example: RR3-T24S
RR3 Reff panel frame raceway
T Ten wire, 3+3
24 for 24" w panel
S Single sided raceway

Specification Information

Power rails are the primary power distribution component. Each rail provides provides outlet mounting position on one side and receptacles for branching power connectors at each end.

Power rail for 24" wide panel accepts one duplex outlet or one power infeed. Power rails for 30" to 48" wide panels accept two outlets.

Application Notes

Power rails on this page are for use with panels with one side raceway only.

Power connections and duplexes as required to be specified from following pages for 8 or 10 wire as required for panels with either one sided base raceway or both sides with base raceway.

Power distribution components

2+2 Base Raceway

four circuit, eight-wire raceway for panels

power rails and connector

description	type	w	d	h	pattern no.	list price
	24" panel	6"	2"	2"	RR3-E24	\$151.
	30" panel	12"	2"	2"	RR3-E30NS	166.
	36" panel	18"	2"	2"	RR3-E36NS	182.
	42" panel	24"	2"	2"	RR3-E42NS	190.
	48" panel	30"	2"	2"	RR3-E48NS	199.
	60" panel	42"	2"	2"	RR3-E60-4	302.
	66" panel	48"	2"	2"	RR3-E66-4	318.
	72" panel	54"	2"	2"	RR3-E72-4	340.

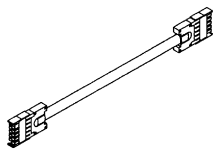
	Straight	16 1/2"	2"	2"	RR3-EPC24M	87.
		18 1/2"	2"	2"	RR3-EPCSM	87.
		20 1/4"	2"	2"	RR3-EPCM	87.

Use **RR3-EPC24M** for straight 24" to 24" wide panel.
 Use **RR3-EPCSM** for straight 24" to any other width panel and for 30" to 30" wide panels.
 Use **RR3-EPCM** for all other straight power connection configurations.

Through post	19"	2"	2"	RR3-EPCP24M	87.
	21"	2"	2"	RR3-EPCPSM	87.
	22 3/4"	2"	2"	RR3-EPCPM	87.

Use **RR3-EPCP24M** for through post 24" to 24" wide panels.
 Use **RR3-EPCPSM** for through post 24" to any other width panel and for 30" to 30" wide panels.
 Use **RR3-EPCPM** for all other through post power connection configurations.

	Circuit A	RR3-DA	42.
	Circuit B	RR3-DB	42.
	Circuit X	RR3-DX	42.
	Circuit Y	RR3-DY	42.

	Circuit X	RR3-DXO	47.
	Circuit Y	RR3-DYO	47.

Data Shield	I pair	RR3-DATSHD	29.
-------------	--------	-------------------	-----

Attaches to power rail, sits under duplex

Order Code	Specification Information	Application Notes
Example: RR3-E-24 RR3 Reff raceway E Eight wire 2+2 24 for 24" panel	Reff 2+2 Raceway is a four-circuit, eight-wire modular power distribution system for use in Reff panels. 2+2 Raceway components distribute two 20-amp convenience circuits (A and B) with neutral and ground, and two protected 20-amp circuits (X and Y) with separate neutral and ground. In Canada circuits carry 15 amp load resting. Specify the suffix "RF" after the power rail pattern number for panels manufactured before June 1996.	Power rails are the primary power distribution component of the Reff 2+2 Raceway. Each rail provides outlet mounting positions on both sides and receptacles for two branching power connectors at each end. Center supports permit lay-in cabling from either side of the raceway. Rail for 24" wide panel accepts one duplex outlet or power infeed centered on each side. Rails for 30" to 48" panels accept two outlets (or one outlet and one infeed) on each side. 60", 66" and 72"W panels accept four duplex outlets per side. Duplex outlets are preconfigured to access one of the four circuits, A, B, X, Y, and snap into any standard outlet location. Duplexes on circuits X and Y may be specified in orange to signify protected circuits for electronic equipment.

Power connectors transmit power between adjacent powered panels. Specify straight power connector for straight connections and through-post power connector when passing in a 90° or straight through a T, X or L post connection.

Power connectors are enclosed in steel flexible conduit.

*Power connectors must be specified according to the panel widths in the specified orientation.

If separation of cabling and electrical wires is required, a data shield can be attached below the power rail. Data Shields are field installed.

Power distribution components

2+2 Base Raceway

four circuit, eight-wire raceway for panels

jumpers and infeed

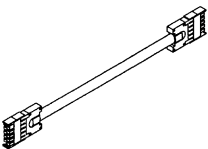
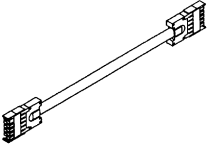
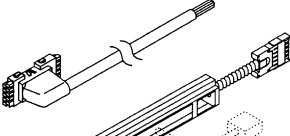
description	type	w	d	h	pattern no.	list price
	18" panel	38"	2"	2"	RR3-EJ18	\$109.
	20" panel	40"	2"	2"	RR3-EJ20	109.
	24" panel	44"	2"	2"	RR3-EJ24	118.
	30" panel	50"	2"	2"	RR3-EJ30	126.
	36" panel	56"	2"	2"	RR3-EJ36	137.
	42" panel	62"	2"	2"	RR3-EJ42	144.
	48" panel	68"	2"	2"	RR3-EJ48	151.
	54" panel run	76 1/2"	2"	2"	RR3-EJ54P	158.
	60" panel run	82 1/2"	2"	2"	RR3-EJ60P	166.
	66" panel run	88 1/2"	2"	2"	RR3-EJ66P	175.
	72" panel run	94 1/2"	2"	2"	RR3-EJ72P	182.
	78" panel run	100 1/2"	2"	2"	RR3-EJ78P	190.
	84" panel run	106 1/2"	2"	2"	RR3-EJ84P	199.
	90" panel run	112 1/2"	2"	2"	RR3-EJ90P	208.
96" panel run	118 1/2"	2"	2"	RR3-EJ96P	215.	
	18" + post	40 1/2"	2"	2"	RR3-EJ18P	109.
	20" + post	42 1/2"	2"	2"	RR3-EJ20P	109.
	24" + post	46 1/2"	2"	2"	RR3-EJ24P	118.
	30" + post	52 1/2"	2"	2"	RR3-EJ30P	126.
	36" + post	58 1/2"	2"	2"	RR3-EJ36P	137.
	42" + post	64 1/2"	2"	2"	RR3-EJ42P	144.
	48" + post	70 1/2"	2"	2"	RR3-EJ48P	151.
	Ceiling power cable infeed. Eight-wire				RR3-EPVR	302.
	Hardwire infeed (NYC) one direction				RR3-EPNY1	220.
	Hardwire infeed (NYC) two directions				RR3-EPNY2	331.
	Panel base end feed				RR3-REPI	262.
	Panel base side infeed				RR3-EPI	262.
	Surge suppressors				RR3-SP-(A,B,X,Y)	190.

Order Code	Specification Information	Application Notes
Example: RR3-EPVR		
RR3	Reff raceway	
E	Eight wire 2+2	
P	power infeed	
VR	for vertical raceway	

Reff 2+2 Raceway is a four-circuit, eight-wire modular power distribution system for use in Reff panels. 2+2 Raceway components distribute two 20-amp convenience circuits (A and B) with neutral and ground, and two 20-amp circuits (X and Y) with separate neutral and ground.

For use in Canada, all circuits are CGA rated 15 amp capacity.

Note:
For NYC hardwire infeeds specify bracket height: 4", 5", or 6"H.

Beltway panels can use jumpers at the panel base in a straight run or around a corner.

Jumpers pass power through the raceway of panels that do not require power access to the next available power rail. Jumpers only connect to power rails. Jumpers 18" to 48" are available standard or extended. Extended jumpers should be specified when passing through a panel and a post. Jumpers 54" to 96" wide can be used with or without a post application. Extended jumpers and jumpers 54" to 96" wide can only pass through panels and one post.

Power infeeds connect building power supply to a cluster of interconnected power rails. Panel base infeed snaps into any outlet position in rail, and includes 6 foot liquid-tight conduit and pigtail for connection to floor or wall electrical box. Ceiling infeeds include up to 13' pigtail for connection

into panel base through power pole adjacent to panel with power rail. Power pole and post must be ordered separately.

Hardwire infeed, used in all New York City installations, includes junction box that mounts within non-powered panel base (any width 30" or greater). Electrical contractor supplies watertight conduit from building power supply to panel and trims power connectors to length. **RR3-EPNY2** includes two power connectors to power panels on both sides of infeed panel; **RR3-EPNY1** includes only one power connector.

Cable sizes are nominal. Use the "type" column to specify the required cable for your panel.

Power distribution components

3+3 Base Raceway

six circuit, ten-wire raceway for panels

power rails and connectors

description	type	w	d	h	pattern no.	list price
	24" panel	6"	2"	2"	RR3-T24	\$175.
	30" panel	12"	2"	2"	RR3-T30NS	190.
	36" panel	18"	2"	2"	RR3-T36NS	208.
	42" panel	24"	2"	2"	RR3-T42NS	220.
	48" panel	30"	2"	2"	RR3-T48NS	229.
	60" panel	42"	2"	2"	RR3-T60-4	358.
	66" panel	48"	2"	2"	RR3-T66-4	372.
	72" panel	54"	2"	2"	RR3-T72-4	398.

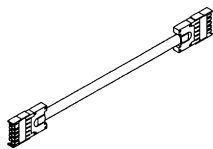
	Straight	16 1/2"	2"	2"	RR3-TPC24	109.
		18 1/2"	2"	2"	RR3-TPCS	109.
		20 1/4"	2"	2"	RR3-TPCM	109.

Use **RR3-TPC24** for through post 24" to 24" wide panels.
 Use **RR3-TPCS** for through post 24" to any other width panel and for 30" to 30" wide panels.
 Use **RR3-TPC** for all other through post power connection configurations.

Through post	19"	2"	2"	RR3-TPCP24	109.
	21"	2"	2"	RR3-TPCPS	109.
	22 3/4"	2"	2"	RR3-TPCPM	109.

Use **RR3-TPCP24** for through post 24" to 24" wide panels.
 Use **RR3-TPCPS** for through post 24" to any other width panel and for 30" to 30" wide panels.
 Use **RR3-TPCP** for all other through post power connection configurations.

	Circuit A	RR3-DA	42.
	Circuit B	RR3-DB	42.
	Circuit C	RR3-DC	42.
	Circuit X	RR3-DX	42.
	Circuit Y	RR3-DY	42.
	Circuit Z	RR3-DZ	42.

	Circuit X	RR3-DXO	47.
	Circuit Y	RR3-DYO	47.
	Circuit Z	RR3-DZO	47.

Data Shield	1 pair	RR3-DATSHD	29.
-------------	--------	-------------------	-----

Order Code	Specification Information	Application Notes
Example: RR3-T-24 RR3 Reff raceway T Ten wire 3+3 24 for 24" panel	Reff 3+3 Raceway is a six-circuit, ten-wire modular power distribution system for use in Reff panels. 3+3 Raceway components distribute three 20-amp convenience circuits (A,B and C) with neutral and ground, and three 20-amp circuits (X, Y and Z) with separate neutral and ground. A, B, X, Y outlets are identical to eight wire, 2+2 components. Duplex outlet circuits are designated by white letters on black background. In Canada, circuits carry a 15 amp load rating. <i>Note:</i> Specify the suffix "RF" after the power rail pattern number for panels manufactured before June 1996.	Power rails are the primary power distribution component of the Reff 3+3 Raceway. Each rail provides outlet mounting positions on both sides and receptacles for branching power connectors at each end. Center supports permit lay-in cabling from either side of the raceway. Rail for 24"W panel accepts one duplex outlet or power infeed one either side. Rails for 30" to 48" panels accept two outlets each side, 60", 66" and 72" rails accept four duplex outlets per side. *Power connectors must be specified according to the panel widths in the specified orientation.

Power connectors transmit power between adjacent powered panels. Specify straight power connector for straight connections and through-post power connector when passing in a 90° or straight through a T or X or L post connection.

 Duplex outlets are preconfigured to access one of the four circuits, A, B, X, Y, and snap into any standard outlet location. Duplexes on circuits X and Y may be specified in orange to signify protected circuits for electronic equipment; all duplexes are black.

 If separation of cabling and electrical wires is required, a data shield can be attached below the power rail. Data Shields are field installed.

Panels

Power distribution components

3+3 Base Raceway

six circuit, ten-wire raceway for panels

jumpers and infeed

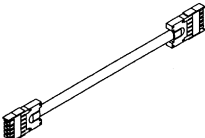
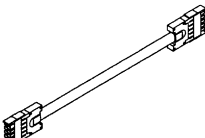
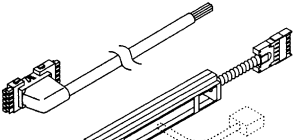
description	type	w	d	h	pattern no.	list price
	18" panel	38"	2"	2"	RR3-TJ18	\$126.
	20" panel	40"	2"	2"	RR3-TJ20	126.
	24" panel	44"	2"	2"	RR3-TJ24	137.
	30" panel	50"	2"	2"	RR3-TJ30	144.
	36" panel	56"	2"	2"	RR3-TJ36	151.
	42" panel	62"	2"	2"	RR3-TJ42	166.
	48" panel	68"	2"	2"	RR3-TJ48	182.
	54" panel run	76 1/2"	2"	2"	RR3-TJ54P	190.
	60" panel	82 1/2"	2"	2"	RR3-TJ60P	199.
	66" panel run	86 1/2"	2"	2"	RR3-TJ66P	208.
	72" panel run	94 1/2"	2"	2"	RR3-TJ72P	215.
	78" panel run	100 1/2"	2"	2"	RR3-TJ78P	220.
	84" panel run	106 1/2"	2"	2"	RR3-TJ84P	241.
90" panel run	112 1/2"	2"	2"	RR3-TJ90P	246.	
96" panel run	118 1/2"	2"	2"	RR3-TJ96P	253.	
	18" + post	40 1/2"	2"	2"	RR3-TJ18P	126.
	20" + post	46 1/2"	2"	2"	RR3-TJ20P	126.
	24" + post	46 1/2"	2"	2"	RR3-TJ24P	137.
	30" + post	52 1/2"	2"	2"	RR3-TJ30P	144.
	36" + post	58 1/2"	2"	2"	RR3-TJ36P	151.
	42" + post	64 1/2"	2"	2"	RR3-TJ42P	166.
	48" + post	70 1/2"	2"	2"	RR3-TJ48P	182.
	Ceiling power cable infeed. Ten-wire				RR3-TPVR	365.
	Hardwire infeed (NYC) one direction **				RR3-TPNY1	253.
	Hardwire infeed (NYC) two directions **				RR3-TPNY2	365.
	Panel base end feed				RR3-RTPI	302.
	Panel base side infeed				RR3-TPI	302.
	Surge suppressors *				RR3-SP-(A, B, C, X, Y, Z)	190.

* Select which circuit needs protecting and order the specified surge processor.

** For RR3-TPNY1 and RR3-TPNY2 specify base height of panel for NYC.

Order Code	Specification Information	Application Notes
Example: RR3-TPVR RR3 Reff raceway T Ten wire 3+3 P power infeed VR for vertical raceway	<p>Reff 3+3 Raceway is a six-circuit, ten-wire modular power distribution system for use in Reff panels. 3+3 Raceway components distribute three 20-amp convenience circuits (A, B and C) with neutral and ground, and three 20-amp circuits (X, Y and Z) with separate neutral and ground.</p> <p>In Canada, circuits carry a 15 amp load rating.</p> <p>Power infeeds connect building power supply to a cluster of interconnected power rails. Panel base infeed snaps into any outlet position in rail, and includes 6 foot liquid-tight conduit and pigtail for connection to floor or wall electrical box. Ceiling infeeds include up to 13' pigtail for connection into panel base through standard power pole. Power pole and post must be ordered separately.</p>	<p>Jumpers pass power through the raceway of panels that do not require power access to the next available power rail. Jumpers only connect to power rails. Jumpers 18" to 48" are available standard or extended. Extended jumpers should be specified when passing through a panel and a post. Jumpers 54" to 96" wide can be used with or without a post application. Extended jumpers and jumpers 54" to 96" wide can only pass through panels and one post.</p> <p>Cable sizes are nominal. Use the "type" column to specify the required cable for your panel.</p> <p>Beltway panels can use jumpers at the panel base in a straight run or around a corner.</p>

Power distribution components

Hardwire box

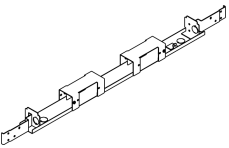
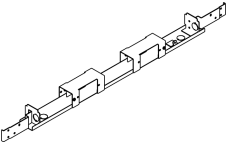
description	type	pattern no.	list
Chicago Hardwire Box 1 Sided 	24" panel	RR3CHI241	\$235.
	30" panel	RR3CHI301	274.
	36" panel	RR3CHI361	295.
	42" panel	RR3CHI421	298.
	48" panel	RR3CHI481	319.
Chicago Hardwire Box 2 Sided 	24" panel	RR3CHI242	244.
	30" panel	RR3CHI302	292.
	36" panel	RR3CHI362	300.
	42" panel	RR3CHI422	304.
	48" panel	RR3CHI482	339.

Order Code

Example: RR3CHI241	
RR3	Reff/AutoStrada raceway G3
CHI	Chicago Hardwire Box
24	For 24" wide panel
1	One sided raceway

Specification Information

Hardwire box is dedicated for panels with raceway either one or two sided, be sure to match to panel specification.

Application Notes

Certified electrician to install.
Reff Hardwire Box
Installation instruction sheet available on Knoll Exchange. Part number 6TR45715.

AutoStrada Ported Panel Components

port, vertical duplex and panel jumpers

AutoStrada

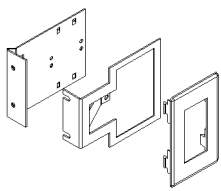
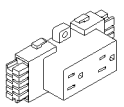
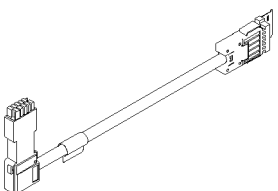
description	type	pattern no.	list price
Port 	Floating data port	RR3FDP	\$59.
	Vertical Power Port Bracket Kit (includes bracket, cover plate & installation instructions)	RR3VPBK	93.
Vertical Duplex 	Vertical Duplex A (8/10 wire applications)	RR3VDA	31.
	Vertical Duplex B (8/10 wire applications)	RR3VDB	31.
	Vertical Duplex C (10 wire applications)	RR3VDC	31.
	Vertical Duplex X (8/10 wire applications)	RR3VDX	31.
	Vertical Duplex X Iso (8/10 wire applications)	RR3VDXO	31.
	Vertical Duplex Y (8/10 wire applications)	RR3VDY	31.
	Vertical Duplex Y Iso (8/10 wire applications)	RR3VDYO	31.
	Vertical Duplex Z (10 wire applications)	RR3VDZ	31.
	Vertical Duplex Z Iso (10 wire applications)	RR3VDZO	31.
Same Panel Jumper, 8w 	30" same Panel Jumper 50" 8w	RR3EBVC50	158.
	30" same Panel Jumper 64" 8w	RR3EBVC64	172.
	30" same Panel Jumper 78" 8w	RR3EBVC78	187.
	36" + same Panel Jumper 62" 8w	RR3EBVC62	171.
	36" + same Panel Jumper 76" 8w	RR3EBVC76	186.
	36" + same Panel Jumper 90" 8w	RR3EBVC90	203.
Same Panel Jumper, 10w	30" same Panel Jumper 50" 10w	RR3TBVC50	181.
	30" same Panel Jumper 64" 10w	RR3TBVC64	199.
	30" same Panel Jumper 78" 10w	RR3TBVC78	217.
	36" + same Panel Jumper 62" 10w	RR3TBVC62	194.
	36" + same Panel Jumper 76" 10w	RR3TBVC76	213.
	36" + same Panel Jumper 90" 10w	RR3TBVC90	229.

Order Code	Specification Information	Application Note
Example: RR3FDP <hr/> RR3 Reff <hr/> F Floating <hr/> DP Data Port <hr/>	For data and communications specify product listed on page 0.	30" same panel jumper only used if there is a harness in base of 30" panel . Length of panel jumper required driven by intended location of port. 50" will support port location in extreme top corner of 49"h 64" will support port location in extreme top corner of 64"h 78" will support port location in extreme top corner of 79"h 36"+ same panel jumper only used if there is a harness in the base of 36", 42" or 48" panels. Length of panel jumper required driven by intended location of port. 62" will support port location in extreme top corner of 49"h 76" will support port location in extreme top corner of 64"h 90" will support port location in extreme top corner of 79"h
		If harness is in base of 24" panel you can not jump vertically, must remove harness. A harness for Reff 30" wide panel with raceway on one side will only accept one same panel jumper. A duplex will not fit with the same panel jumper installed in the harness. Internal panel jumper to be used within a panel, between two ports approximate span 48". Both duplex units must be the same circuit for this application. Adjacent Panel Jumpers: 82" is max for 49" high panel 96" is max if panel is 64" high 110" is max if panel is 79" high All covers plates and snap in modules are black.

AutoStrada Ported Panel Components

port, vertical duplex and panel jumpers

AutoStrada

description	type	pattern no.	list price
Adjacent Panel Jumper, 10w	Adjacent Panel Jumper 110" 10w	RR3TVJ110	\$249.
	Adjacent Panel Jumper 82" 10w	RR3TVJ82	214.
	Adjacent Panel Jumper 96" 10w	RR3TVJ96	232.

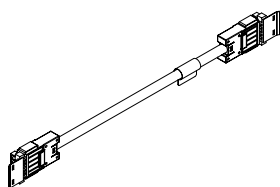

Adjacent Panel Jumper, 8w	Adjacent Panel Jumper 110" 8w	RR3EVJ110	218.
	Adjacent Panel Jumper 82" 8w	RR3EVJ82	190.
	Adjacent Panel Jumper 96" 8w	RR3EVJ96	207.

Internal Panel Jumper	Internal Panel Jumper 10 w	RR3TVJ	159.
	Internal Panel Jumper 8 w	RR3EVJ	148.

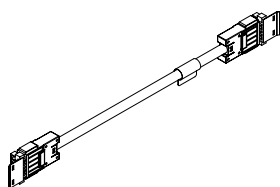

Panels

Order Code

Example: **RR3FDP**
RR3 Reff
F Floating
DP Data Port

Specification Information

For data and communications specify product listed on page 0.

30" same panel jumper only used if there is a harness in base of 30" panel . Length of panel jumper required driven by intended location of port.
 50" will support port location in extreme top corner of 49"h
 64" will support port location in extreme top corner of 64"h
 78" will support port location in extreme top corner of 79"h

36"+ same panel jumper only used if there is a harness in the base of 36", 42" or 48" panels. Length of panel jumper required driven by intended location of port.
 62" will support port location in extreme top corner of 49"h
 76" will support port location in extreme top corner of 64"h
 90" will support port location in extreme top corner of 79"h

If harness is in base of 24" panel you can not jump vertically, must remove harness.

A harness for Reff 30" wide panel with raceway on one side will only accept one same panel jumper. A duplex will not fit with the same panel jumper installed in the harness.

Internal panel jumper to be used within a panel, between two ports approximate span 48". Both duplex units must be the same circuit for this application.

Adjacent Panel Jumpers:
 82" is max for 49" high panel
 96" is max if panel is 64" high
 110" is max if panel is 79" high

All covers plates and snap in modules are black.

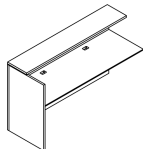
description	type	h*	w*	d	pattern no.	L	M/V1 or V1	M/V2 or V2	M/V3 or V3
 <p>left hand shown, worksurface height fixed 27" h to underside</p>	left hand	42"	42"	26 1/2"	AMB42L424 () () () () () ()	\$1,540.	\$1,939.	\$2,229.	\$2,897.
		42"	48"	26 1/2"	AMB42L484 () () () () () ()	1,602.	2,017.	2,319.	3,015.
		42"	54"	26 1/2"	AMB42L544 () () () () () ()	1,665.	2,097.	2,412.	3,132.
		42"	60"	26 1/2"	AMB42L604 () () () () () ()	1,728.	2,175.	2,502.	3,252.
		42"	66"	26 1/2"	AMB42L664 () () () () () ()	1,792.	2,255.	2,594.	3,372.
		42"	72"	26 1/2"	AMB42L724 () () () () () ()	1,855.	2,333.	2,683.	3,487.
		42"	78"	26 1/2"	AMB42L784 () () () () () ()	1,917.	2,414.	2,774.	3,606.
		42"	84"	26 1/2"	AMB42L844 () () () () () ()	1,979.	2,491.	2,866.	3,725.
		42"	90"	26 1/2"	AMB42L904 () () () () () ()	2,044.	2,569.	2,957.	3,844.
		42"	96"	26 1/2"	AMB42L964 () () () () () ()	2,104.	2,650.	3,048.	3,964.
	right hand	42"	42"	26 1/2"	AMB42R424 () () () () () ()	1,540.	1,939.	2,229.	2,897.
		42"	48"	26 1/2"	AMB42R484 () () () () () ()	1,602.	2,017.	2,319.	3,015.
		42"	54"	26 1/2"	AMB42R544 () () () () () ()	1,665.	2,097.	2,412.	3,132.
		42"	60"	26 1/2"	AMB42R604 () () () () () ()	1,728.	2,175.	2,502.	3,252.
		42"	66"	26 1/2"	AMB42R664 () () () () () ()	1,792.	2,255.	2,594.	3,372.
		42"	72"	26 1/2"	AMB42R724 () () () () () ()	1,855.	2,333.	2,683.	3,487.
		42"	78"	26 1/2"	AMB42R784 () () () () () ()	1,917.	2,414.	2,774.	3,606.
		42"	84"	26 1/2"	AMB42R844 () () () () () ()	1,979.	2,491.	2,866.	3,725.
		42"	90"	26 1/2"	AMB42R904 () () () () () ()	2,044.	2,569.	2,957.	3,844.
		42"	96"	26 1/2"	AMB42R964 () () () () () ()	2,104.	2,650.	3,048.	3,964.

Order Code	Specification Information	Application Notes
Example: AMB42L424GFEV316 V316613AA	To order please specify pattern number including:	Median end without gable to be attached to a storage anchored cabinet. Optional face drill option is to drill outside face of gable to attach to next median in line, if last unit in run specify no drill. Optional end drill gable option is for attachment to bridge units on page 155, specify no drill if configuration does not include bridge unit.
A AutoStrada	1. Hand <i>L = Left hand</i> <i>R = Right hand</i>	Mixed finish options applicable with V1, V2 or V3 finish surround, top shelf and worksurface front edge with laminate finish worksurface.
M Median	2. Width	Products on this page shipped knocked-down.
B Binder depth top shelf	3. Depth <i>4 = 26.5" d nominal</i> <i>5 = 32.5" d nominal</i>	
42 42" high	4. Grommet option <i>G = Grommet(s)</i> <i>N = No grommet(s)</i>	
L Left hand	5. Face drill option <i>F = face drill for attachment to next unit</i> <i>N = no drill, last unit in run</i>	
42 42" wide	6. End drill option <i>E = end drill gable to attach to bridge</i> <i>N = no drill</i>	
4 26.5" d	7. Finish, surround, top shelf and worksurface front edge <i>Laminate, V1, V2 or V3 finish</i>	
G Grommet	8. Finish, worksurface <i>Laminate, V1, V2 or V3 finish</i>	
F Face drill gable	9. Finish, Grommet(s) <i>specify painted or plated finish</i>	
E End drill gable	10. Finish, Aluminum trim <i>AA - Anodized aluminum or painted finish option from page 8 excluding silver</i>	
V316 Finish, surround, top shelf & worksurface edge	Order worksurface stiffener for unsupported spans exceeding 48".	
V316 Finish, worksurface	*42" h to top of gable; with aluminum trim and top shelf 43.2" h.	
613 Finish, grommet	*Width noted is interior nominal dimension, overall footprint additional 1" nominal.	
AA Trim, anodized aluminum	See page 8 for finish options applicable.	

Product on this page will accept wood grain laminate where laminate is currently an option.

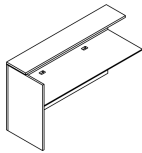
description	type	h*	w*	d	pattern no.	L	M/V1 or V1	M/V2 or V2	M/V3 or V3
 <p>left hand shown, worksurface height fixed 27" h to underside</p>	left hand	42"	42"	32 1/2"	AMB42L425 () () () () ()	\$1,630.	\$2,030.	\$2,336.	\$3,035.
		42"	48"	32 1/2"	AMB42L485 () () () () ()	1,691.	2,109.	2,426.	3,151.
		42"	54"	32 1/2"	AMB42L545 () () () () ()	1,754.	2,187.	2,514.	3,271.
		42"	60"	32 1/2"	AMB42L605 () () () () ()	1,815.	2,263.	2,605.	3,385.
		42"	66"	32 1/2"	AMB42L665 () () () () ()	1,877.	2,341.	2,694.	3,502.
		42"	72"	32 1/2"	AMB42L725 () () () () ()	1,942.	2,419.	2,785.	3,617.
		42"	78"	32 1/2"	AMB42L785 () () () () ()	2,004.	2,497.	2,876.	3,736.
		42"	84"	32 1/2"	AMB42L845 () () () () ()	2,065.	2,576.	2,962.	3,852.
		42"	90"	32 1/2"	AMB42L905 () () () () ()	2,128.	2,653.	3,053.	3,969.
		42"	96"	32 1/2"	AMB42L965 () () () () ()	2,190.	2,730.	3,143.	4,085.
	right hand	42"	42"	32 1/2"	AMB42R425 () () () () ()	1,630.	2,030.	2,336.	3,035.
		42"	48"	32 1/2"	AMB42R485 () () () () ()	1,691.	2,109.	2,426.	3,151.
		42"	54"	32 1/2"	AMB42R545 () () () () ()	1,754.	2,187.	2,514.	3,271.
		42"	60"	32 1/2"	AMB42R605 () () () () ()	1,815.	2,263.	2,605.	3,385.
		42"	66"	32 1/2"	AMB42R665 () () () () ()	1,877.	2,341.	2,694.	3,502.
		42"	72"	32 1/2"	AMB42R725 () () () () ()	1,942.	2,419.	2,785.	3,617.
		42"	78"	32 1/2"	AMB42R785 () () () () ()	2,004.	2,497.	2,876.	3,736.
		42"	84"	32 1/2"	AMB42R845 () () () () ()	2,065.	2,576.	2,962.	3,852.
		42"	90"	32 1/2"	AMB42R905 () () () () ()	2,128.	2,653.	3,053.	3,969.
		42"	96"	32 1/2"	AMB42R965 () () () () ()	2,190.	2,730.	3,143.	4,085.

Order Code	Specification Information	Application Notes
Example: AMB42L425GFEV316 V316613AA	To order please specify pattern number including:	Median end without gable to be attached to a storage anchored cabinet. Optional face drill option is to drill outside face of gable to attach to next median in line, if last unit in run specify no drill. Optional end drill gable option is for attachment to bridge units on page 155, specify no drill if configuration does not include bridge unit.
A AutoStrada	1. Hand <i>L = Left hand R = Right hand</i>	Mixed finish options applicable with V1, V2 or V3 finish surround, top shelf and worksurface front edge with laminate finish worksurface.
M Median	2. Width	Products on this page shipped knocked-down.
B Binder depth top shelf	3. Depth <i>4 = 26.5" d nominal 5 = 32.5" d nominal</i>	
42 42" high	4. Grommet option <i>G = Grommet(s) N = No grommet(s)</i>	
L Left hand	5. Face drill option <i>F = face drill for attachment to next unit N = no drill, last unit in run</i>	
42 42" wide	6. End drill option <i>E = end drill gable to attach to bridge N = no drill</i>	
5 32.5" d	7. Finish, surround, top shelf and worksurface front edge <i>Laminate, V1, V2 or V3 finish</i>	
G Grommet	8. Finish, worksurface <i>Laminate, V1, V2 or V3 finish</i>	
F Face drill gable	9. Finish, Grommet(s) <i>specify painted or plated finish</i>	
E End drill gable	10. Finish, Aluminum trim <i>AA - Anodized aluminum or painted finish option from page 8 excluding silver</i>	
V316 Finish, surround, top shelf & worksurface edge	Order worksurface stiffener for unsupported spans exceeding 48".	
V316 Finish, worksurface	*42" h to top of gable; with aluminum trim and top shelf 43.2" h.	
613 Finish, grommet	*Width noted is interior nominal dimension, overall footprint additional 1" nominal.	
AA Trim, anodized aluminum	See page 8 for finish options applicable.	

Product on this page will accept wood grain laminate where laminate is currently an option.

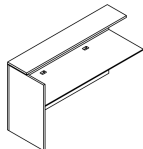
description	type	h*	w*	d	pattern no.	L	M/V1 or V1	M/V2 or V2	M/V3 or V3
 <p>left hand shown, worksurface height fixed 27" h to underside</p>	left hand	42"	42"	26 1/2"	AMG42L424 () () () () ()	\$1,572.	\$1,977.	\$2,273.	\$2,955.
		42"	48"	26 1/2"	AMG42L484 () () () () ()	1,636.	2,057.	2,367.	3,074.
		42"	54"	26 1/2"	AMG42L544 () () () () ()	1,700.	2,139.	2,459.	3,197.
		42"	60"	26 1/2"	AMG42L604 () () () () ()	1,764.	2,217.	2,552.	3,319.
		42"	66"	26 1/2"	AMG42L664 () () () () ()	1,827.	2,298.	2,646.	3,437.
		42"	72"	26 1/2"	AMG42L724 () () () () ()	1,891.	2,381.	2,738.	3,559.
		42"	78"	26 1/2"	AMG42L784 () () () () ()	1,956.	2,460.	2,831.	3,680.
		42"	84"	26 1/2"	AMG42L844 () () () () ()	2,020.	2,540.	2,922.	3,799.
		42"	90"	26 1/2"	AMG42L904 () () () () ()	2,084.	2,620.	3,016.	3,919.
		42"	96"	26 1/2"	AMG42L964 () () () () ()	2,148.	2,701.	3,109.	4,042.
	right hand	42"	42"	26 1/2"	AMG42R424 () () () () ()	1,572.	1,977.	2,273.	2,955.
		42"	48"	26 1/2"	AMG42R484 () () () () ()	1,636.	2,057.	2,367.	3,074.
		42"	54"	26 1/2"	AMG42R544 () () () () ()	1,700.	2,139.	2,459.	3,197.
		42"	60"	26 1/2"	AMG42R604 () () () () ()	1,764.	2,217.	2,552.	3,319.
		42"	66"	26 1/2"	AMG42R664 () () () () ()	1,827.	2,298.	2,646.	3,437.
		42"	72"	26 1/2"	AMG42R724 () () () () ()	1,891.	2,381.	2,738.	3,559.
		42"	78"	26 1/2"	AMG42R784 () () () () ()	1,956.	2,460.	2,831.	3,680.
		42"	84"	26 1/2"	AMG42R844 () () () () ()	2,020.	2,540.	2,922.	3,799.
		42"	90"	26 1/2"	AMG42R904 () () () () ()	2,084.	2,620.	3,016.	3,919.
		42"	96"	26 1/2"	AMG42R964 () () () () ()	2,148.	2,701.	3,109.	4,042.

Order Code	Specification Information	Application Notes
Example: AMG42L424GFEV316 V316613AA	To order please specify pattern number including:	Median end without gable to be attached to a storage anchored cabinet. Optional face drill option is to drill outside face of gable to attach to next median in line, if last unit in run specify no drill. Optional end drill gable option is for attachment to bridge units on page 155, specify no drill if configuration does not include bridge unit.
A AutoStrada	1. Left or Right hand <i>L = Left hand</i> <i>R = Right hand</i>	Mixed finish options applicable with V1, V2 or V3 finish surround, top shelf and worksurface front edge with laminate finish worksurface.
M Median	2. Width	Product on this page shipped knocked-down.
G Legal depth top shelf	3. Depth <i>4 = 26.5" d nominal</i> <i>5 = 32.5" d nominal</i>	
42 42" high	4. Grommet option <i>G = Grommet(s)</i> <i>N = No grommet(s)</i>	
L Left hand	5. Face drill option <i>F = face drill for attachment to next unit</i> <i>N = no drill, last unit in run</i>	
42 42" wide	6. End drill option <i>E = end drill gable to attach to bridge</i> <i>N = no drill</i>	
4 26.5" d	7. Finish, surround, top shelf & worksurface edge <i>Laminate, V1, V2 or V3 finish</i>	
G Grommet	8. Finish, worksurface <i>Laminate, V1, V2 or V3</i>	
F Face drill gable	9. Finish, Grommet(s) <i>specify painted or plated finish</i>	
E End drill gable	10. Finish, Aluminum trim <i>AA - Anodized aluminum or painted finish option from page 8 excluding silver</i>	
V316 Finish, surround, top shelf & worksurface edge	Order worksurface stiffener for unsupported spans exceeding 48".	
V316 Finish, worksurface	*42" h to top of gable; with aluminum trim and top shelf 43.2" h.	
613 Finish, grommet	*Width noted is interior nominal dimension, overall footprint additional 1" nominal.	
AA Trim, anodized aluminum	See page 8 for finish options applicable.	

Product on this page will accept wood grain laminate where laminate is currently an option.

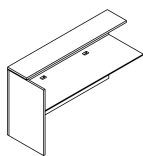
description	type	h*	w*	d	pattern no	L	M/V1 or V1	M/V2 or V2	M/V3 or V3
 <p>left hand shown, worksurface height fixed 27" h to underside</p>	left hand	42"	42"	32 1/2"	AMG42L425 () () () () () ()	\$1,662.	\$2,072.	\$2,382.	\$3,096.
		42"	48"	32 1/2"	AMG42L485 () () () () () ()	1,725.	2,151.	2,473.	3,214.
		42"	54"	32 1/2"	AMG42L545 () () () () () ()	1,790.	2,231.	2,564.	3,334.
		42"	60"	32 1/2"	AMG42L605 () () () () () ()	1,853.	2,308.	2,655.	3,455.
		42"	66"	32 1/2"	AMG42L665 () () () () () ()	1,916.	2,390.	2,747.	3,571.
		42"	72"	32 1/2"	AMG42L725 () () () () () ()	1,979.	2,467.	2,839.	3,689.
		42"	78"	32 1/2"	AMG42L785 () () () () () ()	2,044.	2,547.	2,930.	3,811.
		42"	84"	32 1/2"	AMG42L845 () () () () () ()	2,105.	2,624.	3,021.	3,929.
		42"	90"	32 1/2"	AMG42L905 () () () () () ()	2,172.	2,704.	3,115.	4,047.
		42"	96"	32 1/2"	AMG42L965 () () () () () ()	2,233.	2,787.	3,204.	4,169.
	right hand	42"	42"	32 1/2"	AMG42R425 () () () () () ()	1,662.	2,072.	2,382.	3,096.
		42"	48"	32 1/2"	AMG42R485 () () () () () ()	1,725.	2,151.	2,473.	3,214.
		42"	54"	32 1/2"	AMG42R545 () () () () () ()	1,790.	2,231.	2,564.	3,334.
		42"	60"	32 1/2"	AMG42R605 () () () () () ()	1,853.	2,308.	2,655.	3,455.
		42"	66"	32 1/2"	AMG42R665 () () () () () ()	1,916.	2,390.	2,747.	3,571.
		42"	72"	32 1/2"	AMG42R725 () () () () () ()	1,979.	2,467.	2,839.	3,689.
		42"	78"	32 1/2"	AMG42R785 () () () () () ()	2,044.	2,547.	2,930.	3,811.
		42"	84"	32 1/2"	AMG42R845 () () () () () ()	2,105.	2,624.	3,021.	3,929.
		42"	90"	32 1/2"	AMG42R905 () () () () () ()	2,172.	2,704.	3,115.	4,047.
		42"	96"	32 1/2"	AMG42R965 () () () () () ()	2,233.	2,787.	3,204.	4,169.

Order Code	Specification Information	Application Notes
Example: AMG42L425GFEV316 V316613AA	To order please specify pattern number including:	Median end without gable to be attached to a storage anchored cabinet. Optional face drill option is to drill outside face of gable to attach to next median in line, if last unit in run specify no drill. Optional end drill gable option is for attachment to bridge units on page 155, specify no drill if configuration does not include bridge unit.
A AutoStrada	1. Left or Right hand <i>L = Left hand</i> <i>R = Right hand</i>	Mixed finish options applicable with V1, V2 or V3 finish surround, top shelf and worksurface front edge with laminate finish worksurface.
M Median	2. Width	Product on this page shipped knocked-down.
G Legal depth top shelf	3. Depth <i>4 = 26.5" d nominal</i> <i>5 = 32.5" d nominal</i>	
42 42" high	4. Grommet option <i>G = Grommet(s)</i> <i>N = No grommet(s)</i>	
L Left hand	5. Face drill option <i>F = face drill for attachment to next unit</i> <i>N = no drill, last unit in run</i>	
42 42" wide	6. End drill option <i>E = end drill gable to attach to bridge</i> <i>N = no drill</i>	
5 32.5" d	7. Finish, surround, top shelf & worksurface edge <i>Laminate, V1, V2 or V3 finish</i>	
G Grommet	8. Finish, worksurface <i>Laminate, V1, V2 or V3</i>	
F Face drill gable	9. Finish, Grommet(s) <i>specify painted or plated finish</i>	
E End drill gable	10. Finish, Aluminum trim <i>AA - Anodized aluminum or painted finish option from page 8 excluding silver</i>	
V316 Finish, surround, top shelf & worksurface edge	Order worksurface stiffener for unsupported spans exceeding 48".	
V316 Finish, worksurface	*42" h to top of gable; with aluminum trim and top shelf 43.2" h.	
613 Finish, grommet	*Width noted is interior nominal dimension, overall footprint additional 1" nominal.	
AA Trim, anodized aluminum	See page 8 for finish options applicable.	

Product on this page will accept wood grain laminate where laminate is currently an option.

description	h*	w*	d	pattern no.	L	M/V1 or V1	M/V2 or V2	M/V3 or V3
Medians with double end gable 42"h x 26.5"d with binder depth top shelf	42"	60"	26.5"	AMB42E604 () () () () ()	\$2,126.	\$2,712.	\$3,132.	\$4,076.
	42"	66"	26.5"	AMB42E664 () () () () ()	2,188.	2,792.	3,225.	4,193.
	42"	72"	26.5"	AMB42E724 () () () () ()	2,248.	2,875.	3,317.	4,310.
	42"	78"	26.5"	AMB42E784 () () () () ()	2,313.	2,952.	3,408.	4,427.
	42"	84"	26.5"	AMB42E844 () () () () ()	2,377.	3,030.	3,499.	4,548.
	42"	90"	26.5"	AMB42E904 () () () () ()	2,439.	3,109.	3,591.	4,666.
	42"	96"	26.5"	AMB42E964 () () () () ()	2,502.	3,188.	3,681.	4,784.

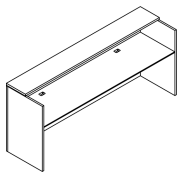

Medians with double end gable 42"h x 32.5"d with binder depth top shelf	42"	60"	32.5"	AMB42E605 () () () () ()	2,237.	2,834.	3,285.	4,268.
	42"	66"	32.5"	AMB42E665 () () () () ()	2,298.	2,910.	3,375.	4,385.
	42"	72"	32.5"	AMB42E725 () () () () ()	2,361.	2,988.	3,463.	4,504.
	42"	78"	32.5"	AMB42E785 () () () () ()	2,421.	3,066.	3,555.	4,621.
	42"	84"	32.5"	AMB42E845 () () () () ()	2,487.	3,145.	3,643.	4,735.
	42"	90"	32.5"	AMB42E905 () () () () ()	2,547.	3,224.	3,734.	4,854.
	42"	96"	32.5"	AMB42E965 () () () () ()	2,611.	3,299.	3,823.	4,972.

Order Code	Specification Information	Application Notes
Example: AMB42E604GFNEBV316V316613AA A AutoStrada M Median B Binder depth top shelf 42 42" high E End gables, both sides 60 60" wide 4 26.5" d G Grommet FN Face drill gable, none EB End drill gable, both V316 Finish, surround, top shelf & worksurface edge V316 Finish, worksurface 613 Finish, grommet AA Trim, anodized aluminum	To order please specify pattern number including: 1. Width 2. Depth 4 = 26.5" d nominal 5 = 32.5" d nominal 3. Grommet option G = Grommet(s) N = No grommet(s) 4. Face drill option FL = face drill left gable for ganging FR = face drill right gable for ganging FN = face drill none 5. End drill option EL = end drill left gable to attach to bridge ER = end drill right gable to attach to bridge EB = end drill both gables to attach to bridges (applicable 84"w, 90"w and 96"w only) EN = no drill (for freestanding applications)	6. Finish, surround, top shelf and worksurface front edge Laminate, V1, V2 or V3 finish 7. Finish, worksurface Laminate, V1, V2 or V3 finish 8. Finish, Grommet(s) specify painted or plated finish 9. Finish, Aluminum trim AA - Anodized aluminum or painted finish option from page 8 excluding silver Order worksurface stiffener for unsupported spans exceeding 48". *42"h to top of gable; with aluminum trim and top shelf 43.2"h. *Width noted is interior nominal dimension, overall footprint additional 2" nominal. See page 8 for finish options applicable. Product on this page will accept wood grain laminate where laminate is currently an option.

Application Notes

Median with double end gables to be specified for single work station or end of run unit without storage anchored cabinet terminating work space. Optional end drill gable option is for attachment to bridge units on page 155, specify no drill if configuration does not include bridge unit.

Mixed finish options applicable with V1, V2 or V3 finish surround, top shelf and worksurface front edge with laminate finish worksurface.

Product on this page shipped knocked-down.

description	h*	w*	d	pattern no.	L	M/V1 or V1	M/V2 or V2	M/V3 or V3
Medians with double end gable 42"h x 26.5"d with legal depth top shelf	42"	60"	26.5"	AMG42E604 () () () () ()	\$2,161.	\$2,756.	\$3,183.	\$4,138.
	42"	66"	26.5"	AMG42E664 () () () () ()	2,224.	2,838.	3,277.	4,261.
	42"	72"	26.5"	AMG42E724 () () () () ()	2,287.	2,919.	3,371.	4,380.
	42"	78"	26.5"	AMG42E784 () () () () ()	2,352.	2,998.	3,460.	4,500.
	42"	84"	26.5"	AMG42E844 () () () () ()	2,416.	3,079.	3,555.	4,623.
	42"	90"	26.5"	AMG42E904 () () () () ()	2,481.	3,158.	3,647.	4,741.
	42"	96"	26.5"	AMG42E964 () () () () ()	2,544.	3,241.	3,741.	4,866.

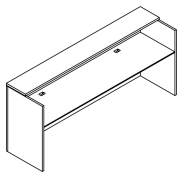

Medians with double end gable 42"h x 32.5"d with legal depth top shelf	42"	60"	32.5"	AMG42E605 () () () () ()	2,272.	2,879.	3,337.	4,338.
	42"	66"	32.5"	AMG42E665 () () () () ()	2,335.	2,958.	3,428.	4,456.
	42"	72"	32.5"	AMG42E725 () () () () ()	2,400.	3,036.	3,520.	4,577.
	42"	78"	32.5"	AMG42E785 () () () () ()	2,463.	3,119.	3,612.	4,696.
	42"	84"	32.5"	AMG42E845 () () () () ()	2,528.	3,197.	3,704.	4,814.
	42"	90"	32.5"	AMG42E905 () () () () ()	2,592.	3,275.	3,796.	4,934.
	42"	96"	32.5"	AMG42E965 () () () () ()	2,654.	3,354.	3,886.	5,051.

Medians

Order Code	Specification Information	Application Notes
Example: AMB42E604GFNEBV316 V316613AA	<i>To order please specify pattern number including:</i>	
A AutoStrada	1. Width	
M Median	2. Depth	6. Finish, surround, top shelf and worksurface front edge <i>Laminate, V1, V2 or V3 finish</i>
B Binder depth top shelf	4 = 26.5" d nominal	7. Finish, worksurface <i>Laminate, V1, V2 or V3 finish</i>
42 42" high	5 = 32.5" d nominal	8. Finish, Grommet(s) <i>specify painted or plated finish</i>
E End gables, both sides	3. Grommet option	9. Finish, Aluminum trim <i>AA - Anodized aluminum or painted finish option from page 8 excluding silver</i>
60 60" wide	G = Grommet(s)	
4 26.5" d	N = No grommet(s)	Order worksurface stiffener for unsupported spans exceeding 48".
G Grommet	4. Face drill option	*42"h to top of gable; with aluminum trim and top shelf 43.2"h.
FN Face drill gable, none	FL = face drill left gable for ganging	*Width noted is interior nominal dimension, overall footprint additional 2" nominal.
EB End drill gable, both	FR = face drill right gable for ganging	See page 8 for finish options applicable.
V316 Finish, surround, top shelf & worksurface edge	FN = face drill none	Product on this page will accept wood grain laminate where laminate is currently an option.
V316 Finish, worksurface	5. End drill option	
613 Finish, grommet	EL = end drill left gable to attach to bridge	
AA Trim, anodized aluminum	ER = end drill right gable to attach to bridge	
	EB = end drill both gables to attach to bridges (applicable 84"w, 90"w and 96"w only)	
	EN = no drill (for freestanding applications)	

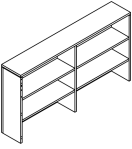
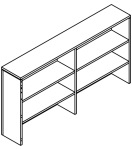
description	type	h*	w*	d	pattern no.	L	V1	V2	V3
 <p>Storage Median, 42" h w/ wood shelves</p> <p>center gable only in units 54" w and over</p>	binder depth	42"	42"	14"	ASM42WB42 () () ()	\$1,769.	\$2,230.	\$2,560.	\$3,331.
		42"	48"	14"	ASM42WB48 () () ()	1,842.	2,319.	2,666.	3,465.
		42"	54"	14"	ASM42WB54 () () ()	2,016.	2,746.	3,300.	4,291.
		42"	60"	14"	ASM42WB60 () () ()	2,092.	2,849.	3,427.	4,452.
		42"	66"	14"	ASM42WB66 () () ()	2,168.	2,953.	3,553.	4,619.
		42"	72"	14"	ASM42WB72 () () ()	2,243.	3,057.	3,675.	4,778.
		42"	78"	14"	ASM42WB78 () () ()	2,318.	3,158.	3,801.	4,942.
		42"	84"	14"	ASM42WB84 () () ()	2,396.	3,262.	3,927.	5,102.
		42"	90"	14"	ASM42WB90 () () ()	2,472.	3,365.	4,050.	5,266.
		42"	96"	14"	ASM42WB96 () () ()	2,547.	3,467.	4,176.	5,429.
 <p>Storage Median, 42" h w/ metal shelves</p> <p>center gable only in units 54" w and over</p>	binder depth	42"	42"	14"	ASM42MB42 () () ()	2,441.	2,985.	3,034.	3,642.
		42"	48"	14"	ASM42MB48 () () ()	2,540.	3,108.	3,158.	3,791.
		42"	54"	14"	ASM42MB54 () () ()	2,778.	3,399.	3,910.	4,695.
		42"	60"	14"	ASM42MB60 () () ()	2,883.	3,526.	4,059.	4,868.
		42"	66"	14"	ASM42MB66 () () ()	2,987.	3,654.	4,204.	5,048.
		42"	72"	14"	ASM42MB72 () () ()	3,091.	3,785.	4,354.	5,226.
		42"	78"	14"	ASM42MB78 () () ()	3,196.	3,910.	4,503.	5,403.
		42"	84"	14"	ASM42MB84 () () ()	3,303.	4,039.	4,651.	5,580.
		42"	90"	14"	ASM42MB90 () () ()	3,405.	4,168.	4,796.	5,758.
		42"	96"	14"	ASM42MB96 () () ()	3,511.	4,296.	4,945.	5,935.

Order Code	Specification Information	Application Notes
Example: ASM42WB42FNELV316AA	To order please specify pattern number including:	<p>Storage medians may be used in free-standing applications alone or multiple units side by side. When specifying side by side applications, be sure to select appropriate face drilling option (see specification option #4) and EN for no end drilling in gables. Storage medians may also be used with bridges on page 155 for creating L shaped work area configurations. When specifying for use with bridges, be sure to specify appropriate end drill option (see specification option #5).</p> <p>Center shelf fixed at 27" h to underside to align with bridge worksurface height and always same material as case (wood or laminate).</p> <p>Bridge units include hardware kit with washers to accommodate connection of 1" thick fixed storage median shelf to 1 1/4" thick bridge worksurface.</p> <p>Product on this page shipped knocked-down.</p>
A AutoStrada	1. Wood or Metal shelves Embedded in pattern number W = wood shelves M = metal shelves (Two piece extruded assembly) Note: shelf at worksurface height always wood	
SM Storage Median	2. Depth Embedded in pattern number B = Binder depth G = Legal depth	
42 42" high	3. Width	
W Wood shelves	4. Face drill option FL = face drill left gable for ganging FR = face drill right gable for ganging FB = face drill both gables for ganging FN = face drill none	
B Binder depth	5. End drill option EL = end drill left gable to attach to bridge ER = end drill right gable to attach to bridge EB = end drill both gables to attach to bridges (applicable 84" w, 90" w and 96" w only) EN = no drill (for freestanding applications)	
42 42" wide	6. Finish Laminate, V1, V2 or V3 finish	
FN Face drill gable, no	7. Finish, metal shelves AA - anodized aluminum or painted finish option from page 8 excluding silver	
EL End drill left gable	8. Finish, Aluminum trim AA - Anodized aluminum or painted finish option from page 8 excluding silver	
V316 Finish, Maple	*42" h to top of gables, with aluminum trim and top shelf 43.2" h. Inside width above, overall footprint additional 2" nominal.	
AA Trim, anodized aluminum	See page 8 for finish options applicable.	

Product on this page will accept wood grain laminate where laminate is currently an option.

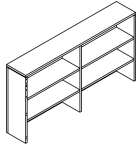
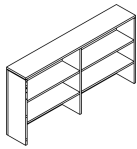
description	type	h*	w*	d	pattern no.	L	V1	V2	V3
 <p>Storage Median, 42" h w/wood shelves</p> <p><i>center gable only in units 54" w and over</i></p>	legal depth	42"	42"	17"	ASM42WG42 () () ()	\$1,861.	\$2,340.	\$2,690.	\$3,499.
		42"	48"	17"	ASM42WG48 () () ()	1,935.	2,436.	2,801.	3,642.
		42"	54"	17"	ASM42WG54 () () ()	2,118.	2,881.	3,466.	4,507.
		42"	60"	17"	ASM42WG60 () () ()	2,196.	2,990.	3,598.	4,677.
		42"	66"	17"	ASM42WG66 () () ()	2,276.	3,100.	3,729.	4,847.
		42"	72"	17"	ASM42WG72 () () ()	2,356.	3,207.	3,860.	5,018.
		42"	78"	17"	ASM42WG78 () () ()	2,436.	3,319.	3,992.	5,188.
		42"	84"	17"	ASM42WG84 () () ()	2,514.	3,426.	4,122.	5,357.
		42"	90"	17"	ASM42WG90 () () ()	2,595.	3,536.	4,253.	5,530.
		42"	96"	17"	ASM42WG96 () () ()	2,674.	3,643.	4,384.	5,702.
 <p>Storage Median, 42" h w/ metal shelves</p> <p><i>center gable only in units 54" w and over</i></p>	legal depth	42"	42"	17"	ASM42MG42 () () ()	2,564.	3,134.	3,186.	3,823.
		42"	48"	17"	ASM42MG48 () () ()	2,667.	3,266.	3,317.	3,981.
		42"	54"	17"	ASM42MG54 () () ()	2,917.	3,567.	4,106.	4,926.
		42"	60"	17"	ASM42MG60 () () ()	3,028.	3,703.	4,262.	5,113.
		42"	66"	17"	ASM42MG66 () () ()	3,137.	3,836.	4,418.	5,301.
		42"	72"	17"	ASM42MG72 () () ()	3,248.	3,971.	4,572.	5,487.
		42"	78"	17"	ASM42MG78 () () ()	3,356.	4,106.	4,728.	5,672.
		42"	84"	17"	ASM42MG84 () () ()	3,467.	4,242.	4,883.	5,859.
		42"	90"	17"	ASM42MG90 () () ()	3,576.	4,374.	5,037.	6,043.
		42"	96"	17"	ASM42MG96 () () ()	3,688.	4,509.	5,193.	6,233.

Order Code	Specification Information	Application Notes
<p>Example: ASM42WG42FNELV316AA</p> <p>A AutoStrada</p> <p>SM Storage Median</p> <p>42 42" high</p> <p>W Wood shelves</p> <p>G Legal depth</p> <p>42 42" wide</p> <p>FN Face drill gable, no</p> <p>EL End drill left gable</p> <p>V316 Finish, Maple</p> <p>AA Trim, anodized aluminum</p>	<p>To order please specify pattern number including:</p> <p>1. Wood or Metal shelves <i>Embedded in pattern number</i> <i>W = wood shelves</i> <i>M = metal shelves (Two piece extruded assembly)</i> <i>Note: shelf at worksurface height always wood</i></p> <p>2. Depth <i>Embedded in pattern number</i> <i>B = Binder depth</i> <i>G = Legal depth</i></p> <p>3. Width</p> <p>4. Face drill option <i>FL = face drill left gable for ganging</i> <i>FR = face drill right gable for ganging</i> <i>FB = face drill both gables for ganging</i> <i>FN = face drill none</i></p>	<p>5. End drill option <i>EL = end drill left gable to attach to bridge</i> <i>ER = end drill right gable to attach to bridge</i> <i>EB = end drill both gables to attach to bridges (applicable 84" w, 90" w and 96" w only)</i> <i>EN = no drill (for freestanding applications)</i></p> <p>6. Finish <i>Laminate, V1, V2 or V3 finish</i></p> <p>7. Finish, metal shelves <i>AA - Anodized aluminum or painted finish option from page 8 excluding silver</i></p> <p>8. Finish, Aluminum trim <i>AA - Anodized aluminum or painted finish option from page 8 excluding silver</i></p> <p>See page 8 for finish options applicable.</p> <p>*42" h to top of gables, with aluminum trim and top shelf 43.2" h. Inside width above, overall footprint additional 2" nominal.</p> <p>See page 8 for finish options applicable.</p> <p>Product on this page will accept wood grain laminate where laminate is currently an option.</p>
		<p>Storage medians may be used in free-standing applications alone or multiple units side by side. When specifying side by side applications, be sure to select appropriate face drilling option (see specification option #4) and EN for no end drilling in gables. Storage medians may also be used with bridges on page 155 for creating L shaped work area configurations. When specifying for use with bridges, be sure to specify appropriate end drill option (see specification option #5).</p> <p>Center shelf fixed at 27" h to underside to align with bridge worksurface height and always same material as case (wood or laminate).</p> <p>Bridge units include hardware kit with washers to accommodate connection of 1" thick fixed storage median shelf to 1 1/4" thick bridge worksurface.</p> <p>Products on this page shipped knocked-down.</p>

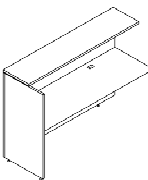
description	type	h*	w*	d	pattern no.	L	M/V1 or V1	M/V2 or V2	M/V3 or V3
 <p>left hand shown, worksurface height fixed 27" h to underside</p>	left hand	49"	42"	26 1/2"	AMBL424 () () () () () ()	\$1,619.	\$2,039.	\$2,344.	\$3,050.
		49"	48"	26 1/2"	AMBL484 () () () () () ()	1,688.	2,122.	2,440.	3,174.
		49"	54"	26 1/2"	AMBL544 () () () () () ()	1,753.	2,207.	2,538.	3,297.
		49"	60"	26 1/2"	AMBL604 () () () () () ()	1,819.	2,288.	2,634.	3,425.
		49"	66"	26 1/2"	AMBL664 () () () () () ()	1,884.	2,373.	2,729.	3,550.
		49"	72"	26 1/2"	AMBL724 () () () () () ()	1,953.	2,454.	2,825.	3,671.
		49"	78"	26 1/2"	AMBL784 () () () () () ()	2,018.	2,539.	2,920.	3,796.
		49"	84"	26 1/2"	AMBL844 () () () () () ()	2,084.	2,622.	3,016.	3,920.
		49"	90"	26 1/2"	AMBL904 () () () () () ()	2,152.	2,704.	3,112.	4,047.
		49"	96"	26 1/2"	AMBL964 () () () () () ()	2,215.	2,789.	3,206.	4,174.
	right hand	49"	42"	26 1/2"	AMBR424 () () () () () ()	1,619.	2,039.	2,344.	3,050.
		49"	48"	26 1/2"	AMBR484 () () () () () ()	1,688.	2,122.	2,440.	3,174.
		49"	54"	26 1/2"	AMBR544 () () () () () ()	1,753.	2,207.	2,538.	3,297.
		49"	60"	26 1/2"	AMBR604 () () () () () ()	1,819.	2,288.	2,634.	3,425.
		49"	66"	26 1/2"	AMBR664 () () () () () ()	1,884.	2,373.	2,729.	3,550.
		49"	72"	26 1/2"	AMBR724 () () () () () ()	1,953.	2,454.	2,825.	3,671.
		49"	78"	26 1/2"	AMBR784 () () () () () ()	2,018.	2,539.	2,920.	3,796.
		49"	84"	26 1/2"	AMBR844 () () () () () ()	2,084.	2,622.	3,016.	3,920.
		49"	90"	26 1/2"	AMBR904 () () () () () ()	2,152.	2,704.	3,112.	4,047.
		49"	96"	26 1/2"	AMBR964 () () () () () ()	2,215.	2,789.	3,206.	4,174.

Order Code	Specification Information	Application Notes
Example: AMBL424GFEV316 V316613AA	<i>To order please specify pattern number including:</i>	
A AutoStrada	1. Hand <i>L = Left hand</i> <i>R = Right hand</i>	7. Finish, surround, top shelf and worksurface front edge <i>Laminate, V1, V2 or V3 finish</i> 8. Finish, worksurface <i>Laminate, V1, V2 or V3 finish</i> 9. Finish, Grommet(s) <i>specify painted or plated finish</i> 10. Finish, Aluminum trim <i>AA - Anodized aluminum or painted finish option from page 8 excluding silver</i> Order worksurface stiffener for unsupported spans exceeding 48". *49" h to top of gable; with aluminum trim and top shelf 50.2" h. *Width noted is interior nominal dimension, overall footprint additional 1" nominal. See page 8 for finish options applicable. Product on this page will accept wood grain laminate where laminate is currently an option.
M Median	2. Width	
B Binder depth top shelf	3. Depth <i>4 = 26.5" d nominal</i> <i>5 = 32.5" d nominal</i>	
L Left hand	4. Grommet option <i>G = Grommet(s)</i> <i>N = No grommet(s)</i>	
42 42" wide	5. Face drill option <i>F = face drill for attachment to next unit</i> <i>N = no drill, last unit in run</i>	
4 26.5" d	6. End drill option <i>E = end drill gable to attach to bridge</i> <i>N = no drill</i>	
G Grommet		
F Face drill gable		
E End drill gable		
V316 Finish, surround, top shelf & worksurface edge		
V316 Finish, worksurface		
613 Finish, grommet		
AA Trim, anodized aluminum		

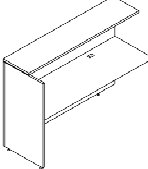
description	type	h*	w*	d	pattern no.	L	M/V1 or V1	M/V2 or V2	M/V3 or V3
 <p>left hand shown, worksurface height fixed 27" h to underside</p>	left hand	49"	42"	32 1/2"	AMBL425 () () () () () ()	\$1,715.	\$2,136.	\$2,459.	\$3,196.
		49"	48"	32 1/2"	AMBL485 () () () () () ()	1,780.	2,219.	2,552.	3,319.
		49"	54"	32 1/2"	AMBL545 () () () () () ()	1,846.	2,300.	2,648.	3,439.
		49"	60"	32 1/2"	AMBL605 () () () () () ()	1,912.	2,382.	2,742.	3,563.
		49"	66"	32 1/2"	AMBL665 () () () () () ()	1,977.	2,465.	2,836.	3,684.
		49"	72"	32 1/2"	AMBL725 () () () () () ()	2,043.	2,546.	2,930.	3,811.
		49"	78"	32 1/2"	AMBL785 () () () () () ()	2,106.	2,629.	3,025.	3,931.
		49"	84"	32 1/2"	AMBL845 () () () () () ()	2,176.	2,710.	3,119.	4,053.
		49"	90"	32 1/2"	AMBL905 () () () () () ()	2,239.	2,792.	3,213.	4,179.
		49"	96"	32 1/2"	AMBL965 () () () () () ()	2,306.	2,875.	3,309.	4,300.
			right hand	49"	42"	32 1/2"	AMBR425 () () () () () ()	1,715.	2,136.
		49"	48"	32 1/2"	AMBR485 () () () () () ()	1,780.	2,219.	2,552.	3,319.
		49"	54"	32 1/2"	AMBR545 () () () () () ()	1,846.	2,300.	2,648.	3,439.
		49"	60"	32 1/2"	AMBR605 () () () () () ()	1,912.	2,382.	2,742.	3,563.
		49"	66"	32 1/2"	AMBR665 () () () () () ()	1,977.	2,465.	2,836.	3,684.
		49"	72"	32 1/2"	AMBR725 () () () () () ()	2,043.	2,546.	2,930.	3,811.
		49"	78"	32 1/2"	AMBR785 () () () () () ()	2,106.	2,629.	3,025.	3,931.
		49"	84"	32 1/2"	AMBR845 () () () () () ()	2,176.	2,710.	3,119.	4,053.
		49"	90"	32 1/2"	AMBR905 () () () () () ()	2,239.	2,792.	3,213.	4,179.
		49"	96"	32 1/2"	AMBR965 () () () () () ()	2,306.	2,875.	3,309.	4,300.

Order Code

Example:	AMBR425GFEV316 V316613AA
A	AutoStrada
M	Median
B	Binder depth top shelf
R	Right hand
42	42" wide
5	32.5" d
G	Grommet
F	Face drill gable
E	End drill gable
V316	Finish, surround, top shelf & worksurface edge
V316	Finish, worksurface
613	Finish, grommet
AA	Trim, anodized aluminum

Specification Information

To order please specify pattern number including:

1. Hand
L = Left hand
R = Right hand
2. Width
3. Depth
4 = 26.5" d nominal
5 = 32.5" d nominal
4. Grommet option
G = Grommet(s)
N = No grommet(s)
5. Face drill option
F = face drill for attachment to next unit
N = no drill, last unit in run
6. End drill option
E = end drill gable to attach to bridge
N = no drill

7. Finish, surround, top shelf and worksurface front edge
Laminate, V1, V2 or V3 finish
8. Finish, worksurface
Laminate, V1, V2 or V3 finish
9. Finish, Grommet(s)
specify painted or plated finish
10. Finish, Aluminum trim
AA - Anodized aluminum or painted finish option from page 8 excluding silver

Order worksurface stiffener for unsupported spans exceeding 48".

*49"h to top of gable; with aluminum trim and top shelf 50.2"h.

*Width noted is interior nominal dimension, overall footprint additional 1" nominal.

See page 8 for finish options applicable.

Product on this page will accept wood grain laminate where laminate is currently an option.

Application Notes

Median end without gable to be attached to a storage anchored cabinet. Optional face drill option is to drill outside face of gable to attach to next median in line, if last unit in run specify no drill. Optional end drill gable option is for attachment to bridge units on page 155, specify no drill if configuration does not include bridge unit.

Mixed finish options applicable with V1, V2 or V3 finish surround, top shelf and worksurface front edge with laminate finish worksurface.

Product on this page shipped knocked-down.

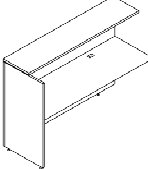
description	type	h*	w*	d	pattern no.	L	M/V1 or V1	M/V2 or V2	M/V3 or V3
 <p>left hand shown, worksurface height fixed 27" h to underside</p>	left hand	49"	42"	26 1/2"	AMGL424 () () () () () ()	\$1,654.	\$2,080.	\$2,393.	\$3,110.
		49"	48"	26 1/2"	AMGL484 () () () () () ()	1,722.	2,165.	2,490.	3,238.
		49"	54"	26 1/2"	AMGL544 () () () () () ()	1,790.	2,251.	2,586.	3,364.
		49"	60"	26 1/2"	AMGL604 () () () () () ()	1,856.	2,335.	2,687.	3,494.
		49"	66"	26 1/2"	AMGL664 () () () () () ()	1,924.	2,420.	2,783.	3,618.
		49"	72"	26 1/2"	AMGL724 () () () () () ()	1,991.	2,506.	2,882.	3,746.
		49"	78"	26 1/2"	AMGL784 () () () () () ()	2,058.	2,590.	2,979.	3,873.
		49"	84"	26 1/2"	AMGL844 () () () () () ()	2,127.	2,673.	3,075.	4,000.
		49"	90"	26 1/2"	AMGL904 () () () () () ()	2,193.	2,757.	3,175.	4,126.
		49"	96"	26 1/2"	AMGL964 () () () () () ()	2,262.	2,844.	3,273.	4,256.
	right hand	49"	42"	26 1/2"	AMGR424 () () () () () ()	1,654.	2,080.	2,393.	3,110.
		49"	48"	26 1/2"	AMGR484 () () () () () ()	1,722.	2,165.	2,490.	3,238.
		49"	54"	26 1/2"	AMGR544 () () () () () ()	1,790.	2,251.	2,586.	3,364.
		49"	60"	26 1/2"	AMGR604 () () () () () ()	1,856.	2,335.	2,687.	3,494.
		49"	66"	26 1/2"	AMGR664 () () () () () ()	1,924.	2,420.	2,783.	3,618.
		49"	72"	26 1/2"	AMGR724 () () () () () ()	1,991.	2,506.	2,882.	3,746.
		49"	78"	26 1/2"	AMGR784 () () () () () ()	2,058.	2,590.	2,979.	3,873.
		49"	84"	26 1/2"	AMGR844 () () () () () ()	2,127.	2,673.	3,075.	4,000.
		49"	90"	26 1/2"	AMGR904 () () () () () ()	2,193.	2,757.	3,175.	4,126.
		49"	96"	26 1/2"	AMGR964 () () () () () ()	2,262.	2,844.	3,273.	4,256.

Order Code	Specification Information	Application Notes
Example: AMGL424GFEV316 V316613AA	To order please specify pattern number including:	Median end without gable to be attached to a storage anchored cabinet. Optional face drill option is to drill outside face of gable to attach to next median in line, if last unit in run specify no drill. Optional end drill gable option is for attachment to bridge units on page 155, specify no drill if configuration does not include bridge unit.
A AutoStrada	1. Left or Right hand <i>L = Left hand</i> <i>R = Right hand</i>	7. Finish, surround, top shelf & worksurface edge <i>Laminate, V1, V2 or V3 finish</i>
M Median	2. Width	8. Finish, worksurface <i>Laminate, V1, V2 or V3</i>
G Legal depth top shelf	3. Depth <i>4 = 26.5" d nominal</i> <i>5 = 32.5" d nominal</i>	9. Finish, Grommet(s) <i>specify painted or plated finish</i>
L Left hand	4. Grommet option <i>G = Grommet(s)</i> <i>N = No grommet(s)</i>	10. Finish, Aluminum trim <i>AA - Anodized aluminum or painted finish option from page 8 excluding silver</i>
42 42" wide	5. Face drill option <i>F = face drill for attachment to next unit</i> <i>N = no drill, last unit in run</i>	Order worksurface stiffener for unsupported spans exceeding 48".
4 26.5" d	6. End drill option <i>E = end drill gable to attach to bridge</i> <i>N = no drill</i>	*49"h to top of gable; with aluminum trim and top shelf 50.2"h.
G Grommet		*Width noted is interior nominal dimension, overall footprint additional 1" nominal.
F Face drill gable		See page 8 for finish options applicable.
E End drill gable		Product on this page will accept wood grain laminate where laminate is currently an option.
V316 Finish, surround, top shelf & worksurface edge		
V316 Finish, worksurface		
613 Finish, grommet		
AA Trim, anodized aluminum		

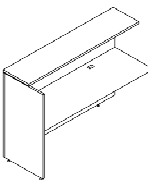
description	type	h*	w*	d	pattern no.	L	M/V1 or V1	M/V2 or V2	M/V3 or V3
 <p>left hand shown, worksurface height fixed 27" h to underside</p>	left hand	49"	42"	32 1/2"	AMGL425 () () () () () ()	\$1,750.	\$2,182.	\$2,507.	\$3,257.
		49"	48"	32 1/2"	AMGL485 () () () () () ()	1,815.	2,263.	2,603.	3,383.
		49"	54"	32 1/2"	AMGL545 () () () () () ()	1,881.	2,346.	2,699.	3,508.
		49"	60"	32 1/2"	AMGL605 () () () () () ()	1,951.	2,432.	2,794.	3,637.
		49"	66"	32 1/2"	AMGL665 () () () () () ()	2,017.	2,514.	2,892.	3,761.
		49"	72"	32 1/2"	AMGL725 () () () () () ()	2,084.	2,597.	2,987.	3,884.
		49"	78"	32 1/2"	AMGL785 () () () () () ()	2,152.	2,682.	3,087.	4,010.
		49"	84"	32 1/2"	AMGL845 () () () () () ()	2,216.	2,763.	3,181.	4,136.
		49"	90"	32 1/2"	AMGL905 () () () () () ()	2,284.	2,846.	3,279.	4,261.
		49"	96"	32 1/2"	AMGL965 () () () () () ()	2,350.	2,933.	3,375.	4,386.
	right hand	49"	42"	32 1/2"	AMGR425 () () () () () ()	1,750.	2,182.	2,507.	3,257.
		49"	48"	32 1/2"	AMGR485 () () () () () ()	1,815.	2,263.	2,603.	3,383.
		49"	54"	32 1/2"	AMGR545 () () () () () ()	1,881.	2,346.	2,699.	3,508.
		49"	60"	32 1/2"	AMGR605 () () () () () ()	1,951.	2,432.	2,794.	3,637.
		49"	66"	32 1/2"	AMGR665 () () () () () ()	2,017.	2,514.	2,892.	3,761.
		49"	72"	32 1/2"	AMGR725 () () () () () ()	2,084.	2,597.	2,987.	3,884.
		49"	78"	32 1/2"	AMGR785 () () () () () ()	2,152.	2,682.	3,087.	4,010.
		49"	84"	32 1/2"	AMGR845 () () () () () ()	2,216.	2,763.	3,181.	4,136.
		49"	90"	32 1/2"	AMGR905 () () () () () ()	2,284.	2,846.	3,279.	4,261.
		49"	96"	32 1/2"	AMGR965 () () () () () ()	2,350.	2,933.	3,375.	4,386.

Medians

Order Code	Specification Information	Application Notes
Example: AMGR425GFEV316 V316613AA	To order please specify pattern number including:	
A AutoStrada	1. Left or Right hand <i>L = Left hand</i> <i>R = Right hand</i>	Median end without gable to be attached to a storage anchored cabinet. Optional face drill option is to drill outside face of gable to attach to next median in line, if last unit in run specify no drill. Optional end drill gable option is for attachment to bridge units on page 155, specify no drill if configuration does not include bridge unit. Mixed finish options applicable with V1, V2 or V3 finish surround, top shelf and worksurface front edge with laminate finish worksurface. Product on this page shipped knocked-down. *49"h to top of gable; with aluminum trim and top shelf 50.2"h. *Width noted is interior nominal dimension, overall footprint additional 1" nominal. See page 8 for finish options applicable. Product on this page will accept wood grain laminate where laminate is currently an option.
M Median	2. Width	
G Legal depth top shelf	3. Depth <i>4 = 26.5" d nominal</i> <i>5 = 32.5" d nominal</i>	
R Right hand	4. Grommet option <i>G = Grommet(s)</i> <i>N = No grommet(s)</i>	
42 42" wide	5. Face drill option <i>F = face drill for attachment to next unit</i> <i>N = no drill, last unit in run</i>	
5 32.5" d	6. End drill option <i>E = end drill gable to attach to bridge</i> <i>N = no drill</i>	
G Grommet	7. Finish, surround, top shelf & worksurface edge <i>Laminate, V1, V2 or V3 finish</i>	
F Face drill gable	8. Finish, worksurface <i>Laminate, V1, V2 or V3</i>	
E End drill gable	9. Finish, Grommet(s) <i>specify painted or plated finish</i>	
V316 Finish, surround, top shelf & worksurface edge	10. Finish, Aluminum trim <i>AA - Anodized aluminum or painted finish option from page 8 excluding silver</i>	
V316 Finish, worksurface		
613 Finish, grommet		
AA Trim, anodized aluminum		

description	h*	w*	d	pattern no.	L	M/V1 or V1	M/V2 or V2	M/V3 or V3
Medians with double end gable	49"	60"	26.5"	AMBE604()	\$2,237.	\$2,856.	\$3,297.	\$4,288.
49"h x 26.5"d with binder depth top shelf	49"	66"	26.5"	AMBE664()	2,304.	2,939.	3,394.	4,414.
	49"	72"	26.5"	AMBE724()	2,369.	3,024.	3,490.	4,538.
	49"	78"	26.5"	AMBE784()	2,436.	3,106.	3,587.	4,661.
	49"	84"	26.5"	AMBE844()	2,500.	3,190.	3,681.	4,786.
	49"	90"	26.5"	AMBE904()	2,567.	3,273.	3,779.	4,913.
	49"	96"	26.5"	AMBE964()	2,634.	3,355.	3,874.	5,036.

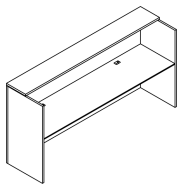

Medians with double end gable	49"	60"	32.5"	AMBE605()	2,355.	2,983.	3,457.	4,494.
49"h x 32.5"d with binder depth top shelf	49"	66"	32.5"	AMBE665()	2,419.	3,064.	3,554.	4,619.
	49"	72"	32.5"	AMBE725()	2,487.	3,145.	3,647.	4,739.
	49"	78"	32.5"	AMBE785()	2,549.	3,227.	3,742.	4,864.
	49"	84"	32.5"	AMBE845()	2,619.	3,311.	3,833.	4,985.
	49"	90"	32.5"	AMBE905()	2,681.	3,392.	3,930.	5,107.
	49"	96"	32.5"	AMBE965()	2,747.	3,473.	4,024.	5,234.

Order Code	Specification Information	Application Notes
Example: AMBE604GFNEBV316 V316613AA	<i>To order please specify pattern number including:</i>	Median with double end gables to be specified for single work station or end of run unit without storage anchored cabinet terminating work space. Optional end drill gable option is for attachment to bridge units on page 155, specify no drill if configuration does not include bridge unit.
A AutoStrada	1. Width	
M Median	2. Depth 4 = 26.5" d nominal 5 = 32.5" d nominal	
B Binder depth top shelf	3. Grommet option G = Grommet(s) N = No grommet(s)	
E End gables, both sides	4. Face drill option FL = face drill left gable for ganging FR = face drill right gable for ganging FN = face drill none	
60 60" wide	5. End drill option EL = end drill left gable to attach to bridge ER = end drill right gable to attach to bridge EB = end drill both gables to attach to bridges (applicable 84"w, 90"w and 96"w only) EN = no drill (for freestanding applications)	
4 26.5" d		
G Grommet		
FN Face drill gable, none		
EB End drill gable, both		
V316 Finish, surround, top shelf & worksurface edge		
V316 Finish, worksurface		
613 Finish, grommet		
AA Trim, anodized aluminum		
	6. Finish, surround, top shelf and worksurface front edge <i>Laminate, V1, V2 or V3 finish</i>	
	7. Finish, worksurface <i>Laminate, V1, V2 or V3 finish</i>	
	8. Finish, Grommet(s) <i>specify painted or plated finish</i>	
	9. Finish, Aluminum trim <i>AA - Anodized aluminum or painted finish option from page 8 excluding silver</i>	
	Order worksurface stiffener for unsupported spans exceeding 48".	Mixed finish options applicable with V1, V2 or V3 finish surround, top shelf and worksurface front edge with laminate finish worksurface.
	*49"h to top of gable; with aluminum trim and top shelf 50.2"h.	Product on this page shipped knocked-down.
	*Width noted is interior nominal dimension, overall footprint additional 2" nominal.	
	See page 8 for finish options applicable.	
	Product on this page will accept wood grain laminate where laminate is currently an option.	

description	h*	w*	d	pattern no.	L	M/V1 or V1	M/V2 or V2	M/V3 or V3
Medians with double end gable	49"	60"	26.5"	AMGE604() () () () ()	\$2,273.	\$2,902.	\$3,351.	\$4,357.
49"h x 26.5"d with legal depth top shelf	49"	66"	26.5"	AMGE664() () () () ()	2,341.	2,986.	3,449.	4,486.
	49"	72"	26.5"	AMGE724() () () () ()	2,409.	3,072.	3,548.	4,611.
	49"	78"	26.5"	AMGE784() () () () ()	2,477.	3,157.	3,644.	4,736.
	49"	84"	26.5"	AMGE844() () () () ()	2,543.	3,241.	3,742.	4,866.
	49"	90"	26.5"	AMGE904() () () () ()	2,611.	3,326.	3,838.	4,993.
	49"	96"	26.5"	AMGE964() () () () ()	2,677.	3,411.	3,935.	5,122.

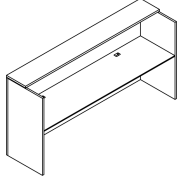

Medians with double end gable	49"	60"	32.5"	AMGE605() () () () ()	2,393.	3,030.	3,512.	4,566.
49"h x 32.5"d with legal depth top shelf	49"	66"	32.5"	AMGE665() () () () ()	2,460.	3,113.	3,608.	4,691.
	49"	72"	32.5"	AMGE725() () () () ()	2,525.	3,197.	3,706.	4,816.
	49"	78"	32.5"	AMGE785() () () () ()	2,593.	3,282.	3,802.	4,942.
	49"	84"	32.5"	AMGE845() () () () ()	2,660.	3,364.	3,899.	5,070.
	49"	90"	32.5"	AMGE905() () () () ()	2,727.	3,447.	3,995.	5,192.
	49"	96"	32.5"	AMGE965() () () () ()	2,793.	3,531.	4,091.	5,319.

Medians

Order Code	Specification Information	Application Notes
Example: AMBE604GFNEBV316 V316613AA	<i>To order please specify pattern number including:</i>	
A AutoStrada	1. Width	
M Median	2. Depth	
B Binder depth top shelf	4 = 26.5" d nominal	
E End gables, both sides	5 = 32.5" d nominal	
60 60" wide	3. Grommet option	
4 26.5" d	G = Grommet(s)	
G Grommet	N = No grommet(s)	
FN Face drill gable, none	4. Face drill option	
EB End drill gable, both	FL = face drill left gable for	
V316 Finish, surround, top shelf & worksurface edge	ganging	
	FR = face drill right gable for	
	ganging	
	FN = face drill none	
	5. End drill option	
	EL = end drill left gable to attach	
	to bridge	
	ER = end drill right gable to	
	attach to bridge	
	EB = end drill both gables to	
	attach to bridges (applicable	
	84"w, 90"w and 96"w only)	
	EN = no drill (for	
	freestanding applications)	
	6. Finish, surround, top shelf and	
	worksurface front edge	
	Laminate, V1, V2 or V3 finish	
	7. Finish, worksurface	
	Laminate, V1, V2 or V3 finish	
	8. Finish, Grommet(s)	
	specify painted or plated finish	
	9. Finish, Aluminum trim	
	AA - Anodized aluminum or	
	painted finish option from page	
	8 excluding silver	
	Order worksurface stiffener for	
	unsupported spans exceeding 48".	
	*49"h to top of gable; with	
	aluminum trim and top shelf 50.2"h.	
	*Width noted is interior nominal	
	dimension, overall footprint	
	additional 2" nominal.	
	See page 8 for finish options	
	applicable.	
	Product on this page will accept	
	wood grain laminate where laminate	
	is currently an option.	

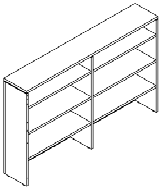
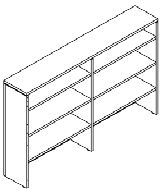
description	type	h*	w*	d	pattern no.	L	V1	V2	V3
 <p>Storage Median, 49"h w/wood shelves</p> <p><i>center gable only in units 54"w and over</i></p>	binder depth	49"	42"	14"	ASMWB42 () () ()	\$1,864.	\$2,345.	\$2,696.	\$3,506.
		49"	48"	14"	ASMWB48 () () ()	1,941.	2,440.	2,806.	3,648.
		49"	54"	14"	ASMWB54 () () ()	2,123.	2,889.	3,475.	4,517.
		49"	60"	14"	ASMWB60 () () ()	2,202.	2,998.	3,607.	4,687.
		49"	66"	14"	ASMWB66 () () ()	2,281.	3,108.	3,740.	4,861.
		49"	72"	14"	ASMWB72 () () ()	2,361.	3,216.	3,870.	5,030.
		49"	78"	14"	ASMWB78 () () ()	2,441.	3,326.	4,002.	5,202.
		49"	84"	14"	ASMWB84 () () ()	2,521.	3,433.	4,133.	5,371.
		49"	90"	14"	ASMWB90 () () ()	2,602.	3,544.	4,264.	5,544.
		49"	96"	14"	ASMWB96 () () ()	2,681.	3,650.	4,396.	5,715.
 <p>Storage Median, 49"h w/ metal shelves</p> <p><i>center gable only in units 54"w and over</i></p>	binder depth	49"	42"	14"	ASMMB42 () () ()	2,516.	3,076.	3,129.	3,754.
		49"	48"	14"	ASMMB48 () () ()	2,621.	3,202.	3,254.	3,907.
		49"	54"	14"	ASMMB54 () () ()	2,864.	3,503.	4,032.	4,840.
		49"	60"	14"	ASMMB60 () () ()	2,971.	3,637.	4,186.	5,018.
		49"	66"	14"	ASMMB66 () () ()	3,079.	3,767.	4,335.	5,204.
		49"	72"	14"	ASMMB72 () () ()	3,187.	3,901.	4,490.	5,389.
		49"	78"	14"	ASMMB78 () () ()	3,296.	4,032.	4,642.	5,570.
		49"	84"	14"	ASMMB84 () () ()	3,403.	4,165.	4,794.	5,753.
		49"	90"	14"	ASMMB90 () () ()	3,512.	4,295.	4,945.	5,934.
		49"	96"	14"	ASMMB96 () () ()	3,618.	4,430.	5,098.	6,118.

Order Code	Specification Information	Application Notes
<p>Example: ASMWB42FNELV316AA</p> <p>A AutoStrada</p> <p>SM Storage Median</p> <p>W Wood shelves</p> <p>B Binder depth</p> <p>42 42" wide</p> <p>FN Face drill gable, no</p> <p>EL End drill left gable</p> <p>V316 Finish, Maple</p> <p>AA Trim, anodized aluminum</p>	<p>To order please specify pattern number including:</p> <p>1. Wood or Metal shelves <i>Embedded in pattern number</i> <i>W = wood shelves</i> <i>M = metal shelves (Two piece extruded assembly)</i> <i>Note: shelf at worksurface height always wood</i></p> <p>2. Depth <i>Embedded in pattern number</i> <i>B = Binder depth</i> <i>G = Legal depth</i></p> <p>3. Width</p> <p>4. Face drill option <i>FL = face drill left gable for ganging</i> <i>FR = face drill right gable for ganging</i> <i>FB = face drill both gables for ganging</i> <i>FN = face drill none</i></p>	<p>5. End drill option <i>EL = end drill left gable to attach to bridge</i> <i>ER = end drill right gable to attach to bridge</i> <i>EB = end drill both gables to attach to bridges (applicable 84"w, 90"w and 96"w only)</i> <i>EN = no drill (for freestanding applications)</i></p> <p>6. Finish <i>Laminate, V1, V2 or V3 finish</i></p> <p>7. Finish, metal shelves <i>AA - anodized aluminum or painted finish option from page 8 excluding silver</i></p> <p>8. Finish, Aluminum trim <i>AA - Anodized aluminum or painted finish option from page 8 excluding silver</i></p> <p>See page 8 for finish options applicable.</p> <p>*49"h to top of gables, with aluminum trim and top shelf 50.2"h. Inside width above, overall footprint additional 2" nominal.</p> <p>See page 8 for finish options applicable.</p> <p>Product on this page will accept wood grain laminate where laminate is currently an option.</p>

Storage medians may be used in free-standing applications alone or multiple units side by side. When specifying side by side applications, be sure to select appropriate face drilling option (see specification option #4) and EN for no end drilling in gables. Storage medians may also be used with bridges on page 155 for creating L shaped work area configurations. When specifying for use with bridges, be sure to specify appropriate end drill option (see specification option #5).

Center shelf fixed at 27"h to underside to align with bridge worksurface height and always same material as case (wood or laminate). Nominally top shelf 7 1/2"h, other two 13"h.

Bridge units include hardware kit with washers to accommodate connection of 1" thick fixed storage median shelf to 1 1/4" thick bridge worksurface.

Product on this page shipped knocked-down.

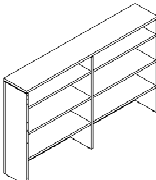
description	type	h*	w*	d	pattern no.	L	V1	V2	V3
 <p>center gable only in units 54"w and over</p>	legal depth	49"	42"	17"	ASMWG42 () () ()	\$1,958.	\$2,464.	\$2,831.	\$3,681.
		49"	48"	17"	ASMWG48 () () ()	2,036.	2,563.	2,947.	3,831.
		49"	54"	17"	ASMWG54 () () ()	2,229.	3,032.	3,649.	4,743.
		49"	60"	17"	ASMWG60 () () ()	2,312.	3,147.	3,788.	4,923.
		49"	66"	17"	ASMWG66 () () ()	2,396.	3,262.	3,926.	5,102.
		49"	72"	17"	ASMWG72 () () ()	2,481.	3,379.	4,063.	5,281.
		49"	78"	17"	ASMWG78 () () ()	2,564.	3,494.	4,202.	5,461.
		49"	84"	17"	ASMWG84 () () ()	2,646.	3,606.	4,338.	5,639.
		49"	90"	17"	ASMWG90 () () ()	2,730.	3,722.	4,476.	5,820.
		49"	96"	17"	ASMWG96 () () ()	2,816.	3,833.	4,618.	6,002.

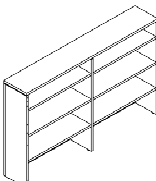
 <p>center gable only in units 54"w and over</p>	legal depth	49"	42"	17"	ASMMG42 () () ()	2,642.	3,231.	3,285.	3,943.
		49"	48"	17"	ASMMG48 () () ()	2,749.	3,364.	3,417.	4,104.
		49"	54"	17"	ASMMG54 () () ()	3,006.	3,676.	4,234.	5,079.
		49"	60"	17"	ASMMG60 () () ()	3,121.	3,818.	4,395.	5,271.
		49"	66"	17"	ASMMG66 () () ()	3,235.	3,957.	4,554.	5,463.
		49"	72"	17"	ASMMG72 () () ()	3,348.	4,093.	4,713.	5,657.
		49"	78"	17"	ASMMG78 () () ()	3,461.	4,234.	4,873.	5,848.
		49"	84"	17"	ASMMG84 () () ()	3,573.	4,372.	5,034.	6,041.
		49"	90"	17"	ASMMG90 () () ()	3,688.	4,510.	5,193.	6,231.
		49"	96"	17"	ASMMG96 () () ()	3,800.	4,650.	5,354.	6,424.

Order Code	Specification Information	Application Notes
Example: ASMWG42FNELV316AA A AutoStrada SM Storage Median W Wood shelves G Legal depth 42 42" wide FN Face drill gable, no EL End drill left gable V316 Finish, Maple AA Trim, anodized aluminum	To order please specify pattern number including: 1. Wood or Metal shelves Embedded in pattern number W = wood shelves M = metal shelves (Two piece extruded assembly) Note: shelf at worksurface height always wood 2. Depth Embedded in pattern number B = Binder depth G = Legal depth 3. Width 4. Face drill option FL = face drill left gable for ganging FR = face drill right gable for ganging FB = face drill both gables for ganging FN = face drill none	5. End drill option EL = end drill left gable to attach to bridge ER = end drill right gable to attach to bridge EB = end drill both gables to attach to bridges (applicable 84"w, 90"w and 96"w only) EN = no drill (for freestanding applications) 6. Finish Laminate, V1, V2 or V3 finish 7. Finish, metal shelves AA - Anodized aluminum or painted finish option from page 8 excluding silver 8. Finish, Aluminum trim AA - Anodized aluminum or painted finish option from page 8 excluding silver See page 8 for finish options applicable. *49"h to top of gables, with aluminum trim and top shelf 50.2"h. Inside width above, overall footprint additional 2" nominal. See page 8 for finish options applicable. Product on this page will accept wood grain laminate where laminate is currently an option.

Storage medians may be used in free-standing applications alone or multiple units side by side. When specifying side by side applications, be sure to select appropriate face drilling option (see specification option #4) and EN for no end drilling in gables. Storage medians may also be used with bridges on page 155 for creating L shaped work area configurations. When specifying for use with bridges, be sure to specify appropriate end drill option (see specification option #5).

Center shelf fixed at 27"h to underside to align with bridge worksurface height and always same material as case (wood or laminate). Nominally top shelf 7 1/2"h, other two 13"h.

Bridge units include hardware kit with washers to accommodate connection of 1" thick fixed storage median shelf to 1 1/4" thick bridge worksurface.

Products on this page shipped knocked-down.

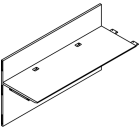
description	h	w	d	pattern no.	L	M/V1 or V1	M/V2 or V2	M/V3 or V3
 <p>worksurface height fixed 27" h to underside</p>	42"	42"	26 1/2"	AOB4242 () () () ()	\$1,021.	\$1,286.	\$1,479.	\$1,922.
	42"	48"	26 1/2"	AOB4248 () () () ()	1,062.	1,337.	1,537.	2,000.
	42"	54"	26 1/2"	AOB4254 () () () ()	1,107.	1,387.	1,600.	2,078.
	42"	60"	26 1/2"	AOB4260 () () () ()	1,146.	1,442.	1,659.	2,157.
	42"	66"	26 1/2"	AOB4266 () () () ()	1,187.	1,494.	1,720.	2,233.
	42"	72"	26 1/2"	AOB4272 () () () ()	1,230.	1,545.	1,780.	2,314.
	42"	78"	26 1/2"	AOB4278 () () () ()	1,271.	1,600.	1,838.	2,393.

Order Code	Specification Information	Application Notes
Example: AOB4242GDV316V316613	<i>To order please specify pattern number including:</i>	Overall depth is 26.5" nominal
A AutoStrada	1. Width	Product on this page shipped knocked-down.
OB Open Bridge	2. Grommet option <i>G = Grommet(s)</i> <i>N = No grommet(s)</i>	
42 42" high	3. Drill for top shelf option <i>Note: not applicable for window bridges</i> <i>D = drill for top shelf attachment</i> <i>N = no drill for top shelf attachment</i>	
42 42" wide	4. Finish, back and worksurface edge <i>Laminate, V1, V2 or V3 finish</i>	Bridge units attach one side to gable end of medians or storage medians, and other end to 26.5" deep storage anchored cabinets. Attachment method is universal, bridge units are not handed.
G Grommet	5. Finish, worksurface <i>Laminate, V1, V2 or V3 finish</i>	
D Drill for top shelf attachment	6. Finish, Grommet(s) <i>specify painted or plated finish</i>	Mixed finish options must only be combination of laminate surface with V1 or V2 or V3 back and edge.
V316 Finish, back panel & edge	Order worksurface stiffener for unsupported spans exceeding 48".	Optional top shelf for bridge assembly specified separately, refer to page 156. Be sure to specify drill for top shelf if required.
V316 Finish, worksurface	See page 8 for finish options applicable.	
613 Finish, grommet	Product on this page will accept wood grain laminate where laminate is currently an option.	

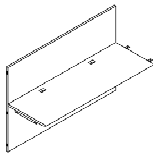
description	h	w	d	pattern no.	L	M/V1 or V1	M/V2 or V2	M/V3 or V3
 <p>Bridge assembly, 49"h includes worksurface</p>	49"	42"	26 1/2"	AOBS42 () () () ()	\$1,073.	\$1,354.	\$1,556.	\$2,023.
	49"	48"	26 1/2"	AOBS48 () () () ()	1,119.	1,407.	1,619.	2,107.
	49"	54"	26 1/2"	AOBS54 () () () ()	1,162.	1,460.	1,683.	2,189.
	49"	60"	26 1/2"	AOBS60 () () () ()	1,205.	1,519.	1,746.	2,269.
	49"	66"	26 1/2"	AOBS66 () () () ()	1,251.	1,574.	1,811.	2,351.
	49"	72"	26 1/2"	AOBS72 () () () ()	1,294.	1,628.	1,873.	2,436.
	49"	78"	26 1/2"	AOBS78 () () () ()	1,338.	1,683.	1,934.	2,518.

worksurface height fixed 27"h to underside

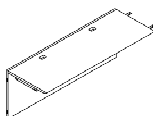
 <p>Bridge assembly, includes worksurface</p>	28"	42"	26 1/2"	AWBS42 () () () ()	1,007.	1,266.	1,453.	1,890.
	28"	48"	26 1/2"	AWBS48 () () () ()	1,045.	1,315.	1,514.	1,968.
	28"	54"	26 1/2"	AWBS54 () () () ()	1,086.	1,368.	1,574.	2,044.
	28"	60"	26 1/2"	AWBS60 () () () ()	1,127.	1,420.	1,631.	2,121.
	28"	66"	26 1/2"	AWBS66 () () () ()	1,167.	1,472.	1,691.	2,196.
	28"	72"	26 1/2"	AWBS72 () () () ()	1,211.	1,522.	1,751.	2,278.
	28"	78"	26 1/2"	AWBS78 () () () ()	1,251.	1,574.	1,811.	2,351.
	28"	84"	26 1/2"	AWBS84 () () () ()	1,291.	1,626.	1,870.	2,430.
	28"	90"	26 1/2"	AWBS90 () () () ()	1,332.	1,676.	1,928.	2,507.
	28"	96"	26 1/2"	AWBS96 () () () ()	1,372.	1,728.	1,987.	2,582.

worksurface height fixed 27"h to underside

Specify with window bridge kits to achieve 49"h

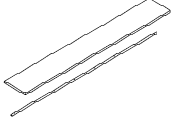

Order Code	Specification Information	Application Notes
Example: AOBS42GDV316V316613	To order please specify pattern number including:	Overall depth is 26.5" nominal
A AutoStrada	1. Width	Product on this page shipped knocked-down.
OB Open Bridge	2. Grommet option <i>G = Grommet(s)</i> <i>N = No grommet(s)</i>	
S Single	3. Drill for top shelf option <i>Note: not applicable for window bridges</i>	Bridge units attach one side to gable end of medians or storage medians, and other end to 26.5" deep storage anchored cabinets. Attachment method is universal, bridge units are not handed.
42 42" wide	<i>D = drill for top shelf attachment</i> <i>N = no drill for top shelf attachment</i>	
G Grommet	4. Finish, back and worksurface edge <i>Laminate, V1, V2 or V3 finish</i>	Mixed finish options must only be combination of laminate surface with V1 or V2 or V3 back and edge.
D Drill for top shelf attachment	5. Finish, worksurface <i>Laminate, V1, V2 or V3 finish</i>	
V316 Finish, back panel & edge	6. Finish, Grommet(s) <i>specify painted or plated finish</i>	Window kit and window trim kit for window bridge assembly specified separately, refer to page 158.
V316 Finish, worksurface	Order worksurface stiffener for unsupported spans exceeding 48".	
613 Finish, grommet	See page 8 for finish options applicable.	Optional top shelf for bridge assembly specified separately, refer to page 156. Be sure to specify drill for top shelf if required.
	Product on this page will accept wood grain laminate where laminate is currently an option.	

description	thickness	w	d	pattern no.	L	V1	V2	V3
Top shelf for bridge assy to median w/26.5" gable & binder depth top 	1 1/4"	54 7/16"	14"	ATSBA42 () ()	\$302.	\$384.	\$441.	\$576.
	1 1/4"	60 7/16"	14"	ATSBA48 () ()	313.	398.	458.	595.
	1 1/4"	66 7/16"	14"	ATSBA54 () ()	324.	413.	476.	620.
	1 1/4"	72 7/16"	14"	ATSBA60 () ()	340.	430.	494.	642.
	1 1/4"	78 7/16"	14"	ATSBA66 () ()	352.	445.	511.	667.
	1 1/4"	84 7/16"	14"	ATSBA72 () ()	362.	463.	529.	690.
	1 1/4"	90 7/16"	14"	ATSBA78 () ()	376.	476.	547.	712.
Top shelf for bridge assy to median w/26.5" gable & legal depth top	1 1/4"	51 7/16"	14"	ATSBB42 () ()	302.	384.	441.	576.
	1 1/4"	57 7/16"	14"	ATSBB48 () ()	313.	398.	458.	595.
	1 1/4"	63 7/16"	14"	ATSBB54 () ()	324.	413.	476.	620.
	1 1/4"	69 7/16"	14"	ATSBB60 () ()	340.	430.	494.	642.
	1 1/4"	75 7/16"	14"	ATSBB66 () ()	352.	445.	511.	667.
	1 1/4"	81 7/16"	14"	ATSBB72 () ()	362.	463.	529.	690.
	1 1/4"	87 7/16"	14"	ATSBB78 () ()	376.	476.	547.	712.
Top shelf for bridge assy to median w/32.5" gable & binder depth top	1 1/4"	60 7/16"	14"	ATSBC42 () ()	373.	475.	546.	708.
	1 1/4"	66 7/16"	14"	ATSBC48 () ()	388.	493.	569.	737.
	1 1/4"	72 7/16"	14"	ATSBC54 () ()	404.	512.	592.	765.
	1 1/4"	78 7/16"	14"	ATSBC60 () ()	421.	532.	614.	798.
	1 1/4"	84 7/16"	14"	ATSBC66 () ()	435.	551.	634.	827.
	1 1/4"	90 7/16"	14"	ATSBC72 () ()	450.	571.	657.	855.
	1 1/4"	96 7/16"	14"	ATSBC78 () ()	465.	592.	679.	884.
Top shelf for bridge assy to median w/32.5" gable & legal depth top	1 1/4"	57 7/16"	14"	ATSBD42 () ()	373.	475.	546.	708.
	1 1/4"	63 7/16"	14"	ATSBD48 () ()	388.	493.	569.	737.
	1 1/4"	69 7/16"	14"	ATSBD54 () ()	404.	512.	592.	765.
	1 1/4"	75 7/16"	14"	ATSBD60 () ()	421.	532.	614.	798.
	1 1/4"	81 7/16"	14"	ATSBD66 () ()	435.	551.	634.	827.
	1 1/4"	87 7/16"	14"	ATSBD72 () ()	450.	571.	657.	855.
	1 1/4"	93 7/16"	14"	ATSBD78 () ()	465.	592.	679.	884.
Top shelf for bridge assy to storage median	1 1/4"	42"	14"	ATSBE42 () ()	302.	384.	441.	576.
	1 1/4"	48"	14"	ATSBE48 () ()	313.	398.	458.	595.
	1 1/4"	54"	14"	ATSBE54 () ()	324.	413.	476.	620.

Order Code	Specification Information	Application Notes
Example: ATSBA42V316AA A AutoStrada TS Top Shelf B Bridge A for bridge to median condition A 42 42" wide plus condition A V316 Finish, Maple AA Trim, anodized aluminum	To order please specify pattern number including: 1. Bridge to Median condition <i>A = to 26.5" d median w/binder depth top shelf</i> <i>B = to 26.5" d median w/legal depth top shelf</i> <i>C = to 32.5" d median w/binder depth top shelf</i> <i>D = to 32.5" d median w/legal depth top shelf</i> <i>E = to storage median binder or legal depth</i> 2. Width <i>specify same as corresponding bridge assembly</i> 3. Finish, Shelf <i>Laminate, V1, V2 or V3 finish</i> 4. Finish, Aluminum trim <i>AA - Anodized aluminum or painted finish option from page 8 excluding silver</i>	See page 8 for finish options applicable. Product on this page will accept wood grain laminate where laminate is currently an option. Top shelf extends width of bridge assembly plus exposed portion of the median gable where the median gable extends beyond median's top shelf. Top shelf assembly includes aluminum trim to install between bridge assembly and underside of top shelf; and aligns with aluminum trim detail of median or storage median.

description	thickness	w	d	pattern no.	L	V1	V2	V3
Top shelf for bridge assy to storage median	1 1/4"	60"	14"	ATSBE60 () ()	\$340.	\$430.	\$494.	\$642.
	1 1/4"	66"	14"	ATSBE66 () ()	352.	445.	511.	667.
	1 1/4"	72"	14"	ATSBE72 () ()	362.	463.	529.	690.
	1 1/4"	78"	14"	ATSBE78 () ()	376.	476.	547.	712.

Order Code	Specification Information	Application Notes
Example: ATSBA42V316AA	<i>To order please specify pattern number including:</i>	See page 8 for finish options applicable.
A AutoStrada		
TS Top Shelf		
B Bridge		
A for bridge to median condition A	1. Bridge to Median condition <i>A = to 26.5" d median w/binder depth top shelf</i> <i>B = to 26.5" d median w/legal depth top shelf</i> <i>C = to 32.5" d median w/binder depth top shelf</i> <i>D = to 32.5" d median w/legal depth top shelf</i> <i>E = to storage median binder or legal depth</i>	Top shelf extends width of bridge assembly plus exposed portion of the median gable where the median gable extends beyond median's top shelf.
42 42" wide plus condition A		
V316 Finish, Maple		Top shelf assembly includes aluminum trim to install between bridge assembly and underside of top shelf; and aligns with aluminum trim detail of median or storage median.
AA Trim, anodized aluminum	2. Width <i>specify same as corresponding bridge assembly</i> 3. Finish, Shelf <i>Laminate, V1, V2 or V3 finish</i> 4. Finish, Aluminum trim <i>AA - Anodized aluminum or painted finish option from page 8 excluding silver</i>	

description	h	w	pattern no.	clear	architectural	list
Window Bridge Kit 	21"	42"	AWBK42 () () ()	\$775.	\$934.	
	21"	48"	AWBK48 () () ()	838.	1,005.	
	21"	54"	AWBK54 () () ()	898.	1,078.	
	21"	60"	AWBK60 () () ()	958.	1,150.	
	21"	66"	AWBK66 () () ()	1,018.	1,221.	
	21"	72"	AWBK72 () () ()	1,080.	1,295.	
	21"	78"	AWBK78 () () ()	1,138.	1,368.	
	21"	84"	AWBK84 () () ()	1,200.	1,440.	
	21"	90"	AWBK90 () () ()	1,260.	1,514.	
	21"	96"	AWBK96 () () ()	1,320.	1,586.	
Median gable top trim for window to median w/26.5" gable & binder depth top		12"	AMGTTA ()			105.
		9"	AMGTTB ()			88.
	Median gable top trim for window to median w/26.5" gable & legal depth top					
Median gable top trim for window to median w/32.5" gable & binder depth top		18"	AMGTTC ()			130.
Median gable top trim for window to median w/32.5" gable & legal depth top		15"	AMGTTD ()			116.

Order Code	Specification Information	Application Notes
Example: AWBK42EAAGL13AA A AutoStrada W Window BK Bridge kit 42 42" wide E Extruded Aluminum Top Trim AA Finish, window frame GL13 Finish, glass AA Finish, aluminum top trim	To order please specify pattern number including: Window bridge kit: 1. Width <i>Note: Be sure to specify window bridge kit to correspond with width of window bridge assembly</i> 2. Extruded Aluminum Top Trim profile <i>E = default</i> 3. Finish, window frame <i>Paint or Anodized Aluminum</i> 4. Finish, glass <i>TEMP - Clear, tempered</i> <i>GL6 - Block Matrix</i> <i>GL13 - Powder</i> 5. Finish, Aluminum top trim <i>AA - anodized aluminum or painted finish option from page 8 excluding silver</i>	Window bridge kits are for use with window bridge assemblies on page 155. Be sure to include median gable top trim when attaching window bridge assembly and window bridge kit to medians for the appropriate condition of median gable and top shelf. The median gable top trim is an aluminum extrusion which finishes the exposed portion of the median gable and continues a consistent aluminum trim detail from one unit to the next.

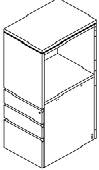
description	hand	h	w	d	pattern no.	L	V1	V2	V3
Storage anchored cabinet, BBF front, open interior side 	left	42"	19"	24"	ACAL4224 () () () ()	\$3,252.	\$4,771.	\$5,179.	\$6,731.
		42"	19"	30"	ACAL4230 () () () ()	3,502.	5,043.	5,533.	7,195.
		42"	19"	26.5"	ACAL4226 () () () ()	3,378.	4,907.	5,357.	6,966.
		42"	19"	32.5"	ACAL4232 () () () ()	3,626.	5,181.	5,712.	7,425.
		49"	19"	24"	ACAL4924 () () () () ()	3,319.	4,868.	5,284.	6,870.
		49"	19"	30"	ACAL4930 () () () () ()	3,572.	5,147.	5,646.	7,342.
		49"	19"	26.5"	ACAL4926 () () () () ()	3,446.	5,008.	5,467.	7,107.
		49"	19"	32.5"	ACAL4932 () () () () ()	3,700.	5,285.	5,828.	7,577.
		left hand shown, shelf aligns with worksurface at 28 1/4" overall, or 27"h to underside	right	42"	19"	24"	ACAR4224 () () () ()	3,252.	4,771.
42"	19"			30"	ACAR4230 () () () ()	3,502.	5,043.	5,533.	7,195.
42"	19"			26.5"	ACAR4226 () () () ()	3,378.	4,907.	5,357.	6,966.
42"	19"			32.5"	ACAR4232 () () () ()	3,626.	5,181.	5,712.	7,425.
49"	19"			24"	ACAR4924 () () () () ()	3,319.	4,868.	5,284.	6,870.
49"	19"			30"	ACAR4930 () () () () ()	3,572.	5,147.	5,646.	7,342.
49"	19"			26.5"	ACAR4926 () () () () ()	3,446.	5,008.	5,467.	7,107.
49"	19"			32.5"	ACAR4932 () () () () ()	3,700.	5,285.	5,828.	7,577.

Order Code	Specification Information	Application Notes
Example: ACAL4924NEDWV316AA	To order please specify pattern number including:	*Upcharge applicable as follows for ACA(L/R)49 and ACB(L/R)49 cabinets: Option S upcharge for L/V1/V2 or V3 to correspond to shelf to match case; Option M upcharge under AA or paint for aluminum metal shelf
A AutoStrada	1. Hand L = User's Left R = User's Right	When planning with panels, single station or cluster groups where all workstations within the group are the same direction/hand, then specify 26.5" or 32.5" deep storage anchor cabinet units. When planning multi-station clusters mirroring left hand/right hand or with stations back to back with panel run perpendicular to two cabinets, you then need to specify one 24" d with one 26.5" d or 30" d with one 32.5" d cabinet to go side by side or back to back as the case may be. Brackets to secure cabinets to panel are required, specified separately - see page 174.
C Cabinet	2. Height	24" and 30" deep storage anchored cabinets may be specified for freestanding applications, specify drill option F for freestanding, otherwise connection detail will be exposed.
A BBF front, Open interior side	3. Depth 24 = 24" deep 26 = 26.5" deep 30 = 30" deep 32 = 32.5" deep	Cabinets include angle bracket to side support worksurfaces except when drill option "F" for freestanding selected.
L Left Hand	4. Shelf option for open interior side 42" h do not have shelf options 49" h have shelf option 64" h do not have "no" shelf option, shelf included N = No shelf S = Shelf to match case * M = Two piece extruded aluminum metal shelf assembly * (*upcharge applicable)	Cabinets drilled for locks, keying instructions must accompany order.
49 49" high	5. Pull E = extruded aluminum pull P = extruded aluminum protruding pull	See page 8 for finish options applicable.
24 24" deep	6. Drill option, applicable only for 24" and 30" deep units D = drilled to anchor to panel or median F = no drill, freestanding	Pencil trays not included in pedestals with metal interior.
N No Shelf	7. Interior W = wood drawer interior M = metal drawer interior, deduct \$100 list	One pencil tray is included in pedestals with wood interior.
E Extruded Aluminum Pull	8. Finish Laminate, V1, V2 or V3 finish	
D Drilled to anchor	9. Finish, Aluminum trim (trim, M shelf option & pull) AA - Anodized aluminum or painted finish option from page 8 excluding silver	
W Wood interior		
V316 Finish, Maple		
AA Finish, trim & pull, anodized aluminum		

3rd digit in pattern number indicates storage configuration, see individual pattern groups above for description.

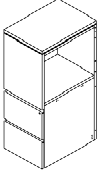
description	hand	h	w	d	pattern no.	L	V1	V2	V3
Storage anchored cabinet, FF front, open interior side 	left	42"	19"	24"	ACBL4224 () () () ()	\$2,788.	\$4,119.	\$4,571.	\$5,940.
		42"	19"	30"	ACBL4230 () () () ()	2,999.	4,352.	4,884.	6,347.
		42"	19"	26.5"	ACBL4226 () () () ()	2,893.	4,237.	4,726.	6,144.
		42"	19"	32.5"	ACBL4232 () () () ()	3,109.	4,474.	5,040.	6,553.
		49"	19"	24"	ACBL4924 () () () ()	2,845.	4,204.	4,663.	6,063.
		49"	19"	30"	ACBL4930 () () () ()	3,063.	4,443.	4,986.	6,478.
		49"	19"	26.5"	ACBL4926 () () () ()	2,953.	4,322.	4,825.	6,268.
		49"	19"	32.5"	ACBL4932 () () () ()	3,172.	4,562.	5,142.	6,686.
left hand shown, shelf aligns with worksurface at 28 1/2" h overall, or 27" h to underside	right	42"	19"	24"	ACBR4224 () () () ()	2,788.	4,119.	4,571.	5,940.
		42"	19"	30"	ACBR4230 () () () ()	2,999.	4,352.	4,884.	6,347.
		42"	19"	26.5"	ACBR4226 () () () ()	2,893.	4,237.	4,726.	6,144.
		42"	19"	32.5"	ACBR4232 () () () ()	3,109.	4,474.	5,040.	6,553.
		49"	19"	24"	ACBR4924 () () () ()	2,845.	4,204.	4,663.	6,063.
		49"	19"	30"	ACBR4930 () () () ()	3,063.	4,443.	4,986.	6,478.
		49"	19"	26.5"	ACBR4926 () () () ()	2,953.	4,322.	4,825.	6,268.
		49"	19"	32.5"	ACBR4932 () () () ()	3,172.	4,562.	5,142.	6,686.

Order Code	Specification Information	Application Notes
Example: ACAL4924NEDWV316AA	To order please specify pattern number including:	*Upcharge applicable as follows for ACA(L/R)49 and ACB(L/R)49 cabinets: Option S upcharge for L/V1/V2 or V3 to correspond to shelf to match case; Option M upcharge under AA or paint for aluminum metal shelf
A AutoStrada	1. Hand L = User's Left R = User's Right	When planning with panels, single station or cluster groups where all workstations within the group are the same direction/hand, then specify 26.5" or 32.5" deep storage anchor cabinet units. When planning multi-station clusters mirroring left hand/right hand or with stations back to back with panel run perpendicular to two cabinets, you then need to specify one 24" d with one 26.5" d or 30" d with one 32.5" d cabinet to go side by side or back to back as the case may be. Brackets to secure cabinets to panel are required, specified separately - see page 174.
C Cabinet	2. Height	24" and 30" deep storage anchored cabinets may be specified for freestanding applications, specify drill option F for freestanding, otherwise connection detail will be exposed.
A BBF front, Open interior side	3. Depth 24 = 24" deep 26 = 26.5" deep 30 = 30" deep 32 = 32.5" deep	Cabinets include angle bracket to side support worksurfaces except when drill option "F" for freestanding selected.
L Left Hand	4. Shelf option for open interior side 42" h do not have shelf options 49" h have shelf option 64" h do not have "no" shelf option, shelf included N = No shelf S = Shelf to match case * M = Two piece extruded aluminum metal shelf assembly * (*upcharge applicable)	Cabinets drilled for locks, keying instructions must accompany order.
49 49" high	5. Pull E = extruded aluminum pull P = extruded aluminum protruding pull	See page 8 for finish options applicable.
24 24" deep	6. Drill option, applicable only for 24" and 30" deep units D = drilled to anchor to panel or median F = no drill, freestanding	Pencil trays not included in pedestals with metal interior.
N No Shelf	7. Interior W = wood drawer interior M = metal drawer interior, deduct \$100 list	One pencil tray is included in pedestals with wood interior.
E Extruded Aluminum Pull	8. Finish Laminate, V1, V2 or V3 finish	
D Drilled to anchor	9. Finish, Aluminum trim (trim, M shelf option & pull) AA - Anodized aluminum or painted finish option from page 8 excluding silver	
W Wood interior		
V316 Finish, Maple		
AA Finish, trim & pull, anodized aluminum		

3rd digit in pattern number indicates storage configuration, see individual pattern groups above for description.

description	hand	h	w	d	pattern no.	L	V1	V2	V3
Storage anchored cabinet, Hinged Door front, open interior side	left	42"	19"	24"	ACCL4224 () () () ()	\$2,322.	\$3,433.	\$3,810.	\$4,948.
		42"	19"	30"	ACCL4230 () () () ()	2,500.	3,629.	4,071.	5,292.
		42"	19"	26.5"	ACCL4226 () () () ()	2,412.	3,529.	3,938.	5,123.
		42"	19"	32.5"	ACCL4232 () () () ()	2,591.	3,727.	4,201.	5,460.
		49"	19"	24"	ACCL4924 () () () ()	2,371.	3,503.	3,889.	5,049.
		49"	19"	30"	ACCL4930 () () () ()	2,551.	3,703.	4,154.	5,399.
		49"	19"	26.5"	ACCL4926 () () () ()	2,461.	3,601.	4,020.	5,226.
		49"	19"	32.5"	ACCL4932 () () () ()	2,642.	3,803.	4,285.	5,570.
		right	42"	19"	24"	ACCR4224 () () () ()	2,322.	3,433.	3,810.
42"	19"		30"	ACCR4230 () () () ()	2,500.	3,629.	4,071.	5,292.	
42"	19"		26.5"	ACCR4226 () () () ()	2,412.	3,529.	3,938.	5,123.	
42"	19"		32.5"	ACCR4232 () () () ()	2,591.	3,727.	4,201.	5,460.	
49"	19"		24"	ACCR4924 () () () ()	2,371.	3,503.	3,889.	5,049.	
49"	19"		30"	ACCR4930 () () () ()	2,551.	3,703.	4,154.	5,399.	
49"	19"		26.5"	ACCR4926 () () () ()	2,461.	3,601.	4,020.	5,226.	
49"	19"		32.5"	ACCR4932 () () () ()	2,642.	3,803.	4,285.	5,570.	

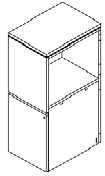

left hand shown, shelf aligns with work surface at 28 1/2" h overall, or 27" h to underside

Order Code	Specification Information	Application Notes
Example: ACCL4924NEDV316AA	To order please specify pattern number including:	*Upcharge applicable as follows for ACC(L/R)49 units on this page: For option S upcharge for LV1/V2 or V3 to correspond to shelf to match case; option M upcharge under AA or paint for aluminum metal shelf
A AutoStrada	1. Hand L = User's Left R = User's Right	When planning with panels, single station or cluster groups where all workstations within the group are the same direction/hand, then specify 26.5" or 32.5" deep storage anchor cabinet units. When planning multi-station clusters mirroring left hand/right hand or with stations back to back with panel run perpendicular to two cabinets, you then need to specify one 24" d with one 26.5" d or 30" d with one 32.5" d cabinet to go side by side or back to back as the case may be. Brackets to secure cabinets to panel are required, specified separately - see page 174.
C Cabinet	2. Height	24" and 30" deep storage anchored cabinets may be specified for freestanding applications, specify drill option F for freestanding, otherwise connection detail will be exposed.
C HD front, Open interior side	3. Depth 24 = 24" deep 30 = 30" deep 26 = 26.5" deep 32 = 32.5" deep	24" and 30" deep storage anchored cabinets may be specified for freestanding applications, specify drill option F for freestanding, otherwise connection detail will be exposed.
L Left Hand	4. Shelf option for open interior side 42" h do not have shelf options 49" h have shelf option 64" h do not have "no" shelf option, shelf included N = No shelf S = Shelf to match case * M = Two piece extruded aluminum metal shelf assembly * (*upcharge applicable)	24" and 30" deep storage anchored cabinets may be specified for freestanding applications, specify drill option F for freestanding, otherwise connection detail will be exposed.
49 49" high	5. Pull E = extruded aluminum pull P = extruded aluminum protruding pull	Cabinets include angle bracket to side support work surfaces except when drill option "F" for freestanding selected.
24 24" deep	6. Drill option applicable only for 24" and 30" deep units D = drilled to anchor to panel or median F = no drill, freestanding	Cabinets drilled for locks, keying instructions must accompany order.
N No Shelf	7. Finish Laminate, V1, V2 or V3 finish	See page 8 for finish options applicable.
E Extruded Aluminum Pull	8. Finish, Aluminum trim (trim M shelf option & pull) AA - Anodized aluminum or painted finish option from page 8 excluding silver	Product on this page will accept wood grain laminate where laminate is currently an option. When planning with medians and bridges (single station or clusters of stations) specify either 26.5" or 32.5" deep storage anchored cabinets for anchoring the median or bridge unit of the same depth. Connection method to medians, median storage or bridges incorporated into product design, no additional hardware required.
D Drilled to anchor		
V316 Finish, Maple		
AA Finish, trim & pull, anodized aluminum		

3rd digit in pattern number indicates storage configuration, see individual pattern groups above for description.

Cabinets

description	hand	h	w	d	pattern no.	L	V1	V2	V3
Storage anchored cabinet, Hinged Door front, open side	left	49"	19"	24"	ACDL4924 () () () ()	\$2,677.	\$3,957.	\$4,391.	\$5,708.
		49"	19"	30"	ACDL4930 () () () ()	2,883.	4,184.	4,694.	6,100.
		49"	19"	26.5"	ACDL4926 () () () ()	2,779.	4,069.	4,543.	5,902.
		49"	19"	32.5"	ACDL4932 () () () ()	2,986.	4,297.	4,841.	6,296.
	right	49"	19"	24"	ACDR4924 () () () ()	2,677.	3,957.	4,391.	5,708.
		49"	19"	30"	ACDR4930 () () () ()	2,883.	4,184.	4,694.	6,100.
		49"	19"	26.5"	ACDR4926 () () () ()	2,779.	4,069.	4,543.	5,902.
		49"	19"	32.5"	ACDR4932 () () () ()	2,986.	4,297.	4,841.	6,296.

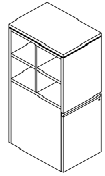

left hand shown, shelf aligns with worksurface at 28 1/4" h overall, or 27" h to underside

Order Code	Specification Information	Application Notes
Example: ACCL4924NEDV316AA	To order please specify pattern number including:	*Upcharge applicable as follows for ACC(L/R)49 units on this page: For option S upcharge for L/V1/V2 or V3 to correspond to shelf to match case; option M upcharge under AA or paint for aluminum metal shelf
A AutoStrada	1. Hand L = User's Left R = User's Right	When planning with panels, single station or cluster groups where all workstations within the group are the same direction/hand, then specify 26.5" or 32.5" deep storage anchor cabinet units. When planning multi-station clusters mirroring left hand/right hand or with stations back to back with panel run perpendicular to two cabinets, you then need to specify one 24" d with one 26.5" d or 30" d with one 32.5" d cabinet to go side by side or back to back as the case may be. Brackets to secure cabinets to panel are required, specified separately - see page 174.
C Cabinet	2. Height	24" and 30" deep storage anchored cabinets may be specified for freestanding applications, specify drill option F for freestanding, otherwise connection detail will be exposed.
C HD front, Open interior side	3. Depth 24 = 24" deep 30 = 30" deep 26 = 26.5" deep 32 = 32.5" deep	24" and 30" deep storage anchored cabinets may be specified for freestanding applications, specify drill option "F" for freestanding, otherwise connection detail will be exposed.
L Left Hand	4. Shelf option for open interior side 42" h do not have shelf options 49" h have shelf option 64" h do not have "no" shelf option, shelf included	Product on this page will accept wood grain laminate where laminate is currently an option.
49 49" high	N = No shelf S = Shelf to match case * M = Two piece extruded aluminum metal shelf assembly * (*upcharge applicable)	When planning with medians and bridges (single station or clusters of stations) specify either 26.5" or 32.5" deep storage anchored cabinets for anchoring the median or bridge unit of the same depth. Connection method to medians, median storage or bridges incorporated into product design, no additional hardware required.
24 24" deep	5. Pull E = extruded aluminum pull P = extruded aluminum protruding pull	Cabinets drilled for locks, keying instructions must accompany order.
N No Shelf	6. Drill option applicable only for 24" and 30" deep units D = drilled to anchor to panel or median F = no drill, freestanding	See page 8 for finish options applicable.
E Extruded Aluminum Pull	7. Finish Laminate, V1, V2 or V3 finish	
D Drilled to anchor	8. Finish, Aluminum trim (trim M shelf option & pull) AA - Anodized aluminum or painted finish option from page 8 excluding silver	
V316 Finish, Maple		
AA Finish, trim & pull, anodized aluminum		

3rd digit in pattern number indicates storage configuration, see individual pattern groups above for description.

description	h	w	d	pattern no.	L	V1	V2	V3
Storage anchored cabinet, wardrobe and BBF front, open interior side	42"	24"	24"	ACWJ(L/R)4224() () () ()	\$4,171.	\$6,182.	\$6,590.	\$8,570.
	42"	24"	30"	ACWJ(L/R)4230() () () ()	4,492.	6,536.	7,040.	9,164.
	42"	24"	26.5"	ACWJ(L/R)4226() () () ()	4,327.	6,361.	6,817.	8,868.
	42"	24"	32.5"	ACWJ(L/R)4232() () () ()	4,649.	6,714.	7,270.	9,454.
	49"	24"	24"	ACWJ(L/R)4924() () () () ()	4,244.	6,294.	6,713.	8,729.
	49"	24"	30"	ACWJ(L/R)4930() () () () ()	4,574.	6,657.	7,170.	9,331.
	49"	24"	26.5"	ACWJ(L/R)4926() () () () ()	4,408.	6,474.	6,944.	9,033.
	49"	24"	32.5"	ACWJ(L/R)4932() () () () ()	4,732.	6,838.	7,403.	9,629.
	64"	24"	24"	ACWJ(L/R)6424() () () () ()	4,324.	6,406.	6,905.	9,022.
	64"	24"	30"	ACWJ(L/R)6430() () () () ()	4,658.	6,773.	7,377.	9,647.
	64"	24"	26.5"	ACWJ(L/R)6426() () () () ()	4,492.	6,587.	7,143.	9,338.
	64"	24"	32.5"	ACWJ(L/R)6432() () () () ()	4,822.	6,955.	7,615.	9,953.

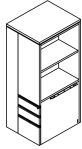

64" h left hand shown, shelf aligns with work surface at 28 1/4" overall, or 27" h to underside

Order Code	Specification Information	Application Notes
Example: ACWJL4924NEDWV316AA	To order please specify pattern number including:	*Upcharge applicable as follows
A AutoStrada	1. Hand L = User's Left R = User's Right	49" h and 64" h only: Option S upcharge for L/V1/V2 or V3 to correspond to shelf to match case
C Cabinet	2. Height	depth L V1
WJ Wardrobe/ BBF Front, Side Open	3. Depth 24 = 24" deep 26 = 26.5" deep 30 = 30" deep 32 = 32.5" deep	24" \$ 97 217 26.5" \$102 223 30" \$107 234 32.5" \$113 239
L Left Hand	4. Shelf option for open interior side	depth V2 V3
49 49" high	42" h do not have shelf options	24" \$240 310
24 24" deep	49" h have shelf option	26.5" \$248 321
N No Shelf	64" h do not have "no" shelf option, shelf included	30" \$260 338
E Extruded Aluminum Pull	N = No shelf	32.5" \$268 348
D Drilled to anchor	S = Shelf to match case *	49" and 64" h: Option M upcharge under AA or paint for aluminum metal shelf
W Wood interior	M = Two piece extruded aluminum metal shelf assembly * (*upcharge applicable)	depth AA or paint
V316 Finish, Maple	5. Pull E = extruded aluminum pull P = extruded aluminum protruding pull	24" \$296
AA Finish, trim & pull, anodized aluminum	6. Drill option, applicable only for 24" and 30" deep units D = drilled to anchor to panel or median F = no drill, freestanding	26.5" \$317
	7. Interior W = wood drawer interior M = metal drawer interior, deduct \$100 list	30" \$347
	8. Finish Laminate, V1, V2 or V3 finish	32.5" \$367
	9. Finish, Aluminum trim (trim, M shelf option & pull) AA - Anodized aluminum or painted finish option from page 8 excluding silver	Product on this page will accept wood grain laminate where laminate is currently an option.
		Specify either 26.5" or 32.5" deep storage anchored cabinets for anchoring median or bridge units of the same depth. Connection method to medians, median storage or bridges incorporated into product design, no additional hardware required.
		When planning with panels, single station or cluster groups where all workstations within the group are the same direction/hand, then specify 26.5" or 32.5" deep storage anchor cabinet units. When planning multi-station clusters mirroring left hand/right hand or with stations back to back with panel run perpendicular to two cabinets, you then need to specify one 24" d with one 26.5" d or 30" d with one 32.5" d cabinet to go side by side or back to back as the case may be. Brackets to secure cabinets to panel are required, specified separately - see page 174.
		24" and 30" deep storage anchored cabinets may be specified for freestanding applications, specify drill option F for freestanding, otherwise connection detail will be exposed.
		Cabinets include angle bracket to side support work surfaces except when drill option "F" for freestanding selected.
		Cabinets drilled for locks, keying instructions must accompany order.
		See page 8 for finish options applicable.

3rd and 4th digit in pattern number indicates storage configuration, see individual pattern groups above for description.

description	h	w	d	pattern no.	L	V1	V2	V3
Storage anchored cabinet, wardrobe and FF front, open interior side	42"	24"	24"	ACWK(L/R)4224() () () ()	\$3,704.	\$5,528.	\$5,983.	\$7,780.
	42"	24"	30"	ACWK(L/R)4230() () () ()	3,990.	5,849.	6,394.	8,315.
	42"	24"	26.5"	ACWK(L/R)4226() () () ()	3,847.	5,687.	6,188.	8,051.
	42"	24"	32.5"	ACWK(L/R)4232() () () ()	4,132.	6,005.	6,596.	8,580.
	49"	24"	24"	ACWK(L/R)4924() () () ()	3,780.	5,644.	6,106.	7,937.
	49"	24"	30"	ACWK(L/R)4930() () () ()	4,071.	5,967.	6,523.	8,483.
	49"	24"	26.5"	ACWK(L/R)4926() () () ()	3,925.	5,806.	6,314.	8,212.
	49"	24"	32.5"	ACWK(L/R)4932() () () ()	4,216.	6,128.	6,731.	8,757.
	64"	24"	24"	ACWK(L/R)6424() () () ()	3,860.	5,753.	6,296.	8,233.
	64"	24"	30"	ACWK(L/R)6430() () () ()	4,156.	6,083.	6,727.	8,799.
	64"	24"	26.5"	ACWK(L/R)6426() () () ()	4,007.	5,918.	6,512.	8,518.
	64"	24"	32.5"	ACWK(L/R)6432() () () ()	4,305.	6,246.	6,943.	9,080.

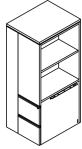

64" h left hand shown, shelf aligns with work surface at 28 1/8" overall, or 27" h to underside

Order Code	Specification Information	Application Notes
Example: ACWKL4924NEDWV316AA	To order please specify pattern number including:	*Upcharge applicable as follows
A AutoStrada	1. Hand L = User's Left R = User's Right	49" h and 64" h only: Option S upcharge for L/V1/V2 or V3 to correspond to shelf to match case
C Cabinet	2. Height	depth L V1
WK Wardrobe/FF front, side open	3. Depth 24 = 24" deep 26 = 26.5" deep 30 = 30" deep 32 = 32.5" deep	24" \$ 95 212 26.5" \$100 218 30" \$104 229 32.5" \$110 234
L Left Hand	4. Shelf option for open interior side 42" h do not have shelf options 49" h have shelf option 64" h do not have "no" shelf option, shelf included N = No shelf S = Shelf to match case * M = Two piece extruded aluminum metal shelf assembly * (*upcharge applicable)	depth V2 V3 24" \$235 303 26.5" \$243 314 30" \$254 331 32.5" \$262 341
49 49" high	5. Pull E = extruded aluminum pull P = extruded aluminum protruding pull	49" and 64" h: Option M upcharge under AA or paint for aluminum metal shelf
24 24" deep	6. Drill option, applicable only for 24" and 30" deep units D = drilled to anchor to panel or median F = no drill, freestanding	depth AA or paint 24" \$290 26.5" \$310 30" \$340 32.5" \$359
N No Shelf	7. Interior W = wood drawer interior M = metal drawer interior, deduct \$100 list	Specify either 26.5" or 32.5" deep storage anchored cabinets for anchoring median or bridge units of the same depth. Connection method to medians, median storage or bridges incorporated into product design, no additional hardware required.
E Extruded Aluminum Pull	8. Finish Laminate, V1, V2 or V3 finish	When planning with panels, single station or cluster groups where all workstations within the group are the same direction/hand, then specify 26.5" or 32.5" deep storage anchor cabinet units. When planning multi-station clusters mirroring left hand/right hand or with stations back to back with panel run perpendicular to two cabinets, you then need to specify one 24" d with one 26.5" d or 30" d with one 32.5" d cabinet to go side by side or back to back as the case may be. Brackets to secure cabinets to panel are required, specified separately - see page 174.
D Drilled to anchor	9. Finish, Aluminum trim (trim, M shelf option & pull) AA - Anodized aluminum or painted finish option from page 8 excluding silver	24" and 30" deep storage anchored cabinets may be specified for freestanding applications, specify drill option F for freestanding, otherwise connection detail will be exposed.
W Wood interior		Cabinets include angle bracket to side support work surfaces except when drill option "F" for freestanding selected.
V316 Finish, Maple		Cabinets drilled for locks, keying instructions must accompany order.
AA Finish, trim & pull, anodized aluminum		See page 8 for finish options applicable.

3rd and 4th digit in pattern number indicates storage configuration, see individual pattern groups above for description.

description	hand	h	w	d	pattern no.	L	V1	V2	V3
Storage anchored cabinet, FF lower front, open interior back	49"h left	49"	24"	19"	ACEL4924 () () () ()	\$2,920.	\$4,313.	\$4,700.	\$6,112.
		49"	30"	19"	ACEL4930 () () () ()	3,145.	4,559.	5,024.	6,530.
		49"	26.5"	19"	ACEL4926 () () () ()	3,033.	4,436.	4,863.	6,323.
		49"	32.5"	19"	ACEL4932 () () () ()	3,254.	4,684.	5,184.	6,740.
	49"h right	49"	24"	19"	ACER4924 () () () ()	2,920.	4,313.	4,700.	6,112.
		49"	30"	19"	ACER4930 () () () ()	3,145.	4,559.	5,024.	6,530.
		49"	26.5"	19"	ACER4926 () () () ()	3,033.	4,436.	4,863.	6,323.
		49"	32.5"	19"	ACER4932 () () () ()	3,254.	4,684.	5,184.	6,740.
	64"h left	64"	24"	19"	ACEL6424 () () () ()	3,212.	4,743.	5,172.	6,723.
		64"	30"	19"	ACEL6430 () () () ()	3,459.	5,014.	5,524.	7,184.
		64"	26.5"	19"	ACEL6426 () () () ()	3,334.	4,881.	5,349.	6,952.
		64"	32.5"	19"	ACEL6432 () () () ()	3,579.	5,150.	5,704.	7,417.
	64"h right	64"	24"	19"	ACER6424 () () () ()	3,212.	4,743.	5,172.	6,723.
		64"	30"	19"	ACER6430 () () () ()	3,459.	5,014.	5,524.	7,184.

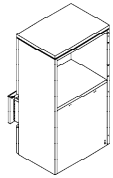

left hand shown, shelf aligns with worksurface at 28 1/4" h overall, or 27" h to underside

Order Code	Specification Information	Application Notes
Example: ACEL4924SEWV316AA	To order please specify pattern number including:	See page 8 for finish options applicable.
A AutoStrada	6. Drawer Interior applicable ACE(L/R) and ACI(L/R) only W = wood interior M = metal drawer interior, deduct \$100 list	Product on this page will accept wood grain laminate where laminate is currently an option.
C Cabinet	1. Hand L = User's Left R = User's Right	When planning with medians and bridges (single station or clusters of stations) specify 49"h cabinets in either 26.5" or 32.5" deep storage anchored cabinets for anchoring the median or bridge unit of the same depth.
E File/File lower front, Interior back open shelf	2. Height 49 = 49"h (for use with medians, bridges or panels, 49"h to below trim, 50.2"h overall) 64 = 64"h (for use with panels 64"h to below trim, 65.2"h overall)	When planning with panels, single station or cluster groups where all workstations within the group are the same direction/hand, then specify 26.5" or 32.5" deep storage anchor cabinet units. When planning multi-station clusters mirroring left hand/right hand or back to back stations with panel run perpendicular to two cabinets, you then need to specify one 24"d with one 26.5"d or 30"d with one 32.5" d cabinet to go side by side or back to back as the case may be.
L Left Hand	3. Depth 24 = 24" deep (use with 26.5" d unit for side by side cabinet application with panels) 30 = 30" deep (use with 32.5" d unit for side by side cabinet application with panels) 26 = 26.5" deep (use with medians, bridges & panels) 32 = 32.5" deep (use with medians, bridges & panels)	Cabinets with front and back access not to be used in freestanding applications.
49 49" high	4. Shelf option for open interior side 42"h do not have shelf options 49"h have shelf option 64"h do not have "no" shelf option, shelf included N = No shelf S = Shelf to match case * M = Two piece extruded aluminum metal shelf assembly * (*upcharge applicable)	Cabinet to panel attachment brackets required, see page 174.
24 24" deep	5. Pull E = extruded aluminum pull P = extruded aluminum protruding pull	Cabinets include angle bracket to side support worksurfaces. Cabinets drilled for locks, keying instructions must accompany order.
S w/shelf to match cabinet case	depth L V1 24" \$ 97 217 26.5" \$102 223 30" \$107 235 32.5" \$113 239 depth V2 V3 24" \$240 310 26.5" \$248 321 30" \$260 338 32.5" \$268 348 depth AA or paint 24" \$296 26.5" \$317 30" \$347 32.5" \$368	File drawers in cabinet styles prefixed ACIL and ACIR do not accommodate legal filing side to side.
E Extruded Aluminum Pull		
W Wood interior		
V316 Finish, Maple		
AA Finish, trim & pull, anodized aluminum		

3rd digit in pattern number indicates storage configuration, see individual pattern groups above for description.

description	hand	h	w	d	pattern no.	L	V1	V2	V3
Storage anchored cabinet, FF lower front, open interior back	64"h right	64"	26.5"	19"	ACER6426 (X)(X)(X)(X)	\$3,334.	\$4,881.	\$5,349.	\$6,952.
		64"	32.5"	19"	ACER6432 (X)(X)(X)(X)	3,579.	5,150.	5,704.	7,417.

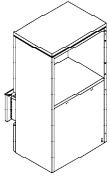

left hand shown, shelf aligns with work surface at 28 1/4" h overall, or 27" h to underside

Order Code	Specification Information	Application Notes																																													
Example: ACEL4924SEWV316AA	To order please specify pattern number including:	See page 8 for finish options applicable.																																													
A AutoStrada																																															
C Cabinet																																															
E File/File lower front, Interior back open shelf		Product on this page will accept wood grain laminate where laminate is currently an option.																																													
L Left Hand																																															
49 49" high																																															
24 24" deep																																															
S w/shelf to match cabinet case																																															
E Extruded Aluminum Pull																																															
W Wood interior																																															
V316 Finish, Maple																																															
AA Finish, trim & pull, anodized aluminum																																															
	<p>1. Hand L = User's Left R = User's Right</p> <p>2. Height 49 = 49" h (for use with medians, bridges or panels, 49" h to below trim, 50.2" h overall) 64 = 64" h (for use with panels 64" h to below trim, 65.2" h overall)</p> <p>3. Depth 24 = 24" deep (use with 26.5" d unit for side by side cabinet application with panels) 30 = 30" deep (use with 32.5" d unit for side by side cabinet application with panels) 26 = 26.5" deep (use with medians, bridges & panels) 32 = 32.5" deep (use with medians, bridges & panels)</p> <p>4. Shelf option for open interior side 42" h do not have shelf options 49" h have shelf option 64" h do not have "no" shelf option, shelf included N = No shelf S = Shelf to match case * M = Two piece extruded aluminum metal shelf assembly * (*upcharge applicable)</p> <p>5. Pull E = extruded aluminum pull P = extruded aluminum protruding pull</p> <p>6. Drawer Interior applicable ACE(L/R) and ACI(L/R) only W = wood interior M = metal drawer interior, deduct \$100 list</p> <p>7. Finish Laminate, V1, V2 or V3 finish</p> <p>8. Finish, Aluminum trim (trim, M shelf option & pull) AA - Anodized aluminum or painted finish option from page 8 excluding silver</p> <p>Connection method to medians, median storage or bridges incorporated into product design, no additional hardware required.</p> <p>64" h cabinets include shelf to match case in price list above. Upcharge below applicable as follows for 49" h shelf to match case for L/V1/V2/V3 or AA or paint for aluminum metal shelf for M option for both 49" h and 64" h cabinets.</p> <table border="1"> <tr> <td>depth</td> <td>L</td> <td>V1</td> </tr> <tr> <td>24"</td> <td>\$ 97</td> <td>217</td> </tr> <tr> <td>26.5"</td> <td>\$102</td> <td>223</td> </tr> <tr> <td>30"</td> <td>\$107</td> <td>235</td> </tr> <tr> <td>32.5"</td> <td>\$113</td> <td>239</td> </tr> <tr> <td>depth</td> <td>V2</td> <td>V3</td> </tr> <tr> <td>24"</td> <td>\$240</td> <td>310</td> </tr> <tr> <td>26.5"</td> <td>\$248</td> <td>321</td> </tr> <tr> <td>30"</td> <td>\$260</td> <td>338</td> </tr> <tr> <td>32.5"</td> <td>\$268</td> <td>348</td> </tr> <tr> <td>depth</td> <td>AA or paint</td> <td></td> </tr> <tr> <td>24"</td> <td>\$296</td> <td></td> </tr> <tr> <td>26.5"</td> <td>\$317</td> <td></td> </tr> <tr> <td>30"</td> <td>\$347</td> <td></td> </tr> <tr> <td>32.5"</td> <td>\$368</td> <td></td> </tr> </table>	depth	L	V1	24"	\$ 97	217	26.5"	\$102	223	30"	\$107	235	32.5"	\$113	239	depth	V2	V3	24"	\$240	310	26.5"	\$248	321	30"	\$260	338	32.5"	\$268	348	depth	AA or paint		24"	\$296		26.5"	\$317		30"	\$347		32.5"	\$368		<p>When planning with medians and bridges (single station or clusters of stations) specify 49" h cabinets in either 26.5" or 32.5" deep storage anchored cabinets for anchoring the median or bridge unit of the same depth.</p> <p>When planning with panels, single station or cluster groups where all workstations within the group are the same direction/hand, then specify 26.5" or 32.5" deep storage anchor cabinet units. When planning multi-station clusters mirroring left hand/right hand or back to back stations with panel run perpendicular to two cabinets, you then need to specify one 24" d with one 26.5" d or 30" d with one 32.5" d cabinet to go side by side or back to back as the case may be.</p> <p>Cabinets with front and back access not to be used in freestanding applications.</p> <p>Cabinet to panel attachment brackets required, see page 174.</p> <p>Cabinets include angle bracket to side support work surfaces. Cabinets drilled for locks, keying instructions must accompany order.</p> <p>File drawers in cabinet styles prefixed ACIL and ACIR do not accommodate legal filing side to side.</p>
depth	L	V1																																													
24"	\$ 97	217																																													
26.5"	\$102	223																																													
30"	\$107	235																																													
32.5"	\$113	239																																													
depth	V2	V3																																													
24"	\$240	310																																													
26.5"	\$248	321																																													
30"	\$260	338																																													
32.5"	\$268	348																																													
depth	AA or paint																																														
24"	\$296																																														
26.5"	\$317																																														
30"	\$347																																														
32.5"	\$368																																														

3rd digit in pattern number indicates storage configuration, see individual pattern groups above for description.

description	hand	h	w	d	pattern no.	L	V1	V2	V3
Storage anchored cabinet, HD lower front, open interior back	49" h right	49"	24"	19"	ACFR4924 () () ()	\$2,585.	\$3,743.	\$4,235.	\$5,507.
		49"	30"	19"	ACFR4930 () () ()	2,780.	3,954.	4,528.	5,883.
		49"	26.5"	19"	ACFR4926 () () ()	2,683.	3,849.	4,382.	5,696.
		49"	32.5"	19"	ACFR4932 () () ()	2,881.	4,064.	4,674.	6,073.
	64" h left	64"	24"	19"	ACFL6424 () () ()	2,843.	4,118.	4,658.	6,054.
		64"	30"	19"	ACFL6430 () () ()	3,061.	4,352.	4,976.	6,474.
		64"	26.5"	19"	ACFL6426 () () ()	2,950.	4,233.	4,819.	6,264.
		64"	32.5"	19"	ACFL6432 () () ()	3,168.	4,469.	5,140.	6,680.
	49" h left	49"	24"	19"	ACFL4924 () () ()	2,585.	3,743.	4,235.	5,507.
		49"	30"	19"	ACFL4930 () () ()	2,780.	3,954.	4,528.	5,883.
		49"	26.5"	19"	ACFL4926 () () ()	2,683.	3,849.	4,382.	5,696.
		49"	32.5"	19"	ACFL4932 () () ()	2,881.	4,064.	4,674.	6,073.
64" h right	64"	24"	19"	ACFR6424 () () ()	2,843.	4,118.	4,658.	6,054.	
	64"	30"	19"	ACFR6430 () () ()	3,061.	4,352.	4,976.	6,474.	

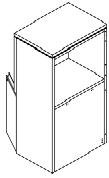

left hand shown, shelf aligns with worksurface at 28 1/4" h overall, or 27" h to underside

Order Code	Specification Information	Application Notes																																													
<p>Example: ACEL4924SEWV316AA</p> <p>A AutoStrada</p> <p>C Cabinet</p> <p>E File/File lower front, Interior back open shelf</p> <p>L Left Hand</p> <p>49 49" high</p> <p>24 24" deep</p> <p>S w/shelf to match cabinet case</p> <p>E Extruded Aluminum Pull</p> <p>W Wood interior</p> <p>V316 Finish, Maple</p> <p>AA Finish, trim & pull, anodized aluminum</p>	<p>To order please specify pattern number including:</p> <p>1. Hand L = User's Left R = User's Right</p> <p>2. Height 49 = 49" h (for use with medians, bridges or panels, 49" h to below trim, 50.2" h overall) 64 = 64" h (for use with panels 64" h to below trim, 65.2" h overall)</p> <p>3. Depth 24 = 24" deep (use with 26.5" d unit for side by side cabinet application with panels) 30 = 30" deep (use with 32.5" d unit for side by side cabinet application with panels) 26 = 26.5" deep (use with medians, bridges & panels) 32 = 32.5" deep (use with medians, bridges & panels)</p> <p>4. Shelf option for open interior side 42" h do not have shelf options 49" h have shelf option 64" h do not have "no" shelf option, shelf included N = No shelf S = Shelf to match case * M = Two piece extruded aluminum metal shelf assembly * (*upcharge applicable)</p> <p>5. Pull E = extruded aluminum pull P = extruded aluminum protruding pull</p> <p>6. Drawer Interior applicable ACE(L/R) and ACI(L/R) only W = wood interior M = metal drawer interior, deduct \$100 list</p> <p>7. Finish Laminate, V1, V2 or V3 finish</p> <p>8. Finish, Aluminum trim (trim, M shelf option & pull) AA - Anodized aluminum or painted finish option from page 8 excluding silver</p> <p>Connection method to medians, median storage or bridges incorporated into product design, no additional hardware required.</p> <p>64" h cabinets include shelf to match case in price list above. Upcharge below applicable as follows for 49" h shelf to match case for L/V1/V2/V3 or AA or paint for aluminum metal shelf for M option for both 49" h and 64" h cabinets.</p> <table border="1"> <tr> <td>depth</td> <td>L</td> <td>V1</td> </tr> <tr> <td>24"</td> <td>\$ 97</td> <td>217</td> </tr> <tr> <td>26.5"</td> <td>\$102</td> <td>223</td> </tr> <tr> <td>30"</td> <td>\$107</td> <td>235</td> </tr> <tr> <td>32.5"</td> <td>\$113</td> <td>239</td> </tr> <tr> <td>depth</td> <td>V2</td> <td>V3</td> </tr> <tr> <td>24"</td> <td>\$240</td> <td>310</td> </tr> <tr> <td>26.5"</td> <td>\$248</td> <td>321</td> </tr> <tr> <td>30"</td> <td>\$260</td> <td>338</td> </tr> <tr> <td>32.5"</td> <td>\$268</td> <td>348</td> </tr> <tr> <td>depth</td> <td>AA or paint</td> <td></td> </tr> <tr> <td>24"</td> <td>\$296</td> <td></td> </tr> <tr> <td>26.5"</td> <td>\$317</td> <td></td> </tr> <tr> <td>30"</td> <td>\$347</td> <td></td> </tr> <tr> <td>32.5"</td> <td>\$368</td> <td></td> </tr> </table>	depth	L	V1	24"	\$ 97	217	26.5"	\$102	223	30"	\$107	235	32.5"	\$113	239	depth	V2	V3	24"	\$240	310	26.5"	\$248	321	30"	\$260	338	32.5"	\$268	348	depth	AA or paint		24"	\$296		26.5"	\$317		30"	\$347		32.5"	\$368		<p>See page 8 for finish options applicable.</p> <p>Product on this page will accept wood grain laminate where laminate is currently an option.</p> <p>When planning with medians and bridges (single station or clusters of stations) specify 49" h cabinets in either 26.5" or 32.5" deep storage anchored cabinets for anchoring the median or bridge unit of the same depth.</p> <p>When planning with panels, single station or cluster groups where all workstations within the group are the same direction/hand, then specify 26.5" or 32.5" deep storage anchor cabinet units. When planning multi-station clusters mirroring left hand/right hand or back to back stations with panel run perpendicular to two cabinets, you then need to specify one 24" d with one 26.5" d or 30" d with one 32.5" d cabinet to go side by side or back to back as the case may be.</p> <p>Cabinets with front and back access not to be used in freestanding applications.</p> <p>Cabinet to panel attachment brackets required, see page 174.</p> <p>Cabinets include angle bracket to side support worksurfaces. Cabinets drilled for locks, keying instructions must accompany order.</p> <p>File drawers in cabinet styles prefixed ACIL and ACIR do not accommodate legal filing side to side.</p>
depth	L	V1																																													
24"	\$ 97	217																																													
26.5"	\$102	223																																													
30"	\$107	235																																													
32.5"	\$113	239																																													
depth	V2	V3																																													
24"	\$240	310																																													
26.5"	\$248	321																																													
30"	\$260	338																																													
32.5"	\$268	348																																													
depth	AA or paint																																														
24"	\$296																																														
26.5"	\$317																																														
30"	\$347																																														
32.5"	\$368																																														

3rd digit in pattern number indicates storage configuration, see individual pattern groups above for description.

description	hand	h	w	d	pattern no.	L	V1	V2	V3
Storage anchored cabinet, HD lower front, open interior back	64" h right	64"	26.5"	19"	ACFR6426 () () ()	\$2,950.	\$4,233.	\$4,819.	\$6,264.
		64"	32.5"	19"	ACFR6432 () () ()	3,168.	4,469.	5,140.	6,680.

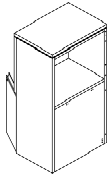

left hand shown, shelf aligns with worksurface at 28 1/4" h overall, or 27" h to underside

Order Code	Specification Information	Application Notes																																													
Example: ACEL4924SEWV316AA	To order please specify pattern number including:	See page 8 for finish options applicable.																																													
A AutoStrada																																															
C Cabinet																																															
E File/File lower front, Interior back open shelf		Product on this page will accept wood grain laminate where laminate is currently an option.																																													
L Left Hand																																															
49 49" high		When planning with medians and bridges (single station or clusters of stations) specify 49" h cabinets in either 26.5" or 32.5" deep storage anchored cabinets for anchoring the median or bridge unit of the same depth.																																													
24 24" deep																																															
S w/shelf to match cabinet case																																															
E Extruded Aluminum Pull																																															
W Wood interior		When planning with panels, single station or cluster groups where all workstations within the group are the same direction/hand, then specify 26.5" or 32.5" deep storage anchor cabinet units. When planning multi-station clusters mirroring left hand/right hand or back to back stations with panel run perpendicular to two cabinets, you then need to specify one 24" d with one 26.5" d or 30" d with one 32.5" d cabinet to go side by side or back to back as the case may be.																																													
V316 Finish, Maple																																															
AA Finish, trim & pull, anodized aluminum																																															
	<p>1. Hand L = User's Left R = User's Right</p> <p>2. Height 49 = 49" h (for use with medians, bridges or panels, 49" h to below trim, 50.2" h overall) 64 = 64" h (for use with panels 64" h to below trim, 65.2" h overall)</p> <p>3. Depth 24 = 24" deep (use with 26.5" d unit for side by side cabinet application with panels) 30 = 30" deep (use with 32.5" d unit for side by side cabinet application with panels) 26 = 26.5" deep (use with medians, bridges & panels) 32 = 32.5" deep (use with medians, bridges & panels)</p> <p>4. Shelf option for open interior side 42" h do not have shelf options 49" h have shelf option 64" h do not have "no" shelf option, shelf included N = No shelf S = Shelf to match case * M = Two piece extruded aluminum metal shelf assembly * (*upcharge applicable)</p> <p>5. Pull E = extruded aluminum pull P = extruded aluminum protruding pull</p> <p>6. Drawer Interior applicable ACE(L/R) and ACI(L/R) only W = wood interior M = metal drawer interior, deduct \$100 list</p> <p>7. Finish Laminate, V1, V2 or V3 finish</p> <p>8. Finish, Aluminum trim (trim, M shelf option & pull) AA - Anodized aluminum or painted finish option from page 8 excluding silver</p> <p>Connection method to medians, median storage or bridges incorporated into product design, no additional hardware required.</p> <p>64" h cabinets include shelf to match case in price list above. Upcharge below applicable as follows for 49" h shelf to match case for L/V1/V2/V3 or AA or paint for aluminum metal shelf for M option for both 49" h and 64" h cabinets.</p> <table border="1"> <tr> <td>depth</td> <td>L</td> <td>V1</td> </tr> <tr> <td>24"</td> <td>\$ 97</td> <td>217</td> </tr> <tr> <td>26.5"</td> <td>\$102</td> <td>223</td> </tr> <tr> <td>30"</td> <td>\$107</td> <td>235</td> </tr> <tr> <td>32.5"</td> <td>\$113</td> <td>239</td> </tr> <tr> <td>depth</td> <td>V2</td> <td>V3</td> </tr> <tr> <td>24"</td> <td>\$240</td> <td>310</td> </tr> <tr> <td>26.5"</td> <td>\$248</td> <td>321</td> </tr> <tr> <td>30"</td> <td>\$260</td> <td>338</td> </tr> <tr> <td>32.5"</td> <td>\$268</td> <td>348</td> </tr> <tr> <td>depth</td> <td>AA or paint</td> <td></td> </tr> <tr> <td>24"</td> <td>\$296</td> <td></td> </tr> <tr> <td>26.5"</td> <td>\$317</td> <td></td> </tr> <tr> <td>30"</td> <td>\$347</td> <td></td> </tr> <tr> <td>32.5"</td> <td>\$368</td> <td></td> </tr> </table>	depth	L	V1	24"	\$ 97	217	26.5"	\$102	223	30"	\$107	235	32.5"	\$113	239	depth	V2	V3	24"	\$240	310	26.5"	\$248	321	30"	\$260	338	32.5"	\$268	348	depth	AA or paint		24"	\$296		26.5"	\$317		30"	\$347		32.5"	\$368		<p>Cabinets with front and back access not to be used in freestanding applications.</p> <p>Cabinet to panel attachment brackets required, see page 174.</p> <p>Cabinets include angle bracket to side support worksurfaces. Cabinets drilled for locks, keying instructions must accompany order.</p> <p>File drawers in cabinet styles prefixed ACIL and ACIR do not accommodate legal filing side to side.</p>
depth	L	V1																																													
24"	\$ 97	217																																													
26.5"	\$102	223																																													
30"	\$107	235																																													
32.5"	\$113	239																																													
depth	V2	V3																																													
24"	\$240	310																																													
26.5"	\$248	321																																													
30"	\$260	338																																													
32.5"	\$268	348																																													
depth	AA or paint																																														
24"	\$296																																														
26.5"	\$317																																														
30"	\$347																																														
32.5"	\$368																																														

3rd digit in pattern number indicates storage configuration, see individual pattern groups above for description.

description	hand	h	w	d	pattern no.	L	V1	V2	V3
Storage anchored cabinet, 49"h Personal wardrobe and storage	left	49"	30"	19"	ACIL4930 ()() ()	\$4,153.	\$6,052.	\$6,583.	\$8,500.
		49"	32.5"	19"	ACIL4932 ()() ()	4,387.	6,320.	6,919.	8,945.
	right	49"	30"	19"	ACIR4930 ()() ()	4,153.	6,052.	6,583.	8,500.
		49"	32.5"	19"	ACIR4932 ()() ()	4,387.	6,320.	6,919.	8,945.

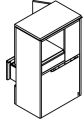

left hand shown, attach perpendicular to panel at back right side

Left hand = wardrobe on left front side
 Right hand = wardrobe on right front side
 wardrobe includes coat rod
 supports worksurface on back side at 28 1/4" overall or 27" h to underside of worksurface
 49" h I style cabinets do not have shelf above box drawer on back side access
 File drawers (front side) do not accommodate side to side legal filing

Order Code	Specification Information	Application Notes
Example: ACEL4924SEWV316AA	To order please specify pattern number including:	See page 8 for finish options applicable.
A AutoStrada	1. Hand L = User's Left R = User's Right	Product on this page will accept wood grain laminate where laminate is currently an option.
C Cabinet	2. Height 49 = 49" h (for use with medians, bridges or panels, 49" h to below trim, 50.2" h overall) 64 = 64" h (for use with panels 64" h to below trim, 65.2" h overall)	When planning with medians and bridges (single station or clusters of stations) specify 49" h cabinets in either 26.5" or 32.5" deep storage anchored cabinets for anchoring the median or bridge unit of the same depth.
E File/File lower front, Interior back open shelf	3. Depth 24 = 24" deep (use with 26.5" d unit for side by side cabinet application with panels) 30 = 30" deep (use with 32.5" d unit for side by side cabinet application with panels) 26 = 26.5" deep (use with medians, bridges & panels) 32 = 32.5" deep (use with medians, bridges & panels)	When planning with panels, single station or cluster groups where all workstations within the group are the same direction/hand, then specify 26.5" or 32.5" deep storage anchor cabinet units. When planning multi-station clusters mirroring left hand/right hand or back to back stations with panel run perpendicular to two cabinets, you then need to specify one 24" d with one 26.5" d or 30" d with one 32.5" d cabinet to go side by side or back to back as the case may be.
L Left Hand	4. Shelf option for open interior side 42" h do not have shelf options 49" h have shelf option 64" h do not have "no" shelf option, shelf included N = No shelf S = Shelf to match case * M = Two piece extruded aluminum metal shelf assembly * (*upcharge applicable)	Cabinets with front and back access not to be used in freestanding applications.
49 49" high	5. Pull E = extruded aluminum pull P = extruded aluminum protruding pull	Cabinet to panel attachment brackets required, see page 174.
24 24" deep		Cabinets include angle bracket to side support worksurfaces. Cabinets drilled for locks, keying instructions must accompany order.
S w/shelf to match cabinet case		File drawers in cabinet styles prefixed ACIL and ACIR do not accommodate legal filing side to side.
E Extruded Aluminum Pull		
W Wood interior		
V316 Finish, Maple		
AA Finish, trim & pull, anodized aluminum		
	6. Drawer Interior applicable ACE(L/R) and ACI(L/R) only W = wood interior M = metal drawer interior, deduct \$100 list	
	7. Finish Laminate, V1, V2 or V3 finish	
	8. Finish, Aluminum trim (trim, M shelf option & pull) AA - Anodized aluminum or painted finish option from page 8 excluding silver	
	Connection method to medians, median storage or bridges incorporated into product design, no additional hardware required.	
	64" h cabinets include shelf to match case in price list above. Upcharge below applicable as follows for 49" h shelf to match case for L/V1/V2/V3 or AA or paint for aluminum metal shelf for M option for both 49" h and 64" h cabinets.	
	depth L V1	
	24" \$ 97 217	
	26.5" \$102 223	
	30" \$107 235	
	32.5" \$113 239	
	depth V2 V3	
	24" \$240 310	
	26.5" \$248 321	
	30" \$260 338	
	32.5" \$268 348	
	depth AA or paint	
	24" \$296	
	26.5" \$317	
	30" \$347	
	32.5" \$368	

3rd digit in pattern number indicates storage configuration, see individual pattern groups above for description.

description	hand	h	w	d	pattern no.	L	V1	V2	V3
Storage anchored cabinet, 64"h Personal wardrobe and storage	left	64"	30"	19"	ACIL6430 () () () ()	\$4,169.	\$6,099.	\$6,686.	\$8,693.
		64"	32.5"	19"	ACIL6432 () () () ()	4,475.	6,439.	7,131.	9,267.
	right	64"	30"	19"	ACIR6430 () () () ()	4,169.	6,099.	6,686.	8,693.
		64"	32.5"	19"	ACIR6432 () () () ()	4,475.	6,439.	7,131.	9,267.

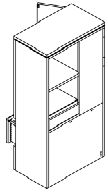

left hand shown, attach perpendicular to panel at back right side

Left hand = wardrobe on left front side
 Right hand = wardrobe on right front side
 supports worksurface on back side at 28 1/4" overall, 27"h to underside of worksurface
 wardrobe includes coat rod
 File drawers (front side) do not accommodate side to side legal filing

Order Code	Specification Information	Application Notes																																													
Example: ACEL4924SEWV316AA	To order please specify pattern number including:	See page 8 for finish options applicable.																																													
A AutoStrada																																															
C Cabinet																																															
E File/File lower front, Interior back open shelf		Product on this page will accept wood grain laminate where laminate is currently an option.																																													
L Left Hand																																															
49 49" high																																															
24 24" deep																																															
S w/shelf to match cabinet case																																															
E Extruded Aluminum Pull																																															
W Wood interior																																															
V316 Finish, Maple																																															
AA Finish, trim & pull, anodized aluminum																																															
3rd digit in pattern number indicates storage configuration, see individual pattern groups above for description.	<p>1. Hand L = User's Left R = User's Right</p> <p>2. Height 49 = 49"h (for use with medians, bridges or panels, 49"h to below trim, 50.2"h overall) 64 = 64"h (for use with panels 64"h to below trim, 65.2"h overall)</p> <p>3. Depth 24 = 24" deep (use with 26.5"d unit for side by side cabinet application with panels) 30 = 30" deep (use with 32.5"d unit for side by side cabinet application with panels) 26 = 26.5" deep (use with medians, bridges & panels) 32 = 32.5" deep (use with medians, bridges & panels)</p> <p>4. Shelf option for open interior side 42"h do not have shelf options 49"h have shelf option 64"h do not have "no" shelf option, shelf included N = No shelf S = Shelf to match case * M = Two piece extruded aluminum metal shelf assembly * (*upcharge applicable)</p> <p>5. Pull E = extruded aluminum pull P = extruded aluminum protruding pull</p> <p>6. Drawer Interior applicable ACE(L/R) and ACI(L/R) only W = wood interior M = metal drawer interior, deduct \$100 list</p> <p>7. Finish Laminate, V1, V2 or V3 finish</p> <p>8. Finish, Aluminum trim (trim, M shelf option & pull) AA - Anodized aluminum or painted finish option from page 8 excluding silver</p> <p>Connection method to medians, median storage or bridges incorporated into product design, no additional hardware required.</p> <p>64"h cabinets include shelf to match case in price list above. Upcharge below applicable as follows for 49"h shelf to match case for L/V1/V2/V3 or AA or paint for aluminum metal shelf for M option for both 49"h and 64"h cabinets.</p> <table border="1"> <tr> <td>depth</td> <td>L</td> <td>V1</td> </tr> <tr> <td>24"</td> <td>\$ 97</td> <td>217</td> </tr> <tr> <td>26.5"</td> <td>\$102</td> <td>223</td> </tr> <tr> <td>30"</td> <td>\$107</td> <td>235</td> </tr> <tr> <td>32.5"</td> <td>\$113</td> <td>239</td> </tr> <tr> <td>depth</td> <td>V2</td> <td>V3</td> </tr> <tr> <td>24"</td> <td>\$240</td> <td>310</td> </tr> <tr> <td>26.5"</td> <td>\$248</td> <td>321</td> </tr> <tr> <td>30"</td> <td>\$260</td> <td>338</td> </tr> <tr> <td>32.5"</td> <td>\$268</td> <td>348</td> </tr> <tr> <td>depth</td> <td>AA or paint</td> <td></td> </tr> <tr> <td>24"</td> <td>\$296</td> <td></td> </tr> <tr> <td>26.5"</td> <td>\$317</td> <td></td> </tr> <tr> <td>30"</td> <td>\$347</td> <td></td> </tr> <tr> <td>32.5"</td> <td>\$368</td> <td></td> </tr> </table>	depth	L	V1	24"	\$ 97	217	26.5"	\$102	223	30"	\$107	235	32.5"	\$113	239	depth	V2	V3	24"	\$240	310	26.5"	\$248	321	30"	\$260	338	32.5"	\$268	348	depth	AA or paint		24"	\$296		26.5"	\$317		30"	\$347		32.5"	\$368		<p>When planning with medians and bridges (single station or clusters of stations) specify 49"h cabinets in either 26.5" or 32.5" deep storage anchored cabinets for anchoring the median or bridge unit of the same depth.</p> <p>When planning with panels, single station or cluster groups where all workstations within the group are the same direction/hand, then specify 26.5" or 32.5" deep storage anchor cabinet units. When planning multi-station clusters mirroring left hand/right hand or back to back stations with panel run perpendicular to two cabinets, you then need to specify one 24"d with one 26.5"d or 30"d with one 32.5" d cabinet to go side by side or back to back as the case may be.</p> <p>Cabinets with front and back access not to be used in freestanding applications.</p> <p>Cabinet to panel attachment brackets required, see page 174.</p> <p>Cabinets include angle bracket to side support worksurfaces. Cabinets drilled for locks, keying instructions must accompany order.</p> <p>File drawers in cabinet styles prefixed ACIL and ACIR do not accommodate legal filing side to side.</p>
depth	L	V1																																													
24"	\$ 97	217																																													
26.5"	\$102	223																																													
30"	\$107	235																																													
32.5"	\$113	239																																													
depth	V2	V3																																													
24"	\$240	310																																													
26.5"	\$248	321																																													
30"	\$260	338																																													
32.5"	\$268	348																																													
depth	AA or paint																																														
24"	\$296																																														
26.5"	\$317																																														
30"	\$347																																														
32.5"	\$368																																														

description	hand	h	w	d	pattern no.	L	V1	V2	V3
Storage anchored cabinet, FFF and HD above (49"h)	left	49"	24"	19"	ACGL4924 () () () ()	\$3,312.	\$4,604.	\$5,185.	\$6,744.
		49"	30"	19"	ACGL4930 () () () ()	3,425.	4,740.	5,456.	7,090.
		49"	26.5"	19"	ACGL4926 () () () ()	3,369.	4,672.	5,322.	6,918.
		49"	32.5"	19"	ACGL4932 () () () ()	3,482.	4,807.	5,587.	7,264.
	right	49"	24"	19"	ACGR4924 () () () ()	3,312.	4,604.	5,185.	6,744.
		49"	30"	19"	ACGR4930 () () () ()	3,425.	4,740.	5,456.	7,090.
		49"	26.5"	19"	ACGR4926 () () () ()	3,369.	4,672.	5,322.	6,918.
		49"	32.5"	19"	ACGR4932 () () () ()	3,482.	4,807.	5,587.	7,264.

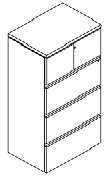

inside clearance behind hinged doors approx 9 1/4" h

Storage anchored cabinet, FFF and HD above (64"h)	left	64"	24"	19"	ACGL6424 () () () ()	3,476.	4,833.	5,448.	7,082.
		64"	30"	19"	ACGL6430 () () () ()	3,597.	4,976.	5,728.	7,444.
		64"	26.5"	19"	ACGL6426 () () () ()	3,537.	4,905.	5,587.	7,264.
		64"	32.5"	19"	ACGL6432 () () () ()	3,656.	5,046.	5,869.	7,625.
	right	64"	24"	19"	ACGR6424 () () () ()	3,476.	4,833.	5,448.	7,082.
		64"	30"	19"	ACGR6430 () () () ()	3,597.	4,976.	5,728.	7,444.
		64"	26.5"	19"	ACGR6426 () () () ()	3,537.	4,905.	5,587.	7,264.
		64"	32.5"	19"	ACGR6432 () () () ()	3,656.	5,046.	5,869.	7,625.

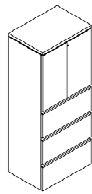

64" h includes adjustable shelf behind hinged doors, doors must be removed to adjust shelf

Order Code	Specification Information	Application Notes
Example: ACGL4924EDWV316AA	To order please specify pattern number including:	<p>Products listed on this page are for use with panel based stations or freestanding applications. Not to be used with median based storage anchored planning model.</p> <p>Product on this page will accept wood grain laminate where laminate is currently an option.</p> <p>When planning with panels, single station or cluster groups where all workstations within the group are the same direction/hand, then specify 26.5" or 32.5" deep storage anchor cabinet units. When planning multi-station clusters mirroring left hand/right hand with stations back to back with panel run perpendicular to two cabinets you then need to specify one 24" d with one 26.5" d or 30" d with one 32.5" d cabinet to go side by side or back to back as the case may be.</p> <p>Cabinet to panel attachment brackets required, see page 174</p>
A AutoStrada	1. Hand (applicable for personal wardrobe & storage units only) L = wardrobe on left R = wardrobe on right	
C Cabinet	2. Height 49 = 49" h (where applicable). 49" h to below trim, 50.2" h overall) 64 = 64" h (64" h to below trim, 65.2" h overall)	
G File drawers w/Hinged doors above	3. Depth 24 = 24" deep (use with one 26.5" d for side by side or freestanding) 30 = 30" deep (use with one 32.5" d for side by side or freestanding) 26 = 26.5" deep (use with panels) 32 = 32.5" deep (use with panels)	
L Left Hand	4. Pull (where applicable) E = Extruded aluminum pull P = Extruded aluminum protruding pull	
49 49" high	5. Drill option, applicable only for 24" and 30" deep units D = drilled to anchor to panel F = no drill, freestanding	
24 24" deep	6. Interior option W = wood drawer interior M = metal drawer interior, deduct \$200 list	
E Extruded Aluminum Pull	7. Finish Laminate, V1, V2 or V3 finish	
D Drilled to anchor	8. Finish, Metal Shelves (if applicable) (paint finish or anodized aluminum two piece assembly)	
W Wood interior	9. Finish, Aluminum trim (trim & pull) AA - Anodized aluminum or painted finish option from page 8 excluding silver	
V316 Finish, Maple	Hinged doors above feature touch latches and do not lock.	
AA Finish, trim & pull, anodized aluminum	File drawers are drilled for locks, keying instructions must accompany order.	
	Cabinets include angle brackets to side support worksurfaces perpendicular to cabinet except when drill option "F" for freestanding selected.	

3rd digit in pattern number indicates storage configuration, see individual pattern groups above for description.

description	hand	h	w	d	pattern no.	L	V1	V2	V3
Storage anchored cabinet, 49"h bookcase w/metal shelves	left	49"	24"	19"	ACHL4924M () () ()	\$2,065.	\$2,816.	\$3,238.	\$3,890.
		49"	30"	19"	ACHL4930M () () ()	2,236.	3,045.	3,503.	4,207.
		49"	26.5"	19"	ACHL4926M () () ()	2,152.	2,931.	3,373.	4,046.
		49"	32.5"	19"	ACHL4932M () () ()	2,319.	3,161.	3,635.	4,365.
	right	49"	24"	19"	ACHR4924M () () ()	2,065.	2,816.	3,238.	3,890.
		49"	30"	19"	ACHR4930M () () ()	2,236.	3,045.	3,503.	4,207.
		49"	26.5"	19"	ACHR4926M () () ()	2,152.	2,931.	3,373.	4,046.
		49"	32.5"	19"	ACHR4932M () () ()	2,319.	3,161.	3,635.	4,365.

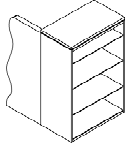

left hand shown

Storage anchored cabinet, 64"h bookcase w/metal shelves	left	64"	24"	19"	ACHL6424M () () ()	2,172.	2,961.	3,402.	4,081.
		64"	30"	19"	ACHL6430M () () ()	2,348.	3,197.	3,678.	4,414.
		64"	26.5"	19"	ACHL6426M () () ()	2,260.	3,077.	3,539.	4,246.
		64"	32.5"	19"	ACHL6432M () () ()	2,437.	3,319.	3,818.	4,581.
	right	64"	24"	19"	ACHR6424M () () ()	2,172.	2,961.	3,402.	4,081.
		64"	30"	19"	ACHR6430M () () ()	2,348.	3,197.	3,678.	4,414.
		64"	26.5"	19"	ACHR6426M () () ()	2,260.	3,077.	3,539.	4,246.
		64"	32.5"	19"	ACHR6432M () () ()	2,437.	3,319.	3,818.	4,581.

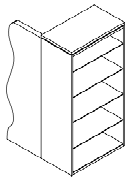

left hand shown

Order Code	Specification Information	Application Notes
Example: ACGL4924EDWV316AA	To order please specify pattern number including:	<p>Products listed on this page are for use with panel based stations or freestanding applications. Not to be used with median based storage anchored planning model.</p> <p>Product on this page will accept wood grain laminate where laminate is currently an option.</p> <p>When planning with panels, single station or cluster groups where all workstations within the group are the same direction/hand, then specify 26.5" or 32.5" deep storage anchor cabinet units. When planning multi-station clusters mirroring left hand/right hand with stations back to back with panel run perpendicular to two cabinets you then need to specify one 24" d with one 26.5" d or 30" d with one 32.5" d cabinet to go side by side or back to back as the case may be.</p> <p>Cabinet to panel attachment brackets required, see page 174</p>
A AutoStrada	1. Hand (applicable for personal wardrobe & storage units only) L = wardrobe on left R = wardrobe on right	
C Cabinet	2. Height 49 = 49" h (where applicable, 49" h to below trim, 50.2" h overall) 64 = 64" h (64" h to below trim, 65.2" h overall)	
G File drawers w/Hinged doors above	3. Depth 24 = 24" deep (use with one 26.5" d for side by side or freestanding) 30 = 30" deep (use with one 32.5" d for side by side or freestanding) 26 = 26.5" deep (use with panels) 32 = 32.5" deep (use with panels)	
L Left Hand	4. Pull (where applicable) E = Extruded aluminum pull P = Extruded aluminum protruding pull	
49 49" high	5. Drill option, applicable only for 24" and 30" deep units D = drilled to anchor to panel F = no drill, freestanding	
24 24" deep	6. Interior option W = wood drawer interior M = metal drawer interior, deduct \$200 list	
E Extruded Aluminum Pull	7. Finish Laminate, V1, V2 or V3 finish	
D Drilled to anchor	8. Finish, Metal Shelves (if applicable) (paint finish or anodized aluminum two piece assembly)	
W Wood interior	9. Finish, Aluminum trim (trim & pull) AA - Anodized aluminum or painted finish option from page 8 excluding silver	
V316 Finish, Maple	Hinged doors above feature touch latches and do not lock.	
AA Finish, trim & pull, anodized aluminum	File drawers are drilled for locks, keying instructions must accompany order.	
	Cabinets include angle brackets to side support worksurfaces perpendicular to cabinet except when drill option "F" for freestanding selected.	

3rd digit in pattern number indicates storage configuration, see individual pattern groups above for description.

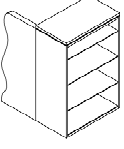
description	hand	h	w	d	pattern no.	L	V1	V2	V3
Storage anchored cabinet, 49" h bookcase w/shelves  left hand shown	left	49"	24"	19"	ACHL4924W () ()	\$2,463.	\$3,530.	\$4,019.	\$5,226.
		49"	30"	19"	ACHL4930W () ()	2,566.	3,677.	4,185.	5,439.
		49"	26.5"	19"	ACHL4926W () ()	2,507.	3,596.	4,090.	5,320.
		49"	32.5"	19"	ACHL4932W () ()	2,603.	3,734.	4,245.	5,521.
	right	49"	24"	19"	ACHR4924W () ()	2,463.	3,530.	4,019.	5,226.
		49"	30"	19"	ACHR4930W () ()	2,566.	3,677.	4,185.	5,439.
		49"	26.5"	19"	ACHR4926W () ()	2,507.	3,596.	4,090.	5,320.
		49"	32.5"	19"	ACHR4932W () ()	2,603.	3,734.	4,245.	5,521.

shelves same as case finish

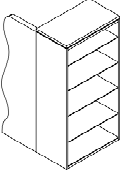
description	hand	h	w	d	pattern no.	L	V1	V2	V3
Storage anchored cabinet, 64" h bookcase w/shelves  left hand shown	left	64"	24"	19"	ACHL6424W () ()	2,718.	3,896.	4,435.	5,764.
		64"	30"	19"	ACHL6430W () ()	2,838.	4,071.	4,629.	6,023.
		64"	26.5"	19"	ACHL6426W () ()	2,768.	3,973.	4,521.	5,874.
		64"	32.5"	19"	ACHL6432W () ()	2,886.	4,140.	4,713.	6,124.
	right	64"	24"	19"	ACHR6424W () ()	2,718.	3,896.	4,435.	5,764.
		64"	30"	19"	ACHR6430W () ()	2,838.	4,071.	4,629.	6,023.
		64"	26.5"	19"	ACHR6426W () ()	2,768.	3,973.	4,521.	5,874.
		64"	32.5"	19"	ACHR6432W () ()	2,886.	4,140.	4,713.	6,124.

shelves same as case finish

Order Code	Specification Information	Application Notes
Example: ACGL4924EDWV316AA	<i>To order please specify pattern number including:</i>	<p>Products listed on this page are for use with panel based stations or freestanding applications. Not to be used with median based storage anchored planning model.</p> <p>Product on this page will accept wood grain laminate where laminate is currently an option.</p> <p>When planning with panels, single station or cluster groups where all workstations within the group are the same direction/hand, then specify 26.5" or 32.5" deep storage anchor cabinet units. When planning multi-station clusters mirroring left hand/right hand with stations back to back with panel run perpendicular to two cabinets you then need to specify one 24" d with one 26.5" d or 30" d with one 32.5" d cabinet to go side by side or back to back as the case may be.</p> <p>Cabinet to panel attachment brackets required, see page 174</p>
A AutoStrada	1. Hand <i>(applicable for personal wardrobe & storage units only)</i> L = wardrobe on left R = wardrobe on right	
C Cabinet	2. Height 49 = 49" h (where applicable, 49" h to below trim, 50.2" h overall) 64 = 64" h (64" h to below trim, 65.2" h overall)	
G File drawers w/Hinged doors above	3. Depth 24 = 24" deep (use with one 26.5" d for side by side or freestanding) 30 = 30" deep (use with one 32.5" d for side by side or freestanding) 26 = 26.5" deep (use with panels) 32 = 32.5" deep (use with panels)	
L Left Hand	4. Pull (where applicable) E = Extruded aluminum pull P = Extruded aluminum protruding pull	
49 49" high	5. Drill option, applicable only for 24" and 30" deep units D = drilled to anchor to panel F = no drill, freestanding	
24 24" deep	6. Interior option W = wood drawer interior M = metal drawer interior, deduct \$200 list	
E Extruded Aluminum Pull	7. Finish Laminate, V1, V2 or V3 finish	
D Drilled to anchor	8. Finish, Metal Shelves (if applicable) <i>(paint finish or anodized aluminum two piece assembly)</i>	
W Wood interior	9. Finish, Aluminum trim (trim & pull) AA - Anodized aluminum or painted finish option from page 8 excluding silver	
V316 Finish, Maple	Hinged doors above feature touch latches and do not lock.	
AA Finish, trim & pull, anodized aluminum	File drawers are drilled for locks, keying instructions must accompany order. Cabinets include angle brackets to side support worksurfaces perpendicular to cabinet except when drill option "F" for freestanding selected.	

3rd digit in pattern number indicates storage configuration, see individual pattern groups above for description.

description	type	pattern no.	49" h	64" h	list
-------------	------	-------------	-------	-------	------

Bracket kit, cabinet to panel attachment
top and bottom connection for single cabinet
attachment to panel run

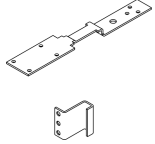

kit includes hookstrip connector (not shown)

Bracket kit, cabinet to panel attachment
top and bottom connection for use with two
cabinets side by side or back to back attached
perpendicular to panel run

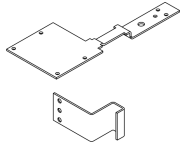

Left hand shown, (kit includes hookstrip
connector not shown)

left	A3CPBDL () ()	230.	241.
right	A3CPBDR () ()	230.	241.

Note - one of the two cabinets should be 2.5" wider or deeper (width or depth dimension depending on style of cabinet) than the other

Order Code	Specification Information	Application Notes
Example: A3CPBS4 ()	<i>To order please specify pattern number including:</i>	Bracket kits for use when attaching storage anchored cabinets to panels; kit includes top and bottom bracket as shown and ships with hookstrip connector. Please be sure to specify height to correspond with cabinet and panel height. When one cabinet perpendicular to panel run, use S bracket; when two cabinets are side by side and perpendicular to panel run, use D bracket.
A3 AutoStrada, generation3	1. Hand (if applicable) <i>L = left hand attachment</i> <i>R = right hand attachment</i>	
CPB Cabinet to Panel bracket	2. Hookstrip connector height <i>2 = for 42" h cabinet to panel connection</i> <i>4 = for 49" h cabinet to panel connection</i> <i>6 = for 64" h cabinet to panel connection</i>	Brackets are NOT to be used with Reff stacking modules. Only use for cabinet to panel attachment (panel and cabinet at same height) or with cabinet to panel plus window modules (overall at same height). Painted finish 613 used when AA trim finish specified.
S Single	3. Finish <i>Painted finish options only from page 8</i>	
4 With 49" h hookstrip connector		
() Finish		

description	type	d	pattern no.	list
Worksurface to cabinet trim		24"	AWTCT24 ()	\$103.
		30"	AWTCT30 ()	116.
Slatwall end trim, use w/SA "D" cabinets	2 pc trim kit		ATSCD19 ()	136.

Note: for use with ACD style storage anchored cabinets when slatwall adjacent to cabinet

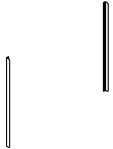

Order Code

Example:	AWTCT24AA
A	AutoStrada
W	Worksurface
TC	to Cabinet
T	Trim
24	24" d worksurface
AA	Finish, anodized aluminum

Specification Information

To order please specify pattern number including:

1. Depth of worksurface
 24 = 24" d worksurface
 30 = 30" d worksurface
2. Finish
 AA = anodized aluminum or painted finish option from page 8 excluding silver

Application Notes

Aluminum spacer optional to fill 1/8" gap at worksurface and storage anchored cabinet connection in AS-2 storage anchored panel based planning. Trim piece installed at worksurface level and rests on side support bracket to cabinet.

description	type	h	w	d	pattern no.	L	V1	V2	V3
File drawers (2) with open wood shelves above		70"	30"	24"	ACJ722WE () ()	\$3,481.	\$4,806.	\$5,585.	\$7,259.
		70"	36"	24"	ACJ723WE () ()	3,584.	4,949.	5,751.	7,476.

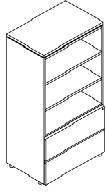

File drawers (3) with open wood shelves above		84"	30"	24"	ACJ822WE () ()	4,073.	5,620.	6,532.	8,494.
		84"	36"	24"	ACJ823WE () ()	4,195.	5,789.	6,728.	8,748.

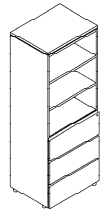

Order Code	Specification Information	Application Notes
Example: ACKL722WEV316AAAA	<i>To order please specify pattern number including:</i>	
A AutoStrada	1. Hand <i>(applicable for units with wardrobes only)</i> <i>L = wardrobe on left</i> <i>R = wardrobe on right</i>	
C Cabinet	2. Height <i>7 = 70" h</i> <i>8 = 84" h</i>	
K Wardrobe/Open bookcase	3. Width <i>2 = 30" wide</i> <i>3 = 36" wide</i>	
L Left Hand	4. Interior & shelf <i>W = wood drawer interior and wood shelves</i> <i>M = wood drawer interior and metal shelves</i>	
7 70" high	5. Extruded aluminum pull <i>E = extruded aluminum pull (default)</i>	
2 24" deep	6. Finish <i>Laminate, V1, V2 or V3 finish</i>	
2 30" wide	7. Finish, Metal Shelves <i>(if applicable)</i> <i>(paint finish or anodized aluminum three piece assembly)</i>	
W Wood interior	8. Finish, Aluminum trim (trim & if pull) <i>AA - Anodized aluminum or painted finish option from page 8 excluding silver</i>	
E Extruded Aluminum Pull	9. Finish, cabinet feet <i>AA - Anodized aluminum or painted finish option from page 8 excluding silver</i>	
V316 Finish, Maple		
AA Finish, trim & pull, anodized aluminum		
AA Finish, cabinet feet, anodized alum		

Cabinets on this page are styled for the private office and include aluminum feet detail which is optional addition to lower storage beginning on page 186. Specify 70" h cabinets for use with single high overhead storage and 84" h cabinets for use with double high overhead storage.

Hinged doors feature touch latches and do not lock. Sliding doors do not lock. File drawers dilled for locks, keying instructions must accompany order.

Coat rod included in wardrobes.

See page 8 for finish options applicable.

Product on this page will accept wood grain laminate where laminate is currently an option.

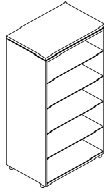
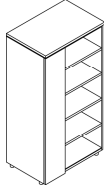
description	type	h	w	d	pattern no.	L	V1	V2	V3	
 <p>Open bookcase</p>	metal shelves	70"	30"	24"	ACL722M () () ()	\$2,989.	\$4,047.	\$4,250.	\$5,523.	
		70"	36"	24"	ACL723M () () ()	3,161.	4,260.	4,473.	5,818.	
		84"	30"	24"	ACL822M () () ()	3,329.	4,474.	4,698.	6,109.	
		84"	36"	24"	ACL823M () () ()	3,498.	4,689.	4,925.	6,402.	
	wood shelves	70"	30"	24"	ACL722W () () ()	2,393.	3,259.	3,750.	4,872.	
		70"	36"	24"	ACL723W () () ()	2,528.	3,428.	3,974.	5,164.	
		84"	30"	24"	ACL822W () () ()	2,663.	3,599.	4,197.	5,457.	
		84"	36"	24"	ACL823W () () ()	2,801.	3,770.	4,419.	5,746.	
 <p>Wardrobe with hinged door open bookcase w/wood shelves</p>	left hand	70"	30"	24"	ACKL722WE () () ()	3,236.	4,642.	5,188.	6,745.	
		70"	36"	24"	ACKL723WE () () ()	3,397.	4,873.	5,448.	7,082.	
		84"	30"	24"	ACKL822WE () () ()	3,397.	4,873.	5,448.	7,082.	
		84"	36"	24"	ACKL823WE () () ()	3,514.	5,041.	5,636.	7,325.	
	<i>left hand = wardrobe on left side facing cabinet (1/3rd of width)</i>									
	right hand	70"	30"	24"	ACKR722WE () () ()	3,236.	4,642.	5,188.	6,745.	
		70"	36"	24"	ACKR723WE () () ()	3,397.	4,873.	5,448.	7,082.	
		84"	30"	24"	ACKR822WE () () ()	3,397.	4,873.	5,448.	7,082.	
84"		36"	24"	ACKR823WE () () ()	3,514.	5,041.	5,636.	7,325.		
<i>right hand = wardrobe on right side facing cabinet (1/3rd of width)</i>										

left hand shown

Order Code	Specification Information	Application Notes
Example: ACKL722WEV316AAAA	To order please specify pattern number including:	
A AutoStrada	1. Hand (applicable for units with wardrobes only) <i>L = wardrobe on left</i> <i>R = wardrobe on right</i>	
C Cabinet	2. Height <i>7 = 70" h</i> <i>2 = 24" deep</i> <i>2 = 30" wide</i>	
K Wardrobe/Open bookcase	3. Width <i>2 = 30" wide</i> <i>3 = 36" wide</i>	
L Left Hand	4. Interior & shelf <i>W = wood drawer interior and wood shelves</i> <i>M = wood drawer interior and metal shelves</i>	
7 70" high	5. Extruded aluminum pull <i>E = extruded aluminum pull (default)</i>	
2 24" deep	6. Finish <i>Laminate, V1, V2 or V3 finish</i>	
2 30" wide	7. Finish, Metal Shelves (if applicable) (paint finish or anodized aluminum three piece assembly)	Cabinets on this page are styled for the private office and include aluminum feet detail which is optional addition to lower storage beginning on page 186. Specify 70" h cabinets for use with single high overhead storage and 84" h cabinets for use with double high overhead storage.
W Wood interior	8. Finish, Aluminum trim (trim & if pull) <i>AA - Anodized aluminum or painted finish option from page 8 excluding silver</i>	Hinged doors feature touch latches and do not lock. Sliding doors do not lock. File drawers drilled for locks, keying instructions must accompany order.
E Extruded Aluminum Pull	9. Finish, cabinet feet <i>AA - Anodized aluminum or painted finish option from page 8 excluding silver</i>	Coat rod included in wardrobes.
V316 Finish, Maple	See page 8 for finish options applicable.	
AA Finish, trim & pull, anodized aluminum	Product on this page will accept wood grain laminate where laminate is currently an option.	
AA Finish, cabinet feet, anodized alum		

description	type	h	w	d	pattern no.	L	V1	V2	V3
Wardrobe w/sliding door open bookcase w/wood shelves	left hand	70"	30"	24"	ACMWL722 () () ()	\$3,437.	\$4,685.	\$5,390.	\$7,006.
		70"	36"	24"	ACMWL723 () () ()	3,609.	4,918.	5,659.	7,358.
		84"	30"	24"	ACMWL822 () () ()	3,717.	5,041.	5,845.	7,598.
		84"	36"	24"	ACMWL823 () () ()	3,894.	5,263.	6,136.	7,977.
	right hand	70"	30"	24"	ACMWR722 () () ()	3,437.	4,685.	5,390.	7,006.
		70"	36"	24"	ACMWR723 () () ()	3,609.	4,918.	5,659.	7,358.
		84"	30"	24"	ACMWR822 () () ()	3,717.	5,041.	5,845.	7,598.
		84"	36"	24"	ACMWR823 () () ()	3,894.	5,263.	6,136.	7,977.

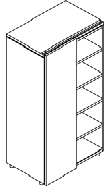

left hand shown

Wardrobe w/sliding door open bookcase w/metal shelves	left hand	70"	30"	24"	ACMML722 () () ()	3,666.	4,936.	5,640.	7,258.
		70"	36"	24"	ACMML723 () () ()	3,866.	5,200.	5,940.	7,640.
		84"	30"	24"	ACMML822 () () ()	4,003.	5,354.	6,159.	7,911.
		84"	36"	24"	ACMML823 () () ()	4,209.	5,609.	6,481.	8,322.
	right hand	70"	30"	24"	ACMMR722 () () ()	3,666.	4,936.	5,640.	7,258.
		70"	36"	24"	ACMMR723 () () ()	3,866.	5,200.	5,940.	7,640.
		84"	30"	24"	ACMMR822 () () ()	4,003.	5,354.	6,159.	7,911.
		84"	36"	24"	ACMMR823 () () ()	4,209.	5,609.	6,481.	8,322.

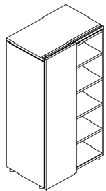

left hand shown

Order Code	Specification Information	Application Notes
Example: ACKL722WEV316AAAA	To order please specify pattern number including:	
A AutoStrada	1. Hand (applicable for units with wardrobes only) <i>L = wardrobe on left</i> <i>R = wardrobe on right</i>	
C Cabinet	2. Height <i>7 = 70" h</i> <i>2 = 24" deep</i> <i>2 = 30" wide</i>	
K Wardrobe/Open bookcase	3. Width <i>2 = 30" wide</i> <i>3 = 36" wide</i>	
L Left Hand	4. Interior & shelf <i>W = wood drawer interior and wood shelves</i> <i>M = wood drawer interior and metal shelves</i>	
7 70" high	5. Extruded aluminum pull <i>E = extruded aluminum pull (default)</i>	
2 24" deep	6. Finish <i>Laminate, V1, V2 or V3 finish</i>	
2 30" wide	7. Finish, Metal Shelves (if applicable) (paint finish or anodized aluminum three piece assembly)	Cabinets on this page are styled for the private office and include aluminum feet detail which is optional addition to lower storage beginning on page 186. Specify 70" h cabinets for use with single high overhead storage and 84" h cabinets for use with double high overhead storage.
W Wood interior	8. Finish, Aluminum trim (trim & if pull) <i>AA - Anodized aluminum or painted finish option from page 8 excluding silver</i>	Hinged doors feature touch latches and do not lock. Sliding doors do not lock. File drawers dilled for locks, keying instructions must accompany order.
E Extruded Aluminum Pull	9. Finish, cabinet feet <i>AA - Anodized aluminum or painted finish option from page 8 excluding silver</i>	Coat rod included in wardrobes.
V316 Finish, Maple	See page 8 for finish options applicable.	
AA Finish, trim & pull, anodized aluminum	Product on this page will accept wood grain laminate where laminate is currently an option.	
AA Finish, cabinet feet, anodized alum		

description	type	h	w	d	pattern no.	L	V1	V2	V3
Full wardrobe		70"	30"	24"	ACW722 () ()	\$3,220.	\$4,533.	\$5,172.	\$6,725.
		70"	36"	24"	ACW723 () ()	3,383.	4,761.	5,430.	7,058.
		84"	30"	24"	ACW822 () ()	3,383.	4,761.	5,430.	7,058.
		84"	36"	24"	ACW823 () ()	3,498.	4,922.	5,618.	7,304.

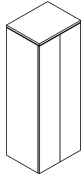

Touch latch only, no pulls/no lock; includes coat rod.

Order Code	Specification Information	Application Notes
Example: ACKL722WEV316AAAA	<i>To order please specify pattern number including:</i>	
A AutoStrada		
C Cabinet		
K Wardrobe/Open bookcase	1. Hand <i>(applicable for units with wardrobes only)</i> <i>L = wardrobe on left</i> <i>R = wardrobe on right</i>	
L Left Hand		
7 70" high	2. Height <i>7 = 70" h</i> <i>8 = 84" h</i>	
2 24" deep		
2 30" wide	3. Width <i>2 = 30" wide</i> <i>3 = 36" wide</i>	
W Wood interior		
E Extruded Aluminum Pull	4. Interior & shelf <i>W = wood drawer interior and wood shelves</i> <i>M = wood drawer interior and metal shelves</i>	
V316 Finish, Maple		
AA Finish, trim & pull, anodized aluminum	5. Extruded aluminum pull <i>E = extruded aluminum pull (default)</i>	
AA Finish, cabinet feet, anodized alum	6. Finish <i>Laminate, V1, V2 or V3 finish</i>	
	7. Finish, Metal Shelves <i>(if applicable)</i> <i>(paint finish or anodized aluminum three piece assembly)</i>	Cabinets on this page are styled for the private office and include aluminum feet detail which is optional addition to lower storage beginning on page 186. Specify 70" h cabinets for use with single high overhead storage and 84" h cabinets for use with double high overhead storage.
	8. Finish, Aluminum trim (trim & if pull) <i>AA - Anodized aluminum or painted finish option from page 8 excluding silver</i>	Hinged doors feature touch latches and do not lock. Sliding doors do not lock. File drawers dilled for locks, keying instructions must accompany order.
	9. Finish, cabinet feet <i>AA - Anodized aluminum or painted finish option from page 8 excluding silver</i>	Coat rod included in wardrobes.
	See page 8 for finish options applicable.	
	Product on this page will accept wood grain laminate where laminate is currently an option.	

Freestanding Cabinets for open plan use with metal case pedestals

AutoStrada

description	h	w	d	pattern no.	lam. case	lam. case	lam. case	lam. case	lam. case	ven. case	ven. case	ven. case
					P1/P2/P3 front	lam front	V1 front	V2 front	V3 front	V1 front	V2 front	V3 front
Freestanding cabinet, 48"h	48"	24"	24"	AAV1 4824 S2D1F () () () ()	\$2,997.	\$2,910.	\$3,246.	\$3,336.	\$3,928.	\$3,935.	\$4,587.	\$6,209.
	48"	30"	24"	AAV1 4830 S2D1F () () () ()	3,140.	3,043.	3,372.	3,489.	4,174.	4,043.	4,800.	6,734.

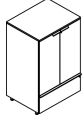

Freestanding cabinet, 64"h	64"	24"	24"	AAV1 6424 S2D2F () () () ()	3,246.	3,138.	3,512.	3,560.	4,332.	4,460.	5,151.	7,128.
	64"	30"	24"	AAV1 6430 S2D2F () () () ()	3,425.	3,297.	3,666.	3,747.	4,643.	4,554.	5,448.	7,782.

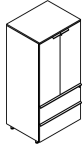

Order Code	Specification Information	Application Notes
Example: AAV1 4824 S2D1F L 118 P 613 AA	<i>To order please specify pattern number including:</i>	Freestanding cabinets for open plan are designed to match drawer fronts of AutoStrada metal pedestals in heights and thickness. Doors have 5 1/2" wide protruding pull and drawers have full width pulls. Cabinets are wood construction with 1 1/2" telescoping glides to match pedestals.
AAV1 Freestanding cabinet	L Lock	48"H cabinets have 2 doors over 1 file.
48 Height	N No lock	64"H cabinets have 2 doors over 2 files.
24 Width	Case finish (laminate or veneer only)	Files are full extension steel drawers that accept suspended legal file folders side to side. File bars are included to also support suspended letter or A4 side to side or front to back. File drawers are not bottom loadable.
S Depth	Front type	Cabinets are laminate case and top with painted, laminate or veneer fronts, or all veneer case and fronts.
2D Two door	L Laminate	
1F One file	P Paint	
L With lock	V Veneer	
118 Case finish	Front finish code	
P Front type	Pull finish (AA only)	
613 Front finish		
AA Pull finish		

Metal case
Pedestals
Floorstanding

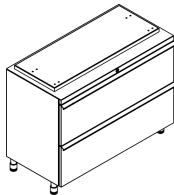
description	type	width	depth	height	pattern number	P1/P2 front	P3 front	L front	V1 front	V2 front	V3 front
	personal/data/file	15"	17"	27"	ASFS1PDF18 () () ()	\$1,222.	\$1,281.	\$1,181.	\$1,580.	\$1,628.	\$1,767.
		15"	23"	27"	ASFS1PDF24 () () ()	1,323.	1,388.	1,295.	1,649.	1,696.	1,842.
	file/file	15"	17"	27"	ASFS1FF18 () () ()	1,043.	1,097.	1,042.	1,374.	1,450.	1,591.
		15"	23"	27"	ASFS1FF24 () () ()	1,133.	1,188.	1,136.	1,435.	1,516.	1,661.
	personal/data/file	30"	17"	27"	ASFS1WPDF30 () () ()	1,740.	1,827.	1,740.	2,093.	2,352.	3,060.
		36"	17"	27"	ASFS1WPDF36 () () ()	2,127.	2,235.	2,127.	2,566.	2,891.	3,756.
	file/file	30"	17"	27"	ASFS1WFF30 () () ()	1,512.	1,588.	1,512.	1,821.	2,048.	2,658.
		36"	17"	27"	ASFS1WFF36 () () ()	1,850.	1,943.	1,850.	2,233.	2,514.	3,267.
	data/file	30"	17"	23"	ASFS1WDF30 () () ()	1,438.	1,509.	1,438.	1,729.	1,942.	2,527.
		36"	17"	23"	ASFS1WDF36 () () ()	1,759.	1,846.	1,759.	2,122.	2,389.	3,103.
	2 door	30"	17"	27"	ASFS1WDD30 () () ()	1,512.	1,588.	1,509.	1,821.	2,048.	2,658.
		36"	17"	27"	ASFS1WDD36 () () ()	1,850.	1,943.	1,850.	2,233.	2,514.	3,267.

Order Code

Example:	ASFS1 FF18 111 P 114 AA
ASFS1	Autostrada floorstanding pedestal
FF	Configuration
18	Depth
111	Finish for case
P	Finish type for fronts
114	Finish for fronts
AA	Finish for pulls

Specification Information

All pedestals include front lock with KnollKey lock system. Personal drawer is 4" h. Data drawer is 7" h. File drawers are 11" h. Deep file drawers include file support for letter (width) or legal (depth) suspended file folders. All drawers have full extension, ball bearing drawer slides.

Please specify painted finish for case or fronts from paint finish options; front finish also optional from laminate, V1, V2 or V3 finish options listed on page 8.

Pulls are available in anodized aluminum or painted finish options listed on page 8 excluding silver.

Application Notes

Floorstanding pedestals include levelling glides and closed top with 1" spacer to support one end of a worksurface at 27" h to underside of worksurface. 18" d pedestals fit under any worksurface with standard stiffener. Deep floorstanding pedestals fit under worksurfaces with worksurface stiffener 18" less than nominal width.

The metal case pedestals come with a 1" h board spacer that installs between the case and the worksurface it is supporting. The tops of the pedestals are drilled to accept the attachment screws.

Pedestals may not be used in freestanding applications.

Metal case
Pedestals
Mobile

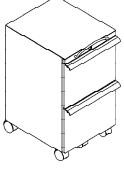
description	type	width	depth	height	pattern number	P1/P2 front	P3 front	L front	V1 front	V2 front	V3 front	
	Mobile pedestal	Standard - data/file	15"	17"	22"	ASMS1 DF18 () () ()	\$1,031.	\$1,080.	\$1,042.	\$1,390.	\$1,484.	\$1,545.
	Deep - data/file	15"	23"	22"	ASMS1 DF24 () () ()	1,165.	1,225.	1,176.	1,595.	1,695.	1,759.	
	Standard - personal/data/file	15"	17"	26 1/2"	ASMS1 PDF18 () () ()	1,201.	1,263.	1,176.	1,582.	1,628.	1,761.	
	Deep - personal/data/file	15"	23"	26 1/2"	ASMS1 PDF24 () () ()	1,336.	1,404.	1,309.	1,796.	1,844.	1,994.	
	Standard - file/file	15"	17"	26 1/2"	ASMS1 FF18 () () ()	1,087.	1,141.	1,088.	1,458.	1,535.	1,545.	
	Deep - file/file	15"	23"	26 1/2"	ASMS1 FF24 () () ()	1,224.	1,283.	1,228.	1,595.	1,676.	1,826.	
Mobile pedestal, open top	Standard - data/file	15"	17"	22"	ASMS1 DFO18 () () ()	973.	1,024.	981.	1,352.	1,448.	1,504.	
Deep - data/file	15"	23"	22"	ASMS1 DFO24 () () ()	1,099.	1,152.	1,102.	1,546.	1,644.	1,711.		

Order Code

Specification Information

Application Notes

Example: **ASMS1 FF18 111 P 114 AA**

ASMS1	Autostrada mobile pedestal
FF	Configuration
18	Depth
111	Finish for case
P	Finish type for fronts
114	Finish for fronts
AA	Finish for pulls

All pedestals include front lock with KnollKey lock system. Personal drawer is 4"H. Data drawer is 7"H. File drawers are 11"H. Deep file drawers include file support for letter (width) or legal (depth) suspended file folders. All drawers have full extension, ball bearing drawer slides.

Please specify painted finish for case or fronts from paint finish options: front finish also optional from laminate, V1, V2 or V3 finish options listed on page 8.

Pulls are available in anodized aluminum or painted finish options listed on page 8 excluding silver.

Mobile pedestals are independent storage components with locking casters and pull. Standard mobile pedestals roll under worksurfaces set at 28" or higher. Deep mobile pedestals with two files or personal/data/file will not fit under stiffener of universal worksurface or desk set at 29" or lower. Specify data/file mobile pedestal under worksurfaces adjusted lower than 28"H.

Metal case
Pedestals
Accessories
cushion - fabric

description	type	width	depth	pattern number	A	com B	C	D	E	F	G	H	I
					Cushion	Deep	15"	23"	AS1 DPAD ()	\$235.	\$263.	\$308.	\$322.
	Standard	15"	17"	AS1 SPAD ()	190.	219.	250.	263.	279.	308.	337.	383.	396.

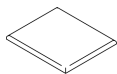

Order Code

Example: **AS1 SPAD**

AS1 Pedestal

S Depth

PAD Cushion

Specification Information

There is a \$80 upcharge on CAL133 backing on the cushion.

Consult the Currents price list for fabric information and grades

Application Notes

Pedestal cushions are for use on open top mobile pedestals.

For Customers Own Material (COM) applications, specify .75 yards of fabric for 17 inch deep mobile pedestal seat cushions, and .90 yards for 23 inch deep seat cushion.

Metal case
Pedestals
Accessories
cushion - leather

description	type	width	depth	pattern number	COL U	V	W	X	Y
Cushion	Deep	15"	23"	AS1 DPAD ()	\$469.	\$558.	\$688.	\$720.	\$761.
	Standard	15"	17"	AS1 SPAD ()	367.	439.	541.	558.	586.

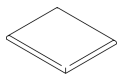

Order Code	Specification Information	Application Notes
Example: AS1 SPAD		
ASI Pedestal	There is a \$105 upcharge for perforated leather.	Pedestal cushions are for use on open top mobile pedestals.
S Depth	Consult the Currents price list for leather information and grades.	For Customers Own Leather (COL) applications, specify 11.5 sq. feet of leather for 17 inch deep mobile pedestal seat cushions, and 14.5 sq. feet for 23 inch deep seat cushion.
PAD Cushion		

Metal case
Pedestals
Accessories
various

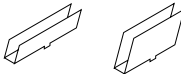
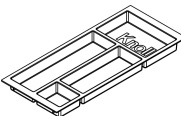
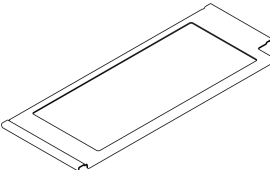
description	type	width	depth	height	pattern number	list
Drawer divider 	Personal or data drawer				MD6-BD	\$37.
File support rail	File drawer, set of 2				MD6-FS	13.
Bumper kits for mobile pedestal	21"H pedestal			21"	AS1 BKL	47.
	26"H pedestal			26"	AS1 BKH	56.
Pencil tray 	Personal or data drawer for 16" (letter width) Peds	13 1/4"	5 7/8"	1"	AS2 PT(C)	47.
	Personal or data drawer for 16" (letter width) Peds	13 1/4"	5 7/8"	1"	AS2 PT(N)	40.
Pencil tray adapter 	Use with 19" (Legal width) peds Includes metal adapter tray and plastic pencil tray				RPETAD	85.

Order Code	Specification Information	Application Notes
Example: AS2 PT <hr/> AS2 Pedestal <hr/> PT Pencil tray	Pencil tray is molded plastic and is available in black or clear. Black: N Clear: C Replacement worksurface stiffeners are black painted steel. Bumper kit is trim grey plastic.	Pencil tray sets in top of personal or data drawer. Moveable dividers organize pencils, pens, and paper clips in separate compartments. Drawer divider mounts in slots in bottom of personal or data drawer. U-shaped divider supports two rows of four CDs with titles visible in data drawer. File support spans width of file drawer to support side-to-side letter or legal width suspended files.

Wood or laminate case

Pedestals, wood drawer interiors

AutoStrada

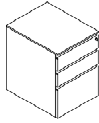
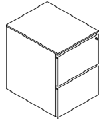
description	type	h	w	d	pattern no.	L	V1	V2	V3		
	Pedestal, BBF	19" deep	26"	16"	19"	AFPB10(E/P)(W)() ()	\$1,458.	\$1,724.	\$1,941.	\$2,516.	
			26"	19"	19"	AFPB11(E/P)(W)() ()	1,458.	1,724.	1,941.	2,516.	
	23" deep	26"	16"	23"	AFPB20(E/P)(W)() ()	1,601.	1,893.	2,132.	2,763.		
		26"	19"	23"	AFPB21(E/P)(W)() ()	1,601.	1,893.	2,132.	2,763.		
	29" deep	26"	16"	29"	AFPB30(E/P)(W)() ()	1,841.	2,174.	2,447.	3,176.		
		26"	19"	29"	AFPB31(E/P)(W)() ()	1,841.	2,174.	2,447.	3,176.		
		Pedestal, FF	19" deep	26"	16"	19"	AFPF10(E/P)(W)() ()	1,358.	1,601.	1,805.	2,345.
				26"	19"	19"	AFPF11(E/P)(W)() ()	1,358.	1,601.	1,805.	2,345.
26"				30"	19"	AFPF12(E/P)(W)() ()	1,753.	2,066.	2,322.	3,020.	
26"				36"	19"	AFPF13(E/P)(W)() ()	2,143.	2,535.	2,854.	3,707.	
26"				42"	19"	AFPF14(E/P)(W)() () *	2,629.	3,108.	3,506.	4,559.	
23" deep		26"	16"	23"	AFPF20(E/P)(W)() ()	1,560.	1,842.	2,076.	2,697.		
		26"	19"	23"	AFPF21(E/P)(W)() ()	1,560.	1,842.	2,076.	2,697.		
		26"	30"	23"	AFPF22(E/P)(W)() ()	2,011.	2,375.	2,674.	3,472.		
		26"	36"	23"	AFPF23(E/P)(W)() ()	2,466.	2,914.	3,284.	4,267.		
		26"	42"	23"	AFPF24(E/P)(W)() () *	3,024.	3,574.	4,033.	5,243.		
29" deep		26"	16"	29"	AFPF30(E/P)(W)() ()	1,795.	2,119.	2,386.	3,100.		
		26"	19"	29"	AFPF31(E/P)(W)() ()	1,795.	2,119.	2,386.	3,100.		

Order Code	Specification Information	Application Notes
Example: AFPB21EWW316AA	To order please specify pattern number including:	
A AutoStrada	1. Pedestal type (embedded in pattern number) F = Floor standing M = Mobile	5. Pull E = extruded aluminum pull P = extruded aluminum protruding pull
F Floor standing	2. Pedestal configuration B = BBF (floorstanding) or BF (mobile) F = File/File	6. Interior W = wood drawer interior
P Pedestal	3. Depth (nominal) 1 = 19" deep 2 = 23" deep 3 = 29" deep * (*available only in 16" or 19" widths)	7. Finish Laminate, V1, V2 or V3 finish
B Box/Box/File configuration	4. Width 0 = 16" wide (nominal) 1 = 19" wide (nominal) 2 = 30" wide (nominal) 3 = 36" wide (nominal) 4 = 42" wide (nominal)	8. Finish, pull Anodized aluminum or painted finish options listed on page 10 excluding silver.
2 23" deep (nominal)		See page 8 for finish options applicable.
1 19" wide (nominal)		Product on this page will accept wood grain laminate where laminate is currently an option.
E Extruded aluminum pull		Note: Optional cabinet feet are recommended when pedestals used in free-standing applications to achieve overall desk height of 29 ⁵ / ₈ " (see page 259).
W Wood interior		Primary finished top required in freestanding applications, ordered separately when item stands alone.
V316 Finish, Maple		Wood pencil tray included with BBF pedestals.
AA Finish, pull (anodized aluminum)		

Wood or laminate case

Pedestals, wood drawer interiors

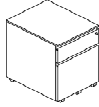
description	type	h	w	d	pattern no.	L	V1	V2	V3
Counterweight (for file/file configurations when used in single use freestanding applications)					RCOUNTWT	\$106.			
Mobile ped, BF 	19" deep	21 3/4"	16"	19"	AMPB10(E/P)(W)() ()	1,971.	2,325.	2,619.	3,404.
		21 3/4"	19"	19"	AMPB11(E/P)(W)() ()	1,971.	2,325.	2,619.	3,404.
	23" deep	21 3/4"	16"	23"	AMPB20(E/P)(W)() ()	2,266.	2,671.	3,015.	3,917.
		21 3/4"	19"	23"	AMPB21(E/P)(W)() ()	2,266.	2,671.	3,015.	3,917.

Order Code	Specification Information	Application Notes
Example: AFPB21EWW316AA	To order please specify pattern number including:	
A AutoStrada	1. Pedestal type (embedded in pattern number) F = Floor standing M = Mobile	5. Pull E = extruded aluminum pull P = extruded aluminum protruding pull
F Floor standing	2. Pedestal configuration B = BBF (floorstanding) or BF (mobile) F = File/File	6. Interior W = wood drawer interior
P Pedestal	3. Depth (nominal) 1 = 19" deep 2 = 23" deep 3 = 29" deep * (*available only in 16" or 19" widths)	7. Finish Laminate, V1, V2 or V3 finish
B Box/Box/File configuration	4. Width 0 = 16" wide (nominal) 1 = 19" wide (nominal) 2 = 30" wide (nominal) 3 = 36" wide (nominal) 4 = 42" wide (nominal)	8. Finish, pull Anodized aluminum or painted finish options listed on page 10 excluding silver.
2 23" deep (nominal)		See page 8 for finish options applicable.
1 19" wide (nominal)		Product on this page will accept wood grain laminate where laminate is currently an option.
E Extruded aluminum pull		Note: Optional cabinet feet are recommended when pedestals used in free-standing applications to achieve overall desk height of 29 5/8" (see page 259).
W Wood interior		Primary finished top required in freestanding applications, ordered separately when item stands alone.
V316 Finish, Maple		Wood pencil tray included with BBF pedestals.
AA Finish, pull (anodized aluminum)		

Actual depth nominal plus 3/8", finished back adds 1/2" (see page 191 for backs). Mobile pedestal includes finished back. All pedestals on this page include a finished sub-top and anti-tip spacer. Height to underside of worksurface including anti-tip spacer is 27"h. Optional work surface stand-offs (to use in place of anti-tip spacer) are specified separately from page 259.

19" wide (nominal) units accommodate legal filing front to back. File bars included to accommodate letter filing front to back. 30", 36" and 42" wide units include file bars to accommodate legal and letter filing front to back and side to side.

File drawers are bottom loadable for 30" and 36" only.

* 42" are not bottom loadable.

Note: 42" wide pedestals, require 4 counter weights.

Pedestals drilled for locks, keying instructions must accompany order.

Wood or laminate case

Pedestals, metal drawer interiors

AutoStrada

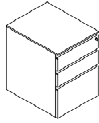
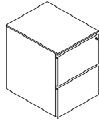
description	type	h	w	d	pattern no.	L	V1	V2	V3	
 Pedestal, BBF	19" deep	26"	16"	19"	AFPB10(E/P)(M)() ()	\$1,323.	\$1,572.	\$1,788.	\$2,359.	
		26"	19"	19"	AFPB11(E/P)(M)() ()	1,323.	1,572.	1,788.	2,359.	
	23" deep	26"	16"	23"	AFPB20(E/P)(M)() ()	1,463.	1,740.	1,978.	2,604.	
		26"	19"	23"	AFPB21(E/P)(M)() ()	1,463.	1,740.	1,978.	2,604.	
	29" deep	26"	16"	29"	AFPB30(E/P)(M)() ()	1,698.	2,017.	2,289.	3,008.	
		26"	19"	29"	AFPB31(E/P)(M)() ()	1,698.	2,017.	2,289.	3,008.	
	 Pedestal, FF	19" deep	26"	16"	19"	AFPF10(E/P)(M)() ()	1,221.	1,451.	1,653.	2,187.
			26"	19"	19"	AFPF11(E/P)(M)() ()	1,221.	1,451.	1,653.	2,187.
26"			30"	19"	AFPF12(E/P)(M)() ()	1,493.	1,776.	2,035.	2,723.	
26"			36"	19"	AFPF13(E/P)(M)() ()	1,877.	2,239.	2,560.	3,404.	
23" deep		26"	16"	23"	AFPF20(E/P)(M)() ()	1,422.	1,688.	1,922.	2,537.	
		26"	19"	23"	AFPF21(E/P)(M)() ()	1,422.	1,688.	1,922.	2,537.	
		26"	30"	23"	AFPF22(E/P)(M)() ()	1,747.	2,080.	2,382.	3,173.	
		26"	36"	23"	AFPF23(E/P)(M)() ()	2,198.	2,616.	2,986.	3,956.	
29" deep		26"	16"	29"	AFPF30(E/P)(M)() ()	1,654.	1,961.	2,227.	2,935.	
		26"	19"	29"	AFPF31(E/P)(M)() ()	1,654.	1,961.	2,227.	2,935.	
Counterweight (for file/file configurations when used in single use freestanding applications)					RCOUNTWT	106.				

Order Code	Specification Information	Application Notes
Example: AFPB21EMV316AA	To order please specify pattern number including:	
A AutoStrada	1. Pedestal type (embedded in pattern number) F = Floor standing M = Mobile	5. Pull E = extruded aluminum pull P = extruded aluminum protruding pull
F Floor standing	2. Pedestal configuration B = BBF (floorstanding) or BF (mobile) F = File/File	6. Interior M = metal drawer interior
P Pedestal	3. Depth (nominal) 1 = 19" deep 2 = 23" deep 3 = 29" deep * (*available only in 16" or 19" widths)	7. Finish Laminate, V1, V2 or V3 finish
B Box/Box/File configuration	4. Width 0 = 16" wide (nominal) 1 = 19" wide (nominal) 2 = 30" wide (nominal) 3 = 36" wide (nominal)	8. Finish, pull Anodized aluminum or painted finish options listed on page 10 excluding silver.
2 23" deep (nominal)		See page 8 for finish options applicable.
1 19" wide (nominal)		Product on this page will accept wood grain laminate where laminate is currently an option.
E Extruded aluminum pull		Note: Optional cabinet feet are recommended when pedestals used in free-standing applications to achieve overall desk height of 29 ^{5/8} " (see page 259).
M Metal interior		Primary finished top required in freestanding applications, ordered separately when item stands alone.
V316 Finish, Maple		Pencil tray to be ordered separately see page 185.
AA Finish, pull (anodized aluminum)		

Wood or laminate case
Pedestals, metal drawer interiors

AutoStrada

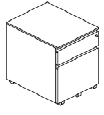
description	type	h	w	d	pattern no.	L	V1	V2	V3
 Mobile ped, BF	19" deep	21 3/4"	16"	19"	AMPB10(E/P)(M)() ()	\$1,858.	\$2,198.	\$2,493.	\$3,268.
		21 3/4"	19"	19"	AMPB11(E/P)(M)() ()	1,858.	2,198.	2,493.	3,268.
	23" deep	21 3/4"	16"	23"	AMPB20(E/P)(M)() ()	2,150.	2,543.	2,882.	3,774.
		21 3/4"	19"	23"	AMPB21(E/P)(M)() ()	2,150.	2,543.	2,882.	3,774.

Order Code

Example:	AFPB21EMV316AA
A	AutoStrada
F	Floor standing
P	Pedestal
B	Box/Box/File configuration
2	23" deep (nominal)
1	19" wide (nominal)
E	Extruded aluminum pull
M	Metal interior
V316	Finish, Maple
AA	Finish, pull (anodized aluminum)

Specification Information

To order please specify pattern number including:

- Pedestal type (embedded in pattern number)
F = Floor standing
M = Mobile
- Pedestal configuration
B = BBF (floorstanding) or BF (mobile)
F = File/File
- Depth (nominal)
1 = 19" deep
2 = 23" deep
3 = 29" deep *
(*available only in 16" or 19" widths)
- Width
0 = 16" wide (nominal)
1 = 19" wide (nominal)
2 = 30" wide (nominal)
3 = 36" wide (nominal)

Application Notes

- Pull
E = extruded aluminum pull
P = extruded aluminum protruding pull
- Interior
M = metal drawer interior
- Finish
Laminate, V1, V2 or V3 finish
- Finish, pull
Anodized aluminum or painted finish options listed on page 10 excluding silver.

See page 8 for finish options applicable.

Product on this page will accept wood grain laminate where laminate is currently an option.

Note: Optional cabinet feet are recommended when pedestals used in free-standing applications to achieve overall desk height of 29 5/8" (see page 259).

Primary finished top required in freestanding applications, ordered separately when item stands alone.

Pencil tray to be ordered separately see page 185.

Actual depth nominal plus 3/8", finished back adds 1/2" (see page 191 for backs). Mobile pedestal includes finished back. All pedestals on this page include a finished sub-top and anti-tip spacer. Height to underside of worksurface including anti-tip spacer is 27"h. Optional work surface stand-offs (to use in place of anti-tip spacer) are specified separately from page 259.

19" wide (nominal) units accommodate legal filing front to back. File bars included to accommodate letter filing front to back. 30", 36" and 42" wide units include file bars to accommodate legal and letter filing front to back and side to side.

File drawers are bottom loadable for 30" and 36" only. 42" are not bottom loadable.

Pedestals drilled for locks, keying instructions must accompany order.

Wood or laminate case

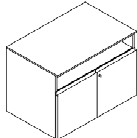

Lower storage

AutoStrada

description	type	h	w	d	pattern no.	L	V1	V2	V3
 <p>36" w shown</p>	19" deep	26"	16"	19"	AFPHL10(E/P)(L/N)(W)() ()	\$930.	\$1,074.	\$1,238.	\$1,609.
		26"	16"	19"	AFPHR10(E/P)(L/N)(W)() ()	930.	1,074.	1,238.	1,609.
		26"	19"	19"	AFPHL11(E/P)(L/N)(W)() ()	930.	1,074.	1,238.	1,609.
		26"	19"	19"	AFPHR11(E/P)(L/N)(W)() ()	930.	1,074.	1,238.	1,609.
		26"	30"	19"	AFPH12(E/P)(L/N)(W)() ()	1,106.	1,276.	1,465.	1,907.
		26"	36"	19"	AFPH13(E/P)(L/N)(W)() ()	1,378.	1,594.	1,836.	2,384.
		26"	42"	19"	AFPH14(E/P)(L/N)(W)() ()	1,725.	1,985.	2,292.	2,981.
	23" deep	26"	16"	23"	AFPHL20(E/P)(L/N)(W)() ()	1,069.	1,238.	1,424.	1,850.
		26"	16"	23"	AFPHR20(E/P)(L/N)(W)() ()	1,069.	1,238.	1,424.	1,850.
		26"	19"	23"	AFPHL21(E/P)(L/N)(W)() ()	1,069.	1,238.	1,424.	1,850.
		26"	19"	23"	AFPHR21(E/P)(L/N)(W)() ()	1,069.	1,238.	1,424.	1,850.
		26"	30"	23"	AFPH22(E/P)(L/N)(W)() ()	1,267.	1,468.	1,688.	2,194.
		26"	36"	23"	AFPH23(E/P)(L/N)(W)() ()	1,586.	1,834.	2,108.	2,741.
		26"	42"	23"	AFPH24(E/P)(L/N)(W)() ()	1,982.	2,287.	2,634.	3,424.

Order Code	Specification Information	Application Notes
Example: AFPHL21ELWV316AA	To order please specify pattern number including:	Units on this page include a finished sub-top and anti-tip spacer. Height to underside of worksurface including anti-tip spacer is 27" h. Optional work surface stand-offs (to use in place of anti-tip spacer) are specified separately from page 259.
A AutoStrada	1. Hand (applicable 16" and 19" wide units) <i>L = hinges on left</i> <i>R = hinges on right</i>	Primary finished top required in freestanding applications, ordered separately when item stands alone.
F Floor standing	2. Depth <i>1 = 20" deep</i> <i>2 = 24" deep</i>	Note: Optional cabinet feet are recommended when units used in free-standing applications to achieve overall desk height of 29 5/8" (see page 259).
P Pedestal	3. Width <i>0 = 16" wide</i> <i>1 = 19" wide</i> <i>2 = 30" wide</i> <i>3 = 36" wide</i> <i>4 = 42" wide</i>	
H Hinged door/open shelf above	4. Pull <i>E = Extruded aluminum pull</i> <i>P = Extruded aluminum protruding pull</i>	
L Left hand	5. Lock option <i>L = drilled for locks</i> <i>N = not drilled for locks</i>	
2 24" deep	6. Interior <i>W = wood interior (only)</i>	
1 19" wide	7. Finish <i>Laminate, V1, V2 or V3 finish</i>	
E Extruded aluminum pull	8. Finish, pull <i>Anodized aluminum or painted finish options listed on page 10 excluding silver.</i>	
L Drilled for lock	Optional lock drilled to be specified. If drilled for locks selected, keying instructions must accompany order.	
W Wood interior	See page 8 for finish options applicable.	
V316 Finish, Maple	Product on this page will accept wood grain laminate where laminate is currently an option.	
AA Finish, pull (anodized aluminum)		

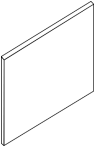
Wood or laminate case
Finished backs for lower storage

description	h	w	thickness	pattern no.	L	V1	V2	V3
 Finished back	25 1/2"	16"	1/2"	AFB16 ()	\$128.	\$142.	\$165.	\$217.
	25 1/2"	19"	1/2"	AFB19 ()	128.	142.	165.	217.
	25 1/2"	30"	1/2"	AFB30 ()	254.	284.	326.	423.
	25 1/2"	36"	1/2"	AFB36 ()	300.	339.	389.	503.
	25 1/2"	42"	1/2"	AFB42 ()	418.	503.	582.	757.
	25 1/2"	60"	1/2"	AFB60 ()	505.	618.	708.	920.
	25 1/2"	72"	1/2"	AFB72 ()	583.	708.	816.	1,059.
	25 1/2"	84"	1/2"	AFB84 ()	657.	802.	919.	1,196.
	25 1/2"	90"	1/2"	AFB90 ()	697.	848.	972.	1,264.
	25 1/2"	96"	1/2"	AFB96 ()	716.	867.	997.	1,297.
 Pedestal filler strip	25 1/2"	5"	1/2"	AWCPFS ()	98.	141.	142.	150.
 Pedestal filler for 3/4 planning	20 3/4"	6"	1/2"	AWCPFS19 ()	90.	130.	133.	140.

Order Code

Example: AFB19V316
A AutoStrada
FB Finished back
19 19" wide
V316 Finish, Maple

Specification Information

To order please specify pattern number including:

- Width
 - 16 = for 16" wide units
 - 19 = for 19" wide units
 - 30 = for 30" wide units
 - 36 = for 36" wide units
 - 42 = for 42" wide units
 - 60 = for two 30" w side by side
 - 72 = for two 36" w side by side
 - 84 = for two 42" w side by side
 - 90 = for three 30" w side by side
 - 96 = for two 30" w & one 36" w side by side
- Finish
 - Laminate, V1, V2 or V3 finish

Application Notes



Finished backs are used with lower storage in free-standing applications where the back is exposed. Backs are 1/2" thick. Finished backs also recommended for "ganging" units together when creating build-to-spec credenza units.

Pedestal filler strip used in lieu of finished back when full back not exposed to finish gap to wall.

See page 8 for finish options applicable.

Product on this page will accept wood grain laminate where laminate is currently an option.

Wood or laminate case
Pedestals, Open Access
Wood drawer interior

description	w	d	h	pattern no.	L	V1	V2	V3
Pedestal, Open Access 	30"	19"	20 ³ / ₄ "	AFPA12()	\$1,000.	\$1,154.	\$1,326.	\$1,790.
	36"	19"	20 ³ / ₄ "	AFPA13()	1,189.	1,375.	1,584.	2,135.
	30"	23"	20 ³ / ₄ "	AFPA22()	1,245.	1,444.	1,663.	2,243.
	36"	23"	20 ³ / ₄ "	AFPA23()	1,488.	1,718.	1,977.	2,669.
Pedestal, Hinge doors 	30"	19"	22 ³ / ₄ "	AFPHD12(E/P)()W()	1,206.	1,376.	1,565.	2,007.
	36"	19"	22 ³ / ₄ "	AFPHD13(E/P)()W()	1,478.	1,694.	1,936.	2,484.
	30"	23"	22 ³ / ₄ "	AFPHD22(E/P)()W()	1,367.	1,568.	1,788.	2,294.
	36"	23"	22 ³ / ₄ "	AFPHD23(E/P)()W()	1,686.	1,934.	2,208.	2,841.
Pedestal, (desk height planning) box/file configuration 	16"	19"	20 ³ / ₄ "	AFPR10(E/P)()W()	1,558.	1,790.	2,041.	2,616.
	19"	19"	20 ³ / ₄ "	AFPR11(E/P)()W()	1,558.	1,790.	2,041.	2,616.
	30"	19"	20 ³ / ₄ "	AFPR12(E/P)()W()	1,941.	2,231.	2,547.	3,276.
	36"	19"	20 ³ / ₄ "	AFPR13(E/P)()W()	2,243.	2,585.	2,954.	3,807.
	16"	23"	20 ³ / ₄ "	AFPR20(E/P)()W()	1,701.	1,956.	2,232.	2,863.
	19"	23"	20 ³ / ₄ "	AFPR21(E/P)()W()	1,701.	1,956.	2,232.	2,863.
	30"	23"	20 ³ / ₄ "	AFPR22(E/P)()W()	1,941.	2,231.	2,547.	3,276.
	36"	23"	20 ³ / ₄ "	AFPR23(E/P)()W()	2,243.	2,585.	2,954.	3,807.

Order Code

Example: AFPA12()	
A	AutoStrada
F	Floor Standing
P	Pedestal
A	Open Access Configuration
1	19" deep
2	30" wide
316	Finish

Specification Information

To order please specify pattern number including:

1. Pedestal type (embedded in pattern number)
 A = Open access
 HD = Hinge doors
 R = Box File
2. Depth (nominal)
 1 = 19" deep
 2 = 23" deep
3. Width (nominal)
 2 = 30" wide
 3 = 36" wide
4. Finish:
Laminate, V1, V2 or V3

Application Notes

Product on this page will accept wood grain laminate where laminate is currently an option.

The open access pedestals are available with Wood interior only.

Wood or laminate case
Pedestals, Open Access
Metal drawer interior

description	w	d	h	pattern no.	L	V1	V2	V3
Pedestal, (desk height planning) box/file configuration 	16"	19"	20 ³ / ₄ "	AFPR10(E/P)()M()	\$1,423.	\$1,641.	\$1,888.	\$2,459.
	19"	19"	20 ³ / ₄ "	AFPR11(E/P)()M()	1,423.	1,641.	1,888.	2,459.
	30"	19"	20 ³ / ₄ "	AFPR12(E/P)()M()	1,798.	2,077.	2,389.	3,108.
	36"	19"	20 ³ / ₄ "	AFPR13(E/P)()M()	1,977.	2,295.	2,660.	3,504.
	16"	23"	20 ³ / ₄ "	AFPR20(E/P)()M()	1,563.	1,806.	2,078.	2,704.
	19"	23"	20 ³ / ₄ "	AFPR21(E/P)()M()	1,563.	1,806.	2,078.	2,704.
	30"	23"	20 ³ / ₄ "	AFPR22(E/P)()M()	1,798.	2,077.	2,389.	3,108.
	36"	23"	20 ³ / ₄ "	AFPR23(E/P)()M()	2,298.	2,665.	3,086.	4,056.

Order Code

Example:	AFPA10(E/P)()W()
A	AutoStrada
F	Floor Standing
P	Pedestal
R	Box / File Configuration
1	19" deep
0	16" wide
E	Extruded pull option
M	Metal interior
V316	Pedestal finish
M	Pull Finish

Specification Information

To order please specify pattern number including:

- Pedestal type (embedded in pattern number)
 A = Open access
 HD = Hinge doors
 R = Box File
- Depth (nominal)
 1 = 19" deep
 2 = 23" deep
- Width (nominal)
 0 = 16" wide
 1 = 19" wide
 2 = 30" wide
 3 = 36" wide
- Pull
 E = Extruded
 P = Extruded aluminum

Application Notes

- Interior Option:
 W = Wood
 M = Metal
- Pedestal Finish:
 Laminate, V1, V2 or V3
- Pull finish:
 Anodized aluminum or painted finish options, listed on page 10 excluding silver.

See page 8 for finish options.

Product on this page will accept wood grain laminate where laminate is currently an option.

The open access pedestals are available with Wood interior only.

Wood or laminate case
 Pedestals, Equipment style, 22³/₄" high
 Wood drawer interiors

description	type	h	w	d	pattern no.	L	V1	V2	V3
 Pedestal, Equipment	19" deep	20 ³ / ₄ "	30"	19"	AFPE12(L/R)(E/P)()W()	\$2,194.	\$3,116.	\$3,444.	\$4,109.
		20 ³ / ₄ "	36"	19"	AFPE13(L/R)(E/P)()W()	2,248.	3,180.	3,517.	4,231.
	23" deep	20 ³ / ₄ "	30"	23"	AFPE22(L/R)(E/P)()W()	2,234.	3,173.	3,500.	4,238.
		20 ³ / ₄ "	36"	23"	AFPE23(L/R)(E/P)()W()	2,285.	3,229.	3,589.	4,359.

Order Code	Specification Information	Application Notes
Example: AFPE12(L/R)(E/P)()W()	<i>To order please specify pattern number including:</i>	
A AutoStrada		6. Pull finish Anodized aluminum or painted finish options listed on page 9 excluding silver
F Floor standing	1. Pedestal type (<i>embedded in pattern number</i>) E = Equipment pedestal	7. Interior W = Wood interior
P Pedestal	2. Depth (nominal) 1 = 19" deep 2 = 23" deep	8. Finish: Wood or Laminate
E Equipment	3. Width (nominal) 2 = 30" wide 3 = 36" wide	<i>See page 8 for finish options applicable</i>
1 19" deep	4. Hand L = Left hand R = Right hand	
2 30" wide	5. Pull Option E = Extruded P = Extruded Aluminum	Product on this page will accept wood grain laminate where laminate is currently an option. The equipment pedestals are available with Wood interior only.
L Left hand		
E Pull option		
AA Pull finish		
W Wood interior		
V316 Finish, Maple		

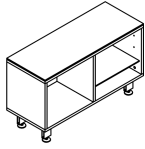
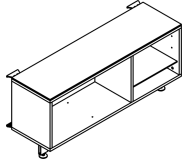
description	w	d	h	pattern no.	L	V1	V2	V3	list
Box shelf, freestanding 	36"	15"	21"	ASBF1 36() ()	\$1,013.	\$1,515.	\$1,748.	\$2,168.	
	42"	15"	21"	ASBF1 42() ()	1,047.	1,552.	1,787.	2,259.	
	48"	15"	21"	ASBF1 48() ()	1,082.	1,590.	1,826.	2,351.	
Box shelf, spine support 	36"	15"	21"	ASBS1 36() ()()	1,013.	1,515.	1,748.	2,168.	
	42"	15"	21"	ASBS1 42() ()()	1,047.	1,552.	1,787.	2,259.	
	48"	15"	21"	ASBS1 48() ()()	1,082.	1,590.	1,826.	2,351.	
Box top	36"	15"		ASBT1 36()					215.
	42"	15"		ASBT1 42()					229.
	48"	15"		ASBT1 48()					243.

Order Code	Specification Information	Application Notes
Example: ASBF1 48 114 AA AS AutoStrada storage B Box shelf F1 freestanding 48 width 114 case finish AA leg finish	To order please specify pattern number including: Box shelf freestanding 1. Finish, Case <i>Laminate, V1, V2 or V3</i> 2. Finish, Legs <i>Clear anodized aluminum or painted finish option</i> Box shelf spine support 1. Finish, Case <i>Laminate, V1, V2 or V3</i> 2. Finish, Legs <i>Clear anodized aluminum or painted finish options listed on page 10 excluding silver.</i> 3. Finish, Bracket <i>All standard paint finishes</i> Painted finish options listed on page 8 excluding silver.	Box top 1. Finish, surface <i>TEMP Clear tempered glass</i> Product on this page will accept wood grain laminate where laminate is currently an option. Freestanding box shelf includes four clear anodized aluminum or painted legs with leveling glides. Spine support version includes two legs and two brackets that clamp on to the structural base cover of AutoStrada spine or Currents service wall. Box shelf also serves as spine support in place of outrigger. Fixed height end support bracket can be attached behind spine-attached Box shelf. Optional Box top is 1/4" clear tempered glass.

Overhead storage, wood cases

Stack-on Overheads (for use with Medians)

open

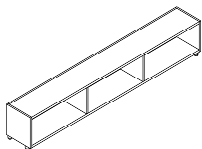
description	type	sections	h	w	d	pattern no.	L	V1	V2	V3	
 <p>96" w shown</p>	binder depth	2	15"	42"	14 1/4"	ASOBO42 () ()	\$1,836.	\$1,916.	\$2,204.	\$2,864.	
		2	15"	48"	14 1/4"	ASOBO48 () ()	1,901.	1,986.	2,282.	2,967.	
		2	15"	54"	14 1/4"	ASOBO54 () ()	1,925.	2,007.	2,310.	3,002.	
		2	15"	60"	14 1/4"	ASOBO60 () ()	1,944.	2,031.	2,337.	3,038.	
		2	15"	66"	14 1/4"	ASOBO66 () ()	2,164.	2,259.	2,598.	3,379.	
		2	15"	72"	14 1/4"	ASOBO72 () ()	2,385.	2,486.	2,860.	3,717.	
		3	15"	78"	14 1/4"	ASOBO78 () ()	2,462.	2,570.	2,954.	3,843.	
		3	15"	84"	14 1/4"	ASOBO84 () ()	2,544.	2,653.	3,052.	3,967.	
		3	15"	90"	14 1/4"	ASOBO90 () ()	2,622.	2,736.	3,146.	4,091.	
		3	15"	96"	14 1/4"	ASOBO96 () ()	2,716.	2,838.	3,260.	4,238.	
		legal depth	2	15"	42"	17 1/4"	ASOGO42 () ()	1,982.	2,064.	2,383.	3,095.
			2	15"	48"	17 1/4"	ASOGO48 () ()	2,055.	2,143.	2,464.	3,206.
			2	15"	54"	17 1/4"	ASOGO54 () ()	2,076.	2,169.	2,496.	3,245.
			2	15"	60"	17 1/4"	ASOGO60 () ()	2,100.	2,192.	2,522.	3,281.
			2	15"	66"	17 1/4"	ASOGO66 () ()	2,336.	2,439.	2,807.	3,647.
			2	15"	72"	17 1/4"	ASOGO72 () ()	2,572.	2,683.	3,089.	4,013.
			3	15"	78"	17 1/4"	ASOGO78 () ()	2,659.	2,774.	3,192.	4,151.
			3	15"	84"	17 1/4"	ASOGO84 () ()	2,745.	2,864.	3,295.	4,284.
3	15"		90"	17 1/4"	ASOGO90 () ()	2,830.	2,954.	3,397.	4,419.		
3	15"		96"	17 1/4"	ASOGO96 () ()	2,933.	3,063.	3,522.	4,580.		

Order Code	Specification Information	Application Notes
Example: ASOBO42V316AA	<p>To order please specify pattern number including:</p> <ol style="list-style-type: none"> Depth B = Binder depth G = Legal depth Width Finish Laminate, V1, V2 or V3 Finish, support feet Anodized aluminum or painted finish options listed on page 10 excluding silver. <p>See page 8 for finish options applicable.</p> <p>Product on this page will accept wood grain laminate where laminate is currently an option.</p>	<p>Stack-on overheads, as the description implies "stack-on" median top shelf, please make sure median top shelf depth and overhead depth correspond.</p> <p>Stack-on overheads correspond to interior width of medians and median storage.</p> <p>NOTE: Knoll does not assume any responsibility for the installation, attachment or the securing of wall hung units to the wall.</p> <p>A certified building contractor should be consulted.</p> <p>Please refer to wall mounting information on page 315 .</p>
A AutoStrada		
S Stack-on		
O Overhead		
B Binder depth		
O Open		
42 42" wide		
V316 Finish, Maple		
AA Finish, Support feet		

Specification Information

To order please specify pattern number including:

- Depth
B = Binder depth
G = Legal depth
- Width
- Finish
Laminate, V1, V2 or V3
- Finish, support feet
Anodized aluminum or painted finish options listed on page 10 excluding silver.

See page 8 for finish options applicable.

Product on this page will accept wood grain laminate where laminate is currently an option.

Application Notes

Stack-on overheads, as the description implies "stack-on" median top shelf, please make sure median top shelf depth and overhead depth correspond.

Stack-on overheads correspond to interior width of medians and median storage.

NOTE: Knoll does not assume any responsibility for the installation, attachment or the securing of wall hung units to the wall.

A certified building contractor should be consulted.

Please refer to wall mounting information on page 315 .

Overhead storage, wood cases

Stack-on Overheads (for use with Medians)

hinged door

description	type	# drs/locks	h	w	d	pattern no.	L	V1	V2	V3
Stack-on Overhead, Wood Hinged Doors	binder depth	3/2	15"	42"	15 1/4"	ASOBD42 () () ()	\$2,036.	\$2,126.	\$2,447.	\$3,179.
		3/2	15"	48"	15 1/4"	ASOBD48 () () ()	2,110.	2,204.	2,533.	3,295.
		3/2	15"	54"	15 1/4"	ASOBD54 () () ()	2,134.	2,229.	2,564.	3,334.
		4/2	15"	60"	15 1/4"	ASOBD60 () () ()	2,158.	2,256.	2,593.	3,370.
		4/2	15"	66"	15 1/4"	ASOBD66 () () ()	2,401.	2,504.	2,884.	3,748.
		4/2	15"	72"	15 1/4"	ASOBD72 () () ()	2,647.	2,765.	3,181.	4,137.
		5/3	15"	78"	15 1/4"	ASOBD78 () () ()	2,734.	2,852.	3,281.	4,266.
		5/3	15"	84"	15 1/4"	ASOBD84 () () ()	2,823.	2,944.	3,385.	4,403.
		6/3	15"	90"	15 1/4"	ASOBD90 () () ()	2,914.	3,039.	3,494.	4,543.
	6/3	15"	96"	15 1/4"	ASOBD96 () () ()	3,015.	3,150.	3,625.	4,711.	
	legal depth	3/2	15"	42"	18 1/4"	ASOGD42 () () ()	2,199.	2,296.	2,642.	3,435.
		3/2	15"	48"	18 1/4"	ASOGD48 () () ()	2,279.	2,383.	2,736.	3,559.
		3/2	15"	54"	18 1/4"	ASOGD54 () () ()	2,305.	2,409.	2,767.	3,600.
		4/2	15"	60"	18 1/4"	ASOGD60 () () ()	2,332.	2,435.	2,801.	3,640.
		4/2	15"	66"	18 1/4"	ASOGD66 () () ()	2,594.	2,707.	3,115.	4,051.
		4/2	15"	72"	18 1/4"	ASOGD72 () () ()	2,858.	2,987.	3,435.	4,468.
		5/3	15"	78"	18 1/4"	ASOGD78 () () ()	2,954.	3,078.	3,542.	4,607.
5/3		15"	84"	18 1/4"	ASOGD84 () () ()	3,046.	3,179.	3,656.	4,755.	
6/3		15"	90"	18 1/4"	ASOGD90 () () ()	3,147.	3,282.	3,774.	4,907.	
6/3	15"	96"	18 1/4"	ASOGD96 () () ()	3,259.	3,402.	3,914.	5,088.		

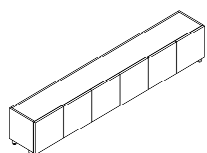

96" w shown

Order Code	Specification Information	Application Notes
Example: ASOBD42LV316AA	<i>To order please specify pattern number including:</i>	Stack-on overheads, as the description implies "stack-on" median top shelf, please make sure median top shelf depth and overhead depth correspond.
A AutoStrada	1. Depth <i>B = Binder depth</i> <i>G = Legal depth</i>	Optional lock drilling to be specified. If drilled for locks selected, keying instructions must accompany order.
S Stack-on	2. Width	Stack-on overheads correspond to interior width of medians and median storage.
O Overhead	3. Lock option <i>L = Lock hole drilled</i> <i>N = Not drilled for locks</i>	Hinged doors extend slightly beyond case construction to allow for easy finger pull access along the bottom. No pulls available.
B Binder depth	4. Finish <i>Laminate, V1, V2 or V3</i>	NOTE: Knoll does not assume any responsibility for the installation, attachment or the securing of wall hung units to the wall.
D Hinged Door	5. Finish, support feet <i>Anodized aluminum or painted finish options listed on page 10 excluding silver.</i>	A certified building contractor should be consulted.
42 42" wide	See page 8 for finish options applicable.	Please refer to wall mounting information on page 315.
L Locking	Product on this page will accept wood grain laminate where laminate is currently an option.	
V316 Finish, Maple		
AA Finish, support feet		

Overhead storage, wood cases

Stack-on Overheads (for use with Medians)

open / hinged door / open

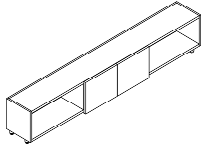
description	type	locks	h	w	d	pattern no.	L	V1	V2	V3
Stack-on Overhead, Open/Wood hinged doors/Open  96" w shown	binder depth	1	15"	60"	15 1/4"	ASOBT60 () ()	\$2,039.	\$2,132.	\$2,453.	\$3,188.
		1	15"	66"	15 1/4"	ASOBT66 () ()	2,271.	2,371.	2,729.	3,546.
		1	15"	72"	15 1/4"	ASOBT72 () ()	2,502.	2,610.	3,002.	3,904.
		1	15"	78"	15 1/4"	ASOBT78 () ()	2,585.	2,699.	3,103.	4,035.
		1	15"	84"	15 1/4"	ASOBT84 () ()	2,669.	2,784.	3,204.	4,164.
		1	15"	90"	15 1/4"	ASOBT90 () ()	2,752.	2,872.	3,304.	4,294.
	legal depth	1	15"	60"	18 1/4"	ASOGT60 () ()	2,206.	2,303.	2,649.	3,447.
		1	15"	66"	18 1/4"	ASOGT66 () ()	2,454.	2,559.	2,945.	3,830.
		1	15"	72"	18 1/4"	ASOGT72 () ()	2,702.	2,818.	3,245.	4,217.
		1	15"	78"	18 1/4"	ASOGT78 () ()	2,791.	2,914.	3,351.	4,360.
		1	15"	84"	18 1/4"	ASOGT84 () ()	2,884.	3,010.	3,462.	4,498.
		1	15"	90"	18 1/4"	ASOGT90 () ()	2,972.	3,102.	3,566.	4,639.
		1	15"	96"	18 1/4"	ASOGT96 () ()	3,079.	3,217.	3,699.	4,806.

Order Code	Specification Information	Application Notes
Example: ASOBT60LV316AA	<i>To order please specify pattern number including:</i>	Stack-on overheads, as the description implies "stack-on" median top shelf, please make sure median top shelf depth and overhead depth correspond.
A AutoStrada	1. Depth <i>B = Binder depth</i> <i>G = Legal depth</i>	Optional lock drilling to be specified. If drilled for locks selected, keying instructions must accompany order.
S Stack-on	2. Width	Stack-on overheads correspond to interior width of medians and median storage.
O Overhead	3. Lock option <i>L = Lock hole drilled</i> <i>N = Not drilled for locks</i>	NOTE: Knoll does not assume any responsibility for the installation, attachment or the securing of wall hung units to the wall.
B Binder depth	4. Finish <i>Laminate, V1, V2 or V3</i>	A certified building contractor should be consulted.
T Open/Hinged Door/Open	5. Finish, support feet <i>Anodized aluminum or painted finish options listed on page 10 excluding silver.</i>	Please refer to wall mounting information on page 315.
60 60" wide	See page 8 for finish options applicable.	
L Locking	Product on this page will accept wood grain laminate where laminate is currently an option.	
V316 Finish, Maple		
AA Finish, support feet		

Overhead storage, wood cases

Stack-on Overheads (for use with Medians) with sliding wood door(s)

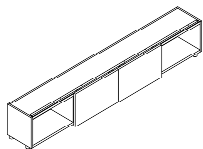
description	type	h	w	d	pattern no.	L	V1	V2	V3	
 <p>96" w shown</p>	binder depth	15"	42"	15 1/4"	ASOBS42 () () ()	\$2,751.	\$2,929.	\$3,703.	\$4,813.	
		15"	48"	15 1/4"	ASOBS48 () () ()	2,851.	3,038.	3,836.	4,985.	
		15"	54"	15 1/4"	ASOBS54 () () ()	2,884.	3,072.	3,879.	5,045.	
		15"	60"	15 1/4"	ASOBS60 () () ()	2,915.	3,105.	3,925.	5,105.	
		15"	66"	15 1/4"	ASOBS66 () () ()	3,246.	3,453.	4,365.	5,673.	
		15"	72"	15 1/4"	ASOBS72 () () ()	3,576.	3,801.	4,806.	6,246.	
		15"	78"	15 1/4"	ASOBS78 () () ()	3,692.	3,930.	4,964.	6,454.	
		15"	84"	15 1/4"	ASOBS84 () () ()	3,813.	4,058.	5,127.	6,662.	
		15"	90"	15 1/4"	ASOBS90 () () ()	3,931.	4,188.	5,286.	6,871.	
		15"	96"	15 1/4"	ASOBS96 () () ()	4,073.	4,340.	5,477.	7,121.	
		legal depth	15"	42"	18 1/4"	ASOGS42 () () ()	2,971.	3,165.	4,000.	5,200.
			15"	48"	18 1/4"	ASOGS48 () () ()	3,079.	3,281.	4,141.	5,384.
			15"	54"	18 1/4"	ASOGS54 () () ()	3,115.	3,319.	4,190.	5,446.
			15"	60"	18 1/4"	ASOGS60 () () ()	3,148.	3,354.	4,240.	5,511.
			15"	66"	18 1/4"	ASOGS66 () () ()	3,504.	3,729.	4,714.	6,130.
			15"	72"	18 1/4"	ASOGS72 () () ()	3,859.	4,107.	5,189.	6,745.
			15"	78"	18 1/4"	ASOGS78 () () ()	3,987.	4,244.	5,363.	6,970.
15"	84"		18 1/4"	ASOGS84 () () ()	4,117.	4,386.	5,535.	7,196.		
15"	90"		18 1/4"	ASOGS90 () () ()	4,246.	4,521.	5,709.	7,419.		
15"	96"		18 1/4"	ASOGS96 () () ()	4,401.	4,687.	5,914.	7,690.		

Order Code	Specification Information	Application Notes
<p>Example: ASOBS42V316AA</p> <p>A AutoStrada</p> <p>S Stack-on</p> <p>O Overhead</p> <p>B Binder depth</p> <p>S Open/Sliding (wood) Door</p> <p>42 42" wide</p> <p>AR Radius pull option</p> <p>V316 Finish, Maple</p> <p>AA Finish, support feet</p>	<p>To order please specify pattern number including:</p> <ol style="list-style-type: none"> Depth B = Binder depth G = Legal depth Sliding door material S = wood, same as case R = glass Width Pull option: AR = AutoStrada Radius pull AB = AutoStrada Bar pull Finish Laminate, V1, V2 or V3 Finish, support feet and pull Anodized aluminum or painted finish options listed on page 10 excluding silver. <p>See page 8 for finish options applicable.</p> <p>Product on this page will accept wood grain laminate where laminate is currently an option.</p>	<p>Sliding doors are not available with locks.</p> <p>Stack-on overheads, as the description implies "stack-on" median top shelf, please make sure median top shelf depth and overhead depth correspond.</p> <p>Sliding door pulls included, not visible on image. When AA finish specified pull is complimentary painted match to AA, pull not anodized.</p> <p>Stack-on overheads correspond to interior width of medians and median storage.</p> <p>NOTE: Knoll does not assume any responsibility for the installation, attachment or the securing of wall hung units to the wall.</p> <p>A certified building contractor should be consulted.</p> <p>Please refer to wall mounting information on page 315 .</p>

Overhead storage, wood cases

Stack-on Overheads (for use with Medians)

with sliding glass door(s)

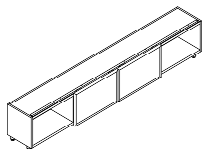
description	type	h	w	d	pattern no.	L	V1	V2	V3				
 <p>96" w shown</p>	Stack-on Overhead, Glass Sliding Door(s)	binder depth	15"	42"	15 1/4"	ASOBR42 (X)(X)(X)(X)	\$3,284.	\$3,485.	\$4,341.	\$5,647.			
			15"	48"	15 1/4"	ASOBR48 (X)(X)(X)(X)	3,401.	3,612.	4,498.	5,848.			
			15"	54"	15 1/4"	ASOBR54 (X)(X)(X)(X)	3,442.	3,654.	4,550.	5,914.			
			15"	60"	15 1/4"	ASOBR60 (X)(X)(X)(X)	3,482.	3,695.	4,603.	5,983.			
			15"	66"	15 1/4"	ASOBR66 (X)(X)(X)(X)	3,873.	4,110.	5,119.	6,655.			
			15"	72"	15 1/4"	ASOBR72 (X)(X)(X)(X)	4,266.	4,522.	5,635.	7,326.			
			15"	78"	15 1/4"	ASOBR78 (X)(X)(X)(X)	4,408.	4,677.	5,821.	7,569.			
			15"	84"	15 1/4"	ASOBR84 (X)(X)(X)(X)	4,551.	4,827.	6,012.	7,814.			
			15"	90"	15 1/4"	ASOBR90 (X)(X)(X)(X)	4,691.	4,980.	6,198.	8,059.			
			15"	96"	15 1/4"	ASOBR96 (X)(X)(X)(X)	4,862.	5,163.	6,423.	8,351.			
			legal depth			15"	42"	18 1/4"	ASOGR42 (X)(X)(X)(X)	3,544.	3,763.	4,690.	6,096.
						15"	48"	18 1/4"	ASOGR48 (X)(X)(X)(X)	3,675.	3,903.	4,856.	6,314.
						15"	54"	18 1/4"	ASOGR54 (X)(X)(X)(X)	3,718.	3,946.	4,914.	6,390.
						15"	60"	18 1/4"	ASOGR60 (X)(X)(X)(X)	3,756.	3,992.	4,972.	6,464.
						15"	66"	18 1/4"	ASOGR66 (X)(X)(X)(X)	4,183.	4,437.	5,528.	7,186.
						15"	72"	18 1/4"	ASOGR72 (X)(X)(X)(X)	4,606.	4,886.	6,086.	7,910.
						15"	78"	18 1/4"	ASOGR78 (X)(X)(X)(X)	4,761.	5,049.	6,288.	8,174.
15"	84"	18 1/4"				ASOGR84 (X)(X)(X)(X)	4,914.	5,215.	6,492.	8,439.			
15"	90"	18 1/4"				ASOGR90 (X)(X)(X)(X)	5,068.	5,379.	6,696.	8,703.			
15"	96"	18 1/4"				ASOGR96 (X)(X)(X)(X)	5,251.	5,576.	6,936.	9,017.			

Order Code	Specification Information	Application Notes
Example: ASOBR42V316GL6AA AA	To order please specify pattern number including:	Sliding doors are not available with locks.
A AutoStrada S Stack-on O Overhead B Binder depth R Open/Sliding (glass) Door 42 42" wide AR Radius pull option V316 Finish, Maple GL6 Glass, Block Matrix AA Frame, anodized aluminum AA Finish, support feet	<ol style="list-style-type: none"> Depth <i>B = Binder depth</i> <i>G = Legal depth</i> Sliding door material <i>S = wood, same as case</i> <i>R = glass</i> Width Pull option: <i>AR = AutoStrada Radius pull</i> <i>AB = AutoStrada Bar pull</i> Finish <i>Laminate, V1, V2 or V3</i> Finish, Glass sliding door <i>TEMP - Clear, tempered</i> <i>GL6 - Block Matrix</i> <i>GL13 - Powder</i> Finish, Glass sliding door frame and pull <i>Anodized aluminum or painted finish options listed on page 10 excluding silver.</i> Finish, support feet <i>Anodized aluminum or painted finish options listed on page 8 excluding silver.</i> 	Stack-on overheads correspond to interior width of medians and median storage. NOTE: Knoll does not assume any responsibility for the installation, attachment or the securing of wall hung units to the wall. A certified building contractor should be consulted. Please refer to wall mounting information on page 315.

Overhead storage, wood cases
Panel hung overheads
open

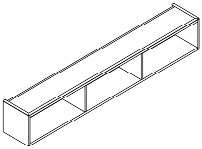
description	type	sections	h	w	d	pattern no.	L	V1	V2	V3		
 <p>96" w shown</p>	binder depth	2	15"	42"	14 1/4"	APHOBO42 ()	\$1,836.	\$1,916.	\$2,204.	\$2,864.		
		2	15"	48"	14 1/4"	APHOBO48 ()	1,901.	1,986.	2,282.	2,967.		
		2	15"	54"	14 1/4"	APHOBO54 ()	1,925.	2,007.	2,310.	3,002.		
		2	15"	60"	14 1/4"	APHOBO60 ()	1,944.	2,031.	2,337.	3,038.		
		2	15"	66"	14 1/4"	APHOBO66 ()	2,164.	2,259.	2,598.	3,379.		
		2	15"	72"	14 1/4"	APHOBO72 ()	2,385.	2,486.	2,860.	3,717.		
		3	15"	78"	14 1/4"	APHOBO78 ()	2,462.	2,570.	2,954.	3,843.		
		3	15"	84"	14 1/4"	APHOBO84 ()	2,544.	2,653.	3,052.	3,967.		
		3	15"	90"	14 1/4"	APHOBO90 ()	2,622.	2,736.	3,146.	4,091.		
		3	15"	96"	14 1/4"	APHOBO96 ()	2,716.	2,838.	3,260.	4,238.		
		legal depth		2	15"	42"	17 1/4"	APHOGO42 ()	1,982.	2,064.	2,383.	3,095.
				2	15"	48"	17 1/4"	APHOGO48 ()	2,055.	2,143.	2,464.	3,206.
				2	15"	54"	17 1/4"	APHOGO54 ()	2,076.	2,169.	2,496.	3,245.
				2	15"	60"	17 1/4"	APHOGO60 ()	2,100.	2,192.	2,522.	3,281.
2	15"			66"	17 1/4"	APHOGO66 ()	2,336.	2,439.	2,807.	3,647.		
2	15"			72"	17 1/4"	APHOGO72 ()	2,572.	2,683.	3,089.	4,013.		
3	15"			78"	17 1/4"	APHOGO78 ()	2,659.	2,774.	3,192.	4,151.		
3	15"			84"	17 1/4"	APHOGO84 ()	2,745.	2,864.	3,295.	4,284.		
3	15"			90"	17 1/4"	APHOGO90 ()	2,830.	2,954.	3,397.	4,419.		
3	15"			96"	17 1/4"	APHOGO96 ()	2,933.	3,063.	3,522.	4,580.		

Order Code

Example:	APHOBO42V316
A	AutoStrada
PH	Panel hung
O	Overhead
B	Binder depth
O	Open
42	42" wide
V316	Finish, Maple

Specification Information

To order please specify pattern number including:

- Depth
B = Binder depth
G = Legal depth
- Width
- Finish
Laminate, V1, V2 or V3

See page 8 for finish options applicable.

Product on this page will accept wood grain laminate where laminate is currently an option.

Application Notes

Panel hung overhead storage units include hardware to hang unit on panels.

NOTE: Knoll does not assume any responsibility for the installation, attachment or the securing of wall hung units to the wall.

A certified building contractor should be consulted.

Please refer to wall mounting information on page 315 .

Overhead storage, wood cases

Panel hung overheads

hinged door

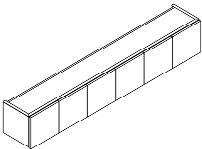
description	type	# drs/locks	h	w	d	pattern no.	L	V1	V2	V3
 <p>96" w shown</p>	binder depth	3/2	15"	42"	15 1/4"	APHOBD42 () ()	\$2,036.	\$2,126.	\$2,447.	\$3,179.
		3/2	15"	48"	15 1/4"	APHOBD48 () ()	2,110.	2,204.	2,533.	3,295.
		3/2	15"	54"	15 1/4"	APHOBD54 () ()	2,134.	2,229.	2,564.	3,334.
		4/2	15"	60"	15 1/4"	APHOBD60 () ()	2,158.	2,256.	2,593.	3,370.
		4/2	15"	66"	15 1/4"	APHOBD66 () ()	2,401.	2,504.	2,884.	3,748.
		4/2	15"	72"	15 1/4"	APHOBD72 () ()	2,647.	2,765.	3,181.	4,137.
		5/3	15"	78"	15 1/4"	APHOBD78 () ()	2,734.	2,852.	3,281.	4,266.
		5/3	15"	84"	15 1/4"	APHOBD84 () ()	2,823.	2,944.	3,385.	4,403.
		6/3	15"	90"	15 1/4"	APHOBD90 () ()	2,914.	3,039.	3,494.	4,543.
		6/3	15"	96"	15 1/4"	APHOBD96 () ()	3,015.	3,150.	3,625.	4,711.
	legal depth	3/2	15"	42"	18 1/4"	APHOGD42 () ()	2,199.	2,296.	2,642.	3,435.
		3/2	15"	48"	18 1/4"	APHOGD48 () ()	2,279.	2,383.	2,736.	3,559.
		3/2	15"	54"	18 1/4"	APHOGD54 () ()	2,305.	2,409.	2,767.	3,600.
		4/2	15"	60"	18 1/4"	APHOGD60 () ()	2,332.	2,435.	2,801.	3,640.
		4/2	15"	66"	18 1/4"	APHOGD66 () ()	2,594.	2,707.	3,115.	4,051.
		4/2	15"	72"	18 1/4"	APHOGD72 () ()	2,858.	2,987.	3,435.	4,468.
		5/3	15"	78"	18 1/4"	APHOGD78 () ()	2,954.	3,078.	3,542.	4,607.
		5/3	15"	84"	18 1/4"	APHOGD84 () ()	3,046.	3,179.	3,656.	4,755.
		6/3	15"	90"	18 1/4"	APHOGD90 () ()	3,147.	3,282.	3,774.	4,907.
		6/3	15"	96"	18 1/4"	APHOGD96 () ()	3,259.	3,402.	3,914.	5,088.

Order Code

Example:	APHOBD42LV316
A	AutoStrada
PH	Panel hung
O	Overhead
B	Binder depth
D	Hinged Door
42	42" wide
L	Locking
V316	Finish, Maple

Specification Information

To order please specify pattern number including:

1. Depth
B = Binder depth
G = Legal depth
2. Width
3. Lock option
L = Lock hole drilled
N = Not drilled for locks
4. Finish
Laminate, V1, V2 or V3

See page 8 for finish options applicable.

Product on this page will accept wood grain laminate where laminate is currently an option.

Application Notes

Panel hung overhead storage units include hardware to hang unit on panels.

Hinged doors extend slightly beyond case construction to allow for easy finger pull access along the bottom. No pulls available.

Optional lock drilling to be specified. If drilled for locks selected, keying instructions must accompany order.

NOTE: Knoll does not assume any responsibility for the installation, attachment or the securing of wall hung units to the wall.

A certified building contractor should be consulted.

Please refer to wall mounting information on page 315.

Overhead storage, wood cases

Panel hung overheads

open / hinged door / open

description	type	locks	h	w	d	pattern no.	L	V1	V2	V3
Panel hung Overhead, Open/Wood hinged doors/Open	binder depth	1	15"	60"	15 1/4"	APHOBT60 () ()	\$2,039.	\$2,132.	\$2,453.	\$3,188.
		1	15"	66"	15 1/4"	APHOBT66 () ()	2,271.	2,371.	2,729.	3,546.
		1	15"	72"	15 1/4"	APHOBT72 () ()	2,502.	2,610.	3,002.	3,904.
		1	15"	78"	15 1/4"	APHOBT78 () ()	2,585.	2,699.	3,103.	4,035.
		1	15"	84"	15 1/4"	APHOBT84 () ()	2,669.	2,784.	3,204.	4,164.
		1	15"	90"	15 1/4"	APHOBT90 () ()	2,752.	2,872.	3,304.	4,294.
		1	15"	96"	15 1/4"	APHOBT96 () ()	2,852.	2,981.	3,424.	4,449.
96" w shown	legal depth	1	15"	60"	18 1/4"	APHOGT60 () ()	2,206.	2,303.	2,649.	3,447.
		1	15"	66"	18 1/4"	APHOGT66 () ()	2,454.	2,559.	2,945.	3,830.
		1	15"	72"	18 1/4"	APHOGT72 () ()	2,702.	2,818.	3,245.	4,217.
		1	15"	78"	18 1/4"	APHOGT78 () ()	2,791.	2,914.	3,351.	4,360.
		1	15"	84"	18 1/4"	APHOGT84 () ()	2,884.	3,010.	3,462.	4,498.
		1	15"	90"	18 1/4"	APHOGT90 () ()	2,972.	3,102.	3,566.	4,639.
		1	15"	96"	18 1/4"	APHOGT96 () ()	3,079.	3,217.	3,699.	4,806.

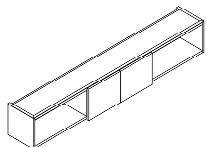

Order Code

Example:	APHOBT60LV316
A	AutoStrada
PH	Panel hung
O	Overhead
B	Binder depth
T	Open/Hinged Door/Open
60	60" wide
L	Locking
V316	Finish, Maple

Specification Information

To order please specify pattern number including:

1. Depth
B = Binder depth
G = Legal depth
2. Width
3. Lock option
L = Lock hole drilled
N = Not drilled for locks
4. Finish
Laminate, V1, V2 or V3

See page 8 for finish options applicable.

Product on this page will accept wood grain laminate where laminate is currently an option.

Application Notes

Panel hung overhead storage units include hardware to hang unit on panels.

Hinged doors extend slightly beyond case construction to allow for easy finger pull access along the bottom. No pulls available

Optional lock drilling to be specified. If drilled for locks selected, keying instructions must accompany order.

NOTE: Knoll does not assume any responsibility for the installation, attachment or the securing of wall hung units to the wall.

A certified building contractor should be consulted.

Please refer to wall mounting information on page 315.

Overhead storage, wood cases
*Panel hung overheads
 with sliding wood door(s)*

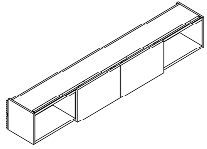
description	type	sections	h	w	d	pattern no.	L	V1	V2	V3	
 96" w shown	binder depth	1/1	15"	42"	15 1/4"	APHOBS42 () ()	\$2,751.	\$2,929.	\$3,703.	\$4,813.	
		1/1	15"	48"	15 1/4"	APHOBS48 () ()	2,851.	3,038.	3,836.	4,985.	
		1/1	15"	54"	15 1/4"	APHOBS54 () ()	2,884.	3,072.	3,879.	5,045.	
		2/2	15"	60"	15 1/4"	APHOBS60 () ()	2,915.	3,105.	3,925.	5,105.	
		2/2	15"	66"	15 1/4"	APHOBS66 () ()	3,246.	3,453.	4,365.	5,673.	
		2/2	15"	72"	15 1/4"	APHOBS72 () ()	3,576.	3,801.	4,806.	6,246.	
		2/2	15"	78"	15 1/4"	APHOBS78 () ()	3,692.	3,930.	4,964.	6,454.	
		2/2	15"	84"	15 1/4"	APHOBS84 () ()	3,813.	4,058.	5,127.	6,662.	
		2/2	15"	90"	15 1/4"	APHOBS90 () ()	3,931.	4,188.	5,286.	6,871.	
		2/2	15"	96"	15 1/4"	APHOBS96 () ()	4,073.	4,340.	5,477.	7,121.	
		legal depth	1/1	15"	42"	18 1/4"	APHOGS42 () ()	2,971.	3,165.	4,000.	5,200.
			1/1	15"	48"	18 1/4"	APHOGS48 () ()	3,079.	3,281.	4,141.	5,384.
			1/1	15"	54"	18 1/4"	APHOGS54 () ()	3,115.	3,319.	4,190.	5,446.
2/2	15"		60"	18 1/4"	APHOGS60 () ()	3,148.	3,354.	4,240.	5,511.		
2/2	15"		66"	18 1/4"	APHOGS66 () ()	3,504.	3,729.	4,714.	6,130.		
2/2	15"		72"	18 1/4"	APHOGS72 () ()	3,859.	4,107.	5,189.	6,745.		
2/2	15"		78"	18 1/4"	APHOGS78 () ()	3,987.	4,244.	5,363.	6,970.		
2/2	15"		84"	18 1/4"	APHOGS84 () ()	4,117.	4,386.	5,535.	7,196.		
2/2	15"		90"	18 1/4"	APHOGS90 () ()	4,246.	4,521.	5,709.	7,419.		
2/2	15"	96"	18 1/4"	APHOGS96 () ()	4,401.	4,687.	5,914.	7,690.			

Order Code	Specification Information
Example: APHOBS42V316	
A AutoStrada	
PH Panel hung	
O Overhead	
B Binder depth	
S Open/Sliding (wood) Door	
42 42" wide	
AR Radius pull option	
V316 Finish, Maple	
118 Pull Finish	

Specification Information

To order please specify pattern number including:

- Depth
*B = Binder depth
 G = Legal depth*
- Sliding door material
S = wood, same as case
- Width
- Pull option:
 AR = AutoStrada Radius pull
 AB = AutoStrada Bar pull
- Finish
Laminate, V1, V2 or V3
- Finish, pull
AA-complimentary painted match to anodized aluminum or painted finish options listed on page 8 excluding silver.

See page 8 for finish options applicable.

Product on this page will accept wood grain laminate where laminate is currently an option.

Application Notes

Sliding doors are not available with locks.

Panel hung overhead storage units include hardware to hang unit on panels.

Sliding door pulls included, not visible on image.

NOTE: Knoll does not assume any responsibility for the installation, attachment or the securing of wall hung units to the wall.

A certified building contractor should be consulted.

Please refer to wall mounting information on page 315 .

Overhead storage, wood cases

Panel hung overheads

with sliding glass door(s)

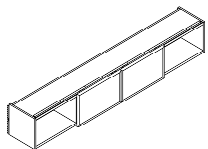
description	type	sections	h	w	d	pattern no.	L	V1	V2	V3	
 <p>96" w shown</p>	binder depth	1/1	15"	42"	15 1/4"	APHOBR42 () () ()	\$3,284.	\$3,485.	\$4,341.	\$5,647.	
		1/1	15"	48"	15 1/4"	APHOBR48 () () ()	3,401.	3,612.	4,498.	5,848.	
		1/1	15"	54"	15 1/4"	APHOBR54 () () ()	3,442.	3,654.	4,550.	5,914.	
		2/2	15"	60"	15 1/4"	APHOBR60 () () ()	3,482.	3,695.	4,603.	5,983.	
		2/2	15"	66"	15 1/4"	APHOBR66 () () ()	3,873.	4,110.	5,119.	6,655.	
		2/2	15"	72"	15 1/4"	APHOBR72 () () ()	4,266.	4,522.	5,635.	7,326.	
		2/2	15"	78"	15 1/4"	APHOBR78 () () ()	4,408.	4,677.	5,821.	7,569.	
		2/2	15"	84"	15 1/4"	APHOBR84 () () ()	4,551.	4,827.	6,012.	7,814.	
		2/2	15"	90"	15 1/4"	APHOBR90 () () ()	4,691.	4,980.	6,198.	8,059.	
		2/2	15"	96"	15 1/4"	APHOBR96 () () ()	4,862.	5,163.	6,423.	8,351.	
		legal depth	1/1	15"	42"	18 1/4"	APHOGR42 () () ()	3,544.	3,763.	4,690.	6,096.
			1/1	15"	48"	18 1/4"	APHOGR48 () () ()	3,675.	3,903.	4,856.	6,314.
			1/1	15"	54"	18 1/4"	APHOGR54 () () ()	3,718.	3,946.	4,914.	6,390.
			2/2	15"	60"	18 1/4"	APHOGR60 () () ()	3,756.	3,992.	4,972.	6,464.
			2/2	15"	66"	18 1/4"	APHOGR66 () () ()	4,183.	4,437.	5,528.	7,186.
			2/2	15"	72"	18 1/4"	APHOGR72 () () ()	4,606.	4,886.	6,086.	7,910.
2/2	15"		78"	18 1/4"	APHOGR78 () () ()	4,761.	5,049.	6,288.	8,174.		
2/2	15"		84"	18 1/4"	APHOGR84 () () ()	4,914.	5,215.	6,492.	8,439.		
2/2	15"		90"	18 1/4"	APHOGR90 () () ()	5,068.	5,379.	6,696.	8,703.		
2/2	15"	96"	18 1/4"	APHOGR96 () () ()	5,251.	5,576.	6,936.	9,017.			

Order Code	Specification Information	Application Notes
Example: APHOBR42V316GL6AA	<i>To order please specify pattern number including:</i>	Sliding doors are not available with locks.
A AutoStrada	1. Depth <i>B = Binder depth</i> <i>G = Legal depth</i>	Panel hung overhead storage units include hardware to hang unit on panels.
PH Panel hung	2. Sliding door material <i>S = wood, same as case</i>	
O Overhead	3. Width	Sliding door pulls included, not visible on image. When AA finish specified pull is complimentary painted match, pull is not anodized.
B Binder depth	4. Pull option: AR = AutoStrada Radius pull AB = AutoStrada Bar pull	
R Open/Sliding (glass) Door	5. Finish <i>Laminate, V1, V2 or V3</i>	See page 8 for finish options applicable.
42 42" wide	6. Finish, Glass sliding door <i>TEMP - Clear, tempered</i> <i>GL6 - Block Matrix</i> <i>GL13 - Powder</i>	Product on this page will accept wood grain laminate where laminate is currently an option.
AR Radius pull option	7. Finish, Glass sliding door frame and pull <i>Anodized aluminum or painted finish options listed on page 8 excluding silver.</i>	
V316 Finish, Maple		
GL6 Glass, Block Matrix		
AA Frame, anodized aluminum		

NOTE: Knoll does not assume any responsibility for the installation, attachment or the securing of wall hung units to the wall.

A certified building contractor should be consulted.

Please refer to wall mounting information on page 315 .

Overhead storage, wood cases

Shared open overhead mounting options

AutoStrada

description	type	h	pattern no.	paint
Mounting brackets for 64" h horizon on 48" h Service Wall or for 55" h horizon on 39" h Service Wall and 39" h Fence	For 24" w - 48" w overhead		AUOMBCC2 ()	\$105.
	For 54" w - 72" w overhead		AUOMBCC3 ()	138.
Mounting brackets for AutoStrada panels	For 24" w - 48" w overhead		AUOMBAP2 ()	67.
	For 54" w - 72" w overhead		AUOMBAP3 ()	100.
Stanchion upmount brackets for 49" h horizon on 28" h Fence or for 48" h horizon on 27" h Fence	For 24" w - 48" w overhead	6 1/2"	AUOMBSS62 ()	144.
	For 54" w - 72" w overhead	6 1/2"	AUOMBSS63 ()	192.
Stanchion upmount brackets for 49" h horizon on 27" h Fence	For 24" w - 48" w overhead	7 1/2"	AUOMBSS72 ()	149.
	For 54" w - 72" w overhead	7 1/2"	AUOMBSS73 ()	199.
Stanchion upmount brackets for 64" h horizon on 39" h Service Wall and 39" h Fence	For 24" w - 48" w overhead	9 1/2"	AUOMBSS92 ()	154.
	For 54" w - 72" w overhead	9 1/2"	AUOMBSS93 ()	210.

Order Code	Specification Information	Application Notes
Example: AUO MB CC 2 118		
A AutoStrada	Specify painted finish.	Shared open overhead mounting brackets for the Service Wall are designed for use on the compact crown only.
U Upmounted	6 1/2" h stanchions are for use on 28" h Fence for 49" h horizon or on 27" h Fence for 48" h horizon.	
O Overhead		
MB Mounting brackets	7 1/2" h stanchions are for use on 27" h Fence for 49" h horizon.	
CC Compact Crown		
2 Quantity of brackets	9 1/2" h stanchions are for use on 39" h Service Wall and 39" h Fence for 64" h horizon.	
118 Finish	Mounting brackets for 24" w - 48" w upmounted overheads come in a pair.	
	Mounting brackets for 54" w - 72" w upmounted overheads come in a quantity of 3.	
	9 1/2" h stanchions can only be used on 39" h Fence when Fence is supported by attached perpendicular panels or screens.	

Overhead storage, wood cases

Wall-attached overheads for private office

open, single high

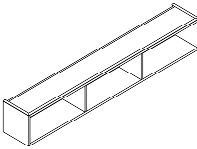
description	type	h	w	d	pattern no.	L	V1	V2	V3
 <p>96" w shown</p>	binder height & depth	15"	30"	14 1/4"	AWHOBSO30 () ()	\$1,760.	\$1,840.	\$2,118.	\$2,750.
		15"	36"	14 1/4"	AWHOBSO36 () ()	1,806.	1,888.	2,172.	2,820.
		15"	42"	14 1/4"	AWHOBSO42 () ()	1,854.	1,934.	2,228.	2,895.
		15"	48"	14 1/4"	AWHOBSO48 () ()	1,904.	1,987.	2,285.	2,971.
		15"	54"	14 1/4"	AWHOBSO54 () ()	2,002.	2,090.	2,409.	3,127.
		15"	60"	14 1/4"	AWHOBSO60 () ()	2,103.	2,192.	2,524.	3,282.
		15"	66"	14 1/4"	AWHOBSO66 () ()	2,163.	2,259.	2,595.	3,376.
		15"	72"	14 1/4"	AWHOBSO72 () ()	2,219.	2,322.	2,666.	3,467.
		15"	78"	14 1/4"	AWHOBSO78 () ()	2,331.	2,440.	2,801.	3,640.
		15"	84"	14 1/4"	AWHOBSO84 () ()	2,401.	2,512.	2,884.	3,749.
		15"	90"	14 1/4"	AWHOBSO90 () ()	2,473.	2,590.	2,969.	3,860.
		15"	96"	14 1/4"	AWHOBSO96 () ()	2,547.	2,664.	3,061.	4,295.

Units up to 36" w have one section, units 42" w up to 72" wide have two sections, over 72" w have three sections

binder height & legal depth	15"	30"	17 1/4"	AWHOGSO30 () ()	1,901.	1,988.	2,284.	2,970.
	15"	36"	17 1/4"	AWHOGSO36 () ()	1,952.	2,040.	2,344.	3,046.
	15"	42"	17 1/4"	AWHOGSO42 () ()	2,001.	2,090.	2,407.	3,127.
	15"	48"	17 1/4"	AWHOGSO48 () ()	2,057.	2,147.	2,470.	3,210.
	15"	54"	17 1/4"	AWHOGSO54 () ()	2,164.	2,257.	2,598.	3,379.
	15"	60"	17 1/4"	AWHOGSO60 () ()	2,271.	2,369.	2,725.	3,544.
	15"	66"	17 1/4"	AWHOGSO66 () ()	2,333.	2,440.	2,805.	3,645.
	15"	72"	17 1/4"	AWHOGSO72 () ()	2,398.	2,507.	2,880.	3,745.
	15"	78"	17 1/4"	AWHOGSO78 () ()	2,518.	2,634.	3,026.	3,931.
	15"	84"	17 1/4"	AWHOGSO84 () ()	2,594.	2,715.	3,115.	4,051.
	15"	90"	17 1/4"	AWHOGSO90 () ()	2,672.	2,794.	3,208.	4,172.
	15"	96"	17 1/4"	AWHOGSO96 () ()	2,751.	2,878.	3,305.	4,295.

Units up to 36" w have one section, units 42" w up to 72" w have two sections, over 72" wide have three sections

Order Code	Specification Information	Application Notes
Example: AWHOBSO30V316AA	To order please specify pattern number including:	Wood cleat included for wall mounting. Two piece cleat, full width of overhead. Each piece nominally 3 5/8" h. Bottom piece attached to wall.
A AutoStrada	1. Depth B = Binder depth G = Legal depth	Single high overhead storage to be mounted at 68 1/2" from floor to top of overhead unit. Dimension is to top of wood side gable of corresponding 70" h floor standing cabinet not including aluminum and wood top trim.
WH Wall hung	2. Width	
O Overhead	3. Finish Laminate, V1, V2 or V3	
B Binder depth	4. Finish, aluminum trim Anodized aluminum or painted finish options listed on page 8 excluding silver.	
S Single high		NOTE: Knoll does not assume any responsibility for the installation, attachment or the securing of wall hung units to the wall.
O Open		A certified building contractor should be consulted.
30 30" wide		Please refer to wall mounting information on page 315 .
V316 Finish, Maple		
AA Finish, Aluminum trim		

See page 8 for finish options applicable.

Product on this page will accept wood grain laminate where laminate is currently an option.

Overhead storage, wood cases

Wall-attached overheads for private office

hinged door, single high

description	type	# drs/locks	h	w	d	pattern no.	L	V1	V2	V3	
Wall hung overhead Hinged doors (wood) single high	binder height and depth	2/1	15"	30"	15 1/4"	AWHOBSD30 () ()	\$2,563.	\$2,673.	\$3,073.	\$3,996.	
		2/1	15"	36"	15 1/4"	AWHOBSD36 () ()	2,705.	2,828.	3,251.	4,226.	
		3/2	15"	42"	15 1/4"	AWHOBSD42 () ()	2,726.	2,850.	3,275.	4,258.	
		3/2	15"	48"	15 1/4"	AWHOBSD48 () ()	2,781.	2,901.	3,339.	4,340.	
		3/2	15"	54"	15 1/4"	AWHOBSD54 () ()	2,923.	3,052.	3,514.	4,566.	
		4/2	15"	60"	15 1/4"	AWHOBSD60 () ()	3,063.	3,195.	3,675.	4,781.	
		4/2	15"	66"	15 1/4"	AWHOBSD66 () ()	3,153.	3,296.	3,789.	4,928.	
		4/2	15"	72"	15 1/4"	AWHOBSD72 () ()	3,241.	3,383.	3,892.	5,058.	
		5/3	15"	78"	15 1/4"	AWHOBSD78 () ()	3,404.	3,561.	4,088.	5,314.	
		5/3	15"	84"	15 1/4"	AWHOBSD84 () ()	3,506.	3,669.	4,210.	5,475.	
		6/3	15"	90"	15 1/4"	AWHOBSD90 () ()	3,611.	3,778.	4,337.	5,640.	
		6/3	15"	96"	15 1/4"	AWHOBSD96 () ()	3,720.	3,892.	4,468.	5,806.	
		binder height and legal depth	2/1	15"	30"	18 1/4"	AWHOGSD30 () ()	2,766.	2,886.	3,320.	4,315.
			2/1	15"	36"	18 1/4"	AWHOGSD36 () ()	2,922.	3,056.	3,513.	4,564.
			3/2	15"	42"	18 1/4"	AWHOGSD42 () ()	2,942.	3,075.	3,537.	4,599.
3/2	15"		48"	18 1/4"	AWHOGSD48 () ()	3,002.	3,131.	3,607.	4,690.		
3/2	15"		54"	18 1/4"	AWHOGSD54 () ()	3,158.	3,295.	3,793.	4,932.		
4/2	15"		60"	18 1/4"	AWHOGSD60 () ()	3,307.	3,452.	3,971.	5,163.		
4/2	15"		66"	18 1/4"	AWHOGSD66 () ()	3,406.	3,560.	4,092.	5,321.		
4/2	15"		72"	18 1/4"	AWHOGSD72 () ()	3,501.	3,654.	4,204.	5,464.		
5/3	15"		78"	18 1/4"	AWHOGSD78 () ()	3,676.	3,847.	4,415.	5,740.		
5/3	15"		84"	18 1/4"	AWHOGSD84 () ()	3,787.	3,963.	4,546.	5,912.		
6/3	15"		90"	18 1/4"	AWHOGSD90 () ()	3,900.	4,080.	4,685.	6,090.		
6/3	15"		96"	18 1/4"	AWHOGSD96 () ()	4,015.	4,204.	4,826.	6,272.		

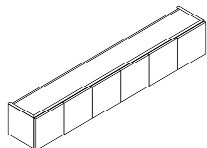

96" w shown

Order Code	Specification Information	Application Notes
Example: AWHOBSD30LV316AA	<i>To order please specify pattern number including:</i>	Single high overhead storage to be mounted at 68 1/2" from floor to top of overhead unit. Dimension is to top of wood side gable of corresponding 70" h floor standing cabinet not including aluminum and wood top trim.
A AutoStrada	1. Depth <i>B = Binder depth</i> <i>G = Legal depth</i>	Wood cleat included for wall mounting. Two piece cleat, full width of overhead. Each piece nominally 3 3/8" h. Bottom piece attached to wall.
WH Wall hung	2. Width	NOTE: Knoll does not assume any responsibility for the installation, attachment or the securing of wall hung units to the wall.
O Overhead	3. Lock <i>L = lock hole drilled</i> <i>N = not drilled for locks</i>	A certified building contractor should be consulted.
B Binder depth	4. Finish <i>Laminate, V1, V2 or V3</i>	Please refer to wall mounting information on page 315.
S Single high	5. Finish, aluminum trim <i>Anodized aluminum or painted finish options listed on page 8 excluding silver.</i>	Optional lock drilling to be specified. If drilled for locks selected, keying instructions must accompany order.
D Hinged doors, wood	See page 8 for finish options applicable.	
30 30" wide	Product on this page will accept wood grain laminate where laminate is currently an option.	
L Lock holes drilled		
V316 Finish, Maple		
AA Finish, Aluminum trim		

Overhead storage, wood cases

Wall-attached overheads for private office

open / hinged door / open, single high

description	type	h	w	d	pattern no.	L	V1	V2	V3
Wall hung overhead Open/Hinged doors (wood) single high	binder height & depth	15"	60"	15 1/4"	AWHOBST60 () ()	\$2,208.	\$2,303.	\$2,649.	\$3,448.
		15"	66"	15 1/4"	AWHOBST66 () ()	2,270.	2,371.	2,725.	3,542.
		15"	72"	15 1/4"	AWHOBST72 () ()	2,331.	2,440.	2,801.	3,640.
		15"	78"	15 1/4"	AWHOBST78 () ()	2,447.	2,560.	2,941.	3,823.
		15"	84"	15 1/4"	AWHOBST84 () ()	2,521.	2,636.	3,028.	3,936.
		15"	90"	15 1/4"	AWHOBST90 () ()	2,596.	2,718.	3,118.	4,055.
		15"	96"	15 1/4"	AWHOBST96 () ()	2,676.	2,800.	3,213.	4,178.
96" w shown	binder height & legal depth	15"	60"	18 1/4"	AWHOGST60 () ()	2,386.	2,487.	2,861.	3,719.
		15"	66"	18 1/4"	AWHOGST66 () ()	2,452.	2,559.	2,943.	3,827.
		15"	72"	18 1/4"	AWHOGST72 () ()	2,518.	2,634.	3,026.	3,931.
		15"	78"	18 1/4"	AWHOGST78 () ()	2,645.	2,765.	3,173.	4,128.
		15"	84"	18 1/4"	AWHOGST84 () ()	2,722.	2,850.	3,272.	4,250.
		15"	90"	18 1/4"	AWHOGST90 () ()	2,807.	2,935.	3,369.	4,378.
		15"	96"	18 1/4"	AWHOGST96 () ()	2,888.	3,024.	3,470.	4,510.

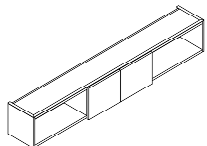

Order Code	Specification Information	Application Notes
Example: AWHOBST60LV316AA	<i>To order please specify pattern number including:</i>	Single high overhead storage to be mounted at 68 1/2" from floor to top of overhead unit. Dimension is to top of wood side gable of corresponding 70" h floor standing cabinet not including aluminum and wood top trim.
A AutoStrada	1. Depth <i>B = Binder depth</i> <i>G = Legal depth</i>	Wood cleat included for wall mounting. Two piece cleat, full width of overhead. Each piece nominally 3 3/8" h. Bottom piece attached to wall.
WH Wall hung	2. Width	NOTE: Knoll does not assume any responsibility for the installation, attachment or the securing of wall hung units to the wall.
O Overhead	3. Lock <i>L = lock hole drilled</i> <i>N = not drilled for locks</i>	A certified building contractor should be consulted.
B Binder depth	4. Finish <i>Laminate, V1, V2 or V3</i>	Please refer to wall mounting information on page 315.
S Single high	5. Finish, aluminum trim <i>Anodized aluminum or painted finish options listed on page 8 excluding silver.</i>	Optional lock drilling to be specified. If drilled for locks selected, keying instructions must accompany order.
T Open/Hinged doors/Open	See page 8 for finish options applicable.	
60 60" wide	Product on this page will accept wood grain laminate where laminate is currently an option.	
L Lock holes drilled		
V316 Finish, Maple		
AA Finish, Aluminum trim		

Overhead storage, wood cases

Wall-attached overheads for private office with sliding door(s), single high

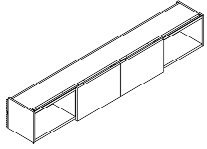
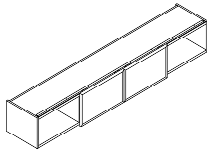
description	type	h	w	d	pattern no.	L	V1	V2	V3
Wall hung overhead Open/Sliding door(s) wood single high  96" w shown	binder height and depth	15"	60"	15 1/4"	AWHOBSS60 () () ()	\$3,152.	\$3,354.	\$4,242.	\$5,515.
		15"	66"	15 1/4"	AWHOBSS66 () () ()	3,243.	3,453.	4,362.	5,667.
		15"	72"	15 1/4"	AWHOBSS72 () () ()	3,332.	3,556.	4,480.	5,823.
		15"	78"	15 1/4"	AWHOBSS78 () () ()	3,498.	3,732.	4,707.	6,115.
		15"	84"	15 1/4"	AWHOBSS84 () () ()	3,600.	3,844.	4,845.	6,300.
		15"	90"	15 1/4"	AWHOBSS90 () () ()	3,710.	3,961.	4,990.	6,490.
		15"	96"	15 1/4"	AWHOBSS96 () () ()	3,820.	4,077.	5,140.	6,685.
	binder height and legal depth	15"	60"	18 1/4"	AWHOGSS60 () () ()	3,404.	3,625.	4,582.	5,955.
		15"	66"	18 1/4"	AWHOGSS66 () () ()	3,502.	3,732.	4,710.	6,122.
		15"	72"	18 1/4"	AWHOGSS72 () () ()	3,595.	3,838.	4,840.	6,289.
		15"	78"	18 1/4"	AWHOGSS78 () () ()	3,777.	4,031.	5,080.	6,604.
		15"	84"	18 1/4"	AWHOGSS84 () () ()	3,889.	4,153.	5,231.	6,804.
		15"	90"	18 1/4"	AWHOGSS90 () () ()	4,007.	4,276.	5,387.	7,008.
		15"	96"	18 1/4"	AWHOGSS96 () () ()	4,128.	4,404.	5,555.	7,218.
Wall hung overhead Open/Sliding door(s) glass single high  96" w shown	binder height and depth	15"	60"	15 1/4"	AWHOBSR60 () () ()	3,762.	3,992.	4,973.	5,970.
		15"	66"	15 1/4"	AWHOBSR66 () () ()	3,869.	4,110.	5,116.	6,136.
		15"	72"	15 1/4"	AWHOBSR72 () () ()	3,973.	4,228.	5,254.	6,304.
		15"	78"	15 1/4"	AWHOBSR78 () () ()	4,174.	4,442.	5,517.	6,622.
		15"	84"	15 1/4"	AWHOBSR84 () () ()	4,297.	4,576.	5,683.	6,818.
		15"	90"	15 1/4"	AWHOBSR90 () () ()	4,426.	4,710.	5,852.	7,024.
		15"	96"	15 1/4"	AWHOBSR96 () () ()	4,561.	4,852.	6,027.	7,234.
	binder height and legal depth	15"	60"	18 1/4"	AWHOGSR60 () () ()	4,061.	4,311.	5,372.	6,446.
		15"	66"	18 1/4"	AWHOGSR66 () () ()	4,179.	4,437.	5,522.	6,628.
		15"	72"	18 1/4"	AWHOGSR72 () () ()	4,290.	4,565.	5,673.	6,810.
		15"	78"	18 1/4"	AWHOGSR78 () () ()	4,506.	4,798.	5,958.	7,150.
		15"	84"	18 1/4"	AWHOGSR84 () () ()	4,640.	4,940.	6,136.	7,363.
		15"	90"	18 1/4"	AWHOGSR90 () () ()	4,781.	5,086.	6,321.	7,586.
		15"	96"	18 1/4"	AWHOGSR96 () () ()	4,925.	5,241.	6,508.	7,812.

Order Code	Specification Information
Example: AWHOBSS60V316AA	
A AutoStrada	
WH Wall hung	
O Overhead	
B Binder depth	
S Single high	
S Open/Sliding door(s)/wood	
60 60" wide	
AR Radius pull option	
V316 Finish, Maple	
AA Finish, Aluminum trim	

Specification Information
To order please specify pattern number including:
1. Depth B = Binder depth G = Legal depth
2. Sliding door material S = wood, same as case R = glass
3. Width
4. Pull options for Glass doors (as applicable) AR=AutoStrada Radius pull AB=AutoStrada Bar pull
5. Finish Laminate, V1, V2 or V3
6. Finish, Glass sliding door (as applicable) TEMP - Clear, tempered GL6 - Block Matrix GL13 - Powder
7. Finish, Glass sliding door frame and pull (as applicable) Anodized aluminum or painted finish options listed on page 8 excluding silver.

Application Notes
Wood cleat included for wall mounting. Two piece cleat, full width of overhead. Each piece nominally 3 5/8" h. Bottom piece attached to wall.
Sliding doors are not available with locks. When AA finish specified pull is complimentary painted match, pull is not anodized.
See page 8 for finish options applicable.
Product on this page will accept wood grain laminate where laminate is currently an option.

Single high overhead storage to be mounted at 68 1/2" from floor to top of overhead unit. Dimension is to top of wood side gable of corresponding 70" h floor standing cabinet not including aluminum and wood top trim.

Sliding door pulls included, not visible on image.

NOTE: Knoll does not assume any responsibility for the installation, attachment or the securing of wall hung units to the wall.

A certified building contractor should be consulted.

Please refer to wall mounting information on page 315.

Overhead storage, wood cases

Wall-attached overheads for private office

open, double high

description	type	h	w	d	pattern no.	L	V1	V2	V3
Wall hung overhead open, double high	binder height & depth	29"	30"	14 1/4"	AWHOBDO30 () ()	\$2,375.	\$2,486.	\$2,857.	\$3,714.
		29"	36"	14 1/4"	AWHOBDO36 () ()	2,439.	2,550.	2,930.	3,812.
		29"	42"	14 1/4"	AWHOBDO42 () ()	2,502.	2,614.	3,007.	3,909.
		29"	48"	14 1/4"	AWHOBDO48 () ()	2,569.	2,682.	3,089.	4,012.
		29"	54"	14 1/4"	AWHOBDO54 () ()	2,703.	2,819.	3,249.	4,223.
		29"	60"	14 1/4"	AWHOBDO60 () ()	2,840.	2,959.	3,406.	4,430.
		29"	66"	14 1/4"	AWHOBDO66 () ()	2,916.	3,046.	3,503.	4,554.
		29"	72"	14 1/4"	AWHOBDO72 () ()	2,997.	3,137.	3,600.	4,681.
		29"	78"	14 1/4"	AWHOBDO78 () ()	3,147.	3,294.	3,781.	4,914.
		29"	84"	14 1/4"	AWHOBDO84 () ()	3,243.	3,391.	3,894.	5,063.
		29"	90"	14 1/4"	AWHOBDO90 () ()	3,337.	3,493.	4,009.	5,215.
		29"	96"	14 1/4"	AWHOBDO96 () ()	3,438.	3,599.	4,133.	5,800.

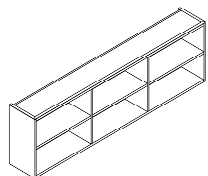

96" w shown

units up to 36" w have one section, 42" w up to 72" w have two sections, over 72" w have three sections

binder height & legal depth	h	w	d	pattern no.	L	V1	V2	V3
binder height & legal depth	29"	30"	17 1/4"	AWHOGDO30 () ()	2,566.	2,683.	3,087.	4,010.
	29"	36"	17 1/4"	AWHOGDO36 () ()	2,636.	2,753.	3,166.	4,113.
	29"	42"	17 1/4"	AWHOGDO42 () ()	2,702.	2,820.	3,248.	4,222.
	29"	48"	17 1/4"	AWHOGDO48 () ()	2,777.	2,896.	3,335.	4,334.
	29"	54"	17 1/4"	AWHOGDO54 () ()	2,919.	3,045.	3,508.	4,558.
	29"	60"	17 1/4"	AWHOGDO60 () ()	3,065.	3,195.	3,683.	4,784.
	29"	66"	17 1/4"	AWHOGDO66 () ()	3,151.	3,293.	3,785.	4,918.
	29"	72"	17 1/4"	AWHOGDO72 () ()	3,238.	3,388.	3,889.	5,055.
	29"	78"	17 1/4"	AWHOGDO78 () ()	3,399.	3,558.	4,082.	5,308.
	29"	84"	17 1/4"	AWHOGDO84 () ()	3,502.	3,663.	4,206.	5,469.
	29"	90"	17 1/4"	AWHOGDO90 () ()	3,607.	3,774.	4,331.	5,632.
	29"	96"	17 1/4"	AWHOGDO96 () ()	3,714.	3,888.	4,462.	5,800.

units up to 36" w have one section, 42" w up to 72" w have two sections, over 72" w have three sections

Order Code	Specification Information	Application Notes
Example: AWHOBDO30V316AA	To order please specify pattern number including:	Wood cleat included for wall mounting. Two piece cleat, full width of overhead. Each piece nominally 3 5/8" h. Bottom piece attached to wall.
A AutoStrada	1. Depth B = Binder depth G = Legal depth	Double high overhead storage to be mounted at 82-5/16" from floor to top of overhead unit. Dimension is to top of wood side gable of corresponding 84" h floor standing cabinet not including aluminum and wood top trim.
WH Wall hung	2. Width	
O Overhead	3. Finish Laminate, V1, V2 or V3	
B Binder depth	4. Finish, aluminum trim Anodized aluminum or painted finish options listed on page 8 excluding silver.	
D Double high		NOTE: Knoll does not assume any responsibility for the installation, attachment or the securing of wall hung units to the wall.
O Open		A certified building contractor should be consulted.
30 30" wide		Please refer to wall mounting information on page 315 .
V316 Finish, Maple		
AA Finish, Aluminum trim		

See page 8 for finish options applicable.

Product on this page will accept wood grain laminate where laminate is currently an option.

Overhead storage, wood cases

Wall-attached overheads for private office

hinged door, double high

description	type	# drs/locks	h	w	d	pattern no.	L	V1	V2	V3	
Wall hung overhead Hinged doors (wood) double high	binder height and depth	2/1	29"	30"	15 1/4"	AWHOBDD30 () ()	\$3,457.	\$3,609.	\$4,150.	\$5,394.	
		2/1	29"	36"	15 1/4"	AWHOBDD36 () ()	3,654.	3,816.	4,389.	5,705.	
		3/2	29"	42"	15 1/4"	AWHOBDD42 () ()	3,681.	3,845.	4,422.	5,747.	
		3/2	29"	48"	15 1/4"	AWHOBDD48 () ()	3,751.	3,917.	4,508.	5,862.	
		3/2	29"	54"	15 1/4"	AWHOBDD54 () ()	3,948.	4,118.	4,740.	6,165.	
		4/2	29"	60"	15 1/4"	AWHOBDD60 () ()	4,136.	4,316.	4,964.	6,454.	
		4/2	29"	66"	15 1/4"	AWHOBDD66 () ()	4,259.	4,449.	5,117.	6,650.	
		4/2	29"	72"	15 1/4"	AWHOBDD72 () ()	4,375.	4,566.	5,254.	6,829.	
		5/3	29"	78"	15 1/4"	AWHOBDD78 () ()	4,596.	4,808.	5,520.	7,174.	
		5/3	29"	84"	15 1/4"	AWHOBDD84 () ()	4,732.	4,950.	5,688.	7,390.	
		6/3	29"	90"	15 1/4"	AWHOBDD90 () ()	4,874.	5,100.	5,856.	7,612.	
		6/3	29"	96"	15 1/4"	AWHOBDD96 () ()	5,022.	5,254.	6,029.	7,841.	
		binder height and legal depth	2/1	29"	30"	18 1/4"	AWHOGDD30 () ()	3,734.	3,896.	4,480.	5,823.
			2/1	29"	36"	18 1/4"	AWHOGDD36 () ()	3,944.	4,119.	4,739.	6,161.
3/2	29"		42"	18 1/4"	AWHOGDD42 () ()	3,974.	4,154.	4,774.	6,206.		
3/2	29"		48"	18 1/4"	AWHOGDD48 () ()	4,054.	4,229.	4,869.	6,332.		
3/2	29"		54"	18 1/4"	AWHOGDD54 () ()	4,263.	4,448.	5,121.	6,657.		
4/2	29"		60"	18 1/4"	AWHOGDD60 () ()	4,465.	4,663.	5,360.	6,968.		
4/2	29"		66"	18 1/4"	AWHOGDD66 () ()	4,601.	4,806.	5,527.	7,181.		
4/2	29"		72"	18 1/4"	AWHOGDD72 () ()	4,723.	4,933.	5,672.	7,374.		
5/3	29"		78"	18 1/4"	AWHOGDD78 () ()	4,960.	5,191.	5,961.	7,751.		
5/3	29"		84"	18 1/4"	AWHOGDD84 () ()	5,111.	5,350.	6,139.	7,983.		
6/3	29"		90"	18 1/4"	AWHOGDD90 () ()	5,263.	5,508.	6,323.	8,220.		
6/3	29"		96"	18 1/4"	AWHOGDD96 () ()	5,423.	5,672.	6,512.	8,468.		

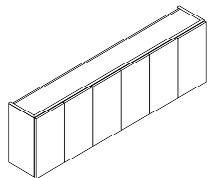

96" w shown

Order Code	Specification Information	Application Notes
Example: AWHOBDD30LV316AA	<i>To order please specify pattern number including:</i>	Double high overhead storage to be mounted at 82-5/16" from floor to top of overhead unit. Dimension is to top of wood side gable of corresponding 84" h floor standing cabinet not including aluminum and wood top trim.
A AutoStrada	1. Depth <i>B = Binder depth</i> <i>G = Legal depth</i>	Wood cleat included for wall mounting. Two piece cleat, full width of overhead. Each piece nominally 3 7/8" h. Bottom piece attached to wall.
WH Wall hung	2. Width	NOTE: Knoll does not assume any responsibility for the installation, attachment or the securing of wall hung units to the wall.
O Overhead	3. Lock <i>L = lock hole drilled</i> <i>N = not drilled for locks</i>	A certified building contractor should be consulted.
B Binder depth	4. Finish <i>Laminate, V1, V2 or V3</i>	Please refer to wall mounting information on page 315 .
D Double high	5. Finish, aluminum trim <i>Anodized aluminum or painted finish options listed on page 8 excluding silver.</i>	
D Hinged doors, wood		
30 30" wide		
L Lock holes drilled		
V316 Finish, Maple		
AA Finish, Aluminum trim		

See page 8 for finish options applicable.

Product on this page will accept wood grain laminate where laminate is currently an option.

Overhead storage, wood cases

Wall-attached overheads for private office

open / hinged door / open, double high

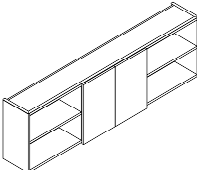
description	type	h	w	d	pattern no.	L	V1	V2	V3
Wall hung overhead Open/Hinged doors (wood) double high 	binder height & depth	29"	60"	15 1/4"	AWHOBDT60 () ()	\$2,981.	\$3,109.	\$3,578.	\$4,652.
		29"	66"	15 1/4"	AWHOBDT66 () ()	3,065.	3,200.	3,678.	4,783.
		29"	72"	15 1/4"	AWHOBDT72 () ()	3,147.	3,294.	3,781.	4,914.
		29"	78"	15 1/4"	AWHOBDT78 () ()	3,305.	3,459.	3,969.	5,159.
		29"	84"	15 1/4"	AWHOBDT84 () ()	3,402.	3,561.	4,088.	5,314.
		29"	90"	15 1/4"	AWHOBDT90 () ()	3,506.	3,669.	4,210.	5,475.
		29"	96"	15 1/4"	AWHOBDT96 () ()	3,610.	3,778.	4,337.	5,640.
	binder height & legal depth	29"	60"	18 1/4"	AWHOGDT60 () ()	3,218.	3,356.	3,866.	5,024.
		29"	66"	18 1/4"	AWHOGDT66 () ()	3,307.	3,459.	3,973.	5,166.
		29"	72"	18 1/4"	AWHOGDT72 () ()	3,399.	3,558.	4,082.	5,308.
		29"	78"	18 1/4"	AWHOGDT78 () ()	3,568.	3,737.	4,287.	5,574.
		29"	84"	18 1/4"	AWHOGDT84 () ()	3,676.	3,847.	4,415.	5,740.
		29"	90"	18 1/4"	AWHOGDT90 () ()	3,787.	3,963.	4,546.	5,912.
29"		96"	18 1/4"	AWHOGDT96 () ()	3,900.	4,080.	4,685.	6,090.	

Order Code	Specification Information	Application Notes
Example: AWHOBDT60LV316AA	<i>To order please specify pattern number including:</i>	Double high overhead storage to be mounted at 82-5/16" from floor to top of overhead unit. Dimension is to top of wood side gable of corresponding 84" h floor standing cabinet not including aluminum and wood top trim.
A AutoStrada	1. Depth <i>B = Binder depth</i> <i>G = Legal depth</i>	Wood cleat included for wall mounting. Two piece cleat, full width of overhead. Each piece nominally 3 3/8" h. Bottom piece attached to wall.
WH Wall hung	2. Width	
O Overhead	3. Lock <i>L = lock hole drilled</i> <i>N = not drilled for locks</i>	NOTE: Knoll does not assume any responsibility for the installation, attachment or the securing of wall hung units to the wall.
B Binder depth	4. Finish <i>Laminate, V1, V2 or V3</i>	
D Double high	5. Finish, aluminum trim <i>Anodized aluminum or painted finish options listed on page 8 excluding silver.</i>	A certified building contractor should be consulted.
T Open/Hinged doors/Open	See page 8 for finish options applicable.	Please refer to wall mounting information on page 315.
60 60" wide	Product on this page will accept wood grain laminate where laminate is currently an option.	Optional lock drilling to be specified. If drilled for locks selected, keying instructions must accompany order.
L Lock holes drilled		
V316 Finish, Maple		
AA Finish, Aluminum trim		

Overhead storage, wood cases

Wall-attached overheads for private office with sliding door(s), double high

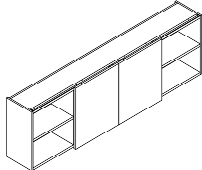
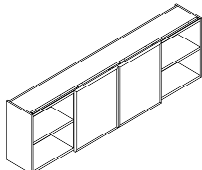
description	type	h	w	d	pattern no.	L	V1	V2	V3
Wall hung overhead Open/Sliding door(s) wood double high  96" w shown	binder height and depth	29"	60"	15 1/4"	AWHOBDS60 () () ()	\$4,256.	\$4,530.	\$5,726.	\$7,443.
		29"	66"	15 1/4"	AWHOBDS66 () () ()	4,376.	4,664.	5,886.	7,654.
		29"	72"	15 1/4"	AWHOBDS72 () () ()	4,495.	4,800.	6,048.	7,861.
		29"	78"	15 1/4"	AWHOBDS78 () () ()	4,720.	5,039.	6,350.	8,258.
		29"	84"	15 1/4"	AWHOBDS84 () () ()	4,862.	5,189.	6,541.	8,505.
		29"	90"	15 1/4"	AWHOBDS90 () () ()	5,008.	5,344.	6,738.	8,760.
	binder height and legal depth	29"	60"	18 1/4"	AWHOGDS60 () () ()	4,598.	4,892.	6,184.	8,038.
		29"	66"	18 1/4"	AWHOGDS66 () () ()	4,725.	5,038.	6,360.	8,266.
		29"	72"	18 1/4"	AWHOGDS72 () () ()	4,857.	5,182.	6,531.	8,495.
		29"	78"	18 1/4"	AWHOGDS78 () () ()	5,099.	5,441.	6,859.	8,917.
		29"	84"	18 1/4"	AWHOGDS84 () () ()	5,252.	5,602.	7,066.	9,185.
		29"	90"	18 1/4"	AWHOGDS90 () () ()	5,410.	5,775.	7,278.	9,460.
		29"	96"	18 1/4"	AWHOGDS96 () () ()	5,571.	5,947.	7,495.	9,745.
		Wall hung overhead Open/Sliding door(s) glass double high  96" w shown	binder height and depth	29"	60"	15 1/4"	AWHOBDR60 () () ()	5,080.	5,386.
29"	66"			15 1/4"	AWHOBDR66 () () ()	5,223.	5,548.	6,905.	8,285.
29"	72"			15 1/4"	AWHOBDR72 () () ()	5,365.	5,708.	7,094.	8,510.
29"	78"			15 1/4"	AWHOBDR78 () () ()	5,635.	5,992.	7,446.	8,939.
29"	84"			15 1/4"	AWHOBDR84 () () ()	5,804.	6,172.	7,671.	9,206.
29"	90"			15 1/4"	AWHOBDR90 () () ()	5,977.	6,360.	7,901.	9,482.
binder height and legal depth	29"		60"	18 1/4"	AWHOGDR60 () () ()	5,485.	5,819.	7,252.	8,702.
	29"		66"	18 1/4"	AWHOGDR66 () () ()	5,640.	5,990.	7,456.	8,947.
	29"		72"	18 1/4"	AWHOGDR72 () () ()	5,793.	6,165.	7,660.	9,193.
	29"		78"	18 1/4"	AWHOGDR78 () () ()	6,084.	6,472.	8,043.	9,652.
	29"		84"	18 1/4"	AWHOGDR84 () () ()	6,267.	6,667.	8,285.	9,942.
	29"		90"	18 1/4"	AWHOGDR90 () () ()	6,454.	6,866.	8,531.	10,242.
	29"		96"	18 1/4"	AWHOGDR96 () () ()	6,648.	7,072.	8,790.	10,546.

Order Code	Specification Information
Example: AWHOBDS60V316AA	
A AutoStrada	
WH Wall hung	
O Overhead	
B Binder depth	
D Double high	
S Open/Sliding door(s)/wood	
60 60" wide	
AR Radius pull option	
V316 Finish, Maple	
AA Finish, Aluminum trim	

Specification Information
To order please specify pattern number including:
1. Depth B = Binder depth G = Legal depth
2. Sliding door material S = wood, same as case R = glass
3. Width
4. Pull options for Glass doors (as applicable) AR=AutoStrada Radius pull AB=AutoStrada Bar pull
5. Finish Laminate, V1, V2 or V3
6. Finish, Glass sliding door (as applicable) TEMP - Clear, tempered GL6 - Block Matrix GL13 - Powder
7. Finish, Glass sliding door frame and pull (as applicable) Anodized aluminum or painted finish options listed on page 8 excluding silver.

Application Notes
Wood cleat included for wall mounting. Two piece cleat, full width of overhead. Each piece nominally 3 5/8" h. Bottom piece attached to wall.
Sliding doors are not available with locks. When AA finish specified pull is complimentary painted match, pull is not anodized.
See page 8 for finish options applicable.
Product on this page will accept wood grain laminate where laminate is currently an option.
Double high overhead storage to be mounted at 82-5/16" from floor to top of overhead unit. Dimension is to top of wood side gable of corresponding 84" h floor standing cabinet not including aluminum and wood top trim.
Sliding door pulls included, not visible on image.
NOTE: Knoll does not assume any responsibility for the installation, attachment or the securing of wall hung units to the wall.
A certified building contractor should be consulted.
Please refer to wall mounting information on page 315.

Reuter flat front overhead cabinet
flat front
Designed by Robert Reuter

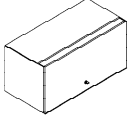
description	w	d	h	pattern no.	P1/P2/P3	L	V1	V2	V3
Enclosed cabinet (no mounting hardware) - One door, no pull, no lock 	30"	14 1/4"	14 3/4"	RO3-A30NN () () ()	n/a	\$1,162.	\$1,264.	\$1,320.	\$1,598.
	36"	14 1/4"	14 3/4"	RO3-A36NN () () ()	n/a	1,319.	1,466.	1,543.	1,969.
	42"	14 1/4"	14 3/4"	RO3-A42NN () () ()	n/a	1,498.	1,699.	1,815.	2,432.
	48"	14 1/4"	14 3/4"	RO3-A48NN () () ()	n/a	1,691.	1,840.	1,976.	2,821.
Enclosed cabinet (no mounting hardware) - Two doors, no pull, no lock	60"	14 1/4"	14 3/4"	RO3-A60NN () () ()	n/a	2,253.	2,352.	2,474.	3,064.
	72"	14 1/4"	14 3/4"	RO3-A72NN () () ()	n/a	2,545.	2,728.	2,896.	3,799.
Enclosed cabinet (no mounting hardware) - One door, no pull, with lock	30"	14 1/4"	14 3/4"	RO3-A30NL () () ()	1,161.	1,236.	1,340.	1,394.	1,671.
	36"	14 1/4"	14 3/4"	RO3-A36NL () () ()	1,299.	1,393.	1,540.	1,620.	2,043.
	42"	14 1/4"	14 3/4"	RO3-A42NL () () ()	1,442.	1,574.	1,779.	1,889.	2,509.
	48"	14 1/4"	14 3/4"	RO3-A48NL () () ()	1,680.	1,765.	1,916.	2,050.	2,896.
Enclosed cabinet (no mounting hardware) - Two doors, no pull, with lock	60"	14 1/4"	14 3/4"	RO3-A60NL () () ()	2,230.	2,401.	2,499.	2,623.	3,217.
	72"	14 1/4"	14 3/4"	RO3-A72NL () () ()	2,521.	2,693.	2,879.	3,043.	3,946.
Enclosed cabinet (no mounting hardware) - One door, with pull, no lock	30"	14 1/4"	14 3/4"	RO3-A30PN () () ()	n/a	1,378.	1,481.	1,536.	1,814.
	36"	14 1/4"	14 3/4"	RO3-A36PN () () ()	n/a	1,537.	1,686.	1,761.	2,188.
	42"	14 1/4"	14 3/4"	RO3-A42PN () () ()	n/a	1,721.	1,924.	2,035.	2,653.
	48"	14 1/4"	14 3/4"	RO3-A48PN () () ()	n/a	1,917.	2,068.	2,203.	3,048.
Enclosed cabinet (no mounting hardware) - Two doors, with pull, no lock	60"	14 1/4"	14 3/4"	RO3-A60PN () () ()	n/a	2,684.	2,783.	2,905.	3,496.
	72"	14 1/4"	14 3/4"	RO3-A72PN () () ()	n/a	2,978.	3,164.	3,329.	4,234.
Enclosed cabinet (no mounting hardware) - One door, with pull, with lock	30"	14 1/4"	14 3/4"	RO3-A30PL () () ()	1,374.	1,452.	1,555.	1,611.	1,887.
	36"	14 1/4"	14 3/4"	RO3-A36PL () () ()	1,517.	1,612.	1,759.	1,836.	2,263.
	42"	14 1/4"	14 3/4"	RO3-A42PL () () ()	1,661.	1,794.	1,997.	2,110.	2,726.
	48"	14 1/4"	14 3/4"	RO3-A48PL () () ()	1,902.	1,991.	2,143.	2,279.	3,122.
Enclosed cabinet (no mounting hardware) - Two doors, with pull, with lock	60"	14 1/4"	14 3/4"	RO3-A60PL () () ()	2,660.	2,833.	2,931.	3,053.	3,646.
	60"	14 1/4"	14 3/4"	RO3-A72PL () () ()	2,955.	3,128.	3,315.	3,479.	4,380.

Order Code	Specification Information	Application Notes
Example: RO3-A30PL-117-V-H-Y316 AA	Specify mounting hardware separately.	Reuter storage is a universal product applicable Knoll systems.
RO3 Reuter overhead	Optional anodized aluminum or painted front pull trims the entire width of cabinet door.	Cabinet door rotates above cabinet on side pivots, counterbalanced by two pneumatic cylinders. Two-door cabinets have center divider and four pneumatic cylinders. Vertical interior partitions may be positioned on 1 1/2" increments of width anywhere across shelf, 1 1/2" in from each side. Vertical partitions contain cutouts for mounting up to five horizontal partitions at 2" increments on either or both sides.
A flat front	<i>Specify paint finishes for case. Finish types for front:</i>	Horizontals are suspended between two verticals, and may be positioned end-to-end in any combination up to 3" less than cabinet width. Available in sets of 10; 6", 9", 12", 15" widths.
30 width	L laminate	Order locks for overheads with a KnollKey order form. Please note that Reuter overhead cabinets 60"W or wider require two lock cores.
P with pull	P paint	
L with lock	V veneer or techwood	
117 case finish	Specify grain direction for veneer fronts.	
V front finish type		
H front grain direction		
Y316 front color		
AA pull finish		

Please refer to the AutoStrada price list for finishes available on Reuter Flat Front overhead cabinets fronts.

description	type	width	depth	height	pattern number	black	paint
Reuter overhead downmount brackets	For 64"H spine				AA1ARODN()		\$236.
Reuter overhead upmount brackets	For 48"H spine with standard crown				AA1ROUP()		236.
Reuter overhead extended upmount brackets	For 39"H spine with standard crown				AA1ROXUP()		471.
Upmount brackets	For AutoStrada panels				RO1-RCB()		110.
	For Morrison panels				RO1-CB()		110.
Panel mount brackets, pair	For AutoStrada panels				RO1-RPB	51.	
	For Morrison panels				RO1-MPB	51.	
Wall mount frames, overhead cabinet	30"W overheads	23"	1/2"	13"	RO1-WMF2	96.	
	36" or 42"W overheads	35"	1/2"	13"	RO1-WMF3	105.	
	48" or 60"W overheads	47"	1/2"	13"	RO1-WMF4	110.	
Wall mount wire manager, set of 10					MWM-J	175.	

Order Code	Specification Information	Application Notes
Example: AA1RODN 613	<p>Please specify painted finish for overhead upmount or downmount kit. Paint options are listed on page 8.</p>	<p>Reuter upmount brackets attach overhead cabinet anywhere along standard spine crown, lifting 1" above nominal wall height. Extended upmount brackets lift overhead to 10" above nominal wall height.</p> <p>Downmount brackets attach overheads within the upper 16" of 64"H walls with either compact or standard crown. The AutoStrada version of the downmount brackets extends to the bottom of the access cover, making contact with the bottom trim extrusion.</p>
AA1 Spine accessory		
RO Reuter overhead		
DN Configuration		
613 Finish		
		<p>Specify an extra bracket (one-half pair) for center support of overhead cabinets wider than 60".</p> <p>Upmount or downmount brackets may be inset to permit overhead to extend 1" or 3" beyond the end of the spine at T-ends.</p> <p>Wall mount frames secure Reuter overhead cabinets to wall (frame/wall mounting hardware is not included). Frame is concealed behind storage. Use 2 RO1-WMF2 to wall mount 66" and 72" wide Reuter overheads.</p> <p>Wall mount wire manager is two-part wire concealment kit, 22"H (medium grey only).</p>

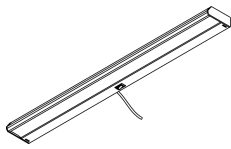
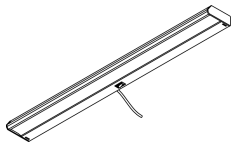
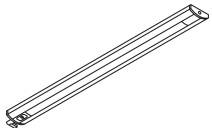
description	type	w	d	h	pattern no.	list
 <p>T5 Standard Task Light</p>	Use with 24" and wider overhead	19"	4"	1 1/2"	RTAT5E19S	\$241.
	Use with 30" and wider overhead	25"	4"	1 1/2"	RTAT5E25S	259.
	Use with 42" and wider overhead	37"	4"	1 1/2"	RTAT5E37S	280.
	Use with 60" and wider overhead	49"	4"	1 1/2"	RTAT5E49S	303.
	Use with 66" and wider overhead	61"	4"	1 1/2"	RTAT5E61S	322.
 <p>T5 Advanced Task Light</p>	Use with 30" and wider overhead	25"	4"	1 1/2"	RTAT5E25A	447.
	Use with 42" and wider overhead	37"	4"	1 1/2"	RTAT5E37A	470.
	Use with 60" and wider overhead	49"	4"	1 1/2"	RTAT5E49A	489.
	Use with 66" and wider overhead	61"	4"	1 1/2"	RTAT5E61A	509.
 <p>LED Task Light</p>	Use with 24" and wider overhead (24 LED's)	17"	2"	1/2"	ML4L17	495.
	Use with 36" and wider overhead (48 LED's)	31"	2"	1/2"	ML4L31	825.
	Use with 48" and wider overhead (72 LED's)	44"	2"	1/2"	ML4L44	1,075.
	Use with 66" and wider overhead (96 LED's)	58"	2"	1/2"	ML4L58	1,350.



Order Code	
T5 Standard Task Light	
Example:	RTAT5E25S
RTA	Task Light
T5	T5 lamp
E	Electronic ballast
25	Width
S	Standard
LED Task Light	
Example:	ML4L17
ML4	Task Light
L	LED
17	Width

Specification Information
<p>T5 Task Lights: 120v and includes T5 cool white (4100K) fluorescent lamp, electronic ballast, 9' grounded cordset, prismatic lens, rocker switch, one cord exit management clip and mounting hardware. Housings are black.</p> <p>LED Task Lights: Includes LED's, power supply with 9-12' cord and mounting hardware. Housings are clear anodized aluminum with white color end-caps.</p>

Application Notes
<p>T5 Task Lights: Specify suffix -CH and add \$45 list for City of Chicago installations. Example: DL3T5E25S-CH</p> <p>Cordset is center exit. On smaller units cord exit is off-center, but still not handed.</p> <p>T5 advanced task lights are fitted with ballasts and lamps compliant with LEED requirements, meeting the LEED EB standard for mercury content.</p> <p>Notes: All task lights mount into the recess in the underside of overhead cabinets and shelves at least 6" wider than task light width.</p> <p>All task lights are TCLP compliant and meet requirements of California Title 20 and Title 24.</p>

Task Lights

for wood and laminate overhead storage

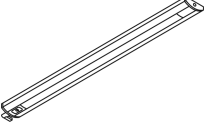
description	type	w	d	h	pattern no.	list
	Use with 24" and wider overhead	19"	4"	1 1/2"	AL1T5E19S	\$292.
	Use with 30" and wider overhead	25"	4"	1 1/2"	AL1T5E25S	298.
	Use with 42" and wider overhead	37"	4"	1 1/2"	AL1T5E37S	305.
	Use with 60" and wider overhead	49"	4"	1 1/2"	AL1T5E49S	310.
	Use with 72" and wider overhead	61"	4"	1 1/2"	AL1T5E61S	328.
	Use with 84" and wider overhead	73"	4"	1 1/2"	AL1T5E73S	358.
	Use with 96" and wider overhead	85"	4"	1 1/2"	AL1T5E85S	447.
	Use with 30" and wider overhead	25"	4"	1 1/2"	AL1T5E25A	431.
	Use with 42" and wider overhead	37"	4"	1 1/2"	AL1T5E37A	452.
	Use with 60" and wider overhead	49"	4"	1 1/2"	AL1T5E49A	470.
	Use with 72" and wider overhead	61"	4"	1 1/2"	AL1T5E61A	489.
	Use with 84" and wider overhead	73"	4"	1 1/2"	AL1T5E73A	508.
	Use with 96" and wider overhead	85"	4"	1 1/2"	AL1T5E85A	526.
	Use with 24" and wider overhead (24 LED's)	17"	2"	1/2"	AL4L17	495.
	Use with 36" and wider overhead (48 LED's)	31"	2"	1/2"	AL4L31	825.
	Use with 48" and wider overhead (72 LED's)	44"	2"	1/2"	AL4L44	1,075.
	Use with 66" and wider overhead (96 LED's)	58"	2"	1/2"	AL4L58	1,350.

Order Code	Specification Information
T5 Standard Task Light	
Example: AL1T5E19S	
AL1 Task Light	
T5 T5 lamp	
E Electronic ballast	
19 Width	
S Standard	
LED Task Light	
Example: AL4L17	
AL4 Task Light	
L LED	
17 Width	

T5 Task Lights:
120v and includes T5 cool white (4100K) fluorescent lamp, electronic ballast, 9' grounded cordset, prismatic lens, rocker switch, one cord exit management clip and mounting hardware. Housings are black.

LED Task Lights:
Includes LED's, power supply with 9-12' cord and mounting hardware. Housings are clear anodized aluminum with white color end-caps.

Application Notes

T5 Task Lights:
Specify suffix -CH and add \$45 list for City of Chicago installations.
Example: DL3T5E25S-CH

Cordset is center exit. On smaller units cord exit is off-center, but still not handed.

T5 advanced task lights are fitted with ballasts and lamps compliant with LEED requirements, meeting the LEED EB standard for mercury content.

Notes:
All task lights mount into the recess in the underside of overhead cabinets and shelves at least 6" wider than task light width.

All task lights are TCLP compliant and meet requirements of California Title 20 and Title 24.

Reuter T5 mounting kit for binder depth wood overhead storage

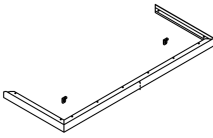
description	type	h	w	d	pattern no.	list		
	binder depth	1 1/2"	18"	13 1/8"	RT1 SMK 1813 ()	\$152.		
		1 1/2"	24"	13 1/8"	RT1 SMK 2413 ()	154.		
		1 1/2"	30"	13 1/8"	RT1 SMK 3013 ()	156.		
		1 1/2"	36"	13 1/8"	RT1 SMK 3613 ()	158.		
		1 1/2"	42"	13 1/8"	RT1 SMK 4213 ()	161.		
		1 1/2"	48"	13 1/8"	RT1 SMK 4813 ()	164.		
		1 1/2"	54"	13 1/8"	RT1 SMK 5413 ()	166.		
		1 1/2"	60"	13 1/8"	RT1 SMK 6013 ()	171.		
		1 1/2"	66"	13 1/8"	RT1 SMK 6613 ()	178.		
		1 1/2"	72"	13 1/8"	RT1 SMK 7213 ()	180.		
		1 1/2"	78"	13 1/8"	RT1 SMK 7813 ()	183.		
		1 1/2"	84"	13 1/8"	RT1 SMK 8413 ()	186.		
		1 1/2"	90"	13 1/8"	RT1 SMK 9013 ()	188.		
		1 1/2"	96"	13 1/8"	RT1 SMK 9613 ()	190.		
		binder depth with tackboard		1 1/2"	18"	12 3/8"	RT1 SMK 1812 ()	152.
				1 1/2"	24"	12 3/8"	RT1 SMK 2412 ()	154.
				1 1/2"	30"	12 3/8"	RT1 SMK 3012 ()	156.
				1 1/2"	36"	12 3/8"	RT1 SMK 3612 ()	158.
				1 1/2"	42"	12 3/8"	RT1 SMK 4212 ()	161.
				1 1/2"	48"	12 3/8"	RT1 SMK 4812 ()	164.
				1 1/2"	54"	12 3/8"	RT1 SMK 5412 ()	166.
				1 1/2"	60"	12 3/8"	RT1 SMK 6012 ()	170.
		1 1/2"	66"	12 3/8"	RT1 SMK 6612 ()	178.		
		1 1/2"	72"	12 3/8"	RT1 SMK 7212 ()	180.		
		1 1/2"	78"	12 3/8"	RT1 SMK 7812 ()	183.		
		1 1/2"	84"	12 3/8"	RT1 SMK 8412 ()	186.		
		1 1/2"	90"	12 3/8"	RT1 SMK 9012 ()	188.		
		1 1/2"	96"	12 3/8"	RT1 SMK 9612 ()	189.		
Additional T5 mounting brackets					RT1 SMK B	25.		

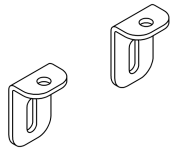

Order Code

Example:	RT1 SMK 2413 AA
RT1	Reuter task lamp
SMK	Mounting kit
24	Width
13	Depth
AA	Finish

Specification Information

Mounting kit finish choice:
Anodized Aluminum or painted finish options listed on page 10 excluding silver.

12" deep: binder depth wood overhead, wall mounted with tackboard below.

13" deep: binder depth wood overhead on Applied Wall System or wall mounted without tackboard.

Application

Reuter T5 task lamp mounting kit enables task lamp to be mounted under veneer or laminate overhead storage cabinets (with or without doors). Mounting kit includes anodized aluminum fascia to conceal lamp and manage power cord along front and side of cabinet. Specify mounting kit in width corresponding to overhead cabinet. Mounting kit also includes back supports for one task lamp.

To mount a second task lamp within one longer mounting kit specify one additional pair of back supports. Back supports are L brackets into which the pins at the back of the Reuter are inserted. Sliding brackets on sides of the lamp slide over the inside lip of the fascia at any point to support the front of the lamp.

Reuter T5 mounting kit for legal depth wood overhead storage

AutoStrada

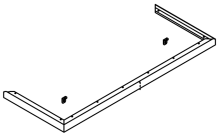
description	type	h	w	d	pattern no.	list		
	legal depth	1 1/2"	18"	16 1/8"	RT1 SMK 1816 ()	\$154.		
		1 1/2"	24"	16 1/8"	RT1 SMK 2416 ()	156.		
		1 1/2"	30"	16 1/8"	RT1 SMK 3016 ()	157.		
		1 1/2"	36"	16 1/8"	RT1 SMK 3616 ()	161.		
		1 1/2"	42"	16 1/8"	RT1 SMK 4216 ()	162.		
		1 1/2"	48"	16 1/8"	RT1 SMK 4816 ()	165.		
		1 1/2"	54"	16 1/8"	RT1 SMK 5416 ()	170.		
		1 1/2"	60"	16 1/8"	RT1 SMK 6016 ()	172.		
		1 1/2"	66"	16 1/8"	RT1 SMK 6616 ()	180.		
		1 1/2"	72"	16 1/8"	RT1 SMK 7216 ()	182.		
		1 1/2"	78"	16 1/8"	RT1 SMK 7816 ()	184.		
		1 1/2"	84"	16 1/8"	RT1 SMK 8416 ()	187.		
		1 1/2"	90"	16 1/8"	RT1 SMK 9016 ()	189.		
		1 1/2"	96"	16 1/8"	RT1 SMK 9616 ()	191.		
		legal depth with tackboard		1 1/2"	18"	15 3/8"	RT1 SMK 1815 ()	154.
				1 1/2"	24"	15 3/8"	RT1 SMK 2415 ()	155.
				1 1/2"	30"	15 3/8"	RT1 SMK 3015 ()	157.
				1 1/2"	36"	15 3/8"	RT1 SMK 3615 ()	159.
				1 1/2"	42"	15 3/8"	RT1 SMK 4215 ()	162.
				1 1/2"	48"	15 3/8"	RT1 SMK 4815 ()	165.
				1 1/2"	54"	15 3/8"	RT1 SMK 5415 ()	170.
				1 1/2"	60"	15 3/8"	RT1 SMK 6015 ()	172.
		1 1/2"	66"	15 3/8"	RT1 SMK 6615 ()	179.		
		1 1/2"	72"	15 3/8"	RT1 SMK 7215 ()	182.		
		1 1/2"	78"	15 3/8"	RT1 SMK 7815 ()	184.		
		1 1/2"	84"	15 3/8"	RT1 SMK 8415 ()	187.		
		1 1/2"	90"	15 3/8"	RT1 SMK 9015 ()	189.		
		1 1/2"	96"	15 3/8"	RT1 SMK 9615 ()	191.		
Additional T5 mounting brackets					RT1 SMK B	25.		

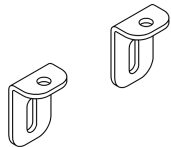

Order Code

Example:	RT1 SMK 2416 AA
RT1	Reuter task lamp
SMK	Mounting kit
24	Width
16	depth
AA	Finish

Specification Information

Mounting kit finish choice:
Anodized Aluminum or painted finish options listed on page 10 excluding silver.

15" deep: legal depth wood overhead, wall mounted with tackboard below.

16" deep: legal depth wood overhead on Applied Wall System or wall mounted without tackboard.

Application

Reuter T5 task lamp mounting kit enables task lamp to be mounted under veneer or laminate overhead storage cabinets (with or without doors). Mounting kit includes anodized aluminum fascia to conceal lamp and manage power cord along front and side of cabinet. Specify mounting kit in width corresponding to overhead cabinet. Mounting kit also includes back supports for one task lamp.

To mount a second task lamp within one longer mounting kit specify one additional pair of back supports. Back supports are L brackets into which the pins at the back of the Reuter are inserted. Sliding brackets on sides of the lamp slide over the inside lip of the fascia at any point to support the front of the lamp.

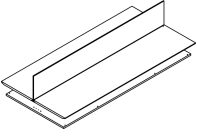
description	h	w	d	pattern no.	L	V1/M	V2	V3
	15"	60	40	A1GCTDK60141(L/V/M)() () ()	\$2,388.	\$2,765.	\$2,885.	\$3,462.
	15"	60"	48"	A1GCTDK60142(L/V/M)() () ()	2,445.	2,827.	2,967.	3,561.
	15"	72"	40"	A1GCTDK72141(L/V/M)() () ()	2,595.	2,979.	3,120.	3,743.
	15"	72"	48"	A1GCTDK72142(L/V/M)() () ()	2,662.	3,051.	3,216.	3,859.
	15"	90"	40"	A1GCTDK90141(L/V/M)() () ()	2,830.	3,224.	3,396.	4,076.
	15"	90"	48"	A1GCTDK90142(L/V/M)() () ()	2,919.	3,320.	3,515.	4,220.
	15"	96"	40"	A1GCTDK96141(L/V/M)() () ()	2,898.	3,293.	3,473.	4,168.
	15"	96"	48"	A1GCTDK96142(L/V/M)() () ()	2,988.	3,389.	3,602.	4,322.

1=use with nominal 19" deep storage.
 2=use with nominal 23" deep storage.

Worksurfaces

Order Code	Specifications	Application Notes
Example: A1GCTDK60141L	<i>To order please specify pattern number including:</i>	Credenza top glass divider kit to include glass divider, pair of worksurfaces under one product code per size.
A AutoStrada	1. Surface type <i>L = Laminate</i>	Worksurfaces are dedicated to kit and to be notched for securing divider capture.
1 Generation 1	<i>M = Mixed, Laminate surface/V1, V2 or V3 edge</i>	
G Glass	<i>V = V1, V2 or V3</i>	Grommets not optional in worksurface.
CT Credenza top	2. Finish, Surface <i>Laminate, V1, V2 or V3 finish</i>	
DK Divider kit	3. Finish, Edge <i>Must be same as surface finish</i>	Hardware included.
60 60" wide	4. Finish, Glass <i>TEMP = clear tempered glass</i>	
141 Nominal glass height	<i>GL13 = powder</i>	Assembly required.
L Laminate	<i>GL25 = bronze</i>	
V316 Finish, primary worksurface	<i>GL35 = grey</i>	
111 Subtop spacer	5. Finish, capture/ divider Anodized aluminum or painted finish options, listed on page 8 excluding 613 Silver.	Standoff / subtop only available in 111.
TEMP Finish, glass		
AA Finish, divider capture		

Applications to be restricted for use with common depth of storage either 19" deep or 23" deep on both sides. Will not offer 19" deep on one side and 23" deep on other side.

Upcharges	GL13	GL25/GL35
<i>width</i>		
60"	\$122	\$390
72"	\$145	\$467
90"	\$181	\$584
96"	\$196	\$625

Flush, user edge tapered Rectilinear, 20" and 24" deep

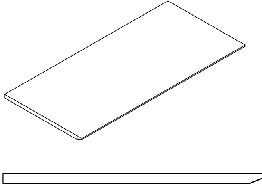
description	d	w	pattern no.	L	M	V1	V2	V3	
Straight rectangular, (full depth) front edge tapered 	20"	18"	AW1T1RF1820 () () () ()	\$358.	\$437.	\$459.	\$523.	\$682.	
		20"	AW1T1RF2020 () () () ()	372.	447.	470.	538.	700.	
		24"	AW1T1RF2420 () () () ()	382.	459.	482.	550.	716.	
		30"	AW1T1RF3020 () () () ()	412.	504.	529.	607.	788.	
		36"	AW1T1RF3620 () () () ()	416.	530.	557.	642.	834.	
		42"	AW1T1RF4220 () () () ()	426.	555.	583.	671.	872.	
		48"	AW1T1RF4820 () () () ()	437.	577.	606.	695.	904.	
		54"	AW1T1RF5420 () () () ()	450.	601.	631.	729.	947.	
		60"	AW1T1RF6020 () () () ()	476.	650.	682.	783.	1,017.	
		66"	AW1T1RF6620 () () () ()	511.	669.	702.	809.	1,052.	
		72"	AW1T1RF7220 () () () ()	515.	703.	738.	849.	1,100.	
		78"	AW1T1RF7820 () () () ()	531.	711.	747.	860.	1,117.	
		84"	AW1T1RF8420 () () () ()	562.	756.	794.	914.	1,191.	
		90"	AW1T1RF9020 () () () ()	575.	790.	830.	953.	1,239.	
		96"	AW1T1RF9620 () () () ()	614.	820.	860.	987.	1,285.	
		24"	18"	AW1T1RF1824 () () () ()	383.	460.	483.	553.	721.
			20"	AW1T1RF2024 () () () ()	398.	470.	494.	567.	738.
			24"	AW1T1RF2424 () () () ()	407.	480.	504.	583.	757.
			30"	AW1T1RF3024 () () () ()	425.	545.	572.	658.	855.
		36"	AW1T1RF3624 () () () ()	438.	568.	596.	684.	891.	
		42"	AW1T1RF4224 () () () ()	453.	584.	614.	704.	916.	
		48"	AW1T1RF4824 () () () ()	501.	627.	658.	755.	981.	
		54"	AW1T1RF5424 () () () ()	505.	669.	702.	809.	1,052.	
		60"	AW1T1RF6024 () () () ()	531.	717.	752.	864.	1,122.	
		66"	AW1T1RF6624 () () () ()	576.	743.	780.	893.	1,162.	
		72"	AW1T1RF7224 () () () ()	591.	775.	813.	937.	1,218.	
		78"	AW1T1RF7824 () () () ()	610.	810.	851.	981.	1,276.	
		84"	AW1T1RF8424 () () () ()	635.	846.	888.	1,017.	1,325.	
		90"	AW1T1RF9024 () () () ()	678.	880.	924.	1,066.	1,384.	
		96"	AW1T1RF9624 () () () ()	694.	914.	960.	1,109.	1,439.	

Order Code	Specification Information	Application Notes
Example: AW1T1RF1820MG118 V316613	To order please specify pattern number including:	Hardware to attach to vertical support to be specified separately.
A AutoStrada	1. Width	1 1/4" tops require additional support when distance spans over 48".
W Worksurface	2. Depth	
1 Generation 1	3. Surface type	Actual widths are 1/16" less than nominal dimension noted and depths are 1/8" less than nominal dimension noted.
T1 Tapered one side, user	<i>L = Laminate</i>	
R Rectilinear	<i>M = Mixed, Laminate surface/V1, V2 or V3 edge</i>	When grommets specified up to 48" w tops have one grommet, over 48" w tops have two grommets.
F Full depth, flush	<i>V = V1, V2 or V3</i>	
18 18" wide	4. Grommet option	Edge grommets are available on worksurfaces 30" wide or greater. The upcharge for Edge Grommet is \$175.
20 20" deep	<i>N = No grommets</i>	
M Surface type, Mixed	<i>G = Grommet(s), flush</i>	
G Grommet	<i>R = Grommet(s), recessed</i>	
118 Finish surface, Bright white	<i>EG = Edge Grommet (for worksurfaces 30" wide or greater)</i>	
V316 Finish edge, Maple	5. Finish, Surface	
613 Finish, grommet	<i>Laminate, V1, V2 or V3 finish</i>	
	6. Finish, Edge	
	<i>Must be same as surface finish unless M surface type specified, then must be V1, V2 or V3 finish</i>	
	7. Finish, Grommet(s)	
	<i>specify painted or plated finish</i>	
	See page 8 for finish options applicable.	
	Product on this page will accept wood grain laminate where laminate is currently an option.	

Flush, user edge tapered Rectilinear, 30" and 36" deep

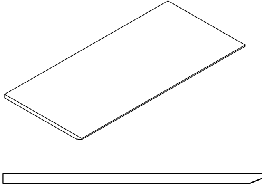
description	d	w	pattern no.	L	M	V1	V2	V3	
Straight rectangular, (full depth) front edge tapered 	30"	18"	AW1T1RF1830 () () () ()	\$391.	\$497.	\$522.	\$604.	\$783.	
		20"	AW1T1RF2030 () () () ()	397.	511.	537.	619.	801.	
		24"	AW1T1RF2430 () () () ()	406.	523.	549.	633.	825.	
		30"	AW1T1RF3030 () () () ()	426.	592.	621.	711.	926.	
		36"	AW1T1RF3630 () () () ()	441.	638.	670.	765.	998.	
		42"	AW1T1RF4230 () () () ()	462.	659.	693.	796.	1,035.	
		48"	AW1T1RF4830 () () () ()	514.	705.	740.	854.	1,112.	
		54"	AW1T1RF5430 () () () ()	527.	762.	801.	921.	1,198.	
		60"	AW1T1RF6030 () () () ()	560.	791.	831.	954.	1,240.	
		66"	AW1T1RF6630 () () () ()	602.	809.	850.	977.	1,270.	
		72"	AW1T1RF7230 () () () ()	621.	830.	872.	1,002.	1,302.	
		78"	AW1T1RF7830 () () () ()	644.	867.	911.	1,051.	1,363.	
		84"	AW1T1RF8430 () () () ()	669.	903.	947.	1,092.	1,421.	
		90"	AW1T1RF9030 () () () ()	728.	942.	989.	1,144.	1,485.	
		96"	AW1T1RF9630 () () () ()	730.	978.	1,026.	1,184.	1,536.	
		36"	18"	AW1T1RF1836 () () () ()	400.	539.	566.	654.	851.
			20"	AW1T1RF2036 () () () ()	405.	554.	582.	673.	874.
			24"	AW1T1RF2436 () () () ()	422.	568.	596.	686.	894.
			30"	AW1T1RF3036 () () () ()	439.	641.	673.	771.	1,003.
36"	AW1T1RF3636 () () () ()		467.	712.	748.	856.	1,114.		
42"	AW1T1RF4236 () () () ()		503.	746.	783.	904.	1,174.		
48"	AW1T1RF4836 () () () ()		555.	797.	836.	966.	1,257.		
54"	AW1T1RF5436 () () () ()		573.	876.	919.	1,048.	1,362.		
60"	AW1T1RF6036 () () () ()		579.	879.	922.	1,055.	1,370.		
66"	AW1T1RF6636 () () () ()		641.	883.	927.	1,070.	1,390.		
72"	AW1T1RF7236 () () () ()		662.	907.	953.	1,097.	1,426.		
78"	AW1T1RF7836 () () () ()		694.	928.	974.	1,125.	1,462.		
84"	AW1T1RF8436 () () () ()		719.	965.	1,013.	1,172.	1,524.		
90"	AW1T1RF9036 () () () ()		777.	1,012.	1,063.	1,224.	1,592.		
96"	AW1T1RF9636 () () () ()		798.	1,045.	1,097.	1,262.	1,639.		

Worksurfaces

Order Code	Specification Information	Application Notes
Example: AW1T1RF1830MG118 V316613	<i>To order please specify pattern number including:</i>	
A AutoStrada	1. Width	
W Worksurface	2. Depth	
1 Generation 1	3. Surface type	
T1 Tapered 1 side, user	<i>L = Laminate</i>	
R Rectilinear	<i>M = Mixed, Laminate surface/V1, V2 or V3 edge</i>	
F Full depth, flush	<i>V = V1, V2 or V3</i>	
18 18" wide	4. Grommet option	
30 30" deep	<i>N = No grommets</i>	
M Surface type, Mixed	<i>G = Grommet(s), flush</i>	
G Grommet	<i>R = Grommet(s), recessed</i>	
118 Finish surface, Bright white	<i>GR = Edge Grommet (for worksurfaces 30" wide or greater)</i>	
V316 Finish edge, Maple	5. Finish, Surface	
613 Finish, grommet	<i>Laminate, V1, V2 or V3 finish</i>	
	6. Finish, Edge	
	<i>Must be same as surface finish unless M surface type specified, then must be V1, V2 or V3 finish</i>	
	7. Finish, Grommet(s)	
	<i>specify painted or plated finish</i>	
	See page 8 for finish options applicable.	Hardware to attach to vertical support to be specified separately.
	Product on this page will accept wood grain laminate where laminate is currently an option.	1 1/4" tops require additional support when distance spans over 48".
		Actual widths are 1/16" less than nominal dimension noted and depths are 1/8" less than nominal dimension noted.
		When grommets specified up to 48" w tops have one grommet, over 48" w have two grommets.
		Edge grommets are available on worksurfaces 30" wide or greater. The upcharge for Edge Grommet is \$175.

Flush, user edge tapered Wedge

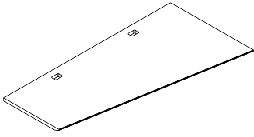
description	d, left	w	d, right	pattern no.	L	M	V1	V2	V3
Wedge, (full depth) front edge tapered 	24"	48"	30"	AW1T1WF4823 () () () ()	\$594.	\$705.	\$740.	\$854.	\$1,112.
	24"	60"	30"	AW1T1WF6023 () () () ()	630.	791.	831.	954.	1,240.
	24"	72"	36"	AW1T1WF7226 () () () ()	779.	889.	934.	1,069.	1,388.
	30"	48"	24"	AW1T1WF4832 () () () ()	594.	705.	740.	854.	1,112.
	30"	60"	24"	AW1T1WF6032 () () () ()	630.	791.	831.	954.	1,240.
	36"	72"	24"	AW1T1WF7262 () () () ()	779.	889.	934.	1,069.	1,388.
Presentation wood sample (with tapered edge detail)	16"	16"	16"	ASAMP1616 ()	118.	172.	180.	239.	283.

Order Code	Specification Information	Application Notes
Example: AW1T1WF4823MG118 V316613	<i>To order please specify pattern number including:</i>	
A AutoStrada	1. Width	6. Finish, Edge <i>Must be same as surface finish unless M surface type specified, then must be V1, V2 or V3 finish</i>
W Worksurface	2. Depth 23 = 24" deep left, 30" deep right 32 = 30" deep left, 24" deep right 26 = 24" deep left, 36" deep right 62 = 36" deep left, 24" deep right	7. Finish, Grommet(s) <i>specify painted or plated finish</i>
1 Generation 1	3. Surface type <i>L = Laminate</i> <i>M = Mixed, Laminate surface/V1, V2 or V3 edge</i> <i>V = V1, V2 or V3</i>	See page 8 for finish options applicable.
T1 Tapered 1 side, user	4. Grommet option <i>N = No grommets</i> <i>G = Grommet(s), flush</i> <i>R = Grommet(s), recessed</i>	Product on this page will accept wood grain laminate where laminate is currently an option.
W Wedge	5. Finish, Surface <i>Laminate, V1, V2 or V3 finish</i>	
F Full depth, flush		Hardware to attach to vertical support to be specified separately.
48 48" wide		1 1/4" tops require additional support when distance spans over 48".
2 24" deep, left		Actual widths are 1/16" less than nominal dimension noted and depths are 1/8" less than nominal dimension noted.
3 30" deep, right		When grommets specified up to 48" w tops have one grommet, over 48" w have two grommets.
M Surface type, Mixed		
G Grommet		
118 Finish surface, Bright white		
V316 Finish edge, Maple		
613 Finish, grommet		

Cord drop, user edge tapered

Rectilinear

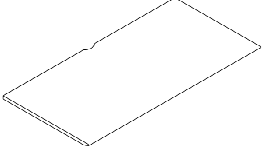
description	d	w	pattern no.	L	M	V1	V2	V3	
Straight rectangular, (cord drop) front edge tapered 	20"	18"	AW1T1RU1820 () () ()	\$369.	\$437.	\$459.	\$523.	\$682.	
		20"	AW1T1RU2020 () () ()	372.	447.	470.	538.	700.	
		24"	AW1T1RU2420 () () ()	382.	459.	482.	550.	716.	
		30"	AW1T1RU3020 () () ()	427.	504.	529.	607.	788.	
		36"	AW1T1RU3620 () () ()	431.	530.	557.	642.	834.	
		42"	AW1T1RU4220 () () ()	436.	555.	583.	671.	872.	
		48"	AW1T1RU4820 () () ()	449.	577.	606.	695.	904.	
		54"	AW1T1RU5420 () () ()	462.	601.	631.	729.	947.	
		60"	AW1T1RU6020 () () ()	488.	650.	682.	783.	1,017.	
		66"	AW1T1RU6620 () () ()	521.	669.	702.	809.	1,052.	
		72"	AW1T1RU7220 () () ()	525.	703.	738.	849.	1,100.	
		78"	AW1T1RU7820 () () ()	544.	711.	747.	860.	1,117.	
		84"	AW1T1RU8420 () () ()	572.	756.	794.	914.	1,191.	
		90"	AW1T1RU9020 () () ()	584.	790.	830.	953.	1,239.	
		96"	AW1T1RU9620 () () ()	624.	820.	860.	987.	1,285.	
		24"	18"	AW1T1RU1824 () () ()	394.	460.	483.	553.	721.
			20"	AW1T1RU2024 () () ()	399.	470.	494.	567.	738.
		24"	AW1T1RU2424 () () ()	402.	480.	504.	583.	757.	
		30"	AW1T1RU3024 () () ()	405.	545.	572.	658.	855.	
		36"	AW1T1RU3624 () () ()	412.	568.	596.	684.	891.	
		42"	AW1T1RU4224 () () ()	428.	584.	614.	704.	916.	
		48"	AW1T1RU4824 () () ()	441.	627.	658.	755.	981.	
		54"	AW1T1RU5424 () () ()	519.	669.	702.	809.	1,052.	
		60"	AW1T1RU6024 () () ()	571.	717.	752.	864.	1,122.	
		66"	AW1T1RU6624 () () ()	587.	743.	780.	893.	1,162.	
		72"	AW1T1RU7224 () () ()	602.	775.	813.	937.	1,218.	
		78"	AW1T1RU7824 () () ()	622.	810.	851.	981.	1,276.	
		84"	AW1T1RU8424 () () ()	647.	846.	888.	1,017.	1,325.	
		90"	AW1T1RU9024 () () ()	688.	880.	924.	1,066.	1,384.	
		96"	AW1T1RU9624 () () ()	705.	914.	960.	1,109.	1,439.	
	30"	18"	AW1T1RU1830 () () ()	401.	497.	522.	604.	783.	
		20"	AW1T1RU2030 () () ()	407.	511.	537.	619.	801.	
		24"	AW1T1RU2430 () () ()	421.	523.	549.	633.	825.	

Worksurfaces

Order Code	Specification Information	Application Notes
Example: AW1T1RC1820M118 V316 812	<i>To order please specify pattern number including:</i>	Worksurfaces with cord drop are not recommended for freestanding applications.
A AutoStrada	1. Width	See page 8 for finish options applicable.
W Worksurface	2. Depth	Product on this page will accept wood grain laminate where laminate is currently an option.
1 Generation 1	3. Surface type <i>L = Laminate</i>	Hardware to attach to vertical support to be specified separately.
T1 Tapered 1 side, user	<i>M = Mixed, Laminate surface/V1, V2 or V3 edge</i>	1 1/4" tops require additional support when distance spans over 48".
R Rectilinear	<i>V = V1, V2 or V3</i>	Actual widths are 1/16" less than nominal dimension noted and depths are 3/8" less than nominal dimension noted.
U Cord drop	4. Finish, Surface <i>Laminate, V1, V2 or V3 finish</i>	
18 18" wide	5. Finish, Edge <i>Must be same as surface finish unless M surface type specified, then must be V1, V2 or V3 finish</i>	
20 20" deep	6. Finish, Grommet	
M Surface type, Mixed	111 Jet black	
118 Finish surface, Bright white	812 Easy grey	
V316 Finish edge, Maple		
812 Finish grommet, Easy grey		

Cord drop, user edge tapered

Rectilinear

description	d	w	pattern no.	L	M	V1	V2	V3
Straight rectangular, (cord drop) front edge tapered	30"	30"	AW1T1RU3030 () () ()	\$436.	\$592.	\$621.	\$711.	\$926.
		36"	AW1T1RU3630 () () ()	453.	638.	670.	765.	998.
		42"	AW1T1RU4230 () () ()	473.	659.	693.	796.	1,035.
		48"	AW1T1RU4830 () () ()	524.	705.	740.	854.	1,112.
		54"	AW1T1RU5430 () () ()	537.	762.	801.	921.	1,198.
		60"	AW1T1RU6030 () () ()	599.	791.	831.	954.	1,240.
		66"	AW1T1RU6630 () () ()	613.	809.	850.	977.	1,270.
		72"	AW1T1RU7230 () () ()	632.	830.	872.	1,002.	1,302.
		78"	AW1T1RU7830 () () ()	652.	867.	911.	1,051.	1,363.
		84"	AW1T1RU8430 () () ()	678.	903.	947.	1,092.	1,421.
		90"	AW1T1RU9030 () () ()	740.	942.	989.	1,144.	1,485.
		96"	AW1T1RU9630 () () ()	742.	978.	1,026.	1,184.	1,536.

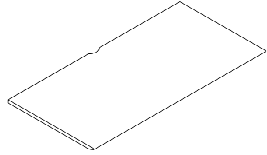

Order Code	Specification Information	Application Notes
Example: AW1T1RC1820M118 V316 812	To order please specify pattern number including:	Worksurfaces with cord drop are not recommended for freestanding applications.
A AutoStrada	1. Width	See page 8 for finish options applicable.
W Worksurface	2. Depth	Product on this page will accept wood grain laminate where laminate is currently an option.
1 Generation 1	3. Surface type <i>L = Laminate</i>	Hardware to attach to vertical support to be specified separately.
T1 Tapered 1 side, user	<i>M = Mixed, Laminate surface/V1, V2 or V3 edge</i>	1 1/4" tops require additional support when distance spans over 48".
R Rectilinear	<i>V = V1, V2 or V3</i>	Actual widths are 1/16" less than nominal dimension noted and depths are 3/8" less than nominal dimension noted.
U Cord drop	4. Finish, Surface <i>Laminate, V1, V2 or V3 finish</i>	
18 18" wide	5. Finish, Edge <i>Must be same as surface finish unless M surface type specified, then must be V1, V2 or V3 finish</i>	
20 20" deep	6. Finish, Grommet	
M Surface type, Mixed	111 Jet black	
118 Finish surface, Bright white	812 Easy grey	
V316 Finish edge, Maple		
812 Finish grommet, Easy grey		

Cord drop, user edge tapered Wedge

description	d, left	w	d, right	pattern no.	L	M	V1	V2	V3
Wedge, (cord drop) front edge tapered 	24"	48"	30"	AW1T1WU4823 () () ()	\$599.	\$705.	\$740.	\$854.	\$1,112.
	24"	60"	30"	AW1T1WU6023 () () ()	633.	791.	831.	954.	1,240.
	24"	72"	36"	AW1T1WU7226 () () ()	786.	889.	934.	1,069.	1,388.
	30"	48"	24"	AW1T1WU4832 () () ()	599.	705.	740.	854.	1,112.
	30"	60"	24"	AW1T1WU6032 () () ()	633.	791.	831.	954.	1,240.
	36"	72"	24"	AW1T1WU7262 () () ()	786.	889.	934.	1,069.	1,388.

Order Code	Specification Information	Application Notes
Example: AW1T1WU4823M118 V316 812	To order please specify pattern number including:	<p>Worksurfaces with cord drop are not recommended for freestanding applications.</p> <p>Hardware to attach to vertical support to be specified separately.</p> <p>1 1/4" tops require additional support when distance spans over 48".</p> <p>Actual widths are 1/16" less than nominal dimension noted and depths are 3/8" less than nominal dimension noted.</p>
A AutoStrada	1. Width	
W Worksurface	2. Depth	
1 Generation 1	23 = 24" deep left, 30" deep right	
T1 Tapered 1 side, user	32 = 30" deep left, 24" deep right	
W Wedge	26 = 24" deep left, 36" deep right	
U Cord drop	62 = 36" deep left, 24" deep right	
48 48" wide	3. Surface type	
2 24" deep, left	L = Laminate	
3 30" deep, right	M = Mixed, Laminate surface/V1, V2 or V3 edge	
M Surface type, Mixed	V = V1, V2 or V3	
118 Finish surface, Bright white	4. Finish, Surface Laminate, V1, V2 or V3 finish	
V316 Finish edge, Maple	5. Finish, Edge Must be same as surface finish unless M surface type specified, then must be V1, V2 or V3 finish	
812 Finish grommet, Easy grey	6. Finish, Grommet 111 Jet black 812 Easy grey	
	See page 8 for finish options applicable.	
	Product on this page will accept wood grain laminate where laminate is currently an option.	

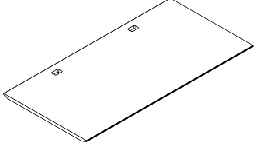
description	d	w	pattern no.	L	M	V1	V2	V3	
Straight rectangular, (full depth) front & back edge tapered 	30"	30"	AW1T2R3030 () () () ()	\$487.	\$721.	\$757.	\$849.	\$1,064.	
		36"	AW1T2R3630 () () () ()	501.	764.	803.	902.	1,132.	
		42"	AW1T2R4230 () () () ()	522.	790.	830.	935.	1,173.	
		48"	AW1T2R4830 () () () ()	545.	836.	878.	989.	1,247.	
		54"	AW1T2R5430 () () () ()	618.	894.	939.	1,060.	1,334.	
		60"	AW1T2R6030 () () () ()	638.	920.	966.	1,091.	1,377.	
		66"	AW1T2R6630 () () () ()	657.	938.	985.	1,115.	1,407.	
		72"	AW1T2R7230 () () () ()	677.	959.	1,007.	1,138.	1,436.	
		78"	AW1T2R7830 () () () ()	702.	997.	1,047.	1,188.	1,501.	
		84"	AW1T2R8430 () () () ()	722.	1,033.	1,085.	1,226.	1,557.	
		90"	AW1T2R9030 () () () ()	776.	1,072.	1,126.	1,280.	1,621.	
		96"	AW1T2R9630 () () () ()	797.	1,108.	1,163.	1,318.	1,672.	
		36"	30"	AW1T2R3036 () () () ()	502.	769.	807.	908.	1,139.
			36"	AW1T2R3636 () () () ()	524.	843.	886.	991.	1,249.
			42"	AW1T2R4236 () () () ()	547.	877.	920.	1,038.	1,311.
			48"	AW1T2R4836 () () () ()	575.	926.	972.	1,101.	1,394.
			54"	AW1T2R5436 () () () ()	651.	1,010.	1,061.	1,186.	1,500.
			60"	AW1T2R6036 () () () ()	674.	1,005.	1,055.	1,192.	1,504.
			66"	AW1T2R6636 () () () ()	711.	1,014.	1,065.	1,204.	1,527.
		72"	AW1T2R7236 () () () ()	720.	1,038.	1,090.	1,236.	1,564.	
		78"	AW1T2R7836 () () () ()	751.	1,060.	1,113.	1,262.	1,600.	
		84"	AW1T2R8436 () () () ()	770.	1,095.	1,150.	1,309.	1,660.	
		90"	AW1T2R9036 () () () ()	826.	1,141.	1,198.	1,360.	1,727.	
		96"	AW1T2R9636 () () () ()	851.	1,176.	1,236.	1,397.	1,775.	
	42"	30"	AW1T2R3042 () () () ()	523.	833.	875.	981.	1,276.	
		36"	AW1T2R3642 () () () ()	547.	945.	992.	1,111.	1,440.	
		42"	AW1T2R4242 () () () ()	572.	986.	1,035.	1,176.	1,532.	
		48"	AW1T2R4842 () () () ()	601.	1,044.	1,096.	1,249.	1,624.	
		54"	AW1T2R5442 () () () ()	680.	1,076.	1,130.	1,282.	1,665.	
		60"	AW1T2R6042 () () () ()	706.	1,109.	1,164.	1,315.	1,710.	
		66"	AW1T2R6642 () () () ()	731.	1,116.	1,172.	1,326.	1,722.	
		72"	AW1T2R7242 () () () ()	756.	1,120.	1,176.	1,335.	1,734.	
		78"	AW1T2R7842 () () () ()	806.	1,135.	1,192.	1,352.	1,756.	

Order Code	Specification Information	Application Notes
Example: AW1T2R3030MG118 V316613	To order please specify pattern number including:	7. Finish, Grommet(s) <i>specify painted or plated finish</i>
A AutoStrada	1. Width	Hardware to attach to vertical support to be specified separately.
W Worksurface	2. Depth	See page 8 for finish options applicable.
1 Generation 1	3. Surface type <i>L = Laminate</i> <i>M = Mixed, Laminate surface/V1, V2 or V3 edge</i> <i>V = V1, V2 or V3</i>	1 1/4" tops require additional support when distance spans over 48".
T2 Tapered 2 sides, user & approach	4. Grommet option <i>N = No grommets</i> <i>G = Grommet(s), flush</i> <i>R = Grommet(s), recessed</i>	When grommets specified up to 48" w tops have one grommet, over 48" w have two grommets.
R Rectilinear	5. Finish, Surface <i>Laminate, V1, V2 or V3 finish</i>	
30 30" wide	6. Finish, Edge <i>Must be same as surface finish unless M surface type specified, then must be V1, V2 or V3 finish</i>	
30 30" deep		
M Surface type, Mixed		
G Grommet		
118 Finish surface, Bright white		
V316 Finish edge, Maple		
613 Finish, grommet		

description	d	w	pattern no.	L	M	V1	V2	V3
Straight rectangular, (full depth) front & back edge tapered	42"	84"	AW1T2R8442 () () () ()	\$814.	\$1,173.	\$1,231.	\$1,402.	\$1,825.
		90"	AW1T2R9042 () () () ()	874.	1,223.	1,284.	1,461.	1,900.
		96"	AW1T2R9642 () () () ()	902.	1,256.	1,319.	1,491.	1,940.

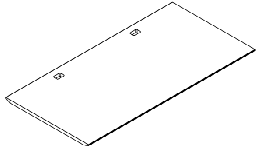

Order Code	Specification Information	Application Notes
Example: AW1T2R3030MG118 V316613	<i>To order please specify pattern number including:</i>	
A AutoStrada	1. Width	7. Finish, Grommet(s) <i>specify painted or plated finish</i>
W Worksurface	2. Depth	See page 8 for finish options applicable.
1 Generation 1	3. Surface type <i>L = Laminate</i>	Product on this page will accept wood grain laminate where laminate is currently an option.
T2 Tapered 2 sides, user & approach	<i>M = Mixed, Laminate surface/V1, V2 or V3 edge</i>	When grommets specified up to 48" w tops have one grommet, over 48" w have two grommets.
R Rectilinear	<i>V = V1, V2 or V3</i>	
30 30" wide	4. Grommet option <i>N = No grommets</i>	
30 30" deep	<i>G = Grommet(s), flush</i>	
M Surface type, Mixed	<i>R = Grommet(s), recessed</i>	
G Grommet	5. Finish, Surface <i>Laminate, V1, V2 or V3 finish</i>	
118 Finish surface, Bright white	6. Finish, Edge <i>Must be same as surface finish unless M surface type specified, then must be V1, V2 or V3 finish</i>	
V316 Finish edge, Maple		
613 Finish, grommet		

Rectilinear for C-Leg and T-Leg bases 24", 30" and 36" Deep

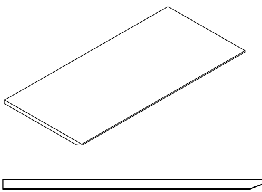
description	type	d*	d	w*	w	pattern no.	L	V1	V2	V3
	For use with 24"D C-Leg base	24"	23"	36"	34"	AW1T1R3423()N()	\$412.	\$596.	\$684.	\$891.
		24"	23"	42"	40"	AW1T1R4023()N()	428.	614.	704.	916.
		24"	23"	48"	46"	AW1T1R4623()N()	441.	658.	755.	981.
		24"	23"	54"	52"	AW1T1R5223()N()	519.	702.	809.	1,052.
		24"	23"	60"	58"	AW1T1R5823()N()	571.	752.	864.	1,122.
		24"	23"	66"	64"	AW1T1R6423()N()	587.	780.	893.	1,162.
		24"	23"	72"	70"	AW1T1R7023()N()	602.	813.	937.	1,218.
	For use with 30"D C-Leg base	30"	29"	36"	34"	AW1T1R3429()N()	453.	670.	765.	998.
		30"	29"	42"	40"	AW1T1R4029()N()	473.	693.	796.	1,035.
		30"	29"	48"	46"	AW1T1R4629()N()	524.	740.	854.	1,112.
		30"	29"	54"	52"	AW1T1R5229()N()	537.	801.	921.	1,198.
		30"	29"	60"	58"	AW1T1R5829()N()	599.	831.	954.	1,240.
		30"	29"	66"	64"	AW1T1R6429()N()	613.	850.	977.	1,270.
		30"	29"	72"	70"	AW1T1R7029()N()	632.	872.	1,002.	1,302.
	For use with 30"D T-Leg base	36"	35"	48"	46"	AW1T2R4635()N()	575.	972.	1,101.	1,394.
		36"	35"	54"	52"	AW1T2R5235()N()	651.	1,061.	1,186.	1,500.
		36"	35"	60"	58"	AW1T2R5835()N()	674.	1,055.	1,192.	1,504.
		36"	35"	66"	64"	AW1T2R6435()N()	711.	1,065.	1,204.	1,527.
		36"	35"	72"	70"	AW1T2R7035()N()	720.	1,090.	1,236.	1,564.

Order Code

Example:	AW1T1R5829LN, 118
AW	Worksurface
1	Generation 1
T1	Tapered 1 side, user
R	Rectilinear
58	Width
29	Depth
L	Laminate
N	No Grommets
118	Bright White Laminate

Specification Information

To order please specify pattern number including:

1. Width

2. Depth

3. Surface Type:

L = Laminate

V = V1, V2 or V3

4. N = No Grommet

5. Finish, Surface Laminate, V1, V2 or V3

See page 7 for finish options applicable.

Product on this page will accept woodgrain laminate where laminate is currently an option.

Application Notes

Worksurfaces on this page are designed for use with fixed and height adjustable C-Leg and T-Leg bases to create freestanding tables.

23", 29" and 35" rectangular worksurfaces are for use with corresponding depth fixed and height adjustable C-Leg bases and T-Leg bases.

23" and 29" worksurfaces are user edge tapered. 35" worksurfaces are user and approach edges tapered.

Worksurfaces are pre-drilled with pilot holes for use with wood screws.

Actual worksurfaces are undersized by 1" on each side edge and by 1" on the back edge.

w* and d* = nominal dimensions

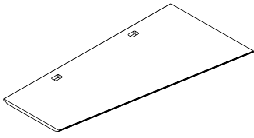
description	d, left	w	d, right	pattern no.	L	M	V1	V2	V3
Wedge, front and back edge tapered 	24"	48"	30"	AW1T2W4823 () () () ()	\$641.	\$836.	\$878.	\$989.	\$1,247.
	24"	60"	30"	AW1T2W6023 () () () ()	708.	920.	966.	1,091.	1,377.
	24"	72"	36"	AW1T2W7226 () () () ()	826.	1,019.	1,070.	1,203.	1,524.
	30"	48"	24"	AW1T2W4832 () () () ()	641.	836.	878.	989.	1,247.
	30"	60"	24"	AW1T2W6032 () () () ()	708.	920.	966.	1,091.	1,377.
	36"	72"	24"	AW1T2W7262 () () () ()	826.	1,019.	1,070.	1,203.	1,524.

Worksurfaces

Order Code	Specification Information	Application Notes
Example: AW1T2W4823MG118 V316613	<i>To order please specify pattern number including:</i>	
A AutoStrada	1. Width	6. Finish, Edge <i>Must be same as surface finish unless M surface type specified, then must be V1, V2 or V3 finish</i>
W Worksurface	2. Depth 23 = 24" deep left, 30" deep right 32 = 30" deep left, 24" deep right 26 = 24" deep left, 36" deep right 62 = 36" deep left, 24" deep right	7. Finish, Grommet(s) <i>specify painted or plated finish</i>
1 Generation 1	3. Surface type <i>L = Laminated</i> <i>M = Mixed, Laminated surface/V1, V2 or V3 edge</i> <i>V = V1, V2 or V3</i>	See page 8 for finish options applicable.
T2 Tapered 2 sides, user & approach	4. Grommet option <i>N = No grommets</i> <i>G = Grommet(s), flush</i> <i>R = Grommet(s), recessed</i>	Product on this page will accept wood grain laminate where laminate is currently an option.
W Wedge	5. Finish, Surface <i>Laminated, V1, V2 or V3 finish</i>	
48 48" wide		
2 24" deep, left		
3 30" deep, right		
M Surface type, Mixed		
G Grommet		
118 Finish surface, Bright white		
V316 Finish edge, Maple		
613 Finish, grommet		

Hardware to attach to vertical support to be specified separately.

1 1/4" tops require additional support when distance spans over 48".

Important: Please note placement of grommet(s) when specified assumes user edge is wedge side. If application requires user side to be straight edge and wedge edge as approach side, then specify no grommets.

When grommets specified up to 48" w tops have one grommet, over 48" w have two grommets.

description	d, left	w	d, right	pattern no.	L	M	V1	V2	V3
Double wedge, front and back edge tapered	24"	48"	36"	AW1T2DW4826 () () () ()	\$669.	\$926.	\$972.	\$1,101.	\$1,394.
	24"	60"	36"	AW1T2DW6026 () () () ()	745.	1,005.	1,055.	1,192.	1,504.
	24"	72"	36"	AW1T2DW7226 () () () ()	826.	1,060.	1,113.	1,262.	1,600.

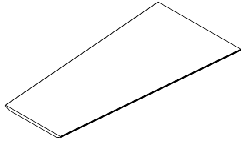

Order Code	Specification Information	Application Notes
Example: AW1T2DW4826MG118 V316613	<i>To order please specify pattern number including:</i>	5. Finish, Grommet <i>specify painted or plated finish</i>
A AutoStrada	1. Surface type <i>L = Laminate</i>	See page 8 for finish options applicable.
W Worksurface	<i>M = Mixed, Laminate surface/V1, V2 or V3 edge</i>	Product on this page will accept wood grain laminate where laminate is currently an option.
1 Generation 1	<i>V = V1, V2 or V3</i>	Hardware to attach to vertical support to be specified separately.
T2 Tapered 2 sides, user & approach	2. Grommet option <i>N = No grommet</i>	1 1/4" tops require additional support when distance spans over 48".
DW Double Wedge	<i>G = Grommet</i>	Grommet when specified, centered 36" w end.
48 48" wide	3. Finish, Surface <i>Laminate, V1, V2 or V3 finish</i>	
2 24" deep	4. Finish, Edge <i>Must be same as surface finish unless M surface type specified, then must be V1, V2 or V3 finish</i>	
6 36" deep		
M Surface type, Mixed		
G Grommet		
118 Finish surface, Bright white		
V316 Finish edge, Maple		
613 Finish, grommet		

Peninsulas

with straight legs and simple stand-off

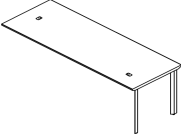
description	d	h	w	leg height	pattern no.	L	M	V1	V2	V3	
Rectangular peninsulas, tapered 2 sides with straight legs and simple stand-off		30"	28 3/8"	60"	27"	APRT2S1ST(L/R)6030() () () () ()	\$1,149.	\$1,431.	\$1,477.	\$1,602.	\$1,888.
		28 3/8"	66"	27"	APRT2S1ST(L/R)6630() () () () ()	1,186.	1,449.	1,496.	1,626.	1,918.	
		28 3/8"	72"	27"	APRT2S1ST(L/R)7230() () () () ()	1,188.	1,470.	1,518.	1,649.	1,947.	
		28 3/8"	78"	27"	APRT2S1ST(L/R)7830() () () () ()	1,213.	1,508.	1,558.	1,699.	2,012.	
		28 3/8"	84"	27"	APRT2S1ST(L/R)8430() () () () ()	1,233.	1,544.	1,596.	1,737.	2,068.	
		28 3/8"	90"	27"	APRT2S1ST(L/R)9030() () () () ()	1,287.	1,583.	1,637.	1,791.	2,132.	
		28 3/8"	96"	27"	APRT2S1ST(L/R)9630() () () () ()	1,308.	1,619.	1,674.	1,829.	2,183.	
		29 3/4"	60"	28 3/4"	APRT2S2ST(L/R)6030() () () () ()	1,149.	1,431.	1,477.	1,602.	1,888.	
		29 3/4"	66"	28 3/4"	APRT2S2ST(L/R)6630() () () () ()	1,186.	1,449.	1,496.	1,626.	1,918.	
		29 3/4"	72"	28 3/4"	APRT2S2ST(L/R)7230() () () () ()	1,188.	1,470.	1,518.	1,649.	1,947.	
		29 3/4"	78"	28 3/4"	APRT2S2ST(L/R)7830() () () () ()	1,213.	1,508.	1,558.	1,699.	2,012.	
		29 3/4"	84"	28 3/4"	APRT2S2ST(L/R)8430() () () () ()	1,233.	1,544.	1,596.	1,737.	2,068.	
		29 3/4"	90"	28 3/4"	APRT2S2ST(L/R)9030() () () () ()	1,287.	1,583.	1,637.	1,791.	2,132.	
		29 3/4"	96"	28 3/4"	APRT2S2ST(L/R)9630() () () () ()	1,308.	1,619.	1,674.	1,829.	2,183.	
		36"	28 3/8"	60"	27"	APRT2S1ST(L/R)6036() () () () ()	1,185.	1,516.	1,566.	1,703.	2,015.
		28 3/8"	66"	27"	APRT2S1ST(L/R)6636() () () () ()	1,222.	1,525.	1,576.	1,715.	2,038.	
		28 3/8"	72"	27"	APRT2S1ST(L/R)7236() () () () ()	1,231.	1,549.	1,601.	1,747.	2,075.	
		28 3/8"	78"	27"	APRT2S1ST(L/R)7836() () () () ()	1,262.	1,571.	1,624.	1,773.	2,111.	
		28 3/8"	84"	27"	APRT2S1ST(L/R)8436() () () () ()	1,281.	1,606.	1,661.	1,820.	2,171.	
		28 3/8"	90"	27"	APRT2S1ST(L/R)9036() () () () ()	1,337.	1,652.	1,709.	1,871.	2,238.	
28 3/8"	96"	27"	APRT2S1ST(L/R)9636() () () () ()	1,362.	1,687.	1,747.	1,908.	2,286.			
29 3/4"	60"	28 3/4"	APRT2S2ST(L/R)6036() () () () ()	1,185.	1,516.	1,566.	1,703.	2,015.			
29 3/4"	66"	28 3/4"	APRT2S2ST(L/R)6636() () () () ()	1,222.	1,525.	1,576.	1,715.	2,038.			
29 3/4"	72"	28 3/4"	APRT2S2ST(L/R)7236() () () () ()	1,231.	1,549.	1,601.	1,747.	2,075.			
29 3/4"	78"	28 3/4"	APRT2S2ST(L/R)7836() () () () ()	1,262.	1,571.	1,624.	1,773.	2,111.			
29 3/4"	84"	28 3/4"	APRT2S2ST(L/R)8436() () () () ()	1,281.	1,606.	1,661.	1,820.	2,171.			
29 3/4"	90"	28 3/4"	APRT2S2ST(L/R)9036() () () () ()	1,337.	1,652.	1,709.	1,871.	2,238.			
29 3/4"	96"	28 3/4"	APRT2S2ST(L/R)9636() () () () ()	1,362.	1,687.	1,747.	1,908.	2,286.			

Worksurfaces

Order Code	Specification Information	Application Notes
Example: APRT2S1ST(L/R)6030	<i>To order please specify pattern number including:</i>	
A AutoStrada		
PR Peninsula Rectilinear		
T2 Tapered 2 sides; user and approach		
S1 27" h Straight leg		
ST Simple stand-off		
L Left hand		
60 Width		
30 Depth		
M Grommet option		
111 Grommet finish		
V316 Finish, Top		
111 Finish, Leg		
111 Finish, Stand-off		
	<ol style="list-style-type: none"> Leg height S1 = 27" high S2 = 28 3/8" high Hand L = Left hand R = Right hand Grommet option M = Mid grommet N = No grommet S = Stand-off SE = Stand-off, end location SD = Stand-off with drop in box SDR = Right hand stand-off with drop in box SDL = Left hand stand-off with drop in box Note: SD, SDR and SDL are only factory cut out, no grommet option is necessary. Finish, Grommet Painted or plated Finish, Top Laminate, V1, V2 or V3 finish Finish, Edge Must be same as surface finish unless M surface type specified, then must be V1, V2 or V3 finish Finish, Leg Anodized aluminum or painted finish option, excluding silver. Finish, Stand-off Painted finish only 	<p>From users perspective, if the leg is on the right side, the peninsula is classified a "Right Hand" peninsula.</p> <p>Peninsula worksurfaces with power center do not come with Electrical Components.</p> <p>Products on this page work with 28 3/8" height planning.</p> <p>Worksurface stiffeners are recommended to provide additional support for open spans greater than 48" w.</p> <p>Modesties sold separately and can be field installed.</p> <p>Wire chase sold separately.</p>

Peninsulas

with straight legs and simple stand-off with power center

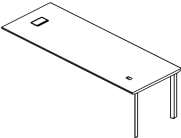
description	d	h	w	leg height	pattern no.	L	M	V1	V2	V3	
Rectangular peninsulas, tapered 2 sides with straight legs and simple stand-off with power center		30"	28 ³ / ₈ "	60"	27"	APRT2S1PC(L/R)6030() () () () ()	\$1,180.	\$1,462.	\$1,508.	\$1,633.	\$1,919.
		28 ³ / ₈ "	66"	27"	APRT2S1PC(L/R)6630() () () () ()	1,217.	1,480.	1,527.	1,657.	1,949.	
		28 ³ / ₈ "	72"	27"	APRT2S1PC(L/R)7230() () () () ()	1,219.	1,501.	1,549.	1,680.	1,978.	
		28 ³ / ₈ "	78"	27"	APRT2S1PC(L/R)7830() () () () ()	1,244.	1,539.	1,589.	1,730.	2,043.	
		28 ³ / ₈ "	84"	27"	APRT2S1PC(L/R)8430() () () () ()	1,264.	1,575.	1,627.	1,768.	2,099.	
		28 ³ / ₈ "	90"	27"	APRT2S1PC(L/R)9030() () () () ()	1,318.	1,614.	1,668.	1,822.	2,163.	
		28 ³ / ₈ "	96"	27"	APRT2S1PC(L/R)9630() () () () ()	1,339.	1,650.	1,705.	1,860.	2,214.	
		29 ³ / ₄ "	60"	28 ³ / ₄ "	APRT2S2PC(L/R)6030() () () () ()	1,180.	1,462.	1,508.	1,633.	1,919.	
		29 ³ / ₄ "	66"	28 ³ / ₄ "	APRT2S2PC(L/R)6630() () () () ()	1,217.	1,480.	1,527.	1,657.	1,949.	
		29 ³ / ₄ "	72"	28 ³ / ₄ "	APRT2S2PC(L/R)7230() () () () ()	1,219.	1,501.	1,549.	1,680.	1,978.	
		29 ³ / ₄ "	78"	28 ³ / ₄ "	APRT2S2PC(L/R)7830() () () () ()	1,244.	1,539.	1,589.	1,730.	2,043.	
		29 ³ / ₄ "	84"	28 ³ / ₄ "	APRT2S2PC(L/R)8430() () () () ()	1,264.	1,575.	1,627.	1,768.	2,099.	
		29 ³ / ₄ "	90"	28 ³ / ₄ "	APRT2S2PC(L/R)9030() () () () ()	1,318.	1,614.	1,668.	1,822.	2,163.	
		29 ³ / ₄ "	96"	28 ³ / ₄ "	APRT2S2PC(L/R)9630() () () () ()	1,339.	1,650.	1,705.	1,860.	2,214.	
		36"	28 ³ / ₈ "	60"	27"	APRT2S1PC(L/R)6036() () () () ()	1,216.	1,547.	1,597.	1,734.	2,046.
		28 ³ / ₈ "	66"	27"	APRT2S1PC(L/R)6636() () () () ()	1,253.	1,556.	1,607.	1,746.	2,069.	
		28 ³ / ₈ "	72"	27"	APRT2S1PC(L/R)7236() () () () ()	1,262.	1,580.	1,632.	1,778.	2,106.	
		28 ³ / ₈ "	78"	27"	APRT2S1PC(L/R)7836() () () () ()	1,293.	1,602.	1,655.	1,804.	2,142.	
		28 ³ / ₈ "	84"	27"	APRT2S1PC(L/R)8436() () () () ()	1,312.	1,637.	1,692.	1,851.	2,202.	
		28 ³ / ₈ "	90"	27"	APRT2S1PC(L/R)9036() () () () ()	1,368.	1,683.	1,740.	1,902.	2,269.	
28 ³ / ₈ "	96"	27"	APRT2S1PC(L/R)9636() () () () ()	1,393.	1,718.	1,778.	1,939.	2,317.			
29 ³ / ₄ "	60"	28 ³ / ₄ "	APRT2S2PC(L/R)6036() () () () ()	1,216.	1,547.	1,597.	1,734.	2,046.			
29 ³ / ₄ "	66"	28 ³ / ₄ "	APRT2S2PC(L/R)6636() () () () ()	1,253.	1,556.	1,607.	1,746.	2,069.			
29 ³ / ₄ "	72"	28 ³ / ₄ "	APRT2S2PC(L/R)7236() () () () ()	1,262.	1,580.	1,632.	1,778.	2,106.			
29 ³ / ₄ "	78"	28 ³ / ₄ "	APRT2S2PC(L/R)7836() () () () ()	1,293.	1,602.	1,655.	1,804.	2,142.			
29 ³ / ₄ "	84"	28 ³ / ₄ "	APRT2S2PC(L/R)8436() () () () ()	1,312.	1,637.	1,692.	1,851.	2,202.			
29 ³ / ₄ "	90"	28 ³ / ₄ "	APRT2S2PC(L/R)9036() () () () ()	1,368.	1,683.	1,740.	1,902.	2,269.			
29 ³ / ₄ "	96"	28 ³ / ₄ "	APRT2S2PC(L/R)9636() () () () ()	1,393.	1,718.	1,778.	1,939.	2,317.			

Order Code	Specification Information	Application Notes
Example: APRT2S1PC(L/R)6030	<i>To order please specify pattern number including:</i>	
A AutoStrada		
PR Peninsula Rectilinear		
T2 Tapered 2 sides; user and approach		
S1 27" h Straight leg		
PC Power center		
L Left hand		
60 Width		
30 Depth		
M Grommet option		
111 Grommet finish		
V316 Finish, Top		
111 Finish, Leg		
111 Finish, Stand-off		
	1. Leg height S1 = 27" high S2 = 28 3/8" high	
	2. Hand L = Left hand R = Right hand	
	3. Grommet option P = Power Center PE = Power center grommet	
	4. Finish, Grommet Painted or plated	
	5. Finish, Top Laminate, V1, V2 or V3 finish	
	6. Finish, Edge Must be same as surface finish unless M surface type specified, then must be V1, V2 or V3 finish	
	7. Finish, Leg Anodized aluminum or painted finish option, excluding silver.	From users perspective, if the leg is on the right side, the peninsula is classified a "Right Hand" peninsula.
	8. Finish, Stand-off Painted finish only	Peninsula worksurfaces with power center do not come with Electrical Components.
	See page 8 for finish options applicable.	Products on this page work with 28 3/8" height planning.
	Product on this page will accept wood grain laminate where laminate is currently an option.	
	Worksurface stiffeners are recommended to provide additional support for open spans greater than 48" w.	
	Modesties sold separately and can be field installed.	
	Wire chase sold separately.	

Peninsulas

with L- legs and simple stand-off

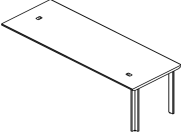
description	d	h	w	leg height	pattern no.	L	M	V1	V2	V3	
Rectangular peninsulas, tapered 2 sides with straight legs and simple stand-off		28 ³ / ₈ "	60"	27"	APRT2L1ST(L/R)6030	\$1,439.	\$1,721.	\$1,767.	\$1,892.	\$2,178.	
		28 ³ / ₈ "	66"	27"	APRT2L1ST(L/R)6630	1,476.	1,739.	1,786.	1,916.	2,208.	
		28 ³ / ₈ "	72"	27"	APRT2L1ST(L/R)7230	1,478.	1,760.	1,808.	1,939.	2,237.	
		28 ³ / ₈ "	78"	27"	APRT2L1ST(L/R)7830	1,503.	1,798.	1,848.	1,989.	2,302.	
		28 ³ / ₈ "	84"	27"	APRT2L1ST(L/R)8430	1,523.	1,834.	1,886.	2,027.	2,358.	
		28 ³ / ₈ "	90"	27"	APRT2L1ST(L/R)9030	1,577.	1,873.	1,927.	2,081.	2,422.	
		28 ³ / ₈ "	96"	27"	APRT2L1ST(L/R)9630	1,598.	1,909.	1,964.	2,119.	2,473.	
		29 ³ / ₄ "	60"	28 ³ / ₄ "	APRT2L2ST(L/R)6030	1,439.	1,721.	1,767.	1,892.	2,178.	
		29 ³ / ₄ "	66"	28 ³ / ₄ "	APRT2L2ST(L/R)6630	1,476.	1,739.	1,786.	1,916.	2,208.	
		29 ³ / ₄ "	72"	28 ³ / ₄ "	APRT2L2ST(L/R)7230	1,478.	1,760.	1,808.	1,939.	2,237.	
		29 ³ / ₄ "	78"	28 ³ / ₄ "	APRT2L2ST(L/R)7830	1,503.	1,798.	1,848.	1,989.	2,302.	
		29 ³ / ₄ "	84"	28 ³ / ₄ "	APRT2L2ST(L/R)8430	1,523.	1,834.	1,886.	2,027.	2,358.	
		29 ³ / ₄ "	90"	28 ³ / ₄ "	APRT2L2ST(L/R)9030	1,577.	1,873.	1,927.	2,081.	2,422.	
		29 ³ / ₄ "	96"	28 ³ / ₄ "	APRT2L2ST(L/R)9630	1,598.	1,909.	1,964.	2,119.	2,473.	
		36"	28 ³ / ₈ "	60"	28 ³ / ₄ "	APRT1L2ST(L/R)6036	1,475.	1,806.	1,856.	1,993.	2,305.
		28 ³ / ₈ "	66"	27"	APRT2L1ST(L/R)6636	1,512.	1,815.	1,866.	2,005.	2,328.	
		28 ³ / ₈ "	72"	28 ³ / ₄ "	APRT2L1ST(L/R)7236	1,521.	1,839.	1,891.	2,037.	2,365.	
		28 ³ / ₈ "	78"	27"	APRT2L1ST(L/R)7836	1,552.	1,861.	1,914.	2,063.	2,401.	
		28 ³ / ₈ "	84"	27"	APRT2L1ST(L/R)8436	1,571.	1,896.	1,951.	2,110.	2,461.	
		28 ³ / ₈ "	90"	28 ³ / ₄ "	APRT2L1ST(L/R)9036	1,627.	1,942.	1,999.	2,161.	2,528.	
28 ³ / ₈ "	96"	27"	APRT2L1ST(L/R)9636	1,652.	1,977.	2,037.	2,198.	2,576.			
29 ³ / ₄ "	60"	28 ³ / ₄ "	APRT2L1ST(L/R)6036	1,475.	1,806.	1,856.	1,993.	2,305.			
29 ³ / ₄ "	66"	28 ³ / ₄ "	APRT2L2ST(L/R)6636	1,512.	1,815.	1,866.	2,005.	2,328.			
29 ³ / ₄ "	72"	28 ³ / ₄ "	APRT2L2ST(L/R)7236	1,521.	1,839.	1,891.	2,037.	2,365.			
29 ³ / ₄ "	78"	28 ³ / ₄ "	APRT2L2ST(L/R)7836	1,552.	1,861.	1,914.	2,063.	2,401.			
29 ³ / ₄ "	84"	28 ³ / ₄ "	APRT2L2ST(L/R)8436	1,571.	1,896.	1,951.	2,110.	2,461.			
29 ³ / ₄ "	90"	28 ³ / ₄ "	APRT2L2ST(L/R)9036	1,627.	1,942.	1,999.	2,161.	2,528.			
29 ³ / ₄ "	96"	28 ³ / ₄ "	APRT2L2ST(L/R)9636	1,652.	1,977.	2,037.	2,198.	2,576.			

Worksurfaces

Order Code	Specification Information	Application Notes
Example: APRT2L1ST(L/R)6030	<i>To order please specify pattern number including:</i>	
A AutoStrada		
PR Peninsula Rectilinear		
T2 Tapered 2 sides; user and approach		
L1 27" h L-leg		
ST Simple stand-off		
L Left hand		
60 Width		
30 Depth		
M Grommet option		
111 Grommet finish		
V316 Finish, Top		
111 Finish, Leg		
111 Finish, Stand-off		
	<ol style="list-style-type: none"> Leg height L1 = 27" high L2 = 28 3/8" high Hand L = Left hand R = Right hand Grommet option M = Mid grommet N = No grommet S = Stand-off SE = Stand-off, end location SD = Stand-off with drop in box SDR = Right hand stand-off with drop in box SDL = Left hand stand-off with drop in box Note: SD, SDR and SDL are only factory cut out, no grommet option is necessary. Finish, Grommet Painted or plated Finish, Top Laminate, V1, V2 or V3 finish Finish, Edge Must be same as surface finish unless M surface type specified, then must be V1, V2 or V3 finish Finish, Leg Anodized aluminum or painted finish option, excluding silver. Finish, Stand-off Painted finish only 	<p>From users perspective, if the leg is on the right side, the peninsula is classified a "Right Hand" peninsula.</p> <p>Peninsula worksurfaces with power center do not come with Electrical Components.</p> <p>Products on this page work with 28³/₈" height planning.</p> <p>Worksurface stiffeners are recommended to provide additional support for open spans greater than 48" w.</p> <p>Modesties sold separately and can be field installed.</p> <p>Wire chase sold separately.</p>

Peninsulas

with L- legs and simple stand-off with power center

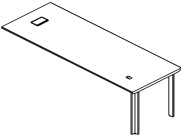
description	d	h	w	leg height	pattern no.	L	M	V1	V2	V3	
Rectangular peninsulas, tapered 2 sides with straight legs and simple stand-off with power center		30"	28 ³ / ₈ "	60"	27"	APRT2L1PC(L/R)6030() () () () ()	\$1,470.	\$1,752.	\$1,798.	\$1,923.	\$2,209.
		28 ³ / ₈ "	66"	27"	APRT2L1PC(L/R)6630() () () () ()	1,507.	1,770.	1,817.	1,947.	2,239.	
		28 ³ / ₈ "	72"	27"	APRT2L1PC(L/R)7230() () () () ()	1,509.	1,791.	1,839.	1,970.	2,268.	
		28 ³ / ₈ "	78"	27"	APRT2L1PC(L/R)7830() () () () ()	1,534.	1,829.	1,879.	2,020.	2,333.	
		28 ³ / ₈ "	84"	27"	APRT2L1PC(L/R)8430() () () () ()	1,554.	1,865.	1,917.	2,058.	2,389.	
		28 ³ / ₈ "	90"	27"	APRT2L1PC(L/R)9030() () () () ()	1,608.	1,904.	1,958.	2,112.	2,453.	
		28 ³ / ₈ "	96"	27"	APRT2L1PC(L/R)9630() () () () ()	1,629.	1,940.	1,995.	2,150.	2,504.	
		29 ³ / ₄ "	60"	28 ³ / ₄ "	APRT2L2PC(L/R)6030() () () () ()	1,470.	1,752.	1,798.	1,923.	2,209.	
		29 ³ / ₄ "	66"	28 ³ / ₄ "	APRT2L2PC(L/R)6630() () () () ()	1,507.	1,770.	1,817.	1,947.	2,239.	
		29 ³ / ₄ "	72"	28 ³ / ₄ "	APRT2L2PC(L/R)7230() () () () ()	1,509.	1,791.	1,839.	1,970.	2,268.	
		29 ³ / ₄ "	78"	28 ³ / ₄ "	APRT2L2PC(L/R)7830() () () () ()	1,534.	1,829.	1,879.	2,020.	2,333.	
		29 ³ / ₄ "	84"	28 ³ / ₄ "	APRT2L2PC(L/R)8430() () () () ()	1,554.	1,865.	1,917.	2,058.	2,389.	
		29 ³ / ₄ "	90"	28 ³ / ₄ "	APRT2L2PC(L/R)9030() () () () ()	1,608.	1,904.	1,958.	2,112.	2,453.	
		29 ³ / ₄ "	96"	28 ³ / ₄ "	APRT2L2PC(L/R)9630() () () () ()	1,629.	1,940.	1,995.	2,150.	2,504.	
		36"	28 ³ / ₈ "	60"	27"	APRT2L1PC(L/R)6036() () () () ()	1,506.	1,837.	1,887.	2,024.	2,336.
		28 ³ / ₈ "	66"	27"	APRT2L1PC(L/R)6636() () () () ()	1,543.	1,846.	1,897.	2,036.	2,359.	
		28 ³ / ₈ "	72"	27"	APRT2L1PC(L/R)7236() () () () ()	1,552.	1,870.	1,922.	2,068.	2,396.	
		28 ³ / ₈ "	78"	27"	APRT2L1PC(L/R)7836() () () () ()	1,583.	1,892.	1,945.	2,094.	2,432.	
		28 ³ / ₈ "	84"	27"	APRT2L1PC(L/R)8436() () () () ()	1,602.	1,927.	1,982.	2,141.	2,492.	
		28 ³ / ₈ "	90"	27"	APRT2L1PC(L/R)9036() () () () ()	1,658.	1,973.	2,030.	2,192.	2,559.	
28 ³ / ₈ "	96"	27"	APRT2L1PC(L/R)9636() () () () ()	1,683.	2,008.	2,068.	2,229.	2,607.			
29 ³ / ₄ "	60"	28 ³ / ₄ "	APRT2L2PC(L/R)6036() () () () ()	1,506.	1,837.	1,887.	2,024.	2,336.			
29 ³ / ₄ "	66"	28 ³ / ₄ "	APRT2L2PC(L/R)6636() () () () ()	1,543.	1,846.	1,897.	2,036.	2,359.			
29 ³ / ₄ "	72"	28 ³ / ₄ "	APRT2L2PC(L/R)7236() () () () ()	1,552.	1,870.	1,922.	2,068.	2,396.			
29 ³ / ₄ "	78"	28 ³ / ₄ "	APRT2L2PC(L/R)7836() () () () ()	1,583.	1,892.	1,945.	2,094.	2,432.			
29 ³ / ₄ "	84"	28 ³ / ₄ "	APRT2L2PC(L/R)8436() () () () ()	1,602.	1,927.	1,982.	2,141.	2,492.			
29 ³ / ₄ "	90"	28 ³ / ₄ "	APRT2L2PC(L/R)9036() () () () ()	1,658.	1,973.	2,030.	2,192.	2,559.			
29 ³ / ₄ "	96"	28 ³ / ₄ "	APRT2L2PC(L/R)9636() () () () ()	1,683.	2,008.	2,068.	2,229.	2,607.			

Order Code	Specification Information	Application Notes
Example: APRT2L1PC(L/R)6030	To order please specify pattern number including:	
A AutoStrada		
PR Peninsula Rectilinear		
T2 Tapered 2 sides; user and approach		
L1 27" h L-leg		
PC Power center		
L Left hand		
60 Width		
30 Depth		
M Grommet option		
111 Grommet finish		
V316 Finish, Top		
111 Finish, Leg		
111 Finish, Stand-off		
	1. Leg height L1 = 27" high L2 = 28 3/8" high	
	2. Hand L = Left hand R = Right hand	
	3. Grommet option P = Power Center PE = Power center grommet	
	4. Finish, Grommet Painted or plated	
	5. Finish, Top Laminate, V1, V2 or V3 finish	
	6. Finish, Edge Must be same as surface finish unless M surface type specified, then must be V1, V2 or V3 finish	
	7. Finish, Leg Anodized aluminum or painted finish option, excluding silver.	From users perspective, if the leg is on the right side, the peninsula is classified a "Right Hand" peninsula.
	8. Finish, Stand-off Painted finish only	Peninsula worksurfaces with power center do not come with Electrical Components.
	See page 8 for finish options applicable.	Products on this page work with 28 ³ / ₈ " height planning.
	Product on this page will accept wood grain laminate where laminate is currently an option.	
	Worksurface stiffeners are recommended to provide additional support for open spans greater than 48" w.	
	Modesties sold separately and can be field installed.	
	Wire chase sold separately.	

Peninsulas

with Open frame legs and simple stand-off

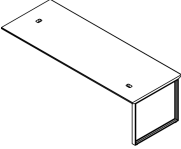
description	d	h	w	leg height	pattern no.	L	M	V1	V2	V3	
Rectangular peninsulas, tapered 2 sides with straight legs and simple stand-off		30"	28 ³ / ₈ "	60"	27"	APRT2O1ST(L/R)6030() () () () ()	\$1,367.	\$1,649.	\$1,695.	\$1,820.	\$2,106.
		28 ³ / ₈ "	66"	27"	APRT2O1ST(L/R)6630() () () () ()	1,404.	1,667.	1,714.	1,844.	2,136.	
		28 ³ / ₈ "	72"	27"	APRT2O1ST(L/R)7230() () () () ()	1,406.	1,688.	1,736.	1,867.	2,165.	
		28 ³ / ₈ "	78"	27"	APRT2O1ST(L/R)7830() () () () ()	1,431.	1,726.	1,776.	1,917.	2,230.	
		28 ³ / ₈ "	84"	27"	APRT2O1ST(L/R)8430() () () () ()	1,451.	1,762.	1,814.	1,955.	2,286.	
		28 ³ / ₈ "	84"	27"	APRT2O1ST(L/R)9030() () () () ()	1,505.	1,801.	1,855.	2,009.	2,350.	
		28 ³ / ₈ "	96"	27"	APRT2O1ST(L/R)9630() () () () ()	1,526.	1,837.	1,892.	2,047.	2,401.	
		29 ³ / ₄ "	60"	28 ³ / ₄ "	APRT2O2ST(L/R)6030() () () () ()	1,367.	1,649.	1,695.	1,820.	2,106.	
		29 ³ / ₄ "	66"	28 ³ / ₄ "	APRT2O2ST(L/R)6630() () () () ()	1,404.	1,667.	1,714.	1,844.	2,136.	
		29 ³ / ₄ "	72"	28 ³ / ₄ "	APRT2O2ST(L/R)7230() () () () ()	1,406.	1,688.	1,736.	1,867.	2,165.	
		29 ³ / ₄ "	78"	28 ³ / ₄ "	APRT2O2ST(L/R)7830() () () () ()	1,431.	1,726.	1,776.	1,917.	2,230.	
		29 ³ / ₄ "	84"	28 ³ / ₄ "	APRT2O2ST(L/R)8430() () () () ()	1,451.	1,762.	1,814.	1,955.	2,286.	
		29 ³ / ₄ "	90"	28 ³ / ₄ "	APRT2O2ST(L/R)9030() () () () ()	1,505.	1,801.	1,855.	2,009.	2,350.	
		29 ³ / ₄ "	96"	28 ³ / ₄ "	APRT2O2ST(L/R)9630() () () () ()	1,526.	1,837.	1,892.	2,047.	2,401.	
		36"	28 ³ / ₈ "	60"	27"	APRT2O1ST(L/R)6036() () () () ()	1,403.	1,734.	1,784.	1,921.	2,233.
			28 ³ / ₈ "	66"	27"	APRT2O1ST(L/R)6636() () () () ()	1,440.	1,743.	1,794.	1,933.	2,256.
			28 ³ / ₈ "	72"	27"	APRT2O1ST(L/R)7236() () () () ()	1,449.	1,767.	1,819.	1,965.	2,293.
			28 ³ / ₈ "	78"	27"	APRT2O1ST(L/R)7836() () () () ()	1,480.	1,789.	1,842.	1,991.	2,329.
			28 ³ / ₈ "	78"	27"	APRT2O1ST(L/R)8436() () () () ()	1,499.	1,824.	1,879.	2,038.	2,389.
			28 ³ / ₈ "	90"	27"	APRT2O1ST(L/R)9036() () () () ()	1,555.	1,870.	1,927.	2,089.	2,456.
28 ³ / ₈ "	96"		27"	APRT2O1ST(L/R)9636() () () () ()	1,580.	1,905.	1,965.	2,126.	2,504.		
29 ³ / ₄ "	60"		28 ³ / ₄ "	APRT2O2ST(L/R)6036() () () () ()	1,403.	1,734.	1,784.	1,921.	2,233.		
29 ³ / ₄ "	66"		28 ³ / ₄ "	APRT2O2ST(L/R)6636() () () () ()	1,440.	1,743.	1,794.	1,933.	2,256.		
29 ³ / ₄ "	72"		28 ³ / ₄ "	APRT2O2ST(L/R)7236() () () () ()	1,449.	1,767.	1,819.	1,965.	2,293.		
29 ³ / ₄ "	78"		28 ³ / ₄ "	APRT2O2ST(L/R)7836() () () () ()	1,480.	1,789.	1,842.	1,991.	2,329.		
29 ³ / ₄ "	84"		28 ³ / ₄ "	APRT2O2ST(L/R)8436() () () () ()	1,499.	1,824.	1,879.	2,038.	2,389.		
29 ³ / ₄ "	90"		28 ³ / ₄ "	APRT2O2ST(L/R)9036() () () () ()	1,555.	1,870.	1,927.	2,089.	2,456.		
29 ³ / ₄ "	96"		28 ³ / ₄ "	APRT2O2ST(L/R)9636() () () () ()	1,580.	1,905.	1,965.	2,126.	2,504.		

Worksurfaces

Order Code	Specification Information	Application Notes
Example: APRT2O1ST(L/R)6030	<i>To order please specify pattern number including:</i>	
A AutoStrada		
PR Peninsula Rectilinear		
T2 Tapered 2 sides; user and approach		
O1 27" h Open frame leg		
ST Simple stand-off		
L Left hand		
60 Width		
30 Depth		
M Grommet option		
111 Grommet finish		
V316 Finish, Top		
111 Finish, Leg		
111 Finish, Stand-off		
	<ol style="list-style-type: none"> Leg height O1 = 27" high O2 = 28 3/8" high Hand L = Left hand R = Right hand Grommet option M = Mid grommet N = No grommet S = Stand-off SE = Stand-off, end location SD = Stand-off with drop in box SDR = Right hand stand-off with drop in box SDL = Left hand stand-off with drop in box Note: SD, SDR and SDL are only factory cut out, no grommet option is necessary. Finish, Grommet Painted or plated Finish, Top Laminate, V1, V2 or V3 finish Finish, Edge Must be same as surface finish unless M surface type specified, then must be V1, V2 or V3 finish Finish, Leg Anodized aluminum or painted finish option, excluding silver. Finish, Stand-off Painted finish only 	<p>From users perspective, if the leg is on the right side, the peninsula is classified a "Right Hand" peninsula.</p> <p>Peninsula worksurfaces with power center do not come with Electrical Components.</p> <p>Products on this page work with 28³/₈" height planning.</p> <p>Worksurface stiffeners are recommended to provide additional support for open spans greater than 48" w.</p> <p>Modesties sold separately and can be field installed.</p> <p>Wire chase sold separately.</p>

with Open frame legs and simple stand-off with power center

description	d	h	w	leg height	pattern no.	L	M	V1	V2	V3	
Rectangular peninsulas, tapered 2 sides with straight legs and simple stand-off with power center	30"	28 ³ / ₈ "	60"	27"	APRT2O1PC(L/R)6030() () () () ()	\$1,398.	\$1,680.	\$1,726.	\$1,851.	\$2,137.	
		28 ³ / ₈ "	66"	27"	APRT2O1PC(L/R)6630() () () () ()	1,435.	1,698.	1,745.	1,875.	2,167.	
		28 ³ / ₈ "	72"	27"	APRT2O1PC(L/R)7230() () () () ()	1,437.	1,719.	1,767.	1,898.	2,196.	
		28 ³ / ₈ "	78"	27"	APRT2O1PC(L/R)7830() () () () ()	1,462.	1,757.	1,807.	1,948.	2,261.	
		28 ³ / ₈ "	84"	27"	APRT2O1PC(L/R)8430() () () () ()	1,482.	1,793.	1,845.	1,986.	2,137.	
		28 ³ / ₈ "	90"	27"	APRT2O1PC(L/R)9030() () () () ()	1,537.	1,832.	1,886.	2,040.	2,381.	
		28 ³ / ₈ "	96"	27"	APRT2O1PC(L/R)9630() () () () ()	1,557.	1,868.	1,923.	2,078.	2,432.	
		29 ³ / ₄ "	60"	28 ³ / ₄ "	APRT2O2PC(L/R)6030() () () () ()	1,398.	1,680.	1,726.	1,851.	2,137.	
		29 ³ / ₄ "	66"	28 ³ / ₄ "	APRT2O2PC(L/R)6630() () () () ()	1,435.	1,698.	1,745.	1,875.	2,167.	
		29 ³ / ₄ "	72"	28 ³ / ₄ "	APRT2O2PC(L/R)7230() () () () ()	1,437.	1,719.	1,767.	1,898.	2,196.	
		29 ³ / ₄ "	78"	28 ³ / ₄ "	APRT2O2PC(L/R)7830() () () () ()	1,462.	1,757.	1,807.	1,948.	2,261.	
		29 ³ / ₄ "	84"	28 ³ / ₄ "	APRT2O2PC(L/R)8430() () () () ()	1,482.	1,793.	1,845.	1,986.	2,317.	
		29 ³ / ₄ "	90"	28 ³ / ₄ "	APRT2O2PC(L/R)9030() () () () ()	1,537.	1,832.	1,886.	2,040.	2,381.	
		29 ³ / ₄ "	96"	28 ³ / ₄ "	APRT2O2PC(L/R)9630() () () () ()	1,557.	1,868.	1,923.	2,078.	2,432.	
		36"	28 ³ / ₈ "	60"	27"	APRT2O1PC(L/R)6036() () () () ()	1,434.	1,765.	1,815.	1,952.	2,264.
			28 ³ / ₈ "	66"	27"	APRT2O1PC(L/R)6636() () () () ()	1,471.	1,774.	1,825.	1,964.	2,287.
			28 ³ / ₈ "	72"	27"	APRT2O1PC(L/R)7236() () () () ()	1,480.	1,798.	1,850.	1,996.	2,324.
			28 ³ / ₈ "	78"	27"	APRT2O1PC(L/R)7836() () () () ()	1,511.	1,820.	1,873.	2,022.	2,360.
			28 ³ / ₈ "	84"	27"	APRT2O1PC(L/R)8436() () () () ()	1,530.	1,855.	1,910.	2,069.	2,420.
			28 ³ / ₈ "	90"	27"	APRT2O1PC(L/R)9036() () () () ()	1,586.	1,901.	1,958.	2,120.	2,487.
		28 ³ / ₈ "	96"	27"	APRT2O1PC(L/R)9636() () () () ()	1,611.	1,936.	1,996.	2,157.	2,535.	
		29 ³ / ₄ "	60"	28 ³ / ₄ "	APRT2O2PC(L/R)6036() () () () ()	1,434.	1,765.	1,815.	1,952.	2,264.	
		29 ³ / ₄ "	66"	28 ³ / ₄ "	APRT2O2PC(L/R)6636() () () () ()	1,471.	1,774.	1,825.	1,964.	2,287.	
		29 ³ / ₄ "	72"	28 ³ / ₄ "	APRT2O2PC(L/R)7236() () () () ()	1,480.	1,798.	1,850.	1,996.	2,324.	
		29 ³ / ₄ "	78"	28 ³ / ₄ "	APRT2O2PC(L/R)7836() () () () ()	1,511.	1,820.	1,873.	2,022.	2,360.	
		29 ³ / ₄ "	84"	28 ³ / ₄ "	APRT2O2PC(L/R)8436() () () () ()	1,530.	1,855.	1,910.	2,069.	2,420.	
		29 ³ / ₄ "	90"	28 ³ / ₄ "	APRT2O2PC(L/R)9036() () () () ()	1,586.	1,901.	1,958.	2,120.	2,487.	
		29 ³ / ₄ "	96"	28 ³ / ₄ "	APRT2O2PC(L/R)9636() () () () ()	1,611.	1,936.	1,996.	2,157.	2,535.	

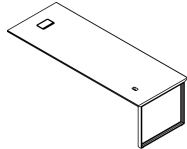

Order Code	Specification Information	Application Notes
Example: APRT2O1PC(L/R)6030	To order please specify pattern number including:	
A AutoStrada		
PR Peninsula Rectilinear		
T2 Tapered 2 sides; user and approach		
O1 27" h Open frame leg		
PC Power center		
L Left hand		
60 Width		
30 Depth		
M Grommet option		
111 Grommet finish		
V316 Finish, Top		
111 Finish, Leg		
111 Finish, Stand-off		
	1. Leg height O1 = 27" high O2 = 28 3/8" high	
	2. Hand L = Left hand R = Right hand	
	3. Grommet option P = Power Center PE = Power center grommet	
	4. Finish, Grommet Painted or plated	
	5. Finish, Top Laminate, V1, V2 or V3 finish	
	6. Finish, Edge Must be same as surface finish unless M surface type specified, then must be V1, V2 or V3 finish	
	7. Finish, Leg Anodized aluminum or painted finish option, excluding silver.	From users perspective, if the leg is on the right side, the peninsula is classified a "Right Hand" peninsula.
	8. Finish, Stand-off Painted finish only	Peninsula worksurfaces with power center do not come with Electrical Components.
	See page 8 for finish options applicable.	Products on this page work with 28 ³ / ₈ " height planning.
	Product on this page will accept wood grain laminate where laminate is currently an option.	
	Worksurface stiffeners are recommended to provide additional support for open spans greater than 48" w.	
	Modesties sold separately and can be field installed.	
	Wire chase sold separately.	

Tables with straight legs

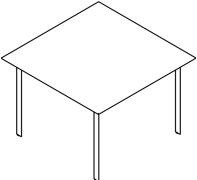
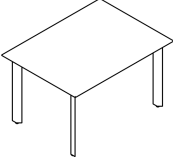
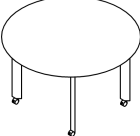
description	h	w	d	dia.	pattern no.	L	M	V1	V2	V3
Square table, tapered 4 sides 	28 1/4"	42"	42"		ATA1T44242 () () () ()	\$1,632.	\$1,810.	\$1,900.	\$1,938.	\$2,244.
	28 1/4"	48"	48"		ATA1T44848 () () () ()	1,766.	1,853.	1,946.	2,000.	2,384.
Rectangular table, tapered 4 sides 	28 1/4"	48"	30"		ATA1T44830 () () () ()	1,666.	1,794.	1,883.	1,909.	2,176.
	28 1/4"	60"	30"		ATA1T46030 () () () ()	1,756.	1,893.	1,987.	2,028.	2,348.
	28 1/4"	72"	30"		ATA1T47230 () () () ()	1,844.	1,930.	2,027.	2,075.	2,450.
	28 1/4"	72"	36"		ATA1T47236 () () () ()	1,888.	1,962.	2,060.	2,124.	2,562.
Round table, tapered edge 	28 1/4"		36"		ATA1R36 () () () ()	1,692.	1,941.	1,843.	1,902.	2,159.
	28 1/4"		42"		ATA1R42 () () () ()	1,772.	1,977.	1,886.	1,959.	2,294.
	28 1/4"		48"		ATA1R48 () () () ()	1,916.	2,023.	1,939.	2,027.	2,447.

Worksurfaces

Order Code	Specification Information	Application Notes
Example: ATA1T44242V27C V316AA	<i>To order please specify pattern number including:</i>	7. Finish, Edge <i>Must be same as surface finish unless M surface type specified, then must be V1, V2 or V3 finish</i>
A AutoStrada	1. Width	7. Finish, Leg <i>Anodized aluminum finish or painted finish option excluding silver.</i>
TA Table	2. Depth	See page 8 for finish options applicable.
1 Generation 1	3. Surface type <i>L = Laminate M = Mixed, Laminate surface/V1, V2 or V3 edge V = V1, V2 or V3</i>	Product on this page will accept wood grain laminate where laminate is currently an option.
T4 Tapered edge 4 sides	4. Leg height (to underside of surface) <i>27 = 27" h 28 = 28 3/8" h (add \$30 for this option) 30 = 30 1/8" h (add \$66 for this option)</i>	Grommets are not optional for tables.
42 42" wide	5. Leg type <i>C = with Caster G = with Glide</i>	Stiffener included with rectangular tables 60" w and over.
42 42" deep	6. Finish, Surface <i>Laminate, Mixed, V1, V2 or V3 finish</i>	
V Surface type, veneer		
27 27" leg height		
C Caster		
V316 Finish top, Maple		
AA Finish, leg		

Tables with L-legs

description	h	w	d	dia.	leg height	pattern no.	L	M	V1	V2	V3
Square table, tapered 4 sides with L-legs	28 ³ / ₈ "	42"	42"		27"	ATAT4LL424227(L/M/V)() ()	\$2,367.	\$2,630.	\$2,761.	\$2,817.	\$3,240.
	28 ³ / ₈ "	48"	48"		27"	ATAT4LL484827(L/M/V)() ()	2,382.	2,646.	2,778.	2,835.	3,259.
	29 ³ / ₄ "	42"	42"		28 ³ / ₈ "	ATAT4LL424228(L/M/V)() ()	2,371.	2,635.	2,767.	2,823.	3,248.
	29 ³ / ₄ "	48"	48"		28 ³ / ₈ "	ATAT4LL484828(L/M/V)() ()	2,412.	2,678.	2,812.	2,869.	3,300.

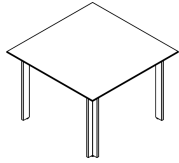

Round table, tapered edge with L-legs	28 ³ / ₈ "		36"	27"		ATARLL3627(L/M/V)() ()	2,304.	2,560.	2,688.	2,742.	3,153.
	28 ³ / ₈ "		42"	27"		ATARLL4227(L/M/V)() ()	2,310.	2,568.	2,696.	2,750.	3,163.
	28 ³ / ₈ "		48"	27"		ATARLL4827(L/M/V)() ()	2,323.	2,580.	2,709.	2,766.	3,181.
	29 ³ / ₄ "		36"	28 ³ / ₈ "		ATARLL3628(L/M/V)() ()	2,343.	2,603.	2,733.	2,788.	3,207.
	29 ³ / ₄ "		42"	28 ³ / ₈ "		ATARLL4228(L/M/V)() ()	2,349.	2,610.	2,741.	2,797.	3,216.
	29 ³ / ₄ "		48"	28 ³ / ₈ "		ATARLL4828(L/M/V)() ()	2,363.	2,623.	2,754.	2,812.	3,233.



Rectangular table desk, tapered 4 sides with L-legs	28 ³ / ₈ "	48"	30"		27"	ATDT4LL483027(L/M/V)() ()	2,162.	2,401.	2,521.	2,574.	2,960.
	28 ³ / ₈ "	60"	30"		27"	ATDT4LL603027(L/M/V)() ()	2,201.	2,444.	2,567.	2,620.	3,012.
	28 ³ / ₈ "	72"	30"		27"	ATDT4LL723027(L/M/V)() ()	2,219.	2,466.	2,590.	2,642.	3,039.
	28 ³ / ₈ "	72"	36"		27"	ATDT4LL723627(L/M/V)() ()	2,239.	2,488.	2,612.	2,667.	3,065.
	29 ³ / ₄ "	48"	30"		28 ³ / ₈ "	ATDT4LL483028(L/M/V)() ()	2,248.	2,499.	2,624.	2,678.	3,078.
	29 ³ / ₄ "	60"	30"		28 ³ / ₈ "	ATDT4LL603028(L/M/V)() ()	2,307.	2,565.	2,693.	2,747.	3,160.
	29 ³ / ₄ "	72"	30"		28 ³ / ₈ "	ATDT4LL723028(L/M/V)() ()	2,356.	2,618.	2,749.	2,805.	3,226.
	29 ³ / ₄ "	72"	36"		28 ³ / ₈ "	ATDT4LL723628(L/M/V)() ()	2,395.	2,661.	2,794.	2,852.	3,278.

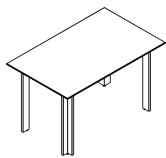

Order Code	Specification Information	Application Notes
Example: ATAT4LL424227 V316AA	<i>To order please specify pattern number including:</i>	AutoStrada table desks include four L-legs with glides.
A AutoStrada	1. Width	Tables can be specified to overall surface height of: 28 ³ / ₈ " : specify 27" leg. 29 ³ / ₈ " : specify 28" leg.
TA Table	2. Depth	
T4 Top tapered 4 sides	3. Leg height (<i>to underside of surface</i>) 27 = 27"h 28 = 28 ³ / ₈ "h	
LL L-Leg	4. Surface type L = Laminate M = Mixed, Laminate surface/V1, V2 or V3 edge V = V1, V2 or V3	
42 42" wide	5. Finish, Surface Laminate, Mixed, V1, V2 or V3 finish	6. Finish, Edge (if applicable) <i>Must be same as surface finish unless M surface type specified, then must be V1, V2 or V3 finish</i>
42 42" deep		7. Finish, Leg <i>Anodized aluminum finish or painted finish option excluding silver.</i>
27 Leg height		See page 8 for finish options applicable.
V Surface type, veneer		Product on this page will accept wood grain laminate where laminate is currently an option.
V316 Finish top, Maple		Grommets are not optional for tables.
AA Finish, leg		Worksurface stiffener included with rectangular table desks 60"w and over.

Table desks with L-legs

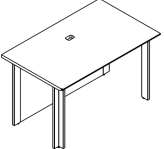
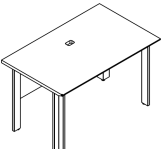
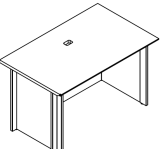
description	h	w	d	leg height	pattern no.	L	M	V1	V2	V3
Rectangular table desk with L-legs and full front modesty 	28 ³ / ₈ "	48"	30"	27"	ATDT1LFM483027(L/M/V)() () () ()	\$2,661.	\$2,957.	\$3,104.	\$3,169.	\$3,644.
	28 ³ / ₈ "	60"	30"	27"	ATDT1LFM603027(L/M/V)() () () ()	2,701.	3,001.	3,151.	3,215.	3,697.
	28 ³ / ₈ "	72"	30"	27"	ATDT1LFM723027(L/M/V)() () () ()	2,733.	3,037.	3,189.	3,253.	3,741.
	28 ³ / ₈ "	72"	36"	27"	ATDT1LFM723627(L/M/V)() () () ()	2,751.	3,058.	3,210.	3,276.	3,766.
	29 ³ / ₄ "	48"	30"	28 ³ / ₈ "	ATDT1LFM483028(L/M/V)() () () ()	2,807.	3,117.	3,273.	3,339.	3,841.
	29 ³ / ₄ "	60"	30"	28 ³ / ₈ "	ATDT1LFM603028(L/M/V)() () () ()	2,811.	3,122.	3,278.	3,345.	3,848.
	29 ³ / ₄ "	72"	30"	28 ³ / ₈ "	ATDT1LFM723028(L/M/V)() () () ()	2,820.	3,134.	3,291.	3,357.	3,862.
29 ³ / ₄ "	72"	36"	28 ³ / ₈ "	ATDT1LFM723628(L/M/V)() () () ()	2,850.	3,166.	3,324.	3,391.	3,901.	
Rectangular table desk with L-legs and partial front modesty 	28 ³ / ₈ "	48"	30"	27"	ATDT1LPM483027(L/M/V)() () () ()	2,552.	2,836.	2,978.	3,039.	3,493.
	28 ³ / ₈ "	60"	30"	27"	ATDT1LPM603027(L/M/V)() () () ()	2,558.	2,841.	2,984.	3,044.	3,501.
	28 ³ / ₈ "	72"	30"	27"	ATDT1LPM723027(L/M/V)() () () ()	2,568.	2,853.	2,995.	3,057.	3,515.
	28 ³ / ₈ "	72"	36"	27"	ATDT1LPM723627(L/M/V)() () () ()	2,597.	2,885.	3,030.	3,091.	3,555.
	29 ³ / ₄ "	48"	30"	28 ³ / ₈ "	ATDT1LPM483028(L/M/V)() () () ()	2,659.	2,955.	3,102.	3,166.	3,642.
	29 ³ / ₄ "	60"	30"	28 ³ / ₈ "	ATDT1LPM603028(L/M/V)() () () ()	2,664.	2,960.	3,108.	3,172.	3,648.
	29 ³ / ₄ "	72"	30"	28 ³ / ₈ "	ATDT1LPM723028(L/M/V)() () () ()	2,675.	2,970.	3,119.	3,184.	3,662.
29 ³ / ₄ "	72"	36"	28 ³ / ₈ "	ATDT1LPM723628(L/M/V)() () () ()	2,703.	3,004.	3,153.	3,218.	3,702.	
Rectangular table desk with L-legs and full front & side modesties 	28 ³ / ₈ "	48"	30"	27"	ATDT1LFS483027(L/M/V)() () () ()	3,296.	3,663.	3,846.	3,925.	4,512.
	28 ³ / ₈ "	60"	30"	27"	ATDT1LFS603027(L/M/V)() () () ()	3,340.	3,711.	3,896.	3,976.	4,573.
	28 ³ / ₈ "	72"	30"	27"	ATDT1LFS723027(L/M/V)() () () ()	3,379.	3,754.	3,943.	4,022.	4,626.
	28 ³ / ₈ "	72"	36"	27"	ATDT1LFS723627(L/M/V)() () () ()	3,407.	3,787.	3,976.	4,058.	4,665.
	29 ³ / ₄ "	48"	30"	28 ³ / ₈ "	ATDT1LFS483028(L/M/V)() () () ()	3,394.	3,770.	3,958.	4,039.	4,646.
	29 ³ / ₄ "	60"	30"	28 ³ / ₈ "	ATDT1LFS603028(L/M/V)() () () ()	3,437.	3,819.	4,010.	4,091.	4,707.
	29 ³ / ₄ "	72"	30"	28 ³ / ₈ "	ATDT1LFS723028(L/M/V)() () () ()	3,477.	3,864.	4,057.	4,137.	4,760.
29 ³ / ₄ "	72"	36"	28 ³ / ₈ "	ATDT1LFS723628(L/M/V)() () () ()	3,505.	3,895.	4,089.	4,172.	4,800.	

Worksurfaces

Order Code	Specification Information	Application Notes
Example: ATDT1LPS483027VG V316AA111 <hr/> A AutoStrada <hr/> TD Table desk <hr/> T1 Top tapered 1 side (user only) <hr/> L L-Leg <hr/> FM Full front modesty <hr/> 48 48" wide <hr/> 30 30" deep <hr/> 27 Leg height <hr/> V Surface type, veneer <hr/> G Grommet <hr/> V316 Finish top, Maple <hr/> AA Finish, leg <hr/> 111 Grommet finish	To order please specify pattern number including: 1. Full or partial modesty (and end panels when applicable) 2. Width 3. Depth 4. Leg height (to underside of surface) 27 = 27" h 28 = 28 ³ / ₈ " h 5. Surface type L = Laminate M = Mixed, Laminate surface/V1, V2 or V3 edge V = V1, V2 or V3 6. Grommet G=Grommet N=No Grommet 7. Finish, Surface Laminate, Mixed, V1, V2 or V3 finish	8. Finish, Edge Must be same as surface finish unless M surface type specified, then must be V1, V2 or V3 finish 9. Finish, Leg Anodized aluminum finish or painted finish option excluding silver. 10. Finish, Grommet See page 8 for finish options applicable. Laminate finish options for modesty panels on this page are as follows: 114 = Folkstone grey 117 = Soft grey 118 = Bright white 119 = Pumice Product on this page will accept wood grain laminate where laminate is currently an option. Worksurface stiffener included with rectangular tables 60" w and over.

AutoStrada tables include four L-legs with glides and full or partial height modesty (and optional end panels).

Tables can be specified to overall surface height of:
 28³/₈" : specify 27" leg.
 29³/₄" : specify 28" leg.

Partial height option for 27" leg is nominally 13" and 14" h nominally with 28³/₈" h legs; and may be mounted flush to underside of worksurface or with 1" gap below worksurface.

Table desks with L-legs

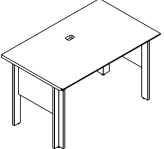
description	h	w	d	leg height	pattern no.	L	M	V1	V2	V3
Rectangular table desk with L-legs and partial front and side modesties 	28 ³ / ₈ "	48"	30"	27"	ATDT1LPS483027(L/M/V)() () () ()	\$3,129.	\$3,477.	\$3,650.	\$3,724.	\$4,282.
	28 ³ / ₈ "	60"	30"	27"	ATDT1LPS603027(L/M/V)() () () ()	3,172.	3,526.	3,702.	3,777.	4,344.
	28 ³ / ₈ "	72"	30"	27"	ATDT1LPS723027(L/M/V)() () () ()	3,213.	3,568.	3,747.	3,824.	4,396.
	28 ³ / ₈ "	72"	36"	27"	ATDT1LPS723627(L/M/V)() () () ()	3,241.	3,600.	3,780.	3,858.	4,437.
	29 ³ / ₄ "	48"	30"	28 ³ / ₈ "	ATDT1LPS483028(L/M/V)() () () ()	3,226.	3,584.	3,763.	3,841.	4,416.
	29 ³ / ₄ "	60"	30"	28 ³ / ₈ "	ATDT1LPS603028(L/M/V)() () () ()	3,271.	3,633.	3,815.	3,893.	4,476.
	29 ³ / ₄ "	72"	30"	28 ³ / ₈ "	ATDT1LPS723028(L/M/V)() () () ()	3,309.	3,676.	3,860.	3,938.	4,530.
	29 ³ / ₄ "	72"	36"	28 ³ / ₈ "	ATDT1LPS723628(L/M/V)() () () ()	3,337.	3,709.	3,894.	3,974.	4,571.

Order Code	Specification Information	Application Notes
Example: ATDT1LPS483027VG V316AA111	<i>To order please specify pattern number including:</i>	
A AutoStrada	1. Full or partial modesty (and end panels when applicable)	8. Finish, Edge <i>Must be same as surface finish unless M surface type specified, then must be V1, V2 or V3 finish</i>
TD Table desk	2. Width	9. Finish, Leg <i>Anodized aluminum finish or painted finish option excluding silver.</i>
T1 Top tapered 1 side (user only)	3. Depth	10. Finish, Grommet
L L-Leg	4. Leg height (to underside of surface) 27 = 27" h 28 = 28 ³ / ₈ " h	See page 8 for finish options applicable.
FM Full front modesty	5. Surface type <i>L = Laminate</i> <i>M = Mixed, Laminate surface/V1, V2 or V3 edge</i> <i>V = V1, V2 or V3</i>	Laminate finish options for modesty panels on this page are as follows: 114 = Folkstone grey 117 = Soft grey 118 = Bright white 119 = Pumice
48 48" wide	6. Grommet <i>G = Grommet</i> <i>N = No Grommet</i>	Partial height option for 27" leg is nominally 13" and 14" h nominally with 28 ³ / ₈ " h legs; and may be mounted flush to underside of worksurface or with 1" gap below worksurface.
30 30" deep	7. Finish, Surface <i>Laminate, Mixed, V1, V2 or V3 finish</i>	Product on this page will accept wood grain laminate where laminate is currently an option.
27 Leg height		Worksurface stiffener included with rectangular tables 60" w and over.
V Surface type, veneer		
G Grommet		
V316 Finish top, Maple		
AA Finish, leg		
111 Grommet finish		

description	w	d	t	pattern no.	L	M	V1	V2	V3
Transaction Top 1 1/4" Thick, Straight	24"	15"	1 1/4"	ATTA24S()	\$750.	\$760.	\$776.	\$799.	\$1,015.
	30"	15"	1 1/4"	ATTA30S()	765.	779.	795.	814.	1,031.
	36"	15"	1 1/4"	ATTA36S()	779.	789.	805.	827.	1,043.
	42"	15"	1 1/4"	ATTA42S()	789.	800.	815.	838.	1,054.
	48"	15"	1 1/4"	ATTA48S()	806.	817.	834.	854.	1,070.
	54"	15"	1 1/4"	ATTA54S()	823.	833.	850.	870.	1,088.
	60"	15"	1 1/4"	ATTA60S()	838.	850.	866.	888.	1,100.
	66"	15"	1 1/4"	ATTA66S()	855.	866.	884.	905.	1,115.
	72"	15"	1 1/4"	ATTA72S()	867.	879.	896.	952.	1,295.

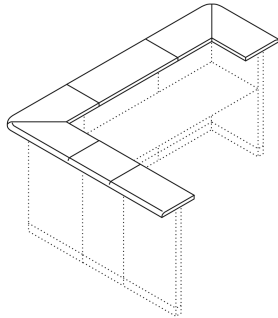

Straight



Transaction Top 1 1/4" Thick, mitered left Left Side	24"	15"	1 1/4"	ATTA24L()	991.	1,004.	1,023.	1,050.	1,297.
	30"	15"	1 1/4"	ATTA30L()	1,009.	1,020.	1,041.	1,067.	1,314.
	36"	15"	1 1/4"	ATTA36L()	1,020.	1,031.	1,051.	1,078.	1,324.
	42"	15"	1 1/4"	ATTA42L()	1,031.	1,042.	1,063.	1,090.	1,336.
	48"	15"	1 1/4"	ATTA48L()	1,047.	1,059.	1,080.	1,107.	1,353.
	54"	15"	1 1/4"	ATTA54L()	1,064.	1,074.	1,096.	1,123.	1,370.
	60"	15"	1 1/4"	ATTA60L()	1,080.	1,092.	1,114.	1,139.	1,383.
	66"	15"	1 1/4"	ATTA66L()	1,097.	1,108.	1,129.	1,158.	1,396.
	72"	15"	1 1/4"	ATTA72L()	1,110.	1,120.	1,143.	1,203.	1,577.



Transaction Top 1 1/4" Thick, mitered right Right Side	24"	15"	1 1/4"	ATTA24R()	991.	1,004.	1,023.	1,050.	1,297.
	30"	15"	1 1/4"	ATTA30R()	1,009.	1,020.	1,041.	1,067.	1,314.
	36"	15"	1 1/4"	ATTA36R()	1,020.	1,031.	1,051.	1,078.	1,324.
	42"	15"	1 1/4"	ATTA42R()	1,031.	1,042.	1,063.	1,090.	1,336.
	48"	15"	1 1/4"	ATTA48R()	1,047.	1,059.	1,080.	1,107.	1,353.
	54"	15"	1 1/4"	ATTA54R()	1,064.	1,074.	1,096.	1,123.	1,370.
	60"	15"	1 1/4"	ATTA60R()	1,080.	1,092.	1,114.	1,139.	1,383.
	66"	15"	1 1/4"	ATTA66R()	1,097.	1,108.	1,129.	1,158.	1,396.
	72"	15"	1 1/4"	ATTA72R()	1,110.	1,120.	1,143.	1,203.	1,577.



Order Code

Example:	ATTA24S1
A	AutoStrada
TT	Transaction top
A	1 1/4" thick
24	24" wide
S	Straight end treatment
1	V1 finish
V316	Maple

To order please specify pattern number including:

1. End treatment type
2. Finish type
3. Finish

1. End treatment options:

- S = Straight
- L = Left side mitre
- R = Right side mitre

2. Finish type:

- L = Laminate
- M = Wood/laminate mixed
- 1 = V1
- 2 = V2
- 3 = V3

Transaction tops are for mounting to 42" h panel or overall panel height achieved from 34" h base panel plus 8" h stacking module. Transaction tops ship with necessary bracketry included.

No grommets included.

Tops may be used to span more than one consecutive panel.

Transaction tops will not fit between panel Hi-Lo conditions without notching the underside of the top. This can be done in the field or through Custom Product Development.

Applicable finishes are listed on page 8.

Product on this page will accept woodgrain laminate where laminate is currently an option.

Transaction Top Brackets for Alternative Material

description	w	h	pattern no.	list
Attachment Bracketry			AAMTB	\$60.
Foam Tape			AAMTT	24.
Transaction Top Bracket Cover			AAMTC24()	44.
			AAMTC30()	47.
			AAMTC36()	50.
			AAMTC42()	54.
			AAMTC48()	57.
			AAMTC54()	60.
			AAMTC60()	63.
			AAMTC66()	68.
			AAMTC72()	70.
Transaction Top Bracket Cover Hilo			AAMTCH24()	60.
			AAMTCH30()	63.
			AAMTCH36()	68.
			AAMTCH42()	71.
			AAMTCH48()	74.
			AAMTCH54()	77.
			AAMTCH60()	80.
			AAMTCH66()	83.
			AAMTCH72()	85.

Order Code



Example: AAMTC	
A	Reff
A	Alternative
M	Material
T	Transaction Top
C	Cover
24	Width
L/R/M	Left/Right/Mitered
()	Finish

Application Information



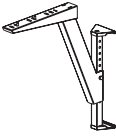
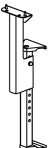

To order please specify pattern number including:

- End treatment options
L = Left side miter
R = Right side miter
M = Mitered both sides
- Finish:
Core paint finishes

Transaction top Brackets are available in core paint finishes.

description	type	width	depth	height	pattern no.	painting	list
Adjustable cantilever bracket (up to 24"D)		3"	20"	23-33"	AB1 AC24 ()	\$213.	
 <p>Maximum of 24" deep worksurfaces may be cantilevered from Spine.</p>							
Adjustable end support bracket			6"	23-33"	AB2 AE ()		172.
							
Compact fixed height end support bracket	for 28"h worksurface		6"	27"	AB2 FE27 ()		145.
	for 29 ⁵ / ₈ "h worksurface		6"	28"	AB2 FE28 ()		145.
							
Adjustable cantilever bridging bracket		3"	20"	23-33"	AB1-ABC24 ()		276.
<p>Maximum of 24" deep worksurfaces may be cantilevered from Spine.</p>							
spacers (20 per pack) use with spine worksurface support brackets					AA1 BS		14.

Order Code	Specification Information	Application Notes
Example: AB1 AC24118 AB1 Bracket AC Type 24 Depth 118 Finish	<p>Please specify painted finish from paint options listed on page 8.</p> <p>Specify worksurface cantilever and end support brackets to attach worksurfaces to spine walls.</p> <p>Specify two cantilever brackets to support any 24"D worksurface up to 84" wide, or one back edge of corner worksurface. Specify three cantilever brackets to support any 24"D worksurface greater than 84" wide. Specify two end support brackets to support one end of straight, conference, or arc-shape surface.</p>	<p>Adjustable height cantilever and bridging cantilever brackets support underside of worksurface in 1" increments from 23" to 33"H (24" to 34" top height).</p> <p>Spacers (AA1 BS) to be used with adjustable cantilever or end support brackets to accommodate wood case AutoStrada pedestals and lower storage with optional cabinet feet. Resulting overall worksurface height achieved 29⁵/₈"h.</p>
		<p>Adjustable bridging cantilever supports adjacent 48"W straight or corner worksurfaces.</p> <p>End support brackets adjust 23"-33"H (24" to 34" top height). Fixed height brackets support worksurface at 28"H and 29⁵/₈"H.</p> <p>Cannot exceed maximum of 24" deep worksurfaces cantilevered from Spine.</p>

description	type	w	d	h	pattern no.	paint	list
 End support brackets - E with wood screws	18"d straight worksurface		18"	1 1/4"	MB3-E18W-()	\$47.	
	24"d straight worksurface		24"	1 1/4"	MB3-E24W-()	50.	
	30"d straight worksurface		30"	1 1/4"	MB3-E30W-()	56.	
	36"d straight worksurface		36"	1 1/4"	MB3-E36W-()	64.	
 End support brackets - E with wood screws End support for 30"h linkable screen	18"d straight worksurface		18"	1 1/4"	MB3-EC18W-() *	47.	
	24"d straight worksurface		24"	1 1/4"	MB3-EC24W-() *	50.	
	30"d straight worksurface		30"	1 1/4"	MB3-EC30W-() *	56.	
 Cantilever brackets - C with wood screws	18"d worksurface	1/2"	15"	8 1/2"	MB2-C18W-(L/R)-()		62.
	24"d worksurface	1/2"	21"	11 1/2"	MB2-C24W-(L/R)-()		71.
	30"d worksurface	1/2"	24"	13 1/2"	MB2-C30W-(L/R)-()		84.
Cantilever tie-clips - AUX-C (10)					MB1-AUX-C		14.
 Worksurface/vertical panel spacer Y with wood screws		1/16"	15"	8 1/2"	MB2-YW-(L/R)-()		52.

Order Code	Specification Information	Application Notes
Example: MB3-E30W-613	Bracket type:	E-type end support brackets support 1 1/4" or 1 3/4" worksurface from connector tracks at both back and front.
MB3 Bracket	E End Support	C-type cantilever brackets support worksurfaces from connector track at the back. Specify left or right hand.
E Bracket type	C Cantilever	
30 Bracket depth	Y Worksurface/vertical panel spacer	
W with wood screws		AUX-C cantilever tie-clips tie together two adjacent cantilever brackets for added stability.
613 Finish, paint	<i>Please specify painted finish from paint options listed on page 8.</i>	Y-type spacer brackets secure the end of pedestal-supported worksurfaces to a connector track. Y brackets maintain the 3/8" wire drop and allow pedestal fronts to align with the end of the worksurface.
		* MB3-EC18W-(), MB3-EC24W-() and MB3-EC30W-() end support brackets should be specified when supporting worksurfaces from 30" high linkable screens.

description	d	pattern no.	P1	P2	P3
Cantilever bracket, panel hung	18"	ASBC18 (L/R) ()	\$99.	\$104.	\$108.
	24"	ASBC24 (L/R) ()	108.	116.	122.

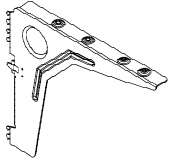

18" for 20" and 24" deep tops
 24" for 30" and 36" deep tops
 specify paint finish

Side hung support bracket, pair		RBCCP ()	42.	44.	45.
---------------------------------	--	------------------	-----	-----	-----

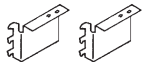

specify paint finish

top to top brackets (pair) for use when top to top condition is without tapered edges	6" x 1"	RBF	5.		
------------------------------------------------------------------------------------------	---------	------------	----	--	--



Top to top bracket for use with tapered edge worksurface conditions ('tapered to tapered' or 'tapered to straight')	4" x 7"	AT2TB (pair)	105.		
------------------------------------------------------------------------------------------------------------------------	---------	---------------------	------	--	--

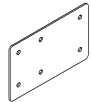

Order Code	Specification Information	Application Notes
Example: RBC18L111	<i>To order please specify pattern number including:</i>	<i>Flat edge to flat edge:</i>
R from Reff	1. Left or right hand where applicable	RBF top to top brackets are for end to end worksurface connection, no tapered edges.
B Bracket	2. Paint finish where applicable	A cantilever bracket should be used to join two adjacent straight worksurfaces along with pair of RBF top to top brackets. RBF brackets install between screw ports on cantilever bracket to underside of worksurface.
C Cantilever	<i>Specify painted finish from paint options listed on page 8.</i>	Tapered edges: AT2TB top to top brackets are for connection of worksurfaces at right angle, with one or both edges tapered. A cantilever bracket should be used to join two worksurfaces along with pair of AT2TB top to top brackets. Install one AT2TB bracket behind cantilever and one in front of cantilever.
18 18" deep		Midspan support required every 48" for all worksurfaces.
L Left hand		Side hung support brackets provide primary connection of a worksurface to a panel, not recommended for midspan support.
111 Finish, Jet black		

Worksurface support

Straight legs, wide legs and L-legs

AutoStrada

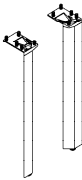
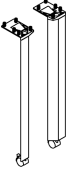
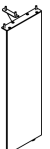
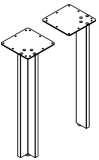
description	type	height	pattern number	list
 Straight leg (pair)	Fixed height	27"	AB1AS27 ()	\$378.
		28 ³ / ₈ "	AB1AS28 ()	398.
		30 ¹ / ₈ "	AB1AS30 ()	409.
 Straight leg with casters (pair)	Fixed height	27"	AB1ASC27 ()	378.
		28 ³ / ₈ "	AB1ASC28 ()	398.
		30 ¹ / ₈ "	AB1ASC30 ()	409.
 Wide leg	Fixed height	27"	AB1AW27 ()	349.
		28 ³ / ₈ "	AB1AW28 ()	370.
 L-legs (pair)	Fixed height	26 ¹ / ₂ "	APTLL26 ()	669.
		27"	APTLL27 ()	687.
		28 ³ / ₈ "	APTLL28 ()	699.

Order Code	Specification Information	Application Notes
Example: AB1AS28 AA AB1A AutoStrada leg S Straight 28 Height AA Finish	AutoStrada straight legs, wide legs and L-legs are available in anodized aluminum or painted finish option listed on page 8 excluding silver. To order specify pattern number including height 1. Specify finish	A pair of straight legs or a pair of L-legs or one wide leg can support one end of a worksurface when the other end is spine-supported, panel-supported or joined to a perpendicular worksurface with AT2TB brackets. If distance between support spans over 48", additional support is required. Two pairs of straight legs or L-legs may also be specified to create a freestanding table in combination with an AutoStrada worksurface not to exceed 72" x 36" with a corresponding worksurface stiffener. AutoStrada straight legs are available in three heights with or without casters:

27" from floor to underside of worksurface (28³/₈" desk height)
 28³/₈" from floor to underside of worksurface (29³/₄" desk height)
 30¹/₈" from floor to underside of worksurface (31¹/₂" desk height)
 AutoStrada wide legs are only available on glides, 27" or 28³/₈" to underside of worksurface.
 AutoStrada L-legs are available in three heights, glide only (no caster option) 26¹/₂"h, 27"h and 28³/₈"h.

Worksurface support

Fixed Height and Height Adjustable C-Leg and T-Leg Bases

AutoStrada

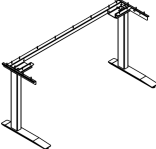
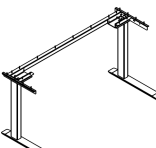
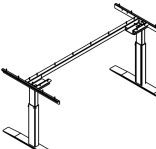
description	type	w*	w	d	pattern no.	Fixed	Pin-Set	Handcrank	Electric	Advanced
						(F)	(P)	(H)	(E)	Electric (A)
	For use with 36"W, 24"D AutoStrada C-Leg Top	36"	34"	23"	ABAC3423 () () ()	\$955.	\$1,273.	\$1,909.	\$3,316.	\$3,491.
	For use with 42"W, 24"D AutoStrada C-Leg Top	42"	40"	23"	ABAC4023 () () ()	955.	1,273.	1,909.	3,316.	3,491.
	For use with 48"W, 24"D AutoStrada C-Leg Top	48"	46"	23"	ABAC4623 () () ()	955.	1,273.	1,909.	3,316.	3,491.
	For use with 54"W, 24"D AutoStrada C-Leg Top	54"	52"	23"	ABAC5223 () () ()	955.	1,273.	1,909.	3,316.	3,491.
	For use with 60"W, 24"D AutoStrada C-Leg Top	60"	58"	23"	ABAC5823 () () ()	955.	1,273.	1,909.	3,316.	3,491.
	For use with 66"W, 24"D AutoStrada C-Leg Top	66"	64"	23"	ABAC6423 () () ()	977.	1,295.	1,932.	3,338.	3,514.
	For use with 72"W, 24"D AutoStrada C-Leg Top	72"	70"	23"	ABAC7023 () () ()	977.	1,295.	1,932.	3,338.	3,514.
<i>Fixed Shown</i>										
	For use with 36"W, 30"D AutoStrada C-Leg Top	36"	34"	29"	ABAC3429 () () ()	1,000.	1,318.	1,955.	3,360.	3,536.
	For use with 42"W, 30"D AutoStrada C-Leg Top	42"	40"	29"	ABAC4029 () () ()	1,000.	1,318.	1,955.	3,360.	3,536.
	For use with 48"W, 30"D AutoStrada C-Leg Top	48"	46"	29"	ABAC4629 () () ()	1,000.	1,318.	1,955.	3,360.	3,536.
	For use with 54"W, 30"D AutoStrada C-Leg Top	54"	52"	29"	ABAC5229 () () ()	1,000.	1,318.	1,955.	3,360.	3,536.
	For use with 60"W, 30"D AutoStrada C-Leg Top	60"	58"	29"	ABAC5829 () () ()	1,000.	1,318.	1,955.	3,360.	3,536.
	For use with 66"W, 30"D AutoStrada C-Leg Top	66"	64"	29"	ABAC6429 () () ()	1,023.	1,341.	1,977.	3,381.	3,559.
	For use with 72"W, 30"D AutoStrada C-Leg Top	72"	70"	29"	ABAC7029 () () ()	1,023.	1,341.	1,977.	3,381.	3,559.
<i>Fixed Shown</i>										
	For use with 48"W, 36"D AutoStrada T-Leg Top	48"	46"	29"	ABAT4629 () () ()	1,000.	1,318.	1,955.	3,360.	3,536.
	For use with 54"W, 36"D AutoStrada T-Leg Top	54"	52"	29"	ABAT5229 () () ()	1,000.	1,318.	1,955.	3,360.	3,536.
	For use with 60"W, 36"D AutoStrada T-Leg Top	60"	58"	29"	ABAT5829 () () ()	1,000.	1,318.	1,955.	3,360.	3,536.
	For use with 66"W, 36"D AutoStrada T-Leg Top	66"	64"	29"	ABAT6429 () () ()	1,023.	1,341.	1,977.	3,381.	3,559.
	For use with 72"W, 36"D AutoStrada T-Leg Top	72"	70"	29"	ABAT7029 () () ()	1,023.	1,341.	1,977.	3,381.	3,559.

Pin-Set Shown

Support Components



Order Code	Specification Information	Application Notes
Example: ABAC5829HS, 9005, 613	To order please specify pattern number including:	Bases are designed for use with corresponding worksurfaces to create freestanding tables. Worksurfaces must be specified separately.
ABA Universal Base	1. <i>Base Type:</i>	Base comes with worksurface mounting hardware and leveling glides with 1/4" of height adjustability.
C C-Leg	(F) = Fixed (27" High)	23"D C-Leg bases support rectangular tops up to 24"D. 29"D C-Leg bases support rectangular tops up to 30"D. 29"D T-Leg bases support rectangular tops 36"D centered over feet.
58 Width	(P) = Pin-Set (22" - 35" High)	36"W C-Leg bases (except for Pin-set) support tops up to 60"w centered over feet (max 12" overhang on each side). 36"W Pin-Set C-Leg bases cannot support tops wider than the base. 42"W C-Leg bases support tops up to 66"W centered over feet (max 12" overhang on each side). 48", 54", 60" and 66"W C-Leg and T-Leg bases support tops up to 30" wider than the base centered over feet (max 15" overhang on each side). 72"W C-Leg and T-Leg bases support tops up to 96"W centered over feet (max 12" overhang on each side).
29 Depth	(H) = Handcrank (22" - 35" High)	Bases available in Black paint finish (9005), Silver finish (613), or Bright White finish (118). Painted lower leg shroud and feet can be specified in Knoll Core paint finishes (for Black base only).
H Handcrank	(E) = Electric (27" - 46 1/2" High)	Fixed and Pin-Set bases support up to 440lbs. Handcrank bases support up to 260lbs. Electric bases support up to 300lbs.
S Shroud	(A) = Advanced Electric (21" - 47 1/2" High)	Pin-Set base adjusts on 1" increments.
9005 Black Base Finish	Base height ranges shown do not include worksurface thickness.	Crank handle is located on the right side of the base. Five turns of the handle adjust worksurface height 1".
613 Shroud/Feet Paint Finish	2. <i>Shroud Options:</i>	
	(N) = Leg without a metal shroud	
	(S) = Painted metal shroud to surround lower leg with matching foot. Add \$100 to the list price.	
	3. <i>Base Finish:</i>	
	(9005) Black paint	
	(613) Silver paint	
	(118) Bright White paint	
	4. <i>Shroud/Feet Paint Finish, when applicable</i>	

w* = nominal width

Worksurface support

Fixed Height and Height Adjustable C-Leg and T-Leg Bases

AutoStrada

description	type	w	d	h	pattern no.	list
Electric Table Memory Switch with Digital Display 	For use with Electric C-Leg and T-Leg bases	5"	.75"	1"	SISDDPS	\$375.
Locking Casters, Set of 4 	For use with C-Leg and T-Leg bases	2"	2"	1.5"	SISLC4	50.
Insert Kit, Antenna Privacy Screen	To attach Antenna Workspaces Privacy Screens to C-Leg and T-Leg worksurfaces				SISAWDSIK	25.

Order Code

Example: SISDDPS
SIS Universal Base
DDPS Electric Table Memory Switch with Digital Display



Application Notes

Locking casters replace standard glides to facilitate reconfiguration. Locking casters raise top height 1 1/2".

Insert kit is required when attaching Antenna Workspaces privacy screens to C-leg and T-leg worksurfaces.

Electric table memory switch with digital display offers three programmable memory settings with digital read out display. Mounting options include a 90° bracket and a 45° bracket. (Both are supplied) This memory switch will replace the standard up/down control.

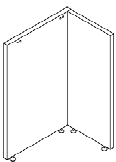
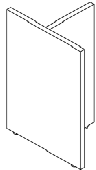
Worksurface support T and L bases

description	type	h	w	d	pattern no.	L	V1	V2	V3
	right hand	28 ³ / ₈ "	24"		ALBR24 ()	\$489.	\$510.	\$586.	\$760.
		28 ³ / ₈ "	30"		ALBR30 ()	565.	591.	683.	889.
		28 ³ / ₈ "	36"		ALBR36 ()	642.	678.	777.	1,010.
	left hand	28 ³ / ₈ "	24"		ALBL24 ()	489.	510.	586.	760.
		28 ³ / ₈ "	30"		ALBL30 ()	565.	591.	683.	889.
		28 ³ / ₈ "	36"		ALBL36 ()	642.	678.	777.	1,010.
<i>left hand shown</i>									
	T Base for tapered 1 edge tops	28 ³ / ₈ "	18"	12"	ATBT120 ()	448.	474.	550.	718.
		28 ³ / ₈ "	22"	12"	ATBT124 ()	479.	510.	586.	760.
		28 ³ / ₈ "	28"	12"	ATBT130 ()	565.	591.	683.	889.
		28 ³ / ₈ "	34"	12"	ATBT136 ()	642.	678.	777.	1,010.
	T Base for tapered 2 edge tops	28 ³ / ₈ "	20"	12"	ATBT224 ()	479.	510.	586.	760.
		28 ³ / ₈ "	26"	12"	ATBT230 ()	565.	591.	683.	889.
		28 ³ / ₈ "	32"	12"	ATBT236 ()	642.	678.	777.	1,010.
		28 ³ / ₈ "	38"	12"	ATBT242 ()	792.	834.	961.	1,249.

Order Code

Example:	ATB24V316
A	Autostrada
TB	T-base
24	24" w x 12" d
V316	Finish, Maple

Specification Information

To order please specify pattern number including:

1. Hand (applicable for L bases only)
L = left hand
R = right hand
2. Width
3. Finish
Laminate, V1, V2 or V3 finish

See page 8 for finish options applicable.

Product on this page will accept wood grain laminate where laminate is currently an option.

Application Notes

T and L bases are 28³/₈" h to underside of worksurface. If used with wood case pedestals or lower storage as support, must specify cabinet feet (see page 259) for pedestals/lower storage to achieve required height.

Worksurface support

Modesty panels

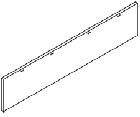
description	h	w	pattern no.	L	V1	V2	V3
 Half height suspended modesty	12"	33 1/2"	AHHSM36 ()	\$352.	\$424.	\$461.	\$598.
	12"	39 1/2"	AHHSM42 ()	362.	433.	473.	617.
	12"	45 1/2"	AHHSM48 ()	371.	442.	484.	630.
	12"	51 1/2"	AHHSM54 ()	384.	449.	498.	646.
	12"	57 1/2"	AHHSM60 ()	392.	460.	511.	664.
	12"	63 1/2"	AHHSM66 ()	402.	467.	523.	680.
	12"	69 1/2"	AHHSM72 ()	414.	476.	536.	695.
	12"	75 1/2"	AHHSM78 ()	424.	484.	547.	712.
	12"	81 1/2"	AHHSM84 ()	435.	493.	561.	730.
	12"	87 1/2"	AHHSM90 ()	444.	502.	575.	746.
	12"	93 1/2"	AHHSM96 ()	454.	512.	587.	761.

Order Code

Example:	AHHSM30V316
A	AutoStrada
HH	Half height
S	Suspended
M	Modesty
30	for 30" w work surface
V316	Finish, Maple

Specification Information

To order please specify pattern number including:

1. Finish
Laminate, V1, V2 or V3 finish

See page 8 for finish options applicable.

Product on this page will accept wood grain laminate where laminate is currently an option.

Application Notes

To be used for free-standing private office applications.

Half height suspended modesty intended for optional use with work surfaces when creating configurations including a peninsula top supported at one end by a pair of legs (legs on page 248) or "freestanding" table desk by set of legs and would install just behind the legs by angle bracket that ships with modesty. Attachment hardware included.

If installing below worksurface with grommets, be sure to specify recessed grommet location.

Worksurface support

Modesty

Hinged

28³/₈" planning

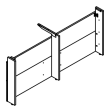
description	application	th	w	h	pattern no.	L	V1	V2	V3
Hinged Modesty for End panel and Storage Unit 	72" wide assembly - 16" storage	1"	72"	25"	ADHMH7210()	\$846.	\$1,054.	\$1,108.	\$1,330.
	72" wide assembly - 19" storage	1"	72"	25"	ADHMH7220()	838.	1,049.	1,099.	1,319.
	72" wide assembly - 30" storage	1"	72"	25"	ADHMH7230()	674.	876.	922.	1,108.
	72" wide assembly - 36" storage	1"	72"	25"	ADHMH7240()	664.	864.	905.	1,086.
	78" wide assembly - 16" storage	1"	78"	25"	ADHMH7810()	861.	1,065.	1,124.	1,349.
	78" wide assembly - 19" storage	1"	78"	25"	ADHMH7820()	850.	1,060.	1,116.	1,338.
	78" wide assembly - 30" storage	1"	78"	25"	ADHMH7830()	686.	893.	939.	1,126.
	78" wide assembly - 36" storage	1"	78"	25"	ADHMH7840()	674.	876.	922.	1,108.
	84" wide assembly - 16" storage	1"	84"	25"	ADHMH8410()	877.	1,084.	1,146.	1,377.
	84" wide assembly - 19" storage	1"	84"	25"	ADHMH8420()	866.	1,069.	1,138.	1,367.
	84" wide assembly - 30" storage	1"	84"	25"	ADHMH8430()	840.	1,049.	1,100.	1,321.
	84" wide assembly - 36" storage	1"	84"	25"	ADHMH8440()	686.	893.	939.	1,126.
	90" wide assembly - 16" storage	1"	90"	25"	ADHMH9010()	887.	1,094.	1,164.	1,396.
	90" wide assembly - 19" storage	1"	90"	25"	ADHMH9020()	881.	1,089.	1,156.	1,386.
	90" wide assembly - 30" storage	1"	90"	25"	ADHMH9030()	852.	1,061.	1,117.	1,340.
	90" wide assembly - 36" storage	1"	90"	25"	ADHMH9040()	840.	1,049.	1,100.	1,321.
	96" wide assembly - 16" storage	1"	96"	25"	ADHMH9610()	899.	1,106.	1,179.	1,416.
96" wide assembly - 19" storage	1"	96"	25"	ADHMH9620()	892.	1,099.	1,171.	1,406.	
96" wide assembly - 30" storage	1"	96"	25"	ADHMH9630()	867.	1,071.	1,141.	1,370.	
96" wide assembly - 36" storage	1"	96"	25"	ADHMH9640()	852.	1,061.	1,117.	1,340.	

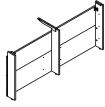
Hinged Modesty for Between Two Storage Elements 	72" wide assembly - 16"/16" storage	1"	72"	25"	ADHMH7211()	674.	876.	920.	1,107.
	72" wide assembly - 16"/19" storage	1"	72"	25"	ADHMH7222()	664.	864.	905.	1,086.
	72" wide assembly - 19"/19" storage	1"	72"	25"	ADHMH7212()	668.	869.	912.	1,095.
	78" wide assembly - 16"/16" storage	1"	78"	25"	ADHMH7811()	686.	893.	939.	1,126.
	78" wide assembly - 16"/19" storage	1"	78"	25"	ADHMH7812()	679.	887.	932.	1,117.
	78" wide assembly - 16"/30" storage	1"	78"	25"	ADHMH7813()	657.	860.	893.	1,071.
	78" wide assembly - 19"/19" storage	1"	78"	25"	ADHMH7822()	674.	876.	920.	1,107.
	78" wide assembly - 19"/30" storage	1"	78"	25"	ADHMH7823()	652.	854.	880.	1,055.
	84" wide assembly - 16"/16" storage	1"	84"	25"	ADHMH8411()	840.	1,049.	1,100.	1,321.
	84" wide assembly - 16"/19" storage	1"	84"	25"	ADHMH8412()	833.	1,044.	1,092.	1,310.
	84" wide assembly - 16"/30" storage	1"	84"	25"	ADHMH8414()	657.	860.	893.	1,071.
	84" wide assembly - 16"/36" storage	1"	84"	25"	ADHMH8413()	670.	870.	914.	1,098.
	84" wide assembly - 19"/19" storage	1"	84"	25"	ADHMH8422()	686.	893.	939.	1,126.
	84" wide assembly - 19"/30" storage	1"	84"	25"	ADHMH8423()	664.	864.	907.	1,089.
	84" wide assembly - 19"/36" storage	1"	84"	25"	ADHMH8424()	652.	854.	880.	1,055.
	90" wide assembly - 16"/16" storage	1"	90"	25"	ADHMH9011()	852.	1,061.	1,117.	1,340.
	90" wide assembly - 16"/19" storage	1"	90"	25"	ADHMH9012()	846.	1,055.	1,109.	1,331.
90" wide assembly - 16"/30" storage	1"	90"	25"	ADHMH9014()	670.	870.	914.	1,098.	
90" wide assembly - 16"/36" storage	1"	90"	25"	ADHMH9013()	680.	888.	933.	1,119.	

Order Code	Specification Information	Application Notes
Example: ADHMH7222	<i>To order please specify pattern number including:</i>	Modesty may prohibit the adjacent drawer from opening.
A AutoStrada	1. <i>Finish Type</i> L, V1, V2, V3	Recommended that when using a modesty the adjacent ped is an open configuration.
DH Desk height	2. <i>Finish</i> V316	Hardware shipped with modesty to attach to worksurface.
M Modesty		J-Extrusion Wire Trough sold separately.
H Hinged		
72 Width		
22 19"/19" storage		
V2 Finish type		
V316 Light Maple		

- Modesty End panel and storage unit.
- 10= 16" storage
- 20= 19" storage
- 30= 30" storage
- 40= 36" storage
- Modesty between two storage units.
- 11= 16"/16" storage
- 12= 16"/19" storage
- 13= 16"/36" storage
- 14= 16"/30" storage
- 22= 19"/19" storage
- 23= 19"/30" storage
- 24= 19"/36" storage
- 33= 30"/30" storage
- 34= 36"/36" storage

Support Components

Worksurface support

Modesty

Hinged

28³/₈" planning

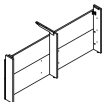
description	application	th	w	h	pattern no.	L	V1	V2	V3
Hinged Modesty for Between Two Storage Elements 	90" wide assembly - 19"/19" storage	1"	90"	25"	ADHMH9022()	\$840.	\$1,049.	\$1,100.	\$1,321.
	90" wide assembly - 19"/30" storage	1"	90"	25"	ADHMH9023()	675.	877.	922.	1,108.
	90" wide assembly - 19"/36" storage	1"	90"	25"	ADHMH9024()	664.	864.	907.	1,089.
	90" wide assembly - 30"/30" storage	1"	90"	25"	ADHMH9033()	653.	855.	882.	1,059.
	96" wide assembly - 16"/16" storage	1"	96"	25"	ADHMH9611()	867.	1,070.	1,139.	1,369.
	96" wide assembly - 16"/19" storage	1"	96"	25"	ADHMH9612()	862.	1,066.	1,125.	1,350.
	96" wide assembly - 16"/30" storage	1"	96"	25"	ADHMH9614()	680.	888.	933.	1,119.
	96" wide assembly - 16"/36" storage	1"	96"	25"	ADHMH9613()	835.	1,045.	1,093.	1,311.
	96" wide assembly - 19"/19" storage	1"	96"	25"	ADHMH9622()	852.	1,061.	1,117.	1,340.
	96" wide assembly - 19"/30" storage	1"	96"	25"	ADHMH9623()	686.	894.	940.	1,127.
	96" wide assembly - 19"/36" storage	1"	96"	25"	ADHMH9624()	675.	877.	922.	1,108.
	96" wide assembly - 30"/30" storage	1"	96"	25"	ADHMH9633()	666.	866.	908.	1,090.
	96" wide assembly - 36"/36" storage	1"	96"	25"	ADHMH9634()	653.	655.	882.	1,059.

Order Code

Example:	ADHMH7222
A	AutoStrada
DH	Desk height
M	Modesty
H	Hinged
72	Width
22	19"/19" storage
V2	Finish type
V316	Light Maple

Specification Information

To order please specify pattern number including:

1. *Finish Type*
L, V1, V2, V3
2. *Finish*
V316

Application Notes

Modesty may prohibit the adjacent drawer from opening.

Recommended that when using a modesty the adjacent ped is an open configuration.

Hardware shipped with modesty to attach to worksurface.

J-Extrusion Wire Trough sold separately.

Modesty End panel and storage unit.

- 10= 16" storage
- 20= 19" storage
- 30= 30" storage
- 40= 36" storage

Modesty between two storage units.

- 11= 16"/16" storage
- 12= 16"/19" storage
- 13= 16"/36" storage
- 14= 16"/30" storage
- 22= 19"/19" storage
- 23= 19"/30" storage
- 24= 19"/36" storage
- 33= 30"/30" storage
- 34= 36"/36" storage

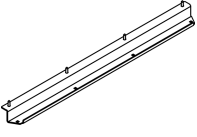
description	type	width	depth	height	pattern number	list
 Stiffener for worksurface, full depths	36"	20"	1 1/2"	1"	AWM1 S36	\$57.
	42"	26"	1 1/2"	1"	AWM1 S42	60.
	48"	32"	1 1/2"	1"	AWM1 S48	62.
	60"	44"	1 1/2"	1"	AWM1 S60	64.
	66"	50"	1 1/2"	1"	AWM1 S66	68.
	72"	56"	1 1/2"	1"	AWM1 S72	70.
	78"	62"	1 1/2"	1"	AWM1 S78	73.
	84"	68"	1 1/2"	1"	AWM1 S84	75.

Order CodeExample: **AWM1 S36****AWM1** Stiffener**S** Straight**36** Application**Specification Information**

Stiffeners are black painted finish.

Application Notes

AutoStrada worksurfaces require stiffeners when the span between structural supports exceeds 48". Stiffener also serves as horizontal cable manager.

Stiffener corresponds in width to straight or corner worksurface back edge. Specify 12" less wide stiffener to mount adjacent to floor standing pedestal.

For 90" application span, use AWM1-S84 stiffener.

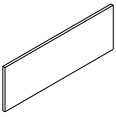
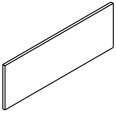
description	h	w	y	pattern no.	list
Tackboard for 49" h Median 	21"	26 1/2"	0.7	ATBM26 ()	\$157.
	21"	32 1/2"	1.0	ATBM32 ()	191.
	21"	42"	1.3	ATBM42 ()	252.
	21"	48"	1.5	ATBM48 ()	288.
	21"	54"	1.6	ATBM54 ()	323.
	21"	60"	1.8	ATBM60 ()	360.
	21"	66"	2.0	ATBM66 ()	396.
	21"	72"	2.2	ATBM72 ()	433.
	21"	78"	2.3	ATBM78 ()	468.
	21"	84"	2.5	ATBM84 ()	503.
	21"	90"	2.6	ATBM90 ()	539.
21"	96"	2.8	ATBM96 ()	576.	
Tackboard for 49" h Bridge 	21"	42"	1.3	ATBB42 ()	252.
	21"	48"	1.5	ATBB48 ()	288.
	21"	54"	1.6	ATBB54 ()	323.
	21"	60"	1.8	ATBB60 ()	360.
	21"	66"	2.0	ATBB66 ()	396.
	21"	72"	2.2	ATBB72 ()	433.
	21"	78"	2.3	ATBB78 ()	468.
14" h Tackboard for use with 42" h medians or bridges	14"	26 1/2"	0.7	ATB1426 ()	152.
	14"	32 1/2"	1.0	ATB1432 ()	185.
	14"	42"	1.3	ATB1442 ()	244.
	14"	48"	1.5	ATB1448 ()	279.
	14"	54"	1.6	ATB1454 ()	314.
	14"	60"	1.8	ATB1460 ()	350.
	14"	66"	2.0	ATB1466 ()	386.
	14"	72"	2.2	ATB1472 ()	420.
	14"	78"	2.3	ATB1478 ()	454.
	14"	84"	2.5	ATB1484 ()	490.
	14"	90"	2.6	ATB1490 ()	524.
	14"	96"	2.8	ATB1496 ()	560.

Order Code	Specification Information	Application Notes
Example: ATBM26W359-	<i>To order please specify pattern number including:</i>	Velcro included to attach tackboard to median or bridge as required.
A AutoStrada	1. For median or bridge <i>M = for medians</i>	Fabric orientation is applied "railroaded".
TB Tackboard	<i>B = for bridges</i>	
M for median	2. Width	Fabric choices listed on page 9.
26 for 26.5" d gable	<i>26 = for 26.5 d median gable</i>	
W359- Fabric selection	<i>32 = for 32.5 d median gable</i> <i>All others specify to match width of corresponding median or bridge</i>	
	3. Fabric selection	

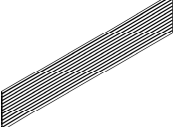
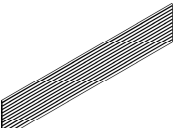

description	h	w	pattern no.	AA or paint
Slatwall for Median 	19"	26 1/2"	ASWM26 ()	\$249.
	19"	32 1/2"	ASWM32 ()	311.
	19"	42"	ASWM42 ()	371.
	19"	48"	ASWM48 ()	417.
	19"	54"	ASWM54 ()	464.
	19"	60"	ASWM60 ()	509.
	19"	66"	ASWM66 ()	554.
	19"	72"	ASWM72 ()	599.
	19"	78"	ASWM78 ()	643.
	19"	84"	ASWM84 ()	675.
	19"	90"	ASWM90 ()	707.
19"	96"	ASWM96 ()	739.	
Slatwall for Bridge 	19"	42"	ASWB42 ()	371.
	19"	48"	ASWB48 ()	417.
	19"	54"	ASWB54 ()	464.
	19"	60"	ASWB60 ()	509.
	19"	66"	ASWB66 ()	554.
	19"	72"	ASWB72 ()	599.
	19"	78"	ASWB78 ()	643.

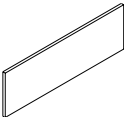
Order Code	Specification Information	Application Notes
Example: ASWM26AA A AutoStrada SW Slatwall M for median 26 for 26.5" d gable AA Finish, anodized aluminum	To order please specify pattern number including: 1. For median or bridge <i>M = for medians</i> <i>B = for bridges</i> 2. Width <i>26 = for 26.5 d median gable</i> <i>32 = for 32.5 d median gable</i> <i>All others specify to match width of corresponding median or bridge</i> 3. Finish <i>AA - anodized aluminum or painted finish option from page 8 excluding silver</i>	Slatwall attaches to median or bridge assembly with brackets (supplied with slatwall) which are then screwed onto modesty of median or bridge assembly. Modesties are not predrilled for attachment, field drill required during installation.

description	height	width	y	pattern no.	list
Wall hung tackboard 	24"	30"	0.9	AWHTB30 ()	\$214.
	24"	36"	1.1	AWHTB36 ()	256.
	24"	42"	1.3	AWHTB42 ()	300.
	24"	48"	1.4	AWHTB48 ()	343.
	24"	54"	1.6	AWHTB54 ()	385.
	24"	60"	1.7	AWHTB60 ()	428.
	24"	66"	1.9	AWHTB66 ()	470.
	24"	72"	2.1	AWHTB72 ()	514.
	24"	78"	2.3	AWHTB78 ()	556.
	24"	84"	2.5	AWHTB84 ()	599.
	24"	90"	2.6	AWHTB90 ()	643.
	24"	96"	2.8	AWHTB96 ()	684.

Order Code	Specification Information	Application Notes
Example: AWHTB30W359- A AutoStrada WH Wall hung TB Tackboard 30 30" wide W359- Fabric selection	To order please specify pattern number including: 1. Width 2. Fabric selection	Fabric orientation is applied railroaded. Velcro supplied for attaching to wall. Fabric choices listed on page 9.

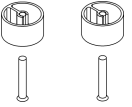
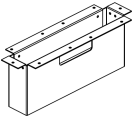
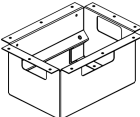
Vertical channel is routed in the center of the tackboard to accept T5 light cord.
Note: Y = Fabric requirements.

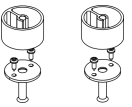
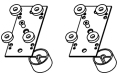
description	height	width	dia.	pattern no.	list
Worksurface stand-off (pair) 	1"		1 3/4"	AWSO ()	\$33.
AutoStrada Stand-Off 	5"	12"	5"	AST()	111.
AutoStrada Power Center Stand-Off 	5"	12"	5"	APCST()	142.
Cabinet feet (pair) 	1 7/8"		1 3/4"	ACF ()	168.
Worksurface stand-off (pair), for "ganging" 	1"		1 3/4"	AWSOG ()	33.
Cabinet feet (pair) for "ganging" 	1 7/8"		1 3/4"	ACFG ()	168.

Accessories

Order Code	Specification Information	Application Notes
Example: AWSOAA	To order please specify pattern number including:	Worksurface stand-offs are for use primarily in the private office between work surfaces and wood case pedestals or lower storage. Worksurface stand-offs may also be installed in place of anti-tip wood spacer between worksurfaces and wood case pedestals or lower storage in storage anchored planning. Anti-tip wood spacer and stand-offs are both 1"h.
A AutoStrada	1. Finish AA - anodized aluminum or painted finish option from page 8 excluding silver	When "ganging" units together to create "build-to-spec" credenzas, one pair of worksurface stand-offs and one pair of cabinet feet are required to span side-by-side units. For instance, if creating a credenza with 3 lower storage units, specify 4 pairs of stand-offs and 4 pairs of cabinet feet.
WSO Work surface stand-off		Cabinet feet should not be used in spine-based or storage anchored planning models. Use only with wood case pedestals and laterals to achieve overall worksurface height of 29 5/8" (or 28 3/8" to underside of worksurface). Spine based and Storage Anchored planning model components are engineered at 27" from floor to underside of worksurface.
AA Finish, anodized aluminum		To install cabinet feet, first remove leveller from pedestal or lower storage, then reinstall with feet.
		Note: Free-standing cabinets on page 176 include cabinet feet.
		If you are planning to create an open knee space credenza with one storage unit on either end of the credenza, you would require 2 pairs of work surface stand-offs and 2 pairs of cabinet feet for each lower storage unit.

description	height	width	dia.	pattern no.	list
Cabinet metal cap leveler (12/pk)				ACMCL	\$19.



Order Code	Specification Information	Application Notes
Example: AWSOAA	To order please specify pattern number including: 1. Finish <i>AA - anodized aluminum or painted finish option from page 8 excluding silver</i>	Worksurface stand-offs are for use primarily in the private office between work surfaces and wood case pedestals or lower storage. Worksurface stand-offs may also be installed in place of anti-tip wood spacer between worksurfaces and wood case pedestals or lower storage in storage anchored planning. Anti-tip wood spacer and stand-offs are both 1”h. Cabinet feet are for use with lower storage units in private office planning to achieve overall worksurface height of 29 ³ / ₈ ”. Note: Free-standing cabinets on page 176 include cabinet feet. If you are planning to create an open knee space credenza with one storage unit on either end of the credenza, you would require 2 pairs of work surface stand-offs and 2 pairs of cabinet feet for each lower storage unit.
A AutoStrada		
WSO Work surface stand-off		
AA Finish, anodized aluminum		
		When “ganging” units together to create “build-to-spec” credenzas, one pair of worksurface stand-offs and one pair of cabinet feet are required to span side-by-side units. For instance, if creating a credenza with 3 lower storage units, specify 4 pairs of stand-offs and 4 pairs of cabinet feet. Cabinet feet should not be used in spine-based or storage anchored planning models. Use only with wood case pedestals and laterals to achieve overall worksurface height of 29 ³ / ₈ ” (or 28 ³ / ₈ ” to underside of worksurface). Spine based and Storage Anchored planning model components are engineered at 27” from floor to underside of worksurface. To install cabinet feet, first remove leveller from pedestal or lower storage, then reinstall with feet.

This Order Guide provides basic planning, specifications and pricing information for Crinion Open Tables.

Refer to KnollExtra price list for compatible accessories such as flat screen monitor supports, task lights, paper management accessories, keyboard and storage drawers.

Refer to Calibre, Reff or Currents price lists for shared and individual storage options. Additional information can be found at www.knoll.com.

Crinion Open Table is the straightforward alternative for open, collaborative work environments. The table accommodates a group of four to eight or more at a continuous work surface.

Crinion Open Table typically consists of deep worksurfaces end-to-end and back-to-back, cantilever supported by parallel beams between end legs. The beams form a technology corridor for flat screen monitor supports, outlets and power/data distribution. Also available is a single-sided configuration, with a single main beam and a smaller back beam, and a single beam configuration for tables with shallower (24" deep) worksurface.

The center of dual tables or back of single-sided tables features a top channel which supports privacy screens above the table and modular power distribution below the worksurface.

Crinion Open Table is appropriate for libraries and education environments, laboratories, finance and trading desks, teaming areas and design offices.

Crinion Open Table is unique in offering individual height-adjustability and extraordinarily deep worksurfaces. Overall dual table depth is 48", 60" or 72".

The table structure is strong enough to span 16 feet between end legs or intermediate supports to build tables of any length.

The continuous worksurfaces and clear kneespace enable varying numbers of workers to sit on each side. Storage is typically separated from the table in parallel, shared file-and-storage islands, perpendicular files and filetops as returns or mobile pedestals.

Crinion is distinguished by a minimalist, modern design, and details like square or tapered edge worksurfaces, plastic laminate, Techwood or natural veneers, and aluminum fittings.

Crinion Open Table simplifies the planning and specifications of an open office, and it can make a dramatic visual and functional statement of collaboration.

The quality and classic design of Crinion work well in virtually any interior.

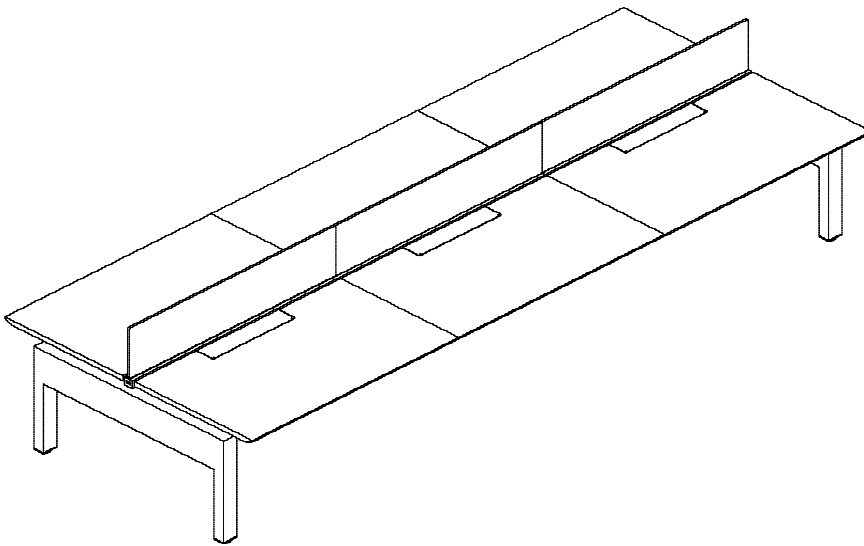

Crinion Open Tables are comprised of worksurfaces, table base assemblies, power components and screens.

Worksurfaces

Individual worksurfaces are available in four standard widths (48", 60", 72", 96") and three depths (nominal 24", 30", 36"), which may be combined to form single-sided or dual-sided groups of two to ten or more positions.

Worksurface edge options

Worksurfaces are 1 1/4" thick, with three front edge options: Tapered edge, laminate, veneer or mixed.

Square edge, veneer

Postformed edge, laminate only

Power and accessory options

Worksurfaces may be specified with hinged power access door and continuous 1/2" cord drop, or edge grommet and continuous cord drop, or just cord drop.

Hinged power access door is 24"W and 5"D, centered on worksurface width. Door hinges toward user for continuity between access opening and cord drop.

Any worksurface (except end counters) accepts clamp on KnollExtra accessories such as flat screen monitor arm or task light.

Other worksurface types

End counters have front edge detail on side edges as well and are designed to extend dual tables 24" or 30" beyond the endleg. End counters also include 3" wide center grommet. Extended end counters are 36"D surfaces with center grommet or hinged power access door. Base of the table must be extended 12" under the back of each extended end counter (although top channels should be specified only as wide as the worksurfaces on each side of the table).

All end counters must be supported by end counter cantilevers and endlegs for end counters.

Worksurface heights

Fixed height cantilevers support worksurfaces at 28 1/2"H, with 27" clear below the top (except directly below cantilevers).

Adjustable height cantilevers enable worksurfaces to be independently set at 27", 27 3/4", 28 1/2", 29 1/4", or 30"H.

Open Table base assemblies

Complete base assemblies simplify specifications for most common configurations of dual or single-sided open tables. Base assemblies include top channels and end caps, beams, end legs and intermediate legs (where required), trusses and top channel supports, cantilever brackets (specify fixed or adjustable height) and midspan supports. Specify worksurfaces, screens, power components, cable trays and accessories separately.

Complete base assemblies are available for the following typical tables, combinations of 60" or 72" worksurfaces.

Single-sided or dual, 24"D, 30"D, or 36"D, with continuous beam span between end legs

10' W two/four positions 60"W

12' W two/four positions 72"W

15' W three/six positions 60"W

Single sided or dual 24"D, 30"D, or 36"D, with intermediate leg

18' W three/six positions 72"W

20' W four/eight positions 60"W

24' W four/eight positions 72"W

25' W five/ten positions 60"W

Open Table base components

Base assemblies may also be specified by individual components to create configurations other than those listed above, or to create tables with end counters or frameless glass add ups.

In addition to worksurfaces Open tables require top channel, starter beams for spans up to 15', extension beams for additional spans of 4' to 15', intermediate legs every 16' or less, two end legs, trusses at every worksurface junction and at each end leg. Adjustable tables require two cantilevers per worksurface (or three for 96"W). Fixed height tables may be supported by a fixed height cantilever at each end, shared cantilevers at each worksurface joint, and a midspan support bracket at the center of each worksurface greater than 48" wide. For 96"W worksurfaces the midspan support should be a 24"D cantilever. Power components, cable trays and screens are optional.

Power distribution

Optional modular raceway distributes 2+2 four circuit or 3+3 six circuit configuration from a single point of supply. Bundles of cables can be managed from the floor in a cable infeed shroud located at any intermediate leg. Raceway provides power outlets and data/communications outlet openings on one or both sides, accessed through hinged access doors in worksurfaces or from under table. Specify 30" raceway for two duplex outlets each side or 42" raceway for four duplex outlets each side. Duplex outlets, power infeed and jumpers between raceways must be specified separately.

Specify compact power module for outlets under extended end counters.

Privacy screens

There are four screen options for Crinion Open Table.

The standard screens are 14"H (42" horizon) or 21"H (49" horizon) in acrylic, slat wall or combination surfaces. Center screens include mounting hardware to attach to the standard top channel. Center screens are available full width, 48", 60" or 72", or shorter by 1" to leave space at either end of the table for a dual end screen. Side screens attach to the front and back of a worksurface at any point other than at a hinged access door. Mounting brackets are specified separately to correspond to each worksurface edge detail. Dual end screens span across the end of a table (or above an end counter) from worksurface front edges.

Frameless glass add ups are available in 12" height only, 48", 60", and 72"W. Add ups can only mount to a top channel for frameless glass add ups, which may be at the center of a dual table or back of a single-sided table specified by components.

Original Crinion privacy screens are 12"H or 19"H (41" or 48" horizons) and mount to a standard top channel only.

Morrison Network fabric screens (15"H or 22"H) can also be mounted to the standard top channel with Crinion Open Table mast kit.

Accessories and storage

All Crinion worksurfaces accept clamp base KnollExtra flat screen monitor arms and task lights at any point except behind the hinged power access door. Worksurfaces also accept suspended accessories like adjustable keyboard supports, BackPack center file or keyboard drawers, or CPU holders. Beam location under most tables prevents pedestals deeper than 20" underneath. However 36"D tops can be planned on 30"D table bases to create additional kneespace depth and room for 24"D pedestals.

Crinion Open Table file tops are available for 27"H Calibre files positioned perpendicular to the table to act as returns. Tapered front and back edges assure consistent detail with tapered worksurface edges. File tops are also available for pairs of files and back to back files.

Finishes

L - Laminate

Matching edge band unless noted otherwise

- 117 Soft Grey
- 118 Bright White
- 114 Folkstone Grey
- 111 Jet Black
- 119 Pumice
- 121 Micro Grey with 114 Folkstone grey edge band
- 122 Brushed Sand with 119 Pumice edge band
- 123 Brushed Grey with 128 Fog edge band
- 128 Fog
- 129 Micro Sand with 119 Pumice edge band

Additional wood grain laminates for application on postformed laminate tops only.

(not available on end counters or tapered edge tops):

- 125 Natural Maple
- 126 Natural Cherry
- 124 Medium Cherry
- 127 Walnut

V1 - Techwood Veneer

- Y316 Maple
- Y319 Cherry
- Y323 Medium Walnut
- Y326 Dark Mahogany
- Y329 Medium Oak
- Y341 Wenge
- Y342 Medium Teak
- Y344 Espresso
- Y811 Natural
- Y821 Blond Maple
- Y831 Light Cherry
- Y851 Black Oak
- Y881 Light Walnut
- Y882 Dove Grey

V2 – Natural Veneer/Premium Techwood Veneer

- V312 Bronze Cherry
 - V316 Maple
 - V319 Medium Cherry
 - V411 Light Walnut
 - V412 Natural Cherry
 - V413 Sand Oak
 - V414 Natural Oak
 - V415 Peacock Green Walnut
 - V417 Old English Walnut
 - V433 Light Fawn Cherry
 - V436 Medium Brown Cherry
- (above V2's are flat cut)*

- V421 Chalk Oak
 - V423 Light Oak
- (above V2 Oaks are rift cut)*

- V439 Straight Anigre
 - V440 Natural Hemock
- (above V2's are quarter cut)*

- Y841 Ebony
 - Y861 Grigio
- (above Premium Techwoods are straight grain)*

V3 – Natural Exotic veneer

- V512 Figured Anigre
 - V514 Makore
 - V515 Figured Sycamore
 - V517 Sapele
 - V518 Natural Chestnut
- (all remaining V3s are quarter cut)*

Paint

- P1**
- 111 Jet Black
 - 112 Brown
 - 113 Dark Grey
 - 114 Folkstone Grey
 - 115 Medium Grey
 - 116 Sandstone
 - 117 Soft Grey
- P2**
- 611 Beige Mist Metallic
 - 612 Medium Metallic Grey

P3

- 613 Silver
- 118 Bright White

Anodized

- AA Anodized Aluminum

Glass

- TEMP Clear Tempered
- GL13 Powder

Acrylic

- O Opal
- T Translucent

Architectural

- GL13 Powder

Fabric Options

- Grade 10*
- Annex (W1360)
 - Beacon (W1597)
 - Broadcloth II (W1619)
 - Element (W1077)
 - Foundation (W351)
 - Growth Spurt (W692)
 - Skylark (W1718)
 - Symbolic Detail (W693)
 - Tailor Made II (W1610)
 - Versatility (W432)

Fabric Options

- Grade 20*
- Bauhaus Block (W296A)
 - Circle Line (W1146)
 - Clarity (W281)
 - Criss Cross (W305)
 - Logic (W1318)
 - Mainframe (W1783)
 - Newmatic II (W1620)
 - Photon II (W1695)
 - Reflect (W884)
 - Resolution (W280)
 - Weave Three (W298)

Grade 30

- Basket Draft (W249)
- Flow (W565)
- Harmony (W232)
- Interknit (W1090)
- Match Point (W1145)
- Micro (W465)
- Relay (W1020)

Grade 40

- Amplify (W1215)
- Bandwidth (W1219)
- Hourglass (K1523)
- Ornament (W1078)
- Spellbound (W1464)

Grade 45

- Macro (W544)
- Mezzo (W543)

Grade 50

- Presto (K1000)
- Trophy (K1709)
- Versa (K1698)

Grade 55

- Ransom (K1298)
- Transition (W816)

Customers Own Material
 Prices for panels that are to be manufactured with a customer supplied fabric will follow Grade 10 panel pricing. COM fabrics are subject to a testing charge prior to acceptance for use on panels. Panels bearing COM fabrics are subject to extended leadtimes. It is the responsibility of the customer's purchasing agent to ensure COM fabric is supplied for testing and manufacturing. Delays in receiving COM fabric for manufacturing will result in rescheduled delivery dates.

Mixed Finish work surfaces:

To order mixed finishes, enter four digit finish code as follows:

Use 2 digit prefix to indicate surface finish (laminate)

- 11 Jet Black
- 14 Folkstone Grey
- 17 Soft Grey
- 18 Bright White
- 19 Pumice
- 21 Micro Grey
- 22 Brushed Sand
- 23 Brushed Grey
- 28 Fog
- 29 Micro Sand

Use 2 digit suffix to indicate edge finish (wood)

- 16 for V316, Y316
- Y9 for Y319
- Y3 for Y323
- 26 for Y326
- 27 for Y327
- 29 for Y329
- 43 for V433
- 45 for V415
- 46 for V436
- 47 for V417
- 48 for V418
- 52 for V512
- 54 for V514
- 55 for V515
- 57 for V517
- 61 for V411
- 71 for V421
- 73 for V423
- 75 for V425
- 77 for V427

Example:

For a Micro Grey laminate surface with Bronzed Cherry edge, enter finish code 2112

For a Jet Black laminate surface with Light Maple edge, enter finish code 1116

Crinion Open Table

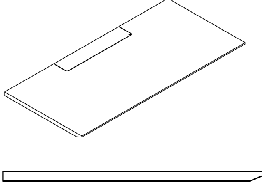
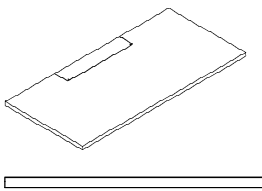
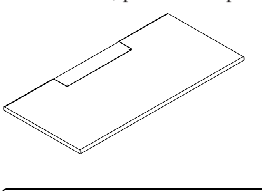
description	nominal depth	w	d	h	pattern number	L	M	V1	V2	V3
Worksurface, tapered edge 	24"	48"	22"	1 1/4"	XTTK4824A (L/M/1/2/3) () ()	\$826.	\$968.	\$968.	\$1,063.	\$1,290.
	24"	60"	22"	1 1/4"	XTTK6024A (L/M/1/2/3) () ()	857.	1,061.	1,061.	1,171.	1,429.
	24"	72"	22"	1 1/4"	XTTK7224A (L/M/1/2/3) () ()	916.	1,121.	1,121.	1,244.	1,526.
	24"	96"	22"	1 1/4"	XTTK9624A (L/M/1/2/3) () ()	1,023.	1,267.	1,267.	1,414.	1,746.
	30"	48"	28"	1 1/4"	XTTK4830A (L/M/1/2/3) () ()	839.	1,050.	1,050.	1,162.	1,416.
	30"	60"	28"	1 1/4"	XTTK6030A (L/M/1/2/3) () ()	885.	1,138.	1,138.	1,262.	1,545.
	30"	72"	28"	1 1/4"	XTTK7230A (L/M/1/2/3) () ()	948.	1,178.	1,178.	1,307.	1,606.
	30"	96"	28"	1 1/4"	XTTK9630A (L/M/1/2/3) () ()	1,061.	1,335.	1,335.	1,488.	1,841.
	36"	48"	34"	1 1/4"	XTTK4836A (L/M/1/2/3) () ()	880.	1,144.	1,144.	1,274.	1,563.
	36"	60"	34"	1 1/4"	XTTK6036A (L/M/1/2/3) () ()	906.	1,227.	1,227.	1,361.	1,674.
	36"	72"	34"	1 1/4"	XTTK7236A (L/M/1/2/3) () ()	990.	1,241.	1,241.	1,376.	1,694.
	36"	96"	34"	1 1/4"	XTTK9636A (L/M/1/2/3) () ()	1,129.	1,405.	1,405.	1,567.	1,944.
	Worksurface, veneer square edge 	24"	48"	22"	1 1/4"	XTTS4824A (1/2/3) () ()	n/a	n/a	788.	869.
24"		60"	22"	1 1/4"	XTTS6024A (1/2/3) () ()	n/a	n/a	827.	909.	1,032.
24"		72"	22"	1 1/4"	XTTS7224A (1/2/3) () ()	n/a	n/a	869.	950.	1,087.
24"		96"	22"	1 1/4"	XTTS9624A (1/2/3) () ()	n/a	n/a	936.	1,018.	1,180.
30"		48"	28"	1 1/4"	XTTS4830A (1/2/3) () ()	n/a	n/a	909.	991.	1,126.
30"		60"	28"	1 1/4"	XTTS6030A (1/2/3) () ()	n/a	n/a	936.	1,024.	1,181.
30"		72"	28"	1 1/4"	XTTS7230A (1/2/3) () ()	n/a	n/a	964.	1,060.	1,289.
30"		96"	28"	1 1/4"	XTTS9630A (1/2/3) () ()	n/a	n/a	1,018.	1,126.	1,466.
36"		48"	34"	1 1/4"	XTTS4836A (1/2/3) () ()	n/a	n/a	991.	1,092.	1,263.
36"		60"	34"	1 1/4"	XTTS6036A (1/2/3) () ()	n/a	n/a	1,032.	1,134.	1,295.
36"		72"	34"	1 1/4"	XTTS7236A (1/2/3) () ()	n/a	n/a	1,072.	1,197.	1,418.
36"		96"	34"	1 1/4"	XTTS9636A (1/2/3) () ()	n/a	n/a	1,154.	1,316.	1,641.
Worksurface, postformed plastic 		24"	48"	22"	1 1/4"	XTPP4824A (L) () ()	601.	n/a	n/a	n/a
	24"	60"	22"	1 1/4"	XTPP6024A (L) () ()	688.	n/a	n/a	n/a	n/a
	24"	72"	22"	1 1/4"	XTPP7224A (L) () ()	755.	n/a	n/a	n/a	n/a
	24"	96"	22"	1 1/4"	XTPP9624A (L) () ()	828.	n/a	n/a	n/a	n/a
	30"	48"	28"	1 1/4"	XTPP4830A (L) () ()	628.	n/a	n/a	n/a	n/a
	30"	60"	28"	1 1/4"	XTPP6030A (L) () ()	721.	n/a	n/a	n/a	n/a
	30"	72"	28"	1 1/4"	XTPP7230A (L) () ()	796.	n/a	n/a	n/a	n/a
	30"	96"	28"	1 1/4"	XTPP9630A (L) () ()	883.	n/a	n/a	n/a	n/a
	36"	48"	34"	1 1/4"	XTPP4836A (L) () ()	664.	n/a	n/a	n/a	n/a
	36"	60"	34"	1 1/4"	XTPP6036A (L) () ()	796.	n/a	n/a	n/a	n/a
	36"	72"	34"	1 1/4"	XTPP7236A (L) () ()	860.	n/a	n/a	n/a	n/a
	36"	96"	34"	1 1/4"	XTPP9636A (L) () ()	957.	n/a	n/a	n/a	n/a

Order Code	Specifications	Application Notes
Example: XTPP6030AL 118 118	Worksurfaces are 1 1/4" thick with square edge or tapered edge option tapering to 1/2" thick front edge.	Crinion 30"D worksurfaces correspond in width to table bases, which are specified separately.
XT Crinion Open Table		48"W worksurfaces plan on 12' wide or 20' wide bases. 60"W worksurfaces plan on 5', 10', 15' and 20' wide bases. 72" W worksurfaces plan on 6', 12' and 18' wide bases.
T Worksurface	1. Specify finish group: L - Laminate M - Laminate/veneer edge	Power access door is 24" wide, 5" deep, centered at back edge of worksurface.
P Postformed plastic	1 - Veneer group 1 2 - Veneer group 2 3 - Veneer group 3	Continous 1/2" wire drop accommodates clamp-on flat screen monitor arm or most power cords plugs.
60 Width	2. Specify worksurface finish.	Actual worksurface depth is 22.35", 28.35" or 34.35".
30 Depth	3. Specify hinged access cover finish.	
A With center hinged power access		
L Finish Type	AA anodized aluminum and all P1,P2 and P3 paint finishes are available except 613 Silver.	Worksurfaces with hinged power access enable access to suspended modular raceway.
118 Work Surface finish		
118 Access door finish		

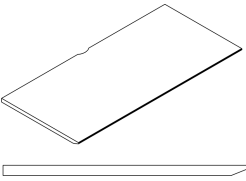
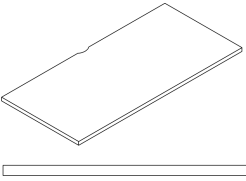
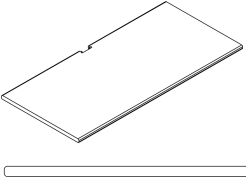
description	nominal depth	w	d	h	pattern number	L	M	V1	V2	V3	
Worksurface, tapered edge 	24"	48"	22"	1 1/4"	XTTK4824U (L/M/1/2/3) () ()	\$555.	\$698.	\$698.	\$792.	\$1,019.	
	24"	60"	22"	1 1/4"	XTTK6024U (L/M/1/2/3) () ()	587.	790.	790.	901.	1,159.	
	24"	72"	22"	1 1/4"	XTTK7224U (L/M/1/2/3) () ()	646.	851.	851.	973.	1,255.	
	24"	96"	22"	1 1/4"	XTTK9624U (L/M/1/2/3) () ()	753.	996.	996.	1,144.	1,476.	
	30"	48"	28"	1 1/4"	XTTK4830U (L/M/1/2/3) () ()	569.	780.	780.	891.	1,146.	
	30"	60"	28"	1 1/4"	XTTK6030U (L/M/1/2/3) () ()	615.	867.	867.	991.	1,275.	
	30"	72"	28"	1 1/4"	XTTK7230U (L/M/1/2/3) () ()	678.	908.	908.	1,037.	1,335.	
	30"	96"	28"	1 1/4"	XTTK9630U (L/M/1/2/3) () ()	790.	1,065.	1,065.	1,218.	1,570.	
	36"	48"	34"	1 1/4"	XTTK4836U (L/M/1/2/3) () ()	609.	874.	874.	1,004.	1,293.	
	36"	60"	34"	1 1/4"	XTTK6036U (L/M/1/2/3) () ()	635.	957.	957.	1,091.	1,404.	
	36"	72"	34"	1 1/4"	XTTK7236U (L/M/1/2/3) () ()	720.	970.	970.	1,106.	1,424.	
	36"	96"	34"	1 1/4"	XTTK9636U (L/M/1/2/3) () ()	859.	1,135.	1,135.	1,297.	1,673.	
	Worksurface, veneer square edge 	24"	48"	22"	1 1/4"	XTTS4824U (1/2/3) () ()	n/a	n/a	518.	599.	708.
		24"	60"	22"	1 1/4"	XTTS6024U (1/2/3) () ()	n/a	n/a	556.	639.	761.
24"		72"	22"	1 1/4"	XTTS7224U (1/2/3) () ()	n/a	n/a	599.	679.	816.	
24"		96"	22"	1 1/4"	XTTS9624U (1/2/3) () ()	n/a	n/a	666.	748.	910.	
30"		48"	28"	1 1/4"	XTTS4830U (1/2/3) () ()	n/a	n/a	639.	721.	856.	
30"		60"	28"	1 1/4"	XTTS6030U (1/2/3) () ()	n/a	n/a	666.	754.	911.	
30"		72"	28"	1 1/4"	XTTS7230U (1/2/3) () ()	n/a	n/a	694.	789.	1,018.	
30"		96"	28"	1 1/4"	XTTS9630U (1/2/3) () ()	n/a	n/a	748.	856.	1,196.	
36"		48"	34"	1 1/4"	XTTS4836U (1/2/3) () ()	n/a	n/a	721.	822.	992.	
36"		60"	34"	1 1/4"	XTTS6036U (1/2/3) () ()	n/a	n/a	761.	863.	1,024.	
36"		72"	34"	1 1/4"	XTTS7236U (1/2/3) () ()	n/a	n/a	802.	927.	1,147.	
36"		96"	34"	1 1/4"	XTTS9636U (1/2/3) () ()	n/a	n/a	884.	1,045.	1,371.	
Worksurface, postformed plastic 		24"	48"	22"	1 1/4"	XTPP4824B (L) () ()	331.	n/a	n/a	n/a	n/a
		24"	60"	22"	1 1/4"	XTPP6024B (L) () ()	418.	n/a	n/a	n/a	n/a
	24"	72"	22"	1 1/4"	XTPP7224B (L) () ()	485.	n/a	n/a	n/a	n/a	
	24"	96"	22"	1 1/4"	XTPP9624B (L) () ()	557.	n/a	n/a	n/a	n/a	
	30"	48"	28"	1 1/4"	XTPP4830B (L) () ()	358.	n/a	n/a	n/a	n/a	
	30"	60"	28"	1 1/4"	XTPP6030B (L) () ()	450.	n/a	n/a	n/a	n/a	
	30"	72"	28"	1 1/4"	XTPP7230B (L) () ()	525.	n/a	n/a	n/a	n/a	
	30"	96"	28"	1 1/4"	XTPP9630B (L) () ()	613.	n/a	n/a	n/a	n/a	
	36"	48"	34"	1 1/4"	XTPP4836B (L) () ()	393.	n/a	n/a	n/a	n/a	
	36"	60"	34"	1 1/4"	XTPP6036B (L) () ()	525.	n/a	n/a	n/a	n/a	
	36"	72"	34"	1 1/4"	XTPP7236B (L) () ()	590.	n/a	n/a	n/a	n/a	
	36"	96"	34"	1 1/4"	XTPP9636B (L) () ()	686.	n/a	n/a	n/a	n/a	

Crinion Open Table

Order Code	Specifications	Application Notes
Example: XTPP6030BL 118 812		
XT Crinion Open Table	Worksurfaces are 1 1/4" thick with square edge or tapered edge option tapering to 1/2" thick front edge.	Crinion 30"D worksurfaces correspond in width to table bases, which are specified separately.
T Worksurface	1. Specify finish group: L - Laminate M - Laminate/veneer edge	48"W worksurfaces plan on 12" wide or 20" wide bases. 60"W worksurfaces plan on 5', 10', 15' and 20' wide bases. 72" W worksurfaces plan on 6', 12' and 18' wide bases.
P Postformed plastic	1 - Veneer group 1 2 - Veneer group 2 3 - Veneer group 3	
60 Width	2. Specify worksurface finish.	
30 Depth	3. Specify grommet color: 812 - Easy grey 111 - Black	Edge grommet accommodates most power cord plugs up to 1" deep.
B With edge grommet		
L Finish type		
118 Surface finish		
812 Grommet finish		Actual worksurface depth is 21.85", 27.85" or 33.85".

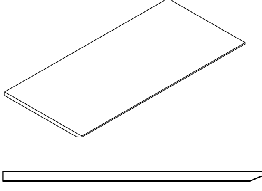
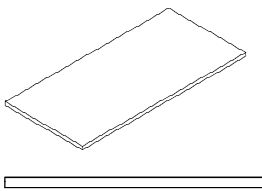
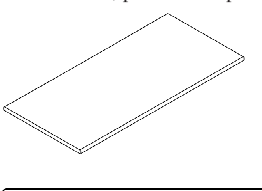
description	nominal depth	w	d	h	pattern number	L	M	V1	V2	V3
Worksurface, tapered edge 	24"	48"	22"	1 1/4"	XTTK4824C (L/M/1/2/3) ()	\$514.	\$656.	\$656.	\$751.	\$978.
	24"	60"	22"	1 1/4"	XTTK6024C (L/M/1/2/3) ()	545.	749.	749.	859.	1,117.
	24"	72"	22"	1 1/4"	XTTK7224C (L/M/1/2/3) ()	604.	809.	809.	932.	1,214.
	24"	96"	22"	1 1/4"	XTTK9624C (L/M/1/2/3) ()	711.	955.	955.	1,102.	1,434.
	30"	48"	28"	1 1/4"	XTTK4830C (L/M/1/2/3) ()	527.	738.	738.	850.	1,104.
	30"	60"	28"	1 1/4"	XTTK6030C (L/M/1/2/3) ()	573.	826.	826.	950.	1,233.
	30"	72"	28"	1 1/4"	XTTK7230C (L/M/1/2/3) ()	636.	866.	866.	995.	1,294.
	30"	96"	28"	1 1/4"	XTTK9630C (L/M/1/2/3) ()	749.	1,023.	1,023.	1,176.	1,529.
	36"	48"	34"	1 1/4"	XTTK4836C (L/M/1/2/3) ()	568.	832.	832.	962.	1,251.
	36"	60"	34"	1 1/4"	XTTK6036C (L/M/1/2/3) ()	594.	915.	915.	1,049.	1,362.
	36"	72"	34"	1 1/4"	XTTK7236C (L/M/1/2/3) ()	678.	929.	929.	1,064.	1,382.
	36"	96"	34"	1 1/4"	XTTK9636C (L/M/1/2/3) ()	817.	1,093.	1,093.	1,255.	1,632.
	Worksurface, veneer square edge 	24"	48"	22"	1 1/4"	XTTS4824C (1/2/3) ()	n/a	n/a	476.	557.
24"		60"	22"	1 1/4"	XTTS6024C (1/2/3) ()	n/a	n/a	515.	597.	720.
24"		72"	22"	1 1/4"	XTTS7224C (1/2/3) ()	n/a	n/a	557.	638.	775.
24"		96"	22"	1 1/4"	XTTS9624C (1/2/3) ()	n/a	n/a	624.	706.	868.
30"		48"	28"	1 1/4"	XTTS4830C (1/2/3) ()	n/a	n/a	597.	679.	814.
30"		60"	28"	1 1/4"	XTTS6030C (1/2/3) ()	n/a	n/a	624.	712.	869.
30"		72"	28"	1 1/4"	XTTS7230C (1/2/3) ()	n/a	n/a	652.	748.	977.
30"		96"	28"	1 1/4"	XTTS9630C (1/2/3) ()	n/a	n/a	706.	814.	1,154.
36"		48"	34"	1 1/4"	XTTS4836C (1/2/3) ()	n/a	n/a	679.	780.	951.
36"		60"	34"	1 1/4"	XTTS6036C (1/2/3) ()	n/a	n/a	720.	822.	983.
36"		72"	34"	1 1/4"	XTTS7236C (1/2/3) ()	n/a	n/a	760.	885.	1,106.
36"		96"	34"	1 1/4"	XTTS9636C (1/2/3) ()	n/a	n/a	842.	1,004.	1,329.
Worksurface, postformed plastic 		24"	48"	22"	1 1/4"	XTTP4824C (L) ()	289.	n/a	n/a	n/a
	24"	60"	22"	1 1/4"	XTTP6024C (L) ()	376.	n/a	n/a	n/a	n/a
	24"	72"	22"	1 1/4"	XTTP7224C (L) ()	443.	n/a	n/a	n/a	n/a
	24"	96"	22"	1 1/4"	XTTP9624C (L) ()	516.	n/a	n/a	n/a	n/a
	30"	48"	28"	1 1/4"	XTTP4830C (L) ()	316.	n/a	n/a	n/a	n/a
	30"	60"	28"	1 1/4"	XTTP6030C (L) ()	409.	n/a	n/a	n/a	n/a
	30"	72"	28"	1 1/4"	XTTP7230C (L) ()	484.	n/a	n/a	n/a	n/a
	30"	96"	28"	1 1/4"	XTTP9630C (L) ()	571.	n/a	n/a	n/a	n/a
	36"	48"	34"	1 1/4"	XTTP4836C (L) ()	352.	n/a	n/a	n/a	n/a
	36"	60"	34"	1 1/4"	XTTP6036C (L) ()	484.	n/a	n/a	n/a	n/a
	36"	72"	34"	1 1/4"	XTTP7236C (L) ()	548.	n/a	n/a	n/a	n/a
	36"	96"	34"	1 1/4"	XTTP9636C (L) ()	645.	n/a	n/a	n/a	n/a

Order Code	Specifications	Application Notes
Example: XTTP6030CL 118	Worksurfaces are 1 1/4" thick with square edge or tapered edge option tapering to 1/2" thick front edge.	Crinion 30"D worksurfaces correspond in width to table bases, which are specified separately.
XT Crinion Open Table		48"W worksurfaces plan on 12' wide or 20' wide bases. 60"W worksurfaces plan on 5', 10', 15' and 20' wide bases. 72" W worksurfaces plan on 6', 12' and 18' wide bases.
T Worksurface		
P Postformed plastic	Specify finishes: L - Laminate M - Laminate/veneer edge	
60 Width	1 - Veneer group 1 2 - Veneer group 2 3 - Veneer group 3	
30 Depth		
C With cord drop		
L Finish type		
118 Surface		Actual work surface depth is 21.85", 27.85" or 33.85".

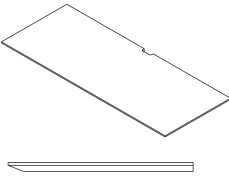
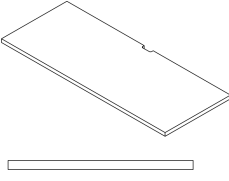
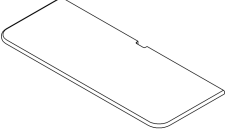
description	nominal depth	w	l	h	pattern number	L	M	V1	V2	V3
End counter, tapered edge 	24"	48"	24"	1 1/4"	XTTK4824E (L/M/1/2/3) ()	\$721.	\$928.	\$928.	\$1,023.	\$1,248.
	24"	60"	24"	1 1/4"	XTTK6024E (L/M/1/2/3) ()	853.	1,020.	1,020.	1,133.	1,389.
	24"	72"	24"	1 1/4"	XTTK7224E (L/M/1/2/3) ()	886.	1,078.	1,078.	1,204.	1,484.
	30"	48"	30"	1 1/4"	XTTK4830E (L/M/1/2/3) ()	807.	1,009.	1,009.	1,122.	1,376.
	30"	60"	30"	1 1/4"	XTTK6030E (L/M/1/2/3) ()	879.	1,097.	1,097.	1,220.	1,505.
	30"	72"	30"	1 1/4"	XTTK7230E (L/M/1/2/3) ()	917.	1,138.	1,138.	1,266.	1,566.
End counter, veneer square edge 	24"	48"	24"	1 1/4"	XTTS4824E (1/2/3) ()	n/a	n/a	476.	557.	667.
	24"	60"	24"	1 1/4"	XTTS6024E (1/2/3) ()	n/a	n/a	515.	597.	720.
	24"	72"	24"	1 1/4"	XTTS7224E (1/2/3) ()	n/a	n/a	557.	638.	775.
	30"	48"	30"	1 1/4"	XTTS4830E (1/2/3) ()	n/a	n/a	597.	679.	814.
	30"	60"	30"	1 1/4"	XTTS6030E (1/2/3) ()	n/a	n/a	624.	712.	869.
	30"	72"	30"	1 1/4"	XTTS7230E (1/2/3) ()	n/a	n/a	652.	748.	977.
End counter for postformed plastic 	24"	48"	24"	1 1/4"	XTTP4824E (L) ()	538.	n/a	n/a	n/a	n/a
	24"	60"	24"	1 1/4"	XTTP6024E (L) ()	638.	n/a	n/a	n/a	n/a
	24"	72"	24"	1 1/4"	XTTP7224E (L) ()	719.	n/a	n/a	n/a	n/a
	30"	48"	30"	1 1/4"	XTTP4830E (L) ()	603.	n/a	n/a	n/a	n/a
	30"	60"	30"	1 1/4"	XTTP6030E (L) ()	719.	n/a	n/a	n/a	n/a
	30"	72"	30"	1 1/4"	XTTP7230E (L) ()	859.	n/a	n/a	n/a	n/a

* Note

Order Code	Specifications	Application Notes
Example: XTTP6024EL 118		
XT Crinion Open Table	End counters are 1 1/4" thick with square edge or tapered edge option tapering to 1/2" thick front edge. End counters are tapered front and side edges only.	End counters mount at the ends of dual tables with two end counter cantilever brackets. Specify dual end legs for end counters instead of standard dual end legs (tables with end counters must be specified from components, not assemblies).
T Worksurface		Specify added length of 24" or 30" beyond end leg for end counters.
P Postformed plastic		* Note - End counters for postformed plastic are not available in these finishes:
60 Width	Specify finishes:	121 Micro grey
24 Length	L - Laminate	129 Micro sand
E End counter	M- Laminate/veneer edge	122 Brushed sand
L Finish Type	1 - Veneer group 1	123 Brushed grey
118 Surface	2 - Veneer group 2	
	3 - Veneer group 3	End counters may not be used with end panel kits.

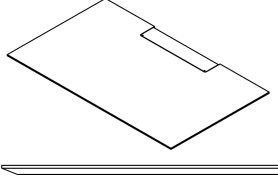
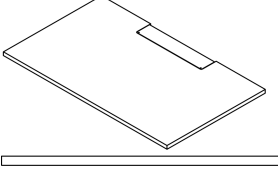
description	nominal				pattern no.	L	M	V1	V2	V3
	depth	w	l	h						
Extended end counter, tapered edge with hinged power access 	36"	48"	36"	1 1/4"	XTTK4836D (L/M/1/2/3) () ()	\$1,197.	\$1,389.	\$1,389.	\$1,514.	\$1,794.
	36"	60"	36"	1 1/4"	XTTK6036D (L/M/1/2/3) () ()	1,228.	1,449.	1,449.	1,577.	1,877.
	36"	72"	36"	1 1/4"	XTTK7236D (L/M/1/2/3) () ()	1,318.	1,560.	1,560.	1,696.	2,028.
Extended end counter, tapered edge with grommet	36"	48"	36"	1 1/4"	XTTK4836E (L/M/1/2/3) ()	886.	1,078.	1,078.	1,204.	1,484.
	36"	60"	36"	1 1/4"	XTTK6036E (L/M/1/2/3) ()	917.	1,138.	1,138.	1,266.	1,566.
	36"	72"	36"	1 1/4"	XTTK7236E (L/M/1/2/3) ()	1,007.	1,249.	1,249.	1,385.	1,717.
Extended end counter, veneer square edge with hinged power access 	36"	48"	36"	1 1/4"	XTTS4836D (1/2/3) () ()	n/a	n/a	841.	918.	1,048.
	36"	60"	36"	1 1/4"	XTTS6036D (1/2/3) () ()	n/a	n/a	963.	1,059.	1,288.
	36"	72"	36"	1 1/4"	XTTS7236D (1/2/3) () ()	n/a	n/a	1,059.	1,159.	1,431.
Extended end counter, veneer square edge with grommet	36"	48"	36"	1 1/4"	XTTS4836E (1/2/3) ()	n/a	n/a	530.	607.	737.
	36"	60"	36"	1 1/4"	XTTS6036E (1/2/3) ()	n/a	n/a	652.	748.	977.
	36"	72"	36"	1 1/4"	XTTS7236E (1/2/3) ()	n/a	n/a	748.	848.	1,120.

Order Code	Specifications	Application Notes
Example: XTTP6036DL 118 AA		
XT Crinion Open Table	End counters are 1 1/4" thick with square edge or tapered edge option tapering to 1/2" thick front edge. End counters are tapered front and side edges only. 1. Specify finish group: L - Laminate M - Laminate/veneer edge 1 - Veneer group 1 2 - Veneer group 2 3 - Veneer group 3 2. Specify worksurface finish. 3. Specify hinged access cover finish.	End counters mount at the ends of dual tables with two end counter cantilever brackets. Specify dual end legs for end counters instead of standard dual end legs (tables with end counters must be specified from components, not assemblies). Specify 48" W for dual 24" tables, 60" W for dual 30" tables and 72" W for dual 36" tables. End counters may not be used with end panel kits.
T Worksurface		
P Postformed plastic		
60 Width		
36 Length		
D End counter, center hinged power access		
L Finish Type		
118 Surface finish		
AA Access door finish		

Hinged access covers are available in AA anodized aluminum and all standard paint finishes except 613 Silver.

description	nominal depth	w	l	h	pattern no.	L	M	V1	V2	V3
Extended end counter, postformed plastic with hinged power access	36"	48"	36"	1 1/4"	XTTP4836D (L) () ()	\$1,030.	n/a	n/a	n/a	n/a
	36"	60"	36"	1 1/4"	XTTP6036D (L) () ()	1,170.	n/a	n/a	n/a	n/a
	36"	72"	36"	1 1/4"	XTTP7236D (L) () ()	1,272.	n/a	n/a	n/a	n/a

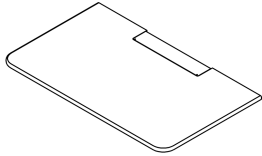

* Note

Extended end counter, postformed plastic with grommet	36"	48"	36"	1 1/4"	XTTP4836E (L) () ()	719.	n/a	n/a	n/a	n/a
	36"	60"	36"	1 1/4"	XTTP6036E (L) () ()	859.	n/a	n/a	n/a	n/a
	36"	72"	36"	1 1/4"	XTTP7236E (L) () ()	961.	n/a	n/a	n/a	n/a

* Note

Order Code	Specifications	Application Notes
Example: XTTP6036DL 118 AA		
XT Crinion Open Table	End counters are 1 1/4" thick with square edge or tapered edge option tapering to 1/2" thick front edge. End counters are tapered front and side edges only. 1. Specify finish group: L - Laminate M - Laminate/veneer edge 1 - Veneer group 1 2 - Veneer group 2 3 - Veneer group 3 2. Specify worksurface finish. 3. Specify hinged access cover finish.	End counters mount at the ends of dual tables with two end counter cantilever brackets. Specify dual end legs for end counters instead of standard dual end legs (tables with end counters must be specified from components, not assemblies). Specify 48" W for dual 24" tables, 60" W for dual 30" tables and 72" W for dual 36" tables. End counters may not be used with end panel kits.
T Worksurface		
P Postformed plastic		
60 Width		
36 Length		
D End counter, center hinged power access		
L Finish Type		
118 Surface finish		
AA Access door finish		

Hinged access covers are available in AA anodized aluminum and all standard paint finishes except 613 Silver.

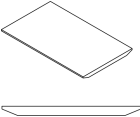
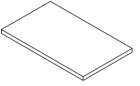
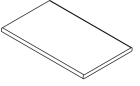
description	w	d	h	pattern number	L	M	V1	V2	V3
File top, tapered edge 	30"	18"	1 1/4"	XTTK3018F (L/M/1/2/3) ()	\$376.	\$638.	\$624.	\$667.	\$964.
	30"	36"	1 1/4"	XTTK3036F (L/M/1/2/3) ()	515.	806.	806.	903.	1,134.
	36"	18"	1 1/4"	XTTK3618F (L/M/1/2/3) ()	391.	652.	638.	673.	1,028.
	36"	36"	1 1/4"	XTTK3636F (L/M/1/2/3) ()	538.	883.	883.	988.	1,245.
	42"	18"	1 1/4"	XTTK4218F (L/M/1/2/3) ()	404.	667.	652.	685.	1,091.
	42"	36"	1 1/4"	XTTK4236F (L/M/1/2/3) ()	562.	916.	916.	1,035.	1,305.
	60"	18"	1 1/4"	XTTK6018F (L/M/1/2/3) ()	638.	985.	985.	1,086.	1,357.
	60"	36"	1 1/4"	XTTK6036F (L/M/1/2/3) ()	691.	1,049.	1,049.	1,185.	1,499.
	72"	18"	1 1/4"	XTTK7218F (L/M/1/2/3) ()	671.	1,019.	1,019.	1,140.	1,428.
	72"	36"	1 1/4"	XTTK7236F (L/M/1/2/3) ()	738.	1,065.	1,065.	1,200.	1,516.
	84"	18"	1 1/4"	XTTK8418F (L/M/1/2/3) ()	725.	1,086.	1,086.	1,221.	1,494.
	84"	36"	1 1/4"	XTTK8436F (L/M/1/2/3) ()	788.	1,143.	1,143.	1,302.	1,653.
File top, veneer square edge 	30"	18"	1 1/4"	XTTS3018F (1/2/3) ()	n/a	n/a	279.	306.	508.
	36"	18"	1 1/4"	XTTS3618F (1/2/3) ()	n/a	n/a	286.	312.	547.
	42"	18"	1 1/4"	XTTS4218F (1/2/3) ()	n/a	n/a	292.	320.	592.
File top, postformed plastic 	30"	18"	1 1/4"	XTTP3018F (L) ()	256.	n/a	n/a	n/a	n/a
	36"	18"	1 1/4"	XTTP3618F (L) ()	269.	n/a	n/a	n/a	n/a
	42"	18"	1 1/4"	XTTP4218F (L) ()	282.	n/a	n/a	n/a	n/a

Order Code	
Example: XTTP4218FL 118	
XT	Crinion Open Table
T	Worksurface
P	Postformed
42	Width
18	Depth
F	File top
L	Finish type
118	Surface

Specifications
File tops are 1 1/4" thick with square edge or tapered edge option tapering to 1/2" thick front edge. Tapered edge file tops are tapered front and back edges only.
Specify finishes: L - Laminate M - Laminate/veneer edge 1 - Veneer group 1 2 - Veneer group 2 3 - Veneer group 3

Application Notes
File tops correspond to 30", 36" or 42"W lateral files. File tops on 2 high Calibre files positioned perpendicular to the Crinion Open Table serve as a worksurface return.

Complete base assemblies fixed height 24" D dual

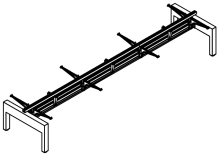
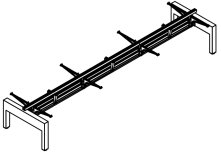
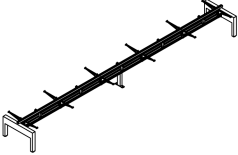
description	nominal	w	d	h	pattern number	P1/P2	P3
	10' dual	120"	44"	28 1/2"	XTB1 BAS 24D10CF () ()	\$9,647.	\$9,902.
	12' dual	144"	44"	28 1/2"	XTB1 BAS 24D12CF () ()	10,051.	10,308.
	15' dual	180"	44"	28 1/2"	XTB1 BAS 24D15CF () ()	11,631.	11,896.
	10' + 5' dual	180"	44"	28 1/2"	XTB1 BAS 24D15SF () ()	12,477.	12,745.
	12' + 6' dual	216"	44"	28 1/2"	XTB1 BAS 24D18SF () ()	13,768.	14,034.
	10' + 10' dual	240"	44"	28 1/2"	XTB1 BAS 24D20SF () ()	15,048.	15,323.
	12' + 12' dual	288"	44"	28 1/2"	XTB1 BAS 24D24SF () ()	15,856.	16,132.
	15' + 10' dual	300"	44"	28 1/2"	XTB1 BAS 24D25SF () ()	17,032.	17,317.

Order Code

Example: **XTB1BAS24D10CF 613 AA**

XT	Crinion Open Table
B1	Base components
BAS	Assembly
24	Depth
D	Dual
10	Width
C	Continuous
F	Fixed height
613	Base finish
AA	Top channel finish

Specifications

Base assemblies include end legs, beams, trusses, cantilever brackets, channels and end caps.

Fixed height base assemblies have shared cantilever brackets for adjacent worksurfaces and midspan support brackets for every worksurface.

- Specify painted finish for base assembly.
For leg and cantilever brackets specify one paint finish for all.
- Specify finish for top channel.
AA anodized aluminum and all paint finishes are available except 613 Silver.
Beams are anodized aluminum only.

Application Notes



Complete base assemblies include all base components necessary to support worksurfaces. Specify screens, power components and cable trays separately. Base assemblies include end legs, intermediate leg (where required), beams, trusses, cantilever brackets, mid span support brackets, top channel and end caps.

No table on this page has beams longer than 15'.

Base assemblies correspond to:
10': four 60"x24"D worksurfaces
12': four 72"x24"D worksurfaces
15': six 60"x24"D worksurfaces
18': six 72"x24"D worksurfaces
20': eight 60"x24"D worksurfaces
24': eight 72"x24"D worksurfaces
25': ten 60"x24"D worksurfaces

Complete base assemblies fixed height 24" D single sided

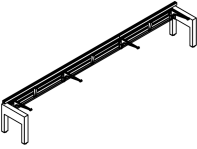
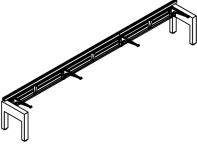
AutoStrada

description	nominal	w	d	h	pattern number	P1/P2	P3
 Base assembly, continuous	10' single sided	120"	24"	28 1/2"	XTB1 BAS 24S10CF () ()	\$8,680.	\$8,927.
	12' single sided	144"	24"	28 1/2"	XTB1 BAS 24S12CF () ()	9,085.	9,330.
	15' single sided	180"	24"	28 1/2"	XTB1 BAS 24S15CF () ()	10,305.	10,555.
 Base assembly, segmented	10' + 5' single sided	180"	24"	28 1/2"	XTB1 BAS 24S15SF () ()	11,152.	11,402.
 Base assembly, with intermediate leg	12' + 6' single sided	216"	24"	28 1/2"	XTB1 BAS 24S18SF () ()	12,440.	12,692.
	10' + 10' single sided	240"	24"	28 1/2"	XTB1 BAS 24S20SF () ()	13,361.	13,617.
	12' + 12' single sided	288"	24"	28 1/2"	XTB1 BAS 24S24SF () ()	14,169.	14,424.
	15' + 10' single sided	300"	24"	28 1/2"	XTB1 BAS 24S25SF () ()	14,984.	15,246.

Order Code

Example:	XTB1BAS24S10CF 613 118
XT	Crinion Open Table
B1	Base components
BAS	Assembly
24	Depth
S	Single
10	Width
C	Continuous
F	Fixed height
613	Base finish
118	Top channel finish

Specifications

Base assemblies include end legs, beams, trusses, cantilever brackets, channels and end caps.

Fixed height base assemblies have shared cantilever brackets for adjacent worksurfaces and midspan support brackets for every worksurface.

- Specify base finish for base assembly.
For legs and cantilever brackets specify one paint finish for all.
- Specify top channel finish.
AA anodized aluminum and all paint finishes are available except 613 Silver.
Beams are anodized aluminum only.

Application Notes

Complete base assemblies include all base components necessary to support worksurfaces. Specify screens, power components and cable trays separately. Base assemblies include end legs, intermediate leg (where required), beams, trusses, cantilever brackets, mid span support brackets, top channel and end caps.

No table on this page has beams longer than 15'.

Base assemblies correspond to:
 10': two 60"x24"D worksurfaces
 12': two 72"x24"D worksurfaces
 15': three 60"x24"D worksurfaces
 18': three 72"x24"D worksurfaces
 20': four 60"x24"D worksurfaces
 24': four 72"x24"D worksurfaces
 25': five 60"x24"D worksurfaces

Complete base assemblies fixed height 30" D dual

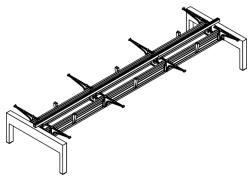
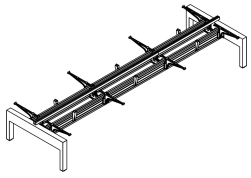
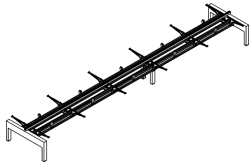
description	nominal	w	d	h	pattern number	P1/P2	P3
	10' dual	120"	54"	28½"	XTB1 BAS 30D10CF () ()	\$11,481.	\$11,806.
	12' dual	144"	54"	28½"	XTB1 BAS 30D12CF () ()	11,949.	12,273.
	15' dual	180"	54"	28½"	XTB1 BAS 30D15CF () ()	13,909.	14,269.
	10' + 5' dual	180"	54"	28½"	XTB1 BAS 30D15SF () ()	15,081.	15,441.
	12' + 6' dual	216"	54"	28½"	XTB1 BAS 30D18SF () ()	16,710.	17,124.
	10' + 10' dual	240"	54"	28½"	XTB1 BAS 30D20SF () ()	18,632.	19,077.
	12' + 12' dual	288"	54"	28½"	XTB1 BAS 30D24CF () ()	19,570.	20,015.
	15' + 10' dual	300"	54"	28½"	XTB1 BAS 30D25CF () ()	21,060.	21,539.

Order Code

Example:	XTB1BAS30D18SF 613 111
XT	Crinion Open Table
B1	Base components
BAS	Assembly
30	Depth
D	Dual
18	Width
S	Segmented
F	Fixed height
613	Base finish
111	Top channel finish

Specifications

Base assemblies include end legs, beams, trusses, cantilever brackets, channels and end caps.

Fixed height base assemblies have shared cantilever brackets for adjacent worksurfaces and midspan support brackets for every worksurface.

- Specify base finish for base assembly.
For legs and cantilever brackets specify one paint finish for all.
- Specify top channel finish.
AA anodized aluminum and all paint finishes are available except 613 Silver.
Beams are anodized aluminum only.

Application Notes



Complete base assemblies include all base components necessary to support worksurfaces. Specify screens, power components and cable trays separately. Base assemblies include end legs, intermediate leg (where required), beams, trusses, cantilever brackets, mid span support brackets, top channel and end caps.

No table on this page has beams longer than 15'.

Base assemblies correspond to:
 10': four 60"x30"D worksurfaces
 12': four 72"x30"D worksurfaces
 15': six 60"x30"D worksurfaces
 18': six 72"x30"D worksurfaces
 20': eight 60"x30"D worksurfaces
 24': eight 72"x30"D worksurfaces
 25': ten 60"x30"D worksurfaces

Complete base assemblies fixed height 30" D single sided

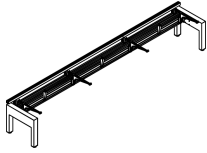
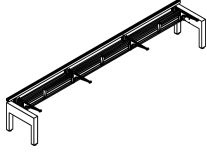
AutoStrada

description	nominal	w	d	h	pattern number	P1/P2	P3
 Base assembly, continuous	10' single sided	120"	28 ³ / ₄ "	28 ¹ / ₂ "	XTB1 BAS 30S10CF () ()	\$10,105.	\$10,386.
	12' single sided	144"	28 ³ / ₄ "	28 ¹ / ₂ "	XTB1 BAS 30S12CF () ()	10,573.	10,853.
	15' single sided	180"	28 ³ / ₄ "	28 ¹ / ₂ "	XTB1 BAS 30S15CF () ()	12,029.	12,327.
 Base assembly, segmented	10' + 5' single sided	180"	28 ³ / ₄ "	28 ¹ / ₂ "	XTB1 BAS 30S15SF () ()	11,248.	11,544.
 Base assembly, with intermediate leg	12' + 6' single sided	216"	28 ³ / ₄ "	28 ¹ / ₂ "	XTB1 BAS 30S18SF () ()	12,213.	12,508.
	10' + 10' single sided	240"	28 ³ / ₄ "	28 ¹ / ₂ "	XTB1 BAS 30S20SF () ()	13,888.	14,203.
	12' + 12' single sided	288"	28 ³ / ₄ "	28 ¹ / ₂ "	XTB1 BAS 30S24SF () ()	16,781.	17,096.
	15' + 10' single sided	300"	28 ³ / ₄ "	28 ¹ / ₂ "	XTB1 BAS 30S25SF () ()	17,769.	18,099.

Order Code

Example:	XTB1BAS30S15CF 613 115
XT	Crinion Open Table
B1	Base components
BAS	Assembly
30	Depth
S	Single
15	Width
C	Continuous
F	Fixed height
613	Base finish
115	Top channel finish

Specifications

Base assemblies include end legs, beams, trusses, cantilever brackets, channels and end caps.

Fixed height base assemblies have shared cantilever brackets for adjacent worksurfaces and midspan support brackets for every worksurface.

- Specify base finish for base assembly.
For legs and cantilever brackets specify one paint finish for all.
- Specify top channel finish.
AA anodized aluminum and all paint finishes are available except 613 Silver.
Beams are anodized aluminum only.

Application Notes

Complete base assemblies include all base components necessary to support worksurfaces. Specify screens, power components and cable trays separately. Base assemblies include end legs, intermediate leg (where required), beams, trusses, cantilever brackets, mid span support brackets, top channel and end caps.

No table on this page has beams longer than 15'.

Base assemblies correspond to:
 10': two 60"x30"D worksurfaces
 12': two 72"x30"D worksurfaces
 15': three 60"x30"D worksurfaces
 18': three 72"x30"D worksurfaces
 20': four 60"x30"D worksurfaces
 24': four 72"x30"D worksurfaces
 25': five 60"x30"D worksurfaces

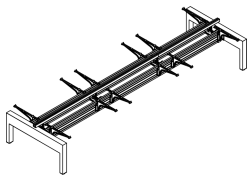
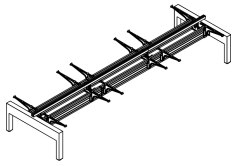
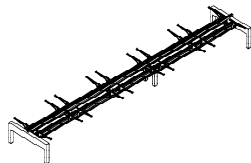

Complete base assemblies adjustable height 30" D dual

description	nominal	w	d	h	pattern number	P1/P2	P3
 Base assembly, continuous	10' dual	120"	54"	28 1/2"	XTB1 BAS 30D10CA () ()	\$11,650.	\$11,988.
	12' dual	144"	54"	28 1/2"	XTB1 BAS 30D12CA () ()	12,119.	12,457.
	15' dual	180"	54"	28 1/2"	XTB1 BAS 30D15CA () ()	14,399.	14,789.
 Base assembly, segmented	10' + 5' dual	180"	54"	28 1/2"	XTB1 BAS 30D15SA () ()	15,571.	15,963.
 Base assembly, with intermediate leg	12' + 6' dual	216"	54"	28 1/2"	XTB1 BAS 30D18SA () ()	17,201.	17,645.
	10' + 10' dual	240"	54"	28 1/2"	XTB1 BAS 30D20SA () ()	19,441.	19,937.
	12' + 12' dual	288"	54"	28 1/2"	XTB1 BAS 30D24CA () ()	20,380.	20,875.
	15' + 10' dual	300"	54"	28 1/2"	XTB1 BAS 30D25CA () ()	22,190.	22,739.

Order Code	Specifications	Application Notes
Example: XTB1BAS30D18SA 613 118	Base assemblies include end legs, beams, trusses, cantilever brackets, channels and end caps.	Complete base assemblies include all base components necessary to support worksurfaces. Specify screens, power components and cable trays separately. Base assemblies include end legs, intermediate leg (where required), beams, trusses, cantilever brackets, top channel and end caps.
XT Crinion Open Table	1. Specify base finish for base assembly.	Base assemblies correspond to: 10': four 60"x30"D worksurfaces 12': four 72"x30"D worksurfaces 15': six 60"x30"D worksurfaces 18': six 72"x30"D worksurfaces 20': eight 60"x30"D worksurfaces 24': eight 72"x30"D worksurfaces 25': ten 60"x30"D worksurfaces
B1 Base components	For legs and cantilever brackets specify one paint finish for all.	No table on this page has beams longer than 15'.
BAS Assembly	2. Specify top channel finish.	
30 Depth	AA anodized aluminum and all paint finishes are available except 613 Silver.	
D Dual	Beams are anodized aluminum only.	
18 Width		
S Segmented		
A Adjustable height		
613 Base finish		
118 Top channel finish		

Complete base assemblies adjustable height 30" D single sided

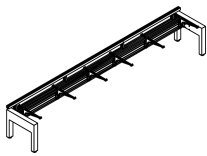
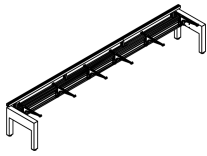
AutoStrada

description	nominal	w	d	h	pattern number	P1/P2	P3
 Base assembly, continuous	10' single sided	120"	28 ³ / ₄ "	28 ¹ / ₂ "	XTB1 BAS 30S10CA () ()	\$10,217.	\$10,502.
	12' single sided	144"	28 ³ / ₄ "	28 ¹ / ₂ "	XTB1 BAS 30S12CA () ()	10,685.	10,970.
	15' single sided	180"	28 ³ / ₄ "	28 ¹ / ₂ "	XTB1 BAS 30S15CA () ()	12,314.	12,626.
 Base assembly, segmented	10' +5' single sided	180"	28 ³ / ₄ "	28 ¹ / ₂ "	XTB1 BAS 30S15SA () ()	11,534.	11,846.
 Base assembly, with intermediate leg	12' + 6' single sided	216"	28 ³ / ₄ "	28 ¹ / ₂ "	XTB1 BAS 30S18SA () ()	12,757.	13,070.
	10' + 10' single sided	240"	28 ³ / ₄ "	28 ¹ / ₂ "	XTB1 BAS 30S20SA () ()	14,346.	14,686.
	12' + 12' single sided	288"	28 ³ / ₄ "	28 ¹ / ₂ "	XTB1 BAS 30S24SA () ()	17,239.	17,578.
	15' + 10' single sided	300"	28 ³ / ₄ "	28 ¹ / ₂ "	XTB1 BAS 30S25SA () ()	18,398.	18,763.

Order Code	Specifications	Application Notes
Example: XTB1BAS30S18SA 613 AA	Base assemblies include end legs, beams, trusses, cantilever brackets, channels and end caps.	Complete base assemblies include all base components necessary to support worksurfaces. Specify screens, power components and cable trays separately. Base assemblies include end legs, intermediate leg (where required), beams, trusses, cantilever brackets, top channel and end caps.
XT Crinion Open Table	1. Specify base finish for base assembly.	Base assemblies correspond to: 10': two 60"x30"D worksurfaces 12': two 72"x30"D worksurfaces 15': three 60"x30"D worksurfaces 18': three 72"x30"D worksurfaces 20': four 60"x30"D worksurfaces 24': four 72"x30"D worksurfaces 25': five 60"x30"D worksurfaces
B1 Base components	For legs and cantilever brackets specify one paint finish for all.	No table on this page has beams longer than 15'.
BAS Assembly	2. Specify top channel finish.	
30 Depth	AA anodized aluminum and all paint finishes are available except 613 Silver.	
S Single	Beams are anodized aluminum only.	
18 Width		
S Segmented		
A Adjustable height		
613 Base finish		
AA Top channel finish		

Complete base assemblies fixed height 36" D dual

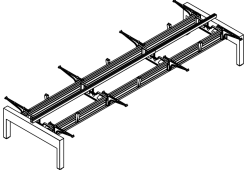
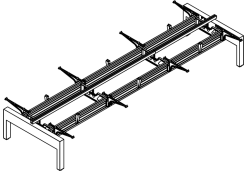
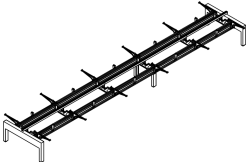
description	nominal	w	h	d	pattern number	P1/P2	P3
 Base assembly, continuous	10' dual	120"	28 1/2"	54"	XTB1 BAS 36D10CF () ()	\$11,636.	\$11,962.
	12' dual	144"	28 1/2"	54"	XTB1 BAS 36D12CF () ()	12,105.	12,430.
	15' dual	180"	28 1/2"	54"	XTB1 BAS 36D15CF () ()	14,116.	14,477.
 Base assembly, segmented	10' + 5' dual	180"	28 1/2"	54"	XTB1 BAS 36D15SF () ()	15,290.	15,651.
 Base assembly, with intermediate leg	12' + 6' dual	216"	28 1/2"	54"	XTB1 BAS 36D18SF () ()	16,919.	17,330.
	10' + 10' dual	240"	28 1/2"	54"	XTB1 BAS 36D20SF () ()	18,892.	19,338.
	12' + 12' dual	288"	28 1/2"	54"	XTB1 BAS 36D24CF () ()	19,828.	20,274.
	15' + 10' dual	300"	28 1/2"	54"	XTB1 BAS 36D25CF () ()	21,372.	21,851.

Order Code

Example:	XTB1BAS36D18SF 613 111
XT	Crinion Open Table
B1	Base components
BAS	Assembly
36	Depth
D	Dual
18	Width
S	Segmented
F	Fixed height
613	Base finish
111	Top channel finish

Specifications

Base assemblies include end legs, beams, trusses, cantilever brackets, channels and end caps.

Fixed height base assemblies have shared cantilever brackets for adjacent worksurfaces and midspan support brackets for every worksurface.

- Specify base finish for base assembly.
For legs and cantilever brackets specify one paint finish for all.
- Specify top channel finish.
AA anodized aluminum and all paint finishes are available except 613 Silver.
Beams are anodized aluminum only.

Application Notes

Complete base assemblies include all base components necessary to support worksurfaces. Specify screens, power components and cable trays separately. Base assemblies include end legs, intermediate leg (where required), beams, trusses, cantilever brackets, mid span support brackets, top channel and end caps.

No table on this page has beams longer than 15'.

Base assemblies correspond to:
 10': four 60"x36"D worksurfaces
 12': four 72"x36"D worksurfaces
 15': six 60"x36"D worksurfaces
 18': six 72"x36"D worksurfaces
 20': eight 60"x36"D worksurfaces
 24': eight 72"x36"D worksurfaces
 25': ten 60"x36"D worksurfaces

Complete base assemblies fixed height 36" D single sided

AutoStrada

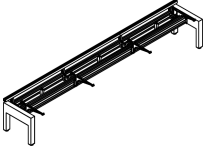
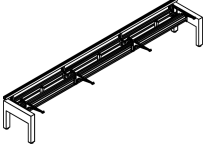
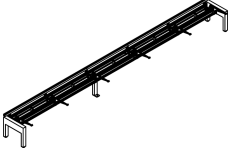
description	nominal	w	d	h	pattern number	P1/P2	P3
 Base assembly, continuous	10' single sided	120"	28 ³ / ₄ "	28 ¹ / ₂ "	XTB1 BAS 36S10CF () ()	\$10,261.	\$10,541.
	12' single sided	144"	28 ³ / ₄ "	28 ¹ / ₂ "	XTB1 BAS 36S12CF () ()	10,729.	11,009.
	15' single sided	180"	28 ³ / ₄ "	28 ¹ / ₂ "	XTB1 BAS 36S15CF () ()	12,239.	12,535.
 Base assembly, segmented	10' + 5' single sided	180"	28 ³ / ₄ "	28 ¹ / ₂ "	XTB1 BAS 36S15SF () ()	11,456.	11,754.
 Base assembly, with intermediate leg	12' + 6' single sided	216"	28 ³ / ₄ "	28 ¹ / ₂ "	XTB1 BAS 36S18SF () ()	12,681.	12,978.
	10' + 10' single sided	240"	28 ³ / ₄ "	28 ¹ / ₂ "	XTB1 BAS 36S20SF () ()	14,150.	14,463.
	12' + 12' single sided	288"	28 ³ / ₄ "	28 ¹ / ₂ "	XTB1 BAS 36S24SF () ()	17,042.	17,357.
	15' + 10' single sided	300"	28 ³ / ₄ "	28 ¹ / ₂ "	XTB1 BAS 36S25SF () ()	18,080.	18,413.

Order Code

Example:	XTB1BAS36S18SF 613 AA
XT	Crinion Open Table
B1	Base components
BAS	Assembly
36	Depth
S	Single
18	Width
S	Segmented
F	Fixed height
613	Base finish
AA	Top channel finish

Specifications

Base assemblies include end legs, beams, trusses, cantilever brackets, channels and end caps.

Fixed height base assemblies have shared cantilever brackets for adjacent worksurfaces and midspan support brackets for every worksurface.

- Specify base finish for base assembly.
For legs and cantilever brackets specify one paint finish for all.
- Specify top channel finish.
AA anodized aluminum and all paint finishes are available except 613 Silver.
Beams are anodized aluminum only.

Application Notes

Complete base assemblies include all base components necessary to support worksurfaces. Specify screens, power components and cable trays separately. Base assemblies include end legs, intermediate leg (where required), beams, trusses, cantilever brackets, mid span support brackets, top channel and end caps.

No table on this page has beams longer than 15'.

Base assemblies correspond to:
 10': two 60"x36"D worksurfaces
 12': two 72"x36"D worksurfaces
 15': three 60"x36"D worksurfaces
 18': three 72"x36"D worksurfaces
 20': four 60"x36"D worksurfaces
 24': four 72"x36"D worksurfaces
 25': five 60"x36"D worksurfaces

Complete base assemblies adjustable height 36" D dual

AutoStrada

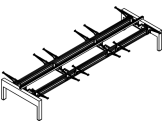
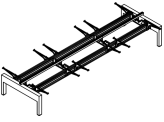
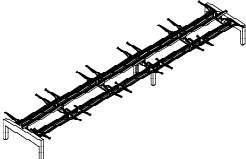

description	nominal	w	d	h	pattern number	P1/P2	P3
 Base assembly, continuous	10' dual	120"	54"	28 1/2"	XTB1 BAS 36D10CA () ()	\$11,806.	\$12,143.
	12' dual	144"	54"	28 1/2"	XTB1 BAS 36D12CA () ()	12,273.	12,614.
	15' dual	180"	54"	28 1/2"	XTB1 BAS 36D15CA () ()	14,608.	14,999.
 Base assembly, segmented	10' + 5' dual	180"	54"	28 1/2"	XTB1 BAS 36D15SA () ()	15,780.	16,170.
 Base assembly, with intermediate leg	12' + 6' dual	216"	54"	28 1/2"	XTB1 BAS 36D18SA () ()	17,409.	17,852.
	10' + 10' dual	240"	54"	28 1/2"	XTB1 BAS 36D20SA () ()	19,702.	20,197.
	12' + 12' dual	288"	54"	28 1/2"	XTB1 BAS 36D24CA () ()	20,640.	21,135.
	15' + 10' dual	300"	54"	28 1/2"	XTB1 BAS 36D25CA () ()	22,502.	23,052.

Crinion Open Table

Order Code	Specifications	Application Notes
Example: XTB1BAS36D18SA 613 115	Base assemblies include end legs, beams, trusses, cantilever brackets, channels and end caps.	Complete base assemblies include all base components necessary to support worksurfaces. Specify screens, power components and cable trays separately. Base assemblies include end legs, intermediate leg (where required), beams, trusses, cantilever brackets, top channel and end caps.
XT Crinion Open Table	1. Specify base finish for base assembly.	Base assemblies correspond to: 10': four 60"x36"D worksurfaces 12': four 72"x36"D worksurfaces 15': six 60"x36"D worksurfaces 18': six 72"x36"D worksurfaces 20': eight 60"x36"D worksurfaces 24': eight 72"x36"D worksurfaces 25': ten 60"x36"D worksurfaces
B1 Base components	For legs and cantilever brackets specify one paint finish for all.	No table on this page has beams longer than 15'.
BAS Assembly	2. Specify top channel finish.	
36 Depth	AA anodized aluminum and all paint finishes are available except 613 Silver.	
D Dual	Beams are anodized aluminum only.	
18 Width		
S Segmented		
A Adjustable height		
613 Base finish		
115 Top channel finish		

Complete base assemblies adjustable height 36" D single sided

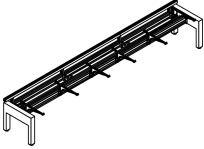
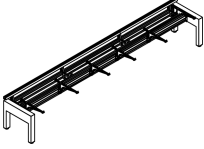
AutoStrada

description	nominal	w	d	h	pattern number	P1/P2	P3
 Base assembly, continuous	10' single sided	120"	28 ³ / ₄ "	28 ¹ / ₂ "	XTB1 BAS 36S10CA () ()	\$10,372.	\$10,660.
	12' single sided	144"	28 ³ / ₄ "	28 ¹ / ₂ "	XTB1 BAS 36S12CA () ()	10,842.	11,128.
	15' single sided	180"	28 ³ / ₄ "	28 ¹ / ₂ "	XTB1 BAS 36S15CA () ()	12,524.	12,836.
 Base assembly, segmented	10' + 5' single sided	180"	28 ³ / ₄ "	28 ¹ / ₂ "	XTB1 BAS 36S15SA () ()	11,741.	12,055.
 Base assembly, with intermediate leg	12' + 6' single sided	216"	28 ³ / ₄ "	28 ¹ / ₂ "	XTB1 BAS 36S18SA () ()	12,966.	13,279.
	10' + 10' single sided	240"	28 ³ / ₄ "	28 ¹ / ₂ "	XTB1 BAS 36S20SA () ()	14,608.	14,945.
	12' + 12' single sided	288"	28 ³ / ₄ "	28 ¹ / ₂ "	XTB1 BAS 36S24SA () ()	17,500.	17,838.
	15' + 10' single sided	300"	28 ³ / ₄ "	28 ¹ / ₂ "	XTB1 BAS 36S25SA () ()	18,713.	19,077.

Order Code	Specifications	Application Notes	
Example: XTB1BAS36S18SA 613 AA	Base assemblies include end legs, beams, trusses, cantilever brackets, channels and end caps. 1. Specify base finish for base assembly. For legs and cantilever brackets specify one paint finish for all. 2. Specify top channel finish. AA anodized aluminum and all paint finishes are available except 613 Silver. Beams are anodized aluminum only.	Complete base assemblies include all base components necessary to support worksurfaces. Specify screens, power components and cable trays separately. Base assemblies include end legs, intermediate leg (where required), beams, trusses, cantilever brackets, top channel and end caps. No table on this page has beams longer than 15'.	
XT Crinion Open Table			
B1 Base components			
BAS Assembly			
36 Depth			
S Single			
18 Width			
S Segmented			
A Adjustable height			
613 Base finish			
AA Top channel finish			
			Base assemblies correspond to: 10': two 60"x36"D worksurfaces 12': two 72"x36"D worksurfaces 15': three 60"x36"D worksurfaces 18': three 72"x36"D worksurfaces 20': four 60"x36"D worksurfaces 24': four 72"x36"D worksurfaces 25': five 60"x36"D worksurfaces

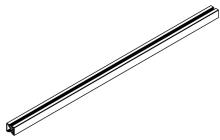
description	nominal	w	d	h	pattern number	list price
 <p>Top channel</p>	4'	48"	2 1/2"	2"	XTC1 48 ()	\$175.
	5'	60"	2 1/2"	2"	XTC1 60 ()	222.
	6'	72"	2 1/2"	2"	XTC1 72 ()	260.
	8'	96"	2 1/2"	2"	XTC1 96 ()	354.
	10'	120"	2 1/2"	2"	XTC1 120 AA	443.
	12'	144"	2 1/2"	2"	XTC1 144 AA	522.

Top channel end cap			2 1/2"	2"	XTC1 END ()	40.
---------------------	--	--	--------	----	---------------------	-----

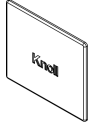

 <p>Top channel for frameless glass addups</p>	4'	48"	2 1/2"	2"	XTCA1 48 ()	260.
	5'	60"	2 1/2"	2"	XTCA1 60 ()	314.
	6'	72"	2 1/2"	2"	XTCA1 72 ()	370.
	8'	96"	2 1/2"	2"	XTCA1 96 ()	483.
	10'	120"	2 1/2"	2"	XTCA1 120 AA	587.
	12'	144"	2 1/2"	2"	XTCA1 144 AA	730.

 <p>Top channel filler</p>		48"			XTCF 48 ()	33.
		60"			XTCF 60 ()	45.
		72"			XTCF 72 ()	45.

Order Code

Example:	XTC1120AA
XT	Crinion open table
C1	Top channel
120	Width
AA	Finish

Specifications

Top channels are extruded aluminum with natural anodized finish AA or any standard painted finish except 613 Silver.

Top channel end caps are die cast aluminum AA or any standard painted finish except 613 Silver.

Top channel filler is 812 Easy Grey or 111 Black.

Application Notes

Crinion Open Table top channel supports privacy screens and suspended raceway components at any point. Top channel is required at the center of dual tables.

Top channels and end caps are included in complete base assemblies.

Top channels correspond in width to one or two worksurface widths.

Beams for single sided or dual tables 24" D

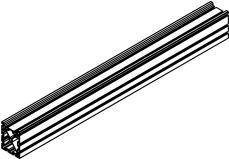
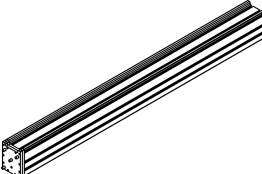
description	nominal	w	d	h	pattern number	list price
 Starter beam set for 24" D	5'	52"	3"	8"	XTB1TB5C	\$1,173.
	6'	64"	3"	8"	XTB1TB6C	1,302.
	8'	88"	3"	8"	XTB1TB8C	1,565.
	10'	112"	3"	8"	XTB1TB10C	1,891.
	12'	136"	3"	8"	XTB1TB12C	2,215.
	15'	172"	3"	8"	XTB1TB15C	2,735.
 Extension beam set for 24" D tables	4'	48"	3"	8"	XTB1TB4E	1,565.
	5'	60"	3"	8"	XTB1TB5E	1,693.
	6'	72"	3"	8"	XTB1TB6E	1,824.
	8'	96"	3"	8"	XTB1TB8E	2,084.
	10'	120"	3"	8"	XTB1TB10E	2,412.
	12'	144"	3"	8"	XTB1TB12E	2,735.
	15'	180"	3"	8"	XTB1TB15E	3,258.

Order Code

Example:	XTB1TB15C
XT	Crinion Open Table
B1	Base components
TB	Dual beam set
15	Width
C	Starter

Specifications

Beams are extruded aluminum with natural anodized finish.

Application Notes

Crinion Open Table bases are assembled from beams, end legs or end panels, intermediate legs and trusses.

Beam sets can be used with either dual or single sided tables. Table bases require one starter beam and extension beam adding up to the length as the sum of the worksurface widths on one side.

Extension beam sets are specified only to add on to starter sets or other extension beams.

Beam sets must be supported by intermediate legs at least every 16'. Intermediate leg must be positioned at beam truss location, where two worksurfaces meet.

Beams for dual tables

30" and 36" D

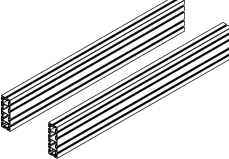
description	nominal	w		h	pattern number	list price
Starter beam set for dual table 30" or 36" (pair of beams) 	5'	52"	3"	8"	XTB1DB5C	\$1,565.
	6'	64"	3"	8"	XTB1DB6C	1,693.
	8'	88"	3"	8"	XTB1DB8C	2,215.
	10'	112"	3"	8"	XTB1DB10C	2,606.
	12'	136"	3"	8"	XTB1DB12C	2,996.
	15'	172"	3"	8"	XTB1DB15C	3,519.

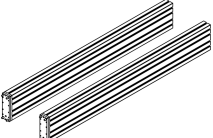
Extension beam set for dual table 30" or 36" (pair of beams) 	4'	48"	3"	8"	XTB1DB4E	2,084.
	5'	60"	3"	8"	XTB1DB5E	2,084.
	6'	72"	3"	8"	XTB1DB6E	2,215.
	8'	96"	3"	8"	XTB1DB8E	2,735.
	10'	120"	3"	8"	XTB1DB10E	3,127.
	12'	144"	3"	8"	XTB1DB12E	3,519.
	15'	180"	3"	8"	XTB1DB15E	4,040.

Order Code

Example: XTB1DB15C
XT Crinion Open Table
B1 Base components
DB Dual beam set
15 Width
C Starter

Specifications

Beams are extruded aluminum with natural anodized finish.

Beam sets are starter or extension.

Extension beam sets are specified only to add on to starter sets or other extension beams.

Application Notes

Crinion Open Table bases are assembled from beams, end legs or end panels, intermediate legs and trusses. Beam sets may be used with either worksurface depth. Dual tables require one pair of main beams of the same nominal width as the sum of the worksurfaces on each side.

Beam sets must be supported by intermediate legs at least every 16'. Intermediate leg must be positioned at beam truss location, where two worksurfaces meet.

Beams for single sided tables 30" and 36" D

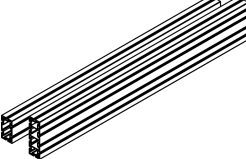
description	nominal	w	d	h	pattern number	list price
Starter beam set for single sided table 30" or 36" (main and back beam) 	5'	52"		8"	XTB1SB5C	\$1,369.
	6'	64"		8"	XTB1SB6C	1,433.
	8'	88"		8"	XTB1SB8C	1,891.
	10'	112"		8"	XTB1SB10C	2,215.
	12'	136"		8"	XTB1SB12C	2,606.
	15'	172"		8"	XTB1SB15C	2,996.

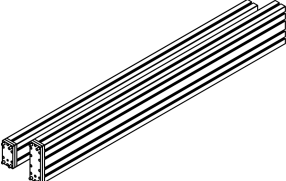
Extension beam set for single sided table 30" or 36" (main and back beam) 	4'	48"		8"	XTB1SB4E	1,824.
	5'	60"		8"	XTB1SB5E	1,891.
	6'	72"		8"	XTB1SB6E	1,955.
	8'	96"		8"	XTB1SB8E	2,412.
	10'	120"		8"	XTB1SB10E	2,735.
	12'	144"		8"	XTB1SB12E	3,127.
	15'	180"		8"	XTB1SB15E	3,519.

Order Code

Example: XTB1DB15C	
XT	Crinion Open Table
B1	Base components
DB	Dual beam set
15	Width
C	Starter

Specifications

Beams are extruded aluminum with natural anodized finish.

Beam sets are starter or extension.

Extension beam sets are specified only to add on to starter sets or other extension beams.

Application Notes

Crinion Open Table bases are assembled from beams, end legs or end panels, intermediate legs and trusses. Beam sets may be used with either worksurface depth. Single sided tables require one pair of main beams of the same nominal width as the sum of the worksurfaces on each side.

Beam sets must be supported by intermediate legs at least every 16'. Intermediate leg must be positioned at beam truss location, where two worksurfaces meet.

description	application	w	d	h	pattern number	P1/P2	P3
End leg for dual tables (pair of legs for 36" D worksurface)	24" D worksurface	4"	44"	24"	XTB1EDD24 ()	\$4,716.	\$4,952.
	30" D worksurface	4"	54"	24"	XTB1EDD30 ()	4,716.	4,952.
	36" D worksurface	4"	54"	24"	XTB1EDD36 ()	4,716.	4,952.

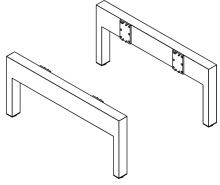

Intermediate leg for dual table (pair of legs for 30" and 36" D)	24" D worksurfaces	4"	2 3/4"	16"	XTB2LDD24 ()	566.	566.
	30" & 36" D worksurfaces	4"	2 3/4"	16"	XTB2LDD ()	622.	622.

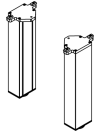

Shroud for intermediate leg infeed kit	24" D or single sided	3 3/4"	2 1/2"	15"	XTB1 SLIK ()	178.	186.
	30" D	11"	4"	15"	XTB1 SLIK30 ()	224.	235.
	36" D	23"	4"	15"	XTB1 SLIK36 ()	262.	278.

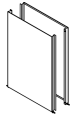

End leg for end counters both ends (pair of legs for 36" D worksurface)	48" W end counter	4"	44"	24"	XTB1XDD24 ()	5,042.	5,279.
	60" W end counter	4"	54"	24"	XTB1XDD30 ()	5,042.	5,279.
	72" W end counter	4"	54"	24"	XTB1XDD36 ()	5,042.	5,279.

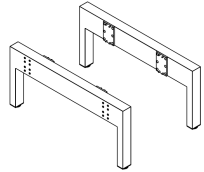

Order Code

Example:	XTB1EDD30 118
XT	Crinion Open Table
B1	Base components
E	End leg
D	Dual
D	Desk height
30	Depth of tops
118	Finish

Specifications

Specify paint finish code after pattern number.

Application Notes

Crinion Open Table bases are assembled from main beams, end legs or end panels, intermediate legs and trusses. After selecting starter or segmented beam sets, specify legs to support each end of beams. End legs support main beams at each end of a table.

Dual end legs for end counters have threaded metal inserts on the outside of the leg to accept two fixed height or adjustable cantilevers for end counters.

Intermediate legs must be specified to provide support under beam sets spanning longer than 16'.

Intermediate legs may be positioned under beams at any beam truss location. End legs include beam end plates and hardware.

Shroud for intermediate leg kit encloses the space between legs to protect power, data and communication cables between floor and table base. Side covers may be removed for access.

Shroud for 24" d intermediate leg is U-shaped cover that attaches to side of intermediate leg for 24" d or any single sided intermediate leg.

End legs for 24" D worksurfaces and end legs for 48" W end counters have only one end plate for attaching a single centered beam for 24" D tables.

End legs for 30" D and 36" D worksurfaces and end legs for 60" W and 72" W end counters have two end plates for attaching two beams for 30" D and 36" D tables.

description	application	w	d	h	pattern number	P1/P2	P3
End leg for end counters one end only (pair of legs for 36"D worksurface)	48" W end counter	4"	44"	24"	XTB1YDD24 ()	\$4,881.	\$5,115.
	60" W end counter	4"	54"	24"	XTB1YDD30 ()	4,881.	5,115.
	72" W end counter	4"	54"	24"	XTB1YDD36 ()	4,881.	5,115.

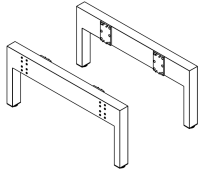

Order Code

Example:	XTB1EDD30 118
XT	Crinion Open Table
B1	Base components
E	End leg
D	Dual
D	Desk height
30	Depth of tops
118	Finish

Specifications

Specify paint finish code after pattern number.

Application Notes

Crinion Open Table bases are assembled from main beams, end legs or end panels, intermediate legs and trusses. After selecting starter or segmented beam sets, specify legs to support each end of beams. End legs support main beams at each end of a table.

Dual end legs for end counters have threaded metal inserts on the outside of the leg to accept two fixed height or adjustable cantilevers for end counters.

Intermediate legs must be specified to provide support under beam sets spanning longer than 16'.

Intermediate legs may be positioned under beams at any beam truss location. End legs include beam end plates and hardware.

Shroud for intermediate leg kit encloses the space between legs to protect power, data and communication cables between floor and table base. Side covers may be removed for access.

Shroud for 24"d intermediate leg is U-shaped cover that attaches to side of intermediate leg for 24"d or any single sided intermediate leg.

End legs for 24"D worksurfaces and end legs for 48"W end counters have only one end plate for attaching a single centered beam for 24"D tables.

End legs for 30"D and 36"D worksurfaces and end legs for 60"W and 72"W end counters have two end plates for attaching two beams for 30"D and 36"D tables.

description	application	width	depth	height	pattern number	P1/P2	P3
End leg for single sided tables (pair of legs)	24" D worksurface	4"	24"	24"	XTB1ESD24 ()	\$4,716.	\$4,952.
	30" D worksurface	4"	28 ³ / ₄ "	24"	XTB1ESD30 ()	4,716.	4,952.
	36" D worksurface	4"	28 ³ / ₄ "	24"	XTB1ESD36 ()	4,716.	4,952.

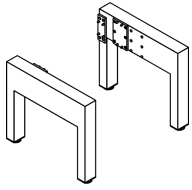

Intermediate leg for single sided table	24" D worksurfaces	4"	2 ³ / ₄ "	16"	XTB2LSD24 ()	509.	509.
	30" & 36" D worksurfaces	4"	2 ³ / ₄ "	16"	XTB2LSD ()	622.	622.



Order Code

Example:	XTB1ESD30 118
XT	Crinion Open Table
B1	Base components
E	End leg
S	Single
D	Desk height
30	Depth of tops
118	Finish

Specifications

Specify paint finish code after pattern number.

Application Notes

Crinion Open Table bases are assembled from main beams, end legs or end panels, intermediate legs and trusses. After selecting starter or segmented beam sets, specify legs to support each end of beams. End legs support main beams at each end of a table.

Dual end legs for end counters have threaded metal inserts on the outside of the leg to accept two fixed height or adjustable cantilevers for end counters.

Intermediate legs must be specified to provide support under beam sets spanning longer than 16'. Intermediate legs may be positioned under beams at any beam truss location. End legs include beam end plates and hardware.

Shroud for intermediate leg kit encloses the space between legs to protect power, data and communication cables between floor and table base. Side covers may be removed for access.

description	application	width	depth	height	pattern no.	P1/P2/P3
End panels for dual tables (pair of end panels)	24" D worksurface	1 1/4"	46"	25 1/2"	XTB1EP2DD24P () ()	\$2,489.
	30" D worksurface	1 1/4"	58"	25 1/2"	XTB1EP2DD30P () ()	3,506.
	36" D worksurface	1 1/4"	70"	25 1/2"	XTB1EP2DD36P () ()	3,733.

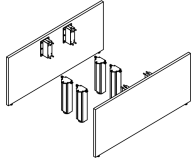

End panels for dual tables (single end panel)	24" D worksurface	1 1/4"	46"	25 1/2"	XTB1EP1DD24P () ()	1,245.
	30" D worksurface	1 1/4"	58"	25 1/2"	XTB1EP1DD30P () ()	1,753.
	36" D worksurface	1 1/4"	70"	25 1/2"	XTB1EP1DD36P () ()	1,866.

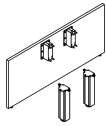

End panels for single sided tables (pair of end panels)	24" D worksurface	1 1/4"	25 3/16"	25 1/2"	XTB1EP2SD24P () ()	2,206.
	30" D worksurface	1 1/4"	30 3/16"	25 1/2"	XTB1EP2SD30P () ()	3,167.
	36" D worksurface	1 1/4"	36 3/16"	25 1/2"	XTB1EP2SD36P () ()	3,280.

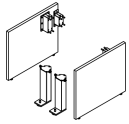

End panels for single sided tables (single end panel)	24" D worksurface, Left	1 1/4"	25 3/16"	25 1/2"	XTB1EP1LD24P () ()	1,102.
	24" D worksurface, Right	1 1/4"	25 3/16"	25 1/2"	XTB1EP1RD24P () ()	1,102.
	30" D worksurface, Left	1 1/4"	30 3/16"	25 1/2"	XTB1EP1LD30P () ()	1,583.
	30" D worksurface, Right	1 1/4"	30 3/16"	25 1/2"	XTB1EP1RD30P () ()	1,583.
	36" D worksurface, Left	1 1/4"	36 3/16"	25 1/2"	XTB1EP1LD36P () ()	1,640.
	36" D worksurface, Right	1 1/4"	36 3/16"	25 1/2"	XTB1EP1RD36P () ()	1,640.

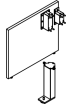

LH Shown
RH Opposite

Order Code	Specification	Application Notes
Example: XTB1EP2DD 24P118	Specify paint finish for brackets, then specify paint finish for end panel.	End panels may be specified as an alternative to End legs to support each end of beams.
XT	Crinion Open Table	
B1	Base components	End panel kits include end panel, connecting hardware and support legs.
EP2	End panel	
D	Dual	End panel kits are not compatible with end counters.
D	Desk Height	
24	Depth of tops	
P	Finish	
118	Finish	
118	Finish	

End panels for dual tables and single sided tables, laminate and veneer

description	application	w	d	h	pattern no.	L	V1	V2	V3
End panels for dual tables (pair of end panels)	24" D worksurface	1 1/4"	46"	25 1/2"	XTB1EP2DD24 () ()	\$2,602.	\$2,714.	\$3,280.	\$3,392.
	30" D worksurface	1 1/4"	58"	25 1/2"	XTB1EP2DD30 () ()	3,618.	3,846.	4,412.	4,637.
	36" D worksurface	1 1/4"	70"	25 1/2"	XTB1EP2DD36 () ()	3,846.	3,959.	4,637.	4,863.

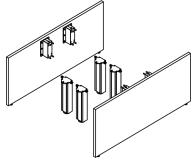

End panel for dual tables (single end panel)	24" D worksurface	1 1/4"	46"	25 1/2"	XTB1EP1DD24 () ()	1,300.	1,357.	1,640.	1,697.
	30" D worksurface	1 1/4"	58"	25 1/2"	XTB1EP1DD30 () ()	1,810.	1,923.	2,206.	2,318.
	36" D worksurface	1 1/4"	70"	25 1/2"	XTB1EP1DD36 () ()	1,923.	1,979.	2,318.	2,432.

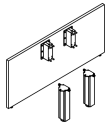

End panels for single sided tables (pair of end panels)	24" D worksurface	1 1/4"	25 3/16"	25 1/2"	XTB1EP2SD24 () ()	2,318.	2,489.	2,828.	2,940.
	30" D worksurface	1 1/4"	30 3/16"	25 1/2"	XTB1EP2SD30 () ()	3,280.	3,506.	3,846.	4,072.
	36" D worksurface	1 1/4"	36 3/16"	25 1/2"	XTB1EP2SD36 () ()	3,392.	3,618.	4,072.	4,297.

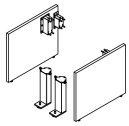

End panel for single sided tables (single end panel)	24" D worksurface, Left	1 1/4"	25 3/16"	25 1/2"	XTB1EP1LD24 () ()	1,160.	1,245.	1,413.	1,471.
	24" D worksurface, Right	1 1/4"	25 3/16"	25 1/2"	XTB1EP1RD24 () ()	1,160.	1,245.	1,413.	1,471.
	30" D worksurface, Left	1 1/4"	30 3/16"	25 1/2"	XTB1EP1LD30 () ()	1,640.	1,753.	1,923.	2,035.
	30" D worksurface, Right	1 1/4"	30 3/16"	25 1/2"	XTB1EP1RD30 () ()	1,640.	1,753.	1,923.	2,035.
	36" D worksurface, Left	1 1/4"	36 3/16"	25 1/2"	XTB1EP1LD36 () ()	1,697.	1,810.	2,035.	2,149.
	36" D worksurface, Right	1 1/4"	36 3/16"	25 1/2"	XTB1EP1RD36 () ()	1,697.	1,810.	2,035.	2,149.

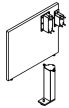

LH Shown
RH Opposite

Order Code	Specifications	Application Notes
Example: XTB1EP2DD 24118 118		
XT Crinion Open Table	Specify paint finish for brackets, then specify laminate or veneer finish for end panel.	End panels may be specified as an alternative to End legs to support each end of beams.
B1 Base components		
EP2 End panel	Brushed and woodgrain laminates are not available on 70" wide end panels for use on 36"D dual sided tables.	End panel kits include end panel, connecting hardware and support legs.
D Dual		
D Desk Height		
24 Depth of tops		End panel kits are not compatible with end counters.
118 Finish		
118 Finish		

description	application	w	d	h	pattern number	P1/P2/P3
Beam truss for dual tables	30" D worksurface	3"	11"	10"	XTB1XD30 ()	\$575.
	36" D worksurface	3"	23"	10"	XTB1XD36 ()	626.

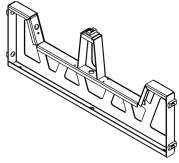

Top channel support	24" D worksurface				XTB1T24 ()	208.
---------------------	-------------------	--	--	--	--------------------	------



Beam truss for single sided tables	30" D worksurface	3"			XTB1XS30 ()	575.
	36" D worksurface	3"			XTB1XS36 ()	626.

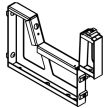

Beam truss for dual tables no top channel support	30" D worksurface	3"	11"	8"	XTB1XD30N ()	444.
	36" D worksurface	3"	23"	8"	XTB1XD36N ()	510.

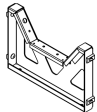

Beam truss for single sided tables no top channel support	30" D worksurface	3"			XTB1XS30N ()	444.
	36" D worksurface	3"			XTB1XS36N ()	510.

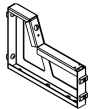

Order Code

Example: XTB1XD30 613	
XT	Crinion Open Table
B1	Base components
XD	Beam truss for dual table
30	Depth
613	Finish

Specifications

Beam trusses are available in all standard painted finishes.

Application Notes



Crinion Open Table bases are assembled from beams, end legs or end panels, intermediate legs and trusses. After selecting beams and leg kits, specify trusses between beams.

Specify beam trusses adjacent to each end leg and at each worksurface junction.

For 24"D tables specify top channel support instead of truss.

Beam trusses with no top channel support must be specified in combination with intermediate legs planned other than at worksurface junctions (as for cable infeed shrouds).

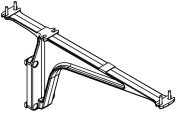
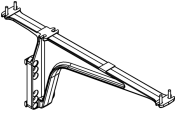
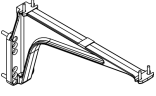
Worksurface support cantilever and mid span support

description	w	d	h	pattern number	P1/P2	P3
Cantilever, fixed height 30" or 36" D 	3"	24"	9"	XTB1FC ()	\$236.	\$246.
Cantilever, fixed height 24" D 	3"	19"	9"	XTB1FC24 ()	236.	246.
Cantilever, adjustable height 30" or 36" D 	3"	24"	9" - 12"	XTB1AC ()	260.	275.
Cantilever, adjustable height 24" D 	3"	24"	9" - 12"	XTB1AC24 ()	260.	275.
Mid span support 	2	2	8	XTB1MB ()	111.	118.

Crinion Open Table

Order Code	Specifications	Application Notes
Example: XTB1FC 118		
XT Crinion Open Table	Specify paint finish code after pattern number.	Cantilever brackets are required to support each end of worksurfaces.
B1 Base components	48"worksurfaces: shared cantilevers each end or two adjustable per worksurface.	Brackets can be positioned at ends of worksurface, or inset at legs or floorstanding pedestal locations.
FC Fixed height cantilever	60" and 72" worksurfaces: shared cantilevers each end plus mid span support or two adjustable cantilevers inset 8".	Fixed height cantilevers can be shared between adjacent worksurfaces. Mid span support bracket must be specified for worksurface spans exceeding 4'.
118 Finish	96"worksurfaces: shared cantilevers at ends plus one in center or three adjustable cantilevers.	Fixed height cantilever supports worksurface at 28 1/2" H.
		Adjustable cantilevers enable worksurfaces to be set at 27", 27 3/4", 28 1/2", 29 1/4" or 30" H.

Worksurface support

linking plate and cantilever for end counters

AutoStrada

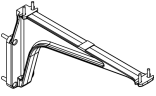
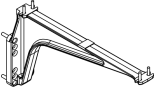
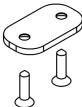
description	w	d	h	pattern no.	P1/P2	P3
Cantilever for end counters, fixed height	3"	19"	9"	XTB1FCEND ()	\$236.	\$246.
						
Cantilever for end counters, adjustable height	3"	19"	9" - 12"	XTB1ACEND ()	260.	275.
						
Worksurface linking plate				XTB1LP		32.
						

Order Code	Specification	Application Notes
Example: XTB1FCEND 613	Specify paint finish code after pattern number.	Cantilever brackets are required to support each end of worksurface.
XT Crinion Open Table		
B1 Base components		
FC Fixed height cantilever		
END for end counter		
613 Finish		
		Brackets attach to inserts on the outside face of end legs for end counters.
		Fixed height cantilever supports for end counter at 28 1/2" H.
		Adjustable cantilevers for end counter enables end counter to be set at 28 1/2", 29 1/4" or 30" H.
		A linking plate is recommended to join adjacent worksurfaces that are independently supported at the same height. Specify two linking plates at the junction of two worksurfaces, or four total for each end counter to two worksurfaces. A linking plate is not required where adjacent tops are supported by a shared fixed height cantilever bracket, as with complete fixed height base assemblies. Linking plates are recommended for complete adjustable height base assemblies in which tops are set at the same height.

Modular Raceway

2 + 2 eight-wire Raceway with covers

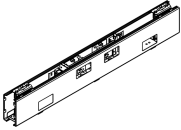
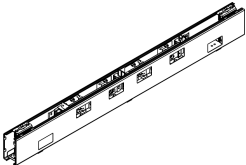
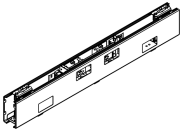
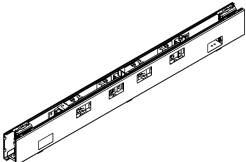
description	type	h	w	d	pattern number	list price
Dual raceway, two power + two data outlets each side 		4"	30"	2"	XTR1E30D ()	\$309.
Dual raceway, four power + two data outlets each side 		4"	42"	2"	XTR1E424D ()	443.
Flat end cover					XTR1FE ()	27.
Extended end cover					XTR1EE ()	27.
Single sided raceway two power + two data outlets one side 		4"	30"	2"	XTR1E30S ()	309.
Single sided raceway four power + two data outlets one side 		4"	42"	2"	XTR1E424S ()	443.

Order Code

Example:	XTR1E424D 613
XT	Crinion Open Table
R1	Raceway
E	Eight wire system
42	Width
4	Extra outlets
D	Dual Raceway
613	Finish

Specifications

Eight wire 2+2 has two sets of circuits, each set with a separate ground and neutral.

Specify paint finish code after pattern number.

Covers have two openings for data/com outlet modules (Decora-size, specified separately).

Applications notes

Raceway for Crinion Open Table is suspended from the top channel. For ideal access, worksurfaces should be specified with hinged power access.

Each raceway requires four or eight duplex outlets, on any of four circuits.

Jumpers connect power from one raceway to another.

To join power between 30" raceways: specify 30" jumper for 60" desks and specify 42" jumper for 72" desks.

To join power between 42" raceways: specify 18" jumper for 60" desks and 30" jumper for 72" desks.

Flat end covers enclose the end of a raceway at the end of a table.



Extended end covers enclose the end of a raceway at the end of a table where power infeed is located.

Specify outlet fillers separately for unused outlet openings.

Modular Raceway

2 + 2 eight-wire Raceway components

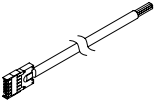
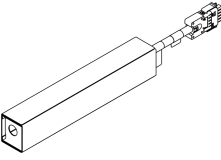
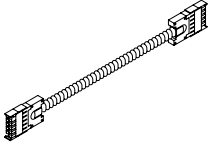
AutoStrada

description	type	h	w	d	pattern number	list price
Modular infeed					XTR1EPI	\$233.
						
NYC infeed kit					XTR1EPH	532.
						
Jumper			18"		XTR1EJ18	107.
			30"		XTR1EJ30	122.
			42"		XTR1EJ42	140.
Duplex outlet	Circuit A				XTR1DA	40.
	Circuit B				XTR1DB	40.
	Circuit X, orange				XTR1DXO	45.
	Circuit Y, orange				XTR1DYO	45.
Outlet filler	Set of 10				XTR1OF	33.
PDC module extension kit	Set of 10				XTR1PDCX	136.
Compact Power Module					XTR1ECPM ()	575.
						

Order Code	Specifications	Application Notes
Example: XTR1EJ18		
XT Crinion Open Table	Eight wire 2+2 has two sets of circuits, each set with a separate ground and neutral.	Raceway for Crinion Open Table is suspended from the top channel. For ideal access, worksurfaces should be specified with hinged power access.
R1 Raceway		
E Eight wire		
J Jumper		
18 Width		Each raceway requires four or eight duplex outlets, on any of four circuits.
		Power infeed includes pigtail for connection to building power supply and connector to either end of any raceway.
		NYC infeed kit includes junction box that mounts to inside face of beams in table base.
		Jumper length is difference between worksurface width and specified raceway width.
		Compact power module is designed to supply power outlets under extended end counter worksurfaces, or additional outlets under desks.
		Compact power module can be suspended from top channel or attached to inside face of beams.
		Each face of compact power module accepts two duplex outlets.

Modular Raceway

3 + 3 ten-wire Raceway with covers

AutoStrada

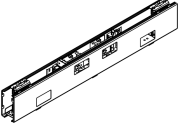
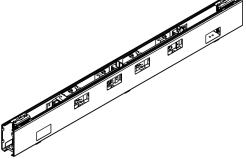
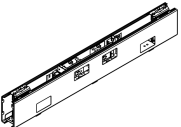
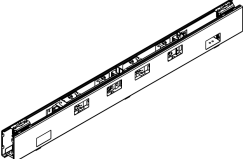
description	type	h	w	d	pattern number	list price
Dual raceway, two power + two data outlets each side 		4"	30"	2"	XTR1T30D ()	\$323.
Dual raceway, four power + two data outlets each side 		4"	42"	2"	XTR1T424D ()	458.
Flat end cover					XTR1FE ()	27.
Extended end cover					XTR1EE ()	27.
Single sided raceway two power + two data outlets one side 		4"	30"	2"	XTR1T30S ()	323.
Single sided raceway four power + two data outlets one side 		4"	42"	2"	XTR1T424S ()	458.

Order Code

Example: XTR1T424D 613	
XT	Crinion Open Table
R1	Raceway
T	Ten wire system
42	Width
4	Extra outlets
D	Dual Raceway
613	Finish

Specifications

Ten wire 3+3 has two sets of three circuits, each set with a separate ground and neutral.

Specify paint finish code after pattern number.

Covers have two openings for data/com outlet modules (Decora-size, specified separately).

Application Notes

Raceway for Crinion Open Table is suspended from the top channel. For ideal access, worksurfaces should be specified with hinged power access.

Each raceway requires four or eight duplex outlets, on any of six circuits.

Jumpers connect power from one raceway to another.

To join power between 30" raceways: specify 30" jumper for 60" desks and specify 42" jumper for 72" desks.

To join power between 42" raceways: specify 18" jumper for 60" desks and 30" jumper for 72" desks.

Flat end covers enclose the end of a raceway at the end of a table.



Extended end covers enclose the end of a raceway at the end of a table where power infeed is located.

Specify outlet fillers separately for unused outlet openings.

Modular Raceway

3 + 3 ten-wire Raceway components

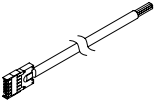
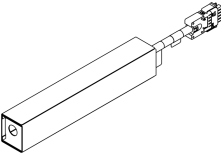
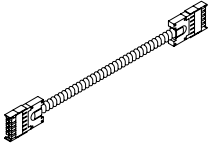
AutoStrada

description	type	h	w	d	pattern number	list pricing
Modular infeed					XTR1TPI	\$261.
						
NYC infeed kit					XTR1TPH	532.
						
Jumper			18"		XTR1TJ18	122.
			30"		XTR1TJ30	140.
			42"		XTR1TJ42	162.
Duplex outlet	Circuit A				XTR1DA	40.
	Circuit B				XTR1DB	40.
	Circuit C				XTR1DC	40.
	Circuit X, orange				XTR1DXO	45.
	Circuit Y, orange				XTR1DYO	45.
	Circuit Z, orange				XTR1DZO	45.
Outlet filler	Set of 10				XTR1OF	33.
PDC module extension kit	Set of 10				XTR1PDCX	136.
Compact Power Module					XTR1TCPM ()	592.
						

Order Code	Specifications	Application Notes
Example: XTR1TJ18	Ten wire 3+3 has two sets of three circuits, each set with a separate ground and neutral.	Raceway for Crinion Open Table is suspended from the top channel. For ideal access, worksurfaces should be specified with hinged power access.
XT Crinion Open Table		
R1 Raceway		
T Ten wire		
J Jumper		
18 Width	Each raceway requires four or eight duplex outlets, on any of six circuits.	Jumper length is difference between worksurface width and specified raceway width.
	Power infeed includes pigtail for connection to building power supply and connector to either end of any raceway.	Compact power module is designed to supply power outlets under extended end counter worksurfaces, or additional outlets under desks.
	NYC infeed kit includes junction box that mounts to inside face of beams in table base.	Compact power module can be suspended from top channel or attached to inside face of beams.
		Each face of compact power module accepts two duplex outlets.

Modular Raceway

4-4-2 ten-wire Raceway with covers

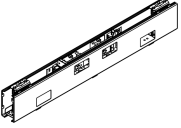
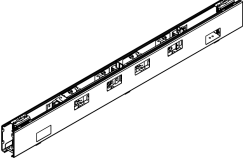
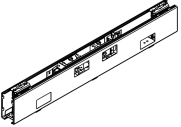
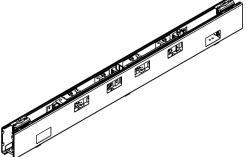
description	type	h	w	d	pattern number	list price
Dual raceway, two power + two data outlets each side 		4"	30"	2"	XTR1X30D ()	\$341.
Dual raceway, four power + two data outlets each side 		4"	42"	2"	XTR1X424D ()	480.
Single sided raceway two power + two data outlets one side 		4"	30"	2"	XTR1X30S ()	341.
Single sided raceway four power + two data outlets one side 		4"	42"	2"	XTR1X424S ()	480.

Order Code

Example: XTR1X424D 613
XT Crinion Open Table
R1 Raceway
X Ten wire 4-4-2
42 Width
4 Extra outlets
D Dual Raceway
613 Finish

Specifications

Ten wire 4-4-2 has four circuits each with a separate neutral, plus a ground wire for circuit 1 and 2 and another ground for circuit 3 and 4.

Specify paint finish code after pattern number.

Covers have two openings for data/com outlet modules (Decora-size, specified separately).

Application Notes

Raceway for Crinion Open Table is suspended from the top channel. For ideal access, worksurfaces should be specified with hinged power access.

Each raceway requires four or eight duplex outlets, on any of six circuits.

Jumpers connect power from one raceway to another.

To join power between 30" raceways: specify 30" jumper for 60" desks and specify 42" jumper for 72" desks.

To join power between 42" raceways: specify 18" jumper for 60" desks and 30" jumper for 72" desks.

Flat end covers enclose the end of a raceway at the end of a table.



Extended end covers enclose the end of a raceway at the end of a table where power infeed is located.

Specify outlet fillers separately for unused outlet openings.

Modular Raceway

4-4-2 ten-wire Raceway components

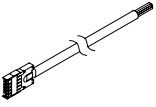
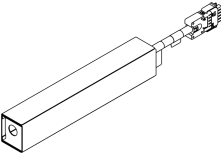
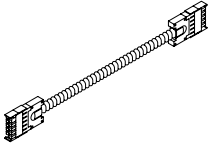
AutoStrada

description	type	h	w	d	pattern number	list price
Modular infeed					XTR1XPI	\$275.
						
NYC infeed kit					XTR1XPH	558.
						
Jumper			18"		XTR1XJ18	128.
			30"		XTR1XJ30	147.
			42"		XTR1XJ42	168.
Duplex outlet	Circuit 1				XTR1D1	42.
	Circuit 2				XTR1D2	42.
	Circuit 3				XTR1D3	42.
	Circuit 4				XTR1D4	42.
Compact Power Module					XTR1XCPM ()	592.
						

Order Code

Example:	XTR1XJ18
XT	Crinion Open Table
R1	Raceway
X	Ten wire 4-4-2
J	Jumper
18	Width

Specifications

Ten wire 4-4-2 has four circuits each with a separate neutral, plus a ground wire for circuit 1 and 2 and another ground for circuit 3 and 4.

All duplex outlets are black.

Application Notes

Raceway for Crinion Open Table is suspended from the top channel. For ideal access, worksurfaces should be specified with hinged power access.

Each raceway requires four or eight duplex outlets, on any of six circuits.

Power infeed includes pigtail for connection to building power supply and connector to either end of any raceway.

NYC infeed kit includes junction box that mounts to inside face of beams in table base.

Jumper length is difference between worksurface width and specified raceway width.

Compact power module is designed to supply power outlets under extended end counter worksurfaces, or additional outlets under desks.

Compact power module can be suspended from top channel or attached to inside face of beams.

Each face of compact power module accepts two duplex outlets.

description	type	h	w	d	pattern number	list price
Dual raceway, two power + two data outlets each side		4"	30"	2"	XTR1H30D ()	\$673.
Flat end cover					XTR1FE ()	27.
Extended end cover					XTR1EE ()	27.
Outlet filler	Set of 10				XTR1OF	33.

Order Code	Specifications	Application Notes
Example: XTR1H30D 613		
XT Crinion Open Table	Specify paint finish code after pattern number.	Raceway for Crinion Open Table is suspended from the top channel. For ideal access, worksurfaces should be specified with hinged power access.
R1 Raceway		
H Hard wire system	Hardwired raceway components are designed for use in City of Chicago installations.	
30 Width		
D Dual Raceway		
613 Finish	Covers have two openings for data/com outlet modules (Decora-size, by others).	Dual raceways are code-approved boxed with openings for two or four duplex outlets on each face, plus two additional openings for data/communications faceplates on each face. A continuous horizontal metal septum divides power wires and connections from data and communications cables. Each raceway requires Decora-type architectural power outlets, internal wiring and connecting cables, supplied by electrical contractor.
		Flat end covers enclose the raceway at the end of a table. Extended end covers provide an opening on the underside to permit cables to enter the raceway.
		Specify outlet filler plates for unused outlet openings. Specify PDC extenders to create space behind data/com for cable distribution inside dual raceway.

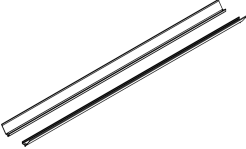
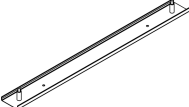
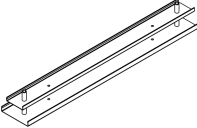
description	table size	w	d	pattern number	list price
Cable trays, leg position, pair 	5', 30"D	53"	1"	XTCT6030LD ()	\$280.
	5', 36"D	53"	4"	XTCT6036LD ()	381.
	6', 30"D	65"	1"	XTCT7230LD ()	303.
	6', 36"D	65"	4"	XTCT7236LD ()	442.
Cable trays, full width, pair 	5', 30"D	60"	1"	XTCT6030D ()	280.
	5', 36"D	60"	4"	XTCT6036D ()	381.
	6', 30"D	72"	1"	XTCT7230D ()	303.
	6', 36"D	72"	4"	XTCT7236D ()	442.
Data tray kit 		42"		XTDT42 ()	196.
Data + excess cable tray kit 		42"		XTDTX42 ()	326.
Truss cable clips, set of 25				XTR1TCC25	16.
Beam cable clips, set of 50				XTR1BCC50	260.
Random attachment kit, set of 10				XTB1RAK	90.

Order Code	Specifications	Applications notes
Example: XTCT7230D 613 XT Crinion Open Table CT Cable tray 72 Width 30 Depth D Dual table 613 Finish	Cable trays and Data tray kits are available in all standard paint finishes.	Cable trays are optional kits to manage cables on each side of dual table bases. Specify cable trays for leg position at each end of the table. Specify cable trays, full width for other positions. Data tray kit provides 3" wide horizontal open cable tray directly below either 30" or 42" W raceway module (at center of 60" or 72" desks). Data + excess tray kit provides two open trays below either raceway module, one 3" W and one 5" W.
		Truss cable clips manage cables between raceway. Specify 2 clips per truss (one set of 10 for each five trusses). Beam cable clips manage cables along the inside faces of each beam set. Random attachment kit is a set of ten M8 slot nuts for attaching various products to the Crinion Open Table beams or top channel. Specify appropriate M8 screws separately.

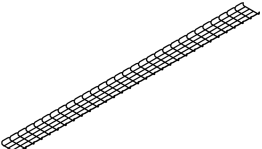
description	application	w	d	h	pattern no.	list
	24"D tables	18"	2"	3/4"	XTBT18 ()	\$88.
	24"D tables	24"	2"	3/4"	XTBT24 ()	100.
	24"D tables	36"	2"	3/4"	XTBT36 ()	108.
	24"D tables	48"	2"	3/4"	XTBT48 ()	119.
	24"D tables	60"	2"	3/4"	XTBT60 ()	128.
Cable basket, 10'		120"	8"	1"	XTWB120	485.
	From truss 30/36D only				XTWTX ()	77.
	From truss at infeed shroud				XTWTBSLIK ()	236.
	From main beam, 24D only				XTWTB ()	77.
	From top channel, 30/36D only				XTWTC ()	101.

Order Code

Example: XTBT36 118
XT Crinion Open Table
BT Beam mounted cable tray
36 Width
118 Paint finish

Specifications

Beam mounted cable trays are available in any standard painted finish.

Cable basket is zinc metal finish only.

Basket hangers can be specified in any standard painted finish.

Application Notes

Beam mounted cable trays may be inserted in slots on either face of Crinion Open Table main beams. On 24"D dual or single sided tables beam mounted cable trays are the only option for cable management other than the shallow channel on top of the beam or a cable basket. On 30"D and 36"D tables beam mounted trays may complement other cable tray options.

Beam mounted cable trays must be segmented to fit between cantilever and midspan support brackets.

For 48"W worksurfaces with shared cantilevers specify 36"W trays. For 60"W worksurfaces with shared cantilevers and midspan supports specify 24"W trays adjacent to end legs specify 18"W trays.

For 72"W worksurfaces with shared cantilevers and midspan supports specify 24"W trays.

For 96"W worksurfaces specify 36"W trays between supports. Specify 48"W trays for additional cable management between trusses on the inside face of beams on dual 30"D and 36"D tables with 60" worksurfaces. Specify 60"W trays on the inside face of beams on dual 30"D and 36"D tables with 72"W worksurfaces.

Cable basket is suspended below the center of dual tables instead of or in addition to cable trays. Cable basket offers the most flexibility for managing large bundles of cables and for entering or exiting the tray at any point. Cable basket ships in 10' lengths and is cut to size in field. Specify cable basket hangers separately. Each hanger can suspend one end of a tray or two adjacent trays. Hanger from trusses is for 30" or 36"D dual or single sided tables. Hanger from main beam is for 24"D dual tables only. Hangers from top channel are for 30" or 36"D dual tables only.

Center screens

Acrylic, slatwall, combination, marker or veneer surface

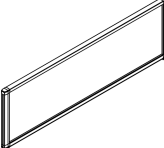
description	appl.	w	d	h	pattern no.	Opal acrylic	Trans. acrylic / Marker	slatwall	Comb. acrylic / slatwall	V1	V2	V3
Center screen to 43" H 	48"	48"	1 1/4"	14"	XTCS1 4814 () () ()	\$944.	\$977.	\$1,500.	n/a	\$1,302.	\$1,428.	\$1,671.
	60"	60"	1 1/4"	14"	XTCS1 6014 () () ()	1,239.	1,299.	1,629.	n/a	1,408.	1,555.	1,864.
	72"	72"	1 1/4"	14"	XTCS1 7214 () () ()	1,302.	1,364.	1,760.	n/a	1,480.	1,649.	2,019.

acrylic shown

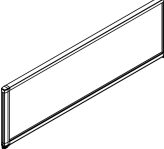
Center screen to 43" H adjacent to end screen 	48"	47"	1 1/4"	14"	XTCS1 4714 () () ()	944.	977.	1,500.	n/a	1,302.	1,428.	1,671.
	60"	59"	1 1/4"	14"	XTCS1 5914 () () ()	1,239.	1,299.	1,629.	n/a	1,408.	1,555.	1,864.
	72"	71"	1 1/4"	14"	XTCS1 7114 () () ()	1,302.	1,364.	1,760.	n/a	1,480.	1,649.	2,019.

acrylic shown

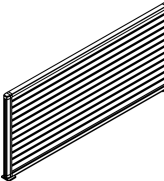
Center screen to 50" H 	48"	48"	1 1/4"	21"	XTCS1 4821 () () ()	1,107.	1,156.	1,760.	1,629.	1,429.	1,591.	1,943.
	60"	60"	1 1/4"	21"	XTCS1 6021 () () ()	1,433.	1,526.	1,955.	1,891.	1,537.	1,734.	2,174.
	72"	72"	1 1/4"	21"	XTCS1 7221 () () ()	1,500.	1,590.	2,152.	2,021.	1,592.	1,821.	2,354.

slatwall shown

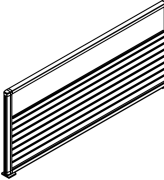
Center screen to 50" H adjacent to end screen 	48"	47"	1 1/4"	21"	XTCS1 4721 () () ()	1,107.	1,156.	1,760.	1,629.	1,429.	1,591.	1,943.
	60"	59"	1 1/4"	21"	XTCS1 5921 () () ()	1,433.	1,526.	1,955.	1,891.	1,537.	1,734.	2,174.
	72"	71"	1 1/4"	21"	XTCS1 7121 () () ()	1,500.	1,590.	2,152.	2,021.	1,592.	1,821.	2,354.

combination shown

Order Code	Specifications	Application Notes
Example: XTCS16014A O 111		
XT Crinion Open Table	Acrylic surface is AO opal or AT translucent.	Center screens mount to continuous channel at center of tables. Specify 14" H screens for a 42" horizon.
CS1 Center screen	For Marker surface both sides specify suffix M.	Specify 21" H screens for a 49" horizon. Horizons are maintained regardless of worksurface height.
60 Width	For Slatwall screens specify slatwall and frame finish.	Combination screens include 14" high slatwall with acrylic above.
14 Height	For combination acrylic/slatwall screens specify suffixes CO (opal) or CT (translucent), slatwall and frame finish.	Center screens include mounting hardware for standard top channel only.
A Surface	Slatwall surface is available in (AA) or any standard painted finish except 613 Silver.	Center screens adjacent to end screens allow space for dual or single sided end screens.
O Opal	For veneer surface specify suffix V and finish code from list on Crinion Open Table.	Slatwall screens require buttresses to support Knoll Extra flat screen monitor arm. Specify one buttress per monitor arm, up to four buttresses per screen.
111 Frame finish	Frame is clear anodized aluminum or any standard paint finish except 613 Silver.	Slatwall screens will support flat panel monitor arms with varying weight limitations based on mounting and application. Please refer to the KnollExtra price list for comprehensive mounting and weight limitation information by application.
		Veneer grain direction is horizontal.
		Marker surface has wood core.

Center screens

Tackable fabric surface

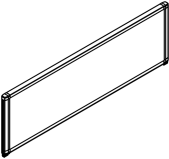

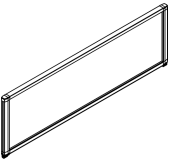

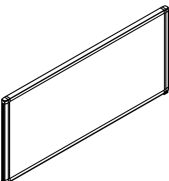
description	application	w	d	h	pattern no.	10	15	20	30	35	40	45
	Center screen to 43" H	48"	48"	1 1/4"	14"	XTCS1 4814F () ()	\$997.	\$1,016.	\$1,021.	\$1,042.	\$1,059.	\$1,095.
		60"	60"	1 1/4"	14"	XTCS1 6014F () ()	1,090.	1,113.	1,117.	1,143.	1,165.	1,210.
		72"	72"	1 1/4"	14"	XTCS1 7214F () ()	1,115.	1,144.	1,148.	1,181.	1,207.	1,259.

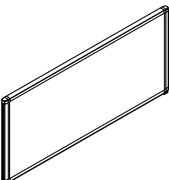
	Center screen to 43" H adjacent to end screen	48"	47"	1 1/4"	14"	XTCS1 4714F () ()	988.	1,007.	1,010.	1,031.	1,048.	1,084.
		60"	59"	1 1/4"	14"	XTCS1 5914F () ()	1,090.	1,113.	1,117.	1,143.	1,165.	1,210.
		72"	71"	1 1/4"	14"	XTCS1 7114F () ()	1,115.	1,144.	1,148.	1,181.	1,207.	1,259.

	Center screen to 50" H	48"	48"	1 1/4"	21"	XTCS1 4821F () ()	1,058.	1,076.	1,080.	1,100.	1,117.	1,151.
		60"	60"	1 1/4"	21"	XTCS1 6021F () ()	1,179.	1,206.	1,210.	1,234.	1,255.	1,300.
		72"	72"	1 1/4"	21"	XTCS1 7221F () ()	1,191.	1,221.	1,226.	1,258.	1,284.	1,336.

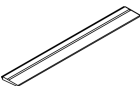
	Center screen to 50" H adjacent to end screen	48"	47"	1 1/4"	21"	XTCS1 4721F () ()	1,058.	1,076.	1,080.	1,100.	1,117.	1,151.
		60"	59"	1 1/4"	21"	XTCS1 5921F () ()	1,179.	1,206.	1,210.	1,234.	1,255.	1,300.
		72"	71"	1 1/4"	21"	XTCS1 7121F () ()	1,191.	1,221.	1,226.	1,258.	1,284.	1,336.

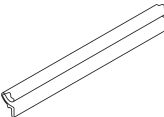
Order Code	Specifications	Application Notes
Example: XTCS16014F20 (W2801) AA		
XT Crinion Open Table	1. Tackable fabric surface is suffix F.	Fabric center screens mount to continuous channel at center of tables. Specify 14" H screens for a 43" horizon. Specify 21" H screens for a 50" horizon. Horizons are maintained regardless of worksurface height.
CS1 Center screen	2. Select fabric surface finish code from list on page Crinion Open Table.	
60 Width		Center screens adjacent to end screens allow space for dual or single sided end screens.
14 Height		
F Surface	Frame is clear anodized aluminum or any standard paint finish except 613 Silver.	Center screens include mounting hardware for standard top channel only.
20 Fabric grade		
W2801 Fabric		
AA Frame finish	Fabric is railroaded.	

description	application	w	d	h	pattern no.	list	AA/paint	L	V1	V2	V3
Display shelf 5"D aluminum only 	48" slatwall	45"	5"	1"	XT1DS4505 ()		\$289.				
	60" slatwall	57"	5"	1"	XT1DS5705 ()		324.				
	72" slatwall	69"	5"	1"	XT1DS6905 ()		352.				
Open shelf 9"D laminate or veneer only 	48" slatwall	45"	9"	1"	XT1LS4509 ()()			324.	424.	487.	657.
	60" slatwall	57"	9"	1"	XT1LS5709 ()()			372.	486.	557.	755.
	72" slatwall	69"	9"	1"	XT1LS6909 ()()			422.	548.	630.	851.
Slatwall adapters for applied wall accessories 		24"			XT1SA24 ()						
			30"			XT1SA30 ()					
			36"			XT1SA36 ()					
			42"			XT1SA42 ()					
			48"			XT1SA48 ()					
			54"			XT1SA54 ()					
			60"			XT1SA60 ()					
			66"			XT1SA66 ()					
		72"			XT1SA72 ()						
Buttress for slatwall screen 					XTCS1 SBA ()			260.			

Order Code

Example:	XT1LS5709 118 AA
XT1	Crinion Open Table
LS	Open shelf
57	Width
09	Depth
118	Shelf finish
AA	Platform finish

Specifications

Display shelves are anodized aluminum (AA) or any standard painted finish except silver.

For open shelves specify any standard laminate or veneer finish, then platform finish. Shelf platform may be AA or any standard paint finish except silver.

Slatwall adapters are integral color 812 Easy grey or 111 Black only.

Application Notes

Open shelves and display shelves for slatwall are designed for use on Crinion Open Table center screens with slatwall inserts.

Shelves include adapter that snaps into horizontal channels in slatwall, approximately every 2" vertically.

Shelf width fits either full width center screens or screens adjacent to end screens.

Slatwall adapters enable other Applied Wall System shelves and accessories to be mounted to Crinion Open Table slatwall.

Adapter will also fit other Knoll system slatwalls, such as AutoStrada spine or panels, but use of shelves in these applications may not comply with ANSI/BIFMA safety standards for anti-dislodgment.

Side screens

Acrylic, Marker or veneer surface

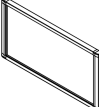
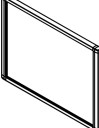
description	application	w	d	h	pattern no.	list	Opal acrylic	Trans. acrylic / Marker	V1	V2	V3	
 Side screen to 43" H	24" D worksurface	22"	1 1/4"	14"	XTSS1 2414 () () ()		\$684.	\$703.	\$1,031.	\$1,106.	\$1,218.	
	30" D worksurface	28"	1 1/4"	14"	XTSS1 3014 () () ()		718.	742.	1,064.	1,148.	1,293.	
	36" D worksurface	34"	1 1/4"	14"	XTSS1 3614 () () ()		781.	813.	1,092.	1,188.	1,363.	
	acrylic shown											
 Side screen to 50" H	24" D worksurface	22"	1 1/4"	21"	XTSS1 2421 () () ()		781.	813.	1,103.	1,197.	1,357.	
	30" D worksurface	28"	1 1/4"	21"	XTSS1 3021 () () ()		815.	852.	1,139.	1,248.	1,452.	
	36" D worksurface	34"	1 1/4"	21"	XTSS1 3621 () () ()		879.	921.	1,171.	1,297.	1,546.	
	acrylic shown											
Side screen brackets (pair)	postformed edge					XTSM1P ()		275.				
	squared edge					XTSM1S ()		194.				
	tapered edge					XTSM1K ()		194.				

Order Code	Specifications	Application Notes
Example: XTSS13014A O AA		
XT Crinion Open Table		
SS1 Side screen		
30 Width		
14 Height		
A Surface		
O Opal		
AA Frame finish		
	1. Specify surface <i>A = Acrylic</i> <i>V = Veneer</i> <i>M = Marker</i> 2. For Acrylic surface specify <i>O = Opal</i> <i>T = Translucent</i> Veneer surfaces may be any standard AutoStrada V1, V2 or V3 veneer. Specify veneer finish code from list on table finishes page in beginning of price list. Frame is clear anodized aluminum or any standard paint finish except 613 Silver. Brackets are available in all paint finishes	Side screens clamp to front and back edge of worksurface at any point (except at hinged access door). Specify side screen brackets separately. Specify 14" H screens for a 42" horizon. Specify 21" H screens for a 49" horizon. Side screens align in height with center screens when worksurfaces are set at 28 3/8" H. Veneer grain direction is horizontal.

Side screens

Tackable fabric surface

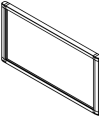
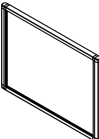
description	application	w	d	h	pattern no.	list	10	15	20	30	35	40	45
	24" D worksurface	22"	1 1/4"	14"	XTSS1 2414F () ()	\$777.	\$785.	\$787.	\$800.	\$808.	\$808.	\$825.	
	30" D worksurface	28"	1 1/4"	14"	XTSS1 3014F () ()	800.	813.	815.	828.	838.	838.	859.	
	36" D worksurface	34"	1 1/4"	14"	XTSS1 3614F () ()	823.	838.	856.	867.	867.	867.	895.	
	24" D worksurface	22"	1 1/4"	21"	XTSS1 2421F () ()	812.	821.	822.	833.	842.	842.	859.	
	30" D worksurface	28"	1 1/4"	21"	XTSS1 3021F () ()	847.	857.	859.	873.	884.	884.	906.	
	36" D worksurface	34"	1 1/4"	21"	XTSS1 3621F () ()	861.	877.	879.	895.	907.	907.	934.	
Side screen brackets (pair)	postformed edge				XTSM1P ()	275.							
	squared edge				XTSM1S ()	194.							
	tapered edge				XTSM1K ()	194.							

Order Code	Specifications	Application Notes
Example: XTSS13014F20 (W2801) 115		
XT Crinion Open Table	1. Tackable fabric surface is suffix F.	Side screens clamp to front and back edge of worksurface at any point (except at hinged access door). Specify side screen brackets separately. Specify 14" H screens for a 43" horizon. Specify 21" H screens for a 50" horizon. Side screens align in height with center screens when worksurfaces are set at 28 3/8" H.
SS1 Side screen	2. Select fabric surface finish code from list on page Crinion Open Table.	
30 Width	3. Specify frame finish.	
14 Height	Frame is clear anodized aluminum or any standard paint finish except 613 Silver.	
F Surface	Fabric is railroaded.	
20 Fabric grade	Brackets are available in all paint finishes.	
W2801 Fabric		
115 Frame finish		

Return screens

Acrylic, Marker or veneer surface

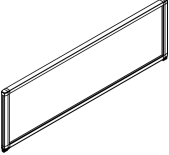
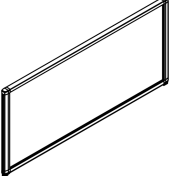
description	application	w	d	h	pattern no.	list	Opal acrylic	Trans. acrylic / Marker	V1	V2	V3
	Return screen to 43" H	54"	52"	1 1/4"	14"	XTRS1 5414 () () ()	\$1,140.	\$1,202.	\$1,243.	\$1,373.	\$1,639.
		60"	58"	1 1/4"	14"	XTRS1 6014 () () ()	1,140.	1,202.	1,258.	1,402.	1,699.
		66"	64"	1 1/4"	14"	XTRS1 6614 () () ()	1,140.	1,202.	1,285.	1,437.	1,769.
		72"	70"	1 1/4"	14"	XTRS1 7214 () () ()	1,140.	1,202.	1,301.	1,465.	1,827.
		78"	76"	1 1/4"	14"	XTRS1 7814 () () ()	1,271.	1,330.	1,541.	1,681.	2,073.
	Return screen to 50" H	54"	52"	1 1/4"	21"	XTRS1 5421 () () ()	1,335.	1,428.	1,362.	1,536.	1,920.
		60"	58"	1 1/4"	21"	XTRS1 6021 () () ()	1,335.	1,428.	1,386.	1,578.	2,007.
		66"	64"	1 1/4"	21"	XTRS1 6621 () () ()	1,335.	1,428.	1,408.	1,616.	2,091.
		72"	70"	1 1/4"	21"	XTRS1 7221 () () ()	1,335.	1,428.	1,432.	1,656.	2,175.
		78"	76"	1 1/4"	21"	XTRS1 7821 () () ()	1,500.	1,590.	1,679.	1,882.	2,443.
Side screen brackets (pair)	postformed edge				XTSM1P ()	275.					
	squared edge				XTSM1S ()	194.					

Order Code	
Example: XTRS16014A O 118	
XT	Crinion Open Table
RS1	Return screen
60	Width
14	Height
A	Acrylic
O	Opal
118	Frame finish

Specifications

- Specify surface
A = Acrylic
V = Veneer
M = Marker
- For Acrylic surface specify
O = Opal
T = Translucent
 Veneer surfaces may be any standard AutoStrada V1, V2 or V3 veneer.
 Specify veneer finish code from list on table finishes page in beginning of price list.
- Specify frame finish.

Frame is clear anodized aluminum (AA) or any standard paint finish except 613 Silver.

Brackets are available in all paint finishes.

Application Notes

Return screens span the depth of Crinion Open Table worksurfaces and the width of a 30", 36" or 42" worksurface planned as perpendicular return. Specify 14" H screens for 42" horizon. Specify 21" H screens for a 49" horizon. Returns (file tops or AutoStrada worksurfaces) must be at the same height as worksurface.

Specify side brackets separately.

Veneer grain direction is horizontal.

Return screens

Tackable fabric surface

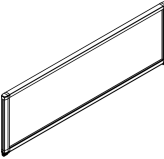
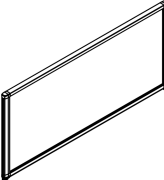
description	application	w	d	h	pattern no.	list	10	15	20	30	35	40	45
 Return screen to 43" H	54"	52"	1 1/4"	14"	XTRS1 5414F () () ()	\$948.	\$970.	\$977.	\$998.	\$1,016.	\$1,016.	\$1,059.	
	60"	58"	1 1/4"	14"	XTRS1 6014F () () ()	956.	980.	985.	1,010.	1,031.	1,031.	1,076.	
	66"	64"	1 1/4"	14"	XTRS1 6614F () () ()	976.	1,000.	1,006.	1,036.	1,058.	1,058.	1,106.	
	72"	70"	1 1/4"	14"	XTRS1 7214F () () ()	981.	1,009.	1,015.	1,049.	1,070.	1,070.	1,127.	
	78"	76"	1 1/4"	14"	XTRS1 7814F () () ()	1,129.	1,160.	1,167.	1,201.	1,224.	1,224.	1,284.	
 Return screen to 50" H	54"	52"	1 1/4"	21"	XTRS1 5421F () () ()	928.	948.	953.	979.	996.	996.	1,037.	
	60"	58"	1 1/4"	21"	XTRS1 6021F () () ()	962.	987.	990.	1,019.	1,038.	1,038.	1,082.	
	66"	64"	1 1/4"	21"	XTRS1 6621F () () ()	968.	995.	999.	1,029.	1,051.	1,051.	1,100.	
	72"	70"	1 1/4"	21"	XTRS1 7221F () () ()	976.	1,003.	1,009.	1,041.	1,066.	1,066.	1,119.	
	78"	76"	1 1/4"	21"	XTRS1 7821F () () ()	1,149.	1,181.	1,188.	1,222.	1,249.	1,249.	1,307.	
Side screen brackets (pair)	postformed edge				XTSM1P ()	275.							
	squared edge				XTSM1S ()	194.							

Order Code	Specifications	Application Notes
Example: XTRS16014F20 (W2801) 611		
XT Crinion Open Table	1. Tackable fabric surface is suffix F.	Fabric return screens span the depth of Crinion Open Table worksurfaces and the width of a 30", 36" or 42" worksurface planned as perpendicular return. Specify 14" H screens for 43" horizon. Specify 21" H screens for a 50" horizon. Returns must be at the same height as worksurface.
RS1 Return screen	2. Select fabric surface finish code from list on page Crinion Open Table.	
60 Width	3. Specify frame finish.	
14 Height	Frame is clear anodized aluminum or any standard paint finish except 613 Silver.	Specify mounting brackets separately.
F Surface	Fabric is railroaded.	
20 Fabric grade	Brackets are available in all paint finishes.	
W2801 Fabric		
611 Frame finish		

Dual end screens

Acrylic, Marker or veneer surface

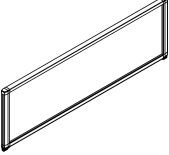
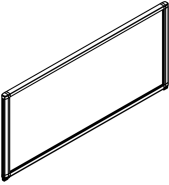
description	application	w	d	h	pattern no.	list	Opal acrylic	Trans. acrylic / Marker	V1	V2	V3	
	Dual end screens to 43" H	24" D dual	48"	1 1/4"	14"	XTES1 4814 () () ()	\$849.	\$878.	\$1,191.	\$1,316.	\$1,561.	
		30" D dual	60"	1 1/4"	14"	XTES1 6014 () () ()	1,107.	1,170.	1,298.	1,447.	1,753.	
		36" D dual	72"	1 1/4"	14"	XTES1 7214 () () ()	1,140.	1,202.	1,370.	1,538.	1,906.	
	acrylic shown											
	Dual end screens to 50" H	24" D dual	48"	1 1/4"	21"	XTES1 4821 () () ()	1,009.	1,059.	1,317.	1,480.	1,834.	
		30" D dual	60"	1 1/4"	21"	XTES1 6021 () () ()	1,302.	1,394.	1,427.	1,621.	2,063.	
		36" D dual	72"	1 1/4"	21"	XTES1 7221 () () ()	1,335.	1,548.	1,483.	1,709.	2,242.	
	acrylic shown											
Replacement mast Kit	acrylic center screen					XTSM1C ()	110.					
	slatwall center screen					XTSM1SLAT ()	292.					
End screen brackets (pair)	tapered edge worksurface					XTSM1KK ()	194.					
Side screen brackets (pair)	postformed edge					XTSM1P ()	275.					
	squared edge					XTSM1S ()	194.					

Order Code

Example:	XTES16014A O AA
XT	Crinion Open Table
ES1	End screen
60	Width
14	Height
A	Surface
O	Opal
AA	Frame finish

Specifications

- Specify surface
A = Acrylic
V = Veneer
M = Marker
- For Acrylic surface specify
O = Opal
T = Translucent
 Veneer surfaces may be any standard AutoStrada V1,V2 or V3 veneer.
 Specify veneer finish code from list on table finishes page in beginning of price list.
- Specify frame finish.

Frame is clear anodized aluminum or any standard paint finish except 613 Silver.

Brackets are available in all paint finishes.

Replacement mast kit for acrylic center screen is 812 Easy Grey or 111 Black.

Application Notes

Dual end screens clamp to front edge of worksurface on either side of table. Specify 14" H screens for a 42" horizon. Specify 21" H screens for a 49" horizon. Side screens align with center screens when worksurfaces are set at 28 3/8" H.

Specify end screen brackets separately for each screen.

Veneer grain direction is horizontal.

Dual end screens

Tackable fabric surface

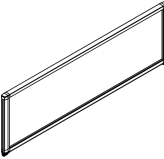
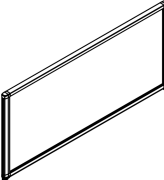
description	application	w	d	h	pattern no.	list	10	15	20	30	35	40	45
	Dual end screens to 43" H	24" D dual	48"	1 1/4"	14"	XTES1 4814F () ()	\$873.	\$894.	\$898.	\$919.	\$935.	\$935.	\$972.
		30" D dual	60"	1 1/4"	14"	XTES1 6014F () ()	956.	980.	985.	1,010.	1,031.	1,031.	1,076.
		36" D dual	72"	1 1/4"	14"	XTES1 7214F () ()	981.	1,009.	1,015.	1,048.	1,070.	1,070.	1,127.
	Dual end screens to 50" H	24" D dual	48"	1 1/4"	21"	XTES1 4821F () ()	943.	963.	968.	989.	1,006.	1,006.	1,042.
		30" D dual	60"	1 1/4"	21"	XTES1 6021F () ()	1,025.	1,050.	1,056.	1,081.	1,101.	1,101.	1,146.
		36" D dual	72"	1 1/4"	21"	XTES1 7221F () ()	1,039.	1,068.	1,072.	1,104.	1,130.	1,130.	1,181.
Replacement mast Kit	acrylic center screen				XTSM1C ()	110.							
	slatwall center screen				XTSM1SLAT ()	292.							
End screen brackets (pair)	tapered edge				XTSM1KK ()	194.							
	worksurface												
Side screen brackets (pair)	postformed edge				XTSM1P ()	275.							
	squared edge				XTSM1S ()	194.							

Order Code	Specifications	Application Notes
Example: XTES16014F20 (W2801) 112	1. Tackable fabric surface is suffix F.	Dual end screens clamp to front edge of worksurface on either side of table. Specify 14" H screens for a 43" horizon. Specify 21" H screens for a 50" horizon. Side screens align with center screens when worksurfaces are set at 28 3/8" H.
XT Crinion Open Table	2. Select fabric surface finish code from list on page Crinion Open Table.	
ES1 End screen	3. Specify frame finish.	
60 Width	Frame is clear anodized aluminum or any standard paint finish except 613 Silver.	Specify end screen brackets separately for each screen.
14 Height	Fabric is railroaded.	
F Surface	Brackets are available in all paint finishes.	
20 Fabric grade	Replacement mast kit is 812 Easy Grey or 111 Black.	
W2801 Fabric		
112 Frame finish		

Single sided end screen

Acrylic, Marker or veneer surface

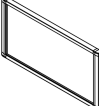
description	application	w	d	h	pattern no.	list	Opal	Trans.	V1	V2	V3
							acrylic	acrylic / Marker			
	24" D Single sided	24 1/2"	1 1/4"	14"	XTES1 2414 () ()	\$684.	\$703.	\$1,031.	\$1,106.	\$1,218.	
	30" D Single sided	30 1/2"	1 1/4"	14"	XTES1 3014 () ()	718.	742.	1,064.	1,148.	1,293.	
	36" D Single sided	36 1/2"	1 1/4"	14"	XTES1 3614 () ()	781.	813.	1,092.	1,188.	1,363.	
acrylic shown											

	24" D single sided	24 1/2"	1 1/4"	21"	XTES1 2421 () ()	781.	813.	1,103.	1,197.	1,357.	
	30" D single sided	30 1/2"	1 1/4"	21"	XTES1 3021 () ()	815.	852.	1,139.	1,248.	1,452.	
	36" D single sided	36 1/2"	1 1/4"	21"	XTES1 3621 () ()	879.	921.	1,171.	1,297.	1,546.	
acrylic shown											

Single sided end screen brackets (set)	postformed edge	XTSM1PC ()	196.
	square edge	XTSM1SC ()	145.
	tapered edge	XTSM1KC ()	145.

Order Code	Specifications	Application Notes
Example: XTES13614A O 114		
XT Crinion Open Table		
ES1 End screen		
36 Width		
14 Height		
A Surface		
O Opal		
114 Frame finish		
	<ol style="list-style-type: none"> Specify surface <i>A = Acrylic</i> <i>V = Veneer</i> <i>M = Marker</i> For Acrylic surface specify <i>O = Opal</i> <i>T = Translucent</i> Veneer surfaces may be any standard AutoStrada V1,V2 or V3 veneer. Specify veneer finish code from list on table finishes page in beginning of price list. Specify frame finish. <p>Frame is clear anodized aluminum or any standard paint finish except 613 Silver.</p> <p>Brackets are available in all paint finishes.</p>	<p>Single sided end screens clamp to front edge of worksurface and attach to top of channel. Specify 14" H screens for a 42" horizon. Specify 21" H screens for a 49" horizon. Side screens align with center screens when worksurfaces are set at 28 3/8" H.</p> <p>Specify end screen brackets separately for each sceen.</p> <p>Veneer grain direction is horizontal.</p>

Single sided end screen

Tackable fabric surface

AutoStrada

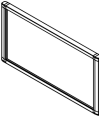
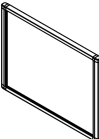
description	application	w	d	h	pattern no.	list	10	15	20	30	35	40	45
	Single sided end screens to 43" H	24" D Single sided	24 1/2"	1 1/4"	14"	XTES1 2414F () () ()	\$777.	\$785.	\$787.	\$800.	\$808.	\$808.	\$825.
		30" D Single sided	30 1/2"	1 1/4"	14"	XTES1 3014F () () ()	800.	813.	815.	828.	838.	838.	859.
		36" D Single sided	36 1/2"	1 1/4"	14"	XTES1 3614F () () ()	823.	838.	856.	867.	867.	867.	895.
	Single sided end screen to 50" H	24" D single sided	24 1/2"	1 1/4"	21"	XTES1 2421F () () ()	812.	821.	822.	833.	842.	842.	859.
		30" D single sided	30 1/2"	1 1/4"	21"	XTES1 3021F () () ()	847.	857.	859.	873.	884.	884.	906.
		36" D single sided	36 1/2"	1 1/4"	21"	XTES1 3621F () () ()	861.	877.	879.	895.	907.	907.	934.
Single sided end screen brackets (set)	postformed edge				XTSM1PC ()	196.							
	square edge				XTSM1SC ()	145.							
	tapered edge				XTSM1KC ()	145.							

Order Code	Specifications	Application Notes
Example: XTES13614F20 (W2801) 111		
XT Crinion Open Table	1. Tackable fabric surface is suffix F.	Single sided end screens clamp to front edge of worksurface and attach to top of channel. Specify 14" H screens for a 43" horizon. Specify 21" H screens for a 50" horizon. Side screens align with center screens when worksurfaces are set at 28 3/8" H.
ES1 End screen	2. Select fabric surface finish code from list on table finishes page in beginning of price list.	
36 Width	3. Specify frame finish.	
14 Height	Frame is clear anodized aluminum or any paint finish except 613 Silver.	Specify end screen brackets separately for each screen.
F Surface		
20 Fabric grade		
W2801 Fabric	Fabric is railroaded.	
111 Frame finish	Brackets are available in all paint finishes.	

Frameless glass Add up for *Crinion Open Table*

AutoStrada

description	w	d	h	pattern number	clear	powder
					tempered	
Frameless glass Add ups	48"	1/2"	12"	XAUA 1248G () ()	\$581.	\$603.
	60"	1/2"	12"	XAUA 1260G () ()	710.	739.
	72"	1/2"	12"	XAUA 1272G () ()	840.	872.

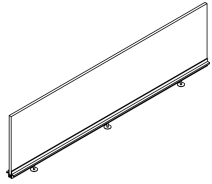

Crinion Open Table

Order Code	Specifications	Application Notes
Example: XAUA 1248G TEMP AA	<i>Add up type:</i>	Frameless glass addups for Crinion Open Table match those available for the AutoStrada spine.
X Crinion Open Table	G Glass	
AUA Frameless addup screen	Glass add-ups are available with the following glass options: TEMP Clear tempered GL13 Powder	Tempered glass in clear or powered finish is 1/2" thick. Base frame is secured with bolts to top channel for frameless glass addups.
48 Width		
12 Height		
G Glass	Specify base finish: AA anodized aluminum and all standard painted finishes except 613 Silver.	Frameless addups cannot be mounted to standard top channel included with base assemblies.
TEMP Finish		
AA Base finish		Base extrusion is clear anodized aluminum or any standard painted finish except Silver.

Morrison Network privacy screens mounting kit for Crinion Open Table

AutoStrada

description	w	d	h	pattern number	list price
Fabric screen mounting kit				XTPS1MZKIT	\$133.



Order Code	Specifications	Applications notes
Example: XTPS1MZKIT		
XT	Crinion Open Table	<p>Crinion Open Tables are designed to accept Morrison Network privacy screens with fabric screen mounting kit. Screens are tackable fabric, $\frac{3}{4}$" thick, in widths corresponding to Crinion worksurfaces 48", 60" or 72" wide. Specify screens MZ1-B4815F, MZ1B6015F or MZ1B7215F.</p> <p>Specify one mounting kit for each screen. Fabric screen mounting kits include two uprights that fasten to the top channel at any point. Uprights slide into internal channels in screens. Fabric screens do not align in height with acrylic privacy screens.</p>
PS1	Privacy Screen	
MZ	Fabric	
KIT	Kit	

Wall Mounting Suggestions

The following information is provided only as a guide, and represents minimum recommendations only. Knoll does not accept responsibility for the attachment of any Knoll product to a Customer's site wall. Wall specification/construction is the responsibility of the Customer and its structural engineer/architect. Failure to properly attach Knoll products to adequate wall structures can lead to property damage and/or personal injury.

You should consult your own structural engineers and/or architects and must not rely on the information provided herein.

It is the responsibility of the Customer and its structural engineers/architects to verify that the permanent structural walls (studs, blocks, solid masonry, etc.) on which the Knoll products are intended to be mounted are designed appropriately to support the product weight, PLUS 3 lbs. per linear inch for each useable shelf length

NOTE: A cabinet's top is considered a "useable shelf" and MUST be included in the calculation of the total load for an overhead cabinet.

It is the responsibility of the Customer and its structural engineer/architects to specify the fasteners and method for attaching the Knoll supplied wall mounting cleat, bracket, frame, etc. to the supporting wall and to confirm that the installers have adhered to these specifications. For all local building standards and codes, and additional requirements (including, but not limited to, seismic conditions) the Customer should always consult local code agencies.

	EXISTING CONSTRUCTION					
	NEW CONSTRUCTION	Cinder Block or Poured Concrete Masonry Wall	Wood Stud Wall, the studs being FULL HEIGHT to the roof/floor above	Wood Stud Wall, the studs being only Ceiling Height	Steel Stud Wall, the studs being FULL HEIGHT to the roof/floor above	Steel Stud Wall, the studs being only Ceiling Height
Stud Specification	Wood studs, grade #2 or better, 3 1/2" minimum width, OR Metal studs, minimum 25 gage thickness, 3 5/8" minimum width	The wall must be a minimum of 6" thick, and must be full height to the roof/ floor structure above	Wood studs must be Grade #2, or better, 3 1/2" minimum width	Wood studs must be Grade #2, or better, 3 1/2" minimum width	Metal studs must be minimum 25 gage thickness, 3 5/8" minimum width	Metal studs must be minimum 25 gage thickness, 3 5/8" minimum width
Stud Centers	Metal and wood studs must be spaced at 16" c/c maximum	N/A	Wood studs must be spaced at 16" c/c maximum	Wood studs must be spaced at 16" c/c maximum"	Metal studs must be spaced at 16" c/c maximum	Metal studs must be spaced at 16" c/c maximum
Stud Height	Metal and wood studs must extend upwards, and be securely attached to the roof/ floor structure above			Wood studs must be braced above the ceiling, and be securely attached to the roof/floor structure above Affix #2 grade 'cap' across the top of the studs, then place diagonal studs from the top cap up to underside of the roof/ floor structure above		Metal studs must be braced above the ceiling, and be securely attached to the roof/floor structure above Affix metal bracing 'cap' across the top of the studs, then place diagonal studs from the top cap up to underside of the roof / floor structure above
Mounting the Knoll Supplied Cleat, Bracket, Frame, etc*	Insert a 2" X 6" wood block, #2 grade or better, [or a Danback™ flexible wood backing system] horizontally between each of the studs to accommodate the full width of the cabinet, and beyond to the next stud. Fasten the wood block to each stud using three screws at the ends of each block. (Fasten the Danback™ as directed by the manufacturer) Fasten the Knoll supplied wall mounting cleat, bracket, frame, etc directly to each wood block every 6" For wall mounting structures that have a rectangular frame-like configuration: fasten the top horizontal element of the frame to the wood blocking every 6", and fasten the lower horizontal element to each wall stud, using one fastener per stud.	Fasten the Knoll supplied cabinet wall mounting cleat, bracket, frame, etc. directly to the masonry wall every 6" For wall mounting structures that have a rectangular frame-like configuration: fasten the top horizontal element of the frame to the wall every 6", and fasten the lower horizontal element to the wall every 16"	In the desired location of the cabinet mounting rail, remove an 8" high section of drywall the width of the cabinet, and beyond to the next stud. Insert a 2" X 6" wood block, #2 grade or better, horizontally between each of the exposed studs. Fasten the wood block to each stud using three screws at the ends of each block. Replace the drywall and repair as desired. Fasten the Knoll supplied wall mounting cleat, rail, frame, etc directly to the wood block every 6" For wall mounting structures that have a rectangular frame-like configuration: fasten the top horizontal element of the frame to the wood blocking every 6", and fasten the lower horizontal element to each wall stud, using one fastener per stud.	In the desired location of the cabinet mounting rail, remove an 8" high section of drywall the width of the cabinet, and beyond to the next stud. Insert a 2" X 6" wood block, #2 grade or better, horizontally between each of the exposed studs. Fasten the wood block to each stud using three screws at the ends of each block. Replace the drywall and repair as desired. Fasten the Knoll supplied wall mounting cleat, rail, frame, etc directly to the wood block every 6" For wall mounting structures that have a rectangular frame-like configuration: fasten the top horizontal element of the frame to the wood blocking every 6", and fasten the lower horizontal element to each wall stud, using one fastener per stud.	In the desired location of the cabinet mounting rail, remove an 8" high section of drywall the width of the cabinet, and beyond to the next stud. Insert a 2" X 6" wood block, #2 grade or better, [or a Danback™ flexible wood backing system] horizontally between each of the exposed studs. Fasten the wood block to each stud using three screws at the ends of each block. Replace the drywall and repair as desired. Fasten the Knoll supplied wall mounting cleat, rail, frame, etc directly to the wood block every 6" For wall mounting structures that have a rectangular frame-like configuration: fasten the top horizontal element of the frame to the wood blocking every 6", and fasten the lower horizontal element to each wall stud, using one fastener per stud.	In the desired location of the cabinet mounting rail, remove an 8" high section of drywall the width of the cabinet, and beyond to the next stud. Insert a 2" X 6" wood block, #2 grade or better, [or a Danback™ flexible wood backing system] horizontally between each of the exposed studs. Fasten the wood block to each stud using three screws at the ends of each block. Replace the drywall and repair as desired. Fasten the Knoll supplied wall mounting cleat, rail, frame, etc directly to the wood block every 6" For wall mounting structures that have a rectangular frame-like configuration: fasten the top horizontal element of the frame to the wood blocking every 6", and fasten the lower horizontal element to each wall stud, using one fastener per stud.
*Graham Wall Hung Shelf	The Graham Wall Hung Shelf Bracket (and others like it) requires full support behind the full height of the bracket This should be accomplished by insertion of additional 2"X 6" wood blocking between the studs as defined above	Fasten the Knoll supplied wall mounting brackets directly to the masonry wall, using the holes provided in each bracket	The Graham Wall Hung Shelf Bracket (and others like it) requires full support behind the full height of the bracket This should be accomplished by insertion of additional 2"X 6" wood blocking between the studs as defined above	The Graham Wall Hung Shelf Bracket (and others like it) requires full support behind the full height of the bracket This should be accomplished by insertion of additional 2"X 6" wood blocking between the studs as defined above	The Graham Wall Hung Shelf Bracket (and others like it) requires full support behind the full height of the bracket This should be accomplished by insertion of additional 2"X 6" wood blocking between the studs as defined above	The Graham Wall Hung Shelf Bracket (and others like it) requires full support behind the full height of the bracket This should be accomplished by insertion of additional 2"X 6" wood blocking between the studs as defined above
Fasten the Knoll supplied wall cleat with...	#10 x 2 1/2" Grabber Woodys Screws or equiv. @ 6" c/c, screwed directly into the wood blocking	3/16" x 3 1/2" Tapcon Masonry Screws or equiv. @ 6" c/c with 1-1/4" embedment, screwed directly into the masonry wall	#10 x 2 1/2" Grabber Woodys Screws or equiv. @ 6" c/c, screwed directly into the wood blocking	#10 x 2 1/2" Grabber Woodys Screws or equiv. @ 6" c/c, screwed directly into the wood blocking	#10 x 2 1/2" Grabber Woodys Screws or equiv. @ 6" c/c, screwed directly into the wood blocking	#10 x 2 1/2" Grabber Woodys Screws or equiv. @ 6" c/c, screwed directly into the wood blocking

Alpha-Numeric Index

<i>pattern no.</i>	<i>page</i>	<i>pattern no.</i>	<i>page</i>	<i>pattern no.</i>	<i>page</i>	<i>pattern no.</i>	<i>page</i>
A1CHLTT102	128	A1PGG4972	89, 113	AAMTB	244	AAWS C0736 A	27
A1CHLTT108	128	A1SGG4860	89, 113	AAMTC24	244	AAWS C0736 F	29
A1CHLTT114	128	A1SGG4872	89, 113	AAMTC30	244	AAWS C0736 M	24
A1CHLTT120	128	A3CPBDL	174	AAMTC36	244	AAWS C0736 P	33
A1CHLTT126	128	A3CPBDR	174	AAMTC42	244	AAWS C0736 R	22
A1CHLTT132	128	A3CPBS	174	AAMTC48	244	AAWS C0736 S	23
A1CHLTT138	128	AA1 30E	86	AAMTC54	244	AAWS C0742	31
A1CHLTT144	128	AA1 39E	86	AAMTC60	244	AAWS C0742 A	27
A1CHLTT60	128	AA1 48E	86	AAMTC66	244	AAWS C0742 F	29
A1CHLTT66	128	AA1 64E	86	AAMTC72	244	AAWS C0742 M	24
A1CHLTT72	128	AA1 ARE	71	AAMTCH24	244	AAWS C0742 P	33
A1CHLTT78	128	AA1 BS	245	AAMTCH30	244	AAWS C0742 R	22
A1CHLTT84	128	AA1 T06	86	AAMTCH36	244	AAWS C0742 S	23
A1CHLTT90	128	AA1 T18	86	AAMTCH42	244	AAWS C0748	31
A1CHLTT96	128	AA1 T24	86	AAMTCH48	244	AAWS C0748 A	27
A1CRTT102	128	AA1 T30	86	AAMTCH54	244	AAWS C0748 F	29
A1CRTT108	128	AA1 T36	86	AAMTCH60	244	AAWS C0748 M	24
A1CRTT114	128	AA1 T42	86	AAMTCH66	244	AAWS C0748 P	33
A1CRTT120	128	AA1 T48	86	AAMTCH72	244	AAWS C0748 R	22
A1CRTT126	128	AA1 T60	86	AAMTT	244	AAWS C0748 S	23
A1CRTT132	128	AA1 T72	87	AAV1 4824 S2D1F	180	AAWS C0754	31
A1CRTT138	128	AA1ARODN	216	AAV1 4830 S2D1F	180	AAWS C0754 A	27
A1CRTT144	128	AA1CET39	70	AAV1 6424 S2D2F	180	AAWS C0754 F	29
A1CRTT60	128	AA1CET48	70	AAV1 6430 S2D2F	180	AAWS C0754 M	24
A1CRTT66	128	AA1CET64	70	AAWS BC 036	19	AAWS C0754 P	33
A1CRTT72	128	AA1DHPS36(5)	76	AAWS BC 042	19	AAWS C0754 R	22
A1CRTT78	128	AA1DHPS42(5)	76	AAWS BC 048	19	AAWS C0754 S	23
A1CRTT84	128	AA1DHPS50(5)	76	AAWS BC 054	19	AAWS C0760	31
A1CRTT90	128	AA1DHPS57(5)	76	AAWS BC 060	19	AAWS C0760 A	27
A1CRTT96	128	AA1DHPS64(5)	76	AAWS BC 066	19	AAWS C0760 F	29
A1FHETE34	127	AA1DHTC	76	AAWS BC 072	19	AAWS C0760 M	24
A1FHETE42	127	AA1GPS	75	AAWS BC 078	19	AAWS C0760 P	33
A1FHETE49	127	AA1MPS30	70	AAWS BC 084	19	AAWS C0760 R	22
A1FHETE64	127	AA1MPS39	70	AAWS BC 090	19	AAWS C0760 S	23
A1GCTDK60141(L/V/M)	221	AA1MPS42	70	AAWS BC 096	19	AAWS C0766	31
A1GCTDK60142(L/V/M)	221	AA1MPS48	70	AAWS BC 102	19	AAWS C0766 A	27
A1GCTDK72141(L/V/M)	221	AA1MPS56	70	AAWS BC 108	19	AAWS C0766 F	29
A1GCTDK72142(L/V/M)	221	AA1MPS64	70	AAWS BC 114	19	AAWS C0766 M	24
A1GCTDK90141(L/V/M)	221	AA1MPS74	70	AAWS BC 120	19	AAWS C0766 P	33
A1GCTDK90142(L/V/M)	221	AA1MPS80	70	AAWS BC 126	19	AAWS C0766 R	22
A1GCTDK96141(L/V/M)	221	AA1MRS	70	AAWS BC 132	19	AAWS C0766 S	23
A1GCTDK96142(L/V/M)	221	AA1NSK	87	AAWS BC 138	19	AAWS C0772	31
A1GGPC4234(L/R)	89, 113	AA1OR	60	AAWS BC 144	19	AAWS C0772 A	27
A1GGPC4934(L/R)	89, 113	AA1ORD	60	AAWS BE	37, 38	AAWS C0772 F	29
A1GGSE30(L/R)	89, 113	AA1RE	87	AAWS BE27	44	AAWS C0772 M	24
A1GGSPSC30(L/R)	89, 113	AA1ROUP	216	AAWS BE28	44	AAWS C0772 P	33
A1HLETE3442	127	AA1ROXUP	216	AAWS C0724	31	AAWS C0772 R	22
A1HLETE3449	127	AA1RPS34	72	AAWS C0724 A	27	AAWS C0772 S	23
A1HLETE3464	127	AA1RPS42	72	AAWS C0724 F	29	AAWS C0778	31
A1HLETE4249	127	AA1RPS49	72	AAWS C0724 M	24	AAWS C0778 F	29
A1HLETE4264	127	AA1RPS64	72	AAWS C0724 P	33	AAWS C0778 P	33
A1HLETE4964	127	AA1RPS79	72	AAWS C0724 R	22	AAWS C0778 R	22
A1HLPTE3442	127	AA1RTC	73	AAWS C0724 S	23	AAWS C0778 S	23
A1HLPTE3449	127	AA1UA39	77	AAWS C0730	31	AAWS C0784	31
A1HLPTE3464 (F/T)	127	AA1UA48	77	AAWS C0730 A	27	AAWS C0784 F	29
A1HLPTE4249	127	AA1UA64	77	AAWS C0730 F	29	AAWS C0784 P	33
A1HLPTE4264 (F/T)	127	AA1UPS39	77	AAWS C0730 M	24	AAWS C0784 R	22
A1HLPTE4964	127	AA1UPS48	77	AAWS C0730 P	33	AAWS C0784 S	23
A1PGG4260	89, 113	AA1UPS64	77	AAWS C0730 R	22	AAWS C0790	31
A1PGG4272	89, 113	AA2 MTC	70	AAWS C0730 S	23	AAWS C0790 F	29
A1PGG4960	89, 113	AA2 UTC	77	AAWS C0736	31	AAWS C0790 P	33

<i>pattern no.</i>	<i>page</i>	<i>pattern no.</i>	<i>page</i>	<i>pattern no.</i>	<i>page</i>	<i>pattern no.</i>	<i>page</i>
AAWS C0790 R	22	AAWS C1572 F	29	AAWS C2260 F	30	AAWS C3060	32
AAWS C0790 S	23	AAWS C1572 G	35	AAWS C2260 G	35	AAWS C3060 A	28
AAWS C0796	31	AAWS C1572 L	26	AAWS C2260 L	26	AAWS C3060 F	30
AAWS C0796 F	29	AAWS C1572 M	24	AAWS C2260 M	24	AAWS C3060 M	24
AAWS C0796 P	33	AAWS C1572 P	33	AAWS C2260 P	34	AAWS C3060 P	34
AAWS C0796 R	22	AAWS C1578	31	AAWS C2266	32	AAWS C3066	32
AAWS C0796 S	23	AAWS C1578 F	29	AAWS C2266 A	28	AAWS C3066 A	28
AAWS C1524	31	AAWS C1578 L	26	AAWS C2266 F	30	AAWS C3066 F	30
AAWS C1524 A	27	AAWS C1578 P	33	AAWS C2266 G	35	AAWS C3066 M	24
AAWS C1524 F	29	AAWS C1584	31	AAWS C2266 L	26	AAWS C3066 P	34
AAWS C1524 G	35	AAWS C1584 F	29	AAWS C2266 M	24	AAWS C3072	32
AAWS C1524 L	26	AAWS C1584 L	26	AAWS C2266 P	34	AAWS C3072 A	28
AAWS C1524 M	24	AAWS C1584 P	33	AAWS C2272	32	AAWS C3072 F	30
AAWS C1524 P	33	AAWS C1590	31	AAWS C2272 A	28	AAWS C3072 M	24
AAWS C1530	31	AAWS C1590 F	29	AAWS C2272 F	30	AAWS C3072 P	34
AAWS C1530 A	27	AAWS C1590 L	26	AAWS C2272 G	35	AAWS C3078	32
AAWS C1530 F	29	AAWS C1590 P	33	AAWS C2272 L	26	AAWS C3078 F	30
AAWS C1530 G	35	AAWS C1596	31	AAWS C2272 M	24	AAWS C3078 P	34
AAWS C1530 L	26	AAWS C1596 F	29	AAWS C2272 P	34	AAWS C3084	32
AAWS C1530 M	24	AAWS C1596 L	26	AAWS C2278	32	AAWS C3084 F	30
AAWS C1530 P	33	AAWS C1596 P	33	AAWS C2278 F	30	AAWS C3084 P	34
AAWS C1536	31	AAWS C2224	32	AAWS C2278 L	26	AAWS C3090	32
AAWS C1536 A	27	AAWS C2224 A	28	AAWS C2278 P	34	AAWS C3090 F	30
AAWS C1536 F	29	AAWS C2224 F	30	AAWS C2284	32	AAWS C3090 P	34
AAWS C1536 G	35	AAWS C2224 G	35	AAWS C2284 F	30	AAWS C3096	32
AAWS C1536 L	26	AAWS C2224 L	26	AAWS C2284 L	26	AAWS C3096 F	30
AAWS C1536 M	24	AAWS C2224 M	24	AAWS C2284 P	34	AAWS C3096 P	34
AAWS C1536 P	33	AAWS C2224 P	34	AAWS C2290	32	AAWS C4524 M	25
AAWS C1542	31	AAWS C2230	32	AAWS C2290 F	30	AAWS C4530 M	25
AAWS C1542 A	27	AAWS C2230 A	28	AAWS C2290 L	26	AAWS C4536 M	25
AAWS C1542 F	29	AAWS C2230 F	30	AAWS C2290 P	34	AAWS C4542 M	25
AAWS C1542 G	35	AAWS C2230 G	35	AAWS C2296	32	AAWS C4548 M	25
AAWS C1542 L	26	AAWS C2230 L	26	AAWS C2296 F	30	AAWS C4554 M	25
AAWS C1542 M	24	AAWS C2230 M	24	AAWS C2296 L	26	AAWS C4560 M	25
AAWS C1542 P	33	AAWS C2230 P	34	AAWS C2296 P	34	AAWS C4566 M	25
AAWS C1548	31	AAWS C2236	32	AAWS C3024	32	AAWS C4572 M	25
AAWS C1548 A	27	AAWS C2236 A	28	AAWS C3024 A	28	AAWS CC 036	17
AAWS C1548 F	29	AAWS C2236 F	30	AAWS C3024 F	30	AAWS CC 042	17
AAWS C1548 G	35	AAWS C2236 G	35	AAWS C3024 M	24	AAWS CC 048	17
AAWS C1548 L	26	AAWS C2236 L	26	AAWS C3024 P	34	AAWS CC 054	17
AAWS C1548 M	24	AAWS C2236 M	24	AAWS C3030	32	AAWS CC 060	17
AAWS C1548 P	33	AAWS C2236 P	34	AAWS C3030 A	28	AAWS CC 066	17
AAWS C1554	31	AAWS C2242	32	AAWS C3030 F	30	AAWS CC 072	17
AAWS C1554 A	27	AAWS C2242 A	28	AAWS C3030 M	24	AAWS CC 078	17
AAWS C1554 F	29	AAWS C2242 F	30	AAWS C3030 P	34	AAWS CC 084	17
AAWS C1554 G	35	AAWS C2242 G	35	AAWS C3036	32	AAWS CC 090	17
AAWS C1554 L	26	AAWS C2242 L	26	AAWS C3036 A	28	AAWS CC 096	17
AAWS C1554 M	24	AAWS C2242 M	24	AAWS C3036 F	30	AAWS CC 102	17
AAWS C1554 P	33	AAWS C2242 P	34	AAWS C3036 M	24	AAWS CC 108	17
AAWS C1560	31	AAWS C2248	32	AAWS C3036 P	34	AAWS CC 114	17
AAWS C1560 A	27	AAWS C2248 A	28	AAWS C3042	32	AAWS CC 120	17
AAWS C1560 F	29	AAWS C2248 F	30	AAWS C3042 A	28	AAWS CC 126	17
AAWS C1560 G	35	AAWS C2248 G	35	AAWS C3042 F	30	AAWS CC 132	17
AAWS C1560 L	26	AAWS C2248 L	26	AAWS C3042 M	24	AAWS CC 138	17
AAWS C1560 M	24	AAWS C2248 M	24	AAWS C3042 P	34	AAWS CC 144	17
AAWS C1560 P	33	AAWS C2248 P	34	AAWS C3048	32	AAWS CG	46
AAWS C1566	31	AAWS C2254	32	AAWS C3048 A	28	AAWS CH	46
AAWS C1566 A	27	AAWS C2254 A	28	AAWS C3048 F	30	AAWS CT24	44
AAWS C1566 F	29	AAWS C2254 F	30	AAWS C3048 M	24	AAWS CT30	44
AAWS C1566 G	35	AAWS C2254 G	35	AAWS C3048 P	34	AAWS CT36	44
AAWS C1566 L	26	AAWS C2254 L	26	AAWS C3054	32	AAWS CT42	44
AAWS C1566 M	24	AAWS C2254 M	24	AAWS C3054 A	28	AAWS CT48	44
AAWS C1566 P	33	AAWS C2254 P	34	AAWS C3054 F	30	AAWS CT54	44
AAWS C1572	31	AAWS C2260	32	AAWS C3054 M	24	AAWS CT60	44
AAWS C1572 A	27	AAWS C2260 A	28	AAWS C3054 P	34	AAWS CT66	44

<i>pattern no.</i>	<i>page</i>	<i>pattern no.</i>	<i>page</i>	<i>pattern no.</i>	<i>page</i>	<i>pattern no.</i>	<i>page</i>
AAWS CT72	44	AAWS LS6609 G	37	AAWS OGD 30	42	AAWS TC 108	15
AAWS DS0605	36	AAWS LS6612	38	AAWS OGD 36	42	AAWS TC 114	15
AAWS DS2405	36	AAWS LS7209 G	37	AAWS OGD 42	42	AAWS TC 120	15
AAWS DS3005	36	AAWS LS7212	38	AAWS OGD 48	42	AAWS TC 126	15
AAWS DS3605	36	AAWS MT24	46	AAWS OGD 54	42	AAWS TC 132	15
AAWS DS4205	36	AAWS MT30	46	AAWS OGD 60	42	AAWS TC 138	15
AAWS DS4805	36	AAWS MT36	46	AAWS OGD 66	42	AAWS TC 144	15
AAWS DS5405	36	AAWS MT42	46	AAWS OGD 72	42	AAWS TU 036	16
AAWS DS6005	36	AAWS MT48	46	AAWS OGD 78	42	AAWS TU 042	16
AAWS DS6605	36	AAWS MT54	46	AAWS OGD 84	42	AAWS TU 048	16
AAWS DS7205	36	AAWS MT60	46	AAWS OGD 90	42	AAWS TU 054	16
AAWS EASEL	46	AAWS MT66	46	AAWS OGD 96	42	AAWS TU 060	16
AAWS ET 106	20	AAWS MT72	46	AAWS OGO 18	39	AAWS TU 066	16
AAWS ET 114	20	AAWS OBD 18L	42	AAWS OGO 24	39	AAWS TU 072	16
AAWS ET 144	20	AAWS OBD 18R	42	AAWS OGO 30	39	AAWS TU 078	16
AAWS ET 69	20	AAWS OBD 24	42	AAWS OGO 36	39	AAWS TU 084	16
AAWS ET 84	20	AAWS OBD 30	42	AAWS OGO 42	39	AAWS TU 090	16
AAWS ET 91	20	AAWS OBD 36	42	AAWS OGO 48	39	AAWS TU 096	16
AAWS ET 99	20	AAWS OBD 42	42	AAWS OGO 54	39	AAWS TU 102	16
AAWS ETO 69	20	AAWS OBD 48	42	AAWS OGO 60	39	AAWS TU 108	16
AAWS ETO 84	20	AAWS OBD 54	42	AAWS OGO 66	39	AAWS TU 114	16
AAWS F2236	14	AAWS OBD 60	42	AAWS OGO 72	39	AAWS TU 120	16
AAWS F2248	14	AAWS OBD 66	42	AAWS OGO 78	39	AAWS TU 126	16
AAWS F3036	14	AAWS OBD 72	42	AAWS OGO 84	39	AAWS TU 132	16
AAWS F3048	14	AAWS OBD 78	42	AAWS OGO 90	39	AAWS TU 138	16
AAWS F6936	14	AAWS OBD 84	42	AAWS OGO 96	39	AAWS TU 144	16
AAWS F6948	14	AAWS OBD 90	42	AAWS OGR 42	40	AAWS US2409 G	37
AAWS F8436	14	AAWS OBD 96	42	AAWS OGR 48	40	AAWS US2412	38
AAWS F8448	14	AAWS OBO 18	39	AAWS OGR 54	40	AAWS US3009 G	37
AAWS IBT	20	AAWS OBO 24	39	AAWS OGR 60	40	AAWS US3012	38
AAWS IC 024	18	AAWS OBO 30	39	AAWS OGR 66	40	AAWS US3609 G	37
AAWS IC 030	18	AAWS OBO 36	39	AAWS OGR 72	40	AAWS US3612	38
AAWS IC 036	18	AAWS OBO 42	39	AAWS OGR 78	40	AAWS US4209 G	37
AAWS IC 042	18	AAWS OBO 48	39	AAWS OGR 84	40	AAWS US4212	38
AAWS IC 048	18	AAWS OBO 54	39	AAWS OGR 90	40	AAWS US4809 G	37
AAWS IC 054	18	AAWS OBO 60	39	AAWS OGR 96	40	AAWS US4812	38
AAWS IC 060	18	AAWS OBO 66	39	AAWS OGS 42	41	AAWS US5409 G	37
AAWS IC 066	18	AAWS OBO 72	39	AAWS OGS 48	41	AAWS US5412	38
AAWS IC 072	18	AAWS OBO 78	39	AAWS OGS 54	41	AAWS US6009 G	37
AAWS IC 078	18	AAWS OBO 84	39	AAWS OGS 60	41	AAWS US6012	38
AAWS IC 084	18	AAWS OBO 90	39	AAWS OGS 66	41	AAWS US6609 G	37
AAWS IC 090	18	AAWS OBO 96	39	AAWS OGS 72	41	AAWS US6612	38
AAWS IC 096	18	AAWS OBR 42	40	AAWS OGS 78	41	AAWS US7209 G	37
AAWS IC 102	18	AAWS OBR 48	40	AAWS OGS 84	41	AAWS US7212	38
AAWS IC 108	18	AAWS OBR 54	40	AAWS OGS 90	41	AAWS VFC	20
AAWS IC 114	18	AAWS OBR 60	40	AAWS OGS 96	41	AAWS WMC	46
AAWS IC 120	18	AAWS OBR 66	40	AAWS PH	46	AAWS WOMK 18	43
AAWS IC 126	18	AAWS OBR 72	40	AAWS RET	22	AAWS WOMK 24	43
AAWS IC 132	18	AAWS OBR 78	40	AAWS RO MK	43	AAWS WOMK 30	43
AAWS IC 138	18	AAWS OBR 84	40	AAWS RPM1 05	45	AAWS WOMK 36	43
AAWS IC 144	18	AAWS OBR 90	40	AAWS RPM2 02	45	AAWS WOMK 42	43
AAWS LS2409 G	37	AAWS OBR 96	40	AAWS RPM2 05	45	AAWS WOMK 48	43
AAWS LS2412	38	AAWS OBS 42	41	AAWS RPM2I 05	45	AAWS WOMK 54	43
AAWS LS3009 G	37	AAWS OBS 48	41	AAWS TC 036	15	AAWS WOMK 60	43
AAWS LS3012	38	AAWS OBS 54	41	AAWS TC 042	15	AAWS WOMK 66	43
AAWS LS3609 G	37	AAWS OBS 60	41	AAWS TC 048	15	AAWS WOMK 72	43
AAWS LS3612	38	AAWS OBS 66	41	AAWS TC 054	15	AAWS WOMK 78	43
AAWS LS4209 G	37	AAWS OBS 72	41	AAWS TC 060	15	AAWS WOMK 84	43
AAWS LS4212	38	AAWS OBS 78	41	AAWS TC 066	15	AAWS WOMK 90	43
AAWS LS4809 G	37	AAWS OBS 84	41	AAWS TC 072	15	AAWS WOMK 96	43
AAWS LS4812	38	AAWS OBS 90	41	AAWS TC 078	15	AAWSIL106	21
AAWS LS5409 G	37	AAWS OBS 96	41	AAWS TC 084	15	AAWSIL114	21
AAWS LS5412	38	AAWS OGD 18L	42	AAWS TC 090	15	AAWSIL144	21
AAWS LS6009 G	37	AAWS OGD 18R	42	AAWS TC 096	15	AAWSIL69	21
AAWS LS6012	38	AAWS OGD 24	42	AAWS TC 102	15	AAWSIL84	21

<i>pattern no.</i>	<i>page</i>	<i>pattern no.</i>	<i>page</i>	<i>pattern no.</i>	<i>page</i>	<i>pattern no.</i>	<i>page</i>
AAWSIL91	21	ACAL4226	159	ACER4930	165	ACHR6424W	173
AAWSIL99	21	ACAL4230	159	ACER4932	165	ACHR6426M	172
AAWSILO69	21	ACAL4232	159	ACER6424	165	ACHR6426W	173
AAWSILO84	21	ACAL4924	159	ACER6426	166	ACHR6430M	172
AAWSOL106	21	ACAL4926	159	ACER6430	165	ACHR6430W	173
AAWSOL114	21	ACAL4930	159	ACER6432	166	ACHR6432M	172
AAWSOL144	21	ACAL4932	159	ACF	259	ACHR6432W	173
AAWSOL69	21	ACAR4224	159	ACFG	259	ACIL4930	169
AAWSOL84	21	ACAR4226	159	ACFL4924	167	ACIL4932	169
AAWSOL91	21	ACAR4230	159	ACFL4926	167	ACIL6430	170
AAWSOL99	21	ACAR4232	159	ACFL4930	167	ACIL6432	170
AAWSOLO69	21	ACAR4924	159	ACFL4932	167	ACIR4930	169
AAWSOLO84	21	ACAR4926	159	ACFL6424	167	ACIR4932	169
ABI AC24	245	ACAR4930	159	ACFL6426	167	ACIR6430	170
ABI-ABC24	245	ACAR4932	159	ACFL6430	167	ACIR6432	170
ABIAS27	248	ACBL4224	160	ACFL6432	167	ACJ722WE	176
ABIAS28	248	ACBL4226	160	ACFR4924	167	ACJ723WE	176
ABIAS30	248	ACBL4230	160	ACFR4926	167	ACJ822WE	176
ABIASC27	248	ACBL4232	160	ACFR4930	167	ACJ823WE	176
ABIASC28	248	ACBL4924	160	ACFR4932	167	ACKL722WE	177
ABIASC30	248	ACBL4926	160	ACFR6424	167	ACKL723WE	177
ABIAW27	248	ACBL4930	160	ACFR6426	168	ACKL822WE	177
ABIAW28	248	ACBL4932	160	ACFR6430	167	ACKL823WE	177
AB2 AE	245	ACBR4224	160	ACFR6432	168	ACKR722WE	177
AB2 FE27	245	ACBR4226	160	ACGL4924	171	ACKR723WE	177
AB2 FE28	245	ACBR4230	160	ACGL4926	171	ACKR822WE	177
ABAC3423	249	ACBR4232	160	ACGL4930	171	ACKR823WE	177
ABAC3429	249	ACBR4924	160	ACGL4932	171	ACL722M	177
ABAC4023	249	ACBR4926	160	ACGL6424	171	ACL722W	177
ABAC4029	249	ACBR4930	160	ACGL6426	171	ACL723M	177
ABAC4623	249	ACBR4932	160	ACGL6430	171	ACL723W	177
ABAC4629	249	ACCL4224	161	ACGL6432	171	ACL822M	177
ABAC5223	249	ACCL4226	161	ACGR4924	171	ACL822W	177
ABAC5229	249	ACCL4230	161	ACGR4926	171	ACL823M	177
ABAC5823	249	ACCL4232	161	ACGR4930	171	ACL823W	177
ABAC5829	249	ACCL4924	161	ACGR4932	171	ACMCL	260
ABAC6423	249	ACCL4926	161	ACGR6424	171	ACMML722	178
ABAC6429	249	ACCL4930	161	ACGR6426	171	ACMML723	178
ABAC7023	249	ACCL4932	161	ACGR6430	171	ACMML822	178
ABAC7029	249	ACCR4224	161	ACGR6432	171	ACMML823	178
ABAT4629	249	ACCR4226	161	ACHL4924M	172	ACMMR722	178
ABAT5229	249	ACCR4230	161	ACHL4924W	173	ACMMR723	178
ABAT5829	249	ACCR4232	161	ACHL4926M	172	ACMMR822	178
ABAT6429	249	ACCR4924	161	ACHL4926W	173	ACMMR823	178
ABAT7029	249	ACCR4926	161	ACHL4930M	172	ACMWL722	178
AC1 39L2	85	ACCR4930	161	ACHL4930W	173	ACMWL723	178
AC1 39T3	85	ACCR4932	161	ACHL4932M	172	ACMWL822	178
AC1 39V2	85	ACDL4924	162	ACHL4932W	173	ACMWL823	178
AC1 39X4	85	ACDL4926	162	ACHL6424M	172	ACMWR722	178
AC1 39Y3	85	ACDL4930	162	ACHL6424W	173	ACMWR723	178
AC1 48L2	85	ACDL4932	162	ACHL6426M	172	ACMWR822	178
AC1 48T3	85	ACDR4924	162	ACHL6426W	173	ACMWR823	178
AC1 48V2	85	ACDR4926	162	ACHL6430M	172	ACW722	179
AC1 48X4	85	ACDR4930	162	ACHL6430W	173	ACW723	179
AC1 48Y3	86	ACDR4932	162	ACHL6432M	172	ACW822	179
AC1 64L2	85	ACEL4924	165	ACHL6432W	173	ACW823	179
AC1 64T3	85	ACEL4926	165	ACHR4924M	172	ACWJ(L/R)4224	163
AC1 64V2	85	ACEL4930	165	ACHR4924W	173	ACWJ(L/R)4226	163
AC1 64X4	85	ACEL4932	165	ACHR4926M	172	ACWJ(L/R)4230	163
AC1 64Y3	86	ACEL6424	165	ACHR4926W	173	ACWJ(L/R)4232	163
ACA1 30E1	86	ACEL6426	165	ACHR4930M	172	ACWJ(L/R)4924	163
ACA1 39E1	86	ACEL6430	165	ACHR4930W	173	ACWJ(L/R)4926	163
ACA1 48E1	86	ACEL6432	165	ACHR4932M	172	ACWJ(L/R)4930	163
ACA1 64E1	86	ACER4924	165	ACHR4932W	173	ACWJ(L/R)4932	163
ACAL4224	159	ACER4926	165	ACHR6424M	172	ACWJ(L/R)6424	163

<i>pattern no.</i>	<i>page</i>	<i>pattern no.</i>	<i>page</i>	<i>pattern no.</i>	<i>page</i>	<i>pattern no.</i>	<i>page</i>
ACWJ(L/R)6426	163	ADHMH9634	254	AFPH13(E/P)(L/N)(W)	190	AHLTTE18	127
ACWJ(L/R)6430	163	ADHMH9640	253	AFPH14(E/P)(L/N)(W)	190	AHLTTE20	127
ACWJ(L/R)6432	163	ADS 0821	55	AFPH22(E/P)(L/N)(W)	190	AHLTTE24	127
ACWK(L/R)4224	164	ADS 0824	55	AFPH23(E/P)(L/N)(W)	190	AHLTTE30	127
ACWK(L/R)4226	164	ADS 0833	55	AFPH24(E/P)(L/N)(W)	190	AHLTTE36	127
ACWK(L/R)4230	164	ADS 0836	55	AFPHD12(E/P)	192	AHLTTE42	127
ACWK(L/R)4232	164	ADS 0845	55	AFPHD13(E/P)	192	AHLTTE48	127
ACWK(L/R)4924	164	ADS 0848	55	AFPHD22(E/P)	192	ALIT5E19S	218
ACWK(L/R)4926	164	ADS 0857	55	AFPHD23(E/P)	192	ALIT5E25A	218
ACWK(L/R)4930	164	ADS 0860	55	AFPHL10(E/P)(L/N)(W)	190	ALIT5E25S	218
ACWK(L/R)4932	164	ADS 0869	55	AFPHL11(E/P)(L/N)(W)	190	ALIT5E37A	218
ACWK(L/R)6424	164	ADS 0872	55	AFPHL20(E/P)(L/N)(W)	190	ALIT5E37S	218
ACWK(L/R)6426	164	AFB16	191	AFPHL21(E/P)(L/N)(W)	190	ALIT5E49A	218
ACWK(L/R)6430	164	AFB19	191	AFPHR10(E/P)(L/N)(W)	190	ALIT5E49S	218
ACWK(L/R)6432	164	AFB30	191	AFPHR11(E/P)(L/N)(W)	190	ALIT5E61A	218
ADHMH7210	253	AFB36	191	AFPHR20(E/P)(L/N)(W)	190	ALIT5E61S	218
ADHMH7211	253	AFB42	191	AFPHR21(E/P)(L/N)(W)	190	ALIT5E73A	218
ADHMH7212	253	AFB60	191	AFPR10(E/P)	192, 193	ALIT5E73S	218
ADHMH7220	253	AFB72	191	AFPR11(E/P)	192, 193	ALIT5E85A	218
ADHMH7222	253	AFB84	191	AFPR12(E/P)	192, 193	ALIT5E85S	218
ADHMH7230	253	AFB90	191	AFPR13(E/P)	192, 193	AL4L17	218
ADHMH7240	253	AFB96	191	AFPR20(E/P)	192, 193	AL4L31	218
ADHMH7810	253	AFPA12	192	AFPR21(E/P)	192, 193	AL4L44	218
ADHMH7811	253	AFPA13	192	AFPR22(E/P)	192, 193	AL4L58	218
ADHMH7812	253	AFPA22	192	AFPR23(E/P)	192, 193	ALBL24	251
ADHMH7813	253	AFPA23	192	AG1B	75	ALBL30	251
ADHMH7820	253	AFPB10(E/P)(M)	188	AG1B3920	88	ALBL36	251
ADHMH7822	253	AFPB10(E/P)(W)	186	AG1B3924	88	ALBR24	251
ADHMH7823	253	AFPB11(E/P)(M)	188	AG1B3930	88	ALBR30	251
ADHMH7830	253	AFPB11(E/P)(W)	186	AG1B3936	88	ALBR36	251
ADHMH7840	253	AFPB20(E/P)(M)	188	AG1B3942	88	AMB42E604	142
ADHMH8410	253	AFPB20(E/P)(W)	186	AG1B3948	88	AMB42E605	142
ADHMH8411	253	AFPB21(E/P)(M)	188	AG1B3954	88	AMB42E664	142
ADHMH8412	253	AFPB21(E/P)(W)	186	AG1B3960	88	AMB42E665	142
ADHMH8413	253	AFPB30(E/P)(M)	188	AG1B3966	88	AMB42E724	142
ADHMH8414	253	AFPB30(E/P)(W)	186	AG1B3972	88	AMB42E725	142
ADHMH8420	253	AFPB31(E/P)(M)	188	AG1B3978	88	AMB42E784	142
ADHMH8422	253	AFPB31(E/P)(W)	186	AG1B3984	88	AMB42E785	142
ADHMH8423	253	AFPE12(L/R)(E/P)	194	AG1B3990	88	AMB42E844	142
ADHMH8424	253	AFPE13(L/R)(E/P)	194	AG1B3996	88	AMB42E845	142
ADHMH8430	253	AFPE22(L/R)(E/P)	194	AG1B4920	88	AMB42E904	142
ADHMH8440	253	AFPE23(L/R)(E/P)	194	AG1B4924	88	AMB42E905	142
ADHMH9010	253	AFPF10(E/P)(M)	188	AG1B4930	88	AMB42E964	142
ADHMH9011	253	AFPF10(E/P)(W)	186	AG1B4936	88	AMB42E965	142
ADHMH9012	253	AFPF11(E/P)(M)	188	AG1B4942	88	AMB42L424	138
ADHMH9013	253	AFPF11(E/P)(W)	186	AG1B4948	88	AMB42L425	139
ADHMH9014	253	AFPF12(E/P)(M)	188	AG1B4954	88	AMB42L484	138
ADHMH9020	253	AFPF12(E/P)(W)	186	AG1B4960	88	AMB42L485	139
ADHMH9022	254	AFPF13(E/P)(M)	188	AG1B4966	88	AMB42L544	138
ADHMH9023	254	AFPF13(E/P)(W)	186	AG1B4972	88	AMB42L545	139
ADHMH9024	254	AFPF14(E/P)(W)	186	AG1B4978	88	AMB42L604	138
ADHMH9030	253	AFPF20(E/P)(M)	188	AG1B4984	88	AMB42L605	139
ADHMH9033	254	AFPF20(E/P)(W)	186	AG1B4990	88	AMB42L664	138
ADHMH9040	253	AFPF21(E/P)(M)	188	AG1B4996	88	AMB42L665	139
ADHMH9610	253	AFPF21(E/P)(W)	186	AHHSM36	252	AMB42L724	138
ADHMH9611	254	AFPF22(E/P)(M)	188	AHHSM42	252	AMB42L725	139
ADHMH9612	254	AFPF22(E/P)(W)	186	AHHSM48	252	AMB42L784	138
ADHMH9613	254	AFPF23(E/P)(M)	188	AHHSM54	252	AMB42L785	139
ADHMH9614	254	AFPF23(E/P)(W)	186	AHHSM60	252	AMB42L844	138
ADHMH9620	253	AFPF24(E/P)(W)	186	AHHSM66	252	AMB42L845	139
ADHMH9622	254	AFPF30(E/P)(M)	188	AHHSM72	252	AMB42L904	138
ADHMH9623	254	AFPF30(E/P)(W)	186	AHHSM78	252	AMB42L905	139
ADHMH9624	254	AFPF31(E/P)(M)	188	AHHSM84	252	AMB42L964	138
ADHMH9630	253	AFPF31(E/P)(W)	186	AHHSM90	252	AMB42L965	139
ADHMH9633	254	AFPH12(E/P)(L/N)(W)	190	AHHSM96	252	AMB42R424	138

<i>pattern no.</i>	<i>page</i>	<i>pattern no.</i>	<i>page</i>	<i>pattern no.</i>	<i>page</i>	<i>pattern no.</i>	<i>page</i>
AMB42R425	139	AMBR784	146	AMGE665	151	AOB4254	154
AMB42R484	138	AMBR785	147	AMGE724	151	AOB4260	154
AMB42R485	139	AMBR844	146	AMGE725	151	AOB4266	154
AMB42R544	138	AMBR845	147	AMGE784	151	AOB4272	154
AMB42R545	139	AMBR904	146	AMGE785	151	AOB4278	154
AMB42R604	138	AMBR905	147	AMGE844	151	AOBS42	155
AMB42R605	139	AMBR964	146	AMGE845	151	AOBS48	155
AMB42R664	138	AMBR965	147	AMGE904	151	AOBS54	155
AMB42R665	139	AMC42E604	143	AMGE905	151	AOBS60	155
AMB42R724	138	AMC42E605	143	AMGE964	151	AOBS66	155
AMB42R725	139	AMC42E664	143	AMGE965	151	AOBS72	155
AMB42R784	138	AMC42E665	143	AMGL424	148	AOBS78	155
AMB42R785	139	AMC42E724	143	AMGL425	149	APIL 3018 N	82
AMB42R844	138	AMC42E725	143	AMGL484	148	APIL 3024 N	82
AMB42R845	139	AMC42E784	143	AMGL485	149	APIL 3030 N	82
AMB42R904	138	AMC42E785	143	AMGL544	148	APIL 3036 N	82
AMB42R905	139	AMC42E844	143	AMGL545	149	APIL 3042 N	82
AMB42R964	138	AMC42E845	143	AMGL604	148	APIL 3048 N	82
AMB42R965	139	AMC42E904	143	AMGL605	149	APIL 3060 N	82
AMBE604	150	AMC42E905	143	AMGL664	148	APIL 3072 N	82
AMBE605	150	AMC42E964	143	AMGL665	149	APIL 3918 N	82
AMBE664	150	AMC42E965	143	AMGL724	148	APIL 3918G	83
AMBE665	150	AMC42L424	140	AMGL725	149	APIL 3924 N	82
AMBE724	150	AMC42L425	141	AMGL784	148	APIL 3924G	83
AMBE725	150	AMC42L484	140	AMGL785	149	APIL 3930 N	82
AMBE784	150	AMC42L485	141	AMGL844	148	APIL 3930G	83
AMBE785	150	AMC42L544	140	AMGL845	149	APIL 3936 N	82
AMBE844	150	AMC42L545	141	AMGL904	148	APIL 3936G	83
AMBE845	150	AMC42L604	140	AMGL905	149	APIL 3942 N	82
AMBE904	150	AMC42L605	141	AMGL964	148	APIL 3942G	83
AMBE905	150	AMC42L664	140	AMGL965	149	APIL 3948 N	82
AMBE964	150	AMC42L665	141	AMGR424	148	APIL 3948G	83
AMBE965	150	AMC42L724	140	AMGR425	149	APIL 3960 N	82
AMBL424	146	AMC42L725	141	AMGR484	148	APIL 3972 N	82
AMBL425	147	AMC42L784	140	AMGR485	149	APIL 4818 N	82
AMBL484	146	AMC42L785	141	AMGR544	148	APIL 4818G	83
AMBL485	147	AMC42L844	140	AMGR545	149	APIL 4824 N	82
AMBL544	146	AMC42L845	141	AMGR604	148	APIL 4824G	83
AMBL545	147	AMC42L904	140	AMGR605	149	APIL 4830 N	82
AMBL604	146	AMC42L905	141	AMGR664	148	APIL 4830G	83
AMBL605	147	AMC42L964	140	AMGR665	149	APIL 4836 N	82
AMBL664	146	AMC42L965	141	AMGR724	148	APIL 4836G	83
AMBL665	147	AMC42R424	140	AMGR725	149	APIL 4842 N	82
AMBL724	146	AMC42R425	141	AMGR784	148	APIL 4842G	83
AMBL725	147	AMC42R484	140	AMGR785	149	APIL 4848 N	82
AMBL784	146	AMC42R485	141	AMGR844	148	APIL 4848G	83
AMBL785	147	AMC42R544	140	AMGR845	149	APIL 4860 N	82
AMBL844	146	AMC42R545	141	AMGR904	148	APIL 4872 N	82
AMBL845	147	AMC42R604	140	AMGR905	149	APIL 6418 A	82
AMBL904	146	AMC42R605	141	AMGR964	148	APIL 6418G	83
AMBL905	147	AMC42R664	140	AMGR965	149	APIL 6424 A	82
AMBL964	146	AMC42R665	141	AMGTTA	158	APIL 6424G	83
AMBL965	147	AMC42R724	140	AMGTTB	158	APIL 6430 A	82
AMBR424	146	AMC42R725	141	AMGTTC	158	APIL 6430G	83
AMBR425	147	AMC42R784	140	AMGTTD	158	APIL 6436 A	82
AMBR484	146	AMC42R785	141	AMPB10(E/P)(M)	189	APIL 6436G	83
AMBR485	147	AMC42R844	140	AMPB10(E/P)(W)	187	APIL 6442 A	82
AMBR544	146	AMC42R845	141	AMPB11(E/P)(M)	189	APIL 6442G	83
AMBR545	147	AMC42R904	140	AMPB11(E/P)(W)	187	APIL 6448 A	82
AMBR604	146	AMC42R905	141	AMPB20(E/P)(M)	189	APIL 6448G	83
AMBR605	147	AMC42R964	140	AMPB20(E/P)(W)	187	APIL 6460 A	82
AMBR664	146	AMC42R965	141	AMPB21(E/P)(M)	189	AP1W 1624G	84
AMBR665	147	AMCE604	151	AMPB21(E/P)(W)	187	AP1W 1630G	84
AMBR724	146	AMCE605	151	AOB4242	154	AP1W 1636G	84
AMBR725	147	AMCE664	151	AOB4248	154	AP1W 1642G	84

<i>pattern no.</i>	<i>page</i>	<i>pattern no.</i>	<i>page</i>	<i>pattern no.</i>	<i>page</i>	<i>pattern no.</i>	<i>page</i>
APIW 1648G	84	APCA 1812 A	57	APHOB072	201	APHOGS60	204
APIW 1660G	84	APCA 1824	56	APHOB078	201	APHOGS66	204
APIW 1672G	84	APCA 1824 A	57	APHOB084	201	APHOGS72	204
APIW 1824G	84	APCA 1836	56	APHOB090	201	APHOGS78	204
APIW 1830G	84	APCA 1836 A	57	APHOB096	201	APHOGS84	204
APIW 1836G	84	APCA 1848	56	APHOBR42	205	APHOGS90	204
APIW 1842G	84	APCA 1848 A	57	APHOBR48	205	APHOGS96	204
APIW 1848G	84	APCA 1860	56	APHOBR54	205	APHOCT60	203
APIW 1860G	84	APCA 1860 A	57	APHOBR60	205	APHOCT66	203
APIW 1872G	84	APCA 1872	56	APHOBR66	205	APHOCT72	203
APIW 2224G	84	APCA 1872 A	57	APHOBR72	205	APHOCT78	203
APIW 2230G	84	APCA 2712	56	APHOBR78	205	APHOCT84	203
APIW 2236G	84	APCA 2712 A	57	APHOBR84	205	APHOCT90	203
APIW 2242G	84	APCA 2724	56	APHOBR90	205	APHOCT96	203
APIW 2248G	84	APCA 2724 A	57	APHOBR96	205	APLP10	129
APIW 2260G	84	APCA 2736	56	APHOBS42	204	APLP25	129
APIW 2272G	84	APCA 2736 A	57	APHOBS48	204	APRA 480	49
APIW 2524G	84	APCA 2748	56	APHOBS54	204	APRA 600	49
APIW 2530G	84	APCA 2748 A	57	APHOBS60	204	APRA 720	49
APIW 2536G	84	APCA 2760	56	APHOBS66	204	APRT1L2ST(L/R)6036	235
APIW 2542G	84	APCA 2760 A	57	APHOBS72	204	APRT2L1PC(L/R)6030	236
APIW 2548G	84	APCA 2772	56	APHOBS78	204	APRT2L1PC(L/R)6036	236
APIW 2560G	84	APCA 2772 A	57	APHOBS84	204	APRT2L1PC(L/R)6630	236
APIW 2572G	84	APCA AZ48	52	APHOBS90	204	APRT2L1PC(L/R)6636	236
APA 39	47	APCA AZ48S	51	APHOBS96	204	APRT2L1PC(L/R)7230	236
APA 48	47	APCA AZ60	52	APHOBT60	203	APRT2L1PC(L/R)7236	236
APA 64	47	APCA AZ60S	51	APHOBT66	203	APRT2L1PC(L/R)7830	236
APA1 LF	87	APCA AZ72	52	APHOBT72	203	APRT2L1PC(L/R)7836	236
APCA 0912	56	APCA AZ72S	51	APHOBT78	203	APRT2L1PC(L/R)8430	236
APCA 0912 A	57	APCA HOC	54	APHOBT84	203	APRT2L1PC(L/R)8436	236
APCA 0912 C	53	APCA OC	53	APHOBT90	203	APRT2L1PC(L/R)9030	236
APCA 0912 S	53	APCST	259	APHOBT96	203	APRT2L1PC(L/R)9036	236
APCA 0924	56	APF1 3948	47	APHOGD42	202	APRT2L1PC(L/R)9630	236
APCA 0924 A	57	APF1 3960	47	APHOGD48	202	APRT2L1PC(L/R)9636	236
APCA 0924 C	53	APF1 3972	47	APHOGD54	202	APRT2L1ST(L/R)6030	235
APCA 0924 S	53	APF1 4848	47	APHOGD60	202	APRT2L1ST(L/R)6036	235
APCA 0936	56	APF1 4860	47	APHOGD66	202	APRT2L1ST(L/R)6630	235
APCA 0936 A	57	APF1 4872	47	APHOGD72	202	APRT2L1ST(L/R)6636	235
APCA 0936 C	53	APF1 6448	47	APHOGD78	202	APRT2L1ST(L/R)7230	235
APCA 0936 S	53	APF1 6460	47	APHOGD84	202	APRT2L1ST(L/R)7236	235
APCA 0948	56	APF1 6472	47	APHOGD90	202	APRT2L1ST(L/R)7830	235
APCA 0948 A	57	APFA1 3948	47	APHOGD96	202	APRT2L1ST(L/R)7836	235
APCA 0948 C	53	APFA1 3960	47	APHOGO42	201	APRT2L1ST(L/R)8430	235
APCA 0948 S	53	APFA1 3972	47	APHOGO48	201	APRT2L1ST(L/R)8436	235
APCA 0960	56	APFA1 4848	47	APHOGO54	201	APRT2L1ST(L/R)9030	235
APCA 0960 A	57	APFA1 4860	47	APHOGO60	201	APRT2L1ST(L/R)9036	235
APCA 0960 C	53	APFA1 4872	47	APHOGO66	201	APRT2L1ST(L/R)9630	235
APCA 0960 S	53	APFA1 6448	47	APHOGO72	201	APRT2L1ST(L/R)9636	235
APCA 0972	56	APFA1 6460	47	APHOGO78	201	APRT2L2PC(L/R)6030	236
APCA 0972 A	57	APFA1 6472	47	APHOGO84	201	APRT2L2PC(L/R)6036)	236
APCA 0972 C	53	APHOBD42	202	APHOGO90	201	APRT2L2PC(L/R)6630	236
APCA 0972 S	53	APHOBD48	202	APHOGO96	201	APRT2L2PC(L/R)6636	236
APCA 1612	56	APHOBD54	202	APHOGR42	205	APRT2L2PC(L/R)7230	236
APCA 1612 A	57	APHOBD60	202	APHOGR48	205	APRT2L2PC(L/R)7236	236
APCA 1624	56	APHOBD66	202	APHOGR54	205	APRT2L2PC(L/R)7830	236
APCA 1624 A	57	APHOBD72	202	APHOGR60	205	APRT2L2PC(L/R)7836	236
APCA 1636	56	APHOBD78	202	APHOGR66	205	APRT2L2PC(L/R)8430	236
APCA 1636 A	57	APHOBD84	202	APHOGR72	205	APRT2L2PC(L/R)8436	236
APCA 1648	56	APHOBD90	202	APHOGR78	205	APRT2L2PC(L/R)9030	236
APCA 1648 A	57	APHOBD96	202	APHOGR84	205	APRT2L2PC(L/R)9036	236
APCA 1660	56	APHOBO42	201	APHOGR90	205	APRT2L2PC(L/R)9630	236
APCA 1660 A	57	APHOBO48	201	APHOGR96	205	APRT2L2PC(L/R)9636	236
APCA 1672	56	APHOBO54	201	APHOGS42	204	APRT2L2ST(L/R)6030	235
APCA 1672 A	57	APHOBO60	201	APHOGS48	204	APRT2L2ST(L/R)6630	235
APCA 1812	56	APHOBO66	201	APHOGS54	204	APRT2L2ST(L/R)6636	235

<i>pattern no.</i>	<i>page</i>	<i>pattern no.</i>	<i>page</i>	<i>pattern no.</i>	<i>page</i>	<i>pattern no.</i>	<i>page</i>
APRT2L2ST(L/R)7230	235	APRT2O2ST(L/R)9636	237	APSA 0969	55	AR1 EPH1	78
APRT2L2ST(L/R)7236	235	APRT2S1PC(L/R)6030	234	APSA 0972	55	AR1 EPH2	78
APRT2L2ST(L/R)7830	235	APRT2S1PC(L/R)6036	234	APSA 1621	55	AR1 EP15	78
APRT2L2ST(L/R)7836	235	APRT2S1PC(L/R)6630	234	APSA 1624	55	AR1 EPIC	78
APRT2L2ST(L/R)8430	235	APRT2S1PC(L/R)6636	234	APSA 1633	55	AR1 ET1	78
APRT2L2ST(L/R)8436	235	APRT2S1PC(L/R)7230	234	APSA 1636	55	AR1 ET3	78
APRT2L2ST(L/R)9030	235	APRT2S1PC(L/R)7236	234	APSA 1645	55	AR1 ET5	78
APRT2L2ST(L/R)9036	235	APRT2S1PC(L/R)7830	234	APSA 1648	55	AR1 ET8	78
APRT2L2ST(L/R)9630	235	APRT2S1PC(L/R)7836	234	APSA 1657	55	AR1 HCC H10	80
APRT2L2ST(L/R)9636	235	APRT2S1PC(L/R)8430	234	APSA 1660	55	AR1 HOB	54
APRT2O1PC(L/R)6030	238	APRT2S1PC(L/R)8436	234	APSA 1669	55	AR1 HOB2	54
APRT2O1PC(L/R)6036	238	APRT2S1PC(L/R)9030	234	APSA 1672	55	AR1 PCC 100	80
APRT2O1PC(L/R)6630	238	APRT2S1PC(L/R)9036	234	APT	49	AR1 TJ1	79
APRT2O1PC(L/R)6636	238	APRT2S1PC(L/R)9630	234	APT 48	48	AR1 TJ10	79
APRT2O1PC(L/R)7230	238	APRT2S1PC(L/R)9636	234	APT 60	48	AR1 TJ12	79
APRT2O1PC(L/R)7236	238	APRT2S1ST(L/R)6030	233	APT 72	48	AR1 TJ2	79
APRT2O1PC(L/R)7830	238	APRT2S1ST(L/R)6036	233	APT1 C24	49	AR1 TJ3	79
APRT2O1PC(L/R)7836	238	APRT2S1ST(L/R)6630	233	APT1 C36	49	AR1 TJ4	79
APRT2O1PC(L/R)8430	238	APRT2S1ST(L/R)6636	233	APT1 C48	49	AR1 TJ5	79
APRT2O1PC(L/R)8436	238	APRT2S1ST(L/R)7230	233	APT1 C60	49	AR1 TJ6	79
APRT2O1PC(L/R)9030	238	APRT2S1ST(L/R)7236	233	APT1 C72	49	AR1 TJ8	79
APRT2O1PC(L/R)9036	238	APRT2S1ST(L/R)7830	233	APTA 48	48	AR1 TOM	79
APRT2O1PC(L/R)9630	238	APRT2S1ST(L/R)7836	233	APTA 60	48	AR1 TPH1	79
APRT2O1PC(L/R)9636	238	APRT2S1ST(L/R)8430	233	APTA 72	48	AR1 TPH2	79
APRT2O1ST(L/R)6030	237	APRT2S1ST(L/R)8436	233	APTA C24	49	AR1 TPI5	79
APRT2O1ST(L/R)6036	237	APRT2S1ST(L/R)9030	233	APTA C36	49	AR1 TPIC	79
APRT2O1ST(L/R)6630	237	APRT2S1ST(L/R)9036	233	APTA C48	49	AR1 TT1	79
APRT2O1ST(L/R)6636	237	APRT2S1ST(L/R)9630	233	APTA C60	49	AR1 TT3	79
APRT2O1ST(L/R)7230	237	APRT2S1ST(L/R)9636	233	APTA C72	49	AR1 TT5	79
APRT2O1ST(L/R)7236	237	APRT2S2PC(L/R)6030	234	APTA CC	49	AR1 TT8	79
APRT2O1ST(L/R)7830	237	APRT2S2PC(L/R)6036	234	APTA CC1	49	AR1-ELS-B	78, 79
APRT2O1ST(L/R)7836	237	APRT2S2PC(L/R)6630	234	APTH	50	AS1 BKH	185
APRT2O1ST(L/R)8430	237	APRT2S2PC(L/R)6636	234	APTH 120	48	AS1 BKL	185
APRT2O1ST(L/R)8436	237	APRT2S2PC(L/R)7230	234	APTH 48	48	AS1 DPAD	183, 184
APRT2O1ST(L/R)9030	237	APRT2S2PC(L/R)7236	234	APTH 60	48	AS1 SPAD	183, 184
APRT2O1ST(L/R)9036	237	APRT2S2PC(L/R)7830	234	APTH 72	48	AS2 PT(C)	185
APRT2O1ST(L/R)9630	237	APRT2S2PC(L/R)7836	234	APTH 96	48	AS2 PT(N)	185
APRT2O1ST(L/R)9636	237	APRT2S2PC(L/R)8430	234	APTL	50	ASAMP1616	224
APRT2O2PC(L/R)6030	238	APRT2S2PC(L/R)8436	234	APTL 120	48	ASBC18 (L/R)	247
APRT2O2PC(L/R)6036)	238	APRT2S2PC(L/R)9030	234	APTL 48	48	ASBC24 (L/R)	247
APRT2O2PC(L/R)6630	238	APRT2S2PC(L/R)9036	234	APTL 60	48	ASBF1 36	195
APRT2O2PC(L/R)6636	238	APRT2S2PC(L/R)9630	234	APTL 72	48	ASBF1 42	195
APRT2O2PC(L/R)7230	238	APRT2S2PC(L/R)9636	234	APTL 96	48	ASBF1 48	195
APRT2O2PC(L/R)7236	238	APRT2S2ST(L/R)6030	233	APTL 26	248	ASBS1 36	195
APRT2O2PC(L/R)7830	238	APRT2S2ST(L/R)6036	233	APTL 27	248	ASBS1 42	195
APRT2O2PC(L/R)7836	238	APRT2S2ST(L/R)6630	233	APTL 28	248	ASBS1 48	195
APRT2O2PC(L/R)8430	238	APRT2S2ST(L/R)6636	233	APX CIP4	80	ASBT1 36	195
APRT2O2PC(L/R)8436	238	APRT2S2ST(L/R)7230	233	APX CIP6	80	ASBT1 42	195
APRT2O2PC(L/R)9030	238	APRT2S2ST(L/R)7236	233	APX CIP8	80	ASBT1 48	195
APRT2O2PC(L/R)9036	238	APRT2S2ST(L/R)7830	233	AR1 DA	78, 79	ASFS1FF18	181
APRT2O2PC(L/R)9630	238	APRT2S2ST(L/R)7836	233	AR1 DB	78, 79	ASFS1FF24	181
APRT2O2PC(L/R)9636	238	APRT2S2ST(L/R)8430	233	AR1 DC	79	ASFS1PDF18	181
APRT2O2ST(L/R)6030	237	APRT2S2ST(L/R)8436	233	AR1 DX	78, 79	ASFS1PDF24	181
APRT2O2ST(L/R)6036	237	APRT2S2ST(L/R)9030	233	AR1 DY	78, 79	ASFS1WDD30	181
APRT2O2ST(L/R)6630	237	APRT2S2ST(L/R)9036	233	AR1 DZ	79	ASFS1WDD36	181
APRT2O2ST(L/R)6636	237	APRT2S2ST(L/R)9630	233	AR1 EJ1	78	ASFS1WDF30	181
APRT2O2ST(L/R)7230	237	APRT2S2ST(L/R)9636	233	AR1 EJ10	78	ASFS1WDF36	181
APRT2O2ST(L/R)7236	237	APSA 0921	55	AR1 EJ12	78	ASFS1WFF30	181
APRT2O2ST(L/R)7830	237	APSA 0924	55	AR1 EJ2	78	ASFS1WFF36	181
APRT2O2ST(L/R)7836	237	APSA 0933	55	AR1 EJ3	78	ASFS1WPDF30	181
APRT2O2ST(L/R)8430	237	APSA 0936	55	AR1 EJ4	78	ASFS1WPDF36	181
APRT2O2ST(L/R)8436	237	APSA 0945	55	AR1 EJ5	78	ASM42MB42	144
APRT2O2ST(L/R)9030	237	APSA 0948	55	AR1 EJ6	78	ASM42MB48	144
APRT2O2ST(L/R)9036	237	APSA 0957	55	AR1 EJ8	78	ASM42MB54	144
APRT2O2ST(L/R)9630	237	APSA 0960	55	AR1 EOM	78	ASM42MB60	144

<i>pattern no.</i>	<i>page</i>	<i>pattern no.</i>	<i>page</i>	<i>pattern no.</i>	<i>page</i>	<i>pattern no.</i>	<i>page</i>
ASM42MB66	144	ASMWB48	152	ASOBT96	198	ASWM84	257
ASM42MB72	144	ASMWB54	152	ASOGD42	197	ASWM90	257
ASM42MB78	144	ASMWB60	152	ASOGD48	197	ASWM96	257
ASM42MB84	144	ASMWB66	152	ASOGD54	197	ASWRB42	110
ASM42MB90	144	ASMWB72	152	ASOGD60	197	ASWRB49	110
ASM42MB96	144	ASMWB78	152	ASOGD66	197	ASWRB64	110
ASM42MG42	145	ASMWB84	152	ASOGD72	197	ASWRB79	110
ASM42MG48	145	ASMWB90	152	ASOGD78	197	AT2TB (pair)	247
ASM42MG54	145	ASMWB96	152	ASOGD84	197	ATA1R36	239
ASM42MG60	145	ASMWC42	153	ASOGD90	197	ATA1R42	239
ASM42MG66	145	ASMWC48	153	ASOGD96	197	ATA1R48	239
ASM42MG72	145	ASMWC54	153	ASOGO42	196	ATA1T44242	239
ASM42MG78	145	ASMWC60	153	ASOGO48	196	ATA1T44830	239
ASM42MG84	145	ASMWC66	153	ASOGO54	196	ATA1T44848	239
ASM42MG90	145	ASMWC72	153	ASOGO60	196	ATA1T46030	239
ASM42MG96	145	ASMWC78	153	ASOGO66	196	ATA1T47230	239
ASM42WB42	144	ASMWC84	153	ASOGO72	196	ATA1T47236	239
ASM42WB48	144	ASMWC90	153	ASOGO78	196	ATARLL3627(L/M/V)	240
ASM42WB54	144	ASMWC96	153	ASOGO84	196	ATARLL3628(L/M/V)	240
ASM42WB60	144	ASOBD42	197	ASOGO90	196	ATARLL4227(L/M/V)	240
ASM42WB66	144	ASOBD48	197	ASOGO96	196	ATARLL4228(L/M/V)	240
ASM42WB72	144	ASOBD54	197	ASOGR42	200	ATARLL4827(L/M/V)	240
ASM42WB78	144	ASOBD60	197	ASOGR48	200	ATARLL4828(L/M/V)	240
ASM42WB84	144	ASOBD66	197	ASOGR54	200	ATAT4LL424227(L/M/V)	240
ASM42WB90	144	ASOBD72	197	ASOGR60	200	ATAT4LL424228(L/M/V)	240
ASM42WB96	144	ASOBD78	197	ASOGR66	200	ATAT4LL484827(L/M/V)	240
ASM42WC42	145	ASOBD84	197	ASOGR72	200	ATAT4LL484828(L/M/V)	240
ASM42WC48	145	ASOBD90	197	ASOGR78	200	ATB1426	256
ASM42WC54	145	ASOBD96	197	ASOGR84	200	ATB1432	256
ASM42WC60	145	ASOBO42	196	ASOGR90	200	ATB1442	256
ASM42WC66	145	ASOBO48	196	ASOGR96	200	ATB1448	256
ASM42WC72	145	ASOBO54	196	ASOCS42	199	ATB1454	256
ASM42WC78	145	ASOBO60	196	ASOCS48	199	ATB1460	256
ASM42WC84	145	ASOBO66	196	ASOCS54	199	ATB1466	256
ASM42WC90	145	ASOBO72	196	ASOCS60	199	ATB1472	256
ASM42WC96	145	ASOBO78	196	ASOCS66	199	ATB1478	256
ASMMB42	152	ASOBO84	196	ASOCS72	199	ATB1484	256
ASMMB48	152	ASOBO90	196	ASOCS78	199	ATB1490	256
ASMMB54	152	ASOBO96	196	ASOCS84	199	ATB1496	256
ASMMB60	152	ASOBR42	200	ASOCS90	199	ATBB42	256
ASMMB66	152	ASOBR48	200	ASOCS96	199	ATBB48	256
ASMMB72	152	ASOBR54	200	ASOCT60	198	ATBB54	256
ASMMB78	152	ASOBR60	200	ASOCT66	198	ATBB60	256
ASMMB84	152	ASOBR66	200	ASOCT72	198	ATBB66	256
ASMMB90	152	ASOBR72	200	ASOCT78	198	ATBB72	256
ASMMB96	152	ASOBR78	200	ASOCT84	198	ATBB78	256
ASMMG42	153	ASOBR84	200	ASOCT90	198	ATBM26	256
ASMMG48	153	ASOBR90	200	ASOCT96	198	ATBM32	256
ASMMG54	153	ASOBR96	200	AST	259	ATBM42	256
ASMMG60	153	ASOBS42	199	ASWB42	257	ATBM48	256
ASMMG66	153	ASOBS48	199	ASWB48	257	ATBM54	256
ASMMG72	153	ASOBS54	199	ASWB54	257	ATBM60	256
ASMMG78	153	ASOBS60	199	ASWB60	257	ATBM66	256
ASMMG84	153	ASOBS66	199	ASWB66	257	ATBM72	256
ASMMG90	153	ASOBS72	199	ASWB72	257	ATBM78	256
ASMMG96	153	ASOBS78	199	ASWB78	257	ATBM84	256
ASMS1 DF18	182	ASOBS84	199	ASWM26	257	ATBM90	256
ASMS1 DF24	182	ASOBS90	199	ASWM32	257	ATBM96	256
ASMS1 DFO18	182	ASOBS96	199	ASWM42	257	ATBT120	251
ASMS1 DFO24	182	ASOBT60	198	ASWM48	257	ATBT124	251
ASMS1 FF18	182	ASOBT66	198	ASWM54	257	ATBT130	251
ASMS1 FF24	182	ASOBT72	198	ASWM60	257	ATBT136	251
ASMS1 PDF18	182	ASOBT78	198	ASWM66	257	ATBT224	251
ASMS1 PDF24	182	ASOBT84	198	ASWM72	257	ATBT230	251
ASMWB42	152	ASOBT90	198	ASWM78	257	ATBT236	251

<i>pattern no.</i>	<i>page</i>	<i>pattern no.</i>	<i>page</i>	<i>pattern no.</i>	<i>page</i>	<i>pattern no.</i>	<i>page</i>
ATBT242	251	ATSBD60	156	AW1T1R3429	230	AW1T1RF9020	222
ATDT1LFM483027(L/M/V)	241	ATSBD66	156	AW1T1R4023	230	AW1T1RF9024	222
ATDT1LFM483028(L/M/V)	241	ATSBD72	156	AW1T1R4029	230	AW1T1RF9030	223
ATDT1LFM603027(L/M/V)	241	ATSBD78	156	AW1T1R4623	230	AW1T1RF9036	223
ATDT1LFM603028(L/M/V)	241	ATSBE42	156	AW1T1R4629	230	AW1T1RF9620	222
ATDT1LFM723027(L/M/V)	241	ATSBE48	156	AW1T1R5223	230	AW1T1RF9624	222
ATDT1LFM723028(L/M/V)	241	ATSBE54	156	AW1T1R5229	230	AW1T1RF9630	223
ATDT1LFM723627(L/M/V)	241	ATSBE60	157	AW1T1R5823	230	AW1T1RF9636	223
ATDT1LFM723628(L/M/V)	241	ATSBE66	157	AW1T1R5829	230	AW1T1RU1820	225
ATDT1LFS483027(L/M/V)	241	ATSBE72	157	AW1T1R6423	230	AW1T1RU1824	225
ATDT1LFS483028(L/M/V)	241	ATSBE78	157	AW1T1R6429	230	AW1T1RU1830	225
ATDT1LFS603027(L/M/V)	241	ATSCD19	175	AW1T1R7023	230	AW1T1RU2020	225
ATDT1LFS603028(L/M/V)	241	ATTA24L	243	AW1T1R7029	230	AW1T1RU2024	225
ATDT1LFS723027(L/M/V)	241	ATTA24R	243	AW1T1RF1820	222	AW1T1RU2030	225
ATDT1LFS723028(L/M/V)	241	ATTA24S	243	AW1T1RF1824	222	AW1T1RU2420	225
ATDT1LFS723627(L/M/V)	241	ATTA30L	243	AW1T1RF1830	223	AW1T1RU2424	225
ATDT1LFS723628(L/M/V)	241	ATTA30R	243	AW1T1RF1836	223	AW1T1RU2430	225
ATDT1LPM483027(L/M/V)	241	ATTA30S	243	AW1T1RF2020	222	AW1T1RU3020	225
ATDT1LPM483028(L/M/V)	241	ATTA36L	243	AW1T1RF2024	222	AW1T1RU3024	225
ATDT1LPM603027(L/M/V)	241	ATTA36R	243	AW1T1RF2030	223	AW1T1RU3030	226
ATDT1LPM603028(L/M/V)	241	ATTA36S	243	AW1T1RF2036	223	AW1T1RU3620	225
ATDT1LPM723027(L/M/V)	241	ATTA42L	243	AW1T1RF2420	222	AW1T1RU3624	225
ATDT1LPM723028(L/M/V)	241	ATTA42R	243	AW1T1RF2424	222	AW1T1RU3630	226
ATDT1LPM723627(L/M/V)	241	ATTA42S	243	AW1T1RF2430	223	AW1T1RU4220	225
ATDT1LPM723628(L/M/V)	241	ATTA48L	243	AW1T1RF2436	223	AW1T1RU4224	225
ATDT1LPS483027(L/M/V)	242	ATTA48R	243	AW1T1RF3020	222	AW1T1RU4230	226
ATDT1LPS483028(L/M/V)	242	ATTA48S	243	AW1T1RF3024	222	AW1T1RU4820	225
ATDT1LPS603027(L/M/V)	242	ATTA54L	243	AW1T1RF3030	223	AW1T1RU4824	225
ATDT1LPS603028(L/M/V)	242	ATTA54R	243	AW1T1RF3036	223	AW1T1RU4830	226
ATDT1LPS723027(L/M/V)	242	ATTA54S	243	AW1T1RF3620	222	AW1T1RU5420	225
ATDT1LPS723028(L/M/V)	242	ATTA60L	243	AW1T1RF3624	222	AW1T1RU5424	225
ATDT1LPS723627(L/M/V)	242	ATTA60R	243	AW1T1RF3630	223	AW1T1RU5430	226
ATDT1LPS723628(L/M/V)	242	ATTA60S	243	AW1T1RF3636	223	AW1T1RU6020	225
ATDT4LL483027(L/M/V)	240	ATTA66L	243	AW1T1RF4220	222	AW1T1RU6024	225
ATDT4LL483028(L/M/V)	240	ATTA66R	243	AW1T1RF4224	222	AW1T1RU6030	226
ATDT4LL603027(L/M/V)	240	ATTA66S	243	AW1T1RF4230	223	AW1T1RU6620	225
ATDT4LL603028(L/M/V)	240	ATTA72L	243	AW1T1RF4236	223	AW1T1RU6624	225
ATDT4LL723027(L/M/V)	240	ATTA72R	243	AW1T1RF4820	222	AW1T1RU6630	226
ATDT4LL723028(L/M/V)	240	ATTA72S	243	AW1T1RF4824	222	AW1T1RU7220	225
ATDT4LL723627(L/M/V)	240	AUA1 0824 G	81	AW1T1RF4830	223	AW1T1RU7224	225
ATDT4LL723628(L/M/V)	240	AUA1 0836 G	81	AW1T1RF4836	223	AW1T1RU7230	226
ATSBA42	156	AUA1 0848 G	81	AW1T1RF5420	222	AW1T1RU7820	225
ATSBA48	156	AUA1 0860 G	81	AW1T1RF5424	222	AW1T1RU7824	225
ATSBA54	156	AUA1 0872 G	81	AW1T1RF5430	223	AW1T1RU7830	226
ATSBA60	156	AUA1 1224 G	81	AW1T1RF5436	223	AW1T1RU8420	225
ATSBA66	156	AUA1 1236 G	81	AW1T1RF6020	222	AW1T1RU8424	225
ATSBA72	156	AUA1 1248 G	81	AW1T1RF6024	222	AW1T1RU8430	226
ATSBA78	156	AUA1 1260 G	81	AW1T1RF6030	223	AW1T1RU9020	225
ATSBB42	156	AUA1 1272 G	81	AW1T1RF6036	223	AW1T1RU9024	225
ATSBB48	156	AUA1 1524 G	81	AW1T1RF6620	222	AW1T1RU9030	226
ATSBB54	156	AUA1 1536 G	81	AW1T1RF6624	222	AW1T1RU9620	225
ATSBB60	156	AUA1 1548 G	81	AW1T1RF6630	223	AW1T1RU9624	225
ATSBB66	156	AUA1 1560 G	81	AW1T1RF6636	223	AW1T1RU9630	226
ATSBB72	156	AUA1 1572 G	81	AW1T1RF7220	222	AW1T1WF4823	224
ATSBB78	156	AUOMBAP2	206	AW1T1RF7224	222	AW1T1WF4832	224
ATSBC42	156	AUOMBAP3	206	AW1T1RF7230	223	AW1T1WF6023	224
ATSBC48	156	AUOMBCC2	206	AW1T1RF7236	223	AW1T1WF6032	224
ATSBC54	156	AUOMBCC3	206	AW1T1RF7820	222	AW1T1WF7226	224
ATSBC60	156	AUOMBSS62	206	AW1T1RF7824	222	AW1T1WF7262	224
ATSBC66	156	AUOMBSS63	206	AW1T1RF7830	223	AW1T1WU4823	227
ATSBC72	156	AUOMBSS72	206	AW1T1RF7836	223	AW1T1WU4832	227
ATSBC78	156	AUOMBSS73	206	AW1T1RF8420	222	AW1T1WU6023	227
ATSBD42	156	AUOMBSS92	206	AW1T1RF8424	222	AW1T1WU6032	227
ATSBD48	156	AUOMBSS93	206	AW1T1RF8430	223	AW1T1WU7226	227
ATSBD54	156	AW1T1R3423	230	AW1T1RF8436	223	AW1T1WU7262	227

<i>pattern no.</i>	<i>page</i>	<i>pattern no.</i>	<i>page</i>	<i>pattern no.</i>	<i>page</i>	<i>pattern no.</i>	<i>page</i>
AW1T2DW4826	232	AWBS72	155	AWHOBSD036	207	AWHOGDS72	214
AW1T2DW6026	232	AWBS78	155	AWHOBSD042	207	AWHOGDS78	214
AW1T2DW7226	232	AWBS84	155	AWHOBSD048	207	AWHOGDS84	214
AW1T2R3030	228	AWBS90	155	AWHOBSD054	207	AWHOGDS90	214
AW1T2R3036	228	AWBS96	155	AWHOBSD060	207	AWHOGDS96	214
AW1T2R3042	228	AWCPFS	191	AWHOBSD066	207	AWHOGDT60	213
AW1T2R3630	228	AWCPFS19	191	AWHOBSD072	207	AWHOGDT66	213
AW1T2R3636	228	AWHOBDD30	212	AWHOBSD078	207	AWHOGDT72	213
AW1T2R3642	228	AWHOBDD36	212	AWHOBSD084	207	AWHOGDT78	213
AW1T2R4230	228	AWHOBDD42	212	AWHOBSD090	207	AWHOGDT84	213
AW1T2R4236	228	AWHOBDD48	212	AWHOBSD096	207	AWHOGDT90	213
AW1T2R4242	228	AWHOBDD54	212	AWHOBSDR60	210	AWHOGDT96	213
AW1T2R4635	230	AWHOBDD60	212	AWHOBSDR66	210	AWHOGSD30	208
AW1T2R4830	228	AWHOBDD66	212	AWHOBSDR72	210	AWHOGSD36	208
AW1T2R4836	228	AWHOBDD72	212	AWHOBSDR78	210	AWHOGSD42	208
AW1T2R4842	228	AWHOBDD78	212	AWHOBSDR84	210	AWHOGSD48	208
AW1T2R5235	230	AWHOBDD84	212	AWHOBSDR90	210	AWHOGSD54	208
AW1T2R5430	228	AWHOBDD90	212	AWHOBSDR96	210	AWHOGSD60	208
AW1T2R5436	228	AWHOBDD96	212	AWHOBSS60	210	AWHOGSD66	208
AW1T2R5442	228	AWHOBDO30	211	AWHOBSS66	210	AWHOGSD72	208
AW1T2R5835	230	AWHOBDO36	211	AWHOBSS72	210	AWHOGSD78	208
AW1T2R6030	228	AWHOBDO42	211	AWHOBSS78	210	AWHOGSD84	208
AW1T2R6036	228	AWHOBDO48	211	AWHOBSS84	210	AWHOGSD90	208
AW1T2R6042	228	AWHOBDO54	211	AWHOBSS90	210	AWHOGSD96	208
AW1T2R6435	230	AWHOBDO60	211	AWHOBSS96	210	AWHOGSO30	207
AW1T2R6630	228	AWHOBDO66	211	AWHOBST60	209	AWHOGSO36	207
AW1T2R6636	228	AWHOBDO72	211	AWHOBST66	209	AWHOGSO42	207
AW1T2R6642	228	AWHOBDO78	211	AWHOBST72	209	AWHOGSO48	207
AW1T2R7035	230	AWHOBDO84	211	AWHOBST78	209	AWHOGSO54	207
AW1T2R7230	228	AWHOBDO90	211	AWHOBST84	209	AWHOGSO60	207
AW1T2R7236	228	AWHOBDO96	211	AWHOBST90	209	AWHOGSO66	207
AW1T2R7242	228	AWHOBDR60	214	AWHOBST96	209	AWHOGSO72	207
AW1T2R7830	228	AWHOBDR66	214	AWHOGDD30	212	AWHOGSO78	207
AW1T2R7836	228	AWHOBDR72	214	AWHOGDD36	212	AWHOGSO84	207
AW1T2R7842	228	AWHOBDR78	214	AWHOGDD42	212	AWHOGSO90	207
AW1T2R8430	228	AWHOBDR84	214	AWHOGDD48	212	AWHOGSO96	207
AW1T2R8436	228	AWHOBDR90	214	AWHOGDD54	212	AWHOGSR60	210
AW1T2R8442	229	AWHOBDR96	214	AWHOGDD60	212	AWHOGSR66	210
AW1T2R9030	228	AWHOBDS60	214	AWHOGDD66	212	AWHOGSR72	210
AW1T2R9036	228	AWHOBDS66	214	AWHOGDD72	212	AWHOGSR78	210
AW1T2R9042	229	AWHOBDS72	214	AWHOGDD78	212	AWHOGSR84	210
AW1T2R9630	228	AWHOBDS78	214	AWHOGDD84	212	AWHOGSR90	210
AW1T2R9636	228	AWHOBDS84	214	AWHOGDD90	212	AWHOGSR96	210
AW1T2R9642	229	AWHOBDS90	214	AWHOGDD96	212	AWHOGSS60	210
AW1T2W4823	231	AWHOBDS96	214	AWHOGDO30	211	AWHOGSS66	210
AW1T2W4832	231	AWHOBDT60	213	AWHOGDO36	211	AWHOGSS72	210
AW1T2W6023	231	AWHOBDT66	213	AWHOGDO42	211	AWHOGSS78	210
AW1T2W6032	231	AWHOBDT72	213	AWHOGDO48	211	AWHOGSS84	210
AW1T2W7226	231	AWHOBDT78	213	AWHOGDO54	211	AWHOGSS90	210
AW1T2W7262	231	AWHOBDT84	213	AWHOGDO60	211	AWHOGSS96	210
AWBK42	158	AWHOBDT90	213	AWHOGDO66	211	AWHOGST60	209
AWBK48	158	AWHOBDT96	213	AWHOGDO72	211	AWHOGST66	209
AWBK54	158	AWHOBSD30	208	AWHOGDO78	211	AWHOGST72	209
AWBK60	158	AWHOBSD36	208	AWHOGDO84	211	AWHOGST78	209
AWBK66	158	AWHOBSD42	208	AWHOGDO90	211	AWHOGST84	209
AWBK72	158	AWHOBSD48	208	AWHOGDO96	211	AWHOGST90	209
AWBK78	158	AWHOBSD54	208	AWHOCDR60	214	AWHOGST96	209
AWBK84	158	AWHOBSD60	208	AWHOCDR66	214	AWHTB30	258
AWBK90	158	AWHOBSD66	208	AWHOCDR72	214	AWHTB36	258
AWBK96	158	AWHOBSD72	208	AWHOCDR78	214	AWHTB42	258
AWBS42	155	AWHOBSD78	208	AWHOCDR84	214	AWHTB48	258
AWBS48	155	AWHOBSD84	208	AWHOCDR90	214	AWHTB54	258
AWBS54	155	AWHOBSD90	208	AWHOCDR96	214	AWHTB60	258
AWBS60	155	AWHOBSD96	208	AWHOGDS60	214	AWHTB66	258
AWBS66	155	AWHOBSD030	207	AWHOGDS66	214	AWHTB72	258

<i>pattern no.</i>	<i>page</i>	<i>pattern no.</i>	<i>page</i>	<i>pattern no.</i>	<i>page</i>	<i>pattern no.</i>	<i>page</i>
AWHTB78	258	AX1A L48	59	AX1SEA7948	63	ML4L44	217
AWHTB84	258	AX1A L64	59	AX1SEA7964	63	ML4L58	217
AWHTB90	258	AX1A T39	59	AX1SEC3939	61	MM2-CG	87
AWHTB96	258	AX1A T48	59	AX1SEC4039 L	61	MWM-J	216
AWM1 S36	255	AX1A T64	59	AX1SEC4239	62	R2AHBW18	126
AWM1 S42	255	AX1A V39	59	AX1SEC4339 C	61	R2AHBW20	126
AWM1 S48	255	AX1A V48	59	AX1SEC4839	62	R2AHBW24	126
AWM1 S60	255	AX1A V64	59	AX1SEC4848	61	R2AHBW30	126
AWM1 S66	255	AX1A X39	59	AX1SEC4948 L	61	R2AHBW36	126
AWM1 S72	255	AX1A X48	59	AX1SEC5248 C	61	R2AHBW42	126
AWM1 S78	255	AX1A X64	59	AX1SEC5639	62	R2AHBW48	126
AWM1 S84	255	AX1A Y39	59	AX1SEC5648	62	R2AHCN34	126
AWSO	259	AX1A Y48	59	AX1SEC6439	62	R2AHCN42	126
AWSOG	259	AX1A Y64	59	AX1SEC6448	62	R2AHCN49	126
AWTCT24	175	AX1AES34	67	AX1SEC6464	61	R2AHCN64	126
AWTCT30	175	AX1AES42	67	AX1SEC6564 L	61	R2AHCN79	126
AX1 A34239	72	AX1AES49	67	AX1SEC6864 C	61	R2AHCR34	126
AX1 A34939	72	AX1AES64	67	AX1SEC8048	62	R2AHCR42	126
AX1 A34948	72	AX1AES79	67	AX1SEC8064	62	R2AHCR49	126
AX1 A36439	72	AX1DHES3600L(5)	69	AX1SECBT	61, 62, 63, 64	R2AHCR64	126
AX1 A36448	73	AX1DHES3600R(5)	69	AX1SED3939	64	R2AHCR79	126
AX1 A36464	73	AX1DHES3603L(5)	69	AX1SED4239	64	R2AHSR18	126
AX1 HLS4839	60	AX1DHES3603R(5)	69	AX1SED4339C	64	R2AHSR20	126
AX1 HLS6439	60	AX1DHES4200L(5)	69	AX1SED4848	64	R2AHSR24	126
AX1 HLS6448	60	AX1DHES4200R(5)	69	AX1SED5039	64	R2AHSR30	126
AX1 M3939	71	AX1DHES4203L(5)	69	AX1SED5048	64	R2AHSR36	126
AX1 M4239	71	AX1DHES4203R(5)	69	AX1SED5248C	64	R2AHSR42	126
AX1 M4839	71	AX1DHES5000L(5)	69	AX1SED5739	64	R2AHSR48	126
AX1 M4848	71	AX1DHES5000R(5)	69	AX1SED5748	64	R2AHWR18	126
AX1 M5639	71	AX1DHES5003L(5)	69	AX1SED6439	64	R2AHWR20	126
AX1 M5648	71	AX1DHES5003R(5)	69	AX1SED6448	64	R2AHWR24	126
AX1 M6439	71	AX1DHES5700L(5)	69	AX1SED6464	64	R2AHWR30	126
AX1 M6448	71	AX1DHES5700R(5)	69	AX1SED7848	64	R2AHWR36	126
AX1 M6464	71	AX1DHES5703L(5)	69	AX1SED7864	64	R2AHWR42	126
AX1 M8039	71	AX1DHES5703R(5)	69	AX1SX39 A (L/C/P)	65	R2AHWR48	126
AX1 M8048	71	AX1DHES6400L(5)	69	AX1SX39 C (L/C/P)	65	R2CG	129
AX1 M8064	71	AX1DHES6400R(5)	69	AX1SX48 A (L/C/P)	65	R3AUAC10	112
AX1 R34239	72	AX1DHES6403L(5)	69	AX1SX48 C (L/C/P)	65	R3BOPOF4207	74
AX1 R34939	72	AX1DHES6403R(5)	69	AX1SX64 A (L/C/P)	65	R3BOPOF4907	74
AX1 R34948	72	AX1GES39	68	AX1SX64 C (L/C/P)	65	R3BOPOF6407	74
AX1 R36439	72	AX1GES48	68	AX2 C3939	71	R3BOPOF7907	74
AX1 R36448	72	AX1LES E	66	AX2 C4839	71	R3BOPOH4207	74
AX1 R36464	72	AX1LES30	66	AX2 C4848	71	R3BOPOH4907	74
AX1 R37939	72	AX1LES39	66	AX2 C6439	71	R3BOPOH6407	74
AX1 R37948	72	AX1LES48	66	AX2 C6448	71	R3BOPOH7907	74
AX1 R37964	72	AX1LES64	66	AX2 C6464	71	R3BOTOF4207	74
AX1 RF1	71	AX1MES30	66	MB1-AUX-C	246	R3BOTOF4907	74
AX1 RF3	71	AX1MES39	66	MB2-C18W-(L/R)	246	R3BOTOF6407	74
AX1 S	60	AX1MES42	66	MB2-C24W-(L/R)	246	R3BOTOF7907	74
AX1 SWS39	60	AX1MES48	66	MB2-C30W-(L/R)	246	R3BOTOH4207	74
AX1 SWS48	60	AX1MES56	66	MB2-YW-(L/R)	246	R3BOTOH4907	74
AX1 SWS64	60	AX1MES64	66	MB3-E18W	246	R3BOTOH6407	74
AX1A C39	58	AX1MES80	66	MB3-E24W	246	R3BOTOH7907	74
AX1A C48	58	AX1SEA3939	63	MB3-E30W	246	R3GAU0818	111
AX1A C64	58	AX1SEA4239	63	MB3-E36W	246	R3GAU0820	111
AX1A EH39	58	AX1SEA4339 C	63	MB3-EC18W	246	R3GAU0824	111
AX1A EH48	58	AX1SEA4848	63	MB3-EC24W	246	R3GAU0830	111
AX1A EH64	58	AX1SEA4939	63	MB3-EC30W	246	R3GAU0836	111
AX1A EL39	58	AX1SEA4948	63	MC1-39S1	86	R3GAU0842	111
AX1A EL48	58	AX1SEA4964	63	MC1-48S1	86	R3GAU0848	111
AX1A EL64	58	AX1SEA5248 C	63	MC1-64S1	86	R3GAU1218	111
AX1A F39	58	AX1SEA6439	63	MD6-BD	185	R3GAU1220	111
AX1A F48	58	AX1SEA6448	63	MD6-FS	185	R3GAU1224	111
AX1A F64	58	AX1SEA6464	63	ML4L17	217	R3GAU1230	111
AX1A L39	59	AX1SEA6864 C	63	ML4L31	217	R3GAU1236	111

<i>pattern no.</i>	<i>page</i>	<i>pattern no.</i>	<i>page</i>	<i>pattern no.</i>	<i>page</i>	<i>pattern no.</i>	<i>page</i>
R3GAU1242	111	R3R0135VP164	125	R3R0TP149	114	R3R1AF26418	92
R3GAU1248	111	R3R0135VP234	125	R3R0TP242	115	R3R1AF26424	92
R3GAU1518	111	R3R0135VP242	125	R3R0TP249	115	R3R1AF26430	92
R3GAU1520	111	R3R0135VP249	125	R3R0TP342	115	R3R1AF26436	92
R3GAU1524	111	R3R0135VP264	125	R3R0TP349	115	R3R1AF26442	92
R3GAU1530	111	R3R0135VP334	125	R3R0TPL42	115	R3R1AF26448	92
R3GAU1536	111	R3R0135VP342	125	R3R0TPL49	115	R3R1AF33418	93
R3GAU1542	111	R3R0135VP349	125	R3R0TT134	114	R3R1AF33424	93
R3GAU1548	111	R3R0135VP364	125	R3R0TT142	114	R3R1AF33430	93
R3GAUHL0818	111	R3R0135VPL34	125	R3R0TT149	114	R3R1AF33436	93
R3GAUHL0820	111	R3R0135VPL42	125	R3R0TT164	114	R3R1AF33442	93
R3GAUHL0824	111	R3R0135VPL49	125	R3R0TT234	114	R3R1AF33448	93
R3GAUHL0830	111	R3R0135VPL64	125	R3R0TT242	114	R3R1AF34218	93
R3GAUHL0836	111	R3R0135VTL134	124	R3R0TT249	114	R3R1AF34224	93
R3GAUHL0842	111	R3R0135VT142	124	R3R0TT264	114	R3R1AF34230	93
R3GAUHL0848	111	R3R0135VT149	124	R3R0TT334	114	R3R1AF34236	93
R3GAUHL1218	112	R3R0135VT164	124	R3R0TT342	114	R3R1AF34242	93
R3GAUHL1220	112	R3R0135VT234	124	R3R0TT349	114	R3R1AF34248	93
R3GAUHL1224	112	R3R0135VT242	124	R3R0TT364	114	R3R1AF34918	93
R3GAUHL1230	112	R3R0135VT249	124	R3R0TTL34	114	R3R1AF34924	93
R3GAUHL1236	112	R3R0135VT264	124	R3R0TTL42	114	R3R1AF34930	93
R3GAUHL1242	112	R3R0135VT334	124	R3R0TTL49	114	R3R1AF34936	93
R3GAUHL1248	112	R3R0135VT342	124	R3R0TTL64	114	R3R1AF34942	93
R3GAUHL1518	112	R3R0135VT349	124	R3R1AF13418	91	R3R1AF34948	93
R3GAUHL1520	112	R3R0135VT364	124	R3R1AF13424	91	R3R1AF36418	93
R3GAUHL1524	112	R3R0135VTL34	124	R3R1AF13430	91	R3R1AF36424	93
R3GAUHL1530	112	R3R0135VTL42	124	R3R1AF13436	91	R3R1AF36430	93
R3GAUHL1536	112	R3R0135VTL49	124	R3R1AF13442	91	R3R1AF36436	93
R3GAUHL1542	112	R3R0135VTL64	124	R3R1AF13448	91	R3R1AF36442	93
R3GAUHL1548	112	R3R0LP142	117	R3R1AF14218	91	R3R1AF36448	93
R3R0120VP134	123	R3R0LP149	117	R3R1AF14224	91	R3R1AFL3418	90
R3R0120VP142	123	R3R0LP242	117	R3R1AF14230	91	R3R1AFL3424	90
R3R0120VP149	123	R3R0LP249	117	R3R1AF14236	91	R3R1AFL3430	90
R3R0120VP164	123	R3R0LP342	117	R3R1AF14242	91	R3R1AFL3436	90
R3R0120VP234	123	R3R0LP349	117	R3R1AF14248	91	R3R1AFL3442	90
R3R0120VP242	123	R3R0LPL42	116	R3R1AF14918	91	R3R1AFL3448	90
R3R0120VP249	123	R3R0LPL49	116	R3R1AF14924	91	R3R1AFL4218	90
R3R0120VP264	123	R3R0LT134	116	R3R1AF14930	91	R3R1AFL4224	90
R3R0120VP334	123	R3R0LT142	116	R3R1AF14936	91	R3R1AFL4230	90
R3R0120VP342	123	R3R0LT149	116	R3R1AF14942	91	R3R1AFL4236	90
R3R0120VP349	123	R3R0LT164	116	R3R1AF14948	91	R3R1AFL4242	90
R3R0120VP364	123	R3R0LT234	116	R3R1AF16418	91	R3R1AFL4248	90
R3R0120VPL34	123	R3R0LT242	116	R3R1AF16424	91	R3R1AFL4918	90
R3R0120VPL42	123	R3R0LT249	116	R3R1AF16430	91	R3R1AFL4924	90
R3R0120VPL49	123	R3R0LT264	116	R3R1AF16436	91	R3R1AFL4930	90
R3R0120VPL64	123	R3R0LT334	116	R3R1AF16442	91	R3R1AFL4936	90
R3R0120VT134	122	R3R0LT342	116	R3R1AF16448	91	R3R1AFL4942	90
R3R0120VT142	122	R3R0LT349	116	R3R1AF23418	92	R3R1AFL4948	90
R3R0120VT149	122	R3R0LT364	116	R3R1AF23424	92	R3R1AFL6418	90
R3R0120VT164	122	R3R0LTL34	116	R3R1AF23430	92	R3R1AFL6424	90
R3R0120VT234	122	R3R0LTL42	116	R3R1AF23436	92	R3R1AFL6430	90
R3R0120VT242	122	R3R0LTL49	116	R3R1AF23442	92	R3R1AFL6436	90
R3R0120VT249	122	R3R0LTL64	116	R3R1AF23448	92	R3R1AFL6442	90
R3R0120VT264	122	R3R0SP142	121	R3R1AF24218	92	R3R1AFL6448	90
R3R0120VT334	122	R3R0SP149	121	R3R1AF24224	92	R3R1ALL3418	94
R3R0120VT342	122	R3R0SP242	121	R3R1AF24230	92	R3R1ALL3424	94
R3R0120VT349	122	R3R0SP249	121	R3R1AF24236	92	R3R1ALL3430	94
R3R0120VT364	122	R3R0SP342	121	R3R1AF24242	92	R3R1ALL3436	94
R3R0120VTL34	122	R3R0SP349	121	R3R1AF24248	92	R3R1ALL3442	94
R3R0120VTL42	122	R3R0SPL42	121	R3R1AF24918	92	R3R1ALL3448	94
R3R0120VTL49	122	R3R0SPL49	121	R3R1AF24924	92	R3R1ALL4218	94
R3R0120VTL64	122	R3R0TOH4207	74	R3R1AF24930	92	R3R1ALL4224	94
R3R0135VP134	125	R3R0TOH4907	74	R3R1AF24936	92	R3R1ALL4230	94
R3R0135VP142	125	R3R0TOH6407	74	R3R1AF24942	92	R3R1ALL4236	94
R3R0135VP149	125	R3R0TP142	114	R3R1AF24948	92	R3R1ALL4242	94

<i>pattern no.</i>	<i>page</i>	<i>pattern no.</i>	<i>page</i>	<i>pattern no.</i>	<i>page</i>	<i>pattern no.</i>	<i>page</i>
R3R1ALL4248	94	R3R1CX36442	109	R3R1PF24224	98	R3R2AF16430	101
R3R1ALL4918	95	R3R1CX36448	109	R3R1PF24230	98	R3R2AF16436	101
R3R1ALL4924	95	R3R1CXL4218	106	R3R1PF24236	98	R3R2AF16442	101
R3R1ALL4930	95	R3R1CXL4224	106	R3R1PF24242	98	R3R2AF16448	101
R3R1ALL4936	95	R3R1CXL4230	106	R3R1PF24248	98	R3R2AF23418	102
R3R1ALL4942	95	R3R1CXL4236	106	R3R1PF24918	98	R3R2AF23424	102
R3R1ALL4948	95	R3R1CXL4242	106	R3R1PF24924	98	R3R2AF23430	102
R3R1ALL6418	95	R3R1CXL4248	106	R3R1PF24930	98	R3R2AF23436	102
R3R1ALL6424	95	R3R1CXL4918	106	R3R1PF24936	98	R3R2AF23442	102
R3R1ALL6430	95	R3R1CXL4924	106	R3R1PF24942	98	R3R2AF23448	102
R3R1ALL6436	95	R3R1CXL4930	106	R3R1PF24948	98	R3R2AF24918	102
R3R1ALL6442	95	R3R1CXL4936	106	R3R1PF34218	99	R3R2AF24924	102
R3R1ALL6448	95	R3R1CXL4942	106	R3R1PF34224	99	R3R2AF24930	102
R3R1CX14218	107	R3R1CXL4948	106	R3R1PF34230	99	R3R2AF24936	102
R3R1CX14224	107	R3R1CXL6418	106	R3R1PF34236	99	R3R2AF24942	102
R3R1CX14230	107	R3R1CXL6424	106	R3R1PF34242	99	R3R2AF24948	102
R3R1CX14236	107	R3R1CXL6430	106	R3R1PF34248	99	R3R2AF26418	102
R3R1CX14242	107	R3R1CXL6436	106	R3R1PF34918	99	R3R2AF26424	102
R3R1CX14248	107	R3R1CXL6442	106	R3R1PF34924	99	R3R2AF26430	102
R3R1CX14918	107	R3R1CXL6448	106	R3R1PF34930	99	R3R2AF26436	102
R3R1CX14924	107	R3R1LAL134	118	R3R1PF34936	99	R3R2AF26442	102
R3R1CX14930	107	R3R1LAL142	118	R3R1PF34942	99	R3R2AF26448	102
R3R1CX14936	107	R3R1LAL149	118	R3R1PF34948	99	R3R2AF33418	103
R3R1CX14942	107	R3R1LAL164	118	R3R1PFL4218	96	R3R2AF33424	103
R3R1CX14948	107	R3R1LAL234	119	R3R1PFL4224	96	R3R2AF33430	103
R3R1CX16418	107	R3R1LAL242	119	R3R1PFL4230	96	R3R2AF33436	103
R3R1CX16424	107	R3R1LAL249	119	R3R1PFL4236	96	R3R2AF33442	103
R3R1CX16430	107	R3R1LAL264	119	R3R1PFL4242	96	R3R2AF33448	103
R3R1CX16436	107	R3R1LAL334	119	R3R1PFL4248	96	R3R2AF34918	103
R3R1CX16442	107	R3R1LAL342	119	R3R1PFL4918	96	R3R2AF34924	103
R3R1CX16448	107	R3R1LAL349	119	R3R1PFL4924	96	R3R2AF34930	103
R3R1CX24218	108	R3R1LAL364	119	R3R1PFL4930	96	R3R2AF34936	103
R3R1CX24224	108	R3R1LAL134	118	R3R1PFL4936	96	R3R2AF34942	103
R3R1CX24230	108	R3R1LALL42	118	R3R1PFL4942	96	R3R2AF34948	103
R3R1CX24236	108	R3R1LALL49	118	R3R1PFL4948	96	R3R2AF36418	103
R3R1CX24242	108	R3R1LALL64	118	R3R1SA134	120	R3R2AF36424	103
R3R1CX24248	108	R3R1LAR134	118	R3R1SA142	120	R3R2AF36430	103
R3R1CX24918	108	R3R1LAR142	118	R3R1SA149	120	R3R2AF36436	103
R3R1CX24924	108	R3R1LAR149	118	R3R1SA164	120	R3R2AF36442	103
R3R1CX24930	108	R3R1LAR164	118	R3R1SA234	120	R3R2AF36448	103
R3R1CX24936	108	R3R1LAR234	119	R3R1SA242	120	R3R2AFL3418	100
R3R1CX24942	108	R3R1LAR242	119	R3R1SA249	120	R3R2AFL3424	100
R3R1CX24948	108	R3R1LAR249	119	R3R1SA264	120	R3R2AFL3430	100
R3R1CX26418	108	R3R1LAR264	119	R3R1SA334	121	R3R2AFL3436	100
R3R1CX26424	108	R3R1LAR334	119	R3R1SA342	121	R3R2AFL3442	100
R3R1CX26430	108	R3R1LAR342	119	R3R1SA349	121	R3R2AFL3448	100
R3R1CX26436	108	R3R1LAR349	119	R3R1SA364	121	R3R2AFL4918	100
R3R1CX26442	108	R3R1LAR364	119	R3R1SAL34	120	R3R2AFL4924	100
R3R1CX26448	108	R3R1LAR134	118	R3R1SAL42	120	R3R2AFL4930	100
R3R1CX34218	109	R3R1LAR142	118	R3R1SAL49	120	R3R2AFL4936	100
R3R1CX34224	109	R3R1LAR149	118	R3R1SAL64	120	R3R2AFL4942	100
R3R1CX34230	109	R3R1LAR164	118	R3R2AF13418	101	R3R2AFL4948	100
R3R1CX34236	109	R3R1PF14218	97	R3R2AF13424	101	R3R2AFL6418	100
R3R1CX34242	109	R3R1PF14224	97	R3R2AF13430	101	R3R2AFL6424	100
R3R1CX34248	109	R3R1PF14230	97	R3R2AF13436	101	R3R2AFL6430	100
R3R1CX34918	109	R3R1PF14236	97	R3R2AF13442	101	R3R2AFL6436	100
R3R1CX34924	109	R3R1PF14242	97	R3R2AF13448	101	R3R2AFL6442	100
R3R1CX34930	109	R3R1PF14248	97	R3R2AF14918	101	R3R2AFL6448	100
R3R1CX34936	109	R3R1PF14918	97	R3R2AF14924	101	R3R2ALL3418	104
R3R1CX34942	109	R3R1PF14924	97	R3R2AF14930	101	R3R2ALL3424	104
R3R1CX34948	109	R3R1PF14930	97	R3R2AF14936	101	R3R2ALL3430	104
R3R1CX36418	109	R3R1PF14936	97	R3R2AF14942	101	R3R2ALL3436	104
R3R1CX36424	109	R3R1PF14942	97	R3R2AF14948	101	R3R2ALL3442	104
R3R1CX36430	109	R3R1PF14948	97	R3R2AF16418	101	R3R2ALL3448	104
R3R1CX36436	109	R3R1PF24218	98	R3R2AF16424	101	R3R2ALL4218	104

<i>pattern no.</i>	<i>page</i>	<i>pattern no.</i>	<i>page</i>	<i>pattern no.</i>	<i>page</i>	<i>pattern no.</i>	<i>page</i>
R3R2ALL4220	104	RO3-A42NN	215	RR3-EJ42	132	RR3-TJ60P	134
R3R2ALL4224	104	RO3-A42PL	215	RR3-EJ42P	132	RR3-TJ66P	134
R3R2ALL4230	104	RO3-A42PN	215	RR3-EJ48	132	RR3-TJ72P	134
R3R2ALL4236	104	RO3-A48NL	215	RR3-EJ48P	132	RR3-TJ78P	134
R3R2ALL4242	104	RO3-A48NN	215	RR3-EJ54P	132	RR3-TJ84P	134
R3R2ALL4248	104	RO3-A48PL	215	RR3-EJ60P	132	RR3-TJ90P	134
R3R2ALL4918	105	RO3-A48PN	215	RR3-EJ66P	132	RR3-TJ96P	134
R3R2ALL4924	105	RO3-A60NL	215	RR3-EJ72P	132	RR3-TPC24	133
R3R2ALL4930	105	RO3-A60NN	215	RR3-EJ78P	132	RR3-TPCM	133
R3R2ALL4936	105	RO3-A60PL	215	RR3-EJ84P	132	RR3-TPCP24	133
R3R2ALL4942	105	RO3-A60PN	215	RR3-EJ90P	132	RR3-TPCPM	133
R3R2ALL4948	105	RO3-A72NL	215	RR3-EJ96P	132	RR3-TPCPS	133
R3R2ALL6418	105	RO3-A72NN	215	RR3-EPC24M	131	RR3-TPCS	133
R3R2ALL6424	105	RO3-A72PL	215	RR3-EPCM	131	RR3-TPI	134
R3R2ALL6430	105	RO3-A72PN	215	RR3-EPCP24M	131	RR3-TPNY1	134
R3R2ALL6436	105	RPETAD	185	RR3-EPCPM	131	RR3-TPNY2	134
R3R2ALL6442	105	RR3CHI241	135	RR3-EPCPSM	131	RR3-TPVR	134
R3R2ALL6448	105	RR3CHI242	135	RR3-EPCSM	131	RR3TVJ	137
R3R2SXX4218	110	RR3CHI301	135	RR3-EPI	132	RR3TVJ110	137
R3R2SXX4224	110	RR3CHI302	135	RR3-EPNY1	132	RR3TVJ82	137
R3R2SXX4230	110	RR3CHI361	135	RR3-EPNY2	132	RR3TVJ96	137
R3R2SXX4236	110	RR3CHI362	135	RR3-EPVR	132	RR3VDA	136
R3R2SXX4242	110	RR3CHI421	135	RR3EVJ	137	RR3VDB	136
R3R2SXX4248	110	RR3CHI422	135	RR3EVJ110	137	RR3VDC	136
R3R2SXX4918	110	RR3CHI481	135	RR3EVJ82	137	RR3VDX	136
R3R2SXX4924	110	RR3CHI482	135	RR3EVJ96	137	RR3VDXO	136
R3R2SXX4930	110	RR3-DA	131, 133	RR3FDP	136	RR3VDY	136
R3R2SXX4936	110	RR3-DATSHD	131, 133	RR3-REPI	132	RR3VDYO	136
R3R2SXX4942	110	RR3-DB	131, 133	RR3-RTPI	134	RR3VDZ	136
R3R2SXX4948	110	RR3-DC	133	RR3-SP-(A, B, C, X, Y, Z)	134	RR3VDZO	136
R3R2SXX6418	110	RR3-DX	131, 133	RR3-SP-(A,B,X,Y)	132	RR3VPBK	136
R3R2SXX6424	110	RR3-DXO	131, 133	RR3-T24	133	RSPABPP	129
R3R2SXX6430	110	RR3-DY	131, 133	RR3-T24S	130	RSPABPW	129
R3R2SXX6436	110	RR3-DYO	131, 133	RR3-T30NS	133	RSPABWW	129
R3R2SXX6442	110	RR3-DZ	133	RR3-T30S	130	RT1 SMK 1812	219
R3R2SXX6448	110	RR3-DZO	133	RR3-T36NS	133	RT1 SMK 1813	219
R3SPABPT	129	RR3-E24	131	RR3-T36S	130	RT1 SMK 1815	220
R3SPABTT	129	RR3-E24S	130	RR3-T42NS	133	RT1 SMK 1816	220
R3SPABTW	129	RR3-E30NS	131	RR3-T42S	130	RT1 SMK 2412	219
R3X34E	120	RR3-E30S	130	RR3-T48NS	133	RT1 SMK 2413	219
R3X42E	120	RR3-E36NS	131	RR3-T48S	130	RT1 SMK 2415	220
R3X49E	120	RR3-E36S	130	RR3-T60-4	133	RT1 SMK 2416	220
R3X64E	120	RR3-E42NS	131	RR3-T66-4	133	RT1 SMK 3012	219
RBCCP	247	RR3-E42S	130	RR3-T72-4	133	RT1 SMK 3013	219
RBF	247	RR3-E48NS	131	RR3TBVC50	136	RT1 SMK 3015	220
RCOUNTWT	187, 188	RR3-E48S	130	RR3TBVC62	136	RT1 SMK 3016	220
RHSCN15	129	RR3-E60-4	131	RR3TBVC64	136	RT1 SMK 3612	219
RHSCN250	129	RR3-E66-4	131	RR3TBVC76	136	RT1 SMK 3613	219
RHSCN70	129	RR3-E72-4	131	RR3TBVC78	136	RT1 SMK 3615	220
RO1-CB	216	RR3EBVC50	136	RR3TBVC90	136	RT1 SMK 3616	220
RO1-MPB	216	RR3EBVC62	136	RR3-TJ18	134	RT1 SMK 4212	219
RO1-RCB	216	RR3EBVC64	136	RR3-TJ18P	134	RT1 SMK 4213	219
RO1-RPB	216	RR3EBVC76	136	RR3-TJ20	134	RT1 SMK 4215	220
RO1-WMF2	216	RR3EBVC78	136	RR3-TJ20P	134	RT1 SMK 4216	220
RO1-WMF3	216	RR3EBVC90	136	RR3-TJ24	134	RT1 SMK 4812	219
RO1-WMF4	216	RR3-EJ18	132	RR3-TJ24P	134	RT1 SMK 4813	219
RO3-A30NL	215	RR3-EJ18P	132	RR3-TJ30	134	RT1 SMK 4815	220
RO3-A30NN	215	RR3-EJ20	132	RR3-TJ30P	134	RT1 SMK 4816	220
RO3-A30PL	215	RR3-EJ20P	132	RR3-TJ36	134	RT1 SMK 5412	219
RO3-A30PN	215	RR3-EJ24	132	RR3-TJ36P	134	RT1 SMK 5413	219
RO3-A36NL	215	RR3-EJ24P	132	RR3-TJ42	134	RT1 SMK 5415	220
RO3-A36NN	215	RR3-EJ30	132	RR3-TJ42P	134	RT1 SMK 5416	220
RO3-A36PL	215	RR3-EJ30P	132	RR3-TJ48	134	RT1 SMK 6012	219
RO3-A36PN	215	RR3-EJ36	132	RR3-TJ48P	134	RT1 SMK 6013	219
RO3-A42NL	215	RR3-EJ36P	132	RR3-TJ54P	134	RT1 SMK 6015	220

<i>pattern no.</i>	<i>page</i>	<i>pattern no.</i>	<i>page</i>	<i>pattern no.</i>	<i>page</i>	<i>pattern no.</i>	<i>page</i>
RT1 SMK 6016	220	XTB1 BAS 24S12CF	272	XTB1 BAS 36S20SA	280	XTB1MB	291
RT1 SMK 6612	219	XTB1 BAS 24S15CF	272	XTB1 BAS 36S20SF	278	XTB1RAK	300
RT1 SMK 6613	219	XTB1 BAS 24S15SF	272	XTB1 BAS 36S24SA	280	XTB1SB10C	284
RT1 SMK 6615	220	XTB1 BAS 24S18SF	272	XTB1 BAS 36S24SF	278	XTB1SB10E	284
RT1 SMK 6616	220	XTB1 BAS 24S20SF	272	XTB1 BAS 36S25SA	280	XTB1SB12C	284
RT1 SMK 7212	219	XTB1 BAS 24S24SF	272	XTB1 BAS 36S25SF	278	XTB1SB12E	284
RT1 SMK 7213	219	XTB1 BAS 24S25SF	272	XTB1 SLIK	285	XTB1SB15C	284
RT1 SMK 7215	220	XTB1 BAS 30D10CA	275	XTB1 SLIK30	285	XTB1SB15E	284
RT1 SMK 7216	220	XTB1 BAS 30D10CF	273	XTB1 SLIK36	285	XTB1SB4E	284
RT1 SMK 7812	219	XTB1 BAS 30D12CA	275	XTB1AC	291	XTB1SB5C	284
RT1 SMK 7813	219	XTB1 BAS 30D12CF	273	XTB1AC24	291	XTB1SB5E	284
RT1 SMK 7815	220	XTB1 BAS 30D15CA	275	XTB1ACEND	292	XTB1SB6C	284
RT1 SMK 7816	220	XTB1 BAS 30D15CF	273	XTB1DB10C	283	XTB1SB6E	284
RT1 SMK 8412	219	XTB1 BAS 30D15SA	275	XTB1DB10E	283	XTB1SB8C	284
RT1 SMK 8413	219	XTB1 BAS 30D15SF	273	XTB1DB12C	283	XTB1SB8E	284
RT1 SMK 8415	220	XTB1 BAS 30D18SA	275	XTB1DB12E	283	XTB1T24	290
RT1 SMK 8416	220	XTB1 BAS 30D18SF	273	XTB1DB15C	283	XTB1TB10C	282
RT1 SMK 9012	219	XTB1 BAS 30D20SA	275	XTB1DB15E	283	XTB1TB10E	282
RT1 SMK 9013	219	XTB1 BAS 30D20SF	273	XTB1DB4E	283	XTB1TB12C	282
RT1 SMK 9015	220	XTB1 BAS 30D24CA	275	XTB1DB5C	283	XTB1TB12E	282
RT1 SMK 9016	220	XTB1 BAS 30D24CF	273	XTB1DB5E	283	XTB1TB15C	282
RT1 SMK 9612	219	XTB1 BAS 30D25CA	275	XTB1DB6C	283	XTB1TB15E	282
RT1 SMK 9613	219	XTB1 BAS 30D25CF	273	XTB1DB6E	283	XTB1TB4E	282
RT1 SMK 9615	220	XTB1 BAS 30S10CA	276	XTB1DB8C	283	XTB1TB5C	282
RT1 SMK 9616	220	XTB1 BAS 30S10CF	274	XTB1DB8E	283	XTB1TB5E	282
RT1 SMK B	219, 220	XTB1 BAS 30S12CA	276	XTB1EDD24	285	XTB1TB6C	282
RTAT5E19S	217	XTB1 BAS 30S12CF	274	XTB1EDD30	285	XTB1TB6E	282
RTAT5E25A	217	XTB1 BAS 30S15CA	276	XTB1EDD36	285	XTB1TB8C	282
RTAT5E25S	217	XTB1 BAS 30S15CF	274	XTB1EP1DD24	289	XTB1TB8E	282
RTAT5E37A	217	XTB1 BAS 30S15SA	276	XTB1EP1DD24P	288	XTB1XD30	290
RTAT5E37S	217	XTB1 BAS 30S15SF	274	XTB1EP1DD30	289	XTB1XD30N	290
RTAT5E49A	217	XTB1 BAS 30S18SA	276	XTB1EP1DD30P	288	XTB1XD36	290
RTAT5E49S	217	XTB1 BAS 30S18SF	274	XTB1EP1DD36	289	XTB1XD36N	290
RTAT5E61A	217	XTB1 BAS 30S20SA	276	XTB1EP1DD36P	288	XTB1XDD24	285
RTAT5E61S	217	XTB1 BAS 30S20SF	274	XTB1EP1LD24	289	XTB1XDD30	285
SISAWDSIK	250	XTB1 BAS 30S24SA	276	XTB1EP1LD24P	288	XTB1XDD36	285
SISDDPS	250	XTB1 BAS 30S24SF	274	XTB1EP1LD30	289	XTB1XS30	290
SISLC4	250	XTB1 BAS 30S25SA	276	XTB1EP1LD30P	288	XTB1XS30N	290
XAUA 1248G	313	XTB1 BAS 30S25SF	274	XTB1EP1LD36	289	XTB1XS36	290
XAUA 1260G	313	XTB1 BAS 36D10CA	279	XTB1EP1LD36P	288	XTB1XS36N	290
XAUA 1272G	313	XTB1 BAS 36D10CF	277	XTB1EP1RD24	289	XTB1YDD24	286
XT1DS4505	304	XTB1 BAS 36D12CA	279	XTB1EP1RD24P	288	XTB1YDD30	286
XT1DS5705	304	XTB1 BAS 36D12CF	277	XTB1EP1RD30	289	XTB1YDD36	286
XT1DS6905	304	XTB1 BAS 36D15CA	279	XTB1EP1RD30P	288	XTB2LDD	285
XT1LS4509	304	XTB1 BAS 36D15CF	277	XTB1EP1RD36	289	XTB2LDD24	285
XT1LS5709	304	XTB1 BAS 36D15SA	279	XTB1EP1RD36P	288	XTB2LSD	287
XT1LS6909	304	XTB1 BAS 36D15SF	277	XTB1EP2DD24	289	XTB2LSD24	287
XT1SA24	304	XTB1 BAS 36D18SA	279	XTB1EP2DD24P	288	XTBT18	301
XT1SA30	304	XTB1 BAS 36D18SF	277	XTB1EP2DD30	289	XTBT24	301
XT1SA36	304	XTB1 BAS 36D20SA	279	XTB1EP2DD30P	288	XTBT36	301
XT1SA42	304	XTB1 BAS 36D20SF	277	XTB1EP2DD36	289	XTBT48	301
XT1SA48	304	XTB1 BAS 36D24CA	279	XTB1EP2DD36P	288	XTBT60	301
XT1SA54	304	XTB1 BAS 36D24CF	277	XTB1EP2SD24	289	XTC1 120 AA	281
XT1SA60	304	XTB1 BAS 36D25CA	279	XTB1EP2SD24P	288	XTC1 144 AA	281
XT1SA66	304	XTB1 BAS 36D25CF	277	XTB1EP2SD30	289	XTC1 48	281
XT1SA72	304	XTB1 BAS 36S10CA	280	XTB1EP2SD30P	288	XTC1 60	281
XTB1 BAS 24D10CF	271	XTB1 BAS 36S10CF	278	XTB1EP2SD36	289	XTC1 72	281
XTB1 BAS 24D12CF	271	XTB1 BAS 36S12CA	280	XTB1EP2SD36P	288	XTC1 96	281
XTB1 BAS 24D15CF	271	XTB1 BAS 36S12CF	278	XTB1ESD24	287	XTC1 END	281
XTB1 BAS 24D15SF	271	XTB1 BAS 36S15CA	280	XTB1ESD30	287	XTCA1 120 AA	281
XTB1 BAS 24D18SF	271	XTB1 BAS 36S15CF	278	XTB1ESD36	287	XTCA1 144 AA	281
XTB1 BAS 24D20SF	271	XTB1 BAS 36S15SA	280	XTB1FC	291	XTCA1 48	281
XTB1 BAS 24D24SF	271	XTB1 BAS 36S15SF	278	XTB1FC24	291	XTCA1 60	281
XTB1 BAS 24D25SF	271	XTB1 BAS 36S18SA	280	XTB1FCEND	292	XTCA1 72	281
XTB1 BAS 24S10CF	272	XTB1 BAS 36S18SF	278	XTB1LP	292	XTCA1 96	281

<i>pattern no.</i>	<i>page</i>	<i>pattern no.</i>	<i>page</i>	<i>pattern no.</i>	<i>page</i>	<i>pattern no.</i>	<i>page</i>
XTCF 48	281	XTR1D2	298	XTSM1C	309, 310	XTTK7236C (L/M/1/2/3)	266
XTCF 60	281	XTR1D3	298	XTSM1K	305, 306	XTTK7236D (L/M/1/2/3)	268
XTCF 72	281	XTR1D4	298	XTSM1KC	311, 312	XTTK7236E (L/M/1/2/3)	268
XTCS1 4714	302	XTR1DA	294, 296	XTSM1KK	309, 310	XTTK7236F (L/M/1/2/3)	270
XTCS1 4714F	303	XTR1DB	294, 296	XTSM1P	305, 306, 307, 308, 309, 310	XTTK7236U (L/M/1/2/3)	265
XTCS1 4721	302	XTR1DC	296	XTSM1PC	311, 312	XTTK8418F (L/M/1/2/3)	270
XTCS1 4721F	303	XTR1DXO	294, 296	XTSM1S	305, 306, 307, 308, 309, 310	XTTK8436F (L/M/1/2/3)	270
XTCS1 4814	302	XTR1DYO	294, 296	XTSM1SC	311, 312	XTTK9624A (L/M/1/2/3)	264
XTCS1 4814F	303	XTR1DZO	296	XTSM1SLAT	309, 310	XTTK9624C (L/M/1/2/3)	266
XTCS1 4821	302	XTR1E30D	293	XTSS1 2414	305	XTTK9624U (L/M/1/2/3)	265
XTCS1 4821F	303	XTR1E30S	293	XTSS1 2414F	306	XTTK9630A (L/M/1/2/3)	264
XTCS1 5914	302	XTR1E424D	293	XTSS1 2421	305	XTTK9630C (L/M/1/2/3)	266
XTCS1 5914F	303	XTR1E424S	293	XTSS1 2421F	306	XTTK9630U (L/M/1/2/3)	265
XTCS1 5921	302	XTR1ECPM	294	XTSS1 3014	305	XTTK9636A (L/M/1/2/3)	264
XTCS1 5921F	303	XTR1EE	293, 295, 299	XTSS1 3014F	306	XTTK9636C (L/M/1/2/3)	266
XTCS1 6014	302	XTR1EJ18	294	XTSS1 3021	305	XTTK9636U (L/M/1/2/3)	265
XTCS1 6014F	303	XTR1EJ30	294	XTSS1 3021F	306	XTPP3018F (L)	270
XTCS1 6021	302	XTR1EJ42	294	XTSS1 3614	305	XTPP3618F (L)	270
XTCS1 6021F	303	XTR1EPH	294	XTSS1 3614F	306	XTPP4218F (L)	270
XTCS1 7114	302	XTR1EPI	294	XTSS1 3621	305	XTPP4824A (L)	264
XTCS1 7114F	303	XTR1FE	293, 295, 299	XTSS1 3621F	306	XTPP4824B (L)	265
XTCS1 7121	302	XTR1H30D	299	XTTK3018F (L/M/1/2/3)	270	XTPP4824C (L)	266
XTCS1 7121F	303	XTR1IOF	294, 296, 299	XTTK3036F (L/M/1/2/3)	270	XTPP4824E (L)	267
XTCS1 7214	302	XTR1PDCX	294, 296	XTTK3618F (L/M/1/2/3)	270	XTPP4830A (L)	264
XTCS1 7214F	303	XTR1T30D	295	XTTK3636F (L/M/1/2/3)	270	XTPP4830B (L)	265
XTCS1 7221	302	XTR1T30S	295	XTTK4218F (L/M/1/2/3)	270	XTPP4830C (L)	266
XTCS1 7221F	303	XTR1T424D	295	XTTK4236F (L/M/1/2/3)	270	XTPP4830E (L)	267
XTCS1 SBA	304	XTR1T424S	295	XTTK4824A (L/M/1/2/3)	264	XTPP4836A (L)	264
XTCT6030D	300	XTR1TCC25	300	XTTK4824C (L/M/1/2/3)	266	XTPP4836B (L)	265
XTCT6030LD	300	XTR1TCPM	296	XTTK4824E (L/M/1/2/3)	267	XTPP4836C (L)	266
XTCT6036D	300	XTR1TJ18	296	XTTK4824U (L/M/1/2/3)	265	XTPP4836D (L)	269
XTCT6036LD	300	XTR1TJ30	296	XTTK4830A (L/M/1/2/3)	264	XTPP4836E (L)	269
XTCT7230D	300	XTR1TJ42	296	XTTK4830C (L/M/1/2/3)	266	XTPP6024A (L)	264
XTCT7230LD	300	XTR1TPH	296	XTTK4830E (L/M/1/2/3)	267	XTPP6024B (L)	265
XTCT7236D	300	XTR1TPI	296	XTTK4830U (L/M/1/2/3)	265	XTPP6024C (L)	266
XTCT7236LD	300	XTR1X30D	297	XTTK4836A (L/M/1/2/3)	264	XTPP6024E (L)	267
XTDT42	300	XTR1X30S	297	XTTK4836C (L/M/1/2/3)	266	XTPP6030A (L)	264
XTDTX42	300	XTR1X424D	297	XTTK4836D (L/M/1/2/3)	268	XTPP6030B (L)	265
XTES1 2414	311	XTR1X424S	297	XTTK4836E (L/M/1/2/3)	268	XTPP6030C (L)	266
XTES1 2414F	312	XTR1XCPM	298	XTTK4836U (L/M/1/2/3)	265	XTPP6030E (L)	267
XTES1 2421	311	XTR1XJ18	298	XTTK6018F (L/M/1/2/3)	270	XTPP6036A (L)	264
XTES1 2421F	312	XTR1XJ30	298	XTTK6024A (L/M/1/2/3)	264	XTPP6036B (L)	265
XTES1 3014	311	XTR1XJ42	298	XTTK6024C (L/M/1/2/3)	266	XTPP6036C (L)	266
XTES1 3014F	312	XTR1XPH	298	XTTK6024E (L/M/1/2/3)	267	XTPP6036D (L)	269
XTES1 3021	311	XTR1XPI	298	XTTK6024U (L/M/1/2/3)	265	XTPP6036E (L)	269
XTES1 3021F	312	XTRS1 5414	307	XTTK6030A (L/M/1/2/3)	264	XTPP7224A (L)	264
XTES1 3614	311	XTRS1 5414F	308	XTTK6030C (L/M/1/2/3)	266	XTPP7224B (L)	265
XTES1 3614F	312	XTRS1 5421	307	XTTK6030E (L/M/1/2/3)	267	XTPP7224C (L)	266
XTES1 3621	311	XTRS1 5421F	308	XTTK6030U (L/M/1/2/3)	265	XTPP7224E (L)	267
XTES1 3621F	312	XTRS1 6014	307	XTTK6036A (L/M/1/2/3)	264	XTPP7230A (L)	264
XTES1 4814	309	XTRS1 6014F	308	XTTK6036C (L/M/1/2/3)	266	XTPP7230B (L)	265
XTES1 4814F	310	XTRS1 6021	307	XTTK6036D (L/M/1/2/3)	268	XTPP7230C (L)	266
XTES1 4821	309	XTRS1 6021F	308	XTTK6036E (L/M/1/2/3)	268	XTPP7230E (L)	267
XTES1 4821F	310	XTRS1 6614	307	XTTK6036F (L/M/1/2/3)	270	XTPP7236A (L)	264
XTES1 6014	309	XTRS1 6614F	308	XTTK6036U (L/M/1/2/3)	265	XTPP7236B (L)	265
XTES1 6014F	310	XTRS1 6621	307	XTTK7218F (L/M/1/2/3)	270	XTPP7236C (L)	266
XTES1 6021	309	XTRS1 6621F	308	XTTK7224A (L/M/1/2/3)	264	XTPP7236D (L)	269
XTES1 6021F	310	XTRS1 7214	307	XTTK7224C (L/M/1/2/3)	266	XTPP7236E (L)	269
XTES1 7214	309	XTRS1 7214F	308	XTTK7224E (L/M/1/2/3)	267	XTPP9624A (L)	264
XTES1 7214F	310	XTRS1 7221	307	XTTK7224U (L/M/1/2/3)	265	XTPP9624B (L)	265
XTES1 7221	309	XTRS1 7221F	308	XTTK7230A (L/M/1/2/3)	264	XTPP9624C (L)	266
XTES1 7221F	310	XTRS1 7814	307	XTTK7230C (L/M/1/2/3)	266	XTPP9630A (L)	264
XTPSIMZKIT	314	XTRS1 7814F	308	XTTK7230E (L/M/1/2/3)	267	XTPP9630B (L)	265
XTR1BCC50	300	XTRS1 7821	307	XTTK7230U (L/M/1/2/3)	265	XTPP9630C (L)	266
XTR1D1	298	XTRS1 7821F	308	XTTK7236A (L/M/1/2/3)	264	XTPP9636A (L)	264

<i>pattern no.</i>	<i>page</i>
XTPP9636B (L)	265
XTPP9636C (L)	266
XTTS3018F (1/2/3)	270
XTTS3618F (1/2/3)	270
XTTS4218F (1/2/3)	270
XTTS4824A (1/2/3)	264
XTTS4824C (1/2/3)	266
XTTS4824E (1/2/3)	267
XTTS4824U (1/2/3)	265
XTTS4830A (1/2/3)	264
XTTS4830C (1/2/3)	266
XTTS4830E (1/2/3)	267
XTTS4830U (1/2/3)	265
XTTS4836A (1/2/3)	264
XTTS4836C (1/2/3)	266
XTTS4836D (1/2/3)	268
XTTS4836E (1/2/3)	268
XTTS4836U (1/2/3)	265
XTTS6024A (1/2/3)	264
XTTS6024C (1/2/3)	266
XTTS6024E (1/2/3)	267
XTTS6024U (1/2/3)	265
XTTS6030A (1/2/3)	264
XTTS6030C (1/2/3)	266
XTTS6030E (1/2/3)	267
XTTS6030U (1/2/3)	265
XTTS6036A (1/2/3)	264
XTTS6036C (1/2/3)	266
XTTS6036D (1/2/3)	268
XTTS6036E (1/2/3)	268
XTTS6036U (1/2/3)	265
XTTS7224A (1/2/3)	264
XTTS7224C (1/2/3)	266
XTTS7224E (1/2/3)	267
XTTS7224U (1/2/3)	265
XTTS7230A (1/2/3)	264
XTTS7230C (1/2/3)	266
XTTS7230E (1/2/3)	267
XTTS7230U (1/2/3)	265
XTTS7236A (1/2/3)	264
XTTS7236C (1/2/3)	266
XTTS7236D (1/2/3)	268
XTTS7236E (1/2/3)	268
XTTS7236U (1/2/3)	265
XTTS9624A (1/2/3)	264
XTTS9624C (1/2/3)	266
XTTS9624U (1/2/3)	265
XTTS9630A (1/2/3)	264
XTTS9630C (1/2/3)	266
XTTS9630U (1/2/3)	265
XTTS9636A (1/2/3)	264
XTTS9636C (1/2/3)	266
XTTS9636U (1/2/3)	265
XTWB120	301
XTWTB	301
XTWTBSLIK	301
XTWTC	301
XTWTX	301

Selling Policy

	<p>This Selling Policy supercedes all previous selling policies. Prices, discounts and product offerings are subject to change without notice.</p>
Terms & Conditions of Sales	<p>Sales by Knoll, Inc. or Knoll North America Corp. ("Seller") of Knoll Product Lines (hereinafter "Products") within the United States and Canada are made only on the terms which are contained in this Selling Policy. Seller hereby gives notice of its objection to any different or additional terms and conditions. This sale is expressly conditional upon Purchaser's assent to the terms and conditions set forth below. Additional terms and conditions may apply to KnollStudio and KnollTextiles orders. These terms and conditions may be modified or supplemented only by a written document signed by an authorized representative of Seller. These terms and conditions supercede any prior and/or contemporaneous agreements or correspondence between Purchaser and Seller. Written quotations expire thirty (30) days from the date of issuance and can be withdrawn by written notice anytime during that period. Where Purchaser and Seller have entered into the Knoll Electronic Terms and Conditions, all orders, acknowledgements, invoices and other business communications placed or transmitted in accordance with the Knoll Electronic Terms and Conditions shall be deemed to be in writing and signed and shall be valid for all purposes as if they were originated and maintained in documentary form.</p>
Ordering Information	<p>All orders must be in writing. The product pattern number(s) contained on Seller's order acknowledgement shall be the final expression of the order.</p>
Order Confirmation	<p>A purchase order is not binding on Seller until Purchaser has received Seller's order confirmation or acknowledgment.</p>
Pricing Policies	<p>List prices are subject to change without notice.</p> <p>List prices shall be those prices in effect on the date of receipt of a complete purchase order unless shipment is requested more than ninety (90) days after order entry in which case prices in effect on the date of shipment apply. List prices include specified freight costs. Unless specified in writing by Seller, no other charges are included in Seller's list prices.</p>
Taxes	<p>All sales, use, excise and other taxes applicable to the sale of the Products shall be paid by Purchaser. If Purchaser claims an exemption from any tax, Purchaser shall submit to Seller the appropriate exemption certificates.</p>
Terms of Payment	<p>Payment for one hundred percent (100%) of the net order amount is due within thirty (30) days of the date of invoice, which is generally issued upon shipment. In case of any discrepancies, such as shortages, and Seller is notified in writing within ten (10) days of receipt of Product, only that portion may be deducted and the balance paid. For orders greater than \$100,000 net, a fifty percent (50%) deposit is due at the time of order placement, with the remainder due within thirty (30) days of the date of invoice.</p> <p>KnollStudio orders less than \$2,000 require payment for one hundred percent (100%) of the net order amount (including any applicable sales tax and charges for inside delivery, special packaging, etc.), due at time of order placement. For KnollStudio orders greater than \$2,000, a one-half (50%) deposit is due at time of order placement with the remainder (including any applicable sales tax and charges for inside delivery, special packaging, etc.) due prior to shipment.</p> <p>If, in the judgment of Seller, Purchaser's financial condition does not justify the terms of the payment, Seller may require full or partial payment in advance.</p> <p>Past due accounts shall be charged one and one-half percent (1.5%) per month, or the highest rate permitted by law, whichever is less, and will be added to the outstanding balance. In the event Purchaser defaults on payment, Purchaser shall be liable for all collection costs, including reasonable attorney's fees and costs.</p>
Changes and Cancellation	<p>Purchase orders may not be changed or cancelled, in whole or in part, without prior written consent of Seller. Changes may effect delivery dates. Expenses incurred because of changes shall be charged to Purchaser. In the event of cancellations, Purchaser will be liable for reasonable cancellation charges established by Seller. Orders for special Product, orders including "COM" (hereinafter defined) material and orders pursuant to expedited delivery programs, may not be canceled.</p>
Freight Prepaid	<p>Freight is prepaid and included in the price of all Products, except KnollTextiles, within the 48 contiguous United States for orders placed with Knoll, Inc. and within Canada, excluding the Yukon, Northwest Territories, Nunavut and Newfoundland for orders placed with Knoll North America Corp. Packing is tested for rigorous motion and transportation but is not guaranteed to protect furniture from all conditions. If special packaging is required for any reason, please consult with your sales representative or dealer. Seller shall select the method of shipment and routing. Freight for all KnollTextiles orders is prepaid and added to the invoice.</p>
Delivery/Freight Charges	<p>Shipments outside the contiguous 48 United States and Canada shall be shipped F.O.B. Origin.</p> <p>For shipments outside the contiguous United States and Canada, Purchaser is responsible for the cost of freight from point of embarkation, including any handling and transportation charges incidental to loading at the point of departure and unloading at the final destination.</p> <p>Conditions beyond the control of Seller, including weather, available facilities and traffic conditions, may affect exact time of delivery. Seller shall not be responsible for specific carrier delivery date or time unless it has made a specific delivery commitment, in writing.</p> <p>Nonstandard methods of shipment and/or additional services are available upon request. Purchaser will be billed for the differential cost of any special services in excess of standard surface carrier freight costs. Premium charges, at Purchaser's request, will be added for airfreight, exclusive use of vehicle and extra, export or special packaging. Accessorial charges will be added for inside delivery, extra labor, reassignment and redelivery.</p> <p>Partial shipments may be made and invoiced by Seller.</p>
Claims	<p>All shipments for Knoll Products within the contiguous United States and Canada are F.O.B. Origin. All risk of loss passes to Purchaser at time of delivery to carrier. Purchaser shall inspect all Products upon receipt and notify Seller within ten (10) working days after receipt of any damage or defects which are, or should be, apparent from an inspection of the Product and its packaging. Failure of Purchaser to notify Seller during the ten (10) working day period shall constitute acceptance of the Products and waiver of any apparent defects, errors or shortages. For all claims relating to Product damaged in transit or for any other claims relating to or arising out of the transportation of the Product, Purchaser must seek recovery from the carrier and Seller has no liability to Purchaser for such claims. Seller may, upon request, assist Purchaser with filing of such claims with the carrier, but Seller will not be liable for any of these transportation related claims.</p>
Seller's Security Interest	<p>Until Seller receives the full payment for the Product, Seller shall have a security interest in the Product. Purchaser agrees to perform all acts, including but not limited to the execution and filing of documentation, which may be necessary to perfect and assure the security interest of Seller.</p>
Returns	<p>The return of Products without a written authorization by Seller shall not be accepted. To receive authorization for Product return, please call Customer Service. All Products that are returned pursuant to a valid authorization shall be subject to a twenty-five percent (25%) of list restocking charge. Products not currently offered for sale by Seller (including COM) shall not be authorized for return. All returned Products must be unused, in original condition and in the original Seller packing cartons. No refund or credit shall be given for damaged Products.</p>
Held Orders/Storage	<p>If Purchaser requests that an order be held or delayed, prices and terms and conditions in effect at the time of shipment shall apply. If Purchaser requests a delay after the time when Seller can defer production, Purchaser will be invoiced for the Product, payable in accordance with standard terms, when the order is ready for shipment. Seller may transfer the Product to storage, in which case all expenses incurred in connection with storage, including demurrage, preparation for storage, storage charges and handling shall be payable by Purchaser upon submission of invoices by Seller. Risk of loss to the Product shall pass to the Purchaser upon delivery of the Product into storage.</p>

Selling Policy

Customer's Own Material	<p>A Purchaser who requests a fabric or other surface material not standard to Seller's line of Products ("COM") must submit samples of the requested material to Seller prior to entry of a purchaser order. Seller shall determine if the material is suitable to its manufacturing processes and meets any requirements of Underwriters Laboratories. If the COM is acceptable, Seller will then establish a price for using the COM or the Product in question. For a description of the procedures for submitting samples and testing, contact customer resources or your sales representative. Seller shall have no responsibility for the appearance, condition, performance, durability, colorfastness or any other physical attribute of the COM. Purchaser shall indemnify and hold Seller harmless for any damages, injuries or losses arising out of or related to use of the COM on the Product.</p>
Warranty	<p>Seller warrants to the original Purchaser only that the Products Seller manufactures and sells to Purchaser are free of defects in workmanship and materials, during the applicable warranty period set forth below.</p> <p>Warranty period set forth below is for 24-hour, 7 days a week, multi shift use (includes parts and labor to repair).</p> <p>Should any failure to conform with this limited warranty appear to a Product listed below during the applicable warranty period from the date of shipment, Seller shall, upon prompt written notice, repair or replace, at its option and costs, the affected part or parts.</p> <p><i>Product and Period of Warranty</i></p> <p><i>Lifetime: Antenna Workspaces, AutoStrada, Calibre, Crinion Open Table, Currents, Dividends Horizon, Equity, Morrison, Reff Profiles laminate, Series 2 Storage, Template and other non-wood components (except cascade edge worksurfaces, operational parts, controls, electrical, Lighting, Series 2 Veneer Front Storage, special or custom products, see below)</i></p> <p><i>12 Years: Chadwick, Essentials Work Chairs, Generation by Knoll, Life, Moment, MultiGeneration by Knoll, ReGeneration by Knoll, RPM, Sapper and Toboggan seating (except seating upholstery, textiles, leathers and finishes, see below).</i></p> <p><i>10 Years: Anchor Storage except digital keypad lock, Antenna Workspaces, AutoStrada, Crinion Open Table, Dividends Horizon, Reff Profiles, Template wood components, Series 2 Veneer Front Storage, cascade edge worksurfaces, Wood Casegoods (The Graham Collection) (except wood casegoods upholstered surfaces, see below), Interaction tables (except height adjustment mechanisms for Counterforce, crank-adjustable, and split-top tables and worksurfaces, see below), Reuter overheads, Reuter vertical storage, KnollExtra Sapper Monitor Arm Collection, Adjustable keyboard mechanisms and platforms, Communication Boards (except fabric board textiles, see below), Smokador collection (except leathers, see below), and Orchestra Universal Systems Accessories.</i></p> <p><i>5 Years: Operational parts, controls, electrical, Lighting (except light ballasts, bulbs and power supply, see below), special or custom product, wood veneer products, Currents handerank, Interaction Counterforce, Interaction crank-adjustable, and split-top mechanisms, KnollStudio, Spark Series seating structural elements, Richard Schultz outdoor products, KnollExtra CPU storage and all universal storage drawers and Power Collection.</i></p> <p><i>3 Years: Seating upholstery, textiles, leathers and finishes. Fabric boards textiles and Smokador Collection leathers.</i></p> <p><i>2 Years: Anchor Storage digital keypad lock, all other KnollExtra product</i></p> <p><i>1 Year: Light ballasts, bulbs and power supply, seating upholstered amp pads and soft amp pads, wood casegoods upholstered surfaces. KnollStudio Maya Lin and Spark Series seating finishes.</i></p> <p>This warranty does not apply to:</p> <ul style="list-style-type: none">• Damage caused by a carrier other than the Seller.• Normal wear and tear or acts or omissions of parties other than Seller (including user modification, improper use or installation of Products).• COM or other third party materials applied to Products.• Products not installed by or under the auspices of a Knoll Dealer.• Dramatic temperature variations or exposure to unusual conditions.• Changes in surface finishes, including colorfastness due to aging or exposure to light.• Except as specifically noted above, textiles and upholstery supplied by <i>KnollTextiles</i> (consult current <i>KnollTextiles</i> price list for applicable warranty). <p>Natural variations occurring in wood, marble, and leather shall not be considered defects, and the Seller does not guarantee the colorfastness or matching of the colors, grains or textures, or surface hardness of such materials. The Seller also does not guarantee the colorfastness of fiberglass panel surfaces. THE EXPRESS WARRANTIES CONTAINED HEREIN ARE IN LIEU OF ALL OTHER WARRANTIES, EXPRESS OR IMPLIED, INCLUDING ANY WARRANTIES OF MERCHANTABILITY AND FITNESS FOR PARTICULAR PURPOSE AND ALL OTHER WARRANTIES ARISING FROM COURSE OF DEALING OR USAGE OF TRADE.</p> <p>The remedies provided above are the Purchaser's sole remedies for any failure of Seller to comply with its obligations regarding the workmanship of its Products. Correction of any nonconformity in the manner and for the period of time provided shall constitute complete fulfillment of all liabilities of Seller, with respect to or arising out of the Product furnished hereunder.</p>
Delay/Force Majeure	<p>Seller shall not be liable for failure to perform or for delay in performance due to fire, flood, strike or other labor difficulty, act of God, act of any governmental authority or of the Purchaser, riot, embargo, fuel or energy shortage, wrecks or delay in transportation, inability to obtain necessary labor, materials or manufacturing facilities from usual sources or failure of suppliers to meet their contractual obligations, or due to any cause beyond its reasonable control. If any such event occurs, Seller may extend delivery dates by a period of time necessary to overcome the effect of such delay, allocate available Product or cancel any purchase order.</p>
Compliance with Law	<p>PURCHASER IS SOLELY RESPONSIBLE FOR COMPLIANCE WITH ALL APPLICABLE FEDERAL, STATE AND LOCAL LAWS, ORDINANCES, REGULATIONS, RULES AND STANDARDS RELATING TO THE INSTALLATION, MAINTENANCE, USE AND OPERATION OF THE PRODUCTS.</p>
Patents	<p>Subject to the following provisions, Seller shall, at its own expense, defend or, at its option, settle any claim, suit or proceeding brought against the Purchaser, and/or its vendees, mediate and immediate, so far as based on an allegation that any Product or any part thereof furnished hereunder constitutes a direct or a contributory infringement of any claim of any patent of the United States or Canada. This obligation shall be effective only if Purchaser shall have made all payments then due hereunder and if Seller is notified promptly in writing and given authority, information and assistance for the defense of said claim, suit or proceeding. Seller shall pay all damages and costs awarded in such suit or proceedings so defended.</p> <p>The foregoing indemnity does not apply to the following:</p> <ul style="list-style-type: none">• Products supplied according to a design other than that of Seller, and which is required by the Purchaser.• Combination of the Product with another product not furnished hereunder unless Seller is a contributory infringer.• Any settlements of a suit or proceeding made without Seller's written consent.
Limitations of Liability	<p>SELLER, ITS CONTRACTORS, AUTHORIZED DEALERS AND SUBCONTRACTORS OR SUPPLIERS OF ANY TIER SHALL NOT BE LIABLE TO PURCHASER FOR ANY SPECIAL, INDIRECT, INCIDENTAL OR CONSEQUENTIAL DAMAGES ARISING FROM A BREACH OF THIS AGREEMENT.</p> <p>Purchaser's remedies set forth herein are exclusive and the liability of Seller with respect to the breach of this agreement or any contract entered into between the parties pursuant hereto shall not exceed the price of the Product or part on which such liability is based.</p>

KnollKey Lock Program

KnollKey Lock Program General Information

Following is the KnollKey lock policy, applicable to all products.

Knoll furniture can be ordered keyed-alike or random keyed. Key-alike and random keying instructions cannot be mixed on any single order. Only one of the two instructions can be used on an individual order. When an order is submitted with mixed (key-alike and random) instructions, Knoll will release the order as key-alike only and lock cores will have to be specified separately.

Key-alike

For the convenience of the user, furniture may be keyed alike at no charge. Write "Key-alike" in the description of your purchase order for any pedestal, overhead, file or other item you wish to have keyed alike.

Using the key-alike instructions, order cores and keys as line items on your purchase order. Do NOT submit a key-alike form. The Knoll East Greenville Lock Center will select key numbers from the standard range of K 001 - K 250. Key numbers will not be repeated unless over 250 sets are ordered. Lock cores keyed-alike will ship separately from the product, ready for field installation.

There is no charge for key-alike orders if placed with the furniture order.

IF THE KEY-ALIKE ORDER IS NOT PLACED AT LEAST TWO WEEKS PRIOR TO THE FURNITURE SHIP DATE, A \$50 HANDLING CHARGE AND AIR FREIGHT CHARGES WILL APPLY.

If product is ordered and shipped random-keyed, additional lock cores for key-alike are billable.

Random-Keying

To specify product keyed-random, write "key-random" in the product description. Random-keyed product is shipped with the lock core factory installed. A shrouded key is included. Random means no effort has been made to match key numbers, or to make them different.

Keys

A Knoll shrouded key is shipped with every lock core. 250 Key numbers are available. For numbers above 250, contact Custom Product Development. Additional keys and key blanks are available. See service parts for more information.

Master Keying

Knoll locks can be controlled by means of a master key. There is no additional per-lock charge for master keying. A letter of approval from the client must accompany orders for master keys.

Installing Lock Cores

Lock cores can be installed or removed in the field by using a change key. Cores must be in the unlocked position to be removed. See service parts for change key pattern number and pricing.

Lock Distribution

All orders for key-alike lock cores/keys are packaged and shipped from the East Greenville Lock Center, regardless of where the pedestals, overhead, or other units are produced. Random keyed product will have cores factory-installed.

How to Specify Key-Alike

Following is an example of how to specify key-alike for a cluster of 10 workstations.

Step 1 - Using the project floorplan, count the number of locks in each workstation.

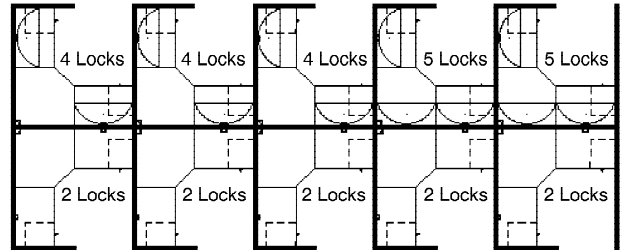

Step 2 - Count the number of workstations with the same quantity of locks. Group together the workstations with a like number of locks.

5 workstations with 2 locks per station
3 workstations with 4 locks per station
2 workstations with 5 locks per station

Step 3 - For the first group (5 sets of 2 locks), enter the number of workstations in the quantity column.

Qty	Pattern #	Description	Unit List	Ext. List
5				

Step 4 - Then enter the pattern number "KSPEC_ _" and add a suffix for the number of locks for that group (i.e., for 2 locks per station, add the suffix "2"). Up to 30 lock cores are available in a set (i.e., KSPEC 30).

Qty	Pattern #	Description	Unit List	Ext. List
5	KSPEC 2	Set of 2 cores/keys	N / C	N / C

Step 5 - Repeat for other groups.

Qty	Pattern #	Description	Unit List	Ext. List
5	KSPEC 2	Set of 2 cores/keys	N / C	N / C
3	KSPEC 4	Set of 4 cores/keys	N / C	N / C
2	KSPEC 5	Set of 5 cores/keys	N / C	N / C

Your Key instructions are complete.

Knoll will select key numbers for each set from 250 available numbers. Additional key numbers are available through Custom Product Development. **For additions to existing installations, specify desired key numbers in the description.**

Service Parts

Pattern #	Description	List Price
KKEY_ _ _	Shrouded Key Specify key number desired	\$10
KBLANK	Shrouded Key Blank	\$10
KSPECB_ _ _	Retrofit Universal Core/Key Specify key number desired	\$22
KCHANGE	Change Key	\$10
HLKRKMASTER*	Master Key	\$10

*Note: A letter of approval on company letterhead from the client must accompany all orders for master keys.

General Ordering Information

The Products

This guide encompasses all standard products for this product group.

Sizes

Dimensions listed in this guide are indicated as:

H = height

W = width

D = depth

Dia. = diameter

Rad. = radius

Pricing

All prices shown are list.

How to Order

Select pattern numbers and quantities required for your complete installation. Product questions can be addressed in the specific sections of this guide or by contacting your sales representative or customer resource representative at 1-800-343-5665.

Next, select options (if required), along with colors and finishes appropriate to each product. Reference the Finishes and Fabrics pages for color designations.

On large installations, an item's "designated area" can be specified to assist in product organization and handling.

To expedite complete / correct entry of your order, be certain all pattern numbers, quantities, colors and area identifications are completely specified. Also, include complete purchase order numbers, bill-to and ship-to addresses, a contact name and specific factory shipping dates required.

Mail all orders to:

Knoll, Inc.
1235 Water Street
P.O. Box 157
East Greenville, PA 18041
Attention: Order Entry

Once your order is entered at Knoll, an acknowledgment will be mailed to you. You will be advised of your scheduled shipping date within five days of the original acknowledgment. If it is necessary to revise your order, please contact your customer resource representative.

Sustainability Statement

Sustainable design is a key component of Knoll's environmental focus. Our commitment to social responsibility and a healthy environment has prompted us to further articulate our longstanding environmental programs and, with encouragement and support from our colleagues in the industry, we have re-energized our focus on such "green" initiatives as life cycle analysis and LEED™ certification. Knoll is proud to have contributed to projects that have received LEED certification from the U.S. Green Building Council.

For the latest information on Knoll products that help our customers achieve LEED certification, log on to knoll.com, click on "About Knoll" and then "Environmental Focus."