

Introduction	Knoll and Sustainable Design	3
	GREENGUARD Indoor Air Quality Certified®	4
	Placing Your Knoll Office Seating Order	5
	Office Seating Visual Index	6
	Office Seating Control Index	9
	KnollTextiles Fabric Application	10
	Customer's Own Material Seating Process Overview	11
	Spinneybeck Leather Application	19
Sapper™	Sapper™ : executive chair	24
	Sapper™ : management chair	26
	Sapper™ Dimensions and Operating Instructions	28
Life®	Life® : plastic base, knitted seat topper, no back topper	30
	Life® : plastic base, seat topper, no back topper	32
	Life® : plastic base, seat topper and back topper	34
	Life® : aluminum base, knitted seat topper, no back topper	36
	Life® : aluminum base, seat topper, no back topper	38
	Life® : aluminum base, seat topper and back topper	40
	Life® : replacement parts	42
	How to Specify a Life® Chair	44
	Life® Upholstery Options and Construction Information	46
	Life® Dimensions and Operating Instructions	48
Generation by Knoll®	Generation by Knoll® : work chair	50
	Generation by Knoll® Dimensions, Features and Operating Instructions	52
	Generation by Knoll® Technical Information	54
Chadwick™	Chadwick™ : tilt stop control	56
	Chadwick™ : basic control	58
	Chadwick™ : high task chair	60
	Chadwick™ Construction Information	64
	Chadwick™ Dimensions and Operating Instructions	66
RPM®	RPM® : basic control	68
	RPM® : advanced control	70
	RPM® : high task chair	72
	RPM® : side chair	76
	RPM® Dimensions and Operating Instructions	78
	RPM® Control Index and Construction Information	80
Essentials Work Chairs™	EWC Pro™ : upholstered mid-back task chair	82
	EWC Pro™ : upholstered mid-back conference chair	86
	EWC Pro™ : upholstered high-back task chair	90
	EWC Pro™ : upholstered high-back conference chair	94
	EWC Pro™ : upholstered side chair	98
	EWC Pro™ : seat and back replacements for task, conference and side chairs	100
	EWC Pro™ Task Dimensions and Operating Instructions	102
	EWC Pro™ Conference Dimensions and Operating Instructions	104
	EWC Tech™ : suspension back task chair	106
	EWC Tech™ : suspension back conference chair	110
	EWC Tech™ : suspension back side chair	114
	EWC Tech™ : seat and back replacements for task, conference and side chairs	116
	EWC Tech™ Task Dimensions and Operating Instructions	118
	EWC Tech™ Conference Dimensions and Operating Instructions	120
	EWC Sport™ : upholstered mid-back task chair	122
	EWC Sport™ : upholstered mid-back conference chair	126
	EWC Sport™ : seat and back replacements for task and conference chairs	130
EWC Sport™ Task Dimensions and Operating Instructions	132	
EWC Sport™ Conference Dimensions and Operating Instructions	134	
Moment™	Moment™ : side chair	136
	Moment™ Technical and Environmental Information	138

Alpha-Numeric Index	140
Selling Policy	141
General Ordering Information	143

Knoll and Sustainable Design

Each year Knoll sets key initiatives in our journey to sustainability. We are members of a global consortium on energy, have adopted a scientific, metrics-based approach to sustainable product design, and maintain a leadership position in establishing universal, verifiable, sustainability standards for our industry.

Knoll promotes independent third-party certification because it provides the most impartial and trustworthy foundation for industry-wide environmental compliance. Certification by established and respected third parties ensures that all manufacturers are held to the same high standards and that customers can trust a company's declaration about the environmental benefits of its products. Knoll third-party partners include: the International Standards Organization (ISO); Forest Stewardship Council (FSC®); Rainforest Alliance; GREENGUARD® Environmental Institute; and Chicago Climate Exchange (CCX®).

In addition, Knoll is aligned with the U.S. Green Building Council and can help companies, healthcare organizations and educational institutions achieve Leadership in Energy and Environmental Design (LEED®) workplace certification.

1. Global Climate Change

- Knoll is a sponsor of the Clinton Global Initiative, which brings together a community of global leaders to devise and implement solutions to some of the world's most pressing challenges, including environmental change.
- Knoll is a member of the Chicago Climate Exchange, which promotes greenhouse gas reduction through the trading of credits earned for reducing emissions.
- Knoll has a comprehensive Energy Management Program to increase energy efficiency in products and processes.

2. Life Cycle Assessment (LCA) Tool

- Life Cycle Assessment is a science-based measurement of a product's environmental impacts throughout its life cycle, from raw materials sourcing through manufacture, shipping, use and re-use or end-of-life. LCA enables cradle-to-cradle implementation of sustainable practices.
- Knoll has partnered with The Green Standard.org to develop an affordable, universal ISO-compliant computer-based LCA tool that can be used by the entire contract furniture industry and is partnering on the development of an Environmental Product Declaration System (EPDs) for Knoll products. EPDs are verified documents containing LCA results and additional environmental performance information about a product.

3. Setting Industry Standards

- Knoll partners with MTS (The Institute for Market Transformation to Sustainability) to develop the SMaRT® Consensus Sustainable Products Standards, a set of consensus-based sustainable product standards based on the LEED® model, for all building products, fabric, apparel, flooring and carpet. MTS, the developer of SMaRT®, is an accredited American National Standards Institute (ANSI) standard developer.
- Knoll has established FSC® (Forest Stewardship Council) certified wood as the standard for general office open plan office systems, casegoods and tables.
- Knoll also participates in an ongoing BIFMA (Business and Institutional Furniture Manufacturers Association) initiative to establish level™ sustainability standards for the contract furniture industry.
- Our goal is to encourage all manufacturers in the contract furniture industry and related industries to adopt standards that will lead to sustainable products and practices.

For more information about Knoll and sustainable design, visit knoll.com/environment.

All Knoll Office Seating is GREENGUARD Indoor Air Quality® certified and GREENGUARD for Children & SchoolsSM certified.

All KnollExtra® products are GREENGUARD Indoor Air Quality® certified.

Visit GREENGUARD.org for more information and to find printable certificates for Knoll Office Seating that can be used for verification and LEED® submission.

GREENGUARD provides the only guide to certified low-emitting interior products and building materials. Its goal is to help building owners and managers, architects, interior designers and product specifiers build and furnish healthier offices, hospitals, schools and homes by providing a register of tested and certified low-emitting products and materials.

GREENGUARD certification is recognized by the U.S. Green Building Council's LEED® Program. Air Quality Science, an independent indoor air quality laboratory, tests products submitted for certification using stringent environmental chamber testing protocols and current indoor air quality standard. Certification is administered by the GREENGUARD Environmental Institute (GEI), an industry-independent, non-profit organization.

GREENGUARD for Children & SchoolsSM certification complies with the State of California's Department of Health Services Standard Practice (CA Section 01350) for testing chemical emissions from building products used in schools, offices and other sensitive environments. Certified products can contribute to achieving credits in the CHPS Best Practices Manual for K-12 schools, the LEED® Green Building Rating System, Green Guide for Healthcare™, NAHB Green Building Guidelines, Green Globes, Regreen and numerous other local authorities' green building codes.

Knoll Office Seating and KnollExtra® products can contribute to achieving LEED® credits. GREENGUARD-tested and certified office furniture is required for Credit 4.5 in the LEED-CI Indoor Environmental Quality section.

GREENGUARD Certification Program

- Internationally recognized for evaluating product emissions and certifying building materials, furnishings, finishes and cleaning products and processes that meet stringent indoor air quality criteria defined by GEL.
- Products undergo rigorous, third-party testing to determine their impact on indoor air pollution with requirements for ongoing testing and verification.
- Certification confirms a manufacturer's environmental responsibility, and signifies their environmental achievements through independent, third-party testing and verification.
- GREENGUARD Certified products are recommended by leading sustainable building programs, including:
 - U.S Green Building Council's (USGBC) LEED Rating System,
 - National Association of Home Builders (NAHB) Green Building Guidelines,
 - Green Guide for Health Care (GGHC),
 - Collaborative for High Performance Schools (CHPS) Best Practices Manual,
 - New York City Department of Design and Construction Sustainable Design Specifications, among others.

Use the Following Addresses

If you would like to send a standard lead time order to our order entry department, please use the following address:

For North American orders:
Knoll, Inc.
1235 Water Street
East Greenville, PA 18041
Attn: Order Entry

Fax: 215 679-1788
Tel: 800 343-KNOLL (5665)

All accepted orders will be confirmed in writing on the Knoll standard order confirmation form.

For More Information

For complete Knoll Selling Policy and warranty information, please refer to page 141 of this price list.

For additional information on Knoll Office Seating, contact your Knoll representative, a Knoll dealer, or telephone Customer Services at 800 343-KNOLL (5665).

Shipping Method

All Generation by Knoll chairs, RPM task chairs, Essentials Work Chairs (EWC Pro, EWC Tech and EWC Sport task and conference versions), and Chadwick task chairs in this price list will ship boxed in two pieces.

If you would like a fully assembled, blanket wrapped Generation by Knoll chair, RPM task chair, Essentials Work Chair (EWC Pro, EWC Tech and EWC Sport task and conference versions), or Chadwick task chair, please consult the Office Seating Standard Specials price list for pattern numbers and associated upcharges.

Sapper™

Executive, p. 24



Management, p. 26



Life®

Plastic base, p. 30



Aluminum base, p. 36



Aluminum base, seat topper and back topper, p. 40



Generation by Knoll®

Dark finish, plastic base p. 50



Dark finish, aluminum base, p. 50



Light finish, plastic base, p. 50



Light finish, aluminum base, p. 50



Chadwick™

Task, p. 56



High task, p. 60



RPM®

Basic control, p. 68



Advanced control, p. 70



High task, p. 72



Side, p. 76



Essentials Work Chairs™

EWC Pro™ mid-back task, p. 82



EWC Pro™ mid-back conference, p.86



EWC Pro™ high-back task, p. 90



EWC Pro™ high-back conference, p. 94



EWC Pro™ side, p. 98



EWC Tech™ task, p. 106



Essentials Work Chairs™ (continued)

EWC Tech™ conference, p. 110



EWC Tech™ side, p. 114



EWC Sport™ task, p. 122



EWC Sport™ conference, p. 126



Bulldog®

Side, p. 0



Moment™

Side, p. 136



Spark™ Series

Side, p. 0



Side with seat pad, p. 0



Lounge, p. 0



Lounge with seat pad, p. 0



Control	Illustration	Description	Application
Weight-Compensated Control with Synchronized Recline		360° swivel; uses body weight in seat as counterbalance for recline resistance, the chair is perfectly adjusted by sitting in it — no adjustment necessary; promotes movement and balance; preference control accommodates a wider range of users.	Life task chairs Generation by Knoll work chairs
Synchronized Spring Tilt Control		360° swivel; back and seat recline in one synchronized movement to support the user's back throughout the recline. As back reclines, the seat drops down slightly, relieving pressure points.	RPM task chairs (basic and advanced controls) Chadwick task chairs (tilt stop and basic controls) Essentials Work Chairs task and conference versions
Advanced Knee-Tilt Control		360° swivel; seat and back tilt at the same ratio at a pivot point under the front edge of the seat.	Sapper task chairs
Swivel Tilt Control		360° swivel; seat and back tilt at the same ratio at a pivot point under the middle of the seat.	Essential Work Chairs task and conference versions

Fabric Application

The application of KnollTextiles fabrics on Knoll Office Seating provides the broadest and most exciting selection of standard fabrics in the contract furniture industry.

Developed in collaboration with leading designers, KnollTextiles upholstery harmonizes pattern, color and texture in the Modernist tradition. Choose from a wide selection of fabrics that are appropriate for corporate, hospitality, and healthcare use, ranging from natural fibers such as wool and cotton, to high performance options like Crypton® fabrics. Visit KnollTextiles.com to search the online database.

Fabrics are grouped into categories referred to as “grades.” The selection of approved fabrics varies by chair.

Always check with KnollTextiles for textile changes or new applications on seating.

Visit KnollTextiles.com and click on “Textile Matrices” to find the link to the most up-to-date Seating Approval Matrix.

Performance Upholstery Fabrics

KnollTextiles offers a wide selection of high durability and high performance fabric options. For excellent stain resistance, choose from upholstery products with a Nano-Tex™ finish. For a complete moisture barrier, so that nothing penetrates the fabric into the cushion, you can select from among Crypton® stain, moisture, odor and bacteria resistant fabrics. In addition, there are bleach-cleanable upholstery products, such as vinyl and solution-dyed nylon. Visit KnollTextiles.com and click on “Upholstery” or “Technical Documents” for details.

Nano-Tex™ and Teflon®: Both Nano-Tex and Teflon provide additional performance—spill and stain protection—and come stocked on a number of fabrics. These finishes can also be applied to dozens of KnollTextiles fabrics for an upcharge and additional lead time. For a moisture barrier, we also offer Crypton, Gore and Nano-Tex with DuraBlock.

Crypton®: KnollTextiles stocks over a dozen patterns with Crypton. It has a moisture barrier plus stain, odor and bacteria resistance, to protect the fabric and the cushion.

Gore™ Seating Protection or

Nano-Tex with DuraBlock: Gore and Nano-Tex with DuraBlock provide a durable moisture barrier with a soil and stain resistant topical treatment. Even under high pressure, no liquid can travel through the treatment into the cushion. These finish options are not stocked on products, but can be added to many existing KnollTextiles upholstery fabrics for an additional upcharge and lead time.

Environmental Options

KnollTextiles offers dozens of upholstery patterns with recycled content or natural fiber. Included in the line is a selection of 100% recycled upholstery fabrics that have no added backing or finish. Visit KnollTextiles.com and click on “Environmental Fabrics” for details.

California Technical Bulletin 133 (Cal 133)

Cal 133 is a flammability test procedure for seating furniture for use in public occupancies. Testing must be performed on the designated chair and textile together. Component data alone cannot be used to certify compliance with the regulation. Under Cal 133, one cannot assume that seating or textiles that have passed individually will pass together.

Cal 133 (cont.)

Many Knoll Office Seating products can be specified to comply with Cal 133. Applicable upcharge and specification rules are listed on the respective price list page. Chadwick is Cal 133 approved standard. Please refer to the textile matrix for pre-approved Cal 133 upholstery options for the following chairs:

- Sapper
- Life
- Generation by Knoll (dark finish only)
- RPM
- Essentials Work Chairs
- Moment

If any other KnollTextiles fabric or COM is desired, Knoll will test the compliance of the specified fabric on the specified chair. The cost of the test will be the price of the chair in the specified fabric plus \$520. The additional fee is to cover the cost of the test. Please see the respective price list page for yardage requirements. The process time for test results is 4-8 weeks. Contact your Knoll customer service representative at 800 343-KNOLL (5665) for further test processing instructions.

	Soil & Stain Resistance		Moisture Barrier Plus Soil & Stain Resistance		
	Teflon® (Topical)	Nano-Tex™ (Immersion)	Crypton®	Gore™	Nano-Tex with DuraBlock
Soil and Stain Resistant Topical Treatment	Yes	Yes	Yes	Yes	Yes
Water Repellant Finish	No	Yes	Yes	Yes	Yes
Moisture Resistant Backing/Barrier	No	No	Yes	Yes	Yes
Breathable	Yes	Yes	Yes	Yes	Yes
Microbial Resistant	No	Yes	Yes	Yes	Yes
Fabrics Stocked with Finish	Some	Some	Yes	No	No
Minimum Yardage on Non-Stocked Fabrics	5	5	n/a	5	5

Knoll is pleased to cooperate with Customer's Own Material (COM) or Customer's Own Leather (COL) selections after they have been approved by Knoll.

Please refer to the table below for COM process overview. See price list pages for specific chair information. For additional information see Customer's Own Material section in the Selling Policy.

Seating	Pre-Approval				Application Testing		
	Color Specific Testing?	Send to CSR/PM:	Process Time	Application Test Required?	Requires:	Yardage Required for Test	Process Time
Sapper	No	COM Seating Form & Memo Sample	2-3 days	No*	25 chair minimum order OR PO for \$300	2	2-3 weeks
Life	No	COM Seating Form & Memo Sample	2-3 days	No*			
Generation by Knoll	No	COM Seating Form & Memo Sample	2-3 days	No*			
RPM	No	COM Seating Form & Memo Sample	2-3 days	Yes	25 chair minimum order OR PO for \$300	1.5	2-3 weeks
RPM Side Chair	Yes	COM Seating Form & Memo Sample	2-3 days	Yes	25 chair minimum order OR PO for \$300	5	2-3 weeks
Essentials Work Chairs	No	COM Seating Form & Memo Sample	2-3 days	No*		1	2-3 weeks
Moment	No	COM Seating Form & Memo Sample	2-3 days	No*			

*Guideline only – subject to the discretion of the production floor. Sapper requires testing for vinyl.

Cal 133 COM Process Overview

If COM is desired, the fire barrier must be attached when fabric arrives at Knoll. Intek F187 fire barrier is recommended. Knoll will test the compliance of the specified fabric on the specified chair. The cost of the test will include the price of the chair and COM fabric plus \$520. The fee is to cover the cost of the test. Please see respective price list page for yardage requirement. The process time for test results is 4-8 weeks. Contact your Knoll Customer Service Representative at 800-343-KNOLL (5665) for further test processing instructions.

Textile Name	Grade	Direction	Part #	EWC Pro & EWC Tech Side	EWC Pro & EWC Tech Task	EWC Sport	Generation by Knoll
Abacus	B	NR	K715	■ ♣	■ ♣	■ ♣	■ ♣
Alignment	A	NR	K349	■ ♣	■ ♣	■ ♣	■ ♣
Analogy	A	NR	K614	■ **	■ **	■	○
Arno	H	NR*	K128	■	■	■	○
Atlas	C	NR*	K1236	■ **	■ **	○	■
Backdrop	B	NR*	W302	■ **	■ **	○	○
Bank Shot	B	NR*	K134	○	○	○	○
Belize	B	NR	K1165	■	■	■	■
Betwixt	B	NR	K1074	■ ** ♣	■ **	■	■ ♣
Bifold CR	B	RR	HC193	○	○	○	■
Biota	C	NR	K1297	■ ** ♣	■ **	■	■ ♣
Bocce	A	NR	K1255	■	■	■	■
Calais Cotton Velvet	F	NR	K787	○	○	○	○
Cat's Cradle	A	NR	K1290	■ **	■ **	■	■
Cato	I	RR	KH800	○	○	○	○
Cavalier	D	NR	K217	■ **	■ **	■	■
Century	F	NR	K1051	■ **	■ **	■	■
Charm	C	NR	K1049	■ ** ♣	■ **	■	■
Chroma	B	NR	K345	■ ** ♣	■ ** ♣	■ ♣	■
Circa	C	NR	K1054	■ **	■ **	■	■
Classic Boucle	B	NR*	K162	■	■	■	■
Close Knit	B	NR	K201	■	■	■	■
Coco	F	NR	K1024	■	■	■	■
Common Ground	A	NR*	K448	■ ** ♣	■ ** ♣	■ ♣	■ ♣
Compass CR	D	NR	HC1183	■ **	■ **	■	■
Cornaro	F	NR	K1320	■	■	■	■
Cotton Duck	A	ND	K131	○	○	○	○
Cricket	C	NR	HC1279	■ **	■ **	■	○
Cross Stitch	E	NR	K1026	■	■	■	■
Cuddle Cloth	F	NR*	K231	■	■	■	■
Decade	C	NR	K1053	■ **	■ **	■	■
Digit	B	NR	K891	■ ♣	■	○	■
Dovetail	B	NR	K1150	■ ** ♣	■ ** ♣	■ ♣	■ ♣
Dristi	A	NR*	K872	■	■	■	■
Earthwork	C	NR	K1238	■ ♣	■	■	■ ♣
Echo	C	NR	K1019	■	■	■	■
Eclat Weave	D	NR	K1104	■ **	■ **	■	■
Empire Stripe	C	NR	K1025	■ **	■ **	○	○
English Accent	C	NR	K1027	■ **	■ **	■	■
Enmesh	C	NR	K1092	■ ♣	■ ♣	■ ♣	■ ♣
Entourage	C	NR	K1389	■ ** ♣	■ ** ♣	■ ♣	■
EWC Sport	A	ND	K1196	■ **	■ **	■ ♣	○
Fable CR	C	RR	HC1122	■ **	■ **	■	■
Fairway	B	NR	HC1350	○	○	○	○

■ = Available

○ = Not Available

♣ = Cal 133 Pre-approved

* = Can be Railroad Cut

** = Not available with upholstered outer back

Textile Name	Life Back Topper	Life Seat Topper	Moment	RPM Side	RPM Task	Sapper
Abacus	■ ʘ	■ ʘ	■ ʘ	○	■ ʘ	■ ʘ
Alignment	■ ʘ	■ ʘ	■ *** ʘ	○	■ ʘ	■ ʘ
Analogy	○	○	○	○	■	○
Arno	○	○	■ *** ʘ	■	■ ʘ	■
Atlas	■	■	■	○	■	○
Backdrop	○	○	○	○	○	○
Bank Shot	○	○	■ ʘ	○	○	■
Belize	■	■	■	○	■	■
Betwixt	○	○	○	○	■	■ ʘ
Bifold CR	○	○	■	○	■	■
Biota	■	■	■	○	■	■
Bocce	■	■	■	○	■	■
Calais Cotton Velvet	○	○	○	○	○	○
Cat's Cradle	■	■	■	○	■	■
Cato	○	○	○	■	■	■
Cavalier	■ ʘ	■ ʘ	■ ʘ	○	■ ʘ	○
Century	■ ʘ	■ ʘ	■	■	■	○
Charm	■ ʘ	■ ʘ	■ ʘ	○	■	■
Chroma	■ ʘ	■ ʘ	■ ʘ	■ ʘ	■ ʘ	■ ʘ
Circa	■ ʘ	■ ʘ	■	○	■	■
Classic Boucle	■ ʘ	■ ʘ	■	■	■ ʘ	■
Close Knit	■	■	■	■	■	■
Coco	■	■	○	■	■	○
Common Ground	■ ʘ	■ ʘ	■ ʘ	○	■ ʘ	■ ʘ
Compass CR	■	■	■	○	■	■
Cornaro	■	■	■	■	■	■
Cotton Duck	○	○	○	○	○	○
Cricket	○	○	■	○	○	■
Cross Stitch	■ ʘ	■ ʘ	■ ʘ	■	■ ʘ	■
Cuddle Cloth	■	■	■	■	■	■
Decade	■ ʘ	■ ʘ	■	○	■	■
Digit	○	○	○	○	■	■
Dovetail	■ ʘ	■ ʘ	■ ʘ	○	○	■ ʘ
Dristi	○	○	○	■	■	○
Earthwork	■	■	■ ʘ	■ ʘ	■	■
Echo	■	■	■ ʘ	○	■	■
Eclat Weave	■	■	■	○	■	■
Empire Stripe	■ ʘ	■ ʘ	■	○	○	■
English Accent	■	■	■	○	■	■
Enmesh	■ ʘ	■ ʘ	■ ʘ	■	■	■
Entourage	■ ʘ	■ ʘ	■ ʘ	■ ʘ	■ ʘ	■ ʘ
EWC Sport	○	○	○	○	○	○
Fable CR	■	■	■	○	■	■
Fairway	■	○	■	○	○	○

Textile Name	Grade	Direction	Part #	EWC Pro & EWC Tech Side	EWC Pro & EWC Tech Task	EWC Sport	Generation by Knoll
Fast Forward	B	NR*	W301	■**	■**	■	○
Fibra	C	NR	K1105	■**♣	■**	■	■
Field Day	B	NR*	K124	■♣	■♣	■♣	■♣
Foil Rap	A	NR	W535	○	○	○	○
Forza	B	NR*	K584	○	○	○	○
Fox Trot CR	C	NR	HC777	■	■	■	■
Gala	C	NR	K558	■**♣	■**♣	■♣	■♣
Gibson	G	NR	K1086	■**	■**	■	■
Grande	B	NR*	K180	■**	■**	■	■
Groove Line	F	NR	K488	■	■	■	■
Gusto CR	B	NR	HC759	■**	■**	○	■
Harrison	D	NR	K1084	■**	■**	■	■
Haze	G	NR	K109	■	■	■	■
Heavy Metal	A	NR	W539	○	○	○	○
Highline CR	C	NR	HC1064	■**	■**	■	■
Hologram	D	NR	K500	■**	■**♣	■♣	■
Hula Hoop	C	NR	K753	■**♣	■**	■	■
Icon	F	NR	K1028	■♣	■	■	■
In The Loop	D	NR	K490	■	■	■	○
Kaleidoscope CR	C	NR	HC1186	○	○	○	■
Kimono	E	NR	K1174	■**	■**	■	■
Knoll Felt	B	NR	K1207	■	■	■	■
Knoll Hopsack	B	NR	K1206	■	■	■	■
Knoll Velvet	I	RR	K784	○	○	○	○
Kora CR	C	NR	HC1010	■**	■**	■	■
Legend CR	C	NR	HC1124	○	○	○	○
Lore CR	C	NR	HC1123	■**	■**^	■	■
Luberon	E	NR	K676	■	■	■	■
Lyonese Velvet	H	NR*	K530	■	■	○	○
Lyric	B	NR	K698	■	■	■	■
Madison	E	NR	K1085	■**	■**	○	○
Mamba	E	NR	K549	■	■	■	■
Mariner	A	NR*	K642	■**	■**	■	■
Masquerade	D	NR	K806	■	■	■	■
Metaphor	A	NR	K612	■**	■**	■	○
Metro	C	NR	K1018	■**	■**	○	○
Mini Stitch	B	RR	K1130	■**♣	■**♣	■♣	■♣
Monarch	A	NR	K1149	■♣	■♣	■♣	■♣
Moto CR	C	NR	HC1002	■♣	■♣	■♣	■
Night Life	B	NR	K181	■	■	○	■
Nonchalant CR	B	NR	HC198	○	○	○	■
Obi	D	NR	K1175	■	■	■	■
Panache CR	C	NR	HC1047	■**	■**	■	■
Paradigm	B	NR	K1101	■	■	■	■
Parasol	C	NR	HC1257	■**	■**	■	■
Plain Linen	D	NR	K1310	○	○	○	○

■=Available

○=Not Available

♣=Cal 133 Pre-approved

*=Can be Railroad Cut

**=Not available with upholstered outer back

Textile Name	Life Back Topper	Life Seat Topper	Moment	RPM Side	RPM Task	Sapper
Fast Forward	○	○	○	○	○	○
Fibra	■	■	■ [△]	○	■	■
Field Day	■ [△]	■ [△]	■ [△]	■ [△]	■ [△]	■ [△]
Foil Rap	○	○	○	○	○	○
Forza	○	○	○	○	○	○
Fox Trot CR	■	■	■	○	■	■
Gala	■ [△]	■ [△]	■ [△]	○	■ [△]	■ [△]
Gibson	■	■	■ [△]	○	■	○
Grande	■	■	■	○	■	■
Groove Line	■	■	■	○	■	■
Gusto CR	■	■	■	○	■	○
Harrison	■	■	■ [△]	■	■	■
Haze	■	■	■	○	■	■
Heavy Metal	○	○	○	○	○	○
Highline CR	■	■	■	○	■	■
Hologram	■	■	■	○	■	■
Hula Hoop	■ [△]	■ [△]	■	■	■	■
Icon	■ [△]	■ [△]	■ [△]	○	■	■
In The Loop	■	■	○	○	■	■
Kaleidoscope CR	○	○	○	○	○	○
Kimono	■	■	■ [△]	○	■	■
Knoll Felt	■ [△]	■ [△]	■ [△]	○	■ [△]	■
Knoll Hopsack	■ [△]	■ [△]	■ [△]	○	■ [△]	■
Knoll Velvet	○	○	○	○	○	○
Kora CR	■	■	■	○	■	■
Legend CR	○	○	○	○	○	○
Lore CR	■	■	■	○	■	■
Luberon	■	■	■	○	■	■
Lyonese Velvet	○	○	○	○	■	■
Lyric	■	■	■	○	■	■
Madison	○	○	○	○	○	■
Mamba	■	■	■	○	■	■
Mariner	■	■	■ [△]	■	■	■ [△]
Masquerade	■	■	■	○	■	■
Metaphor	○	○	○	○	■	■
Metro	○	○	■ ^{***} [△]	○	■	■
Mini Stitch	■ [△]	■ [△]	■ [△]	○	■ [△]	■ [△]
Monarch	■ [△]	■ [△]	■ [△]	■ [△]	■ [△]	■ [△]
Moto CR	■	■	■	○	■	■
Night Life	○	○	■	○	■	■
Nonchalant CR	○	■	○	○	■	■
Obi	■	■	■ [△]	○	■	■
Panache CR	■	■	■	■	■	■
Paradigm	■ [△]	■ [△]	■ [△]	■	■	■
Parasol	■	○	■	○	○	■
Plain Linen	○	○	■	○	○	■

Textile Name	Grade	Direction	Part #	EWC Pro & EWC Tech Side	EWC Pro & EWC Tech Task	EWC Sport	Generation by Knoll
Plus	E	NR	K423	■	■	■	■
Pogo	B	NR	K1100	■**♣	■**♣	■♣	○
Pony Up	C	RR	K1323	○	○	○	■
Pop	B	NR*	K782	■**	■**	■	○
Posh	C	NR	K1163	○	○	○	○
Prep	A	NR	K1076	■**♣	■**	■	■♣
Presto	A	NR	K1000	■♣	■♣	■♣	■♣
Quark	C	NR	K781	■	■	■	■
Ransom	B	NR	K1298	■	■	■	■
Rattan	G	NR*	K138	■**	■**	■	■
Regard CR	C	NR	HC1063	○	○	○	■
Ricochet	B	NR*	K498	■♣	■♣	■♣	■♣
Rio	C	NR	K1164	■**	■**	■	■
Rivington	F	NR	K1080	■	■	■	■
Roundtrip	C	NR	K1430	■**♣	■**♣	■♣	■
Sahara	C	NR	HC1269	■	■	■	○
Sandpiper	C	NR	HC1258	○	○	■	■
Satellite	D	NR*	K503	■♣	■	■	■
Satin Chisel	D	NR	K487	■	■	■	○
Sequin CR	C	NR	HC1009	■	■	■	■
Smart	C	NR	K1268	■	■	■	■
Spark	B	NR	K1075	■♣	■	■	■♣
Spectator	C	NR	K1391	■**♣	■**♣	■♣	■
Spencer	G	NR	K1106	■**	■**	○	■
Spot On	C	NR	K1324	■	■	■	■
Spotlight	B	NR	K772	■	■	■	■
Stacks	A	NR	K528	■	■	■	■
Star Struck	C	NR	K1048	■**♣	■**	■	■
Starry Night	B	NR*	K529	■♣	■♣	■♣	■♣
Stepping Stones	C	RR	K346	■**	■**	■	■
Swing	C	NR	K479	■	■	■	■
Techno Tweed	B	NR*	K771	■	■	○	○
Topography	F	NR	K1052	■	■	■	■
Transition	C	NR	K816	■**♣	■**♣	■♣	■♣
Treble CR	C	NR	HC1062	■	■	■	■
Triple Lace	B	NR	K1116	○	○	○	○
Tweed Frieze	F	NR	K754	○	○	○	○
Ultrasuede	G	NR	K1021	■**♣	■**♣	■♣	■♣
Una	F	NR	K451	■**	■**	■	■
Utmost	B	NR	K1325	■**	■**	○	○
Vibe	C	NR*	K1029	○	○	○	○
Vinyl	B	ND	K242	■**	■**	○	○
Whip	E	NR	K1386	■	■^	■	■
Wide Angle	B	NR	K244	■♣	■♣	■♣	■♣
Zari CR	C	NR	HC1008	■**	■**	■	■
Zephyr	B	NR	K724	■**	■**	■	■
Zoom	D	NR	K113	■**	■**♣	○	■

■=Available

○=Not Available

♣=Cal 133 Pre-approved

*=Can be Railroad Cut

**=Not available with upholstered outer back

Textile Name	Life Back Topper	Life Seat Topper	Moment	RPM Side	RPM Task	Sapper
Plus	■	■	■ ♠	○	■	■
Pogo	■	○	■ ♠	○	○	■ ♠
Pony Up	■	■	■	○	■	■
Pop	○	○	○	○	■	○
Posh	○	○	○	○	○	○
Prep	○	○	■ ♠	○	○	■ ♠
Presto	■ ♠	■ ♠	■ ♠	○	■ ♠	■ ♠
Quark	■	■	■	■	■	■
Ransom	■	■	■	■	■	■
Rattan	■	■	■	■	■	■
Regard CR	■ ♠	■ ♠	■	○	○	■
Ricochet	■ ♠	■ ♠	■ ♠	○	■	○
Rio	■	■	■	○	■	■
Rivington	■	■	■	■	■	■
Roundtrip	■ ♠	■ ♠	■ ♠	○	■ ♠	■ ♠
Sahara	■	○	■	○	○	■
Sandpiper	■	■	■	○	■	■
Satellite	■	■	■ ♠	○	■	■
Satin Chisel	○	○	○	■	■	■
Sequin CR	■ ♠	■ ♠	■	○	■	■
Smart	■	■	■	○	○	■
Spark	■ ♠	■ ♠	■ ♠	○	■ ♠	■ ♠
Spectator	■ ♠	■ ♠	■ ♠	○	■ ♠	■ ♠
Spencer	○	○	○	○	○	○
Spot On	■	■	■	○	■	■
Spotlight	■	■	■	○	■	■
Stacks	■	■	■	○	■	■
Star Struck	■	■	■ ♠	○	■	■
Starry Night	■ ♠	■ ♠	■ ♠	■	■	■ ♠
Stepping Stones	■	■	■	○	■	■
Swing	■	■	■	■	■	■
Techno Tweed	○	○	○	○	■	○
Topography	■ ♠	■ ♠	■	○	■	■
Transition	■ ♠	■ ♠	■ ♠	■ ♠	■ ♠	○
Treble CR	■ ♠	■ ♠	■	○	■	■
Triple Lace	○	○	○	○	○	○
Tweed Frieze	○	○	○	○	○	■
Ultrasuede	■	■	■ ♠	○	○	■ ♠
Una	■	■	○	○	■	■
Utmost	■	■	■	○	■	■
Vibe	■	■	■	○	■	○
Vinyl	○	○	○	○	■	○
Whip	■	■	■ ♠	○	■	■
Wide Angle	■ ♠	■ ♠	○	○	■	■ ♠
Zari CR	■ ♠	■ ♠	■	○	■	■
Zephyr	■	■	■	○	■	■
Zoom	○	○	■ *** ♠	○	○	■

This page intentionally left blank

For the ultimate in comfort, durability, and prestige, many Knoll Office Seating products can be upholstered in Spinneybeck leathers.

Spinneybeck leathers are made from the top 2% of the world's finest hides, inspected numerous times during production.

After tanning, all Spinneybeck leathers are drum-dyed, a time-consuming procedure which ensures color penetration throughout the hide. Then each hide is finished in the manner which will best bring out its individual character.

Spinneybeck leathers are all full-grain aniline drum-dyed products imported from Italy.

The following Spinneybeck leathers are approved for application on Knoll Office Seating products. Leathers are grouped into five price categories referred to as "grades." The selection of approved leathers varies by product. Please refer to the pricing page for each product line for more information.

Square footage requirements for Customer's Own Leather (COL) are listed on each chair's pricing page. Please refer to COM Seating Process Overview for further information regarding COL.

For further information, call Spinneybeck at 1 800 482-7777.

Grades

T

Vicenza

Characteristics

Finished cowhide, corrected grain that is slightly raised; 20 colorways.

U

Verona

Finished cowhide, corrected grain and raised texture; 11 colorways.

Volo

Finished cowhide, corrected grain, slightly raised grain texture; 56 colorways.

V

Acqua

Water-repellent finished cowhide, corrected grain, slightly raised grain texture; 66 colorways.

Andes

Slightly pronounced grain, finished cowhide and enhanced grain; 59 colorways.

España

Smooth, tight grain cowhide; breathable, protective finish, enhanced grain; 75 colorways.

Hand Tipped

Two-toned leather, lightly finished cowhide, pronounced pebble grain texture; 34 colorways.

Maremma

Full grain textured suede with impregnated soil-resistant treatment; 17 colorways.

Velluto Pelle

Slightly pronounced grain, finished cowhide and enhanced grain; 67 colorways.

W

Alaska

Pearlized-iridescent protective finish cowhide, full grain with smooth texture; 22 colorways.

Amazon

Mid-weight, full grain cowhide; colors of the Amazonian jungle, raised grain texture; 22 colorways.

Antique

Smooth tight grain cowhide, lightly antiqued to produce an elegant patina, enhanced grain; 7 colorways.

Arizona

Full grain, lightly finished kip; ironed for tight, smooth texture, glove-like hand; 42 colorways.

Derby

Combination-tanned cowhide; full grain, lightly finished and raised grain texture; 26 colorways.

Forte

High performance, full grain leather with slightly pronounced grain texture. 81 colorways.

Lucente

Smooth, very tight grain cowhide; subtle sheen; light casein finish; 17 colorways.

Sabrina

Smooth, tight and full grain cowhide with a breathable protective finish; 114 colorways.

X

Ducale

Embossed shrunken grain cowhide with protective finish, full grain; 13 colorways.

Ducale Velour

Full grain-sueded cowhide, embossed shrunken grain, scotch-guarded; 36 colorways.

Y

Capri

Chrome-free, light protective finish, full grain cowhide; 10 colorways.

Cervo

Full aniline, cowhide, pronounced grain texture, extremely soft and supple hand, 13 colorways.

Copenhagen

Full aniline, 100% vegetable tanned leather, full grain; 14 colorways.

Cordovan

Aniline-dyed cowhide, light waxy finish, supple hand, full grain; 18 colorways.

Distressed

Aniline-dyed, paraffin wax final ironing process with a smooth finish, and full grain; 4 colorways.

Marissa

Grain-sueded cowhide, smooth suede grain with soil resistant treatment; 19 colorways.

Portofino

Full grain, lightly finished cowhide with a pronounced raised texture; 21 colorways.

Prima

Full aniline, special oils provide a very elegant and supple hand; 8 colorways.

Riva

Slightly pronounced grain texture, water-repellent, full grain; 16 colorways.

Saddle

Full aniline, smooth very tight grain surface takes on a rich patina over time; 23 colorways.

Salon

Full aniline cowhide, ironing process provides a lustrous sheen of traditional leathers; 8 colorways.

Leather Name	Grade	Part #	EWC Pro & EWC Tech Side	EWC Pro & EWC Tech Task	EWC Sport	Generation by Knoll
Acqua	V	AU	■ ♣	■ ♣	■ ♣	■ ♣
Alaska	W	AL	■ ♣	■ ♣	■ ♣	■ ♣
Amazon	W	AM	○	○	○	■
Andes	V	AD	■ ♣	■ ♣	■ ♣	■ ♣
Antique	W	AQ	■ ♣	■ ♣	■ ♣	■ ♣
Arizona	W	AR	■	■	■ ♣	■ ♣
Capri	Y	CP	○	○	○	■
Cervo	Y	CV	■	■	■	■
Copenhagen	Y	CO	■**	■**	■	■
Cordovan	Y	CD	○	○	○	■ ♣
Derby	W	DE	○	○	○	■
Distressed	Y	DT	■**	■**	■	■
Ducale	X	DL	○	○	○	■
Ducale Velours	X	DV	○	○	○	■
España	V	ES	■ ♣	■ ♣	■ ♣	■ ♣
Forte	W	FE	■ ♣	■ ♣	■ ♣	■ ♣
Hand Tipped	V	HT	○	○	○	■
Lucente	W	LU	○	○	○	○
Maremma	V	MM	○	○	○	■
Marissa	Y	MA	■ ♣	■ ♣	■ ♣	■ ♣
Portofino	Y	PT	○	○	○	○
Prima	Y	PR	■ ♣	■ ♣	○	■ ♣
Riva	Y	RA	■	■	■ ♣	■ ♣
Sabrina	W	SA	■ ♣	■ ♣	■ ♣	■ ♣
Saddle	Y	SL	○	○	○	○
Salon	Y	SN	○	○	○	■
Velluto Pelle	V	VP	■ ♣	■ ♣	■ ♣	■ ♣
Verona	U	VR	■	■	■ ♣	■
Vicenza	T	VZ	■	■	■ ♣	■ ♣
Volo	U	VO	■ ♣	■ ♣	■ ♣	■ ♣

Leather Name	Life Back Topper	Life Seat Topper	Moment	RPM Side	RPM Task	Sapper
Acqua	■ ♣	■ ♣	■ ♣	○	■	■ ♣
Alaska	■ ♣	■ ♣	■ ♣	○	■	■ ♣
Amazon	■	■	■ ♣	○	○	■
Andes	■ ♣	■ ♣	■ ♣	○	■	■ ♣
Antique	■ ♣	■ ♣	■ ♣	○	■	■ ♣
Arizona	■ ♣	■ ♣	■ ♣	○	■	■ ♣
Capri	■	■	■ ♣	○	■	■
Cervo	■	■	■	○	■	■
Copenhagen	■	■	■ ♣	○	■	■
Cordovan	■ ♣	■ ♣	■ ♣	○	■	■ ♣
Derby	■	■	■ ♣	○	■	■
Distressed	■	■	■ ♣	○	■	■
Ducale	○	○	○	○	○	■
Ducale Velours	○	○	○	○	○	■
España	■ ♣	■ ♣	■ ♣	○	■	■ ♣
Forte	■ ♣	■ ♣	■ ♣	○	■	■ ♣
Hand Tipped	○	■	■ ♣	○	○	■
Lucente	○	○	○	○	○	■ ♣
Maremma	■	■	■ ♣	○	○	○
Marissa	■ ♣	■ ♣	■ ♣	○	○	■ ♣
Portofino	○	○	■ ♣	○	○	■
Prima	■ ♣	■ ♣	■ ♣	○	○	■ ♣
Riva	■ ♣	■ ♣	■ ♣	○	○	■ ♣
Sabrina	■ ♣	■ ♣	■ ♣	○	■	■ ♣
Saddle	○	○	○	○	○	■
Salon	○	■	■ ♣	○	○	■
Velluto Pelle	■ ♣	■ ♣	■ ♣	○	■	■ ♣
Verona	■ ♣	■ ♣	■ ♣	○	■	■
Vicenza	■ ♣	■ ♣	■ ♣	■	■	■ ♣
Volo	■ ♣	■ ♣	■ ♣	■	■	■ ♣

Any of our leather grades may be perforated with any of the patterns shown below to create a crisp, contemporary look.

Perforated Leather is a specialty product, available only on a custom order basis. Please use pattern numbers below. Perforated Leather is available in half hides only. Not recommended on outside back applications (e.g. Bulldog)

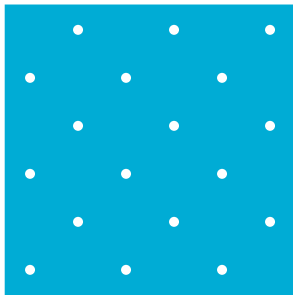

Pattern #265
.052 in. diameter
diagonal pattern
8 holes per square inch

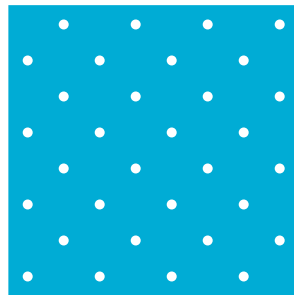

Pattern #330
.052 in. diameter
diagonal pattern
12 holes per square inch

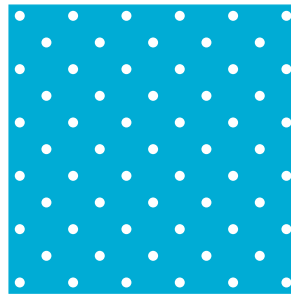

Pattern #457
.052 in. diameter
diagonal pattern
21 holes per square inch

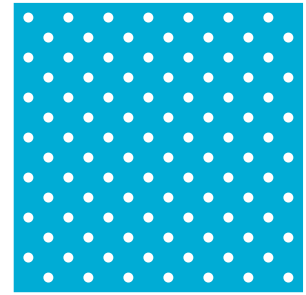

Pattern #914
Mini Perf
.052 in. diameter
straight line pattern
70 holes per square inch

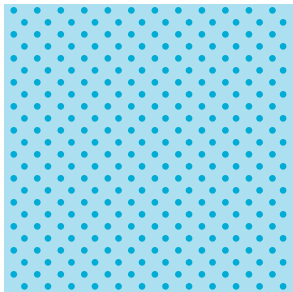

Pattern #528
Emossed Micro Perf
.050 in. diameter
staggered pattern
75 holes per square inch

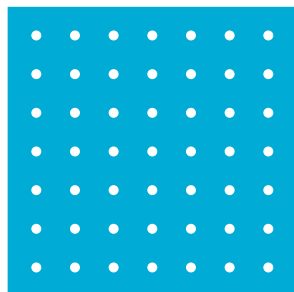

Pattern #1875
.052 in. diameter
diagonal pattern
25 holes per square inch

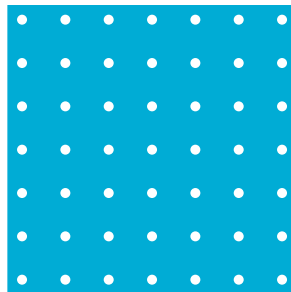

Pattern #0250S
.052 in. diameter
straight line pattern
16 holes per square inch

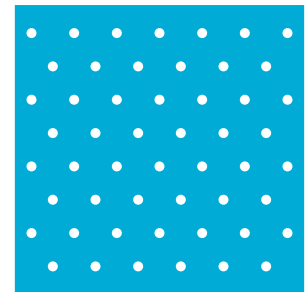

Pattern #560
.052 in. diameter
staggered pattern
22 holes per square inch



Pattern #280*
.052 in. diameter
staggered pattern
7 holes per square inch

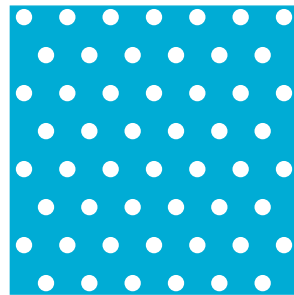

Pattern #560-85
.085 in. diameter
staggered pattern
20 holes per square inch

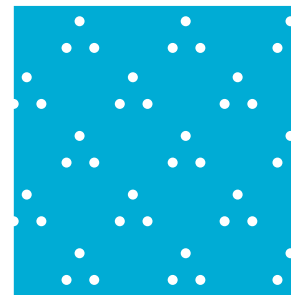

Pattern Tri-Star
Multiple Diamond
.052 in. diameter
staggered pattern
18 holes per square inch

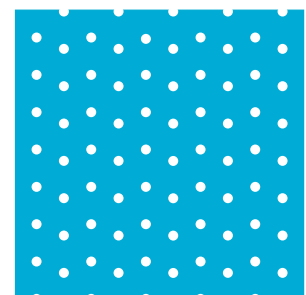



Pattern #1250
.052 in. diameter
staggered pattern
35 holes per square inch

* Not available on Bulldog Side Chair or RPM

This page intentionally left blank

Sapper™ executive chair

	arm	description	pattern no.
Designer(s): Richard Sapper, 1979 Award(s): IBD Product Design Award, 1985	Cantilevered 	Advanced knee-tilt control, no lumbar, pneumatic seat height adjustment	45A3-A5G-H
	Armless 	Pneumatic seat height adjustment	45C3-A5G-H

Order Code	Ordering Information	Options	Construction
<i>Example:</i> 45A3-A5G-H-VO947	<i>Specify:</i>	<i>Code: Upchg: Description:</i>	<i>Finish color:</i>
45A3 Sapper executive armchair	1. Pattern number	L \$247 Height-adjustable	Black
A5G Advanced knee-tilt control with pneumatic seat height adjustment	2. Upholstery selection with color	lumbar (5" range) (substitute L for G)	<i>Internal construction:</i>
H 2" dual, hooded hard-wheel casters	List prices shown include fabric or leather upholstery. Contact your Knoll representative for colors.	C \$145 CAL 133 upholstery (add C to end)	Steel perimeter frame. Elastic webbed straps suspended between seat frame. Steel internal back support structure.
VO947 Volo/Coffee Bean	<i>COM/COL ordering information:</i>	R \$50 Soft caster for hardwood floors (substitute R for H)	<i>Upholstery:</i>
<i>Example for Cal 133:</i>	For Customer's Own Material/Leather, see approval requirements, important processing instructions and full ordering information in the Fabric Application and Selling Policy sections of the Price List.		High resilient, variable density molded urethane foam. Polyester batting with quilted, horizontally stitched cover. Standard upholstered back.
45A3-A5G-H-C-VO947	When specifying suede and shrunken cowhide, add 10% to the leather square footage requirement. When specifying calf-skin, add 15% to the leather square footage requirement.		<i>Standard cantilevered arms:</i> Integrally colored, textured, self-skinning polyurethane over steel insert.

grades	COM									COL				
A	B	C	D	E	F	G	H	I	T	U	V	W	X	Y
\$2,333.	\$2,394.	\$2,455.	\$2,499.	\$2,539.	\$2,572.	\$2,611.	\$2,710.	\$2,887.	\$3,058.	\$3,160.	\$3,326.	\$3,861.	\$3,935.	\$3,961.
2,231.	2,292.	2,352.	2,395.	2,434.	2,469.	2,510.	2,608.	2,786.	2,955.	3,057.	3,223.	3,755.	3,831.	3,859.

Optional adjustable lumbar:
Lumbar contour mechanically adjusts 4" vertically by activating lever under left side of the seat.

Available on either Advanced or Basic control models.

Column cover:
Integrally colored, textured plastic.

Base:
Die cast aluminum with epoxy finish. Five-star design.

Casters:
Black, integrally colored, textured nylon; 2" dual, hooded hard-wheel or soft-wheel design.

Controls

Advanced knee-tilt control:
360° swivel, knee-tilt with tilt tension, forward tilt, upright and forward tilt lock and pneumatic seat height adjustments.

COM/COL Textile Requirement



	<i>fabric</i>	<i>leather</i>
	<i>yds</i>	<i>sq. ft.</i>
chair	2.0	35

Cal 133:
‡ = Cal 133 upholstery available. See textile matrix at the beginning of the Price List for pre-approved Cal 133 textiles.

KnollTextiles and Spinneyback Leathers

Please refer to the matrices at the beginning of the price list for Approved Textiles and Leathers.

Sapper™ management chair

	arm	description	pattern no.
<p><i>Designer(s):</i> Richard Sapper, 1979</p> <p><i>Award(s):</i> IBD Product Design Award, 1985</p> 	<p>Cantilevered</p> 	<p>Advanced knee-tilt control, pneumatic seat height adjustment</p>	<p>45A1-A5G-H</p>
	<p>Armless</p> 	<p>Pneumatic seat height adjustment</p>	<p>45C1-A5G-H</p>

Order Code	Ordering Information	Options	Construction
<p><i>Example:</i> 45A1-A5G-H-VOBLK</p> <p>45A1 Sapper management armchair</p> <p>A5G Advanced knee-tilt control with pneumatic seat height adjustment</p> <p>H 2" dual, hooded hardwheel casters</p> <p>VOBLK Volof/Black</p> <p><i>Example for Cal 133:</i> 45A1-A5G-H-C-VOBLK</p>	<p><i>Specify:</i></p> <ol style="list-style-type: none"> 1. Pattern number 2. Upholstery selection with color <p>List prices shown include fabric or leather upholstery. Contact your Knoll representative for colors.</p> <p><i>COM/COL ordering information:</i> For Customer's Own Material/Leather, see approval requirements, important processing instructions and full ordering information in the Fabric Application and Selling Policy sections of the Price List.</p> <p>When specifying suede and shrunken cowhide, add 10% to the leather square footage requirement. When specifying calf-skin, add 15% to the leather square footage requirement.</p>	<p><i>Code: Upchg: Description:</i></p> <p>L \$247 Adjustable lumbar (substitute L for G)</p> <p>C \$145 CAL 133 upholstery (add C to end)</p> <p>R \$50 Soft caster for hardwood floors (substitute R for H)</p>	<p><i>Finish color:</i> Black</p> <p><i>Internal construction:</i> Steel perimeter frame. Elastic webbed straps suspended between seat frame. Steel internal back support structure.</p> <p><i>Upholstery:</i> High resilient, variable density molded urethane foam. Polyester batting with quilted, horizontally stitched cover. Standard upholstered back.</p> <p><i>Standard cantilevered arms:</i> Integrally colored, textured, self-skinning polyurethane over steel insert.</p>

grades	COM										COL				
A	B	C	D	E	F	G	H	I	T	U	V	W	X	Y	
\$1,984.	\$2,033.	\$2,085.	\$2,121.	\$2,156.	\$2,184.	\$2,217.	\$2,299.	\$2,454.	\$2,602.	\$2,685.	\$2,825.	\$3,286.	\$3,350.	\$3,370.	
1,880.	1,930.	1,984.	2,019.	2,053.	2,081.	2,116.	2,199.	2,351.	2,498.	2,582.	2,722.	3,183.	3,246.	3,266.	

Optional adjustable lumbar:
Lumbar contour mechanically adjusts 4" vertically by activating lever under left side of the seat.

Available on either Advanced or Basic control models.

Column cover:
Integrally colored, textured plastic.

Base:
Die cast aluminum with epoxy finish. Five-star design.

Standard casters:
Black, integrally colored, textured nylon; 2" dual, hooded hard-wheel design.

Controls

Advanced knee-tilt control:
360° swivel, knee-tilt with tilt tension, forward tilt, upright and forward tilt lock and pneumatic seat height adjustments.

COM/COL Textile Requirement

	<i>fabric</i>	<i>leather</i>
	<i>yds</i>	<i>sq. ft.</i>
chair	1.7	30

Cal 133:
‡ = Cal 133 upholstery available. See textile matrix at the beginning of the Price List for pre-approved Cal 133 textiles.

KnollTextiles and Spinneybeck Leathers

Please refer to the matrices at the beginning of the price list for Approved Textiles and Leathers.

Sapper™ Dimensions and Operating Instructions

Seat*		
	Executive (Pneumatic)	Manager (Pneumatic)
Seat Height	17" - 20.5"	17" - 20.5"
Seat Depth	18"	18"
Seat Width	22.5"	20.5"
Seat Pan Angle	6.5°	6.5°
Seat Back/Seat Pan Angle	95°	95°

Back*		
Seat Back Width	22.5"	22.5"
Lumbar Support Height	8"	8"
Lumbar Support Width	16.5"	16.5"
Lumbar Support Center	7.5"	7.5"

Arms*		
Width Between Armrests	22.5" minimum	20.5"

* All measurements taken with BIFMA Chair Measuring Device using the Universal Measurement Procedure which has a measurement uncertainty of $\pm 5\%$

Sapper Chair Measurements

	Executive (Pneumatic)	Manager (Pneumatic)
A. Overall Height	40.75" - 43.875"	33.75" - 37.25"
B. Overall Width	26.75"	24.75"
C. Overall Depth	28.75"	28"
D. Arm Height from Floor	23.5" - 27"	23.5" - 27"
E. Base dimensions	28" diameter	28" diameter
Weight with arms	55.5 lbs.	51 lbs.

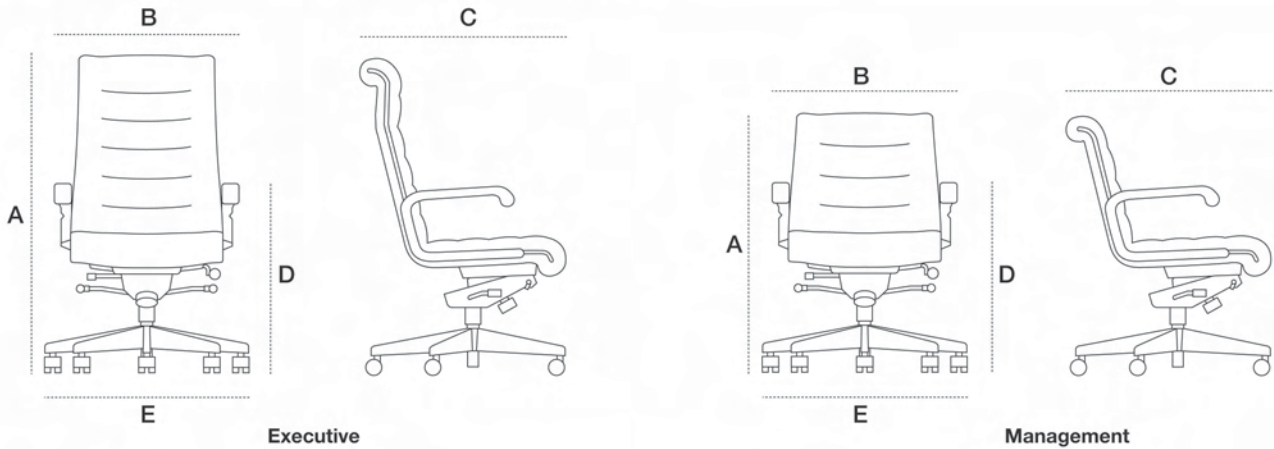

Sapper - Additional Information

Compliancy: ANSI/BIFMA X5.1 : 1993 (U.S. structural standard), California T.B. 117 (U.S. flammability standard for urethane foam), California T.B. 133 with approved FR textile (U.S. flammability standard for full chair),

The Sapper chair line has been tested and is approved for use by individuals weighing up to 300 pounds.

Sapper™ Operating Instructions



Pneumatic Seat Height Adjustment

To adjust the height, lift the handle on the right side of the seat.

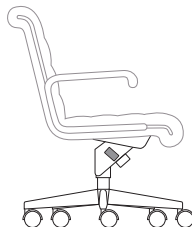

Tilt Lock

To lock the chair upright, push down on the handle under the left side of the chair. Pull up to release.

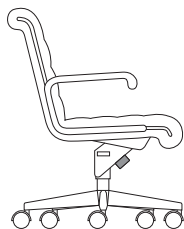

Tension Adjustment

Lean back and recline. If tension needs adjusting, reach under the front-center of the seat and increase tension by turning the knob to the left, or decrease tension by turning the knob to the right.

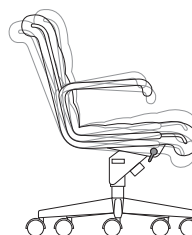

Forward Tilt

Reach under the right side of the chair toward the front and twist the lever to the front while slightly reclining to activate forward tilt.

To deactivate forward tilt, recline slightly and twist the lever to the rear.

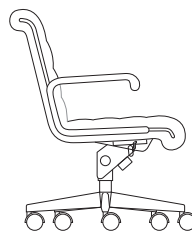

Adjustable Lumbar Support

(optional)



To raise the lumbar support, slide the curved lever on the left side of the chair toward the rear of the chair. To lower the lumbar, slide the lever toward the front edge of the chair.

Life®

plastic base, knitted seat topper, no back topper

	arm	description	pattern no. *
<p><i>Designer(s):</i> Formway Design Studio, 2002</p> <p><i>Award(s):</i> Good Design Award, Chicago Athenaeum, 2003, USA NeoCon Gold, Best of NeoCon, Task Chair - Seating Design, June 2002, USA IIDEX/NeoCon, Sustainable Design Gold Award, 2002, Canada</p> 	Armless	Plastic base, Life Knitted Seat Topper (KST), no back topper	55C-3-(2 or 6)-A-5-K-GH BSF()-KST()-NB
	Fixed Plastic	Plastic base, Life Knitted Seat Topper (KST), no back topper	55A-3-(2 or 6)-A-5-K-GH BSF()-KST()-NB
	Fixed Aluminum	Plastic base, Life Knitted Seat Topper (KST), no back topper	55M-3-(2 or 6)-A-5-K-GH BSF()-KST()-NB
	Height Adjustable	Plastic base, Life Knitted Seat Topper (KST), no back topper	55H-3-(2 or 6)-A-5-K-GH BSF()-KST()-NB
	High Performance	Plastic base, Life Knitted Seat Topper (KST), no back topper	55P-3-(2 or 6)-A-5-K-GH BSF()-KST()-NB

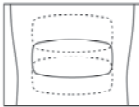
*For specification directions, please see page 44.
For upholstery selections and pricing see facing page.

Order Code	Ordering Information	Options
<p><i>Example:</i> 55H-3-6-A5K-GH-BSF33-ST-K1206/9-NB</p> <p>55 Life chair</p> <p>H Height adjustable arms</p> <p>3 High back</p> <p>6 Grey base and grey levers</p> <p>A Advanced control with sliding seat</p> <p>5 Standard height cylinder</p> <p>K No lumbar</p> <p>GH Grey hard caster</p> <p>BSF33 Plum Back Suspension Fabric</p> <p>ST-K1206/9 Knoll Hopsack, Magenta seat topper</p> <p>NB No back topper</p>	<p><i>Specify:</i></p> <ol style="list-style-type: none"> 1. Pattern number with back suspension fabric BSF(). 2. Seat topper textile, either KST() for knitted seat topper or ST() for fabric or leather. NS for no seat topper. 3. Back topper textile, BT() for fabric or leather. NB for no back topper. <p>Options</p> <p><i>Armpad Options:</i> For leather armpads, add J after the arm pattern code (Example: 55PJ) and specify leather. Available in Spinneybeck Volo (Grade U) and Sabrina (Grade W) leathers.</p> <p><i>Code: Upchg: Description:</i> J \$258 Spinneybeck Volo J \$347 Spinneybeck Sabrina</p> <p><i>Base Options:</i></p> <p><i>Code: Upchg: Description:</i> 2 n/c black plastic base 6 n/c grey plastic base</p>	<p><i>Cylinder Height Options:</i> For height ranges see Life Dimensions and Operating Instructions. Replace 5 in pattern with one of the following options:</p> <p><i>Code: Upchg: Description:</i> L n/c low cylinder H n/c high cylinder</p> <p><i>Lumbar Options:</i> For lumbar, replace K with L() in the pattern number. Specify color code in the parentheses after L.</p> <p><i>Code: Upchg: Description:</i> L(K1029/13) \$98 Vibe, Glam L(K1029/14) \$98 Vibe, Poise L(K1029/BLK) \$98 Vibe, Black</p> <p><i>Lumbar detail</i></p>  <p><i>Caster Options:</i> Replace GH in pattern with one of the following options:</p> <p><i>Code: Upchg: Description:</i> BH n/c hard black caster BR \$42 soft black caster GR \$42 soft grey caster CH \$25 hard clear caster CR \$67 soft clear caster</p> <p><i>Glides:</i> Replace GH in pattern with GG. No upcharge for this option.</p> <p><i>Glide detail</i></p> 

KST or COM	A	B	C	D	E	F	G	H	I	T	COL U	V	W	X	Y
\$1,243.															
1,403.															
1,454.															
1,458.															
1,538.															



Back Suspension Fabric - Standard**Knitted Seat Topper - Base Grade****Textile Options**

<i>Code:</i>	<i>Description:</i>	<i>Code:</i>	<i>Description:</i>		
BSF 15	Eclipse	KST 15	Eclipse/Blackout	Please refer to the matrices at the beginning of the price list for approved KnollTextiles fabrics and Spinneybeck leathers for seat and back toppers. <i>Ultra Seat Topper Options:</i> For ultra seat topper, which is 1/2" thicker foam than standard seat topper, add U before the seat topper pattern code. <i>Code: Upchg: Description:</i> UST \$59 Ultra Seat Topper in fabric or leather UKST \$59 Ultra Knitted Seat Topper <i>Perforated Leather Option:</i> For perforated patterns in leather seat and/or back toppers, insert PERF() after ST() and/or BT() in pattern number. Seat topper upcharge is \$105. Back topper upcharge is \$220. See Spinneybeck Leather Application section for pattern codes. COM/COL Textile Requirements <i>Seat Topper:</i> 0.7 yards fabric 9.0 sq ft leather <i>Back Topper:</i> 1.3 yards fabric 16.0 sq ft leather	<i>CAL 133 Options:</i> To meet Cal 133 requirements, Life must have seat topper or seat and back toppers with approved FR upholstery. Not compliant with KST. See textile matrix at the beginning of the price list for pre-approved Cal 133 textiles. # = Cal 133 pre-approved. Insert C after ST() option. See below for upcharges. <i>Code: Upchg: Description:</i> C \$81 CAL 133 fabric seat topper C \$277 CAL 133 fabric seat and back toppers C \$159 CAL 133 leather seat topper Minimum order of 3 chairs required C \$390 CAL 133 leather seat and back toppers. No minimum order required
BSF 17	Blackout	KST 18	Camel		
BSF 19	Beige	KST 19	Beige		
BSF 22	Grain	KST 31	Dark Blue		
BSF 31	Navy	KST 32	Scarlet		
BSF 32	Rouge	KST 33	Grape		
BSF 33	Plum	KST 36	Olive		
BSF 34	Sunset	KST 38	Dark Brown		
BSF 35	Avocado	KST 40	Dark Grey		
BSF 37	Bronze				
BSF 38	Chestnut				
BSF 39	Platinum				
BSF 40	Charcoal				
BSF 41	Frost				
			For no seat topper (NS), subtract \$51 from KST base grade list price.		
			Ordering Samples/Viewing online: To view BSF and KST colors see Surface Finish Library on knoll.com. Physical samples are the best representation of color. To order samples, contact a Knoll sales representative or Knoll dealer.		

Life®
plastic base, seat topper, no back topper

	arm	description	pattern no. *
<p><i>Designer(s):</i> Formway Design Studio, 2002</p> <p><i>Award(s):</i> Good Design Award, Chicago Athenaeum, 2003, USA NeoCon Gold, Best of NeoCon, Task Chair - Seating Design, June 2002, USA IIDEX/NeoCon, Sustainable Design Gold Award, 2002, Canada</p> 	Armless	Plastic base, fabric or leather seat topper, no back topper	55C-3-(2 or 6)-A-5-K-GH BSF()-ST()-NB
	Fixed Plastic	Plastic base, fabric or leather seat topper, no back topper	55A-3-(2 or 6)-A-5-K-GH BSF()-ST()-NB
	Fixed Aluminum	Plastic base, fabric or leather seat topper, no back topper	55M-3-(2 or 6)-A-5-K-GH BSF()-ST()-NB
	Height Adjustable	Plastic base, fabric or leather seat topper, no back topper	55H-3-(2 or 6)-A-5-K-GH BSF()-ST()-NB
	High Performance	Plastic base, fabric or leather seat topper, no back topper	55P-3-(2 or 6)-A-5-K-GH BSF()-ST()-NB

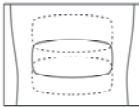
*For specification directions, please see page 44.
For upholstery selections and pricing see facing page.

Order Code	Ordering Information	Options
<p><i>Example:</i> 55H-3-6-A5K-GH-BSF33-ST-K1206/9-NB</p> <p>55 Life chair</p> <p>H Height adjustable arms</p> <p>3 High back</p> <p>6 Grey base and grey levers</p> <p>A Advanced control with sliding seat</p> <p>5 Standard height cylinder</p> <p>K No lumbar</p> <p>GH Grey hard caster</p> <p>BSF33 Plum Back Suspension Fabric</p> <p>ST-K1206/9 Knoll Hopsack, Magenta seat topper</p> <p>NB No back topper</p>	<p><i>Specify:</i></p> <ol style="list-style-type: none"> Pattern number with back suspension fabric BSF(). Seat topper textile, either KST() for knitted seat topper or ST() for fabric or leather. NS for no seat topper. Back topper textile, BT() for fabric or leather. NB for no back topper. <p>Options</p> <p><i>Armpad Options:</i> For leather armpads, add J after the arm pattern code (Example: 55PJ) and specify leather. Available in Spinneybeck Volo (Grade U) and Sabrina (Grade W) leathers.</p> <p><i>Code: Upchg: Description:</i> J \$258 Spinneybeck Volo J \$347 Spinneybeck Sabrina</p> <p><i>Base Options:</i></p> <p><i>Code: Upchg: Description:</i> 2 n/c black plastic base 6 n/c grey plastic base</p>	<p><i>Cylinder Height Options:</i> For height ranges see Life Dimensions and Operating Instructions. Replace 5 in pattern with one of the following options:</p> <p><i>Code: Upchg: Description:</i> L n/c low cylinder H n/c high cylinder</p> <p><i>Lumbar Options:</i> For lumbar, replace K with L() in the pattern number. Specify color code in the parentheses after L.</p> <p><i>Code: Upchg: Description:</i> L(K1029/13) \$98 Vibe, Glam L(K1029/14) \$98 Vibe, Poise L(K1029/BLK) \$98 Vibe, Black</p> <p><i>Lumbar detail</i></p>  <p><i>Caster Options:</i> Replace GH in pattern with one of the following options:</p> <p><i>Code: Upchg: Description:</i> BH n/c hard black caster BR \$42 soft black caster GR \$42 soft grey caster CH \$25 hard clear caster CR \$67 soft clear caster</p> <p><i>Glides:</i> Replace GH in pattern with GG. No upcharge for this option.</p> <p><i>Glide detail</i></p> 

KST or COM	A	B	C	D	E	F	G	H	I	T	COL U	V	W	X	Y
\$1,243.	\$1,294.	\$1,300.	\$1,325.	\$1,349.	\$1,366.	\$1,391.	\$1,403.	\$1,422.	\$1,447.	\$1,639.	\$1,669.	\$1,732.	\$1,881.	\$1,896.	\$1,983.
1,403.	1,454.	1,460.	1,485.	1,509.	1,526.	1,551.	1,563.	1,582.	1,607.	1,799.	1,829.	1,892.	2,041.	2,056.	2,143.
1,454.	1,505.	1,511.	1,536.	1,560.	1,577.	1,602.	1,614.	1,633.	1,658.	1,850.	1,880.	1,943.	2,092.	2,107.	2,194.
1,458.	1,509.	1,515.	1,540.	1,564.	1,581.	1,606.	1,618.	1,637.	1,662.	1,854.	1,884.	1,947.	2,096.	2,111.	2,198.
1,538.	1,589.	1,595.	1,620.	1,644.	1,661.	1,686.	1,698.	1,717.	1,742.	1,934.	1,964.	2,027.	2,176.	2,191.	2,278.

Back Suspension Fabric - Standard

Code:	Description:
BSF 15	Eclipse
BSF 17	Blackout
BSF 19	Beige
BSF 22	Grain
BSF 31	Navy
BSF 32	Rouge
BSF 33	Plum
BSF 34	Sunset
BSF 35	Avocado
BSF 37	Bronze
BSF 38	Chestnut
BSF 39	Platinum
BSF 40	Charcoal
BSF 41	Frost

Knitted Seat Topper - Base Grade

Code:	Description:
KST 15	Eclipse/Blackout
KST 18	Camel
KST 19	Beige
KST 31	Dark Blue
KST 32	Scarlet
KST 33	Grape
KST 36	Olive
KST 38	Dark Brown
KST 40	Dark Grey

For no seat topper (NS), subtract \$51 from KST base grade list price.

Ordering Samples/Viewing online:
To view BSF and KST colors see Surface Finish Library on knoll.com. Physical samples are the best representation of color. To order samples, contact a Knoll sales representative or Knoll dealer.

Textile Options

Please refer to the matrices at the beginning of the price list for approved Knoll Textiles fabrics and Spinneybeck leathers for seat and back toppers.

Ultra Seat Topper Options:

For ultra seat topper, which is 1/2" thicker foam than standard seat topper, add U before the seat topper pattern code.

Code:	Upchg:	Description:
UST	\$59	Ultra Seat Topper in fabric or leather
UKST	\$59	Ultra Knitted Seat Topper

Perforated Leather Option:

For perforated patterns in leather seat and/or back toppers, insert PERF() after ST() and/or BT() in pattern number. Seat topper upcharge is \$105. Back topper upcharge is \$220. See Spinneybeck Leather Application section for pattern codes.

COM/COL Textile Requirements

Seat Topper:
0.7 yards fabric
9.0 sq ft leather

Back Topper:
1.3 yards fabric
16.0 sq ft leather

CAL 133 Options:







To meet Cal 133 requirements, Life must have seat topper or seat and back toppers with approved FR upholstery. Not compliant with KST. See textile matrix at the beginning of the price list for pre-approved Cal 133 textiles. * = Cal 133 pre-approved.

Insert C after ST() option. See below for upcharges.



Code:	Upchg:	Description:
C	\$81	CAL 133 fabric seat topper
C	\$277	CAL 133 fabric seat and back toppers
C	\$159	CAL 133 leather seat topper Minimum order of 3 chairs required
C	\$390	CAL 133 leather seat and back toppers No minimum order required

Life®

plastic base, seat topper and back topper

	arm	description	pattern no. *
<i>Designer(s):</i> Formway Design Studio, 2002	Armless 	Plastic base, fabric or leather seat and back toppers	55C-3-(2 or 6)-A-5-K-GH BSF()-ST()-BT()
<i>Award(s):</i> Good Design Award, Chicago Athenaeum, 2003, USA NeoCon Gold, Best of NeoCon, Task Chair - Seating Design, June 2002, USA IIDEX/NeoCon, Sustainable Design Gold Award, 2002, Canada	Fixed Plastic 	Plastic base, fabric or leather seat and back toppers	55A-3-(2 or 6)-A-5-K-GH BSF()-ST()-BT()
	Fixed Aluminum 	Plastic base, fabric or leather seat and back toppers	55M-3-(2 or 6)-A-5-K-GH BSF()-ST()-BT()
	Height Adjustable 	Plastic base, fabric or leather seat and back toppers	55H-3-(2 or 6)-A-5-K-GH BSF()-ST()-BT()
	High Performance 	Plastic base, fabric or leather seat and back toppers	55P-3-(2 or 6)-A-5-K-GH BSF()-ST()-BT()

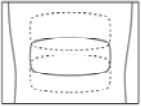
*For specification directions, please see page 44.
For upholstery selections and pricing see facing page.

Order Code	Ordering Information	Options
<i>Example:</i> 55H-3-6-A5K-GH-BSF33-ST-K1206/9-NB	<i>Specify:</i>	<i>Cylinder Height Options:</i>
55 Life chair	1. Pattern number with back suspension fabric BSF().	For height ranges see Life Dimensions and Operating Instructions. Replace 5 in pattern with one of the following options:
H Height adjustable arms	2. Seat topper textile, either KST() for knitted seat topper or ST() for fabric or leather. NS for no seat topper.	<i>Code: Upchg: Description:</i>
3 High back	3. Back topper textile, BT() for fabric or leather. NB for no back topper.	L n/c low cylinder
6 Grey base and grey levers		H n/c high cylinder
A Advanced control with sliding seat		
5 Standard height cylinder		<i>Lumbar Options:</i>
K No lumbar		For lumbar, replace K with L() in the pattern number. Specify color code in the parentheses after L.
GH Grey hard caster		<i>Code: Upchg: Description:</i>
BSF33 Plum Back Suspension Fabric	<i>Armpad Options:</i>	L(K1029/13) \$98 Vibe, Glam
ST-K1206/9 Knoll Hopsack, Magenta seat topper	For leather armpads, add J after the arm pattern code (Example: 55PJ) and specify leather. Available in Spinneybeck Volo (Grade U) and Sabrina (Grade W) leathers.	L(K1029/14) \$98 Vibe, Poise
NB No back topper		L(K1029/BLK) \$98 Vibe, Black
	<i>Code: Upchg: Description:</i>	<i>Lumbar detail</i>
	J \$258 Spinneybeck Volo	
	J \$347 Spinneybeck Sabrina	
	<i>Base Options:</i>	<i>Caster Options:</i>
	<i>Code: Upchg: Description:</i>	Replace GH in pattern with one of the following options:
	2 n/c black plastic base	<i>Code: Upchg: Description:</i>
	6 n/c grey plastic base	BH n/c hard black caster
		BR \$42 soft black caster
		GR \$42 soft grey caster
		CH \$25 hard clear caster
		CR \$67 soft clear caster
		<i>Glides:</i>
		Replace GH in pattern with GG. No upcharge for this option.
		<i>Glide detail</i>
		

KST or COM	A	B	C	D	E	F	G	H	I	T	COL U	V	W	X	Y
\$1,453.	\$1,540.	\$1,572.	\$1,628.	\$1,687.	\$1,731.	\$1,761.	\$1,879.	\$1,904.	\$1,942.	\$2,241.	\$2,359.	\$2,479.	\$2,942.	\$2,968.	\$3,099.
1,613.	1,700.	1,732.	1,788.	1,847.	1,891.	1,921.	2,039.	2,064.	2,102.	2,401.	2,519.	2,639.	3,102.	3,128.	3,259.
1,664.	1,751.	1,783.	1,839.	1,898.	1,942.	1,972.	2,090.	2,115.	2,153.	2,452.	2,570.	2,690.	3,153.	3,179.	3,310.
1,668.	1,755.	1,787.	1,843.	1,902.	1,946.	1,976.	2,094.	2,119.	2,157.	2,456.	2,574.	2,694.	3,157.	3,183.	3,314.
1,748.	1,835.	1,867.	1,923.	1,982.	2,026.	2,056.	2,174.	2,199.	2,237.	2,536.	2,654.	2,774.	3,237.	3,263.	3,394.

Back Suspension Fabric - Standard

Code:	Description:
BSF 15	Eclipse
BSF 17	Blackout
BSF 19	Beige
BSF 22	Grain
BSF 31	Navy
BSF 32	Rouge
BSF 33	Plum
BSF 34	Sunset
BSF 35	Avocado
BSF 37	Bronze
BSF 38	Chestnut
BSF 39	Platinum
BSF 40	Charcoal
BSF 41	Frost

Knitted Seat Topper - Base Grade

Code:	Description:
KST 15	Eclipse/Blackout
KST 18	Camel
KST 19	Beige
KST 31	Dark Blue
KST 32	Scarlet
KST 33	Grape
KST 36	Olive
KST 38	Dark Brown
KST 40	Dark Grey

For no seat topper (NS), subtract \$51 from KST base grade list price.

Ordering Samples/Viewing online:
To view BSF and KST colors see Surface Finish Library on knoll.com. Physical samples are the best representation of color. To order samples, contact a Knoll sales representative or Knoll dealer.

Textile Options

Please refer to the matrices at the beginning of the price list for approved Knoll Textiles fabrics and Spinneybeck leathers for seat and back toppers.

Ultra Seat Topper Options:
For ultra seat topper, which is 1/2" thicker foam than standard seat topper, add U before the seat topper pattern code.

Code:	Upchg:	Description:
UST	\$59	Ultra Seat Topper in fabric or leather
UKST	\$59	Ultra Knitted Seat Topper

Perforated Leather Option:
For perforated patterns in leather seat and/or back toppers, insert PERF() after ST() and/or BT() in pattern number. Seat topper upcharge is \$105. Back topper upcharge is \$220. See Spinneybeck Leather Application section for pattern codes.

COM/COL Textile Requirements

Seat Topper:
0.7 yards fabric
9.0 sq ft leather

Back Topper:
1.3 yards fabric
16.0 sq ft leather

CAL 133 Options:

To meet Cal 133 requirements, Life must have seat topper or seat and back toppers with approved FR upholstery. Not compliant with KST. See textile matrix at the beginning of the price list for pre-approved Cal 133 textiles. * = Cal 133 pre-approved.

Insert C after ST() option. See below for upcharges.

Code:	Upchg:	Description:
C	\$81	CAL 133 fabric seat topper
C	\$277	CAL 133 fabric seat and back toppers
C	\$159	CAL 133 leather seat topper
C	\$390	CAL 133 leather seat and back toppers



Minimum order of 3 chairs required
No minimum order required

Life®

aluminum base, knitted seat topper, no back topper

	arm	description	pattern no. *
<p><i>Designer(s):</i> Formway Design Studio, 2002</p> <p><i>Award(s):</i> Good Design Award, Chicago Athenaeum, 2003, USA NeoCon Gold, Best of NeoCon, Task Chair - Seating Design, June 2002, USA IIDEX/NeoCon, Sustainable Design Gold Award, 2002, Canada</p> 	Armless	Aluminum base, Life Knitted Seat Topper (KST), no back topper	55C-3-(3 or 4)-A-5-K-GH BSF()-KST()-NB
	Fixed Plastic	Aluminum base, Life Knitted Seat Topper (KST), no back topper	55A-3-(3 or 4)-A-5-K-GH BSF()-KST()-NB
	Fixed Aluminum	Aluminum base, Life Knitted Seat Topper (KST), no back topper	55M-3-(3 or 4)-A-5-K-GH BSF()-KST()-NB
	Height Adjustable	Aluminum base, Life Knitted Seat Topper (KST), no back topper	55H-3-(3 or 4)-A-5-K-GH BSF()-KST()-NB
	High Performance	Aluminum base, Life Knitted Seat Topper (KST), no back topper	55P-3-(3 or 4)-A-5-K-GH BSF()-KST()-NB

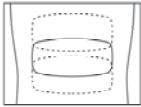
*For specification directions, please see page 44.
For upholstery selections and pricing see facing page.

Order Code	Ordering Information	Options
<p><i>Example:</i> 55H-3-6-A5K-GH-BSF33-ST-K1206/9-NB</p> <p>55 Life chair</p> <p>H Height adjustable arms</p> <p>3 High back</p> <p>6 Grey base and grey levers</p> <p>A Advanced control with sliding seat</p> <p>5 Standard height cylinder</p> <p>K No lumbar</p> <p>GH Grey hard caster</p> <p>BSF33 Plum Back Suspension Fabric</p> <p>ST-K1206/9 Knoll Hopsack, Magenta seat topper</p> <p>NB No back topper</p>	<p><i>Specify:</i></p> <ol style="list-style-type: none"> 1. Pattern number with back suspension fabric BSF(). 2. Seat topper textile, either KST() for knitted seat topper or ST() for fabric or leather. NS for no seat topper. 3. Back topper textile, BT() for fabric or leather. NB for no back topper. <p>Options</p> <p><i>Armpad Options:</i> For leather armpads, add J after the arm pattern code (Example: 55PJ) and specify leather. Available in Spinneybeck Volo (Grade U) and Sabrina (Grade W) leathers.</p> <p><i>Code: Upchg: Description:</i> J \$258 Spinneybeck Volo J \$347 Spinneybeck Sabrina</p> <p><i>Base Options:</i></p> <p><i>Code: Upchg: Description:</i> 3 n/c painted matte aluminum base 4 n/c polished aluminum base</p>	<p><i>Cylinder Height Options:</i> For height ranges see Life Dimensions and Operating Instructions. Replace 5 in pattern with one of the following options:</p> <p><i>Code: Upchg: Description:</i> L n/c low cylinder H n/c high cylinder</p> <p><i>Lumbar Options:</i> For lumbar, replace K with L() in the pattern number. Specify color code in the parentheses after L.</p> <p><i>Code: Upchg: Description:</i> L(K1029/13) \$98 Vibe, Glam L(K1029/14) \$98 Vibe, Poise L(K1029/BLK) \$98 Vibe, Black</p> <p><i>Lumbar detail</i></p>  <p><i>Caster Options:</i> Replace GH in pattern with one of the following options:</p> <p><i>Code: Upchg: Description:</i> BH n/c hard black caster BR \$42 soft black caster GR \$42 soft grey caster CH \$25 hard clear caster CR \$67 soft clear caster</p> <p><i>Glides:</i> Replace GH in pattern with GG. No upcharge for this option.</p> <p><i>Glide detail</i></p> 

KST or COM	A	B	C	D	E	F	G	H	I	T	COL U	V	W	X	Y
\$1,297.															
1,458.															
1,508.															
1,512.															
1,594.															



Back Suspension Fabric - Standard**Knitted Seat Topper - Base Grade****Textile Options**

<i>Code:</i>	<i>Description:</i>	<i>Code:</i>	<i>Description:</i>		
BSF 15	Eclipse	KST 15	Eclipse/Blackout	Please refer to the matrices at the beginning of the price list for approved KnollTextiles fabrics and Spinneybeck leathers for seat and back toppers. <i>Ultra Seat Topper Options:</i> For ultra seat topper, which is 1/2" thicker foam than standard seat topper, add U before the seat topper pattern code. <i>Code: Upchg: Description:</i> UST \$59 Ultra Seat Topper in fabric or leather UKST \$59 Ultra Knitted Seat Topper <i>Perforated Leather Option:</i> For perforated patterns in leather seat and/or back toppers, insert PERF() after ST() and/or BT() in pattern number. Seat topper upcharge is \$105. Back topper upcharge is \$220. See Spinneybeck Leather Application section for pattern codes. COM/COL Textile Requirements <i>Seat Topper:</i> 0.7 yards fabric 9.0 sq ft leather <i>Back Topper:</i> 1.3 yards fabric 16.0 sq ft leather	<i>CAL 133 Options:</i> To meet Cal 133 requirements, Life must have seat topper or seat and back toppers with approved FR upholstery. Not compliant with KST. See textile matrix at the beginning of the price list for pre-approved Cal 133 textiles. * = Cal 133 pre-approved. Insert C after ST() option. See below for upcharges. <i>Code: Upchg: Description:</i> C \$81 CAL 133 fabric seat topper C \$277 CAL 133 fabric seat and back toppers C \$159 CAL 133 leather seat topper Minimum order of 3 chairs required C \$390 CAL 133 leather seat and back toppers No minimum order required
BSF 17	Blackout	KST 18	Camel		
BSF 19	Beige	KST 19	Beige		
BSF 22	Grain	KST 31	Dark Blue		
BSF 31	Navy	KST 32	Scarlet		
BSF 32	Rouge	KST 33	Grape		
BSF 33	Plum	KST 36	Olive		
BSF 34	Sunset	KST 38	Dark Brown		
BSF 35	Avocado	KST 40	Dark Grey		
BSF 37	Bronze				
BSF 38	Chestnut				
BSF 39	Platinum				
BSF 40	Charcoal				
BSF 41	Frost				
			For no seat topper (NS), subtract \$51 from KST base grade list price.		
			Ordering Samples/Viewing online: To view BSF and KST colors see Surface Finish Library on knoll.com. Physical samples are the best representation of color. To order samples, contact a Knoll sales representative or Knoll dealer.		

Life®
aluminum base, seat topper, no back topper

	arm	description	pattern no. *
<p><i>Designer(s):</i> Formway Design Studio, 2002</p> <p><i>Award(s):</i> Good Design Award, Chicago Athenaeum, 2003, USA NeoCon Gold, Best of NeoCon, Task Chair - Seating Design, June 2002, USA IIDEX/NeoCon, Sustainable Design Gold Award, 2002, Canada</p> 	Armless	Aluminum base, fabric or leather seat topper, no back topper	55C-3-(3 or 4)-A-5-K-GH BSF()-ST()-NB
	Fixed Plastic	Aluminum base, fabric or leather seat topper, no back topper	55A-3-(3 or 4)-A-5-K-GH BSF()-ST()-NB
	Fixed Aluminum	Aluminum base, fabric or leather seat topper, no back topper	55M-3-(3 or 4)-A-5-K-GH BSF()-ST()-NB
	Height Adjustable	Aluminum base, fabric or leather seat topper, no back topper	55H-3-(3 or 4)-A-5-K-GH BSF()-ST()-NB
	High Performance	Aluminum base, fabric or leather seat topper, no back topper	55P-3-(3 or 4)-A-5-K-GH BSF()-ST()-NB

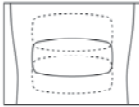
*For specification directions, please see page 44.
For upholstery selections and pricing see facing page.

Order Code	Ordering Information	Options
<p><i>Example:</i> 55H-3-6-A5K-GH-BSF33-ST-K1206/9-NB</p> <p>55 Life chair</p> <p>H Height adjustable arms</p> <p>3 High back</p> <p>6 Grey base and grey levers</p> <p>A Advanced control with sliding seat</p> <p>5 Standard height cylinder</p> <p>K No lumbar</p> <p>GH Grey hard caster</p> <p>BSF33 Plum Back Suspension Fabric</p> <p>ST-K1206/9 Knoll Hopsack, Magenta seat topper</p> <p>NB No back topper</p>	<p><i>Specify:</i></p> <ol style="list-style-type: none"> 1. Pattern number with back suspension fabric BSF(). 2. Seat topper textile, either KST() for knitted seat topper or ST() for fabric or leather. NS for no seat topper. 3. Back topper textile, BT() for fabric or leather. NB for no back topper. <p>Options</p> <p><i>Armpad Options:</i> For leather armpads, add J after the arm pattern code (Example: 55PJ) and specify leather. Available in Spinneybeck Volo (Grade U) and Sabrina (Grade W) leathers.</p> <p><i>Code: Upchg: Description:</i> J \$258 Spinneybeck Volo J \$347 Spinneybeck Sabrina</p> <p><i>Base Options:</i></p> <p><i>Code: Upchg: Description:</i> 3 n/c painted matte aluminum base 4 n/c polished aluminum base</p>	<p><i>Cylinder Height Options:</i> For height ranges see Life Dimensions and Operating Instructions. Replace 5 in pattern with one of the following options:</p> <p><i>Code: Upchg: Description:</i> L n/c low cylinder H n/c high cylinder</p> <p><i>Lumbar Options:</i> For lumbar, replace K with L() in the pattern number. Specify color code in the parentheses after L.</p> <p><i>Code: Upchg: Description:</i> L(K1029/13) \$98 Vibe, Glam L(K1029/14) \$98 Vibe, Poise L(K1029/BLK) \$98 Vibe, Black</p> <p><i>Lumbar detail</i></p>  <p><i>Caster Options:</i> Replace GH in pattern with one of the following options:</p> <p><i>Code: Upchg: Description:</i> BH n/c hard black caster BR \$42 soft black caster GR \$42 soft grey caster CH \$25 hard clear caster CR \$67 soft clear caster</p> <p><i>Glides:</i> Replace GH in pattern with GG. No upcharge for this option.</p> <p><i>Glide detail</i></p> 

KST or COM	A	B	C	D	E	F	G	H	I	T	COL U	V	W	X	Y
\$1,297.	\$1,348.	\$1,354.	\$1,379.	\$1,403.	\$1,420.	\$1,445.	\$1,457.	\$1,476.	\$1,501.	\$1,693.	\$1,723.	\$1,786.	\$1,935.	\$1,950.	\$2,037.
1,458.	1,509.	1,515.	1,540.	1,564.	1,581.	1,606.	1,618.	1,637.	1,662.	1,854.	1,884.	1,947.	2,096.	2,111.	2,198.
1,508.	1,559.	1,565.	1,590.	1,614.	1,631.	1,656.	1,668.	1,687.	1,712.	1,904.	1,934.	1,997.	2,146.	2,161.	2,248.
1,512.	1,563.	1,569.	1,594.	1,618.	1,635.	1,660.	1,672.	1,691.	1,716.	1,908.	1,938.	2,001.	2,150.	2,165.	2,252.
1,594.	1,645.	1,651.	1,676.	1,700.	1,717.	1,742.	1,754.	1,773.	1,798.	1,990.	2,020.	2,083.	2,232.	2,247.	2,334.

Back Suspension Fabric - Standard

Code:	Description:
BSF 15	Eclipse
BSF 17	Blackout
BSF 19	Beige
BSF 22	Grain
BSF 31	Navy
BSF 32	Rouge
BSF 33	Plum
BSF 34	Sunset
BSF 35	Avocado
BSF 37	Bronze
BSF 38	Chestnut
BSF 39	Platinum
BSF 40	Charcoal
BSF 41	Frost

Knitted Seat Topper - Base Grade

Code:	Description:
KST 15	Eclipse/Blackout
KST 18	Camel
KST 19	Beige
KST 31	Dark Blue
KST 32	Scarlet
KST 33	Grape
KST 36	Olive
KST 38	Dark Brown
KST 40	Dark Grey

For no seat topper (NS), subtract \$51 from KST base grade list price.

Ordering Samples/Viewing online:
To view BSF and KST colors see Surface Finish Library on knoll.com. Physical samples are the best representation of color. To order samples, contact a Knoll sales representative or Knoll dealer.

Textile Options

Please refer to the matrices at the beginning of the price list for approved Knoll/Textiles fabrics and Spinneybeck leathers for seat and back toppers.

Ultra Seat Topper Options:
For ultra seat topper, which is 1/2" thicker foam than standard seat topper, add U before the seat topper pattern code.

Code:	Upchg:	Description:
UST	\$59	Ultra Seat Topper in fabric or leather
UKST	\$59	Ultra Knitted Seat Topper

Perforated Leather Option:
For perforated patterns in leather seat and/or back toppers, insert PERF() after ST() and/or BT() in pattern number. Seat topper upcharge is \$105. Back topper upcharge is \$220. See Spinneybeck Leather Application section for pattern codes.

COM/COL Textile Requirements

Seat Topper:
0.7 yards fabric
9.0 sq ft leather

Back Topper:
1.3 yards fabric
16.0 sq ft leather

CAL 133 Options:

To meet Cal 133 requirements, Life must have seat topper or seat and back toppers with approved FR upholstery. Not compliant with KST. See textile matrix at the beginning of the price list for pre-approved Cal 133 textiles. * = Cal 133 pre-approved.

Insert C after ST() option. See below for upcharges.



Code:	Upchg:	Description:
C	\$81	CAL 133 fabric seat topper
C	\$277	CAL 133 fabric seat and back toppers
C	\$159	CAL 133 leather seat topper
C	\$390	CAL 133 leather seat and back toppers

Minimum order of 3 chairs required
No minimum order required

Life®
aluminum base, seat topper and back topper

	arm	description	pattern no. *
<p><i>Designer(s):</i> Formway Design Studio, 2002</p> <p><i>Award(s):</i> Good Design Award, Chicago Athenaeum, 2003, USA NeoCon Gold, Best of NeoCon, Task Chair - Seating Design, June 2002, USA IIDEX/NeoCon, Sustainable Design Gold Award, 2002, Canada</p> 	Armless	Aluminum base, fabric or leather seat and back topper	55C-3-(3 or 4)-A-5-K-GH BSF()-ST()-BT()
	Fixed Plastic	Aluminum base, fabric and leather seat and back topper	55A-3-(3 or 4)-A-5-K-GH BSF()-ST()-BT()
	Fixed Aluminum	Aluminum base, fabric and leather seat and back topper	55M-3-(3 or 4)-A-5-K-GH BSF()-ST()-BT()
	Height Adjustable	Aluminum base, fabric and leather seat and back topper	55H-3-(3 or 4)-A-5-K-GH BSF()-ST()-BT()
	High Performance	Aluminum base, fabric and leather seat and back topper	55P-3-(3 or 4)-A-5-K-GH BSF()-ST()-BT()

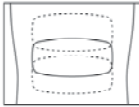
*For specification directions, please see page 44.
For upholstery selections and pricing see facing page.

Order Code	Ordering Information	Options
<p><i>Example:</i> 55H-3-6-A5K-GH-BSF33-ST-K1206/9-NB</p> <p>55 Life chair</p> <p>H Height adjustable arms</p> <p>3 High back</p> <p>6 Grey base and grey levers</p> <p>A Advanced control with sliding seat</p> <p>5 Standard height cylinder</p> <p>K No lumbar</p> <p>GH Grey hard caster</p> <p>BSF33 Plum Back Suspension Fabric</p> <p>ST-K1206/9 Knoll Hopsack, Magenta seat topper</p> <p>NB No back topper</p>	<p><i>Specify:</i></p> <ol style="list-style-type: none"> Pattern number with back suspension fabric BSF(). Seat topper textile, either KST() for knitted seat topper or ST() for fabric or leather. NS for no seat topper. Back topper textile, BT() for fabric or leather. NB for no back topper. <p>Options</p> <p><i>Armpad Options:</i> For leather armpads, add J after the arm pattern code (Example: 55PJ) and specify leather. Available in Spinneybeck Volo (Grade U) and Sabrina (Grade W) leathers.</p> <p><i>Code: Upchg: Description:</i> J \$258 Spinneybeck Volo J \$347 Spinneybeck Sabrina</p> <p><i>Base Options:</i></p> <p><i>Code: Upchg: Description:</i> 3 n/c painted matte aluminum base 4 n/c polished aluminum base</p>	<p><i>Cylinder Height Options:</i> For height ranges see Life Dimensions and Operating Instructions. Replace 5 in pattern with one of the following options:</p> <p><i>Code: Upchg: Description:</i> L n/c low cylinder H n/c high cylinder</p> <p><i>Lumbar Options:</i> For lumbar, replace K with L() in the pattern number. Specify color code in the parentheses after L.</p> <p><i>Code: Upchg: Description:</i> L(K1029/13) \$98 Vibe, Glam L(K1029/14) \$98 Vibe, Poise L(K1029/BLK) \$98 Vibe, Black</p> <p>Lumbar detail</p>  <p><i>Caster Options:</i> Replace GH in pattern with one of the following options:</p> <p><i>Code: Upchg: Description:</i> BH n/c hard black caster BR \$42 soft black caster GR \$42 soft grey caster CH \$25 hard clear caster CR \$67 soft clear caster</p> <p><i>Glides:</i> Replace GH in pattern with GG. No upcharge for this option.</p> <p>Glide detail</p> 

KST or COM	A	B	C	D	E	F	G	H	I	T	COL U	V	W	X	Y
\$1,507.	\$1,594.	\$1,626.	\$1,682.	\$1,741.	\$1,785.	\$1,815.	\$1,933.	\$1,958.	\$1,996.	\$2,295.	\$2,413.	\$2,533.	\$2,996.	\$3,022.	\$3,153.
1,668.	1,755.	1,787.	1,843.	1,902.	1,946.	1,976.	2,094.	2,119.	2,157.	2,456.	2,574.	2,694.	3,157.	3,183.	3,314.
1,718.	1,805.	1,837.	1,893.	1,952.	1,996.	2,026.	2,144.	2,169.	2,207.	2,506.	2,624.	2,744.	3,207.	3,233.	3,364.
1,722.	1,809.	1,841.	1,897.	1,956.	2,000.	2,030.	2,148.	2,173.	2,211.	2,510.	2,628.	2,748.	3,211.	3,237.	3,368.
1,804.	1,891.	1,923.	1,979.	2,038.	2,082.	2,112.	2,230.	2,255.	2,293.	2,592.	2,710.	2,830.	3,293.	3,319.	3,450.

Back Suspension Fabric - Standard

Code:	Description:
BSF 15	Eclipse
BSF 17	Blackout
BSF 19	Beige
BSF 22	Grain
BSF 31	Navy
BSF 32	Rouge
BSF 33	Plum
BSF 34	Sunset
BSF 35	Avocado
BSF 37	Bronze
BSF 38	Chestnut
BSF 39	Platinum
BSF 40	Charcoal
BSF 41	Frost

Knitted Seat Topper - Base Grade

Code:	Description:
KST 15	Eclipse/Blackout
KST 18	Camel
KST 19	Beige
KST 31	Dark Blue
KST 32	Scarlet
KST 33	Grape
KST 36	Olive
KST 38	Dark Brown
KST 40	Dark Grey

For no seat topper (NS), subtract \$51 from KST base grade list price.

Ordering Samples/Viewing online:
To view BSF and KST colors see Surface Finish Library on knoll.com. Physical samples are the best representation of color. To order samples, contact a Knoll sales representative or Knoll dealer.

Textile Options

Please refer to the matrices at the beginning of the price list for approved Knoll Textiles fabrics and Spinneybeck leathers for seat and back toppers.

Ultra Seat Topper Options:
For ultra seat topper, which is 1/2" thicker foam than standard seat topper, add U before the seat topper pattern code.

Code:	Upchg:	Description:
UST	\$59	Ultra Seat Topper in fabric or leather
UKST	\$59	Ultra Knitted Seat Topper

Perforated Leather Option:
For perforated patterns in leather seat and/or back toppers, insert PERF() after ST() and/or BT() in pattern number. Seat topper upcharge is \$105. Back topper upcharge is \$220. See Spinneybeck Leather Application section for pattern codes.

COM/COL Textile Requirements

Seat Topper:
0.7 yards fabric
9.0 sq ft leather

Back Topper:
1.3 yards fabric
16.0 sq ft leather

CAL 133 Options:

To meet Cal 133 requirements, Life must have seat topper or seat and back toppers with approved FR upholstery. Not compliant with KST. See textile matrix at the beginning of the price list for pre-approved Cal 133 textiles. # = Cal 133 pre-approved.

Insert C after ST() option. See below for upcharges.

Code:	Upchg:	Description:
C	\$81	CAL 133 fabric seat topper
C	\$277	CAL 133 fabric seat and back toppers
C	\$159	CAL 133 leather seat topper
C	\$390	CAL 133 leather seat and back toppers

Minimum order of 3 chairs required
No minimum order required

Life®
replacement parts

	description	pattern no. *
<i>Designer(s):</i> Formway Design Studio, 2002 <i>Award(s):</i> Good Design Award, Chicago Athenaeum, 2003, USA NeoCon Gold, Best of NeoCon, Task Chair - Seating Design, June 2002, USA IINDEX/NeoCon, Sustainable Design Gold Award, 2002, Canada	Replacement KST or leather seat topper upholstery	55SEATTOPPER
	Replacement fabric seat topper	55FABRICTOPPER
	Replacement fabric or leather back topper	55BACKTOPPER
	Replacement lumbar	55LUMBAR



*For upholstery selections and pricing see facing page.

Order Code	Ordering Information	Options												
<i>Example:</i> 55FABRICTOPPER-ST-K1206/9 55 Life chair FABRIC TOPPER Replacement fabric seat topper ST Seat topper K1206/9 Knoll Hopsack, Magenta	<i>Specify:</i> 1. Pattern number 2. Textile	<i>Lumbar Options:</i> For lumbar, specify color code in the parentheses after L. <table> <thead> <tr> <th>Code:</th> <th>Upchg:</th> <th>Description:</th> </tr> </thead> <tbody> <tr> <td>K1029/13</td> <td>\$98</td> <td>Vibe, Glam</td> </tr> <tr> <td>K1029/14</td> <td>\$98</td> <td>Vibe, Poise</td> </tr> <tr> <td>K1029/BLK</td> <td>\$98</td> <td>Vibe, Black</td> </tr> </tbody> </table>	Code:	Upchg:	Description:	K1029/13	\$98	Vibe, Glam	K1029/14	\$98	Vibe, Poise	K1029/BLK	\$98	Vibe, Black
Code:	Upchg:	Description:												
K1029/13	\$98	Vibe, Glam												
K1029/14	\$98	Vibe, Poise												
K1029/BLK	\$98	Vibe, Black												

Lumbar detail



KST or COM	A	B	C	D	E	F	G	H	I	T	COL U	V	W	X	Y
\$51.										\$447.	\$477.	\$540.	\$689.	\$704.	\$791.
51.	102.	108.	133.	157.	174.	199.	211.	230.	255.						
210.	246.	272.	303.	338.	365.	370.	476.	482.	495.	602.	690.	747.	1,061.	1,072.	1,116.
98.															

Knitted Seat Topper - Base Grade

<i>Code:</i>	<i>Description:</i>
KST 15	Eclipse/Blackout
KST 18	Camel
KST 19	Beige
KST 31	Dark Blue
KST 32	Scarlet
KST 33	Grape
KST 36	Olive
KST 38	Dark Brown
KST 40	Dark Grey

Ordering Samples/Viewing online:
To view BSF and KST colors see Surface Finish Library on knoll.com. Physical samples are the best representation of color. To order samples, contact a Knoll sales representative or Knoll dealer.

Textile Options

Please refer to the matrices at the beginning of the price list for approved Knoll Textiles fabrics and Spinneybeck leathers for seat and back toppers.

Ultra Seat Topper Options:
For ultra seat topper, which is 1/2" thicker foam than standard seat topper, add U before the seat topper pattern code.

<i>Code:</i>	<i>Upchg:</i>	<i>Description:</i>
UST	\$59	Ultra Seat Topper in fabric or leather
UKST	\$59	Ultra Knitted Seat Topper

Perforated Leather Option:
For perforated patterns in leather seat and/or back toppers, insert PERF() after ST() and/or BT() in pattern number. Seat topper upcharge is \$105. Back topper upcharge is \$220. See Spinneybeck Leather Application section for pattern codes.

COM/COL Textile Requirements

Seat Topper:
0.7 yards fabric
9.0 sq ft leather

Back Topper:
1.3 yards fabric
16.0 sq ft leather

CAL 133 Options:

To meet Cal 133 requirements, Life must have seat topper or seat and back toppers with approved FR upholstery. Not compliant with KST. See textile matrix at the beginning of the price list for pre-approved Cal 133 textiles. * = Cal 133 pre-approved.

Insert C after ST() option. See below for upcharges.

<i>Code:</i>	<i>Upchg:</i>	<i>Description:</i>
C	\$81	CAL 133 fabric seat topper
C	\$277	CAL 133 fabric seat and back toppers
C	\$159	CAL 133 leather seat topper
C	\$390	CAL 133 leather seat and back toppers

Minimum order of 3 chairs required
No minimum order required

How to Specify a Life Chair

Step 1 Basic Pattern Number																							
Select a Chair Type (including arm, base, cylinder, lumbar and caster type)																							
	Arm				Base				Cylinder	Lumbar	Caster												
Life Chair	Height Adjustable Arms	High Performance Arms	Fixed Plastic Arms	Fixed Aluminum Arms	Armless	Leather Armpads	High Back	Grey Plastic Base & Levers	Polished Aluminum Base & Levers	Painted Matte Aluminum Base & Levers	Black Plastic Base & Levers	Advanced Control with Sliding Seat	Medium Height Cylinder	Low Height Cylinder	High Height Cylinder	Height Adjustable Lumbar, Color #	No Lumbar	Grey Hard Caster	Grey Soft Caster	Clear Hard Caster	Clear Soft Caster	Black Hard Caster	Black Soft Caster
55	H	P	A	M	C	J	3	6	4	3	2	A	5	L	H	L	K	GH	GR	CH	CR	BH	BR

The basic pattern numbers are configured for you in the price list.

EXAMPLES:

55PJ-3-6-A5L-K1029-13-GH-BSF17-ST-K451/4-BT-K451/4

(Life with plastic base and upholstered seat and back toppers)

Life / High Performance Arm / Leather Armpads / Grey Base /
Height Adjustable Lumbar, Vibe K1029-13 Glam / Grey Hard Caster /
Life Back Suspension Fabric-Blackout / Seat Topper Fabric-Una, Ebony /
Back Topper Fabric-Una, Ebony

55H-3-4-A5K-CH-BSF22-KST19-NB

(Life with aluminum base and knitted seat topper, no back topper)

Life / Height Adjustable Arms / Polished Aluminum Base / No Lumbar /
Clear Hard Caster / Life Back Suspension Fabric-Grain /
Life Knitted Seat Topper / No Back Topper

Step 2		Step 3		Step 4	
	Select Back Suspension Fabric color	Select No Seat Topper	<input type="checkbox"/> or <input type="checkbox"/> Select Seat Topper and Upholstery Choice	Select No Back Topper	<input type="checkbox"/> or <input type="checkbox"/> Select Back Topper and Upholstery Choice
	Life Back Suspension Fabric	No Seat Topper (-\$51 from base grade list price)	Seat Topper and Upholstery Number Life Knitted Seat Toppers are base grade. Additional options include all approved KnollTextiles fabrics, Spinneybeck leathers, COM or COL	No Back Topper	Back Topper and Upholstery Code Options include all approved KnollTextiles fabrics, Spinneybeck leathers, COM or COL
	BSF(15-41)	NS	Life Knitted Seat Topper KST(15-40) <i>(base grade)</i> or UKST(15-40) <i>(optional Ultra Knitted Seat Topper)</i> or ST-(KnollTextiles or Spinneybeck Upholstery Code*) <i>(optional fabric or leather seat topper)</i> or UST-(Upholstery Code*) <i>(optional fabric or leather Ultra Seat Topper)</i> or COM or COL	NB	No base grade available or BT-(KnollTextiles or Spinneybeck Upholstery Code*) <i>(optional fabric or leather back topper)</i> or COM or COL

* Please refer to the matrices at the beginning of the price list for approved fabrics and leathers.



Back Suspension Fabric with No Seat Topper

Life Back Suspension Fabric (BSF) is required for every chair and comes in 14 updated colors including warm and cool neutrals and vibrant, saturated colors.



Back Suspension Fabric with Upholstered Seat Topper

You may choose to add a seat topper. In addition to a wide range of approved KnollTextiles fabrics and Spinneybeck leathers, an exclusive Life Knitted Seat Topper (KST) is available in a palette to match the Life BSF. Life KST is base grade and included in the basic model pricing.



Back Suspension Fabric with Upholstered Seat and Back Toppers

Change the look of Life by adding an upholstered back topper. A wide range of approved KnollTextiles fabrics and Spinneybeck leathers are available as back toppers. Life KST is not available as a back topper. There is no base grade back topper.

To view fabrics online, refer to the Knoll Surface Finish Library on knoll.com (go to the top menu bar and click on “Resources” and click on “Surface Finish Library”).

Construction

COM/COL Approval Procedure

Prior to order placement a sample* of the actual COM/COL must be submitted to Knoll East Greenville, with completed Knoll COM/COL Approval Request Form. Even after such preliminary approval, Knoll reserves the right to reject COM, including, if necessary, the item intended for use with COM, if Knoll considers the customer-supplied material inadequate for any reason. When specifying suede and shrunken cowhide, add 10% to the square footage requirement. When specifying calfskin, add 15% to the square footage requirement. COM is graded at Life KST base grade and COL is grade U.

*Sample Requirement: 8" x 8" minimum memo sample if solid; if COM has a repeat, the sample must be large enough to show the repeat.

Call Customer Service at 800-343-5665 to obtain a copy of the COM/COL Approval Request Form.

Cleaning Note:

Life BSF is cleaning code W, meaning water-based cleaning agents or foam may be used.

Life KST is cleaning code W-S, meaning water-based cleaning agents and foam or mild water-free solvents may be used.

See KnollTextiles Price List for further details on cleaning codes.

Back:

Glass filled nylon frame. Polyester multi-filament yarn with co-polymer polyester elastomeric knit back suspension fabric.

Upholstery toppers:

MDI polyurethane foam material
 3/4" foam - back thickness
 1 3/4" foam - seat thickness
 2 1/4" foam - ultra seat thickness

Flexing Seatpad:

Glass filled nylon seat structure.

Fixed Plastic Arms:

Grey plastic armrest with soft integrally colored thermoplastic urethane pad and glass filled nylon foam insert.

Fixed Aluminum Arms:

Aluminum armrest with soft integrally colored thermoplastic urethane pad and glass filled nylon foam insert.

Height Adjustable and High Performance Arms:

Aluminum armrest with soft integrally colored thermoplastic urethane pad and glass filled nylon foam insert.

Black and Grey Plastic Base:

Glass filled nylon.

Polished and painted matte aluminum base:

Aluminum

Optional Lumbar:

Slow recovery urethane foam with KnollTextiles Vibe fabric cover. Attaches with neodymium magnets in TPU back frame.

Casters:

Nylon 6 hard caster.
 Nylon 6 soft caster with urethane overmolding.

Visual impression and scale:

Doesn't dominate the look of the work environment, it complements it. Translucent back, sculpted mechanism and thin profile integrate Life into the landscape. Generous scale and features accommodate all size users.

Synchronized recline with auto-balanced tension:

Utilizes user's body weight for resistance and recline. Allows for constant sightline — no need to refocus. Promotes movement and balance. Preference control accommodates a wider range of users.

Dynamic seat pan with forward flex:

Unique cut-out pattern with ribbed understructure provides dynamic movement and structural stability. Cradles and accommodates ischials (sit bones) without pressure points. Automatic flex responds to user's every move. Flex front automatically supports perching and enables a balanced posture. Flex front includes waterfall edge (gradual radius at the front edge that does not cause pressure under the knee). Ribs prevent "hammocking" or sagging and allow for easier movement.

Back flex:

The back frame is also a flexible plane like the seat that moves with you as you recline in the chair.

Life Back Suspension Fabric (BSF):

Exclusive elastomeric knit has built in lumbar support and is available in 14 color options. Has a soft feel that is not harsh to skin or clothing.

Arms:

Soft armpads alleviate pressure points. Types available: fixed, height adjustable, high performance (includes height adjustment and armpad positioning). Retrofittable or changeable.

High performance arms:

One-hand operation. Armposts are set toward the rear of the seat for a better fit. Soft armpads float in an orbital motion with locked stops. A great deal of adjustment in a surprisingly slim package.

Optional lumbar attachment:

Made of slow recovery foam, it magnetically attaches anywhere on the Life Back Suspension Fabric (BSF), and is covered in Vibe by KnollTextiles.

Low profile base and casters:

Feet can rest on the base comfortably. Low profile enables easier foot movement. Caster ribs absorb energy, flex and spread the static load for easier rolling.

Controls:

Adjustable from the seated position. Easy, obvious and labeled. Automated where possible.

Environmental:**SMaRT[®] Sustainable Gold certified.**

Life was the first product in the industry to be SMaRT[®] certified. SMaRT[®] Consensus Sustainable Product Standard is a comprehensive, transparent, sustainable product standard that measures a product's environmental, economic and social benefits over its life and throughout its global supply chain, from raw materials through reclamation or re-use. Life can contribute to achieving a LEED[®] Innovation in Design Credit.

GREENGUARD[®] certified.

Life is GREENGUARD Indoor Air Quality[®] and GREENGUARD for Children & SchoolsSM certified and can contribute to achieving LEED[®] credits.

Durability:

10 year, 24-hour, 7 days a week, multi-shift warranty, including Life Back Suspension Fabric. See details in the Selling Policy at the end of the Price List.

Life Awards:

Good Design Award, Chicago Athenaeum, 2003, USA
NeoCon Gold, Best of NeoCon, Task Chair - Seating Design, June 2002, USA
IIDEX/NeoCon, Sustainable Design Gold Award, 2002, Canada
IIDEX/NeoCon, Seating Desk, Workstation Chair Gold Award, 2002, Canada
FX Awards, Seating Product of the Year, 2002, UK
FX Awards, Overall Interior Product of the Year, 2002, UK

Life® Dimensions and Operating Instructions

	BIFMA G1-2002 Ergonomic Guidelines	Life Ergonomic Dimensions		
Seat*				
		Standard Cylinder	Low Cylinder	High Cylinder
Seat Height	15" - 19.9" minimum range (one or combination of chairs)	15.25" - 20.5" (no seat topper) 15.75" - 21" (seat topper) 16" - 21.25" (ultra seat topper)	14.25" - 18" (no ST) 14.75" - 18.5" (ST) 15" - 18.75" (UST)	17" - 22" (no ST) 17.5" - 22.5" (ST) 17.75" - 22.75" (UST)
Seat Depth (Adjustable)	Include 16.9" or less in range	15" - 19"		
Seat Width	18" minimum	18.75"		
Seat Pan Angle (Fixed)	In range of 0° - 4° rearward	4° rearward		

Back*				
Backrest Height	12.2" minimum	25"		
Backrest Width	14.2" minimum	18.25"		
Lumbar Support (Fixed)	In range of 5.9" - 9.8"	7.5"		
Lumbar Support (Adjustable)	Include part of 5.9" - 9.8" range	Exceeds 5.5" - 9.8" (optional lumbar)		
Angle Between Seat and Back	≥90°, include 10° movement in 90° - 115° range	95° - 119°		
Tilt Range of Back	10° minimum	24°		

		Seat Topper	No Seat Topper	Ultra Seat Topper
Armrest Height (Fixed)	In range of 7.9" - 9.8"	9.5" (fixed arm)	10.5" (fixed arm)	8.5" (fixed arm)
Armrest Height (Adjustable)	6.9" - 10.8" minimum range (single or multiple sets of arms)	6.8" - 10.8" (height adjustable) 6.8" - 10.8" (high performance)	7.8" - 11.8" (height adjustable) 7.8" - 11.8" (high performance)	5.8" - 9.8" (height adjustable) 5.8" - 9.8" (high performance)
Inside Distance Between Armrests (Fixed)	18" minimum	18.5" (fixed) 18.25" (height adjustable)		
Inside Distance Between Armrests (Adjustable)	Include 18" in range	17.25" - 19.75" (high performance)		

* All measurements taken with BIFMA Chair Measuring Device using the Universal Measurement Procedure which has a measurement uncertainty of ± 5%

Life Chair Measurements**

A. Overall Height	38.5" - 43.75" (back topper adds 0.5")
B. Overall Width	26.5"
C. Overall Depth	24.5"
D. Arm Height from Floor	25" - 30" (fixed arm) 22" - 31.5" (height adjustable) 22" - 31.5" (high performance)
E. Base Diameter	26"
Weight	36.5 lbs. (plastic base, high performance arms, seat topper) 38 lbs. (aluminum base, high performance arms, seat topper)

**Standard cylinder

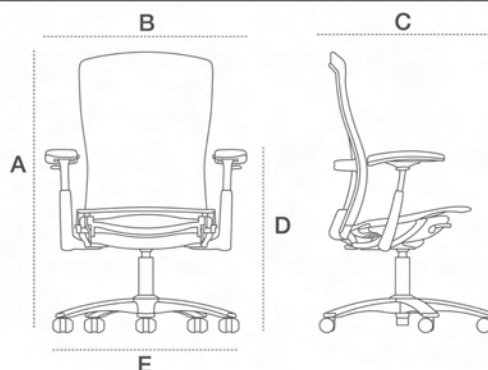

Life - Additional Information

Synchronized recline ratio seat : back is 1° : 4.8°

High performance arms adjust 2.5" in armpad width (1.25" per side) and 3" armpad fore/aft movement

Optional lumbar measures 11.5" x 5.5"

Compliance: ANSI/BIFMA X5.1 : 2002 except front stability - ANSI/BIFMA X5.1 : 1993 (U.S. structural standards), BIFMA G1 : 2002 (U.S. ergonomic guidelines), California T.B. 117 (U.S. flammability standard for foam), California T.B. 133 with approved FR textile (U.S. flammability standard for full chair), CAN/CGSB 44.232-2008, BS 5459.2 : 2000 (European structural standard), EN 1335-1 : 2000 (European ergonomic standard), AS/NZS 4438 : 1997 Level 6 (Australia, New Zealand ergonomic standard)

The Life chair has been tested and is approved for use by individuals weighing up to 300 pounds.

Life® Operating Instructions

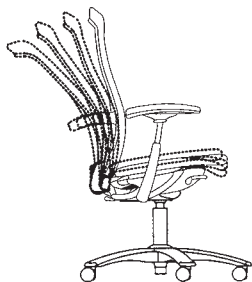

Standard Features:

Synchronized recline with auto-balanced tension

No need to adjust tension. Automatic recline tension counter-balances your body weight, resulting in perfect balance as you recline.

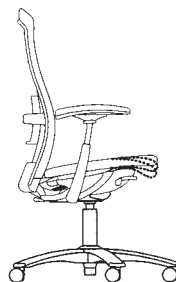

Forward seat flex

No knobs or levers needed. Lean forward or perch toward the edge of the seat and Life's seat pan automatically adjusts to support your position.

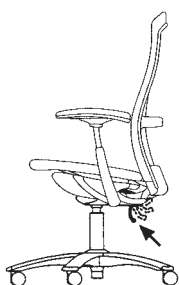

Tension preference selector

To perfect the tension adjust the preference lever located at the back left of the chair while in the upright position.

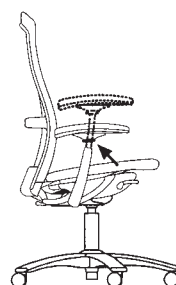

Arm Options:

Fixed arms:

Non-adjustable.

Height Adjustable Arms:

Lift the lever on the outside of the armpad to adjust arm height.

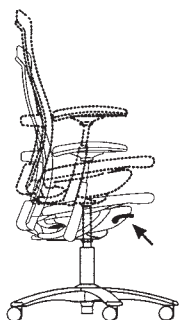

Seat height adjustment

To raise or lower the height, lift the lever on the right side of the chair and adjust to the proper height.

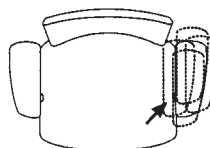

High Performance Arms:

Lift the lever on the outside of the armpad to adjust arm height.

The armpads adjust in an orbital motion and lock into a fixed position by pressing the button on the inside of the pad. The armpads can be positioned to the front or back and in width.

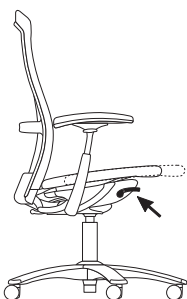

Sliding seat depth adjustment

Using the same lever as the seat height, push down to slide the seat within the 4" seat depth range. Release the lever to lock the seat into position.

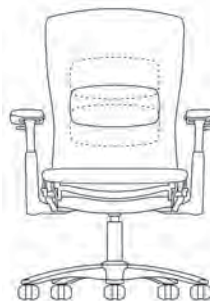

Lumbar Options:

Height Adjustable Lumbar

The lumbar support is held on to the chair with magnets for easy installation and a maximum range of adjustability.

To install the lumbar, separate the halves of the magnetic lumbar and place it in the desired position on your chair. Secure it by putting both halves back together around the back suspension fabric on the chair.

Adjust the lumbar by sliding the lumbar pad up and down the back of the chair.



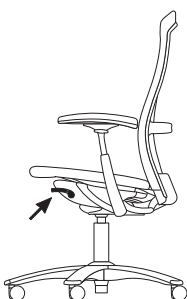

Note: Product contains magnets. Consult the lumbar hangtag for more information.



Upright tilt lock

To lock the seat in an upright position, push down the lever located on the left side of seat. Lift lever to unlock.

Generation by Knoll® work chair

	model	description	pattern no.	
<p><i>Designer(s):</i> Formway Design, 2009</p> <p><i>Award(s):</i> NeoCon Gold, Best of NeoCon, Task Chair - Seating, June 2009, USA Best of Year Award, <i>Interior</i> <i>Design</i>, Seating: Contract/Task, December 2009, USA GOOD DESIGN Award, Chicago Athenaeum, 2009, USA</p> 	armless	plastic base, standard cylinder, no optional lumbar, hard casters	11-1-NA-2-S-X-HC	
		fixed arms	plastic base, standard cylinder, no optional lumbar, hard casters	11-1-FA-2-S-X-HC
		height adjustable arms	plastic base, standard cylinder, no optional lumbar, hard casters	11-1-HA-2-S-X-HC
		high performance arms	plastic base, standard cylinder, no optional lumbar, hard casters	11-1-HP-2-S-X-HC
	GENSEAT	Replacement seat	GENSEAT	

Order Code	Ordering Information	Options																						
<p><i>Example:</i> 11-1-HP-2-S-X-HC-DK-01-USF-GENU01</p> <table border="0"> <tr><td>11</td><td>Generation by Knoll</td></tr> <tr><td>1</td><td>Work chair</td></tr> <tr><td>HP</td><td>High performance arms</td></tr> <tr><td>2</td><td>Plastic base</td></tr> <tr><td>S</td><td>Standard cylinder</td></tr> <tr><td>X</td><td>No optional lumbar</td></tr> <tr><td>HC</td><td>Hard casters for soft floors</td></tr> <tr><td>DK</td><td>Dark finish</td></tr> <tr><td>01</td><td>Storm Flex Back Net color</td></tr> <tr><td>USF</td><td>Ultra seat foam</td></tr> <tr><td>GENU01</td><td>Generation Fabric, Storm</td></tr> </table> <p><i>Example for Cal 133:</i> 11-1-HP-2-S-X-HC-DK-01-USF-C-GENU01-133</p>	11	Generation by Knoll	1	Work chair	HP	High performance arms	2	Plastic base	S	Standard cylinder	X	No optional lumbar	HC	Hard casters for soft floors	DK	Dark finish	01	Storm Flex Back Net color	USF	Ultra seat foam	GENU01	Generation Fabric, Storm	<p><i>Specify:</i></p> <ol style="list-style-type: none"> 1. Pattern number 2. Finish color 3. Flex Back Net color 4. Seat foam 5. Seat textile <p>Options</p> <p><i>Polished Aluminum Base:</i> Replace 2 in pattern with 4</p> <p><i>Code: Upchg: Description:</i> 4 \$85 polished aluminum base</p> <p><i>Cylinder Height Options:</i> For height ranges see Generation Dimensions page. Replace S in pattern with one of the following:</p> <p><i>Code: Description:</i> L low cylinder H high cylinder (not available armless)</p>	<p><i>Lumbar Option:</i> For height adjustable lumbar, replace X in pattern with L</p> <p><i>Code: Upchg: Description:</i> L \$80 height adjustable lumbar support</p> <p><i>Note:</i> To order a lumbar separately, use pattern number 11LUMBAR. The list price is \$80.</p> <p><i>Casters and Glides:</i> Replace HC in pattern with one of the following:</p> <p><i>Code: Upchg: Description:</i> SC \$40 soft casters for hard floors GL n/c glides (reduce chair height by 0.25")</p> <p><i>Finish Colors:</i> Select one of the following:</p> <p><i>Code: Description:</i> DK Dark finish LT Light finish</p> <p><i>Flex Back Net Colors:</i> Select one of the following:</p> <p><i>Code: Description:</i> 01 Storm (dark grey) 02 Meteor (light grey) 03 Pebble (medium grey) 04 Desert (beige) 05 Lemongrass (green) 06 Espresso (brown) 07 Firecracker (red) 08 Bluemarine (blue) 09 Onyx (black)</p> <p><i>Seat Foam Options:</i> Select one of the following:</p> <p><i>Code: Description:</i> TSF thin seat foam USF ultra seat foam</p> <p>Glide detail</p> 
11	Generation by Knoll																							
1	Work chair																							
HP	High performance arms																							
2	Plastic base																							
S	Standard cylinder																							
X	No optional lumbar																							
HC	Hard casters for soft floors																							
DK	Dark finish																							
01	Storm Flex Back Net color																							
USF	Ultra seat foam																							
GENU01	Generation Fabric, Storm																							

list price base grade	grades A	COM B	C	D	E	F	G	H	I	T	COL U	V	W	X	Y
\$995.	\$1,045.	\$1,065.	\$1,080.	\$1,095.	\$1,115.	\$1,125.	\$1,145.	\$1,180.	\$1,210.	\$1,230.	\$1,270.	\$1,355.	\$1,465.	\$1,515.	\$1,560.
1,195.	1,245.	1,265.	1,280.	1,295.	1,315.	1,325.	1,345.	1,380.	1,410.	1,430.	1,470.	1,555.	1,665.	1,715.	1,760.
1,195.	1,245.	1,265.	1,280.	1,295.	1,315.	1,325.	1,345.	1,380.	1,410.	1,430.	1,470.	1,555.	1,665.	1,715.	1,760.
1,295.	1,345.	1,365.	1,380.	1,395.	1,415.	1,425.	1,445.	1,480.	1,510.	1,530.	1,570.	1,655.	1,765.	1,815.	1,860.
150.	200.	220.	235.	250.	270.	280.	300.	335.	365.	385.	425.	510.	620.	670.	715.

Generation Fabric - Base Grade

Generation Fabric prefix GENT for thin seat foam or GENU for ultra seat foam, followed by two digit color code. Select one of the following:

Code: Description:

- 01 Storm
- 03 Pebble
- 04 Desert
- 05 Lemongrass
- 06 Espresso
- 07 Firecracker
- 08 Bluemarine
- 09 Onyx

Textile Options

Knoll Textiles fabrics and Spinneybeck leathers:
Please refer to the textile matrices at the beginning of the price list for approved fabrics and leathers.

Customer's Own Material/Leather:
See Customer's Own Material Seating Process Overview at the beginning of the price list

COM/COL Textile Requirements (for both thin and ultra seat foam):

COM fabric .75 yards
COL leather 11 sq. ft.

Cal 133:
See textile matrices at the beginning of the price list for additional Cal 133 pre-approved textiles. Dark finish with fire-retardant additive only approved for Cal 133. Generation Fabric is Cal 133 approved but it must be specified as described below and the upcharge does apply.
▲ = Cal 133 pre-approved

To specify, insert C before seat textile selection and 133 after it.

Code: Upchg: Description:
C()133 \$ 100 Cal 133 compliant

Generation by Knoll® Dimensions, Features and Operating Instructions

	BIFMA G1-2002 Ergonomic Guidelines	Generation by Knoll Ergonomic Dimensions	
		Thin Seat Foam	Ultra Seat Foam
Seat*			
Seat Height	15" - 19.9" minimum range (one or combination of chairs)	15" - 19.5" (low cylinder) 16.5" - 21.75" (standard cylinder) 17.75" - 23.25" (high cylinder)**	15.75" - 20.25" (low cylinder) 17.25" - 22.5" (standard cylinder) 18.5" - 24" (high cylinder)**
Seat Depth (Adjustable)	Include 16.9" or less in range	15" - 18" (with arms) 15" - 17.5" (armless)	15.75" - 18.75" (with arms) 15.75" - 18.25" (armless)
Seat Width	18" minimum	21"	
Seat Pan Angle (Fixed)	In range of 0° - 4° rearward	2.85° rearward at rest	
Back*			
Backrest Height	12.2" minimum	24.125"	
Backrest Width	14.2" minimum	19.375" at top of lumbar area	
Lumbar Support (Fixed)	In range of 5.9" - 9.8"	9.25"	
Lumbar Support (Adjustable)	Include part of 5.9" - 9.8" range	8.125" - 11.375" (optional lumbar)	
Angle Between Seat and Back	≥90°, include 10° movement in 90° - 115° range	96° - 111°	
Tilt Range of Back	10° minimum	15°	
Arms*			
Armrest Height from Seat (Fixed)	between 7.9" - 9.8"	10" (fixed)	9.5" (fixed)
Armrest Height from Seat (Adjustable)	6.9" - 10.8" minimum range (single or multiple sets of arms)	6.625" - 11.125" (height adjustable) 6.625" - 11.125" (high performance)	6.125" - 10.625" (height adjustable) 6.125" - 10.625" (high performance)
Inside Distance Between Armrests (Fixed)	18" minimum	21.5" (fixed and height adjustable)	
Inside Distance Between Armrests (Adjustable)	Include 18" in range	17.5" - 19.5" (high performance)	

* All measurements taken with BIFMA Chair Measuring Device using the Universal Measurement Procedure which has a measurement uncertainty of ±5%

** Not available armless

Generation by Knoll Chair Measurements***

A. Overall Height	39.25" - 44.5" (glides reduce height by 0.25")
B. Overall Width	21" armless 28.5" with arms
C. Overall Depth	26" excluding base
D. Arm Height from Floor	26.625" - 32" (fixed arms) 22.75" - 32.5" (height adjustable and high performance arms)
E. Base Diameter	26.75"
Weight	37 lbs. (plastic base, high performance arms) 39 lbs. (aluminum base, high performance arms)

***Standard cylinder

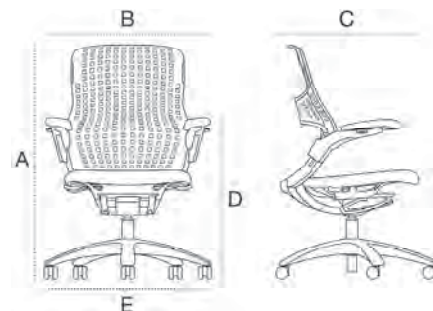

Generation by Knoll Performance Information

Synchronized recline ratio seat:back is 1°:4.4°

Arm pads measure 9.6" long x 4.3" wide

High performance arm pads adjust 2" in width (1" per arm), 1.5" in depth and pivot 45°

Flex Top folds up to 90° rearward

Compliance: ANSI/BIFMA X5.1 : 2002 (U.S. structural standard)

BIFMA G1 : 2002 (U.S. ergonomic guidelines)

ANSI/HFES 100-2007 (U.S. ergonomic standard)

California T.B. 117 (U.S. flammability standard for foam)

California T.B. 133 with approved FR textile and Dark finish with fire-retardant additive (U.S. flammability standard for full chair)

BS 5459.2 : 2000 (European structural standard)

EN 1335-1 : 2000 (European ergonomic standard)

AS/NZS 4438 : 1997 Level 6 (Australia, New Zealand ergonomic standard)

The Generation by Knoll work chair has been tested and is approved for use by individuals weighing up to 300 pounds

Generation by Knoll® Features and Operating Instructions

No Adjustment Necessary

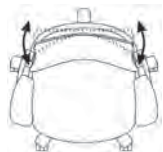

Flex Back

Sit back and the Flex Back supports you and responds to your multidimensional movements.



Flex Top

Simply rest your arms comfortably over the top of the Flex Back.



Flex Seat

Sit in any position—forward or sideways—and the Flex Seat supports you with 270° of seat edge flex.



Dynamic Suspension control

The synchronized recline counterbalances your body weight for a smooth and effortless ride. Four independent flexors act as suspension devices that respond to your multidirectional movements—forward, backward and side-to-side.

Intuitive Adjustments (Standard)

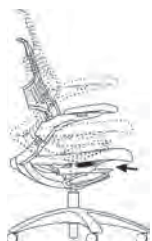

Seat height

Lift the right front lever. Sit down to lower the seat or remove your weight to raise it. Release the lever to lock.



Seat depth

While seated, lift the left lever and slide the seat to the desired position. Release the lever to lock.

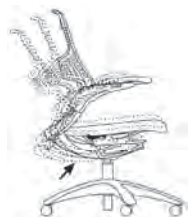

Tilt preference selector

Select the degree of recline movement for your preference and your task. Sit fully upright. Rotate the back right lever until it clicks into one of three positions—all the way back for the most movement, in the middle for less, or all the way forward for greater upright support.

Performance Options

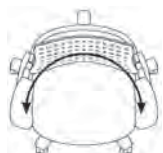

Arm options

Cantilevered arm supports provide seated clearance for your legs and feature Continuous Lumbar, so your back is supported when side sitting.



Height adjustable arm

To adjust the height, lift the lever on the arm and lift the arm to disengage. Slide the arm to the desired position and release the lever to lock.



High performance arm

To adjust the height, lift the lever on the arm and lift the arm to disengage. Slide the arm to the desired position and release the lever to lock. Free float arm pads move easily in width and depth, and pivot.



Height adjustable lumbar

Grasp both sides of the lumbar support and slide it to the desired position.

CONSTRUCTION INFORMATION

Flex Back

Integrally colored, high performance elastomer and glass reinforced polyester structure

Fixed, height adjustable and high performance arms

Burnished cast aluminum and integrally colored, glass reinforced nylon supports with integrally colored, self skinning polyurethane arm pads

Flex Seat

High-resiliency molded urethane foam with textile cover and integrally colored, glass reinforced, impact modified nylon structure

Controls

- A. Dynamic Suspension control
A solid state construction of integrally colored, high performance elastomer, glass reinforced polyester and cast zinc
- B. Tilt preference selector
Integrally colored nylon and acetal; integrally colored, glass reinforced acetal
- C. Seat depth adjustment mechanism
Steel plate with integrally colored polypropylene parts

Pneumatic cylinder

Steel

Base

Burnished cast aluminum or integrally colored, glass reinforced nylon; five star design

Hard casters and glides

Integrally colored nylon

Soft casters

Integrally colored nylon over molded with thermoplastic polyurethane

Height adjustable lumbar

Integrally colored, glass reinforced polycarbonate

CLEANING INSTRUCTIONS

Hard surfaces and Flex Back Net

General cleaning

Frequent vacuuming or light brushing to remove dust and grime is recommended. Spot clean with a mild upholstery shampoo or the foam from a mild detergent. When using a cleaning product, follow instructions carefully and clean only in a well-ventilated room. Avoid any product that contains carbon tetrachloride or other toxic materials. With any method, pretest a small area before proceeding. When an overall soiled conditioned has been reached, use a professional furniture cleaning service or call Knoll Field Service at 800-445-5045 with questions.

Healthcare cleaning

Generation's hard surfaces and Flex Back Net successfully passed third-party testing for the following five cleaning agents commonly used in healthcare facilities:

- Clorox Germicidal Liquid Bleach diluted 1:5 ratio to tap water (pH 3.7)
- Clorox Cleanup undiluted 100% solution (pH 9.7)
- Wex-Cide 128 Concentrate Phenolic Germicide by Wexford Labs diluted 1 ounce to 1 gallon tap water (pH 3.7)
- Formula 880 Quaternary Germicide by Grand Technologies diluted 1/2 ounce to 1 gallon tap water (pH 8.1)
- Hydroxi Pro Concentrate 128 by Core Products diluted 1:8 ratio to tap water (pH 7.2)

In addition to the testing detailed above, Knoll has conducted internal testing of Virox 5 RTU cleaning solution on Generation structural parts with no adverse affects.

Generation Fabric

Cleaning code W-S: water or solvent based cleaning agent; can be cleaned with low environmental impact cleaning fluids, including GS-37 certified products. See KnollTextiles Price List for further details on cleaning codes.

ENVIRONMENTAL

SMaRT® Sustainable Platinum certified

SMaRT® Consensus Sustainable Product Standard is a comprehensive, transparent sustainable product standard that measures a product's environmental, economic and social benefits over its life cycle and throughout its global supply chain, from raw materials extraction through use, reclamation or re-use. Generation can contribute to achieving a LEED® Innovation in Design credit for its SMaRT® certification.

GREENGUARD certified

Generation is GREENGUARD Indoor Air Quality Certified® and GREENGUARD Children & Schools™ certified and can contribute to achieving LEED® credits.

WARRANTY

Generation by Knoll is warranted for 10 years, 24-hour, 7 days a week, multi-shift use, including the Flex Back Net, structural and operational parts, controls, casters, pneumatic cylinders and labor to repair; 3 years upholstery and finishes. See Knoll Selling Policy for further details.

This page intentionally left blank.

Chadwick™

tilt stop control

	arm	description	pattern no.
Designer(s): Don Chadwick, 2005 	Armless	Tilt stop control Note: Arms cannot be added later.	33-NA-1-BK-T-S-X-HC #
	Fixed arms	Tilt stop control	33-FA-1-BK-T-S-X-HC #
	Height and width adjustable arms	Tilt stop control Note: A tall adjustable arm option is available. See below for details.	33-AA-1-BK-T-S-X-HC #

For Chadwick Fabric selections and pricing, see facing page.

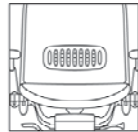
Order Code	Ordering Information	Options
<i>Example:</i> 33-AA-1-BK-T-S-X-HC-05	<i>Specify:</i>	<i>Arm Option:</i>
33 Chadwick Chair	1. Pattern number	For Tall Adjustable Arm, replace AA with TA in the pattern number. The tall arm is 3/4" higher than the standard adjustable arm. No upcharge for this option.
AA Adjustable Arms	2. Fabric color	<i>Cylinder Height Options:</i>
1 Task Chair	<i>Finish color:</i>	For height ranges see Chadwick Dimensions and Operating Instructions. Replace S in pattern with one of the following options:
BK Black Frame	Black	<i>Code: Upchg: Description:</i>
T Tilt Stop Control		L n/c low cylinder
S Standard Cylinder		H n/c high cylinder
X No Lumbar		<i>Lumbar Option:</i>
HC Hard Black Caster		For lumbar, replace X with L in the pattern number. Add \$84 to list price
05 Black Chadwick Fabric		Note:
		To order a lumbar separately, use pattern number 33LUMBAR. The list price is \$84.
		Lumbar detail
		
		

list

\$887.

956.

1,034.

Chadwick Fabric

Caster Option:

For soft casters, replace HC with SC in the pattern number, and add \$41 to the list price

Glides:

For glides, replace HC with GL in the pattern number. No upcharge for this option.

Glide detail



Black Monofilament:

Code:	Desc:	Upcharge:
01	Beige	n/c
02	Brown	n/c
03	Silver	n/c
04	Green	n/c
05	Black	n/c
06	Red	n/c
07	Blue	n/c

Silver Monofilament:

Code:	Desc:	Upcharge:
08	Jade	\$18
09	Platinum	\$18

Cal 133:

Chadwick is Cal 133 approved standard. No options or upcharge required.

Chadwick™ basic control

	arm	description	pattern no.
<p><i>Designer(s):</i> Don Chadwick, 2005</p> 	Armless	Basic control Note: Arms cannot be added later.	33-NA-1-BK-B-S-X-HC #
	Fixed arms	Basic control	33-FA-1-BK-B-S-X-HC #
	Height and width adjustable arms	Basic control Note: A tall adjustable arm option is available. See below for details.	33-AA-1-BK-B-S-X-HC #

For Chadwick Fabric selections and pricing, see facing page.

Order Code	Ordering Information	Options
<i>Example:</i> 33-AA-1-BK-B-S-X-HC-05	<i>Specify:</i>	<i>Arm Option:</i>
33 Chadwick Chair	1. Pattern number	For Tall Adjustable Arm, replace AA with TA in the pattern number. The tall arm is 3/4" higher than the standard adjustable arm. No upcharge for this option.
AA Adjustable Arms	2. Fabric color	<i>Tall Adjustable Arm detail</i>
1 Task Chair	<i>Finish color:</i>	
BK Black Frame	Black	<i>Cylinder Height Options:</i>
B Basic Control		For height ranges see Chadwick Dimensions and Operating Instructions. Replace S in pattern with one of the following options:
S Standard Cylinder		<i>Code: Upchg: Description:</i>
X No Lumbar		L n/c low cylinder
HC Hard Black Caster		H n/c high cylinder
05 Black Chadwick Fabric		<i>Lumbar Option:</i>

For lumbar, replace X with L in the pattern number. Add \$84 to list price

Note:
To order a lumbar separately, use pattern number 33LUMBAR. The list price is \$84.

Lumbar detail

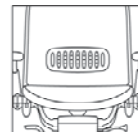

list

\$833.

903.

981.

Chadwick Fabric

Caster Option:

For soft casters, replace HC with SC in the pattern number, and add \$41 to the list price

Glides:

For glides, replace HC with GL in the pattern number. No upcharge for this option.

Glide detail



Black Monofilament:

Code:	Desc:	Upcharge:
01	Beige	n/c
02	Brown	n/c
03	Silver	n/c
04	Green	n/c
05	Black	n/c
06	Red	n/c
07	Blue	n/c

Silver Monofilament:

Code:	Desc:	Upcharge:
08	Jade	\$18
09	Platinum	\$18

Cal 133:

Chadwick is Cal 133 approved standard. No options or upcharge required.

Chadwick™
high task chair
tilt stop control

	arm	description	pattern no.
Designer(s): Don Chadwick, 2005 	Armless	Tilt stop control Note: Arms cannot be added later	33-NA-2-BK-T-S-X-HC #
	Fixed arms	Tilt stop control	33-FA-2-BK-T-S-X-HC #
	Height and width adjustable arms	Tilt stop control Note: A tall adjustable arm option is available. See below for details.	33-AA-2-BK-T-S-X-HC #

For Chadwick Fabric selections and pricing, see facing page.

Order Code	Ordering Information	Options
<i>Example:</i> 33-AA-2-BK-T-S-X-HC-05	<i>Specify:</i>	<i>Arm Option:</i>
33 Chadwick Chair	1. Pattern number	For Tall Adjustable Arm, replace AA with TA in the pattern number. The tall arm is 1/4" higher than the standard adjustable arm. No upcharge for this option.
AA Adjustable Arms	2. Fabric color	
2 High Task Chair	<i>Finish color:</i>	<i>Lumbar Option:</i>
BK Black Frame	Black	For lumbar, replace X with L in the pattern number. Add \$84 to list price
T Tilt Stop Control		Note:
S Standard Cylinder		To order a lumbar separately, use pattern number 33LUMBAR. The list price is \$84.
X No Lumbar		
HC Hard Black Caster		
05 Black Chadwick Fabric		

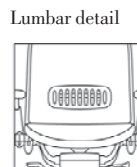

list

\$1,102.

1,171.

1,248.

Chadwick Fabric

Caster Option:
For soft casters, replace HC with SC in the pattern number, and add \$41 to the list price

Glides:
For glides, replace HC with GL in the pattern number. No upcharge for this option.

Glide detail



Black Monofilament:

Code:	Desc:	Upcharge:
01	Beige	n/c
02	Brown	n/c
03	Silver	n/c
04	Green	n/c
05	Black	n/c
06	Red	n/c
07	Blue	n/c

Silver Monofilament:

Code:	Desc:	Upcharge:
08	Jade	\$18
09	Platinum	\$18

Cal 133:
Chadwick is Cal 133 approved standard.
No options or upcharge required.

Chadwick™
high task chair
basic control

	arm	description	pattern no.
Designer(s): Don Chadwick, 2005 	Armless	Basic control Note: Arms cannot be added later	33-NA-2-BK-B-S-X-HC #
	Fixed arms	Basic control	33-FA-2-BK-B-S-X-HC #
	Height and width adjustable arms	Basic control Note: A tall adjustable arm option is available. See below for details.	33-AA-2-BK-B-S-X-HC #

For Chadwick Fabric selections and pricing, see facing page.

Order Code	Ordering Information	Options
<i>Example:</i> 33-AA-2-BK-T-S-X-HC-05	<i>Specify:</i>	<i>Arm Option:</i>
33 Chadwick Chair	1. Pattern number	For Tall Adjustable Arm, replace AA with TA in the pattern number. The tall arm is 1/4" higher than the standard adjustable arm. No upcharge for this option.
AA Adjustable Arms	2. Fabric color	
2 High Task Chair	<i>Finish color:</i>	<i>Lumbar Option:</i>
BK Black Frame	Black	For lumbar, replace X with L in the pattern number. Add \$84 to list price.
T Tilt Stop Control		Note:
S Standard Cylinder		To order a lumbar separately, use pattern number 33LUMBAR. The list price is \$84.
X No Lumbar		
HC Hard Black Caster		
05 Black Chadwick Fabric		

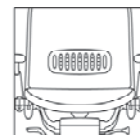

list

\$1,048.

1,118.

1,195.

Chadwick Fabric

Caster Option:
For soft casters, replace HC with SC in the pattern number, and add \$41 to the list price

Glides:
For glides, replace HC with GL in the pattern number. No upcharge for this option.

Glide detail



Black Monofilament:

Code:	Desc:	Upcharge:
01	Beige	n/c
02	Brown	n/c
03	Silver	n/c
04	Green	n/c
05	Black	n/c
06	Red	n/c
07	Blue	n/c

Silver Monofilament:

Code:	Desc:	Upcharge:
08	Jade	\$18
09	Platinum	\$18

Cal 133:
Chadwick is Cal 133 approved standard.
No options or upcharge required.

Chadwick™

Construction Information

Features and Benefits



Standard Features	Benefits
Active Suspension™ Technology includes: 1. Responsive synchronized control and tilt tension	The synchronized control and tilt tension allow the user's torso to open up, promoting healthy circulation and creating a ride that is characterized by a cradled feeling that keeps the user's back in contact with the chair.
2. Resilient, breathable seat and back suspension fabric	Chadwick Fabric provides inherent, energizing support all day long, conforming to the user's shape and minimizing pressure points. The open weave provides aeration.
Forward Tilt: Mechanism automatically includes forward tilt movement	Chadwick offers automatic support for forward seated positions without requiring any additional adjustments.
Variable Seat Depth: Seat depth automatically expands while reclining in the chair	Fits a multitude of users comfortably, no additional adjustments required.
Generous Lumbar Curvature	Chadwick's ample lumbar curvature and conforming back suspension fabric eliminate the need for an additional lumbar mechanism or attachment.
Flexing Arm Pads on Fixed and Adjustable Arms	Suspended design and shape allows the arm pads to flex for additional softness to alleviate pressure points on the wrists.
2 Simple Adjustments: Tension and Seat Height	With so much responsive movement built in, Chadwick only needs two adjustments. They are obvious and simple to operate.

Optional Features	Benefits
Tilt Stop Control	Limits the recline in the upright position to 5 degrees.
Adjustable Arms or Tall Adjustable Arms: both include width adjustment	One finger, ratchet adjustment quickly and easily adjusts. Width adjustment can be accomplished with $\frac{5}{32}$ " Allen wrench.
Optional Lumbar	Magnetic for easy installation, the lumbar provides a maximum range of adjustability.

To view fabrics online, refer to the Knoll Surface Library at knoll.com (go to the menu bar and click on "Resources" and click on "Surface Finish Library").

Care:

Frequent vacuuming or light brushing to remove dust and grime is recommended. Spot clean, with a mild upholstery shampoo or the foam from a mild detergent. When using a cleaning product, follow instructions carefully and clean only in a well-ventilated room. Avoid any product that contains carbon tetrachloride or other toxic materials. With any method, pretest a small area before proceeding. Use a professional furniture cleaning service when an overall soiled conditioned has been reached, or call Knoll Field Service at 800-445-5045 with questions.

Cleaning code

W or **W-S**, meaning water-based cleaning agents and foam or mild, water-free solvents may be used. See KnollTextiles price List for further details on cleaning codes.

Healthcare Cleaning Agents:

Chadwick successfully passed third-party testing for the following five cleaning agents commonly used in healthcare facilities:

- Clorox Germicidal Liquid Bleach diluted 1:5 ratio to tap water (pH 3.7)
- Clorox Cleanup undiluted 100% solution (pH 9.7)
- Wexcide 128 Concentrate Phenolic Germicide by Wexford Labs diluted 1 ounce to 1 gallon tap water (pH 3.7)
- Formula 880 Quarternary Germicide by Grand Technologies diluted $\frac{1}{2}$ ounce to 1 gallon tap water (pH 8.1)
- Hydroxi Pro concentrate 128 by Core Products diluted 1:8 ratio to tap water (pH 7.2)

Environmental:

SMaRT® Sustainable Gold certified.

SMaRT® Consensus Sustainable Product Standard is a comprehensive, transparent, sustainable product standard that measures a product's environmental, economic and social benefits over its life and throughout its global supply chain, from raw materials through reclamation or re-use. Chadwick can contribute to achieving a LEED® Innovation in Design Credit.

Cal 133 approved.

GREENGUARD® certified.

Chadwick is GREENGUARD Indoor Air Quality® and GREENGUARD for Children & Schools™ certified and can contribute to achieving LEED® credits.

Construction:

Back

Frame

Integrally-colored glass filled nylon

Chadwick Fabric

Polyester monofilament warp with multifilament fill fibers

Seat

Frame

Integrally-colored glass filled nylon

Chadwick Fabric

Polyester monofilament warp with multifilament fill fibers

Soft Edge

Polyurethane foam

Arms*Fixed/Adjustable Arm Pads*

Urethane armpad with flexible spring steel insert

Fixed/Adjustable Arm Supports

Integrally-colored glass filled nylon

Base & Casters*Base*

Integrally-colored glass filled nylon

Casters and Glides

Integrally-colored nylon

Soft Casters

Integrally-colored urethane covered nylon

Cylinder

Gas-activated steel seat height mechanism with steel tube (contains nitrogen)

Control

Control housing-aluminum casting and ABS top cover
Component parts-steel, rubber and engineered plastics

Optional Lumbar

Neodymium magnets, polypropylene carrier, TPE pad and back frame

Durability

10 year, 24-hour, 7 days a week, multi-shift warranty including Chadwick Fabric. See details in the Selling Policy at the end of the Price List.

Chadwick Fabric exceeds 100,000 double rubs Wyzenbeek Method.

Chadwick™ Dimensions and Operating Instructions

	BIFMA G1-2002 Ergonomic Guidelines	Chadwick Ergonomic Dimensions	
Seat*			
		Chadwick	Chadwick High Task
Seat Height	15" - 19.9" minimum range (one or combination of chairs)	15" - 19.1" (low cylinder) 15.9" - 20" (standard cylinder) 16.9" - 21.6" (high cylinder)	23.25" - 30.75"
Seat Depth (Adjustable)	Include 16.9" or less in range	16.9" - 19.4" (range includes reclined position)	16.9" - 19.4" (range includes reclined position)
Seat Width	18" minimum	19.6"	19.6"
Seat Pan Angle (Adjustable)	Include part of 0° - +4° range	-5° - +7° (range includes forward and reclined positions)	-5° - +7° (range includes forward and reclined positions)
Back*			
Backrest Height	12.2" minimum	22.8"	22.8"
Backrest Width	14.2" minimum	18.5"	18.5"
Lumbar Support (Fixed)	In range of 5.9" - 9.8"	7"	7"
Lumbar Support (Adjustable)	Include part of 5.9" - 9.8" range	Exceeds 5.9" - 9.9" (optional lumbar)	Exceeds 5.9" - 9.9" (optional lumbar)
Angle Between Seat and Back	≥90°, include 10° movement in 90° - 115° range	94° - 120°	94° - 120°
Tilt Range of Back	10° minimum	26°	26°
Arms*			
Armrest Height (Fixed)	In range of 7.9" - 9.8"	8.5" (fixed arm)	8.5" (fixed arm)
Armrest Height (Adjustable)	6.9" - 10.8" minimum range (single or multiple sets of arms)	6.9" - 9.4" (adjustable) 8.3" - 10.8" (tall adjustable)	6.9" - 9.4" (adjustable) 8.3" - 10.8" (tall adjustable)
Inside Distance Between Armrests (Fixed)	18" minimum	19.5" (fixed)	19.5" (fixed)
Inside Distance Between Armrests (Adjustable)	Include 18" in range	18.5" - 20.5" (adjustable and tall adjustable)	18.5" - 20.5" (adjustable and tall adjustable)

* All measurements taken with BIFMA Chair Measuring Device using the Universal Measurement Procedure which has a measurement uncertainty of ± 5%

Chadwick Chair Measurements

	Chadwick**	Chadwick High Task
A. Overall Height	37.5" - 42"	44.5" - 52"
B. Overall Width	26.5"	26.5"
C. Overall Depth	25.5"	25.5"
D. Arm Height from Floor	25.5" - 30" (fixed arm) 24" - 31" (adjustable) 24.75" - 31.75" (tall adjustable)	32.5" - 40" (fixed arm) 31" - 41" (adjustable) 31.75" - 41.75" (adjustable)
E. Base Diameter	26.5"	26.5"
Weight	37 lbs. (with arms)	41 lbs. (with arms)

**Standard cylinder

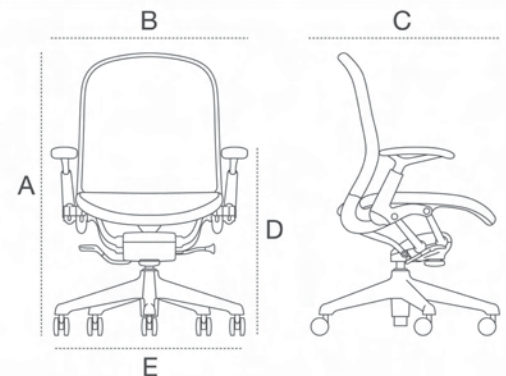

Chadwick - Additional Information

Synchronized recline ratio seat : back is 1° : 1.2°

Adjustable and tall adjustable arms adjust 2" in armpad width (1" per side) with 5/32" Allen wrench

Optional lumbar measures 11.25" x 4.4"

Chadwick High Task footring measures 19.875" in diameter

Chadwick High Task footring adjusts 5" in height by a single lever mechanism with 11 locking positions in 1/2" increments

Compliance: ANSI/BIFMA X5.1 : 2002 (U.S. structural standard), BIFMA G1 : 2002 (U.S. ergonomic guidelines),

California T.B. 117 (U.S. flammability standard for foam), California T.B. 133 (U.S. flammability standard for full chair)

The Chadwick chair line has been tested and is approved for use by individuals weighing up to 300 pounds.

Chadwick™ Operating Instructions

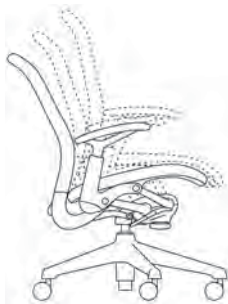

Synchronized Recline with Tilt Tension
Chadwick has a synchronized recline that allows the torso to open up while reclining. To customize the tension of the recline, adjust the tension knob. To decrease the tension, turn the tension knob clockwise (while seated in the chair), and turn it counterclockwise to increase the tension. The underside of the knob also indicates the instructions with arrows.

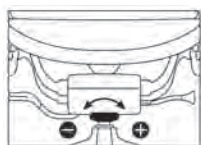

Front View



Seat Height Adjustment
To raise the seat height, remove your weight from the chair while lifting the lever on the right side of the chair. To lower the seat height, lift the lever while sitting in the chair.

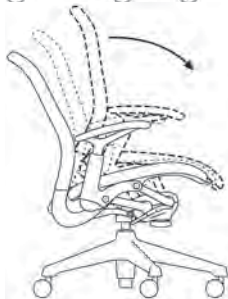

Forward Tilt
Chadwick has a built-in forward tilt that automatically follows and supports the user in the forward posture for typing. No adjustment is required.

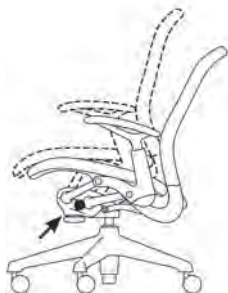

Tilt Stop (Option)
The tilt stop is an upright tilt limiter. When specified, it is the lever on the left side of the chair. If your chair does not have a lever on the left side of the chair, it does not have this feature. The in-and-out lever design operates with an audible click, whereby “out” is engaged, “in” is not engaged.

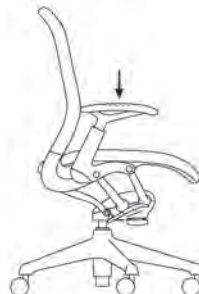

Spring Loaded Arms
Both fixed and adjustable arm pads have a spring suspension, which provides the user with arm pad softness and flexibility.

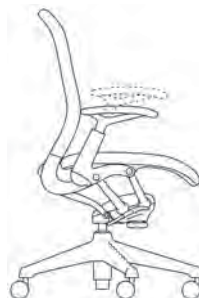

Adjustable Arm Height (Option)
The arm height is adjusted by lifting the arm pads upward. No lever is required. Simply move the arms up in five, $\frac{1}{2}$ " increments for a total of $2\frac{1}{2}$ ". To lower the arms, lift them to the highest point and at the highest point pull up firmly; and they will return to the lowest point. The arm height adjustment is easy to maneuver with one hand.

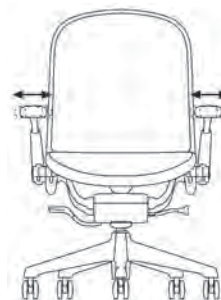

Adjustable Arm Width (Option)
The arm pads have a width adjustment of $\frac{1}{2}$ " inward or $\frac{1}{2}$ " outward for 1" in total adjustability on each side. A $\frac{3}{32}$ " Allen wrench is required to adjust the arm pad width.

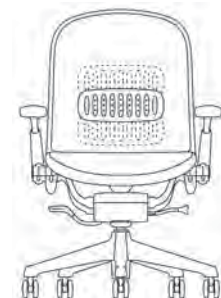

Adjustable Lumbar (Option)
Chadwick has an adjustable lumbar support, if needed. It is secured to the chair with magnets for easy installation and a maximum range of adjustability.





Separate both halves of the lumbar support and place them in the desired position on your chair. Secure the support by putting both halves together around the back suspension fabric of the chair.

Adjust the lumbar by sliding the lumbar pad up and down the back of the chair.

Note: Contains magnets. Consult the Knoll lumbar support hangtag for more information.

RPM®

basic control

	arm	description	pattern no.
<p><i>Designer(s):</i> Carl Magnusson, 2000</p> 	High performance arm	Basic control	8P4-2-A5GH
		Basic control: synchronized tilt, 4" back height, forward tilt, tilt lock (5 position), side-position tension knob, pneumatic seat height, 360° swivel, instructions attached to side of control	
	Fixed height arm	Basic control	8A4-2-A5GH
		Basic control: synchronized tilt, 4" back height, forward tilt, tilt lock (5 position), side-position tension knob, pneumatic seat height, 360° swivel, instructions attached to side of control	
	Armless	Basic control	8C4-2-A5GH
		Basic control: synchronized tilt, 4" back height, forward tilt, tilt lock (5 position), side-position tension knob, pneumatic seat height, 360° swivel, instructions attached to side of control	
	Replacement seat		8RSEAT
	Replacement back, prior to 11/01/2005		8RBACK
	Replacement back, after 11/01/2005		8UPHBACK

Order Code

<i>Example:</i>	8A4-2-A5GH SP7
8A4	RPM task chair, fixed arms
2	Black finish and black levers
A5G	Basic control
H	Hard caster for carpet
SP7	Speedway, Black

Ordering Information

Specify:

1. Pattern number
2. Upholstery selection

Finish color:
Black

Options

Cylinder Height Options:
For height ranges see RPM Dimensions and Operating Instructions. Replace 5 in pattern with one of the following options:

Code:	Upchg:	Description:
L	n/c	low cylinder
H	n/c	high cylinder

Caster and Glide Options:
Substitute H in pattern with one of the following:

Code:	Upchg:	Description:
R	\$49	Soft casters for hard surfaces
G	n/c	Glides

RPM grade	grades A	COM B	C	D	E	F	G	H	I	T	COL U	V	W	Y
\$972.	\$1,105.	\$1,152.	\$1,206.	\$1,233.	\$1,267.	\$1,308.	\$1,367.	\$1,441.	\$1,480.	\$1,766.	\$1,857.	\$1,966.	\$2,646.	\$2,783.
897.	1,033.	1,080.	1,131.	1,158.	1,193.	1,233.	1,294.	1,367.	1,408.	1,691.	1,783.	1,891.	2,571.	2,709.
857.	992.	1,039.	1,093.	1,119.	1,152.	1,193.	1,252.	1,328.	1,367.	1,650.	1,741.	1,849.	2,529.	2,667.
277.	405.	449.	501.	525.	557.	596.	652.	725.	763.	1,019.	1,110.	1,214.	1,861.	2,172.
287.	412.	459.	509.	534.	567.	606.	663.	733.	771.	1,029.	1,120.	1,223.	1,871.	2,211.
287.	412.	459.	509.	534.	567.	606.	663.	733.	771.	1,029.	1,120.	1,223.	1,871.	2,211.

RPM Grade Upholsteries*Radial*

RAD7	Midnight/Huckleberry
RAD8	Black/Batik
RAD9	Black/Crimson
RAD10	Claret/Jute
RAD22	Spice/Jute
RAD23	Cappuccino/Pebble Beige
RAD25	Basil/Xanadu
RAD27	Black/Smoke
RAD28	Smoke/Black
RAD29	Smoke/Pebble Beige

Speedway

SP2	Smoke
SP3	Steel Blue
SP5	Midnight
SP6	Crimson
SP7	Black
SP10	Basil
SP33	Wine
SP36	Chocolate

Ordering Samples/Viewing online:
To view RPM upholstery colors refer to the Surface Finish Library on knoll.com. Physical samples are the best representation of color. To order samples, contact a Knoll sales representative or Knoll dealer.

Textile Options**KnollTextiles Fabrics and Spinneybeck Leathers**

Please refer to the textile matrices at the beginning of the price list for approved fabrics and leathers.

COM/COL Textile Requirement

	fabric yds.	leather sq. ft.
chair	1.4	25





Cal 133:

‡= Cal 133 upholstery available. See textile matrices at the beginning of the price list for pre-approved Cal 133 textiles.

To specify, add C after pattern number and 133 after upholstery code.

<i>Code:</i>	<i>Upchg:</i>	<i>Description:</i>
C()133	\$129	Cal 133 textile

RPM®
advanced control

	arm	description	pattern no.
<p>Designer(s): Carl Magnusson, 2000</p> 	High performance arm	Advanced control (sliding seat pan)	8P4-2-A5KH
		Advanced control: synchronized tilt, 4" back height, sliding seat adjustment, forward tilt, tilt lock (5 position side-position tension knob, pneumatic seat height, 360° swivel, instructions attached to side of control	
	Fixed height arms	Advanced control (sliding seat pan)	8A4-2-A5KH
		Advanced control: synchronized tilt, 4" back height, sliding seat adjustment, forward tilt, tilt lock (5 position side-position tension knob, pneumatic seat height, 360° swivel, instructions attached to side of control	
	Armless	Advanced control (sliding seat pan)	8C4-2-A5KH
		Advanced control: synchronized tilt, 4" back height, sliding seat adjustment, forward tilt, tilt lock (5 position side-position tension knob, pneumatic seat height, 360° swivel, instructions attached to side of control	
	Replacement seat		8RSEAT
	Replacement back, prior to 11/01/2005		8RBACK
	Replacement back, after 11/01/2005		8UPHBACK

Order Code

<i>Example:</i>	8A4-2-A5KH SP7
8A4	RPM task chair, fixed arms
2	Black finish and black levers
A5K	Advanced control with sliding seat
H	Hard caster for carpet
SP7	Speedway, Black

Ordering Information

Specify:

1. Pattern number
2. Upholstery selection

Finish color:
Black

Options

Cylinder Height Options:
For height ranges see RPM Dimensions and Operating Instructions. Replace 5 in pattern with one of the following options:

Code:	Upchg:	Description:
L	n/c	low cylinder
H	n/c	high cylinder

Caster and Glide Options:
Substitute H in pattern with one of the following:

Code:	Upchg:	Description:
R	\$49	Soft casters for hard surfaces
G	n/c	Glides

RPM grade	grades A	COM B	C	D	E	F	G	H	I	T	COL U	V	W	Y
\$1,009.	\$1,137.	\$1,181.	\$1,232.	\$1,257.	\$1,290.	\$1,328.	\$1,384.	\$1,455.	\$1,494.	\$1,762.	\$1,851.	\$1,955.	\$2,605.	\$2,734.
938.	1,066.	1,111.	1,162.	1,187.	1,218.	1,257.	1,315.	1,384.	1,423.	1,690.	1,781.	1,886.	2,532.	2,663.
898.	1,026.	1,073.	1,123.	1,148.	1,181.	1,218.	1,277.	1,347.	1,384.	1,651.	1,742.	1,846.	2,494.	2,625.
277.	405.	449.	501.	525.	557.	596.	652.	725.	763.	1,019.	1,110.	1,214.	1,861.	2,172.
287.	412.	459.	509.	534.	567.	606.	663.	733.	771.	1,029.	1,120.	1,223.	1,871.	2,211.
287.	412.	459.	509.	534.	567.	606.	663.	733.	771.	1,029.	1,120.	1,223.	1,871.	2,211.

RPM Grade Upholsteries*Radial*

RAD7	Midnight/Huckleberry
RAD8	Black/Batik
RAD9	Black/Crimson
RAD10	Claret/Jute
RAD22	Spice/Jute
RAD23	Cappuccino/Pebble Beige
RAD25	Basil/Xanadu
RAD27	Black/Smoke
RAD28	Smoke/Black
RAD29	Smoke/Pebble Beige

Speedway

SP2	Smoke
SP3	Steel Blue
SP5	Midnight
SP6	Crimson
SP7	Black
SP10	Basil
SP33	Wine
SP36	Chocolate

Ordering Samples/Viewing online:
To view RPM upholstery colors refer to the Surface Finish Library on knoll.com. Physical samples are the best representation of color. To order samples, contact a Knoll sales representative or Knoll dealer.

Textile Options**KnollTextiles Fabrics and Spinneybeck Leathers**

Please refer to the textile matrices at the beginning of the price list for approved fabrics and leathers.

COM/COL Requirement

	fabric yds.	leather sq. ft.
chair	1.4	25

Cal 133:

‡ = Cal 133 upholstery available. See textile matrices at the beginning of the price list for pre-approved Cal 133 textiles.



To specify, add C after pattern number and 133 after upholstery code.

<i>Code:</i>	<i>Upchg:</i>	<i>Description:</i>
C()133	\$129	Cal 133 textile

RPM®
high task chair
basic control

Designer(s):
 Carl Magnusson, 2000



arm	description	pattern no.
High performance arm 	Basic control, mechanical height footring (9" - 18" height range) Basic control: synchronized tilt, 4" back height adjustment, forward tilt, tilt lock (5 position), side-position tension knob, pneumatic seat height, 360 degree swivel, instructions attached to side of control, mechanical height footring	8P5-2-A5GH
Fixed height arms 	Basic control, mechanical height footring (9" - 18" height range) Basic control: synchronized tilt, 4" back height adjustment, forward tilt, tilt lock (5 position), side-position tension knob, pneumatic seat height, 360 degree swivel, instructions attached to side of control, mechanical height footring	8A5-2-A5GH
Armless 	Basic control, mechanical height footring (9" - 18" height range) Basic control: synchronized tilt, 4" back height adjustment, forward tilt, tilt lock (5 position), side-position tension knob, pneumatic seat height, 360 degree swivel, instructions attached to side of control, mechanical height footring	8C5-2-A5GH
Replacement seat		8RSEAT
Replacement back, prior to 11/01/2005		8RBACK
Replacement back, after 11/01/2005		8UPHBACK

Order Code

<i>Example:</i>	8A5-2-A5GH SP7
8A5	RPM high task chair, fixed arms
2	Black finish and black levers
A5G	Basic control
H	Hard caster for carpet
SP7	Speedway, Black

Ordering Information

Specify:
 1. Pattern number
 2. Upholstery selection

Finish color:
 Black

Options

Caster and Glide Options:
 Substitute H in pattern with one of the following:

Code:	Upchg:	Description:
R	\$49	Soft casters for hard surfaces
G	n/c	Glides

RPM grade	grades A	COM B	C	D	E	F	G	H	I	T	COL U	V	W	Y
\$1,251.	\$1,385.	\$1,434.	\$1,487.	\$1,512.	\$1,545.	\$1,589.	\$1,649.	\$1,721.	\$1,761.	\$2,050.	\$2,142.	\$2,249.	\$2,930.	\$3,289.
1,180.	1,314.	1,359.	1,413.	1,440.	1,475.	1,512.	1,573.	1,649.	1,689.	1,977.	2,066.	2,178.	2,856.	3,217.
1,139.	1,272.	1,319.	1,375.	1,400.	1,434.	1,475.	1,534.	1,607.	1,649.	1,936.	2,027.	2,136.	2,815.	3,184.
277.	405.	449.	501.	525.	557.	596.	652.	725.	763.	1,019.	1,110.	1,214.	1,861.	2,172.
287.	412.	459.	509.	534.	567.	606.	663.	733.	771.	1,029.	1,120.	1,223.	1,871.	2,211.
287.	412.	459.	509.	534.	567.	606.	663.	733.	771.	1,029.	1,120.	1,223.	1,871.	2,211.

RPM Grade Upholsteries*Radial*

RAD7	Midnight/Huckleberry
RAD8	Black/Batik
RAD9	Black/Crimson
RAD10	Claret/Jute
RAD22	Spice/Jute
RAD23	Cappuccino/Pebble Beige
RAD25	Basil/Xanadu
RAD27	Black/Smoke
RAD28	Smoke/Black
RAD29	Smoke/Pebble Beige

Speedway

SP2	Smoke
SP3	Steel Blue
SP5	Midnight
SP6	Crimson
SP7	Black
SP10	Basil
SP33	Wine
SP36	Chocolate

Ordering Samples/Viewing online:

To view RPM upholstery colors refer to the Surface Finish Library on knoll.com. Physical samples are the best representation of color. To order samples, contact a Knoll sales representative or Knoll dealer.

Textile Options**KnollTextiles Fabrics and Spinneybeck Leathers**

Please refer to the textile matrices at the beginning of the price list for approved fabrics and leathers.

COM/COL Textile Requirement

	fabric yds.	leather sq. ft.
chair	1.4	25

Cal 133:

‡ = Cal 133 upholstery available. See textile matrices at the beginning of the price list for pre-approved Cal 133 textiles.



To specify, add C after pattern number and 133 after upholstery code.

<i>Code:</i>	<i>Upchg:</i>	<i>Description:</i>
C()133	\$129	Cal 133 textile

RPM®
high task chair
advanced control

Designer(s):
 Carl Magnusson, 2000



arm	description	pattern no.
High performance arm 	Advanced control, mechanical height footring (9" - 18" height range) Advanced control: synchronized tilt, 4" back height, adjustment forward tilt, tilt lock (5 position), sliding seat-depth adjustment, side-position tension knob, pneumatic seat height, 360 degree swivel, instructions, mechanical height footring	8P5-2-A5KH
Fixed height arm 	Advanced control, mechanical height footring (9" - 18" height range) Advanced control: synchronized tilt, 4" back height adjustment, forward tilt, tilt lock (5 position), sliding seat-depth adjustment, side-position tension knob, pneumatic seat height, 360 degree swivel, instructions, mechanical height footring	8A5-2-A5KH
Armless 	Advanced control, mechanical height footring (9" - 18" height range) Advanced control: synchronized tilt, 4" back height adjustment, forward tilt, tilt lock (5 position), sliding seat-depth adjustment, side-position tension knob, pneumatic seat height, 360 degree swivel, instructions, mechanical height footring	8C5-2-A5KH
Replacement seat		8RSEAT
Replacement back, prior to 11/01/2005		8RBACK
Replacement back, after 11/01/2005		8UPHBACK

Order Code

<i>Example:</i>	8A5-2-A5KH SP7
8A5	RPM high task chair, fixed arms
2	Black finish and black levers
A5K	Advanced control
H	Hard caster for carpet
SP7	Speedway, Black

Ordering Information

Specify:

1. Pattern number
2. Upholstery selection

Finish color:
 Black

Options

Caster and Glide Options:
 Substitute H in pattern with one of the following:

Code:	Upchg:	Description:
R	\$49	Soft casters for hard surfaces
G	n/c	Glides

RPM grade	grades A	COM B	C	D	E	F	G	H	I	T	COL U	V	W	Y
\$1,290.	\$1,416.	\$1,462.	\$1,511.	\$1,538.	\$1,570.	\$1,607.	\$1,665.	\$1,736.	\$1,775.	\$2,047.	\$2,138.	\$2,241.	\$2,889.	\$3,240.
1,218.	1,347.	1,392.	1,442.	1,469.	1,501.	1,538.	1,595.	1,665.	1,730.	1,976.	2,065.	2,169.	2,817.	3,173.
1,181.	1,309.	1,352.	1,405.	1,429.	1,462.	1,501.	1,557.	1,627.	1,665.	1,937.	2,029.	2,130.	2,780.	3,144.
277.	405.	449.	501.	525.	557.	596.	652.	725.	763.	1,019.	1,110.	1,214.	1,861.	2,172.
287.	412.	459.	509.	534.	567.	606.	663.	733.	771.	1,029.	1,120.	1,223.	1,871.	2,211.
287.	412.	459.	509.	534.	567.	606.	663.	733.	771.	1,029.	1,120.	1,223.	1,871.	2,211.

RPM Grade Upholsteries*Radial*

RAD7	Midnight/Huckleberry
RAD8	Black/Batik
RAD9	Black/Crimson
RAD10	Claret/Jute
RAD22	Spice/Jute
RAD23	Cappuccino/Pebble Beige
RAD25	Basil/Xanadu
RAD27	Black/Smoke
RAD28	Smoke/Black
RAD29	Smoke/Pebble Beige

Speedway

SP2	Smoke
SP3	Steel Blue
SP5	Midnight
SP6	Crimson
SP7	Black
SP10	Basil
SP33	Wine
SP36	Chocolate

Ordering Samples/Viewing online:

To view RPM upholstery colors refer to the Surface Finish Library on knoll.com. Physical samples are the best representation of color. To order samples, contact a Knoll sales representative or Knoll dealer.

Textile Options**KnollTextiles Fabrics and Spinneybeck Leathers**

Please refer to the textile matrices at the beginning of the price list for approved fabrics and leathers.

COM/COL Textile Requirement

	fabric yds.	leather sq. ft.
chair	1.4	25

Cal 133:

‡ = Cal 133 upholstery available. See textile matrices at the beginning of the price list for pre-approved Cal 133 textiles.

To specify, add C after pattern number and 133 after upholstery code.

<i>Code:</i>	<i>Upchg:</i>	<i>Description:</i>
C()133	\$129	Cal 133 textile

RPM®
side chair

	arm	description	pattern no.
<i>Designer(s):</i> Dragomir Ivcevic	Armchair	Armcap painted frame	6A8-(2)-SL
	Armless	Painted frame	6C8-(2)-SL
<i>Award(s):</i> Arango Design Foundation Exhibit, Refuse: Good Everyday Products from Reused and Recycled Materials, 1995	Reupholstery assembly		6RS8



Order Code

<i>Example:</i>	6A8-2-SL-SP7
6A8	RPM Side armchair
2	black finish
SL	sled base
SP7	Speedway, Black

Ordering Information

<i>Specify:</i>
1. Pattern number.
2. Upholstery selection
<i>Finish color:</i>
Black

grades	COM									COL
A	B	C	D	E	F	G	H	I	T	U
\$582.	\$616.	\$648.	\$672.	\$696.	\$712.	\$734.	\$769.	\$781.	\$1,143.	\$1,176.
541.	577.	609.	632.	654.	674.	696.	728.	741.	1,105.	1,138.
270.	299.	333.	356.	377.	394.	417.	457.	471.	811.	842.

KnollTextiles and Spinneybeck Leathers

Please refer to the textile matrices at the beginning of the price list for approved fabrics and leathers.

COM/COL Textile Requirement

	fabric	leather
	yds.	sq. ft.
chair	1.3	17

Cal 133:

♣ = Cal 133 upholstery available. See textile matrices at the beginning of the price list for pre-approved Cal 133 textiles.

To specify, add C after pattern number and 133 after upholstery code.

Code:	Upchg:	Description:
C()133	\$99	Cal 133 textile

RPM Knits

RPM Knits Speedway and Radial are priced at Grade A for the RPM side chair.

Construction**Outer shell:**

Integrally colored, textured polypropylene.

Internal support:

Cold rolled, mild carbon 14-gauge steel J-Bar.

Upholstery:

Integrally colored, textured ABS plastic upholstery liner with molded urethane foam; fabric is permanently bonded to the CFC-free foam.

Frame:

Cold rolled mild carbon 12-gauge steel tube with textured epoxy powder coat paint finish.

Arm caps:

Integrally colored, textured ABS plastic.

Glides:

Black, integrally colored, textured, glass-reinforced nylon.

RPM® Dimensions and Operating Instructions

	BIFMA G1-2002 Ergonomic Guidelines	RPM Ergonomic Dimensions	
Seat*			
		RPM	RPM High Task
Seat Height	15" - 19.9" minimum range (one or combination of chairs)	15" - 17.75" (low cylinder) 16.5" - 20.5" (medium cylinder) 18.75" - 23.75" (high cylinder)	23.5" - 31.25"
Seat Depth (Fixed)	16.9" or less	17.5" (basic control)	17.5" (basic control)
Seat Depth (Adjustable)	Include 16.9" or less in range	16.5" - 18.5" (advanced control)	16.5" - 18.5" (advanced control)
Seat Width	18" minimum	20.5"	20.5"
Seat Pan Angle (Adjustable)	Include part of 0° - +4° range	-3° - +2° (includes forward tilt)	-3° - +2° (includes forward tilt)
Back*			
Backrest Height	12.2" minimum	21" - 25"	21" - 25"
Backrest Width	14.2" minimum	19"	19"
Lumbar Support (Adjustable)	Include part of 5.9" - 9.8" range	5.9" - 9.9"	5.9" - 9.9"
Angle Between Seat and Back	≥90°, include 10° movement in 90° - 115° range	93° - 118°	93° - 118°
Tilt Range of Back	10° minimum	25°	25°
Arms*			
Armrest Height (Fixed)	In range of 7.9" - 9.8"	8.4" (fixed arm)	8.4" (fixed arm)
Armrest Height (Adjustable)	6.9" - 10.8" minimum range (single or multiple sets of arms)	7.25" - 10.5" (high performance)	7.25" - 10.5" (high performance)
Inside Distance Between Armrests (Adjustable)	Include 18" in range	16.5" - 19" (fixed arm) 17.75" - 19.75" (high performance)	16.5" - 19" (fixed arm) 17.75" - 19.75" (high performance)

* All measurements taken with BIFMA Chair Measuring Device using the Universal Measurement Procedure which has a measurement uncertainty of ± 5%

RPM Chair Measurements**

	RPM	RPM High Task	RPM Side
A. Overall Height	37.1" - 45.6" (medium cylinder)	43.75" - 51"	32.5"
B. Overall Width	27"	27"	22"
C. Overall Depth	26.5" (basic control) 25.5" - 26.5" (advanced control)	26.5" (basic control) 25.5" - 26.5" (advanced control)	23.5"
D. Arm Height from Floor	25" - 29.5" (fixed arm) 23.75" - 31.5" (high performance)	25" - 29.5" (fixed arm) 23.75" - 31.5" (high performance)	25"
E. Base Diameter	28"	28"	22.5" wide
Weight	44 lbs.	51 lbs.	28 lbs.

** With arms

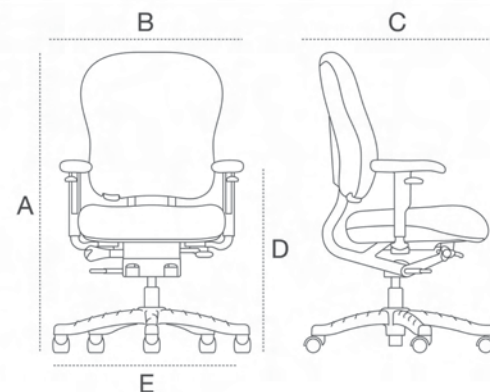

RPM - Additional Information

High performance arm pads pivot 30° (±15°, 3 fixed positions)

RPM High Task footing measures 20" in diameter and adjusts 9" - 18" in height

RPM Side chair seat is 17.75" from the floor; arms are 7.75" from seat; the inside distance between the arms is 19.9"

Compliance: ANSI/BIFMA X5.1 : 1993 (U.S. structural standard), BIFMA G1 : 2002 (U.S. ergonomic guidelines),

California T.B. 117 (U.S. flammability standard for foam), California T.B. 133 with approved FR textile (U.S. flammability standard for full chair)

The RPM chair line has been tested and is approved for use by individuals weighing up to 300 pounds.

RPM® Operating Instructions



Tilt Tension

On the right side of the seat, there is a retractable knob which facilitates the adjustment when the knob is extended. Turn the knob forward to tighten and backward to loosen. When finished, tuck the knob under the seat.

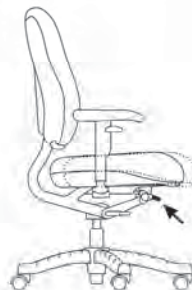

Seat Depth

The sliding seat activation is located underneath the seat on the front, left-hand side of the control. The adjustment mechanism is a button that has a space for two fingers. To activate, push up on the button and move the seat forward or backward. There are 4 positions within a 2" range.

(on Advanced Models only)

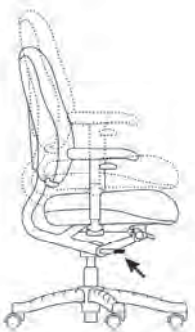

Seat Height

While seated, lift the lever on the right side of the chair to lower seat height. Remove your weight from the chair and lift the handle to raise the chair to the highest position.

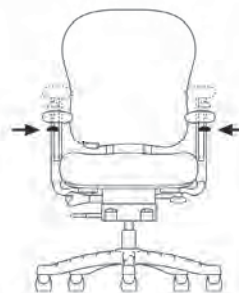

High Performance Arms

High Performance arms are controlled by the lever next to the armpad and from the knob beneath the arm support.

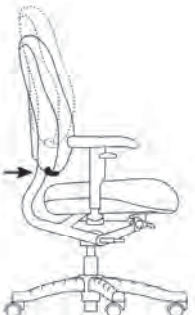

Back Height

Press the lever on the bottom of the right side of the back cushion to reposition the back height within a four inch range. It is necessary to press the lever to make the back move.



Arm Height and Armpad Pivot

Press the lever next to the armpad to adjust the arm height and to set the arm pivot in one of three fixed positions.

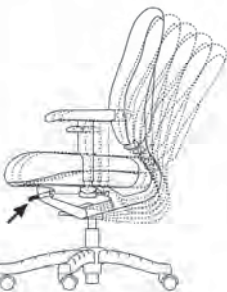

Multiple Stop Tilt Lock and Upright Tilt Lock

To lock the chair upright or in a reclined position, lift the lever on the front left side of the chair. Push down on the lever and recline to unlock the chair.

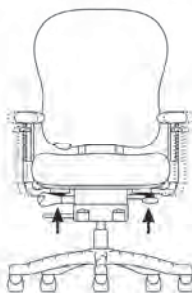

Arm Width

Loosen the knob under the arm support to adjust the arm support placement on the chair. There is a 2" total width adjustment for all arms (fixed and height-adjustable)



Forward Tilt

The forward tilt button is located on the rear, left-hand side of the control—to activate, push the lever in, lift your weight off the seat, and pull up on the rear of the seat to tilt it forward.

RPM® Control Index and Construction Information

Control Index

Advanced Control	Features	Explanations
	Synchronized tilt (1:1.9)	Back reclines 1.9 times faster than seat
	Tilt lock (5 positions)	Chair back can be locked in upright and reclined positions
	Forward tilt (3°)	Chair locks in a forward tilting position for intensive keyboarding application
	4" back height adjustment	Allows for correct positioning of lumbar support
	2" seat depth adjustments	Seat adjusts in depth to provide proper support under the legs of both taller and shorter users
	Retractable tension knob	Tension knob is easy to reach and tucks out of the way when not in use
	Instructions	Easy to reach instruction card attached to chair makes adjusting the chair easy for everyone
	Dual J-Bar	Provides additional support for the back
	360° swivel	

Basic Control	Features	Explanations
	Synchronized tilt (1:1.9)	Back reclines 1.9 times faster than seat
	Tilt lock (5 positions)	Chair can be locked in upright and reclined positions
	Forward tilt (3°)	Chair locks in a forward tilting position for intensive keyboarding application
	4" back height adjustment	Allows for correct positioning of lumbar support
	Retractable tension knob	Tension knob is easy to reach and tucks out of the way when not in use
	Instructions	Easy to reach instruction card attached to chair makes adjusting the chair easy for everyone
	Dual J-Bar	Provides additional support for the back
	360° swivel	





RPM Task and High Task Construction Information	Part	Materials
	Outer shells:	Integrally colored, textured polypropylene.
	Seat structure:	Glass-reinforced nylon with steel connectors (for basic control, laminated plywood).
	Back and J-Bar structure:	Glass-reinforced nylon, ABS and steel connector plate.
	Cushions and upholstery:	Insert molded high resilient urethane foam. Back is permanently bonded to CFC free foam. RPM grade covers are knitted to fit the cushion.
	Fixed height arms/high performance arms:	Integrally colored, textured glass-reinforced nylon.
	Armpads:	Molded urethane and steel substructure.
	Base:	Integrally colored, textured, glass-reinforced nylon.
	Casters and glides:	Black, integrally colored, textured nylon.

This page intentionally left blank.

EWC Pro™
upholstered mid-back task chair
synchronized tilt control

Designer(s):
 Jeffrey Bernett and
 Nicholas Dodziuk, 2005



arm	description	pattern no.
Armless 	Upholstered mid-back task chair with plastic outer back, 2.5" back height adjustment, plastic base, synchronized control	77W-MB-2-SY-NA-5-HC
Loop arms 	Upholstered mid-back task chair with plastic outer back, 2.5" back height adjustment, plastic base, synchronized control	77W-MB-2-SY-LA-5-HC
Fixed arms 	Upholstered mid-back task chair with plastic outer back, 2.5" back height adjustment, plastic base, synchronized control	77W-MB-2-SY-FA-5-HC
Height/width adjustable arms 	Upholstered mid-back task chair with plastic outer back, 2.5" back height adjustment, plastic base, synchronized control,	77W-MB-2-SY-HA-5-HC
High performance arms 	Upholstered mid-back task chair with plastic outer back, 2.5" back height adjustment, plastic base, synchronized control	77W-MB-2-SY-HP-5-HC
Upholstered outer back	(insert U after MB in the pattern number)	U

Order Code

Example: **77W-MB-2-SY-HA-5-SL-HC K1000/8**

77W	EWC Pro task chair
MB	Mid-back
2	Black finish
SY	Synchronized tilt control
HA	Height and width adjustable arms
5	Standard height cylinder
SL	Sliding seat
HC	Hard wheel black casters
K1000/8	Presto, Red Carpet

Ordering Information

Specify:

1. Pattern number
2. Seat and back upholstery

Finish color:
 Black

Options

Polished Aluminum Base:
 Replace 2 in pattern with 4. Only available with standard height cylinder.

Code: Upchg: Description:
 4 \$150 polished aluminum base

Options

Cylinder Height Option:
 For low height cylinder (plastic base only), replace 5 in pattern number with L. See Dimensions page for seat height range.

Code: Upchg: Description:
 L \$71 low cylinder

Caster and Glide Options:
 Substitute HC in pattern with one of the following options:

Code:	Upchg:	Description:
SC	n/c	soft black casters for hard surfaces
GL	n/c	glides

Sliding Seat Option:
 For sliding seat with 2.75" of depth adjustment insert SL after cylinder choice in pattern number. Adds 0.5" to seat height.

Code: Upchg: Description:
 SL \$39 sliding seat

list price Presto base grade	A	COM B	C	D	E	F	G	H	I	T	COL U	V	W	X	Y
\$616.	\$622.	\$639.	\$663.	\$690.	\$716.	\$746.	\$763.	\$769.	\$787.	\$1,051.	\$1,189.	\$1,319.	\$1,547.	n/a	\$1,759.
671.	678.	695.	718.	745.	773.	802.	817.	824.	842.	1,108.	1,244.	1,376.	1,605.	n/a	1,816.
671.	678.	695.	718.	745.	773.	802.	817.	824.	842.	1,108.	1,244.	1,376.	1,605.	n/a	1,816.
700.	707.	724.	747.	775.	801.	830.	846.	853.	872.	1,136.	1,274.	1,405.	1,634.	n/a	1,845.
716.	722.	739.	763.	790.	816.	846.	863.	869.	887.	1,151.	1,289.	1,419.	1,647.	n/a	1,859.
72.	74.	82.	91.	102.	112.	123.	131.	133.	141.	244.	298.	351.	442.	n/a	526.





Presto - Base Grade Fabric

<p><i>Color options:</i></p> <ul style="list-style-type: none"> Presto Winter White K1000/1 Presto Sand K1000/2 Presto Stone K1000/3 Presto Saffron K1000/4 Presto Spring Green K1000/5 Presto Blue Chip K1000/6 Presto Scarlet K1000/7 Presto Red Carpet K1000/8 Presto Beige Taupe K1000/9 Presto Olive K1000/10 Presto Navy Blue K1000/11 Presto Clear Gray K1000/12 Presto Charcoal Gray K1000/13 Presto Black Tie K1000/14 	<p><i>Split Upholstery:</i></p> <p>EWC Pro seats and backs can be upholstered in any two approved KnollTextiles or Spinneybeck upholsteries. To specify, first indicate the seat upholstery (labeled "seat upholstery") and then indicate the back upholstery (labeled "back upholstery"). The list price of the chair equals the list price of the higher of the two upholstery grades.</p> <p>For split upholstery on the upholstered outer back option, indicate "inner back" and "outer back" on upholstery selections. Add the list price upcharge of the grade selected for the upholstered outer back.</p>	<p><i>CAL 133 Options:</i></p> <p><i>Code: Upchg: Description:</i></p> <p>C133 \$78 CAL 133 textile on seat and back. No additional upcharge for upholstered outer back (add C133 to the end of the pattern number)</p>	<p>COM/COL Upholstery Requirements</p> <p>Textile yardage required: 2 yards Leather sq. ft. required: 28 sq. ft. Outer back shell: .8 yards or 12 sq. ft.</p>
---	---	---	--

EWC Pro™
upholstered mid-back task chair
swivel tilt control

Designer(s):
 Jeffrey Bernett and
 Nicholas Dodziuk, 2005



arm	description	pattern no.
Armless 	Upholstered mid-back task chair with plastic outer back, 2.5" back height adjustment, plastic base, swivel-tilt control	77W-MB-2-ST-NA-5-HC
Loop arms 	Upholstered mid-back task chair with plastic outer back, 2.5" back height adjustment, plastic base, swivel-tilt control	77W-MB-2-ST-LA-5-HC
Fixed arms 	Upholstered mid-back task chair with plastic outer back, 2.5" back height adjustment, plastic base, swivel-tilt control	77W-MB-2-ST-FA-5-HC
Height/width adjustable arms 	Upholstered mid-back task chair with plastic outer back, 2.5" back height adjustment, plastic base, swivel-tilt control	77W-MB-2-ST-HA-5-HC
High performance arms 	Upholstered mid-back task chair with plastic outer back, 2.5" back height adjustment, plastic base, swivel-tilt control	77W-MB-2-ST-HP-5-HC
Upholstered outer back	(insert U after MB in the pattern number)	U

Order Code

Example: **77W-MB-2-ST-HA-5-SL-HC K1000/8**

77W	EWC Pro task chair
MB	Mid-back
2	Black finish
ST	Swivel tilt control
HA	Height and width adjustable arms
5	Standard height cylinder
SL	Sliding seat
HC	Hard wheel black casters
K1000/8	Presto, Red Carpet

Ordering Information

Specify:

1. Pattern number
2. Seat and back upholstery

Finish color:
 Black

Options

Polished Aluminum Base:
 Replace 2 in pattern with 4. Only available with standard height cylinder.

Code: Upchg: Description:
 4 \$150 polished aluminum base

Options

Cylinder Height Option:
 For low height cylinder (plastic base only), replace 5 in pattern number with L. See Dimensions page for seat height range.

Code: Upchg: Description:
 L \$71 low cylinder

Sliding Seat Option:
 For sliding seat with 2.75" of depth adjustment insert SL after cylinder choice in pattern number. Adds 0.5" to seat height.

Code: Upchg: Description:
 SL \$39 sliding seat

Caster and Glide Options:
 Substitute HC in pattern with one of the following options:

Code:	Upchg:	Description:
SC	n/c	soft black casters for hard surfaces
GL	n/c	glides



list price Presto base grade	A	COM B	C	D	E	F	G	H	I	T	COL U	V	W	X	Y
\$517.	\$524.	\$542.	\$567.	\$593.	\$620.	\$650.	\$666.	\$673.	\$692.	\$957.	\$1,097.	\$1,229.	\$1,461.	n/a	\$1,676.
574.	580.	598.	622.	649.	677.	706.	722.	728.	748.	1,015.	1,152.	1,288.	1,519.	n/a	1,734.
574.	580.	598.	622.	649.	677.	706.	722.	728.	748.	1,015.	1,152.	1,288.	1,519.	n/a	1,734.
603.	610.	628.	651.	679.	705.	736.	751.	759.	778.	1,044.	1,183.	1,317.	1,549.	n/a	1,763.
617.	624.	642.	667.	693.	720.	750.	766.	773.	792.	1,057.	1,197.	1,329.	1,561.	n/a	1,776.
72.	74.	82.	91.	102.	112.	123.	131.	133.	141.	244.	298.	351.	442.	n/a	526.

Presto - Base Grade Fabric

<p><i>Color options:</i></p> <ul style="list-style-type: none"> Presto Winter White K1000/1 Presto Sand K1000/2 Presto Stone K1000/3 Presto Saffron K1000/4 Presto Spring Green K1000/5 Presto Blue Chip K1000/6 Presto Scarlet K1000/7 Presto Red Carpet K1000/8 Presto Beige Taupe K1000/9 Presto Olive K1000/10 Presto Navy Blue K1000/11 Presto Clear Gray K1000/12 Presto Charcoal Gray K1000/13 Presto Black Tie K1000/14 	<p><i>Split Upholstery:</i></p> <p>EWC Pro seats and backs can be upholstered in any two approved KnollTextiles or Spinneybeck upholsteries. To specify, first indicate the seat upholstery (labeled “seat upholstery”) and then indicate the back upholstery (labeled “back upholstery”). The list price of the chair equals the list price of the higher of the two upholstery grades.</p> <p>For split upholstery on the upholstered outer back option, indicate “inner back” and “outer back” on upholstery selections. Add the list price upcharge of the grade selected for the upholstered outer back.</p>	<p><i>CAL 133 Options:</i></p> <p><i>Code: Upchg: Description:</i></p> <p>C133 \$78 CAL 133 textile on seat and back. No additional upcharge for upholstered outer back (add C133 to the end of the pattern number)</p>	<p>COM/COL Upholstery Requirements</p> <p>Textile yardage required: 2 yards Leather sq. ft. required: 28 sq. ft. Outer back shell: .8 yards or 12 sq. ft.</p>
---	---	---	--

EWC Pro™

upholstered mid-back conference chair synchronized tilt control

	arm	description	pattern no.
<p><i>Designer(s):</i> Jeffrey Bernett and Nicholas Dodziuk, 2007</p> 	<p>Loop arms</p> 	<p>Upholstered mid-back conference chair with plastic outer back, fixed back height, plastic base, synchronized control</p>	77C-MB-2-SY-LA-5-HC
	<p>Upholstered outer back</p>	<p>(insert U after MB in the pattern number)</p>	U

Order Code

<i>Example:</i>	77C-MB-2-SY-LA-5-SL-HC K1000/8
77C	EWC Pro conference chair
MB	Mid-back
2	Black finish
SY	Synchronized tilt control
LA	Loop width adjustable arms
5	Standard height cylinder
SL	Sliding seat
HC	Hard wheel black casters
K1000/8	Presto, Red Carpet

Ordering Information

Specify:

1. Pattern number
2. Seat and back upholstery

Finish color:
Black

Options

Polished Aluminum Base:
Replace 2 in pattern with 4. Only available with standard height cylinder.

Code: Upchg: Description:
4 \$150 polished aluminum base

Options

Cylinder Height Option:
For low height cylinder (plastic base only), replace 5 in pattern number with L. See Dimensions page for seat height range.

Code: Upchg: Description:
L \$71 low cylinder

Sliding Seat Option:
For sliding seat with 2.75" of depth adjustment insert SL after cylinder choice in pattern number. Adds 0.5" to seat height.

Code: Upchg: Description:
SL \$39 sliding seat

Caster and Glide Options:
Substitute HC in pattern with one of the following options:

<i>Code:</i>	<i>Upchg:</i>	<i>Description:</i>
SC	n/c	soft black casters for hard surfaces
GL	n/c	glides

list price Presto base grade	A	COM B	C	D	E	F	G	H	I	T	COL U	V	W	X	Y
\$666.	\$673.	\$690.	\$713.	\$740.	\$767.	\$797.	\$812.	\$818.	\$837.	\$1,103.	\$1,238.	\$1,371.	\$1,600.	n/a	\$1,811.
72.	74.	82.	91.	102.	112.	123.	131.	133.	141.	244.	298.	351.	442.	n/a	526.

Presto - Base Grade Fabrics

<i>Color options:</i>	<i>Split Upholstery:</i>	<i>CAL 133 Options:</i>	COM/COL Upholstery Requirements
Presto Winter White K1000/1 Presto Sand K1000/2 Presto Stone K1000/3 Presto Saffron K1000/4 Presto Spring Green K1000/5 Presto Blue Chip K1000/6 Presto Scarlet K1000/7 Presto Red Carpet K1000/8 Presto Beige Taupe K1000/9 Presto Olive K1000/10 Presto Navy Blue K1000/11 Presto Clear Gray K1000/12 Presto Charcoal Gray K1000/13 Presto Black Tie K1000/14	EWC Pro seats and backs can be upholstered in any two approved KnollTextiles or Spinneybeck upholsteries. To specify, first indicate the seat upholstery (labeled "seat upholstery") and then indicate the back upholstery (labeled "back upholstery"). The list price of the chair equals the list price of the higher of the two upholstery grades. For split upholstery on the upholstered outer back option, indicate "inner back" and "outer back" on upholstery selections. Add the list price upcharge of the grade selected for the upholstered outer back.	Code: Upchg: Description: C133 \$78 CAL 133 textile on seat and back. No additional upcharge for upholstered outer back (add C133 to the end of the pattern number)	Textile yardage required: 2 yards Leather sq. ft. required: 28 sq. ft. Outer back shell: .8 yards or 12 sq. ft.

EWC Pro™
upholstered mid-back conference chair
swivel tilt control

Designer(s):
 Jeffrey Bernett and
 Nicholas Dodziuk, 2007



arm	description	pattern no.
Loop arms 	Upholstered mid-back conference chair with plastic outer back, fixed back height, plastic base, swivel-tilt control	77C-MB-2-ST-LA-5-HC
Upholstered outer back	(insert U after MB in the pattern number)	U

Order Code

<i>Example:</i>	77C-MB-2-ST-LA-5-SL-HC K1000/8
77C	EWC Pro conference chair
MB	Mid-back
2	Black finish
ST	Swivel tilt control
LA	Loop width adjustable arms
5	Standard height cylinder
SL	Sliding seat
HC	Hard wheel black casters
K1000/8	Presto Red Carpet

Ordering Information

Specify:

1. Pattern number
2. Seat and back upholstery

Finish color:
 Black

Options

Polished Aluminum Base:
 Replace 2 in pattern with 4. Only available with standard height cylinder.

Code: Upchg: Description:
 4 \$150 polished aluminum base

Options

Cylinder Height Option:
 For low height cylinder (plastic base only), replace 5 in pattern number with L. See Dimensions page for seat height range.

Code: Upchg: Description:
 L \$71 low cylinder

Sliding Seat Option:
 For sliding seat with 2.75" of depth adjustment insert SL after cylinder choice in pattern number. Adds 0.5" to seat height.

Code: Upchg: Description:
 SL \$39 sliding seat

Caster and Glide Options:
 Substitute HC in pattern with one of the following options:







Code: Upchg: Description:
 SC n/c soft black casters for hard surfaces
 GL n/c glides

list price															
Presto															
base															
grade	A	COM B	C	D	E	F	G	H	I	T	COL U	V	W	X	Y
\$569.	\$575.	\$593.	\$617.	\$643.	\$671.	\$701.	\$717.	\$723.	\$742.	\$1,010.	\$1,147.	\$1,282.	\$1,513.	n/a	\$1,729.
72.	74.	82.	91.	102.	112.	123.	131.	133.	141.	244.	298.	351.	442.	n/a	526.

Presto - Base Grade Fabrics

<i>Color options:</i>	<i>Split Upholstery:</i>	<i>CAL 133 Options:</i>	COM/COL Upholstery Requirements
Presto Winter White K1000/1	<p>EWC Pro seats and backs can be upholstered in any two approved KnollTextiles or Spinneybeck upholsteries. To specify, first indicate the seat upholstery (labeled "seat upholstery") and then indicate the back upholstery (labeled "back upholstery"). The list price of the chair equals the list price of the higher of the two upholstery grades.</p> <p>For split upholstery on the upholstered outer back option, indicate "inner back" and "outer back" on upholstery selections. Add the list price upcharge of the grade selected for the upholstered outer back.</p>	<p><i>Code: Upchg: Description:</i></p> <p>C133 \$78 CAL 133 textile on seat and back. No additional upcharge for upholstered outer back (add C133 to the end of the pattern number)</p>	<p>Textile yardage required: 2 yards Leather sq. ft. required: 28 sq. ft. Outer back shell: .8 yards or 12 sq. ft.</p>
Presto Sand K1000/2			
Presto Stone K1000/3			
Presto Saffron K1000/4			
Presto Spring Green K1000/5			
Presto Blue Chip K1000/6			
Presto Scarlet K1000/7			
Presto Red Carpet K1000/8			
Presto Beige Taupe K1000/9			
Presto Olive K1000/10			
Presto Navy Blue K1000/11			
Presto Clear Gray K1000/12			
Presto Charcoal Gray K1000/13			
Presto Black Tie K1000/14			

EWC Pro™
upholstered high-back task chair
synchronized tilt control

	arm	description	pattern no.
 <p><i>Designer(s):</i> Jeffrey Bernett and Nicholas Dodziuk, 2005</p>	Armless	Upholstered high-back task chair with plastic outer back, 2.5" back height adjustment, plastic base, synchronized control	77W-HB-2-SY-NA-5-HC
			
	Loop arms	Upholstered high-back task chair with plastic outer back, 2.5" back height adjustment, plastic base, synchronized control	77W-HB-2-SY-LA-5-HC
			
	Fixed arms	Upholstered high-back task chair with plastic outer back, 2.5" back height adjustment, plastic base, synchronized control	77W-HB-2-SY-FA-5-HC
			
Height/width adjustable arms	Upholstered high-back task chair with plastic outer back, 2.5" back height adjustment, plastic base, synchronized control	77W-HB-2-SY-HA-5-HC	
			
High performance arms	Upholstered high-back task chair with plastic outer back, 2.5" back height adjustment, plastic base, synchronized control	77W-HB-2-SY-HP-5-HC	
			
Upholstered outer back	(insert U after HB in the pattern number)	U	

Order Code

<i>Example:</i>	77W-HB-2-SY-HA-5-SL-HC K1000/8
77W	EWC Pro task chair
HB	High-back
2	Black finish
SY	Synchronized tilt control
HA	Height and width adjustable arms
5	Standard height cylinder
SL	Sliding seat
HC	Hard wheel black casters
K1000/8	Presto, Red Carpet

Ordering Information

Specify:
 1. Pattern number
 2. Seat and back upholstery

Finish color:
 Black

Options

Polished Aluminum Base:
 Replace 2 in pattern with 4. Only available with standard height cylinder.

Code:	Upchg:	Description:
4	\$150	polished aluminum base

Options

Cylinder Height Option:
 For low height cylinder (plastic base only), replace 5 in pattern number with L. See Dimensions page for seat height range.

Code:	Upchg:	Description:
L	\$71	low cylinder

Sliding Seat Option:
 For sliding seat with 2.75" of depth adjustment insert SL after cylinder choice in pattern number. Adds 0.5" to seat height.

Code:	Upchg:	Description:
SL	\$39	sliding seat

Caster and Glide Options:
 Substitute HC in pattern with one of the following options:

Code:	Upchg:	Description:
SC	n/c	soft black casters for hard surfaces
GL	n/c	glides

list price															
Presto base grade	A	COM B	C	D	E	F	G	H	I	T	COL U	V	W	X	Y
\$671.	\$681.	\$703.	\$729.	\$763.	\$793.	\$829.	\$847.	\$855.	\$878.	\$1,164.	\$1,317.	\$1,466.	\$1,722.	n/a	\$1,963.
726.	737.	756.	785.	817.	848.	886.	902.	910.	933.	1,221.	1,374.	1,523.	1,779.	n/a	2,020.
726.	737.	756.	785.	817.	848.	886.	902.	910.	933.	1,221.	1,374.	1,523.	1,779.	n/a	2,020.
754.	766.	786.	814.	846.	877.	914.	931.	938.	963.	1,249.	1,402.	1,551.	1,809.	n/a	2,049.
771.	781.	803.	829.	863.	893.	929.	947.	955.	978.	1,264.	1,417.	1,566.	1,822.	n/a	2,063.
72.	77.	84.	97.	110.	121.	138.	144.	147.	157.	271.	334.	396.	500.	n/a	598.

Presto - Base Grade Fabric*Color options:*

Presto Winter White K1000/1
Presto Sand K1000/2
Presto Stone K1000/3
Presto Saffron K1000/4
Presto Spring Green K1000/5
Presto Blue Chip K1000/6
Presto Scarlet K1000/7
Presto Red Carpet K1000/8
Presto Beige Taupe K1000/9
Presto Olive K1000/10
Presto Navy Blue K1000/11
Presto Clear Gray K1000/12
Presto Charcoal Gray K1000/13
Presto Black Tie K1000/14

Split Upholstery:

EWC Pro seats and backs can be upholstered in any two approved KnollTextiles or Spinneybeck upholsteries. To specify, first indicate the seat upholstery (labeled "seat upholstery") and then indicate the back upholstery (labeled "back upholstery"). The list price of the chair equals the list price of the higher of the two upholstery grades.

For split upholstery on the upholstered outer back option, indicate "inner back" and "outer back" on upholstery selections. Add the list price upcharge of the grade selected for the upholstered outer back.







CAL 133 Options:

Code: Upchg: Description:
C133 \$78 CAL 133 textile on seat and back. No additional upcharge for upholstered outer back (add C133 to the end of the pattern number)

COM/COL Upholstery Requirements

Textile yardage required: 2.2 yards
Leather sq. ft. required: 31 sq. ft.
Outer back shell: .9 yards or 13.5 sq. ft.

EWC Pro™
upholstered high-back task chair
swivel tilt control

	arm	description	pattern no.
 <p><i>Designer(s):</i> Jeffrey Bernett and Nicholas Dodziuk, 2005</p>	Armless	Upholstered high-back task chair with plastic outer back, 2.5" back height adjustment, plastic base, swivel-tilt control	77W-HB-2-ST-NA-5-HC
			
	Loop arms	Upholstered high-back task chair with plastic outer back, 2.5" back height adjustment, plastic base, swivel-tilt control	77W-HB-2-ST-LA-5-HC
			
	Fixed arms	Upholstered high-back task chair with plastic outer back, 2.5" back height adjustment, plastic base, swivel-tilt control	77W-HB-2-ST-FA-5-HC
			
Height/width adjustable arms	Upholstered high-back task chair with plastic outer back, 2.5" back height adjustment, plastic base, swivel-tilt control	77W-HB-2-ST-HA-5-HC	
			
High performance arms	Upholstered high-back task chair with plastic outer back, 2.5" back height adjustment, plastic base, swivel-tilt control	77W-HB-2-ST-HP-5-HC	
			
Upholstered outer back	(insert U after HB in the pattern number)	U	

Order Code

Example: **77W-HB-2-ST-HA-5-SL-HC VOBLK**

77W	EWC Pro task chair
HB	High-back
2	Black finish
ST	Swivel tilt control
HA	Height and width adjustable arms
5	Standard height cylinder
SL	Sliding seat
HC	Hard wheel black casters
VOBLK	Volo black Spinneybeck leather

Ordering Information

Specify:

1. Pattern number
2. Seat and back upholstery

Finish color:
 Black

Options

Polished Aluminum Base:
 Replace 2 in pattern with 4. Only available with standard height cylinder.

Code: Upchg: Description:
 4 \$150 polished aluminum base

Options

Cylinder Height Option:
 For low height cylinder (plastic base only), replace 5 in pattern number with L. See Dimensions page for seat height range.

Code: Upchg: Description:
 L \$71 low cylinder

Sliding Seat Option:
 For sliding seat with 2.75" of depth adjustment insert SL after cylinder choice in pattern number. Adds 0.5" to seat height.

Code: Upchg: Description:
 SL \$39 sliding seat

Caster and Glide Options:
 Substitute HC in pattern with one of the following options:

<i>Code:</i>	<i>Upchg:</i>	<i>Description:</i>
SC	n/c	soft black casters for hard surfaces
GL	n/c	glides

list price															
Presto base grade	A	COM B	C	D	E	F	G	H	I	T	COL U	V	W	X	Y
\$574.	\$585.	\$606.	\$633.	\$666.	\$698.	\$735.	\$753.	\$761.	\$785.	\$1,073.	\$1,227.	\$1,378.	\$1,638.	n/a	\$1,883.
630.	640.	662.	690.	722.	754.	791.	809.	817.	840.	1,130.	1,286.	1,436.	1,697.	n/a	1,941.
630.	640.	662.	690.	722.	754.	791.	809.	817.	840.	1,130.	1,286.	1,436.	1,697.	n/a	1,941.
660.	670.	691.	719.	751.	784.	821.	838.	846.	870.	1,158.	1,315.	1,465.	1,725.	n/a	1,970.
674.	685.	706.	733.	766.	798.	835.	853.	861.	885.	1,173.	1,327.	1,478.	1,738.	n/a	1,983.
72.	77.	84.	97.	110.	121.	138.	144.	147.	157.	271.	334.	396.	500.	n/a	598.

Presto - Base Grade Fabric*Color options:*

Presto Winter White K1000/1
Presto Sand K1000/2
Presto Stone K1000/3
Presto Saffron K1000/4
Presto Spring Green K1000/5
Presto Blue Chip K1000/6
Presto Scarlet K1000/7
Presto Red Carpet K1000/8
Presto Beige Taupe K1000/9
Presto Olive K1000/10
Presto Navy Blue K1000/11
Presto Clear Gray K1000/12
Presto Charcoal Gray K1000/13
Presto Black Tie K1000/14

Split Upholstery:

EWC Pro seats and backs can be upholstered in any two approved KnollTextiles or Spinneybeck upholsteries. To specify, first indicate the seat upholstery (labeled "seat upholstery") and then indicate the back upholstery (labeled "back upholstery"). The list price of the chair equals the list price of the higher of the two upholstery grades.

For split upholstery on the upholstered outer back option, indicate "inner back" and "outer back" on upholstery selections. Add the list price upcharge of the grade selected for the upholstered outer back.

CAL 133 Options:

Code: Upchg: Description:
C133 \$78 CAL 133 textile on seat and back. No additional upcharge for upholstered outer back (add C133 to the end of the pattern number)

COM/COL Upholstery Requirements

Textile yardage required: 2.2 yards
Leather sq. ft. required: 31 sq. ft.
Outer back shell: .9 yards or 13.5 sq. ft.

EWC Pro™
upholstered high-back conference chair
synchronized tilt control

Designer(s):
 Jeffrey Bernett and
 Nicholas Dodziuk, 2007



arm	description	pattern no.
Loop arms 	Upholstered high-back conference chair with plastic outer back, fixed back height, plastic base, synchronized control	77C-HB-2-SY-LA-5-HC
Upholstered outer back	(insert U after HB in the pattern number)	U

Order Code	Ordering Information	Options
<i>Example:</i> 77C-HB-2-SY-LA-5-SL-HC K1000/8	<i>Specify:</i> 1. Pattern number 2. Seat and back upholstery	<i>Cylinder Height Option:</i> For low height cylinder (plastic base only), replace 5 in pattern number with L. See Dimensions page for seat height range.
77C EWC Pro conference chair	<i>Finish color:</i> Black	<i>Caster and Glide Options:</i> Substitute HC in pattern with one of the following options:
HB High-back		<i>Code: Upchg: Description:</i> SC n/c soft black casters for hard surfaces
2 Black finish		GL n/c glides
SY Synchronized tilt control		
LA Loop width adjustable arms		
5 Standard height cylinder	Options	<i>Sliding Seat Option:</i> For sliding seat with 2.75" of depth adjustment insert SL after cylinder choice in pattern number. Adds 0.5" to seat height.
SL Sliding seat	<i>Polished Aluminum Base:</i> Replace 2 in pattern with 4. Only available with standard height cylinder.	<i>Code: Upchg: Description:</i> SL \$39 sliding seat
HC Hard wheel black casters	<i>Code: Upchg: Description:</i> 4 \$150 polished aluminum base	
K1000/8 Presto, Red Carpet		

list price															
Presto base grade	A	COM B	C	D	E	F	G	H	I	T	COL U	V	W	X	Y
\$721.	\$730.	\$751.	\$780.	\$812.	\$842.	\$880.	\$897.	\$905.	\$928.	\$1,215.	\$1,369.	\$1,517.	\$1,773.	n/a	\$2,013.
72.	77.	84.	97.	110.	121.	138.	144.	147.	157.	271.	334.	396.	500.	n/a	598.

Presto - Base Grade Fabric

Color options:

- Presto Winter White K1000/1
- Presto Sand K1000/2
- Presto Stone K1000/3
- Presto Saffron K1000/4
- Presto Spring Green K1000/5
- Presto Blue Chip K1000/6
- Presto Scarlet K1000/7
- Presto Red Carpet K1000/8
- Presto Beige Taupe K1000/9
- Presto Olive K1000/10
- Presto Navy Blue K1000/11
- Presto Clear Gray K1000/12
- Presto Charcoal Gray K1000/13
- Presto Black Tie K1000/14

Split Upholstery:

EWC Pro seats and backs can be upholstered in any two approved KnollTextiles or Spinneybeck upholsteries. To specify, first indicate the seat upholstery (labeled “seat upholstery”) and then indicate the back upholstery (labeled “back upholstery”). The list price of the chair equals the list price of the higher of the two upholstery grades.

For split upholstery on the upholstered outer back option, indicate “inner back” and “outer back” on upholstery selections. Add the list price upcharge of the grade selected for the upholstered outer back.

CAL 133 Options:

Code: Upchg: Description:
 C133 \$78 CAL 133 textile on seat and back. No additional upcharge for upholstered outer back (add C133 to the end of the pattern number)

COM/COL Upholstery Requirements

Textile yardage required: 2.2 yards
 Leather sq. ft. required: 31 sq. ft.
 Outer back shell: .9 yards or 13.5 sq. ft.

EWC Pro™
upholstered high-back conference chair
swivel tilt control

Designer(s):
 Jeffrey Bernett and
 Nicholas Dodziuk, 2007



arm	description	pattern no.
Loop arms 	Upholstered high-back conference chair with plastic outer back, fixed back height, plastic base, swivel-tilt control	77C-HB-2-ST-LA-5-HC
Upholstered outer back	(insert U after HB in the pattern number)	U

Order Code

<i>Example:</i>	77C-HB-2-ST-LA-5-SL-HC VOBLK
77C	EWC Pro conference chair
HB	High-back
2	Black finish
ST	Swivel tilt control
LA	Loop width adjustable arms
5	Standard height cylinder
SL	Sliding seat
HC	Hard wheel black casters
VOBLK	Volo black Spinneybeck leather

Ordering Information

Specify:

1. Pattern number
2. Seat and back upholstery

Finish color:
 Black

Options

Polished Aluminum Base:
 Replace 2 in pattern with 4. Only available with standard height cylinder.

Code: Upchg: Description:
 4 \$150 polished aluminum base

Options

Cylinder Height Option:
 For low height cylinder (plastic base only), replace 5 in pattern number with L. See Dimensions page for seat height range.

Code: Upchg: Description:
 L \$71 low cylinder

Sliding Seat Option:
 For sliding seat with 2.75" of depth adjustment insert SL after cylinder choice in pattern number. Adds 0.5" to seat height.

Code: Upchg: Description:
 SL \$39 sliding seat

Caster and Glide Options:
 Substitute HC in pattern with one of the following options:

Code:	Upchg:	Description:
SC	n/c	soft black casters for hard surfaces
GL	n/c	glides



list price															
Presto															
base															
grade	A	COM B	C	D	E	F	G	H	I	T	COL U	V	W	X	Y
\$624.	\$634.	\$657.	\$684.	\$717.	\$748.	\$786.	\$804.	\$811.	\$834.	\$1,124.	\$1,280.	\$1,430.	\$1,692.	n/a	\$1,934.
72.	77.	84.	97.	110.	121.	138.	144.	147.	157.	271.	334.	396.	500.	n/a	598.

Presto - Base Grade Fabric

<i>Color options:</i>	<i>Split Upholstery:</i>	<i>CAL 133 Options:</i>	COM/COL Upholstery Requirements
Presto Winter White K1000/1	EWC Pro seats and backs can be upholstered in any two approved KnollTextiles or Spinneybeck upholsteries. To specify, first indicate the seat upholstery (labeled "seat upholstery") and then indicate the back upholstery (labeled "back upholstery"). The list price of the chair equals the list price of the higher of the two upholstery grades.	<i>Code: Upchg: Description:</i> C133 \$78 CAL 133 textile on seat and back. No additional upcharge for upholstered outer back (add C133 to the end of the pattern number)	Textile yardage required: 2.2 yards Leather sq. ft. required: 31 sq. ft. Outer back shell: .9 yards or 13.5 sq. ft.
Presto Sand K1000/2			
Presto Stone K1000/3			
Presto Saffron K1000/4			
Presto Spring Green K1000/5			
Presto Blue Chip K1000/6			
Presto Scarlet K1000/7			
Presto Red Carpet K1000/8			
Presto Beige Taupe K1000/9			
Presto Olive K1000/10			
Presto Navy Blue K1000/11	For split upholstery on the upholstered outer back option, indicate "inner back" and "outer back" on upholstery selections. Add the list price upcharge of the grade selected for the upholstered outer back.		
Presto Clear Gray K1000/12			
Presto Charcoal Gray K1000/13			
Presto Black Tie K1000/14			

EWC Pro™

upholstered side chair

	arm	description	pattern no.
<p><i>Designer(s):</i> Jeffrey Bennett and Nicholas Dodziuk, 2005</p> 	Fixed arms	Upholstered side chair with plastic outer back	77S-2-FA-HC
			
	Armless	Upholstered side chair with plastic outer back	77S-2-NA-HC
			
	Upholstered outer back	(insert U after S in the pattern number)	U

Order Code

<i>Example:</i>	77S-2-FA-HC K1000/10
77S	EWC Pro side chair
2	Black finish
FA	Fixed arms
HC	Hard wheel black casters
K1000/10	Presto Olive

Ordering Information

Specify:

1. Pattern number
2. Seat and back upholstery

Finish color:
Black

Options

Caster and Glide Options:
Substitute HC in pattern with one of the following options:

<i>Code:</i>	<i>Upchg:</i>	<i>Description:</i>
SC	n/c	soft black casters for hard surfaces
GL	n/c	glides

list price															
Presto base grade	A	COM B	C	D	E	F	G	H	I	T	COL U	V	W	X	Y
\$384.	\$388.	\$404.	\$425.	\$448.	\$473.	\$500.	\$513.	\$520.	\$536.	\$803.	\$933.	\$1,062.	\$1,281.	n/a	\$1,485.
356.	361.	377.	399.	423.	447.	476.	489.	496.	514.	788.	924.	1,056.	1,284.	n/a	1,493.
49.	51.	59.	65.	72.	80.	88.	93.	97.	102.	188.	230.	273.	344.	n/a	412.

Presto - Base Grade Fabric

Color options:

- Presto Winter White K1000/1
- Presto Sand K1000/2
- Presto Stone K1000/3
- Presto Saffron K1000/4
- Presto Spring Green K1000/5
- Presto Blue Chip K1000/6
- Presto Scarlet K1000/7
- Presto Red Carpet K1000/8
- Presto Beige Taupe K1000/9
- Presto Olive K1000/10
- Presto Navy Blue K1000/11
- Presto Clear Gray K1000/12
- Presto Charcoal Gray K1000/13
- Presto Black Tie K1000/14

Split Upholstery:

EWC Pro seats and backs can be upholstered in any two approved KnollTextiles or Spinneybeck upholsteries. To specify, first indicate the seat upholstery (labeled “seat upholstery”) and then indicate the back upholstery (labeled “back upholstery”). The list price of the chair equals the list price of the higher of the two upholstery grades.

For split upholstery on the upholstered outer back option, indicate “inner back” and “outer back” on upholstery selections. Add the list price upcharge of the grade selected for the upholstered outer back.

CAL 133 Options:

<i>Code:</i>	<i>Upchg:</i>	<i>Description:</i>
C133	\$56	CAL 133 textile on seat and back. No additional upcharge for upholstered outer back (add C133 to the end of the pattern number)

COM/COL Upholstery Requirements

Textile yardage required: 1.8 yards
 Leather sq. ft. required: 25 sq. ft.
 Outer back shell: .6 yards or 9 sq. ft.

EWC Pro™

seat and back replacements for task, conference and side chairs

	description	pattern no.
<p><i>Designer(s):</i> Jeffrey Bernett and Nicholas Dodziuk, 2007</p> 	Replacement upholstered seat for EWC Pro and EWC Tech task and conference chairs	ESSENWORKSEAT
	Replacement upholstered EWC Pro Task Midback with plastic outer back and 2.5" back height adjustment	77WMIDBACK
	Upholstered outer back option for 77WMIDBACK	U (insert U after 77W- in the pattern number)*
	Replacement upholstered EWC Pro Conference Midback with plastic outer back and fixed back height	77CMIDBACK
	Upholstered outer back option for 77CMIDBACK	U (insert U after 77C- in the pattern number)*
	Replacement upholstered EWC Pro Task Highback with plastic outer back and 2.5" back height adjustment	77WHIGHBACK
	Upholstered outer back option for 77WHIGHBACK	U (insert U after 77W- in the pattern number)*
	Replacement upholstered EWC Pro Conference Highback with plastic outer back and fixed back height	77CHIGHBACK
	Upholstered outer back option for 77CHIGHBACK	U (insert U after 77C- in the pattern number)*
	Replacement upholstered seat for EWC Pro and EWC Tech side chairs	ESSENSIDESEAT
Replacement upholstered EWC Pro Side back with plastic outer back	77SBACK	
Upholstered outer back option for 77SBACK	U (insert U after 77S- in the pattern number)*	

Order Code	Ordering Information	Presto - Base Grade Fabric	Options
<i>Example:</i> ESSENWORKSEAT - K1000/8	<i>Specify:</i>	<i>Color options:</i>	<i>CAL 133 Options:</i>
ESSENWORKSEAT Upholstered seat replacement	1. Pattern number	Presto Winter White K1000/1	<i>Code: Upchg: Description:</i>
K1000/8 Presto, Red Carpet	2. Textile	Presto Sand K1000/2	C133 \$50 CAL 133 textile on seat. (add C133 to the end of the pattern number)
	COM/COL Upholstery Requirements	Presto Stone K1000/3	
	See yardage requirements on respective price list pages.	Presto Saffron K1000/4	
		Presto Spring Green K1000/5	<i>Code: Upchg: Description:</i>
		Presto Blue Chip K1000/6	C133 \$50 CAL 133 textile on back. No additional upcharge for upholstered outer back (add C133 to the end of the pattern number)
		Presto Scarlet K1000/7	
		Presto Red Carpet K1000/8	
		Presto Beige Taupe K1000/9	
		Presto Olive K1000/10	
		Presto Navy Blue K1000/11	
		Presto Clear Gray K1000/12	
		Presto Charcoal Gray K1000/13	
		Presto Black Tie K1000/14	

list price Presto base grade	A	COM B	C	D	E	F	G	H	I	T	COL U	V	W	X	Y
\$107.	\$128.	\$142.	\$159.	\$180.	\$200.	\$222.	\$235.	\$239.	\$256.	\$286.	\$338.	\$392.	\$485.	n/a	\$571.
258.	290.	309.	334.	365.	395.	429.	445.	455.	476.	576.	674.	768.	931.	n/a	1,083.
72.	74.	82.	91.	102.	112.	123.	131.	133.	141.	244.	298.	351.	442.	n/a	526.
258.	290.	309.	334.	365.	395.	429.	445.	455.	476.	576.	674.	768.	931.	n/a	1,083.
72.	74.	82.	91.	102.	112.	123.	131.	133.	141.	244.	298.	351.	442.	n/a	526.
272.	309.	332.	363.	397.	431.	471.	490.	501.	526.	645.	758.	870.	1,062.	n/a	1,242.
72.	77.	84.	97.	110.	121.	138.	144.	147.	157.	271.	334.	396.	500.	n/a	598.
272.	309.	332.	363.	397.	431.	471.	490.	501.	526.	645.	758.	870.	1,062.	n/a	1,242.
72.	77.	84.	97.	110.	121.	138.	144.	147.	157.	271.	334.	396.	500.	n/a	598.
110.	135.	148.	166.	186.	205.	227.	238.	245.	259.	289.	341.	394.	485.	n/a	568.
158.	190.	208.	228.	254.	278.	305.	320.	326.	343.	427.	507.	586.	721.	n/a	846.
49.	51.	59.	65.	72.	80.	88.	93.	97.	102.	188.	230.	273.	344.	n/a	412.

Split Upholstery:

For split upholstery on the upholstered outer back option, indicate “inner back” and “outer back” on upholstery selections. Add the list price upcharge of the grade selected for the upholstered outer back.

EWC Pro™ Task Dimensions and Operating Instructions

Seat*	BIFMA G1-2002 Ergonomic Guidelines	EWC Pro Mid-back Task Ergonomic Dimensions	EWC Pro High-back Task Ergonomic Dimensions	EWC Pro Side
Seat Height**	15" - 19.9" minimum range (one or combination of chairs)	16.25" - 20.75" (std. cylinder) 15.5" - 19.6" (alum. base, std. cylinder) 15" - 19" (low cylinder)	16.25" - 20.75" (std. cylinder) 15.5" - 19.6" (alum. base, std. cylinder) 15" - 19" (low cylinder)	17"
		**sliding seat option adds 0.5" to all seat height dimensions	**sliding seat option adds 0.5" to all seat height dimensions	
Seat Depth	16.9" or less fixed, include if adjustable	16.9" (fixed) 16.25" - 19" (adjustable)	16.9" (fixed) 16.25" - 19" (adjustable)	16.9"
Seat Width	18" min	19"	19"	19"
Seat Pan Angle (at rest)	0° - 4° rearward	2°	2°	2°
Back*				
Backrest Height	12.2" min	22" - 24.5"	24.5" - 27"	17.5"
Backrest Width	14.2" min	18"	19"	18.5"
Lumbar Support	5.9" - 9.8" (adjustable include part of range)	5.75" - 8.75"	5.75" - 8.75"	6.75"
Angle Between Seat and Back	90°-115°	96°	96°	103°
Tilt Range of Back	10° min	24° (synchro) 14° (swivel)	24° (synchro) 14° (swivel)	N/A
Arms*				
Armrest Height (fixed)	7.9" - 9.8"	8.2" (fixed); 8" (loop)	8.2" (fixed); 8" (loop)	9.4"
Armrest Height (adjustable)	6.9" - 10.8"	7" - 10.5" (height adj.) 7.875" - 11" (high perf.)	7" - 10.5" (height adj.) 7.875" - 11" (high perf.)	N/A N/A
Inside Distance Between Armrests (fixed)	18" min	19.5" - 21.5" (fixed) 19.7" - 21.9" (loop)	19.5" - 21.5" (fixed) 19.7" - 21.9" (loop)	19.5"
Inside Distance Between Armrests (adjustable)	include 18"	19.5" - 21.5" (height adj.) 18.5" - 20.625" (high perf.)	19.5" - 21.5" (height adj.) 18.5" - 20.625" (high perf.)	N/A
*All measurements taken with BIFMA Chair Measuring Device using the Universal Measurement Procedure which as a measurement uncertainty of ±5%				
Chair Measurements***				
A Overall Height		36.75" - 43.75" (plastic base) 36" - 42.6" (alum. base)	39.25" - 46.75" (plastic base) 38.5" - 45.1" (alum. base)	32"
B Overall Width		27"	27"	21.75" (armless) 24.3" (with arms)
C Overall Depth		27" (plastic base) 26.75" (alum. base)	27" (plastic base) 26.75" (alum. base)	24"
D Fixed Arm Height from Floor		24.2" - 28.7"	24.2" - 28.7"	25.8"
Loop Arm Height from Floor		24" - 28.5"	24" - 28.5"	N/A
Height Adj. Arm Height from Floor		23" - 31.5"	23" - 31.5"	N/A
High Perf. Arm Height from Floor		22.875" - 30.5"	22.875" - 30.5"	N/A
E Recline Range		96° - 120° (synchro) 96° - 110° (swivel)	96° - 120° (synchro) 96° - 110° (swivel)	N/A N/A
Back Recline Ratio		1:3 (synchro); 1:1 (swivel)	1:3 (synchro); 1:1 (swivel)	N/A
F Base Diameter		27" (plastic); 26.75" (alum.)	27" (plastic); 26.75" (alum.)	N/A
G Weight		41.3 lbs. (plastic base) 43.3 lbs. (alum. base)	43.3 lbs. (plastic base) 45.3 lbs. (alum. base)	20.2 lbs. (armless) 23.5 lbs. (with arms)

***standard cylinder; sliding seat option adds 0.5" to overall height and arm height from floor

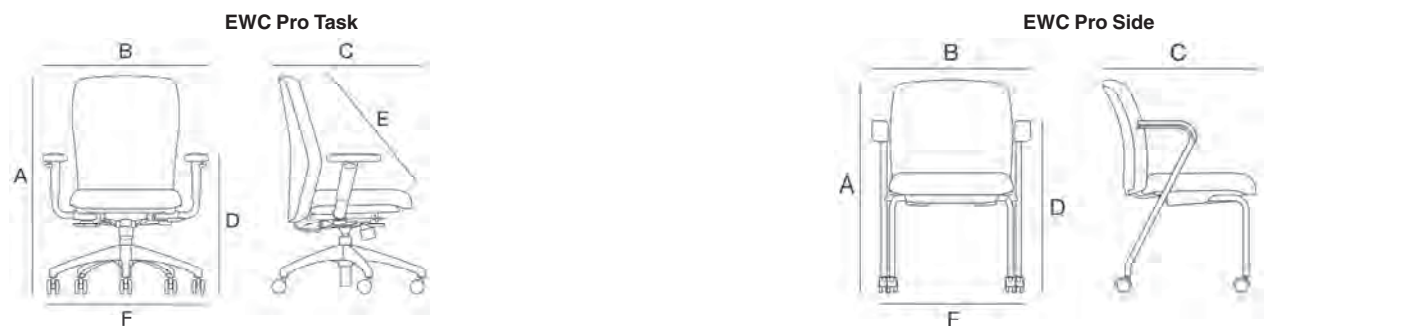

Compliance: ANSI/BIFMA X5.1 : 2002 (U.S. structural standard), BIFMA G1 : 2002 (U.S. ergonomic guidelines), California T.B. 117 (U.S. flammability standard for foam), California T.B. 133 with approved FR textile (U.S. flammability standard for full chair), CAN/CGSB 44.232-2002 (except conference chairs)

The EWC Pro chair line has been tested and is approved for use by individuals weighing up to 300 pounds.

EWC Pro High-back and Mid-back Task Chair Operating Instructions

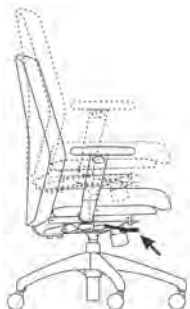

Seat Height

To raise the seat height, remove your weight from the chair while lifting the lever under the right side of the seat. To lower the seat height, lift the lever while sitting in the chair.



Adjustable Arm Width (All arm options)

To adjust the arm width, loosen the knob under the arm support by turning clockwise. Slide the arm support toward or away from the seat to adjust the arm width. Tighten the knob under the arm to secure.



Tilt Lock

To recline, pull out the lever under the right side of the seat. To lock the chair upright, push the lever in.



Height Adjustable Arm (Optional)

To adjust the arm pad height, lift the lever on the outside of the arm support and move the arm up or down. Release the lever to lock.



Tilt Tension

To adjust the tilt tension, turn the knob under the front of the seat. Turn counterclockwise to tighten, and clockwise to loosen.

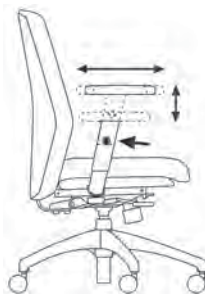

High Performance Arm (Optional)

To adjust the arm pad height, push the button on the outside of the arm support and move the arm up or down. Release the button to lock. To adjust arm pad depth, grasp arm pad and push forward or pull backward. The arm pad adjusts 2.5" in depth.



Back Height (Task chairs only)

To raise the back height, firmly hold both sides of the back and lift. The back height adjusts 9 notches upward. To lower the back height, first raise the back to the highest position; the top notch releases the back to the lowest position.

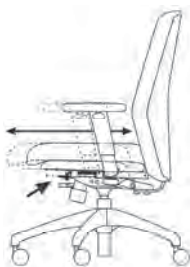

Sliding Seat Depth Adjustment (Optional)

To adjust the seat depth, lift the lever under the left side of the seat and slide the seat to the desired location. Release the lever to lock in one of the 6 positions



EWC Pro Side Chair

This is a stacking side chair.

Chairs should not be stacked more than 3 units high. To stack chairs, place the rear legs of the top chair in front of the rear legs of the bottom chair. The bottom of the top chair's seat should rest on the lower chair's seat.

EWC Pro™ Conference Dimensions and Operating Instructions

Seat*	BIFMA G1-2002 Ergonomic Guidelines	EWC Pro Mid-back Conference Ergonomic Dimensions	EWC Pro High-back Conference Ergonomic Dimensions
Seat Height**	15" - 19.9" min range (one or combination of chairs)	16.25" - 20.75" (std. cylinder) 15.5" - 19.6" (alum. base, std. cylinder) 15" - 19" (low cylinder) **sliding seat option adds 0.5" to all seat height dimensions	16.25" - 20.75" (std. cylinder) 15.5" - 19.6" (alum. base, std. cylinder) 15" - 19" (low cylinder) **sliding seat option adds 0.5" to all seat height dimensions
Seat Depth	16.9" (or less fixed, include if adjustable)	16.9" (fixed) 16.25" - 19" (adjustable)	16.9" (fixed) 16.25" - 19" (adjustable)
Seat Width	18" min	19"	19"
Seat Pan Angle (at rest)	0° - 4° rearward	2°	2°
Back*			
Backrest Height	12.2" min	22.75"	24.75"
Backrest Width	14.2" min	18"	19"
Lumbar Support	5.9" - 9.8"	7.25"	7.25"
Angle Between Seat and Back	90° - 115°	92.5°	92.5°
Tilt Range of Back	10° min	24° (synchro) 14° (swivel)	24° (synchro) 14° (swivel)
Arms*			
Armrest Height (fixed)	7.9" - 9.8"	8" (loop)	8" (loop)
Inside Distance Between Armrest (fixed)	18" min	19.7" - 21.9" (loop)	19.7" - 21.9" (loop)
*All measurements taken with BIFMA Chair Measuring Device using the Universal Measurement Procedure which has a measurement uncertainty of ±5%			
Chair Measurements***			
A Overall Height		36.75" - 41.25" (plastic base) 36" - 40.1" (alum. base)	39.25" - 46.75" (plastic base) 36" - 40.1" (alum. base)
B Overall Width		27"	27"
C Overall Depth		27"	27"
D Loop Arm Height from Floor		24" - 28.5"	24" - 28.5"
E Recline Range		92.5° - 116.5° (synchro) 92.5° - 106.5° (swivel)	92.5° - 116.5° (synchro) 92.5° - 106.5° (swivel)
Back Recline Ratio		1:3 (synchro); 1:1 (swivel)	1:3 (synchro); 1:1 (swivel)
F Base Diameter		27" (plastic); 26.75" (alum.)	27" (plastic); 26.75" (alum.)
G Weight		41.3 lbs. (plastic base) 43.3 lbs. (alum. base)	43.3 lbs. (plastic base) 45.3 lbs. (alum. base)

***standard cylinder; sliding seat adds 0.5" to overall height and arm height from floor

EWC Pro Conference

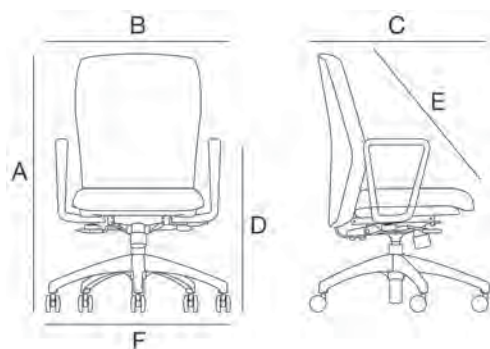

Compliance: ANSI/BIFMA X5.1 : 2002 (U.S. structural standard), BIFMA G1 : 2002 (U.S. ergonomic guidelines), California T.B. 117 (U.S. flammability standard for foam), California T.B. 133 with approved FR textile (U.S. flammability standard for full chair)

The EWC Pro chair line has been tested and is approved for use by individuals weighing up to 300 pounds.

EWC Pro High-back and Mid-back Conference Chair Operating Instructions



Seat Height

To raise the seat height, remove your weight from the chair while lifting the lever under the right side of the seat. To lower the seat height, lift the lever while sitting in the chair.



Adjustable Arm Width

To adjust the arm width, loosen the knob under the arm support by turning clockwise. Slide the arm support toward or away from the seat to adjust the arm width. Tighten the knob under the arm to secure.



Tilt Lock

To recline, pull out the lever under the right side of the seat. To lock the chair upright, push the lever in.

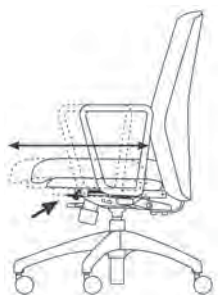

Sliding Seat Depth Adjustment (Optional)

To adjust the seat depth, lift the lever under the left side of the seat and slide the seat to the desired location. Release the lever to lock in one of the 6 positions.



Tilt Tension

To adjust the tilt tension, turn the knob under the front of the seat. Turn counterclockwise to tighten, and clockwise to loosen.

EWC Tech™
suspension back task chair
synchronized tilt control

	arm	description	pattern no.
<p><i>Designer(s):</i> Jeffrey Bernett and Nicholas Dodziuk, 2005</p> 	Armless	Suspension mid-back task chair, plastic base, synchronized control	88W-MB-2-SY-NA-5-HC
			
	Loop arms	Suspension mid-back task chair, plastic base, synchronized control	88W-MB-2-SY-LA-5-HC
			
	Fixed arms	Suspension mid-back task chair, plastic base, synchronized control	88W-MB-2-SY-FA-5-HC
			
Height/width adjustable arms	Suspension mid-back task chair, plastic base, synchronized control	88W-MB-2-SY-HA-5-HC	
			
High performance arms	Suspension mid-back task chair, plastic base, synchronized control	88W-MB-2-SY-HP-5-HC	
			

Order Code	Ordering Information	Options
<i>Example:</i> 88W-MB-2-SY-HA 5-SL-HC Seat: K1000/8 - Back: S08	<i>Specify:</i> 1. Pattern number 2. Seat and back upholstery 3. Suspension back color	<i>Cylinder Height Option:</i> For low height cylinder (plastic base only), replace 5 in pattern number with L. See Dimensions page for seat height range.
88W EWC Tech suspension back task chair	<i>Finish color:</i> Black	<i>Code: Upchg: Description:</i> L \$71 low cylinder
MB Mid-back	Options	<i>Caster and Glide Options:</i> Substitute HC in pattern with one of the following options: <i>Code: Upchg: Description:</i> SC n/c soft black casters for hard surfaces GL n/c glides
2 Black finish	<i>Polished Aluminum Base:</i> Replace 2 in pattern with 4. Only available with standard height cylinder.	<i>Sliding Seat Option:</i> For sliding seat with 2.75" of depth adjustment insert SL after cylinder choice in pattern number. Adds 0.5" to seat height.
SY Synchronized tilt control	<i>Code: Upchg: Description:</i> 4 \$150 polished aluminum base	<i>Code: Upchg: Description:</i> SL \$39 sliding seat
HA Height and width adjustable arms		
5 Standard height cylinder		
SL Sliding seat		
HC Hard wheel black caster		
SEAT K1000/8 Presto, Red Carpet		
BACK S08 Red Carpet		

list price															
Presto															
base															
grade	A	COM B	C	D	E	F	G	H	I	T	COL U	V	W	X	Y
\$677.	\$689.	\$701.	\$716.	\$735.	\$752.	\$775.	\$784.	\$788.	\$802.	\$837.	\$888.	\$935.	\$1,018.	n/a	\$1,098.
732.	744.	755.	773.	790.	809.	829.	839.	844.	857.	895.	943.	991.	1,076.	n/a	1,154.
732.	744.	755.	773.	790.	809.	829.	839.	844.	857.	895.	943.	991.	1,076.	n/a	1,154.
761.	774.	785.	801.	819.	837.	859.	868.	873.	887.	923.	974.	1,020.	1,104.	n/a	1,184.
777.	789.	801.	816.	835.	852.	875.	884.	888.	902.	937.	988.	1,035.	1,118.	n/a	1,198.

Presto - Base Grade Fabric**FOR SEAT ONLY***Color options:*

Presto Winter White K1000/1
Presto Sand K1000/2
Presto Stone K1000/3
Presto Saffron K1000/4
Presto Spring Green K1000/5
Presto Blue Chip K1000/6
Presto Scarlet K1000/7
Presto Red Carpet K1000/8
Presto Beige Taupe K1000/9
Presto Olive K1000/10
Presto Navy Blue K1000/11
Presto Clear Gray K1000/12
Presto Charcoal Gray K1000/13
Presto Black Tie K1000/14

Suspension Back-Standard**FOR BACK ONLY***Color options:*

Red Carpet S08
Beige Taupe S09
Olive S10
Navy Blue S11
Clear Gray S12
Charcoal Gray S13
Black Tie S14

EWC Tech Suspension Back is cleaning code W-S. It is rated Heavy Duty for abrasion (exceeds 30,000 double rubs with Wyzenbeek method).

COM/COL Upholstery Requirements

Textile yardage required: .8 yards
Leather sq. ft. required: 10 sq. ft.

*CAL 133 Options:**Code: Upchg: Description:*

C133 \$50 CAL 133 textile on seat only. (add C133 to the end of the pattern number)

EWC Tech™
suspension back task chair
swivel tilt control

	arm	description	pattern no.
<p><i>Designer(s):</i> Jeffrey Bernett and Nicholas Dodziuk, 2005</p> 	Armless	Suspension mid-back task chair, plastic base, swivel-tilt control	88W-MB-2-ST-NA-5-HC
	Loop arms	Suspension mid-back task chair, plastic base, swivel-tilt control	88W-MB-2-ST-LA-5-HC
	Fixed arms	Suspension mid-back task chair, plastic base, swivel-tilt control	88W-MB-2-ST-FA-5-HC
	Height/width adjustable arms	Suspension mid-back task chair, plastic base, swivel-tilt control	88W-MB-2-ST-HA-5-HC
	High performance arms	Suspension mid-back task chair, plastic base, swivel-tilt control	88W-MB-2-ST-HP-5-HC

Order Code	Ordering Information	Options
<i>Example:</i> 88W-MB-2-ST-HA 5-SL-HC Seat: K1000/8 Back: S08	<i>Specify:</i> 1. Pattern number 2. Seat and back upholstery 3. Suspension back color <i>Finish color:</i> Black	<i>Cylinder Height Option:</i> For low height cylinder (plastic base only), replace 5 in pattern number with L. See Dimensions page for seat height range. <i>Code: Upchg: Description:</i> L \$71 low cylinder
88W EWC Tech upholstered task chair		<i>Caster and Glide Options:</i> Substitute HC in pattern with one of the following options: <i>Code: Upchg: Description:</i> SC n/c soft black casters for hard surfaces GL n/c glides
MB Mid-back		
2 Black finish		
ST Swivel tilt control		
HA Height and width adjustable arms		
5 Standard height cylinder		<i>Sliding Seat Option:</i> For sliding seat with 2.75" of depth adjustment insert SL after cylinder choice in pattern number. Adds 0.5" to seat height. <i>Code: Upchg: Description:</i> SL \$39 sliding seat
SL Sliding seat	<i>Polished Aluminum Base:</i> Replace 2 in pattern with 4. Only available with standard height cylinder.	
HC Hard wheel black caster		
SEAT K1000/8 Presto, Red Carpet	<i>Code: Upchg: Description:</i> 4 \$150 polished aluminum base	
BACK S08 Red Carpet		

list price															
Presto base grade	A	COM B	C	D	E	F	G	H	I	T	COL U	V	W	X	Y
\$579.	\$592.	\$605.	\$620.	\$639.	\$658.	\$679.	\$688.	\$693.	\$706.	\$740.	\$791.	\$841.	\$925.	n/a	\$1,004.
635.	648.	661.	677.	696.	714.	735.	744.	749.	763.	799.	848.	898.	983.	n/a	1,063.
635.	648.	661.	677.	696.	714.	735.	744.	749.	763.	799.	848.	898.	983.	n/a	1,063.
665.	678.	690.	705.	724.	742.	764.	775.	779.	792.	828.	878.	927.	1,012.	n/a	1,093.
679.	692.	705.	720.	739.	758.	779.	788.	793.	806.	840.	891.	941.	1,025.	n/a	1,104.

Presto - Base Grade Fabric

- FOR SEAT ONLY**
Color options:
- Presto Winter White K1000/1
 - Presto Sand K1000/2
 - Presto Stone K1000/3
 - Presto Saffron K1000/4
 - Presto Spring Green K1000/5
 - Presto Blue Chip K1000/6
 - Presto Scarlet K1000/7
 - Presto Red Carpet K1000/8
 - Presto Beige Taupe K1000/9
 - Presto Olive K1000/10
 - Presto Navy Blue K1000/11
 - Presto Clear Gray K1000/12
 - Presto Charcoal Gray K1000/13
 - Presto Black Tie K1000/14



Suspension Back-Standard

- FOR BACK ONLY**
Color options:
- Red Carpet S08
 - Beige Taupe S09
 - Olive S10
 - Navy Blue S11
 - Clear Gray S12
 - Charcoal Gray S13
 - Black Tie S14
- EWC Tech Suspension Back is cleaning code W-S. It is rated Heavy Duty for abrasion (exceeds 30,000 double rubs Wyzenbeek method).

CAL 133 Options:
Code: Upchg: Description:
 C133 \$50 CAL 133 textile on seat only. (add C133 to the end of the pattern number)

COM/COL Upholstery Requirements
 Textile yardage required: .8 yards
 Leather sq. ft. required: 10 sq. ft.

EWC Tech™
suspension back conference chair
synchronized tilt control

	arm	description	pattern no.
<i>Designer(s):</i> Jeffrey Bernett and Nicholas Dodziuk, 2007 	Loop arms 	Suspension mid-back conference chair, plastic base, synchronized control	88C-MB-2-SY-LA-5-HC

Order Code	Ordering Information	Options
<i>Example:</i> 88C-MB-2-SY-LA 5-SL-HC Seat: K1000/8 - Back: S08	<i>Specify:</i> 1. Pattern number 2. Seat and back upholstery 3. Suspension back color <i>Finish color:</i> Black	<i>Cylinder Height Option:</i> For low height cylinder (platic base only), replace 5 in pattern number with L. See Dimensions page for seat height range. <i>Code: Upchg: Description:</i> L \$71 low cylinder <i>Caster and Glide Options:</i> Substitute HC in pattern with one of the following options: <i>Code: Upchg: Description:</i> SC n/c soft black casters for hard surfaces GL n/c glides
88C EWC Tech suspension back conference chair		
MB Mid-back		
2 Black finish		
SY Synchronized tilt control		
LA Loop width adjustable arms		
5 Standard height cylinder		
SL Sliding seat		
HC Hard wheel black caster		
SEAT Presto, Red Carpet		
K1000/8		
BACK S08 Red Carpet		
	Options <i>Polished Aluminum Base:</i> Replace 2 in pattern with 4. Only available with standard height cylinder. <i>Code: Upchg: Description:</i> 4 \$150 polished aluminum base	<i>Sliding Seat Option:</i> For sliding seat with 2.75" of depth adjustment insert SL after cylinder choice in pattern number. Adds 0.5" to seat height. <i>Code: Upchg: Description:</i> SL \$39 sliding seat

list price																
Presto		COM									COL					
base	A	B	C	D	E	F	G	H	I	T	U	V	W	X	Y	
grade																
	\$732.	\$744.	\$755.	\$773.	\$790.	\$809.	\$829.	\$839.	\$844.	\$857.	\$895.	\$943.	\$991.	\$1,076.	n/a	\$1,154.

Presto - Base Grade Fabric

- FOR SEAT ONLY**
Color options:
- Presto Winter White K1000/1
 - Presto Sand K1000/2
 - Presto Stone K1000/3
 - Presto Saffron K1000/4
 - Presto Spring Green K1000/5
 - Presto Blue Chip K1000/6
 - Presto Scarlet K1000/7
 - Presto Red Carpet K1000/8
 - Presto Beige Taupe K1000/9
 - Presto Olive K1000/10
 - Presto Navy Blue K1000/11
 - Presto Clear Gray K1000/12
 - Presto Charcoal Gray K1000/13
 - Presto Black Tie K1000/14

Suspension Back-Standard

- FOR BACK ONLY**
Color options:
- Red Carpet S08
 - Beige Taupe S09
 - Olive S10
 - Navy Blue S11
 - Clear Gray S12
 - Charcoal Gray S13
 - Black Tie S14
- EWC Tech Suspension Back is cleaning code W-S. It is rated Heavy Duty for abrasion (exceeds 30,000 double rubs Wyzenbeek method).

CAL 133 Options:

<i>Code:</i>	<i>Upchg:</i>	<i>Description:</i>
C133	\$50	CAL 133 textile on seat only. (add C133 to the end of the pattern number)

COM/COL Upholstery Requirements
 Textile yardage required: .8 yards
 Leather sq. ft. required: 10 sq. ft.

EWC Tech™
suspension back conference chair
swivel tilt control

	arm	description	pattern no.
<i>Designer(s):</i> Jeffrey Bernett and Nicholas Dodziuk, 2007	Loop arms 	Suspension mid-back conference chair, plastic base, swivel-tilt control	88C-MB-2-ST-LA-5-HC



Order Code

<i>Example:</i>	88C-MB-2-ST-LA 5-SL-HC Seat: K1000/8 Back: S08
88C	EWC Tech suspension back conference chair
MB	Mid-back
2	Black finish
ST	Swivel tilt control
LA	Loop width adjustable arms
5	Standard height cylinder
SL	Sliding seat
HC	Hard wheel black caster
SEAT	Presto, Red Carpet
K1000/8	
BACK S08	Red Carpet

Ordering Information

Specify:

1. Pattern number
2. Seat and back upholstery
3. Suspension back color

Finish color:
Black

Options

Polished Aluminum Base:
 Replace 2 in pattern with 4. Only available with standard height cylinder.

Code:	Upchg:	Description:
4	\$150	polished aluminum base

Options

Cylinder Height Option:
 For low height cylinder (plastic base only), replace 5 in pattern number with L. See Dimensions page for seat height range.

Code:	Upchg:	Description:
L	\$71	low cylinder

Sliding Seat Option:
 For sliding seat with 2.75" of depth adjustment insert SL after cylinder choice in pattern number. Adds 0.5" to seat height.

Code:	Upchg:	Description:
SL	\$39	sliding seat

Caster and Glide Options:
 Substitute HC in pattern with one of the following options:

Code:	Upchg:	Description:
SC	n/c	soft black casters for hard surfaces
GL	n/c	glides

list price															
Presto															
base															
grade	A	COM B	C	D	E	F	G	H	I	T	COL U	V	W	X	Y
\$635.	\$648.	\$661.	\$677.	\$696.	\$714.	\$735.	\$744.	\$749.	\$763.	\$799.	\$848.	\$898.	\$983.	n/a	\$1,063.

Presto - Base Grade Fabric

- FOR SEAT ONLY**
Color options:
- Presto Winter White K1000/1
 - Presto Sand K1000/2
 - Presto Stone K1000/3
 - Presto Saffron K1000/4
 - Presto Spring Green K1000/5
 - Presto Blue Chip K1000/6
 - Presto Scarlet K1000/7
 - Presto Red Carpet K1000/8
 - Presto Beige Taupe K1000/9
 - Presto Olive K1000/10
 - Presto Navy Blue K1000/11
 - Presto Clear Gray K1000/12
 - Presto Charcoal Gray K1000/13
 - Presto Black Tie K1000/14

Suspension Back-Standard



- FOR BACK ONLY**
Color options:
- Red Carpet S08
 - Beige Taupe S09
 - Olive S10
 - Navy Blue S11
 - Clear Gray S12
 - Charcoal Gray S13
 - Black Tie S14
- EWC Tech Suspension Back is cleaning code W-S. It is rated Heavy Duty for abrasion (exceeds 30,000 double rubs Wyzenbeek method).

CAL 133 Options:

<i>Code:</i>	<i>Upchg:</i>	<i>Description:</i>
C133	\$50	CAL 133 textile on seat only. (add C133 to the end of the pattern number)

COM/COL Upholstery Requirements
 Textile yardage required: .8 yards
 Leather sq. ft. required: 10 sq. ft.

EWC Tech™
suspension back side chair

	arm	description	pattern no.
Designer(s): Jeffrey Bernett and Nicholas Dodziuk, 2005 	Fixed arms	Suspension back side chair	88S-2-FA-HC
			
	Armless	Suspension back side chair	88S-2-NA-HC
			

Order Code

Example: **88S-2-FA-HC Seat:**
K1000/8 Back: S08

88S	EWC Tech suspension back side chair
2	Black finish
FA	Fixed arms
HC	Hard wheel black caster
SEAT	Presto, Red Carpet
K1000/8	
BACK S08	Red Carpet suspension back

Ordering Information

Specify:

1. Pattern number
2. Seat and back upholstery
3. Suspension back color

Finish color:
Black

Options

Caster and Glide Options:
Substitute HC in pattern with one of the following options:

<i>Code:</i>	<i>Upchg:</i>	<i>Description:</i>
SC	n/c	soft black casters for hard surfaces
GL	n/c	glides

list price															
Presto															
base															
grade	A	COM B	C	D	E	F	G	H	I	T	COL U	V	W	X	Y
\$409.	\$424.	\$436.	\$451.	\$471.	\$488.	\$509.	\$520.	\$524.	\$537.	\$569.	\$619.	\$667.	\$749.	n/a	\$828.
381.	398.	409.	426.	444.	464.	485.	495.	501.	514.	546.	596.	645.	733.	n/a	811.

Presto - Base Grade Fabric

- FOR SEAT ONLY**
Color options:
- Presto Winter White K1000/1
 - Presto Sand K1000/2
 - Presto Stone K1000/3
 - Presto Saffron K1000/4
 - Presto Spring Green K1000/5
 - Presto Blue Chip K1000/6
 - Presto Scarlet K1000/7
 - Presto Red Carpet K1000/8
 - Presto Beige Taupe K1000/9
 - Presto Olive K1000/10
 - Presto Navy Blue K1000/11
 - Presto Clear Gray K1000/12
 - Presto Charcoal Gray K1000/13
 - Presto Black Tie K1000/14

Suspension Back-Standard

- FOR BACK ONLY**
Color options:
- Red Carpet S08
 - Beige Taupe S09
 - Olive S10
 - Navy Blue S11
 - Clear Gray S12
 - Charcoal Gray S13
 - Black Tie S14
- EWC Tech Suspension Back is cleaning code W-S. It is rated Heavy Duty for abrasion (exceeds 30,000 double rubs Wyzenbeek method).

CAL 133 Options:
Code: Upchg: Description:
 C133 \$50 CAL 133 textile on seat only. (add C133 to the end of the pattern number)

COM/COL Upholstery Requirements
 Textile yardage required: .8 yards
 Leather sq. ft. required: 10 sq. ft.

EWC Tech™

seat and back replacements for task, conference and side chairs

	description	pattern no.
<p>Designer(s): Jeffrey Bernett and Nicholas Dodziuk, 2007</p> 	Replacement upholstered seat for EWC Pro and EWC Tech side chairs	ESSENSIDSEAT
	Replacement upholstered seat for EWC Pro and EWC Tech task and conference chairs	ESSENWORKSEAT
	Replacement EWC Tech side back	88SBACK
	Replacement EWC Tech task and conference back	88WBACK

Order Code	Ordering Information	Presto - Base Grade Fabric	Suspension Back-Standard
<p>Example: ESSENWORKSEAT - K1000/8</p> <hr/> <p>ESSENWORKSEAT Upholstered seat replacement</p> <hr/> <p>K1000/8 Presto, Red Carpet</p>	<p>Specify:</p> <ol style="list-style-type: none"> 1. Pattern number 2. Seat upholstery or Suspension back color <p>COM/COL Upholstery Requirements Textile yardage required: .8 yards Leather sq. ft. required: 10 sq. ft.</p>	<p>FOR SEAT ONLY Color options:</p> <p>Presto Winter White K1000/1 Presto Sand K1000/2 Presto Stone K1000/3 Presto Saffron K1000/4 Presto Spring Green K1000/5 Presto Blue Chip K1000/6 Presto Scarlet K1000/7 Presto Red Carpet K1000/8 Presto Beige Taupe K1000/9 Presto Olive K1000/10 Presto Navy Blue K1000/11 Presto Clear Gray K1000/12 Presto Charcoal Gray K1000/13 Presto Black Tie K1000/14</p>	<p>FOR BACK ONLY Color options:</p> <p>Red Carpet S08 Beige Taupe S09 Olive S10 Navy Blue S11 Clear Gray S12 Charcoal Gray S13 Black Tie S14</p> <p>EWC Tech Suspension Back is cleaning code W-S. It is rated Heavy Duty for abrasion (exceeds 30,000 double rubs Wyzenbeek method).</p>

list price Presto base grade	A	COM B	C	D	E	F	G	H	I	T	COL U	V	W	X	Y
\$110.	\$135.	\$148.	\$166.	\$186.	\$205.	\$227.	\$238.	\$245.	\$259.	\$289.	\$341.	\$394.	\$485.	n/a	\$568.
107.	128.	142.	159.	180.	200.	222.	235.	239.	256.	286.	338.	392.	485.	n/a	571.
142.															
173.															

Options

CAL 133 Options:

Code:	Upchg:	Description:
C133	\$50	CAL 133 textile on seat only. (add C133 to the end of the pattern number)

EWC Tech™ Task Dimensions and Operating Instructions

Seat*	BIFMA G1-2002 Ergonomic Guidelines	EWC Tech Mid-back Task Ergonomic Dimensions	EWC Tech Side
Seat Height**	15" - 19.9" minimum range (one or combination of chairs)	16.25" - 20.75" (std. cylinder) 15.5" - 19.6" (alum. base, std. cylinder) 15" - 19" (low cylinder) **sliding seat option adds 0.5" to all seat height dimensions	17"
Seat Depth	16.9" or less fixed, include if adjustable	16.9" (fixed) 16.25" - 19" (adjustable)	16.9"
Seat Width	18" min	19"	19"
Seat Pan Angle (at rest)	0° - 4° rearward	2°	2°
Back*			
Backrest Height	12.2" min	23"	17.5"
Backrest Width	14.2" min	19"	18.5"
Lumbar Support	5.9" - 9.8"	6.5"	6.25"
Angle Between Seat and Back	90° - 115°	96°	103°
Tilt Range of Back	10° min	24° (synchro) 14° (swivel)	N/A
Arms*			
Armrest Height (fixed)	7.9" - 9.8"	8.2" (fixed); 8" (loop)	9.4"
Armrest Height (adjustable)	6.9" - 10.8"	7" - 10.5" (height adj.) 7.875" - 11" (high perf.)	N/A
Inside Distance Between Armrests (fixed)	18" min	19.5" - 21.5" (fixed) 19.7" - 21.9" (loop)	19.5"
Inside Distance Between Armrests (adjustable)	include 18"	19.5" - 21.5" (height adj.) 18.5" - 20.625" (high perf.)	N/A

*All measurements taken with BIFMA Chair Measuring Device using the Universal Measurement Procedure which has a measurement uncertainty of ±5%

Chair Measurements ***			
A Overall Height		38.25" - 42.75" (plastic base) 37.5" - 41.6" (alum. base)	32"
B Overall Width		27"	21.75" (armless) 24.3" (with arms)
C Overall Depth		27" (plastic base); 26.75" (alum. base)	24"
D Fixed Arm Height from Floor		24.2" - 28.7"	25.8"
Loop Arm Height from Floor		24" - 28.5"	N/A
Height Adj. Arm Height from Floor		23" - 31.5"	N/A
High Perf. Arm Height from Floor		22.875" - 30.5"	N/A
E Recline Range		96° - 120° (synchro) 96° - 110° (swivel)	N/A N/A
Back Recline Ratio		1:3 (synchro); 1:1 (swivel)	N/A
F Base Diameter		27" (plastic); 26.75" (alum.)	N/A
G Weight		38.6 lbs. (plastic base) 40.6 lbs. (alum. base)	19.2 lbs. (armless) 22.5 lbs. (with arms)

***standard cylinder; sliding seat option adds 0.5" to overall height and arm height from floor



Compliance: ANSI/BIFMA X5.1 : 2002 (U.S. structural standard), BIFMA G1 : 2002 (U.S. ergonomic guidelines), California T.B. 117 (U.S. flammability standard for foam), California T.B. 133 with approved FR textile (U.S. flammability standard for full chair), CAN/CGSB 44.232-2002 (except conference chairs)

The EWC Tech chair line has been tested and is approved for use by individuals weighing up to 300 pounds.

EWC Tech Task Chair Operating Instructions

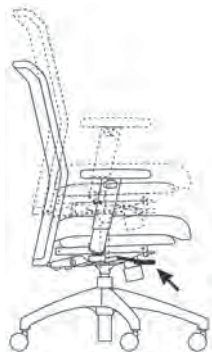

Seat Height

To raise the seat height, remove your weight from the chair while lifting the lever under the right side of the seat. To lower the seat height, lift the lever while sitting in the chair.



Adjustable Arm Width (All arm options)

To adjust the arm width, loosen the knob under the arm support by turning clockwise. Slide the arm support toward or away from the seat to adjust the arm width. Tighten the knob under the arm to secure.



Tilt Lock

To recline, pull out the lever under the right side of the seat. To lock the chair upright, push the lever in.

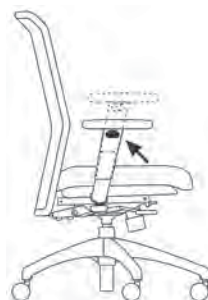

Height Adjustable Arm (Optional)

To adjust the arm pad height, lift the lever on the outside of the arm support and move the arm up or down. Release the lever to lock.



Tilt Tension

To adjust the tilt tension, turn the knob under the front of the seat. Turn counterclockwise to tighten, and clockwise to loosen.

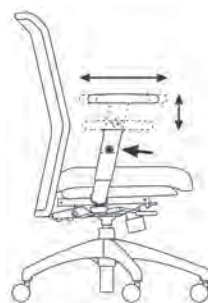

High Performance Arm (Optional)

To adjust the arm pad height, push the button on the outside of the arm support and move the arm up or down. Release the button to lock. To adjust arm pad depth, grasp arm pad and push forward or pull backward. The arm pad adjusts 2.5" in depth.

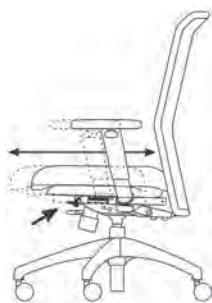

Sliding Seat Depth Adjustment (Optional)

To adjust the seat depth, lift the lever under the left side of the seat and slide the seat to the desired location. Release the lever to lock in one of the 6 positions.



EWC Tech Side Chair

This is a stacking side chair.

Chairs should not be stacked more than 3 units high. To stack chairs, place the rear legs of the top chair in front of the rear legs of the bottom chair. The bottom of the top chair's seat should rest on the lower chair's seat.

EWC Tech™ Conference Dimensions and Operating Instructions

Seat*	BIFMA G1-2002 Ergonomic Guidelines	EWC Tech Mid-back Conference Ergonomic Dimensions
Seat Height**	15" - 19.9 minimum range" (one or combination of chairs)	16.25" - 20.75" (std. cylinder) 15.5" - 19.6" (alum. base, std. cylinder) 15" - 19" (low cylinder) **sliding seat option adds 0.5" to all seat height dimensions
Seat Depth	16.9" or less fixed, include if adjustable	16.9" (fixed) 16.25" - 19" (adjustable)
Seat Width	18" min	19"
Seat Pan Angle (at rest)	0° - 4° rearward	2°
Back*		
Backrest Height	12.2" min	23"
Backrest Width	14.2" min	19"
Lumbar Support	5.9" - 9.8"	6.5"
Angle Between Seat and Back	90° - 115°	96°
Tilt Range of Back	10° min	24° (synchro) 14° (swivel)
Arms*		
Armrest Height (fixed)	7.9" - 9.8"	8" (loop)
Inside Distance Between Armrests (fixed)	18" min	19.7" - 21.9" (loop)
*All measurements taken with BIFMA Chair Measuring Device using the Universal Measurement Procedure which has a measurement uncertainty of ±5%		
Chair Measurements***		
A Overall Height		38.25" - 42.75" (plastic base) 37.5" - 41.6" (alum. base)
B Overall Width		27"
C Overall Depth		27" (plastic base) 26.75" (alum. base)
D Loop Arm Height from Floor		24" - 28.5"
E Recline Range		96° - 120° (synchro) 96° - 110° (swivel)
Back Recline Ratio		1:3 (synchro); 1:1 (swivel)
F Base Diameter		27" (plastic); 26.75" (alum.)
G Weight		38.6 lbs.(plastic base) 40.6 lbs. (alum. base)

***standard cylinder; sliding seat adds 0.5" to overall height and arm height from floor

EWC Tech Conference

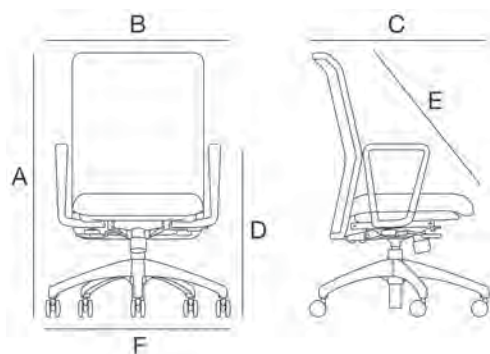

Compliance: ANSI/BIFMA X5.1 : 2002 (U.S. structural standard), BIFMA G1 : 2002 (U.S. ergonomic guidelines), California T.B. 117 (U.S. flammability standard for foam), California T.B. 133 with approved FR textile (U.S. flammability standard for full chair)

The EWC Tech chair line has been tested and is approved for use by individuals weighing up to 300 pounds.

EWC Tech Conference Chair Operating Instructions



Seat Height

To raise the seat height, remove your weight from the chair while lifting the lever under the right side of the seat. To lower the seat height, lift the lever while sitting in the chair.



Adjustable Arm Width

To adjust the arm width, loosen the knob under the arm support by turning clockwise. Slide the arm support toward or away from the seat to adjust the arm width. Tighten the knob under the arm to secure.

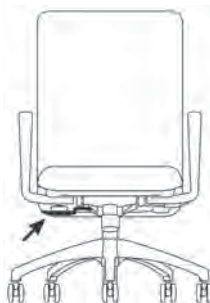

Tilt Lock

To recline, pull out the lever under the right side of the seat. To lock the chair upright, push the lever in.

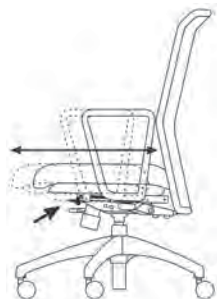

Sliding Seat Depth Adjustment (Optional)

To adjust the seat depth, lift the lever under the left side of the seat and slide the seat to the desired location. Release the lever to lock in one of the 6 positions.







Tilt Tension

To adjust the tilt tension, turn the knob under the front of the seat. Turn counterclockwise to tighten, and clockwise to loosen.

EWC Sport™

upholstered mid-back task chair

synchronized tilt control

	arm	description	pattern no.	
<p>Designer(s): Jeffrey Bennett and Nicholas Dodziuk, 2007</p>  <p>(Shown with EWC Sport Fabric Seat Accent Option)</p>	Armless	Upholstered mid-back task chair with upholstered outer back, 2.5" back height adjustment, plastic base, synchronized control	99W-MBU-2-SY-NA-5-HC	
		Loop arms	Upholstered mid-back task chair with upholstered outer back, 2.5" back height adjustment, plastic base, synchronized control	99W-MBU-2-SY-LA-5-HC
		Fixed arms	Upholstered mid-back task chair with upholstered outer back, 2.5" back height adjustment, plastic base, synchronized control	99W-MBU-2-SY-FA-5-HC
		Height/width adjustable arms	Upholstered mid-back task chair with upholstered outer back, 2.5" back height adjustment, plastic base, synchronized control	99W-MBU-2-SY-HA-5-HC
		High performance arms	Upholstered mid-back task chair with upholstered outer back, 2.5" back height adjustment, plastic base, synchronized control	99W-MBU-2-SY-HP-5-HC

Order Code	Ordering Information	Options	
<p>Example: 99W-MBU-2-SY-HA-5-SL-HC K1000/8 K1000/8 K1000/8 K1196/14</p> <p>99W EWC Sport task chair</p> <p>MB Mid-back</p> <p>U Upholstered outer back</p> <p>2 Black finish</p> <p>SY Synchronized tilt control</p> <p>HA Height and width adjustable arms</p> <p>5 Standard height cylinder</p> <p>SL Sliding seat</p> <p>HC Hard wheel black casters</p> <p>K1000/8 Presto, Red Carpet</p> <p>K1000/8 Presto, Red Carpet</p> <p>K1000/8 Presto, Red Carpet</p> <p>K1196/14 EWC Sport Black</p>	<p>Specify:</p> <ol style="list-style-type: none"> 1. Pattern number 2. Seat upholstery 3. Seat accent upholstery 4. Back upholstery 5. Back accent upholstery <p>Finish color: Black</p> <p>Options</p> <p><i>Polished Aluminum Base:</i> Replace 2 in pattern with 4. Only available with standard height cylinder.</p> <p>Code: Upchg: Description: 4 \$150 polished aluminum base</p>	<p><i>Cylinder Height Option:</i> For low height cylinder (plastic base only), replace 5 in pattern number with L. See Dimensions page for seat height range.</p> <p>Code: Upchg: Description: L \$71 low cylinder</p> <p><i>Sliding Seat Option:</i> For sliding seat with 2.75" of depth adjustment insert SL after cylinder choice in pattern number. Adds 0.5" to seat height.</p> <p>Code: Upchg: Description: SL \$39 sliding seat</p>	<p><i>Caster and Glide Options:</i> Substitute HC in pattern with one of the following options:</p> <p>Code: Upchg: Description: SC n/c soft black casters for hard surfaces GL n/c glides</p>

list price	COM														
Presto base grade	A	B	C	D	E	F	G	H	I	T	COL U	V	W	X	Y
\$682.	\$713.	\$745.	\$778.	\$820.	\$864.	\$906.	\$949.	\$1,014.	\$1,089.	\$1,091.	\$1,166.	\$1,334.	\$1,543.	n/a	\$1,738.
735.	767.	799.	831.	874.	918.	961.	1,004.	1,069.	1,143.	1,144.	1,221.	1,388.	1,599.	n/a	1,792.
735.	767.	799.	831.	874.	918.	961.	1,004.	1,069.	1,143.	1,144.	1,221.	1,388.	1,599.	n/a	1,792.
765.	796.	828.	861.	903.	946.	990.	1,033.	1,098.	1,173.	1,175.	1,250.	1,417.	1,627.	n/a	1,822.
782.	813.	845.	878.	920.	964.	1,006.	1,049.	1,114.	1,189.	1,191.	1,266.	1,434.	1,643.	n/a	1,838.

Presto - Base Grade Fabric

Color options:

- Presto Winter White K1000/1
- Presto Sand K1000/2
- Presto Stone K1000/3
- Presto Saffron K1000/4
- Presto Spring Green K1000/5
- Presto Blue Chip K1000/6
- Presto Scarlet K1000/7
- Presto Red Carpet K1000/8
- Presto Beige Taupe K1000/9
- Presto Olive K1000/10
- Presto Navy Blue K1000/11
- Presto Clear Gray K1000/12
- Presto Charcoal Gray K1000/13
- Presto Black Tie K1000/14

For split seat and back upholstery, indicate the words "seat" and "back" before the selected color.

EWC Sport Fabric

Back and Seat Accent Options:

All EWC Sport chairs come standard with an EWC Sport fabric upholstered outer back accent. The back accent can only be specified in EWC Sport fabric. Optional EWC Sport fabric seat accents can be specified for an upcharge of \$27. EWC Sport fabric is available in three colors as outlined below. Chair can be fully upholstered in EWC Sport fabric at Grade A pricing.

Color Options:

- EWC Sport Beige Taupe K1196/9
- EWC Sport Charcoal Gray K1196/13
- EWC Sport Black K1196/14

EWC Sport Fabric exceeds 100,000 double rubs Wyzenbeek method and is cleaning code W-S.

Split Upholstery Option:

EWC Sport seats and backs can be upholstered in any two approved KnollTextiles or Spinneybeck upholsteries. To specify, first indicate the seat upholstery (labeled "seat upholstery") and then indicate the back upholstery (labeled "back upholstery"). The list price of the chair equals the list price of the higher of the two upholstery grades.

COM/COL Upholstery Requirements

Textile yardage required: 1.9 yards
Leather sq. ft. required: 22 sq. ft.







CAL 133 Options:

<i>Code:</i>	<i>Upchg:</i>	<i>Description:</i>
C133	\$78	CAL 133 textile on seat and back. Add C133 to the end of the pattern number

EWC Sport™

upholstered mid-back task chair

swivel tilt control

	arm	description	pattern no.
<p>Designer(s): Jeffrey Bennett and Nicholas Dodziuk, 2007</p>  <p>(Shown with EWC Sport Fabric Seat Accent Option)</p>	Armless 	Upholstered mid-back task chair with upholstered outer back, 2.5" back height adjustment, plastic base, swivel-tilt control	99W-MBU-2-ST-NA-5-HC
	Loop arms 	Upholstered mid-back task chair with upholstered outer back, 2.5" back height adjustment, plastic base, swivel-tilt control	99W-MBU-2-ST-LA-5-HC
	Fixed arms 	Upholstered mid-back task chair with upholstered outer back, 2.5" back height adjustment, plastic base, swivel-tilt control	99W-MBU-2-ST-FA-5-HC
	Height/width adjustable arms 	Upholstered mid-back task chair with upholstered outer back, 2.5" back height adjustment, plastic base, swivel-tilt control	99W-MBU-2-ST-HA-5-HC
	High performance arms 	Upholstered mid-back task chair with upholstered outer back, 2.5" back height adjustment, plastic base, swivel-tilt control	99W-MBU-2-ST-HP-5-HC

Order Code	Ordering Information	Options
<p>Example: 99W-MBU-2-ST-HA-5-SL-HC K1000/8 K1000/8 K1000/8 K1196/14</p> <p>99W EWC Sport task chair</p> <p>MB Mid-back</p> <p>U Upholstered outer back</p> <p>2 Black finish</p> <p>ST Swivel tilt control</p> <p>HA Height and width adjustable arms</p> <p>5 Standard height cylinder</p> <p>SL Sliding seat</p> <p>HC Hard wheel black casters</p> <p>K1000/8 Presto, Red Carpet</p> <p>K1000/8 Presto, Red Carpet</p> <p>K1000/8 Presto, Red Carpet</p> <p>K1196/14 EWC Sport Black</p>	<p>Specify:</p> <ol style="list-style-type: none"> 1. Pattern number 2. Seat upholstery 3. Seat accent upholstery 4. Back upholstery 5. Back accent upholstery <p>Finish color: Black</p> <p>Options</p> <p><i>Polished Aluminum Base:</i> Replace 2 in pattern with 4. Only available with standard height cylinder.</p> <p>Code: Upchg: Description: 4 \$150 polished aluminum base</p>	<p><i>Cylinder Height Option:</i> For low height cylinder (plastic base only), replace 5 in pattern number with L. See Dimensions page for seat height range.</p> <p>Code: Upchg: Description: L \$71 low cylinder</p> <p><i>Sliding Seat Option:</i> For sliding seat with 2.75" of depth adjustment insert SL after cylinder choice in pattern number. Adds 0.5" to seat height.</p> <p>Code: Upchg: Description: SL \$39 sliding seat</p> <p><i>Caster and Glide Options:</i> Substitute HC in pattern with one of the following options:</p> <p>Code: Upchg: Description: SC n/c soft black casters for hard surfaces GL n/c glides</p>

list price	COM													COL	
Presto base grade	A	B	C	D	E	F	G	H	I	T	U	V	W	X	Y
\$585.	\$616.	\$649.	\$682.	\$725.	\$769.	\$812.	\$856.	\$921.	\$998.	\$998.	\$1,075.	\$1,244.	\$1,456.	n/a	\$1,654.
639.	671.	703.	736.	780.	824.	868.	911.	977.	1,053.	1,054.	1,130.	1,299.	1,512.	n/a	1,710.
639.	671.	703.	736.	780.	824.	868.	911.	977.	1,053.	1,054.	1,130.	1,299.	1,512.	n/a	1,710.
669.	700.	733.	766.	809.	852.	897.	940.	1,006.	1,083.	1,083.	1,159.	1,330.	1,542.	n/a	1,739.
685.	716.	749.	782.	825.	869.	912.	956.	1,021.	1,098.	1,098.	1,175.	1,344.	1,556.	n/a	1,754.

Presto - Base Grade Fabric

Color options:

- Presto Winter White K1000/1
- Presto Sand K1000/2
- Presto Stone K1000/3
- Presto Saffron K1000/4
- Presto Spring Green K1000/5
- Presto Blue Chip K1000/6
- Presto Scarlet K1000/7
- Presto Red Carpet K1000/8
- Presto Beige Taupe K1000/9
- Presto Olive K1000/10
- Presto Navy Blue K1000/11
- Presto Clear Gray K1000/12
- Presto Charcoal Gray K1000/13
- Presto Black Tie K1000/14

For split seat and back upholstery, indicate the words "seat" and "back" before the selected color.

EWC Sport Fabric

Back and Seat Accent Options:

All EWC Sport chairs come standard with an EWC Sport fabric upholstered outer back accent. The back accent can only be specified in EWC Sport fabrics. Optional EWC Sport fabric seat accents can be specified at an upcharge of \$27. EWC Sport fabric is available in three colors as outlined below. Chair can be fully upholstered in EWC Sport fabric at Grade A pricing.

Color Options:

- EWC Sport Beige Taupe K1196/9
- EWC Sport Charcoal Gray K1196/13
- EWC Sport Black K1196/14

EWC Sport Fabric exceeds 100,000 double rubs Wyzenbeek method and is cleaning code W-S.

Split Upholstery Option:

EWC Sport seats and backs can be upholstered in any two approved KnollTextiles or Spinneybeck upholsteries. To specify, first indicate the seat upholstery (labeled "seat upholstery") and then indicate the back upholstery (labeled "back upholstery"). The list price of the chair equals the list price of the higher of the two upholstery grades.



COM/COL Upholstery Requirements

Textile yardage required: 1.9 yards
Leather sq. ft. required: 22 sq. ft.

CAL 133 Options:

Code: Upchg: Description:
C133 \$78 CAL 133 textile on seat and back. Add C133 to the end of the pattern number

EWC Sport™
upholstered mid-back conference chair
synchronized tilt control

	arm	description	pattern no.
<p>Designer(s): Jeffrey Bernett and Nicholas Dodziuk, 2007</p>  <p>(Shown with EWC Sport Fabric Seat Accent Option)</p>	<p>Loop arms</p> 	<p>Upholstered mid-back conference chair with upholstered outer back, fixed back height, plastic base, synchronized control</p>	<p>99C-MBU-2-SY-LA-5-HC</p>

Order Code	Ordering Information	Options
<p>Example: 99C-MBU-2-SY-LA-5-SL-HC K1000/8 K1000/8 K1000/8 K1196/14</p> <p>99C EWC Sport conference chair</p> <p>MB Mid-back</p> <p>U Upholstered outer back</p> <p>2 Black finish</p> <p>SY Synchronized tilt control</p> <p>LA Loop width adjustable arms</p> <p>5 Standard height cylinder</p> <p>SL Sliding seat</p> <p>HC Hard wheel black casters</p> <p>K1000/8 Presto, Red Carpet</p> <p>K1000/8 Presto, Red Carpet</p> <p>K1000/8 Presto, Red Carpet</p> <p>K1196/14 EWC Sport Black</p>	<p>Specify:</p> <ol style="list-style-type: none"> 1. Pattern number 2. Seat upholstery 3. Seat accent upholstery 4. Back upholstery 5. Back accent upholstery <p>Finish color: Black</p> <p>Options</p> <p><i>Polished Aluminum Base:</i> Replace 2 in pattern with 4. Only available with standard height cylinder.</p> <p>Code: Upchg: Description: 4 \$150 polished aluminum base</p>	<p><i>Cylinder Height Option:</i> For low height cylinder (plastic base only), replace 5 in pattern number with L. See Dimensions page for seat height range.</p> <p>Code: Upchg: Description: L \$71 low cylinder</p> <p><i>Sliding Seat Option:</i> For sliding seat with 2.75" of depth adjustment insert SL after cylinder choice in pattern number. Adds 0.5" to seat height.</p> <p>Code: Upchg: Description: SL \$39 sliding seat</p> <p><i>Caster and Glide Options:</i> Substitute HC in pattern with one of the following options:</p> <p>Code: Upchg: Description: SC n/c soft black casters for hard surfaces GL n/c glides</p>

list price															
Presto		COM									COL				
base	A	B	C	D	E	F	G	H	I	T	U	V	W	X	Y
grade															
\$729.	\$761.	\$794.	\$826.	\$869.	\$912.	\$955.	\$998.	\$1,064.	\$1,138.	\$1,139.	\$1,215.	\$1,383.	\$1,593.	n/a	\$1,787.

Presto - Base Grade Fabric

Color options:

- Presto Winter White K1000/1
- Presto Sand K1000/2
- Presto Stone K1000/3
- Presto Saffron K1000/4
- Presto Spring Green K1000/5
- Presto Blue Chip K1000/6
- Presto Scarlet K1000/7
- Presto Red Carpet K1000/8
- Presto Beige Taupe K1000/9
- Presto Olive K1000/10
- Presto Navy Blue K1000/11
- Presto Clear Gray K1000/12
- Presto Charcoal Gray K1000/13
- Presto Black Tie K1000/14

For split seat and back upholstery, indicate the words "seat" and "back" before the selected color.

EWC Sport Fabric

Back and Seat Accent Options:

All EWC Sport chairs come standard with an EWC Sport fabric upholstered outer back accent. The back accent can only be specified in EWC Sport fabric. Optional EWC Sport fabric seat accents can be specified for an upcharge of \$27. EWC Sport fabric is available in three colors as outlined below. Chair can be fully upholstered in EWC Sport fabric at Grade A pricing.

Color Options:

- EWC Sport Beige Taupe K1196/9
- EWC Sport Charcoal Gray K1196/13
- EWC Sport Black K1196/14

EWC Sport Fabric exceeds 100,000 double rubs Wyzenbeek method and is cleaning code W-S.

Split Upholstery Option:

EWC Sport seats and backs can be upholstered in any two approved KnollTextiles or Spinneybeck upholsteries. To specify, first indicate the seat upholstery (labeled "seat upholstery") and then indicate the back upholstery (labeled "back upholstery"). The list price of the chair equals the list price of the higher of the two upholstery grades.

COM/COL Upholstery Requirements

Textile yardage required: 1.9 yards
Leather sq. ft. required: 22 sq. ft.

CAL 133 Options:

Code: Upchg: Description:
C133 \$78 CAL 133 textile on seat and back. Add C133 to the end of the pattern number

EWC Sport™
 upholstered mid-back conference chair
 swivel tilt control

Designer(s):	arm	description	pattern no.
Jeffrey Bernett and Nicholas Dodziuk, 2007	Loop arms 	Upholstered mid-back conference chair with upholstered outer back, fixed back height, plastic base, swivel-tilt control	99C-MBU-2-ST-LA-5-HC



(Shown with EWC Sport Fabric
Seat Accent Option)

Order Code	Ordering Information	Options
<i>Example:</i> 99C-MBU-2-ST-LA-5-SL-HC K1000/8 K1000/8 K1000/8 K1196/14	<i>Specify:</i> 1. Pattern number 2. Seat upholstery 3. Seat accent upholstery 4. Back upholstery 5. Back accent upholstery	<i>Cylinder Height Option:</i> For low height cylinder (plastic base only), replace 5 in pattern number with L. See Dimensions page for seat height range. <i>Code: Upchg: Description:</i> L \$71 low cylinder
99C EWC Sport conference chair	<i>Finish color:</i> Black	<i>Caster and Glide Options:</i> Substitute HC in pattern with one of the following options: <i>Code: Upchg: Description:</i> SC n/c soft black casters for hard surfaces GL n/c glides
MB Mid-back		
U Upholstered outer back		
2 Black finish		
ST Swivel tilt control		
LA Loop width adjustable arms		
5 Standard height cylinder		
SL Sliding seat		<i>Sliding Seat Option:</i> For sliding seat with 2.75" of depth adjustment insert SL after cylinder choice in pattern number. Adds 0.5" to seat height. <i>Code: Upchg: Description:</i> SL \$39 sliding seat
HC Hard wheel black casters	<i>Options</i>	
K1000/8 Presto, Red Carpet	<i>Polished Aluminum Base:</i> Replace 2 in pattern with 4. Only available with standard height cylinder.	
K1000/8 Presto, Red Carpet	<i>Code: Upchg: Description:</i> 4 \$150 polished aluminum base	
K1000/8 Presto, Red Carpet		
K1196/14 EWC Sport Black		

list price															
Presto		COM									COL				
base	A	B	C	D	E	F	G	H	I	T	U	V	W	X	Y
grade															
\$633.	\$665.	\$698.	\$730.	\$775.	\$818.	\$863.	\$906.	\$972.	\$1,047.	\$1,047.	\$1,124.	\$1,294.	\$1,507.	n/a	\$1,704.

Presto - Base Grade Fabric

Color options:

- Presto Winter White K1000/1
- Presto Sand K1000/2
- Presto Stone K1000/3
- Presto Saffron K1000/4
- Presto Spring Green K1000/5
- Presto Blue Chip K1000/6
- Presto Scarlet K1000/7
- Presto Red Carpet K1000/8
- Presto Beige Taupe K1000/9
- Presto Olive K1000/10
- Presto Navy Blue K1000/11
- Presto Clear Gray K1000/12
- Presto Charcoal Gray K1000/13
- Presto Black Tie K1000/14

For split seat and back upholstery, indicate the words "seat" and "back" before the selected color.

EWC Sport Fabric

Back and Seat Accent Options:

All EWC Sport chairs come standard with an EWC Sport fabric upholstered outer back accent. The back accent can only be specified in EWC Sport fabric. Optional EWC Sport fabric seat accents can be specified for an upcharge of \$27. EWC Sport fabric is available in three colors as outlined below. Chair can be fully upholstered in EWC Sport fabric at Grade A pricing.

Color Options:

- EWC Sport Beige Taupe K1196/9
- EWC Sport Charcoal Gray K1196/13
- EWC Sport Black K1196/14

EWC Sport Fabric exceeds 100,000 double rubs Wyzenbeek method and is cleaning code W-S.

Split Upholstery Option:

EWC Sport seats and backs can be upholstered in any two approved KnollTextiles or Spinneybeck upholsteries. To specify, first indicate the seat upholstery (labeled "seat upholstery") and then indicate the back upholstery (labeled "back upholstery"). The list price of the chair equals the list price of the higher of the two upholstery grades.

COM/COL Upholstery Requirements

Textile yardage required: 1.9 yards
Leather sq. ft. required: 22 sq. ft.

CAL 133 Options:

Code: Upchg: Description:
C133 \$78 CAL 133 textile on seat and back. Add C133 to the end of the pattern number

EWC Sport™

seat and back replacements for task and conference chairs

	description	pattern no.
<p>Designer(s): Jeffrey Bernett and Nicholas Dodziuk, 2007</p>  <p>(Shown with EWC Sport Fabric Seat Accent Option)</p>	Replacement upholstered back for EWC Sport conference chair with upholstered outer back and fixed back height	99CMBSPORTBACK
	Replacement upholstered back for EWC Sport Task chair with upholstered outer back and 2.5" back height adjustment	99WMBSPORTBACK
	Replacement upholstered seat for EWC Sport Task and conference chairs	ESSENSPORTSEAT

Order Code	Ordering Information	Presto - Base Grade Fabric	EWC Sport Fabric
Example: ESSENSPORTSEAT - K1000/8 K1196/14	Specify:	Color options:	Back and Seat Accent Options:
ESSEN Upholstered seat	1. Pattern number	Presto Winter White K1000/1	All EWC Sport chairs come standard with an EWC Sport fabric upholstered outer back accent. The back accent can only be specified in EWC Sport fabric. Optional EWC Sport fabric seat accents can be specified for an upcharge of \$27. EWC Sport fabric is available in three colors as outlined below. Chair can be fully upholstered in EWC Sport fabric at Grade A pricing.
SPORT-SEAT replacement	2. Seat upholstery and seat accent upholstery	Presto Sand K1000/2	
K1000/8 Presto Red Carpet	3. Back upholstery and back accent upholstery	Presto Stone K1000/3	
K1196/14 EWC Sport Black		Presto Saffron K1000/4	Color Options: EWC Sport Beige Taupe K1196/9 EWC Sport Charcoal Grey K1196/13 EWC Sport Black K1196/14 EWC Sport Fabric exceeds 100,000 double rubs Wyzenbeek method and is cleaning code W-S.
	COM/COL Upholstery Requirements	Presto Spring Green K1000/5	
	Textile yardage required: 1.9 yds.	Presto Blue Chip K1000/6	
	Leather sq. ft. required: 22 sq. ft.	Presto Scarlet K1000/7	
		Presto Red Carpet K1000/8	
		Presto Beige Taupe K1000/9	
		Presto Olive K1000/10	
		Presto Navy Blue K1000/11	
		Presto Clear Gray K1000/12	
		Presto Charcoal Gray K1000/13	
		Presto Black Tie K1000/14	

list price Presto base grade	A	COM B	C	D	E	F	G	H	I	T	COL U	V	W	X	Y
\$337.	\$381.	\$405.	\$438.	\$478.	\$517.	\$564.	\$584.	\$596.	\$623.	\$754.	\$882.	\$1,006.	\$1,216.	n/a	\$1,418.
337.	381.	405.	438.	478.	517.	564.	584.	596.	623.	754.	882.	1,006.	1,216.	n/a	1,418.
148.	170.	180.	192.	207.	213.	230.	234.	274.	280.	314.	345.	415.	504.	n/a	586.

Options

CAL 133 Options:

Code: Upchg: Description:
 C133 \$78 CAL 133 textile on
 seat and back. Add
 C133 to the end of
 the pattern number

EWC Sport™ Task Dimensions and Operating Instructions

Seat*	BIFMA G1-2002 Ergonomic Guidelines	EWC Sport Mid-back Task Ergonomic Dimensions
Seat Height**	15" - 19.9" minimum range (one or combination of chairs)	15.6" - 20.25" (std. cylinder) 14.9" - 19" (alum. base, std. cylinder) 14.4" - 18.5" (low cylinder)
		**sliding seat option adds 0.5" to all seat height dimensions
Seat Depth	16.9" or less fixed, include if adjustable	16.9" (fixed) 16.25" - 19" (adjustable)
Seat Width	18" min	19.75"
Seat Pan Angle (at rest)	0° - 4° rearward	3.5°
Back*		
Backrest Height	12.2" min	22" - 24.5"
Backrest Width	14.2" min	19.25"
Lumbar Support	5.9" - 9.8" (adjustable include part of range)	6.5" - 9.25"
Angle Between Seat and Back	90° - 115°	98°
Tilt Range of Back	10° min	22° (synchro) 12° (swivel)
Arms*		
Armrest Height (fixed)	7.9" - 9.8"	8.2" (fixed); 8" (loop)
Armrest Height (adjustable)	6.9" - 10.8"	7" - 10.5" (height adj.) 7.75" - 10.875" (high perf.)
Inside Distance Between Armrests (fixed)	18" min	18.4" - 20.4" (fixed); 19.7" - 21.9" (loop)
Inside Distance Between Armrests (adjustable)	include 18"	18.4" - 20.4" (height adj.) 18.5" - 20.625" (high perf.)
*All measurements taken with BIFMA Chair Measuring Device using the Universal Measurement Procedure which has a measurement uncertainty of ±5%		
Chair Measurements ***		
A Overall Height		37.1" - 41.75" (plastic base) 36.35" - 40.45" (alum. base)
B Overall Width		29"
C Overall Depth		27" (plastic base); 26.75" (alum. base)
D Fixed Arm Height from Floor		23.75" - 28.5"
Loop Arm Height from Floor		24" - 28.5"
Height Adj. Arm Height from Floor		22.5" - 30.75"
High Perf. Arm Height from Floor		22.875" - 30.5"
E Recline Range		98° - 120° (synchro) 98° - 110° (swivel)
Back Recline Ratio		1:3 (synchro); 1:1 (swivel)
F Base Diameter		27" (plastic); 26.75" (alum. base)
G Weight		46 lbs. (plastic base) 48 lbs. (alum. base)

***standard cylinder; sliding seat option adds 0.5" to overall height and arm height from floor

EWC Sport Task

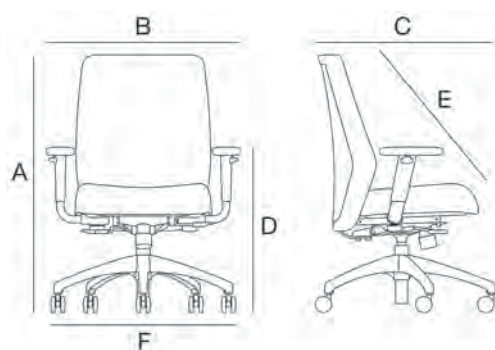

Compliance: ANSI/BIFMA X5.1 : 2002 (U.S. structural standard), BIFMA G1 : 2002 (U.S. ergonomic guidelines), California T.B. 117 (U.S. flammability standard for foam), California T.B. 133 with approved FR textile (U.S. flammability standard for full chair)

The EWC Sport chair line has been tested and is approved for use by individuals weighing up to 300 pounds.

EWC Sport Task Chair Operating Instructions

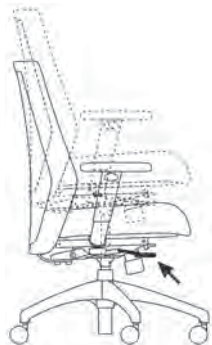

Seat Height

To raise the seat height, remove your weight from the chair while lifting the lever under the right side of the seat. To lower the seat height, lift the lever while sitting in the chair.



Adjustable Arm Width (All arm options)

To adjust the arm width, loosen the knob under the arm support by turning clockwise. Slide the arm support toward or away from the seat to adjust the arm width. Tighten the knob under the arm to secure.



Tilt Lock

To recline, pull out the lever under the right side of the seat. To lock the chair upright, push the lever in.



Height Adjustable Arm (Optional)

To adjust the arm pad height, lift the lever on the outside of the arm support and move the arm up or down. Release the lever to lock.



Tilt Tension

To adjust the tilt tension, turn the knob under the front of the seat. Turn counterclockwise to tighten, and clockwise to loosen.

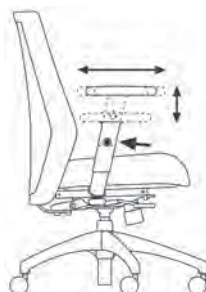

High Performance Arm (Optional)

To adjust the arm pad height, push the button on the outside of the arm support and move the arm up or down. Release the button to lock. To adjust arm pad depth, grasp arm pad and push forward or pull backward. The arm pad adjusts 2.5" in depth.



Back Height (Task chairs only)

To raise the back height, firmly hold both sides of the back and lift. The back height adjusts 9 notches upward. To lower the back height, first raise the back to the highest position; the top notch releases the back to the lowest position.

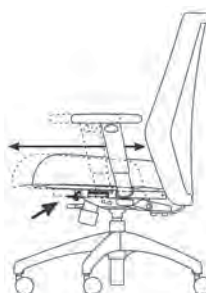

Sliding Seat Depth Adjustment (Optional)

To adjust the seat depth, lift the lever under the left side of the seat and slide the seat to the desired location. Release the lever to lock in one of the 6 positions.

EWC Sport™ Conference Dimensions and Operating Instructions

Seat*	BIFMA G1-2002 Ergonomic Guidelines	EWC Sport Mid-back Conference Ergonomic Dimensions
Seat Height**	15" - 19.9" minimum range (one or combination of chairs)	15.6" - 20.25" (std. cylinder) 14.9" - 19" (alum. base, std. cylinder) 14.4" - 18.5" (low cylinder) **sliding seat option adds 0.5" to all seat height dimensions
Seat Depth	16.9" or less fixed, include if adjustable	16.9" (fixed) 16.25" - 19" (adjustable)
Seat Width	18" min	19.75"
Seat Pan Angle (at rest)	0° - 4° rearward	3.5°
Back*		
Backrest Height	12.2" min	22.75"
Backrest Width	14.2" min	19.25"
Lumbar Support	5.9" - 9.8"	8.25"
Angle Between Seat and Back	90° - 115°	94.8°
Tilt Range of Back	10° min	22° (synchro) 12° (swivel)
Arms*		
Armrests Height (fixed)	7.9" - 9.8"	8" (loop)
Inside Distance Between Armrests (fixed)	18" min	19.7" - 21.9" (loop)

*All measurements taken with BIFMA Chair Measuring Device using the Universal Measurement Procedure which has a measurement uncertainty of ±5%

Chair Measurements***		
A Overall Height		37.1" - 41.75" (plastic base) 36.35" - 40.45" (alum. base)
B Overall Width		29"
C Overall Depth		27" (plastic base); 26.75" (alum. base)
D Loop Arm Height from Floor		24" - 28.8"
E Recline Range		94.8° - 116.8° (synchro) 94.8° - 106.8° (swivel)
Back Recline Ratio		1:3 (synchro); 1:1 (swivel)
F Base Diameter		27" (plastic); 26.75" (alum. base)
G Weight		46 lbs. (plastic base) 48 lbs. (alum. base)

***standard cylinder; sliding seat option adds 0.5" to overall height and arm height from floor

EWC Sport Conference

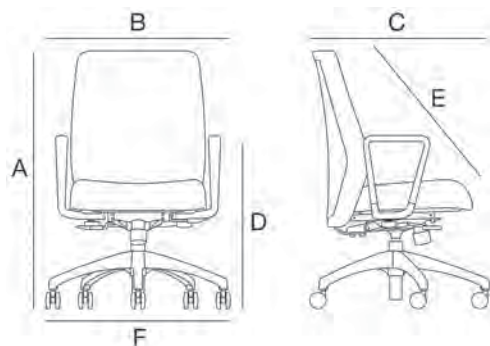

Compliance: ANSI/BIFMA X5.1 : 2002 (U.S. structural standard), BIFMA G1 : 2002 (U.S. ergonomic guidelines), California T.B. 117 (U.S. flammability standard for foam), California T.B. 133 with approved FR textile (U.S. flammability standard for full chair)

The EWC Sport chair line has been tested and is approved for use by individuals weighing up to 300 pounds.

EWC Sport Conference Chair Operating Instructions



Seat Height

To raise the seat height, remove your weight from the chair while lifting the lever under the right side of the seat. To lower the seat height, lift the lever while sitting in the chair.



Adjustable Arm Width

To adjust the arm width, loosen the knob under the arm support by turning clockwise. Slide the arm support toward or away from the seat to adjust the arm width. Tighten the knob under the arm to secure.



Tilt Lock

To recline, pull out the lever under the right side of the seat. To lock the chair upright, push the lever in.

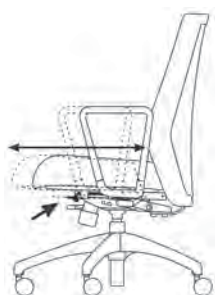

Sliding Seat Depth Adjustment (Optional)

To adjust the seat depth, lift the lever under the left side of the seat and slide the seat to the desired location. Release the lever to lock in one of the 6 positions.



Tilt Tension

To adjust the tilt tension, turn the knob under the front of the seat. Turn counterclockwise to tighten, and clockwise to loosen.

Moment™ side chair

	arm	description	pattern no.
<p><i>Designer(s):</i> Jeffrey Bernett and Nicholas Dodziuk, 2007</p> 	fixed	Cantilevered side chair with painted frame, stacks 4 high on the floor	9-A-SL-S
	9RSEAT	Replacement upholstered seat assembly	9RSEAT

Order Code

<i>Example:</i>	9-A-SL-S-2-AB-K1000/14
9	Moment side chair
A	Arms
SL	Sled base
S	Upholstered seat
2	Black frame finish
AB	Almost Black back
K1000/14	Presto, Black Tie

Example for Cal 133:

9-A-SL-S-2-AB-C-K1000/14-133

Ordering Information

Specify:

1. Pattern number
2. Frame finish color
3. Back color
4. Upholstery selection

Finish Options

Frame:
Select one of the following frame finishes

<i>Code:</i>	<i>Upchg:</i>	<i>Description:</i>
2	n/c	Black
3	n/c	Metallic Grey
4	n/c	Metallic Silver
C	\$150	Trivalent Chrome

Back:
Select one of the following back colors

<i>Code:</i>	<i>Upchg:</i>	<i>Description:</i>
AB	n/c	Almost Black
CH	n/c	Charcoal
RD	n/c	Red
OR	n/c	Orange
WH	n/c	White

list price base grade	grades A	COM B	C	D	E	F	G	H	I	T	COL U	V	W	X	Y
\$485.	\$501.	\$522.	\$530.	\$551.	\$568.	\$584.	\$610.	\$645.	\$660.	\$710.	\$753.	\$845.	\$965.	\$1,017.	\$1,069.
197.	219.	237.	253.	267.	285.	298.	313.	349.	377.	440.	487.	587.	716.	772.	828.

Presto - Base Grade Fabric

Color options:

- Presto, Winter White K1000/1
- Presto, Sand K1000/2
- Presto, Stone K1000/3
- Presto, Saffron K1000/4
- Presto, Spring Green K1000/5
- Presto, Blue Chip K1000/6
- Presto, Scarlet K1000/7
- Presto, Red Carpet K1000/8
- Presto, Beige Taupe K1000/9
- Presto, Olive K1000/10
- Presto, Navy Blue K1000/11
- Presto, Clear Gray K1000/12
- Presto, Charcoal Gray K1000/13
- Presto, Black Tie K1000/14

Textile Options

KnollTextiles fabrics and Spinneybeck leathers:

Please refer to the textile matrices at the beginning of the price list for approved fabrics and leathers.

Cal 133:

See textile matrices at the beginning of the price list for pre-approved Cal 133 textiles. # = Cal 133 pre-approved

Insert C after back color and 133 after upholstery selection

Code: Upchg: Description:

C()133 \$50 Cal 133 compliant textile

Customer's Own

Material/Leather:

See Customer's Own Material Seating Process Overview at the beginning of the price list

COM/COL Textile Requirements

Fabric yards 0.8 yards
Leather square feet 14 sq. ft.

Moment™ Technical and Environmental Information

Dimensions

A. Overall Height	32.5"
B. Overall Width	21"
C. Overall Depth	21"
D. Arm Height from Seat	8.5"
E. Arm Height from Floor	26.25"
F. Seat Height	17.75"
G. Seat Width	19"
H. Seat Depth	17.5"
Weight	24 lbs.

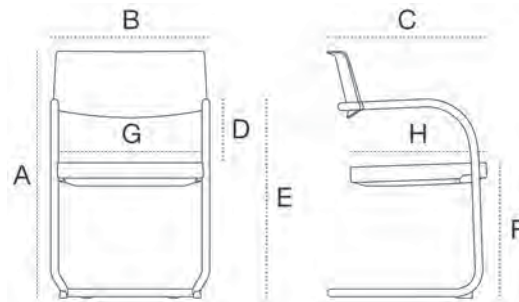

Operating Instructions

Moment stacks up to 4 units high on the floor and features a non-marking cosmetic cover under the seat that reduces fabric wear from stacking.

To stack chairs, place the top chair seat on top of the seat of the chair below. The base of the top chair fits between the legs of the lower chair and rests on top of the lower chair base.

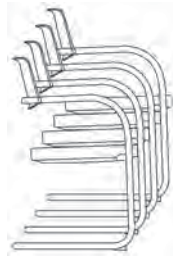

Construction Information

Frame	Powder coat or trivalent chrome over steel
Back structure	Integrally colored, textured, glass reinforced nylon
Back bar	Powder coat or trivalent chrome over aluminum die cast
Seat upholstery plate	Integrally colored polypropylene
Seat cosmetic cover	Integrally colored, textured, impact modified polypropylene
Upholstery	High resiliency molded urethane foam with textile cover
Tip stops and glides	Black, integrally colored, molded nylon
Fasteners and hardware	Steel

Environmental Information

SMaRT®	Moment is SMaRT® Sustainable Gold Certified
GREENGUARD	Moment is GREENGUARD Indoor Air Quality Certified® and GREENGUARD Children & Schools SM
Powder Coat	Knoll metal powder coating processes are 99% VOC-free
Trivalent Chrome	Trivalent chrome uses a safer, more environmentally friendly process to achieve a chrome finish

Compliance: ANSI/BIFMA X5.1 : 2002 (U.S. structural standard), California T.B. 117 (U.S. flammability standard for foam), California T.B. 133 with approved FR textile (U.S. flammability standard for full chair)

The Moment chair has been tested and is approved for use by individuals weighing up to 300 pounds.

This page intentionally left blank.

Alpha-Numeric Index

<i>pattern no.</i>	<i>page</i>	<i>pattern no.</i>	<i>page</i>
11-1-FA-2-S-X-HC	50	77W-MB-2-SY-NA-5-HC	82
11-1-HA-2-S-X-HC	50	77WMIDBACK	100
11-1-HP-2-S-X-HC	50	88C-MB-2-ST-LA-5-HC	112
11-1-NA-2-S-X-HC	50	88C-MB-2-SY-LA-5-HC	110
33-AA-1-BK-B-S-X-HC	58	88S-2-FA-HC	114
33-AA-1-BK-T-S-X-HC	56	88S-2-NA-HC	114
33-AA-2-BK-B-S-X-HC	62	88SBACK	116
33-AA-2-BK-T-S-X-HC	60	88WBACK	116
33-FA-1-BK-B-S-X-HC	58	88W-MB-2-ST-FA-5-HC	108
33-FA-1-BK-T-S-X-HC	56	88W-MB-2-ST-HA-5-HC	108
33-FA-2-BK-B-S-X-HC	62	88W-MB-2-ST-HP-5-HC	108
33-FA-2-BK-T-S-X-HC	60	88W-MB-2-ST-LA-5-HC	108
33-NA-1-BK-B-S-X-HC	58	88W-MB-2-ST-NA-5-HC	108
33-NA-1-BK-T-S-X-HC	56	88W-MB-2-SY-FA-5-HC	106
33-NA-2-BK-B-S-X-HC	62	88W-MB-2-SY-HA-5-HC	106
33-NA-2-BK-T-S-X-HC	60	88W-MB-2-SY-HP-5-HC	106
45A1-A5G-H	26	88W-MB-2-SY-LA-5-HC	106
45A3-A5G-H	24	88W-MB-2-SY-NA-5-HC	106
45C1-A5G-H	26	8A4-2-A5GH	68
45C3-A5G-H	24	8A4-2-A5KH	70
55A-3	30, 32, 34, 36, 38, 40	8A5-2-A5GH	72
55BACKTOPPER	42	8A5-2-A5KH	74
55C-3	30, 32, 34, 36, 38, 40	8C4-2-A5GH	68
55FABRICTOPPER	42	8C4-2-A5KH	70
55H-3	30, 32, 34, 36, 38, 40	8C5-2-A5GH	72
55LUMBAR	42	8C5-2-A5KH	74
55M-3	30, 32, 34, 36, 38, 40	8P4-2-A5GH	68
55P-3	30, 32, 34, 36, 38, 40	8P4-2-A5KH	70
55SEATTOPPER	42	8P5-2-A5GH	72
6A8	76	8P5-2-A5KH	74
6C8	76	8RBACK	68, 70, 72, 74
6RS8	76	8RSEAT	68, 70, 72, 74
77C-HB-2-ST-LA-5-HC	96	8UPHBACK	68, 70, 72, 74
77C-HB-2-SY-LA-5-HC	94	99CMBSPORTBACK	130
77CHIGHBACK	100	99C-MBU-2-ST-LA-5-HC	128
77C-MB-2-ST-LA-5-HC	88	99C-MBU-2-SY-LA-5-HC	126
77C-MB-2-SY-LA-5-HC	86	99WMBSPORTBACK	130
77CMIDBACK	100	99W-MBU-2-ST-FA-5-HC	124
77S-2-FA-HC	98	99W-MBU-2-ST-HA-5-HC	124
77S-2-NA-HC	98	99W-MBU-2-ST-HP-5-HC	124
77SBACK	100	99W-MBU-2-ST-LA-5-HC	124
77W-HB-2-ST-FA-5-HC	92	99W-MBU-2-ST-NA-5-HC	124
77W-HB-2-ST-HA-5-HC	92	99W-MBU-2-SY-FA-5-HC	122
77W-HB-2-ST-HP-5-HC	92	99W-MBU-2-SY-HA-5-HC	122
77W-HB-2-ST-LA-5-HC	92	99W-MBU-2-SY-HP-5-HC	122
77W-HB-2-ST-NA-5-HC	92	99W-MBU-2-SY-LA-5-HC	122
77W-HB-2-SY-FA-5-HC	90	99W-MBU-2-SY-NA-5-HC	122
77W-HB-2-SY-HA-5-HC	90	9-A-SL-S	136
77W-HB-2-SY-HP-5-HC	90	9RSEAT	136
77W-HB-2-SY-LA-5-HC	90	ESSENSIDESEAT	100, 116
77W-HB-2-SY-NA-5-HC	90	ESSENSPORTSEAT	130
77WHIGHBACK	100	ESSENWORKSEAT	100, 116
77W-MB-2-ST-FA-5-HC	84	GENSEAT	50
77W-MB-2-ST-HA-5-HC	84	U	82, 84, 86, 88, 90, 92, 94, 96, 98, 100
77W-MB-2-ST-HP-5-HC	84		
77W-MB-2-ST-LA-5-HC	84		
77W-MB-2-ST-NA-5-HC	84		
77W-MB-2-SY-FA-5-HC	82		
77W-MB-2-SY-HA-5-HC	82		
77W-MB-2-SY-HP-5-HC	82		
77W-MB-2-SY-LA-5-HC	82		

Selling Policy

	<p>This Selling Policy supercedes all previous selling policies. Prices, discounts and product offerings are subject to change without notice.</p>
Terms & Conditions of Sales	<p>Sales by Knoll, Inc. or Knoll North America Corp. ("Seller") of Knoll Product Lines (hereinafter "Products") within the United States and Canada are made only on the terms which are contained in this Selling Policy. Seller hereby gives notice of its objection to any different or additional terms and conditions. This sale is expressly conditional upon Purchaser's assent to the terms and conditions set forth below. Additional terms and conditions may apply to KnollStudio and KnollTextiles orders. These terms and conditions may be modified or supplemented only by a written document signed by an authorized representative of Seller. These terms and conditions supercede any prior and/or contemporaneous agreements or correspondence between Purchaser and Seller. Written quotations expire thirty (30) days from the date of issuance and can be withdrawn by written notice anytime during that period. Where Purchaser and Seller have entered into the Knoll Electronic Terms and Conditions, all orders, acknowledgements, invoices and other business communications placed or transmitted in accordance with the Knoll Electronic Terms and Conditions shall be deemed to be in writing and signed and shall be valid for all purposes as if they were originated and maintained in documentary form.</p>
Ordering Information	<p>All orders must be in writing. The product pattern number(s) contained on Seller's order acknowledgement shall be the final expression of the order.</p>
Order Confirmation	<p>A purchase order is not binding on Seller until Purchaser has received Seller's order confirmation or acknowledgment.</p>
Pricing Policies	<p>List prices are subject to change without notice.</p> <p>List prices shall be those prices in effect on the date of receipt of a complete purchase order unless shipment is requested more than ninety (90) days after order entry in which case prices in effect on the date of shipment apply. List prices include specified freight costs. Unless specified in writing by Seller, no other charges are included in Seller's list prices.</p>
Taxes	<p>All sales, use, excise and other taxes applicable to the sale of the Products shall be paid by Purchaser. If Purchaser claims an exemption from any tax, Purchaser shall submit to Seller the appropriate exemption certificates.</p>
Terms of Payment	<p>Payment for one hundred percent (100%) of the net order amount is due within thirty (30) days of the date of invoice, which is issued upon shipment. In case of any discrepancies, such as shortages, and Seller is notified in writing within ten (10) days of receipt of Product, only that portion may be deducted and the balance paid. For orders greater than \$100,000 net, a fifty percent (50%) deposit is due at the time of order placement, with the remainder due within thirty (30) days of the date of invoice.</p> <p>KnollStudio orders less than \$2,000 require payment for one hundred percent (100%) of the net order amount (including any applicable sales tax and charges for inside delivery, special packaging, etc.), due at time of order placement. For KnollStudio orders greater than \$2,000, a one-half (50%) deposit is due at time of order placement with the remainder (including any applicable sales tax and charges for inside delivery, special packaging, etc.) due prior to shipment.</p> <p>If, in the judgment of Seller, Purchaser's financial condition does not justify the terms of the payment, Seller may require full or partial payment in advance.</p> <p>Past due accounts shall be charged one and one-half percent (1.5%) per month, or the highest rate permitted by law, whichever is less, and will be added to the outstanding balance. In the event Purchaser defaults on payment, Purchaser shall be liable for all collection costs, including reasonable attorney's fees and costs.</p>
Changes and Cancellation	<p>Purchase orders may not be changed or cancelled, in whole or in part, without prior written consent of Seller. Changes may effect delivery dates. Expenses incurred because of changes shall be charged to Purchaser. In the event of cancellations, Purchaser will be liable for reasonable cancellation charges established by Seller. Orders for special Product, orders including "COM" (hereinafter defined) material and orders pursuant to expedited delivery programs, may not be canceled.</p>
Freight Prepaid	<p>Freight is prepaid and included in the price of all Products, except KnollTextiles, within the 48 contiguous United States for orders placed with Knoll, Inc. and within Canada, excluding the Yukon, Northwest Territories, Nunavut and Newfoundland for orders placed with Knoll North America Corp. Packing is tested for rigorous motion and transportation but is not guaranteed to protect furniture from conditions over which the Seller has no control. If special packaging is required for any reason, please consult with your sales representative or dealer. Seller shall select the method of shipment and routing. All shipments shall be tailgate deliveries. Freight for all KnollTextiles orders is prepaid and added to the invoice.</p>
Delivery/Freight Charges	<p>Shipments outside the contiguous 48 United States and Canada shall be shipped F.O.B. Origin.</p> <p>For shipments outside the contiguous United States and Canada, Purchaser is responsible for the cost of freight from point of embarkation, including any handling and transportation charges incidental to loading at the point of departure and unloading at the final destination.</p> <p>Conditions beyond the control of Seller, including weather, available facilities and traffic conditions, may affect exact time of delivery. Seller shall not be responsible for specific carrier delivery date or time unless it has made a specific delivery commitment, in writing.</p> <p>Nonstandard methods of shipment and/or additional services are available upon request. Purchaser will be billed for the differential cost of any special services in excess of standard surface carrier freight costs. Premium charges, at Purchaser's request, will be added for airfreight, exclusive use of vehicle and extra, export or special packaging. Accessorial charges will be added for inside delivery, extra labor, reconsignment and redelivery.</p> <p>Partial shipments may be made and invoiced by Seller.</p>
Claims	<p>All shipments for all Knoll Products within the contiguous United States and Canada are F.O.B. Origin. Risk of loss passes to Purchaser at time of delivery to carrier. Purchaser shall inspect all Products upon receipt and notify Seller within ten (10) working days after receipt of any damage or defects which are, or should be, apparent from an inspection of the Product and its packaging. Failure of Purchaser to make a claim against carrier or notify Seller during the ten (10) working day period shall constitute acceptance of the Products and waiver of any apparent defects, errors or shortages. Seller will agree to repair or replace Product damaged in shipment if Purchaser has notified Seller of freight damage within ten (10) working days after receipt and assigns its rights against the carrier.</p>
Seller's Security Interest	<p>Until Seller receives the full payment for the Product, Seller shall have a security interest in the Product. Purchaser agrees to perform all acts, including but not limited to the execution and filing of documentation, which may be necessary to perfect and assure the security interest of Seller.</p>
Returns	<p>The return of Products without a written authorization by Seller shall not be accepted. To receive authorization for Product return, please call Customer Service. All Products that are returned pursuant to a valid authorization shall be subject to a twenty-five percent (25%) of list restocking charge. Products not currently offered for sale by Seller (including COM) shall not be authorized for return. All returned Products must be unused, in original condition and in the original Seller packing cartons. No refund or credit shall be given for damaged Products.</p>
Held Orders/Storage	<p>If Purchaser requests that an order be held or delayed, prices and terms and conditions in effect at the time of shipment shall apply. If Purchaser requests a delay after the time when Seller can defer production, Purchaser will be invoiced for the Product, payable in accordance with standard terms, when the order is ready for shipment. Seller may transfer the Product to storage, in which case all expenses incurred in connection with storage, including demurrage, preparation for storage, storage charges and handling shall be payable by Purchaser upon submission of invoices by Seller. Risk of loss to the Product shall pass to the Purchaser upon delivery of the Product into storage.</p>

Selling Policy

Customer's Own Material	<p>A Purchaser who requests a fabric or other surface material not standard to Seller's line of Products ("COM") must submit samples of the requested material to Seller prior to entry of a purchaser order. Seller shall determine if the material is suitable to its manufacturing processes and meets any requirements of Underwriters Laboratories. If the COM is acceptable, Seller will then establish a price for using the COM or the Product in question. For a description of the procedures for submitting samples and testing, contact customer resources or your sales representative. Seller shall have no responsibility for the appearance, condition, performance, durability, colorfastness or any other physical attribute of the COM. Purchaser shall indemnify and hold Seller harmless for any damages, injuries or losses arising out of or related to use of the COM on the Product.</p>
Warranty	<p>Seller warrants to the original Purchaser only that the Products Seller manufactures and sells to Purchaser are free of defects in workmanship and materials, during the applicable warranty period set forth below.</p> <p>Warranty period set forth below is for 24-hour, 7 days a week, multi shift use.</p> <p>Should any failure to conform with this limited warranty appear to a Product listed below during the applicable warranty period from the date of shipment, Seller shall, upon prompt written notice, repair or replace, at its option and costs, the affected part or parts.</p> <p><i>Product and Period of Warranty</i></p> <p><i>Lifetime: AutoStrada, Calibre, Crinion Open Table, Currents, Dividends Horizon, Equity, Morrison, Reff laminate, Series 2 Storage, Template, Antenna Workspaces</i> and other non-wood components (except cascade edge worksurfaces, operational parts, controls, electrical, Lighting, <i>Series 2 Veneer Front Storage</i>, special or custom products, see below)</p> <p><i>10 Years: AutoStrada, Crinion Open Table, Reff</i> wood components, <i>Series 2 Veneer Front Storage, Antenna Workspaces</i> wood components, <i>Wood Casegoods (Magnusson, The Graham Collection)</i> (except wood casegoods upholstered surfaces, see below), <i>Interaction</i> tables (except height adjustment mechanisms for <i>Counterforce</i>, crank-adjustable, and split-top tables and worksurfaces, see below), <i>Reuter</i> overheads, <i>Reuter</i> vertical storage, <i>KnollExtra</i> Sapper Monitor Arm Collection, Adjustable keyboard mechanisms and platforms, Communication Boards (except fabric board textiles, see below), Smokador collection (except leathers, see below), and Orchestra Universal Systems Accessories, <i>Bulldog, Chadwick, Essentials Work Chairs, Generation by Knoll</i> work chair, <i>Life, Moment, RPM</i> and <i>Sapper</i> seating structural and operational parts, controls, casters, pneumatic cylinders, seat and back suspension material (except seating upholstery, textiles and leathers, finishes and labor, see below). Labor to repair <i>Generation by Knoll</i> work chair.</p> <p><i>5 Years:</i> Operational parts, controls, electrical, Lighting (except light ballasts, bulbs and power supply, see below), cascade edge worksurfaces, special or custom product, wood veneer products, <i>Currents</i> handcrank, <i>Interaction Counterforce, Interaction</i> crank-adjustable, and split-top mechanisms, <i>KnollStudio, KnollExtra</i> Wishbone and Zorro monitor supports, CPU storage and all universal storage drawers, <i>Spark Series</i> seating structural parts, (except seating upholstery, textiles, finishes and labor, see below).</p> <p><i>3 Years: Bulldog, Chadwick, Essentials Work Chairs, Life, Moment, RPM, Sapper</i> seating upholstery, textiles and leathers, finishes and labor to repair, <i>Generation by Knoll</i> work chair seating upholstery, textiles and leathers, and finishes, <i>Spark Series</i> seating upholstery and textiles. Fabric boards textiles and Smokador Collection leathers.</p> <p><i>2 Years:</i> All other <i>KnollExtra</i> product</p> <p><i>1 Year:</i> Light ballasts, bulbs and power supply, seating upholstered arm pads and soft arm pads, <i>Spark Series</i> seating finishes and labor to repair, wood casegoods upholstered surfaces.</p> <p>This warranty does not apply to:</p> <ul style="list-style-type: none">• Damage caused by a carrier other than the Seller.• Normal wear and tear or acts or omissions of parties other than Seller (including user modification, improper use or installation of Products).• COM or other third party materials applied to Products.• Products not installed by or under the auspices of a Knoll Dealer.• Dramatic temperature variations or exposure to unusual conditions.• Except as specifically noted above, textiles and upholstery supplied by <i>KnollTextiles</i> (consult current <i>KnollTextiles</i> price list for applicable warranty). <p>Natural variations occurring in wood, marble, and leather shall not be considered defects, and the Seller does not guarantee the colorfastness or matching of the colors, grains or textures, or surface hardness of such materials. The Seller also does not guarantee the colorfastness of fiberglass panel surfaces.</p> <p>THE EXPRESS WARRANTIES CONTAINED HEREIN ARE IN LIEU OF ALL OTHER WARRANTIES, EXPRESS OR IMPLIED, INCLUDING ANY WARRANTIES OF MERCHANTABILITY AND FITNESS FOR PARTICULAR PURPOSE AND ALL OTHER WARRANTIES ARISING FROM COURSE OF DEALING OR USAGE OF TRADE.</p> <p>The remedies provided above are the Purchaser's sole remedies for any failure of Seller to comply with its obligations regarding the workmanship of its Products. Correction of any nonconformity in the manner and for the period of time provided shall constitute complete fulfillment of all liabilities of Seller, with respect to or arising out of the Product furnished hereunder.</p>
Delay/Force Majeure	<p>Seller shall not be liable for failure to perform or for delay in performance due to fire, flood, strike or other labor difficulty, act of God, act of any governmental authority or of the Purchaser, riot, embargo, fuel or energy shortage, wrecks or delay in transportation, inability to obtain necessary labor, materials or manufacturing facilities from usual sources or failure of suppliers to meet their contractual obligations, or due to any cause beyond its reasonable control. If any such event occurs, Seller may extend delivery dates by a period of time necessary to overcome the effect of such delay, allocate available Product or cancel any purchase order.</p>
Compliance with Law	<p>PURCHASER IS SOLELY RESPONSIBLE FOR COMPLIANCE WITH ALL APPLICABLE FEDERAL, STATE AND LOCAL LAWS, ORDINANCES, REGULATIONS, RULES AND STANDARDS RELATING TO THE INSTALLATION, MAINTENANCE, USE AND OPERATION OF THE PRODUCTS.</p>
Patents	<p>Subject to the following provisions, Seller shall, at its own expense, defend or, at its option, settle any claim, suit or proceeding brought against the Purchaser, and/or its vendees, mediate and immediate, so far as based on an allegation that any Product or any part thereof furnished hereunder constitutes a direct or a contributory infringement of any claim of any patent of the United States or Canada. This obligation shall be effective only if Purchaser shall have made all payments then due hereunder and if Seller is notified promptly in writing and given authority, information and assistance for the defense of said claim, suit or proceeding. Seller shall pay all damages and costs awarded in such suit or proceedings so defended.</p> <p>The foregoing indemnity does not apply to the following:</p> <ul style="list-style-type: none">• Products supplied according to a design other than that of Seller, and which is required by the Purchaser.• Combination of the Product with another product not furnished hereunder unless Seller is a contributory infringer.• Any settlements of a suit or proceeding made without Seller's written consent.
Limitations of Liability	<p>SELLER, ITS CONTRACTORS, AUTHORIZED DEALERS AND SUBCONTRACTORS OR SUPPLIERS OF ANY TIER SHALL NOT BE LIABLE TO PURCHASER FOR ANY SPECIAL, INDIRECT, INCIDENTAL OR CONSEQUENTIAL DAMAGES ARISING FROM A BREACH OF THIS AGREEMENT.</p> <p>Purchaser's remedies set forth herein are exclusive and the liability of Seller with respect to the breach of this agreement or any contract entered into between the parties pursuant hereto shall not exceed the price of the Product or part on which such liability is based.</p>

General Ordering Information

The Products

This guide encompasses all standard products for this product group.

Sizes

Dimensions listed in this guide are indicated as:

H = height

W = width

D = depth

Dia. = diameter

Rad. = radius

Pricing

All prices shown are list.

How to Order

Select pattern numbers and quantities required for your complete installation. Product questions can be addressed in the specific sections of this guide or by contacting your sales representative or customer resource representative at 1-800-343-5665.

Next, select options (if required), along with colors and finishes appropriate to each product. Reference the Finishes and Fabrics pages for color designations.

On large installations, an item's "designated area" can be specified to assist in product organization and handling.

To expedite complete / correct entry of your order, be certain all pattern numbers, quantities, colors and area identifications are completely specified. Also, include complete purchase order numbers, bill-to and ship-to addresses, a contact name and specific factory shipping dates required.

Mail all orders to:

Knoll, Inc.

1235 Water Street

P.O. Box 157

East Greenville, PA 18041

Attention: Order Entry

Once your order is entered at Knoll, an acknowledgment will be mailed to you. You will be advised of your scheduled shipping date within five days of the original acknowledgment. If it is necessary to revise your order, please contact your customer resource representative.

Sustainability Statement

Sustainable design is a key component of Knoll's environmental focus. Our commitment to social responsibility and a healthy environment has prompted us to further articulate our longstanding environmental programs and, with encouragement and support from our colleagues in the industry, we have re-energized our focus on such "green" initiatives as life cycle analysis and LEED™ certification. Knoll is proud to have contributed to projects that have received LEED certification from the U.S. Green Building Council.

For the latest information on Knoll products that help our customers achieve LEED certification, log on to knoll.com, click on "About Knoll" and then "Environmental Focus."