

|   |  |    |
|---|--|----|
| Introduction  | <a href="#">Introduction &gt;&gt;</a>  | 2  |
|   | <a href="#">Specifications &gt;&gt;</a>  | 3  |
|   | <a href="#">Crinion Open Table Finishes &gt;&gt;</a>                                   | 4  |
| Worksurfaces  | <a href="#">Worksurfaces with center hinged power access &gt;&gt;</a>                  | 5  |
|   | <a href="#">Worksurfaces with edge grommet &gt;&gt;</a>                                | 6  |
|   | <a href="#">Worksurfaces with cord drop &gt;&gt;</a>                                   | 7  |
|   | <a href="#">End counters &gt;&gt;</a>  | 8  |
|   | <a href="#">Extended end counters &gt;&gt;</a>   | 9  |
| Complete base assemblies                              | <a href="#">Complete base assemblies fixed height 24" D dual &gt;&gt;</a>              | 10 |
|   | <a href="#">Complete base assemblies fixed height 24" D single sided &gt;&gt;</a>      | 11 |
|   | <a href="#">Complete base assemblies fixed height 30" D dual &gt;&gt;</a>              | 12 |
|   | <a href="#">Complete base assemblies fixed height 30" D single sided &gt;&gt;</a>      | 13 |
|   | <a href="#">Complete base assemblies adjustable height 30" D dual &gt;&gt;</a>         | 14 |
|   | <a href="#">Complete base assemblies adjustable height 30" D single sided &gt;&gt;</a> | 15 |
|   | <a href="#">Complete base assemblies fixed height 36" D dual &gt;&gt;</a>              | 16 |
|   | <a href="#">Complete base assemblies fixed height 36" D single sided &gt;&gt;</a>      | 17 |
|   | <a href="#">Complete base assemblies adjustable height 36" D dual &gt;&gt;</a>         | 18 |
|   | <a href="#">Complete base assemblies adjustable height 36" D single sided &gt;&gt;</a> | 19 |
| Base components                                       | <a href="#">Top channels &gt;&gt;</a>  | 20 |
|   | <a href="#">Beams for single sided or dual tables &gt;&gt;</a>                         | 21 |
|   | <a href="#">Beams for dual tables &gt;&gt;</a>   | 22 |
|   | <a href="#">Beams for single sided tables &gt;&gt;</a>                                 | 23 |
|   | <a href="#">End legs, intermediate leg sets for dual tables &gt;&gt;</a>               | 24 |
|   | <a href="#">End legs, intermediate leg sets for single sided tables &gt;&gt;</a>       | 26 |
|   | <a href="#">Beam trusses &gt;&gt;</a>  | 27 |
|   | <a href="#">Worksurface support &gt;&gt;</a>   | 28 |
| Power components                                      | <a href="#">Modular Raceway &gt;&gt;</a>   | 30 |
|   | <a href="#">Hardwire Raceway &gt;&gt;</a>  | 34 |
|   | <a href="#">Cable tray and cable clips &gt;&gt;</a>                                    | 35 |
| Screens   | <a href="#">Center screens &gt;&gt;</a>  | 36 |
|   | <a href="#">Side screens &gt;&gt;</a>  | 37 |
|   | <a href="#">Dual end screens &gt;&gt;</a>  | 38 |
|   | <a href="#">Single sided end screen &gt;&gt;</a>                                       | 39 |
|   | <a href="#">Frameless glass Add up &gt;&gt;</a>  | 40 |
|   | <a href="#">Original Crinion privacy screens &gt;&gt;</a>                              | 41 |
|   | <a href="#">Morrison Network privacy screens &gt;&gt;</a>                              | 42 |
| File tops   | <a href="#">File tops &gt;&gt;</a>   | 43 |
| <a href="#">Alpha-Numeric Index &gt;&gt;</a>          |  | 44 |
| <a href="#">Selling Policy &gt;&gt;</a>               |  | 46 |
| <a href="#">General Ordering Information &gt;&gt;</a> |  | 48 |

This Order Guide provides basic planning, specifications and pricing information for Crinion Open Tables.

Refer to KnollExtra price list for compatible accessories such as flat screen monitor supports, task lights, paper management accessories, keyboard and storage drawers.

Refer to Calibre, Reff or Currents price lists for shared and individual storage options. Additional information can be found at [www.knoll.com](http://www.knoll.com).

Crinion Open Table is the straightforward alternative for open, collaborative work environments. The table accommodates a group of four to eight or more at a continuous work surface.

Crinion Open Table typically consists of deep worksurfaces end-to-end and back-to-back, cantilever supported by parallel beams between end legs. The beams form a technology corridor for flat screen monitor supports, outlets and power/data distribution. Also available is a single-sided configuration, with a single main beam and a smaller back beam.

Above the center of the table are optional privacy screens in tackable fabric, translucent or slatwall surfaces.

Crinion Open Table is appropriate for libraries and education environments, laboratories, finance and trading desks, teaming areas and design offices.

Crinion Open Table is unique in offering individual height-adjustability and extraordinarily deep worksurfaces. Overall dual table depth is 48", 60" or 72".

The table structure is strong enough to span 16 feet between end legs or intermediate supports to build tables of any length.

The continuous worksurfaces and clear kneespace enable varying numbers of workers to sit on each side. Storage is typically separated from the table in parallel, shared file-and-storage islands.

Crinion is distinguished by a minimalist, modern design, and details like square or tapered edge worksurfaces, plastic laminate, Techwood or natural veneers, and aluminum fittings.

Crinion Open Table simplifies the planning and specifications of an open office, and it can make a dramatic visual and functional statement of collaboration.

The quality and classic design of Crinion work well in virtually any interior.

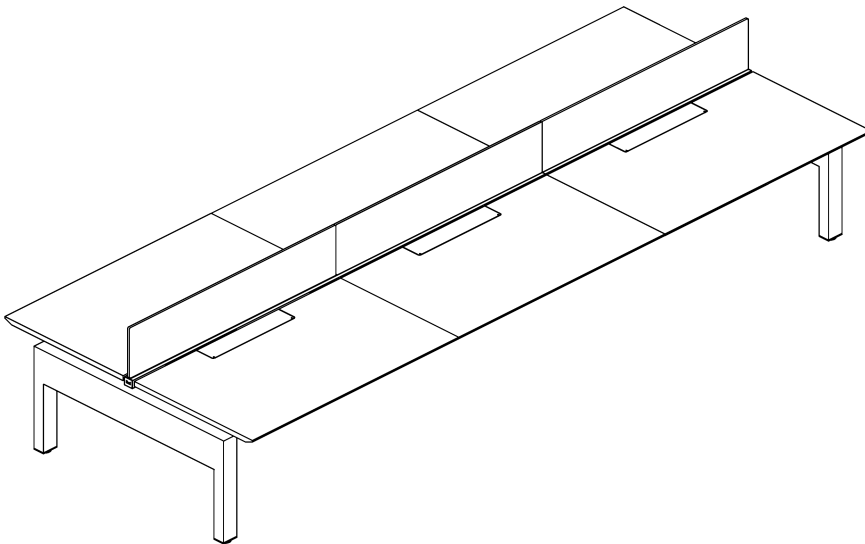

Crinion Open Tables are comprised of worksurfaces, table base assemblies, power components and screens.

### Worksurfaces

Individual worksurfaces are available in four standard widths (48", 60", 72", 96") and three depths (nominal 24", 30", 36"), which may be combined to form single-sided or dual-sided groups of two to ten or more positions.

#### Worksurface edge options

Worksurfaces are 1 1/4" thick, with three front edge options: Tapered edge, laminate, veneer or mixed.

Square edge, veneer

Postformed edge, laminate only

### Power and accessory options

Worksurfaces may be specified with hinged power access door and continuous 1/2" cord drop, or edge grommet and continuous cord drop, or just cord drop.

Hinged power access door is 24"W and 5"D, centered on worksurface width. Door hinges toward user for continuity between access opening and cord drop.

Any worksurface (except end counters) accepts clamp on KnollExtra accessories such as flat screen monitor arm or task light.

#### Other worksurface types

End counters have front edge detail on side edges as well and are designed to extend dual tables 24" or 30" beyond the endleg. End counters also include 3" wide center grommet. Extended end counters are 36"D surfaces with center grommet or hinged power access door. Base of the table must be extended 12" under the back of each extended end counter (although top channels should be specified only as wide as the worksurfaces on each side of the table).

All end counters must be supported by end counter cantilevers and endlegs for end counters.

#### Worksurface heights

Fixed height cantilevers support worksurfaces at 28 1/2"H, with 27" clear below the top (except directly below cantilevers).

Adjustable height cantilevers enable worksurfaces to be independently set at 27", 27 3/4", 28 1/2", 29 1/4", or 30"H.

### Open Table base assemblies

Complete base assemblies simplify specifications for most common configurations of dual or single-sided open tables. Base assemblies include top channels and end caps, beams, end legs and intermediate legs (where required), trusses and top channel supports, cantilever brackets (specify fixed or adjustable height) and midspan supports. Specify worksurfaces, screens, power components, cable trays and accessories separately.

Complete base assemblies are available for the following typical tables, combinations of 60" or 72" worksurfaces.

*Single-sided or dual, 24"D, 30"D, or 36"D, with continuous beam span between end legs*

10' W two/four positions 60"W

12' W two/four positions 72"W

15' W three/six positions 60"W

*Single sided or dual 24"D, 30"D, or 36"D, with intermediate leg*

18' W three/six positions 72"W

20' W four/eight positions 60"W

24' W four/eight positions 72"W

25' W five/ten positions 60"W

### Open Table base components

Base assemblies may also be specified by individual components to create configurations other than those listed above, or to create tables with end counters or frameless glass add ups.

In addition to worksurfaces Open tables require top channel, starter beams for spans up to 15', extension beams for additional spans of 4' to 15', intermediate legs every 16' or less, two end legs, trusses at every worksurface junction and at each end leg. Adjustable tables require two cantilevers per worksurface (or three for 96"W). Fixed height tables may be supported by a fixed height cantilever at each end, shared cantilevers at each worksurface joint, and a midspan support bracket at the center of each worksurface greater than 48" wide. For 96"W worksurfaces the midspan support should be a 24"D cantilever. Power components, cable trays and screens are optional.

### Power distribution

Optional modular raceway distributes 2+2 four circuit or 3+3 six circuit configuration from a single point of supply. Bundles of cables can be managed from the floor in a cable infeed shroud located at any intermediate leg. Raceway provides power outlets and data/communications outlet openings on one or both sides, accessed through hinged access doors in worksurfaces or from under table. Specify 30" raceway for two duplex outlets each side or 42" raceway for four duplex outlets each side. Duplex outlets, power infeed and jumpers between raceways must be specified separately.

### Privacy screens

There are four screen options for Crinion Open Table.

The standard screens are 14"H (42" horizon) or 21"H (49" horizon) in acrylic, slatwall or combination surfaces. Center screens include mounting hardware to attach to the standard top channel. Center screens are available full width, 48", 60" or 72", or shorter by 1" to leave space at either end of the table for a dual end screen. Side screens attach to the front and back of a worksurface at any point other than at a hinged access door. Mounting brackets are specified separately to correspond to each worksurface edge detail. Dual end screens span across the end of a table (or above an end counter) from worksurface front edges.

Frameless glass add ups are available in 12" height only, 48", 60", and 72"W. Add ups can only mount to a top channel for frameless glass add ups, which may be at the center of a dual table or back of a single-sided table.

Original Crinion privacy screens are 12"H or 19"H (41" or 48" horizons) and mount to a standard top channel only.

Morrison Network fabric screens (15"H or 22"H) can also be mounted to the standard top channel with Crinion Open Table mast kit.

### Accessories and storage

All Crinion worksurfaces accept clamp base KnollExtra flat screen monitor arms and task lights at any point except behind the hinged power access door. Worksurfaces also accept suspended accessories like adjustable keyboard supports, BackPack center file or keyboard drawers, or CPU holders. Beam location under most tables prevents pedestals deeper than 20" underneath. However 36"D tops can be planned on 30"D table bases to create additional kneespace depth and room for 24"D pedestals.

Crinion Open Table file tops are available for 27"H Calibre files positioned perpendicular to the table to act as returns. Tapered front and back edges assure consistent detail with tapered worksurface edges. File tops are also available for pairs of files and back to back files.

## Finishes

### L - Laminate

117 Soft Grey  
 118 Bright White  
 114 Folkstone Grey  
 111 Jet Black  
 119 Pumice

### V1 - Techwood Closed Pore

Y319 Cherry  
 Y326 Dark Mahogany  
 Y316 Maple  
 Y323 Medium Walnut  
 Y311 Beech  
 Y324 Ash  
 Y325 Chestnut  
 Y327 Light Oak  
 Y328 Mahogany  
 Y329 Medium Oak

### V1 - Techwood Open Pore

Y111 Beech  
 Y116 Maple  
 Y119 Cherry  
 Y123 Medium Walnut  
 Y124 Ash  
 Y125 Chestnut  
 Y126 Dark Mahogany  
 Y127 Light Oak  
 Y128 Mahogany  
 Y129 Medium Oak  
 Y131 Ebonized Black

### V2 – Natural veneer

V312 Bronzed Cherry  
 V313 Burnt Walnut  
 V316 Light Maple  
 V311 Beech  
 V314 Dark Cherry  
 V315 Light Cherry  
 V318 Mahogany on Walnut  
 V319 Medium Cherry  
 V323 Medium Walnut on Walnut  
 V342 Qtr. cut/slip match Bronzed Cherry  
 V344 Qtr. cut/slip match Dark Cherry  
 V345 Qtr. cut/slip match Light Cherry  
 V349 Qtr. cut/slip match Medium Cherry

### V3 – Exotic veneer

V512 Quartered Figured Anigre  
 V514 Quartered Makore  
 V515 Quartered Sycamore  
 V513 Quartered Graphite Oak  
 V516 Quartered Whitened Oak

## Paint

### P1

111 Jet Black  
 112 Brown  
 113 Dark Grey  
 114 Folkstone Grey  
 115 Medium Grey  
 116 Sandstone  
 117 Soft Grey

### P2

611 Beige Mist Metallic  
 612 Medium Metallic Grey

### P3

118 Bright White  
 613 Silver

### Anodized

AA Anodized Aluminum

### Glass

TEMP Clear Tempered

### Acrylic

O Opal translucent

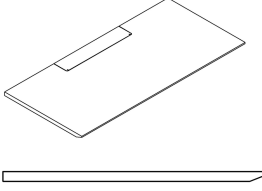
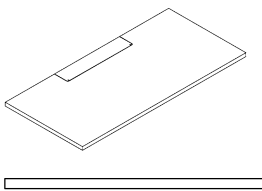
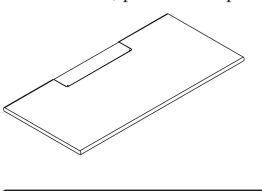
| description  | nominal depth  | w   | d   | h      | pattern number            | L                     | M      | V1     | V2     | V3       |      |
|--|--|-----|-----|--------|---------------------------|-----------------------|--------|--------|--------|----------|------|
| Worksurface, tapered edge<br>         | 24"  | 48" | 22" | 1 1/4" | XTTK4824A (L/M/1/2/3) ( ) | \$673.                | \$782. | \$782. | \$856. | \$1,030. |      |
|  | 24"  | 60" | 22" | 1 1/4" | XTTK6024A (L/M/1/2/3) ( ) | 698.                  | 854.   | 854.   | 940.   | 1,139.   |      |
|  | 24"  | 72" | 22" | 1 1/4" | XTTK7224A (L/M/1/2/3) ( ) | 744.                  | 900.   | 900.   | 996.   | 1,213.   |      |
|  | 24"  | 96" | 22" | 1 1/4" | XTTK9624A (L/M/1/2/3) ( ) | 826.                  | 1,014. | 1,014. | 1,128. | 1,384.   |      |
|  | 30"  | 48" | 28" | 1 1/4" | XTTK4830A (L/M/1/2/3) ( ) | 683.                  | 846.   | 846.   | 932.   | 1,130.   |      |
|  | 30"  | 60" | 28" | 1 1/4" | XTTK6030A (L/M/1/2/3) ( ) | 719.                  | 914.   | 914.   | 1,009. | 1,229.   |      |
|  | 30"  | 72" | 28" | 1 1/4" | XTTK7230A (L/M/1/2/3) ( ) | 768.                  | 945.   | 945.   | 1,045. | 1,276.   |      |
|  | 30"  | 96" | 28" | 1 1/4" | XTTK9630A (L/M/1/2/3) ( ) | 855.                  | 1,066. | 1,066. | 1,185. | 1,457.   |      |
|  | 36"  | 48" | 34" | 1 1/4" | XTTK4836A (L/M/1/2/3) ( ) | 715.                  | 919.   | 919.   | 1,019. | 1,243.   |      |
|  | 36"  | 60" | 34" | 1 1/4" | XTTK6036A (L/M/1/2/3) ( ) | 735.                  | 982.   | 982.   | 1,087. | 1,329.   |      |
|  | 36"  | 72" | 34" | 1 1/4" | XTTK7236A (L/M/1/2/3) ( ) | 800.                  | 993.   | 993.   | 1,097. | 1,343.   |      |
|  | 36"  | 96" | 34" | 1 1/4" | XTTK9636A (L/M/1/2/3) ( ) | 908.                  | 1,120. | 1,120. | 1,246. | 1,537.   |      |
|  | Worksurface, veneer square edge<br> | 24" | 48" | 22"    | 1 1/4"                    | XTTS4824A (1/2/3) ( ) | n/a    | n/a    | 643.   | 706.     | 790. |
|  |  | 24" | 60" | 22"    | 1 1/4"                    | XTTS6024A (1/2/3) ( ) | n/a    | n/a    | 674.   | 737.     | 832. |
| 24"  |  | 72" | 22" | 1 1/4" | XTTS7224A (1/2/3) ( )     | n/a                   | n/a    | 706.   | 769.   | 874.     |      |
| 24"  |  | 96" | 22" | 1 1/4" | XTTS9624A (1/2/3) ( )     | n/a                   | n/a    | 758.   | 821.   | 947.     |      |
| 30"  |  | 48" | 28" | 1 1/4" | XTTS4830A (1/2/3) ( )     | n/a                   | n/a    | 737.   | 800.   | 905.     |      |
| 30"  |  | 60" | 28" | 1 1/4" | XTTS6030A (1/2/3) ( )     | n/a                   | n/a    | 758.   | 826.   | 948.     |      |
| 30"  |  | 72" | 28" | 1 1/4" | XTTS7230A (1/2/3) ( )     | n/a                   | n/a    | 779.   | 853.   | 1,029.   |      |
| 30"  |  | 96" | 28" | 1 1/4" | XTTS9630A (1/2/3) ( )     | n/a                   | n/a    | 821.   | 905.   | 1,168.   |      |
| 36"  |  | 48" | 34" | 1 1/4" | XTTS4836A (1/2/3) ( )     | n/a                   | n/a    | 800.   | 879.   | 1,010.   |      |
| 36"  |  | 60" | 34" | 1 1/4" | XTTS6036A (1/2/3) ( )     | n/a                   | n/a    | 832.   | 910.   | 1,034.   |      |
| 36"  |  | 72" | 34" | 1 1/4" | XTTS7236A (1/2/3) ( )     | n/a                   | n/a    | 863.   | 958.   | 1,131.   |      |
| 36"  |  | 96" | 34" | 1 1/4" | XTTS9636A (1/2/3) ( )     | n/a                   | n/a    | 926.   | 1,052. | 1,304.   |      |
| Worksurface, postformed plastic<br> |  | 24" | 48" | 22"    | 1 1/4"                    | XTPP4824A (L) ( )     | 499.   | n/a    | n/a    | n/a      | n/a  |
|  |  | 24" | 60" | 22"    | 1 1/4"                    | XTPP6024A (L) ( )     | 566.   | n/a    | n/a    | n/a      | n/a  |
|  | 24"  | 72" | 22" | 1 1/4" | XTPP7224A (L) ( )         | 618.                  | n/a    | n/a    | n/a    | n/a      |      |
|  | 24"  | 96" | 22" | 1 1/4" | XTPP9624A (L) ( )         | 675.                  | n/a    | n/a    | n/a    | n/a      |      |
|  | 30"  | 48" | 28" | 1 1/4" | XTPP4830A (L) ( )         | 519.                  | n/a    | n/a    | n/a    | n/a      |      |
|  | 30"  | 60" | 28" | 1 1/4" | XTPP6030A (L) ( )         | 592.                  | n/a    | n/a    | n/a    | n/a      |      |
|  | 30"  | 72" | 28" | 1 1/4" | XTPP7230A (L) ( )         | 649.                  | n/a    | n/a    | n/a    | n/a      |      |
|  | 30"  | 96" | 28" | 1 1/4" | XTPP9630A (L) ( )         | 717.                  | n/a    | n/a    | n/a    | n/a      |      |
|  | 36"  | 48" | 34" | 1 1/4" | XTPP4836A (L) ( )         | 545.                  | n/a    | n/a    | n/a    | n/a      |      |
|  | 36"  | 60" | 34" | 1 1/4" | XTPP6036A (L) ( )         | 649.                  | n/a    | n/a    | n/a    | n/a      |      |
|  | 36"  | 72" | 34" | 1 1/4" | XTPP7236A (L) ( )         | 701.                  | n/a    | n/a    | n/a    | n/a      |      |
|  | 36"  | 96" | 34" | 1 1/4" | XTPP9636A (L) ( )         | 774.                  | n/a    | n/a    | n/a    | n/a      |      |

| Order Code                               | Specifications   | Application Notes   |
|--|--|---|
| Example: <b>XTPP6030AL 118</b>           |  |   |
| <b>XT</b> Crinon Open Table              | Worksurfaces are 1 1/4" thick with square edge or tapered edge option tapering to 1/2" thick front edge. | Crinon 30"D worksurfaces correspond in width to table bases, which are specified separately.  |
| <b>T</b> Worksurface                     |  | 48"W worksurfaces plan on 12' wide or 20' wide bases. 60"W worksurfaces plan on 5', 10', 15' and 20' wide bases. 72" W worksurfaces plan on 6', 12' and 18' wide bases. |
| <b>P</b> Postformed plastic              | Specify finishes:<br>L - Laminate<br>M - Laminate/veneer edge  | Power access door is 24" wide, 5" deep, centered at back edge of worksurface.   |
| <b>60</b> Width                          | 1 - Veneer group 1<br>2 - Veneer group 2   | Continous 1/2" wire drop accommodates clamp-on flat screen monitor arm or most power cords plugs.   |
| <b>30</b> Depth                          | 3 - Veneer group 3   | Actual worksurface depth is 22.35", 28.35" or 34.35".   |
| <b>A</b> With center hinged power access |  | Worksurfaces with hinged power access enable access to suspended modular raceway.   |
| <b>L</b> Finish Type                     |  |   |
| <b>118</b> Surface                       |  |   |

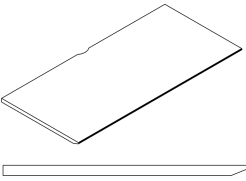
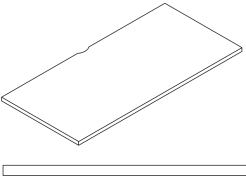
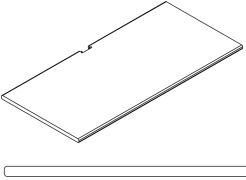
| description  | nominal depth  | w   | d   | h      | pattern number                   | L                            | M      | V1     | V2     | V3     |
|--|--|-----|-----|--------|----------------------------------|------------------------------|--------|--------|--------|--------|
| Worksurface, tapered edge<br>         | 24"  | 48" | 22" | 1 1/4" | <b>XTTK4824B (L/M/1/2/3) ( )</b> | \$428.                       | \$537. | \$537. | \$611. | \$785. |
|  | 24"  | 60" | 22" | 1 1/4" | <b>XTTK6024B (L/M/1/2/3) ( )</b> | 453.                         | 609.   | 609.   | 695.   | 894.   |
|  | 24"  | 72" | 22" | 1 1/4" | <b>XTTK7224B (L/M/1/2/3) ( )</b> | 499.                         | 655.   | 655.   | 751.   | 968.   |
|  | 24"  | 96" | 22" | 1 1/4" | <b>XTTK9624B (L/M/1/2/3) ( )</b> | 581.                         | 769.   | 769.   | 883.   | 1,139. |
|  | 30"  | 48" | 28" | 1 1/4" | <b>XTTK4830B (L/M/1/2/3) ( )</b> | 438.                         | 601.   | 601.   | 687.   | 885.   |
|  | 30"  | 60" | 28" | 1 1/4" | <b>XTTK6030B (L/M/1/2/3) ( )</b> | 474.                         | 669.   | 669.   | 764.   | 984.   |
|  | 30"  | 72" | 28" | 1 1/4" | <b>XTTK7230B (L/M/1/2/3) ( )</b> | 523.                         | 700.   | 700.   | 800.   | 1,031. |
|  | 30"  | 96" | 28" | 1 1/4" | <b>XTTK9630B (L/M/1/2/3) ( )</b> | 610.                         | 821.   | 821.   | 940.   | 1,212. |
|  | 36"  | 48" | 34" | 1 1/4" | <b>XTTK4836B (L/M/1/2/3) ( )</b> | 470.                         | 674.   | 674.   | 774.   | 998.   |
|  | 36"  | 60" | 34" | 1 1/4" | <b>XTTK6036B (L/M/1/2/3) ( )</b> | 490.                         | 737.   | 737.   | 842.   | 1,084. |
|  | 36"  | 72" | 34" | 1 1/4" | <b>XTTK7236B (L/M/1/2/3) ( )</b> | 555.                         | 748.   | 748.   | 852.   | 1,098. |
|  | 36"  | 96" | 34" | 1 1/4" | <b>XTTK9636B (L/M/1/2/3) ( )</b> | 663.                         | 875.   | 875.   | 1,001. | 1,292. |
|  | Worksurface, veneer square edge<br> | 24" | 48" | 22"    | 1 1/4"                           | <b>XTTS4824B (1/2/3) ( )</b> | n/a    | n/a    | 398.   | 461.   |
| 24"  |  | 60" | 22" | 1 1/4" | <b>XTTS6024B (1/2/3) ( )</b>     | n/a                          | n/a    | 429.   | 492.   | 587.   |
| 24"  |  | 72" | 22" | 1 1/4" | <b>XTTS7224B (1/2/3) ( )</b>     | n/a                          | n/a    | 461.   | 524.   | 629.   |
| 24"  |  | 96" | 22" | 1 1/4" | <b>XTTS9624B (1/2/3) ( )</b>     | n/a                          | n/a    | 513.   | 576.   | 702.   |
| 30"  |  | 48" | 28" | 1 1/4" | <b>XTTS4830B (1/2/3) ( )</b>     | n/a                          | n/a    | 492.   | 555.   | 660.   |
| 30"  |  | 60" | 28" | 1 1/4" | <b>XTTS6030B (1/2/3) ( )</b>     | n/a                          | n/a    | 513.   | 581.   | 703.   |
| 30"  |  | 72" | 28" | 1 1/4" | <b>XTTS7230B (1/2/3) ( )</b>     | n/a                          | n/a    | 534.   | 608.   | 784.   |
| 30"  |  | 96" | 28" | 1 1/4" | <b>XTTS9630B (1/2/3) ( )</b>     | n/a                          | n/a    | 576.   | 660.   | 923.   |
| 36"  |  | 48" | 34" | 1 1/4" | <b>XTTS4836B (1/2/3) ( )</b>     | n/a                          | n/a    | 555.   | 634.   | 765.   |
| 36"  |  | 60" | 34" | 1 1/4" | <b>XTTS6036B (1/2/3) ( )</b>     | n/a                          | n/a    | 587.   | 665.   | 789.   |
| 36"  |  | 72" | 34" | 1 1/4" | <b>XTTS7236B (1/2/3) ( )</b>     | n/a                          | n/a    | 618.   | 713.   | 886.   |
| 36"  |  | 96" | 34" | 1 1/4" | <b>XTTS9636B (1/2/3) ( )</b>     | n/a                          | n/a    | 681.   | 807.   | 1,059. |
| Worksurface, postformed plastic<br> |  | 24" | 48" | 22"    | 1 1/4"                           | <b>XTPP4824B (L) ( )</b>     | 254.   | n/a    | n/a    | n/a    |
|  | 24"  | 60" | 22" | 1 1/4" | <b>XTPP6024B (L) ( )</b>         | 321.                         | n/a    | n/a    | n/a    | n/a    |
|  | 24"  | 72" | 22" | 1 1/4" | <b>XTPP7224B (L) ( )</b>         | 373.                         | n/a    | n/a    | n/a    | n/a    |
|  | 24"  | 96" | 22" | 1 1/4" | <b>XTPP9624B (L) ( )</b>         | 430.                         | n/a    | n/a    | n/a    | n/a    |
|  | 30"  | 48" | 28" | 1 1/4" | <b>XTPP4830B (L) ( )</b>         | 274.                         | n/a    | n/a    | n/a    | n/a    |
|  | 30"  | 60" | 28" | 1 1/4" | <b>XTPP6030B (L) ( )</b>         | 347.                         | n/a    | n/a    | n/a    | n/a    |
|  | 30"  | 72" | 28" | 1 1/4" | <b>XTPP7230B (L) ( )</b>         | 404.                         | n/a    | n/a    | n/a    | n/a    |
|  | 30"  | 96" | 28" | 1 1/4" | <b>XTPP9630B (L) ( )</b>         | 472.                         | n/a    | n/a    | n/a    | n/a    |
|  | 36"  | 48" | 34" | 1 1/4" | <b>XTPP4836B (L) ( )</b>         | 300.                         | n/a    | n/a    | n/a    | n/a    |
|  | 36"  | 60" | 34" | 1 1/4" | <b>XTPP6036B (L) ( )</b>         | 404.                         | n/a    | n/a    | n/a    | n/a    |
|  | 36"  | 72" | 34" | 1 1/4" | <b>XTPP7236B (L) ( )</b>         | 456.                         | n/a    | n/a    | n/a    | n/a    |
|  | 36"  | 96" | 34" | 1 1/4" | <b>XTPP9636B (L) ( )</b>         | 529.                         | n/a    | n/a    | n/a    | n/a    |

| Order Code                     | Specifications |
|--------------------------------|----------------|
| Example: <b>XTPP6030BL 118</b> |                |
| <b>XT</b> Crinion Open Table   |                |
| <b>T</b> Worksurface           |                |
| <b>P</b> Postformed plastic    |                |
| <b>60</b> Width                |                |
| <b>30</b> Depth                |                |
| <b>B</b> With edge grommet     |                |
| <b>L</b> Finish type           |                |
| <b>118</b> Surface             |                |

Worksurfaces are 1 1/4" thick with square edge or tapered edge option tapering to 1/2" thick front edge.

Specify finishes:  
 L - Laminate  
 M - Laminate/veneer edge  
 1 - Veneer group 1  
 2 - Veneer group 2  
 3 - Veneer group 3

**Application Notes**

Crinion 30"D worksurfaces correspond in width to table bases, which are specified separately. 48"W worksurfaces plan on 12' wide or 20' wide bases. 60"W worksurfaces plan on 5', 10', 15' and 20' wide bases. 72" W worksurfaces plan on 6', 12' and 18' wide bases.

Edge grommet accommodates most power cord plugs up to 1" deep.

Actual worksurface depth is 21.85", 27.85" or 33.85".

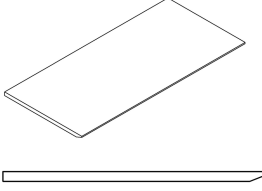
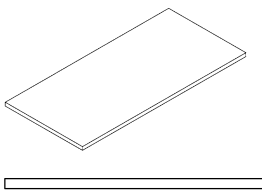
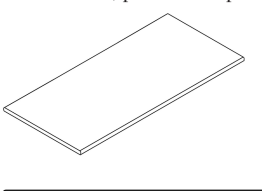
| description  | nominal depth  | w   | d   | h      | pattern number                   | L                            | M      | V1     | V2     | V3     |      |
|--|--|-----|-----|--------|----------------------------------|------------------------------|--------|--------|--------|--------|------|
| Worksurface, tapered edge<br>         | 24"  | 48" | 22" | 1 1/4" | <b>XTTK4824C (L/M/1/2/3) ( )</b> | \$398.                       | \$507. | \$507. | \$581. | \$755. |      |
|  | 24"  | 60" | 22" | 1 1/4" | <b>XTTK6024C (L/M/1/2/3) ( )</b> | 423.                         | 579.   | 579.   | 665.   | 864.   |      |
|  | 24"  | 72" | 22" | 1 1/4" | <b>XTTK7224C (L/M/1/2/3) ( )</b> | 469.                         | 625.   | 625.   | 721.   | 938.   |      |
|  | 24"  | 96" | 22" | 1 1/4" | <b>XTTK9624C (L/M/1/2/3) ( )</b> | 551.                         | 739.   | 739.   | 853.   | 1,109. |      |
|  | 30"  | 48" | 28" | 1 1/4" | <b>XTTK4830C (L/M/1/2/3) ( )</b> | 408.                         | 571.   | 571.   | 657.   | 855.   |      |
|  | 30"  | 60" | 28" | 1 1/4" | <b>XTTK6030C (L/M/1/2/3) ( )</b> | 444.                         | 639.   | 639.   | 734.   | 954.   |      |
|  | 30"  | 72" | 28" | 1 1/4" | <b>XTTK7230C (L/M/1/2/3) ( )</b> | 493.                         | 670.   | 670.   | 770.   | 1,001. |      |
|  | 30"  | 96" | 28" | 1 1/4" | <b>XTTK9630C (L/M/1/2/3) ( )</b> | 580.                         | 791.   | 791.   | 910.   | 1,182. |      |
|  | 36"  | 48" | 34" | 1 1/4" | <b>XTTK4836C (L/M/1/2/3) ( )</b> | 440.                         | 644.   | 644.   | 744.   | 968.   |      |
|  | 36"  | 60" | 34" | 1 1/4" | <b>XTTK6036C (L/M/1/2/3) ( )</b> | 460.                         | 707.   | 707.   | 812.   | 1,054. |      |
|  | 36"  | 72" | 34" | 1 1/4" | <b>XTTK7236C (L/M/1/2/3) ( )</b> | 525.                         | 718.   | 718.   | 822.   | 1,068. |      |
|  | 36"  | 96" | 34" | 1 1/4" | <b>XTTK9636C (L/M/1/2/3) ( )</b> | 633.                         | 845.   | 845.   | 971.   | 1,262. |      |
|  | Worksurface, veneer square edge<br> | 24" | 48" | 22"    | 1 1/4"                           | <b>XTTS4824C (1/2/3) ( )</b> | n/a    | n/a    | 368.   | 431.   | 515. |
|  |  | 24" | 60" | 22"    | 1 1/4"                           | <b>XTTS6024C (1/2/3) ( )</b> | n/a    | n/a    | 399.   | 462.   | 557. |
| 24"  |  | 72" | 22" | 1 1/4" | <b>XTTS7224C (1/2/3) ( )</b>     | n/a                          | n/a    | 431.   | 494.   | 599.   |      |
| 24"  |  | 96" | 22" | 1 1/4" | <b>XTTS9624C (1/2/3) ( )</b>     | n/a                          | n/a    | 483.   | 546.   | 672.   |      |
| 30"  |  | 48" | 28" | 1 1/4" | <b>XTTS4830C (1/2/3) ( )</b>     | n/a                          | n/a    | 462.   | 525.   | 630.   |      |
| 30"  |  | 60" | 28" | 1 1/4" | <b>XTTS6030C (1/2/3) ( )</b>     | n/a                          | n/a    | 483.   | 551.   | 673.   |      |
| 30"  |  | 72" | 28" | 1 1/4" | <b>XTTS7230C (1/2/3) ( )</b>     | n/a                          | n/a    | 504.   | 578.   | 754.   |      |
| 30"  |  | 96" | 28" | 1 1/4" | <b>XTTS9630C (1/2/3) ( )</b>     | n/a                          | n/a    | 546.   | 630.   | 893.   |      |
| 36"  |  | 48" | 34" | 1 1/4" | <b>XTTS4836C (1/2/3) ( )</b>     | n/a                          | n/a    | 525.   | 604.   | 735.   |      |
| 36"  |  | 60" | 34" | 1 1/4" | <b>XTTS6036C (1/2/3) ( )</b>     | n/a                          | n/a    | 557.   | 635.   | 759.   |      |
| 36"  |  | 72" | 34" | 1 1/4" | <b>XTTS7236C (1/2/3) ( )</b>     | n/a                          | n/a    | 588.   | 683.   | 856.   |      |
| 36"  |  | 96" | 34" | 1 1/4" | <b>XTTS9636C (1/2/3) ( )</b>     | n/a                          | n/a    | 651.   | 777.   | 1,029. |      |
| Worksurface, postformed plastic<br> |  | 24" | 48" | 22"    | 1 1/4"                           | <b>XTPP4824C (L) ( )</b>     | 224.   | n/a    | n/a    | n/a    | n/a  |
|  |  | 24" | 60" | 22"    | 1 1/4"                           | <b>XTPP6024C (L) ( )</b>     | 291.   | n/a    | n/a    | n/a    | n/a  |
|  | 24"  | 72" | 22" | 1 1/4" | <b>XTPP7224C (L) ( )</b>         | 343.                         | n/a    | n/a    | n/a    | n/a    |      |
|  | 24"  | 96" | 22" | 1 1/4" | <b>XTPP9624C (L) ( )</b>         | 400.                         | n/a    | n/a    | n/a    | n/a    |      |
|  | 30"  | 48" | 28" | 1 1/4" | <b>XTPP4830C (L) ( )</b>         | 244.                         | n/a    | n/a    | n/a    | n/a    |      |
|  | 30"  | 60" | 28" | 1 1/4" | <b>XTPP6030C (L) ( )</b>         | 317.                         | n/a    | n/a    | n/a    | n/a    |      |
|  | 30"  | 72" | 28" | 1 1/4" | <b>XTPP7230C (L) ( )</b>         | 374.                         | n/a    | n/a    | n/a    | n/a    |      |
|  | 30"  | 96" | 28" | 1 1/4" | <b>XTPP9630C (L) ( )</b>         | 442.                         | n/a    | n/a    | n/a    | n/a    |      |
|  | 36"  | 48" | 34" | 1 1/4" | <b>XTPP4836C (L) ( )</b>         | 270.                         | n/a    | n/a    | n/a    | n/a    |      |
|  | 36"  | 60" | 34" | 1 1/4" | <b>XTPP6036C (L) ( )</b>         | 374.                         | n/a    | n/a    | n/a    | n/a    |      |
|  | 36"  | 72" | 34" | 1 1/4" | <b>XTPP7236C (L) ( )</b>         | 426.                         | n/a    | n/a    | n/a    | n/a    |      |
|  | 36"  | 96" | 34" | 1 1/4" | <b>XTPP9636C (L) ( )</b>         | 499.                         | n/a    | n/a    | n/a    | n/a    |      |

| Order Code                     | Specifications   | Application Notes   |
|--------------------------------|--|---|
| Example: <b>XTPP6030CL 118</b> | Worksurfaces are 1 1/4" thick with square edge or tapered edge option tapering to 1/2" thick front edge. | Crinion 30"D worksurfaces correspond in width to table bases, which are specified separately. 48"W worksurfaces plan on 12' wide or 20' wide bases. 60"W worksurfaces plan on 5', 10', 15' and 20' wide bases. 72" W worksurfaces plan on 6', 12' and 18' wide bases. |
| <b>XT</b> Crinion Open Table   | Specify finishes:<br>L - Laminate<br>M- Laminate/veneer edge   | Actual worksurface depth is 21.85", 27.85" or 33.85".   |
| <b>T</b> Worksurface           | 1 - Veneer group 1<br>2 - Veneer group 2<br>3 - Veneer group 3   |   |
| <b>P</b> Postformed plastic    |  |   |
| <b>60</b> Width                |  |   |
| <b>30</b> Depth                |  |   |
| <b>C</b> With cord drop        |  |   |
| <b>L</b> Finish type           |  |   |
| <b>118</b> Surface             |  | Continuous 1/2" cord drop accommodates clamp-on flat screen monitor arm or most power cords.  |

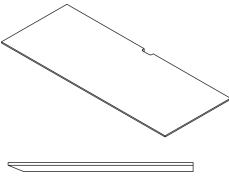
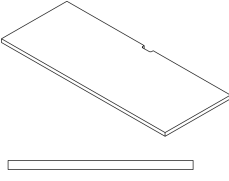
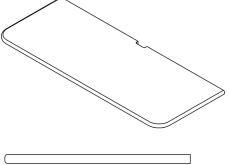
| description   | nominal depth | w   | l   | h      | pattern number                   | L      | M      | V1     | V2     | V3     |
|---|---------------|-----|-----|--------|----------------------------------|--------|--------|--------|--------|--------|
| End counter, tapered edge<br>          | 24"           | 48" | 24" | 1 1/4" | <b>XTTK4824E (L/M/1/2/3) ( )</b> | \$558. | \$717. | \$717. | \$791. | \$965. |
|   | 24"           | 60" | 24" | 1 1/4" | <b>XTTK6024E (L/M/1/2/3) ( )</b> | 660.   | 789.   | 789.   | 875.   | 1,074. |
|   | 24"           | 72" | 24" | 1 1/4" | <b>XTTK7224E (L/M/1/2/3) ( )</b> | 685.   | 835.   | 835.   | 931.   | 1,148. |
|   | 30"           | 48" | 30" | 1 1/4" | <b>XTTK4830E (L/M/1/2/3) ( )</b> | 624.   | 781.   | 781.   | 867.   | 1,065. |
|   | 30"           | 60" | 30" | 1 1/4" | <b>XTTK6030E (L/M/1/2/3) ( )</b> | 682.   | 849.   | 849.   | 944.   | 1,164. |
|   | 30"           | 72" | 30" | 1 1/4" | <b>XTTK7230E (L/M/1/2/3) ( )</b> | 710.   | 880.   | 880.   | 980.   | 1,211. |
| End counter, veneer square edge<br>    | 24"           | 48" | 24" | 1 1/4" | <b>XTTS4824E (1/2/3) ( )</b>     | n/a    | n/a    | 368.   | 431.   | 515.   |
|   | 24"           | 60" | 24" | 1 1/4" | <b>XTTS6024E (1/2/3) ( )</b>     | n/a    | n/a    | 399.   | 462.   | 557.   |
|   | 24"           | 72" | 24" | 1 1/4" | <b>XTTS7224E (1/2/3) ( )</b>     | n/a    | n/a    | 431.   | 494.   | 599.   |
|   | 30"           | 48" | 30" | 1 1/4" | <b>XTTS4830E (1/2/3) ( )</b>     | n/a    | n/a    | 462.   | 525.   | 630.   |
|   | 30"           | 60" | 30" | 1 1/4" | <b>XTTS6030E (1/2/3) ( )</b>     | n/a    | n/a    | 483.   | 551.   | 673.   |
|   | 30"           | 72" | 30" | 1 1/4" | <b>XTTS7230E (1/2/3) ( )</b>     | n/a    | n/a    | 504.   | 578.   | 754.   |
| End counter for postformed plastic<br> | 24"           | 48" | 24" | 1 1/4" | <b>XTTP4824E (L) ( )</b>         | 416.   | n/a    | n/a    | n/a    | n/a    |
|   | 24"           | 60" | 24" | 1 1/4" | <b>XTTP6024E (L) ( )</b>         | 494.   | n/a    | n/a    | n/a    | n/a    |
|   | 24"           | 72" | 24" | 1 1/4" | <b>XTTP7224E (L) ( )</b>         | 556.   | n/a    | n/a    | n/a    | n/a    |
|   | 30"           | 48" | 30" | 1 1/4" | <b>XTTP4830E (L) ( )</b>         | 468.   | n/a    | n/a    | n/a    | n/a    |
|   | 30"           | 60" | 30" | 1 1/4" | <b>XTTP6030E (L) ( )</b>         | 556.   | n/a    | n/a    | n/a    | n/a    |
|   | 30"           | 72" | 30" | 1 1/4" | <b>XTTP7230E (L) ( )</b>         | 666.   | n/a    | n/a    | n/a    | n/a    |

**Order Code**

|                                |
|--------------------------------|
| Example: <b>XTTP6024EL 118</b> |
| <b>XT</b> Crinion Open Table   |
| <b>T</b> Worksurface           |
| <b>P</b> Postformed plastic    |
| <b>60</b> Width                |
| <b>24</b> Length               |
| <b>E</b> End counter           |
| <b>L</b> Finish Type           |
| <b>118</b> Surface             |

**Specifications**

End counters are 1 1/4" thick with square edge or tapered edge option tapering to 1/2" thick front edge. End counters are tapered front and side edges only.

Specify finishes:  
 L - Laminate  
 M- Laminate/veneer edge  
 1 - Veneer group 1  
 2 - Veneer group 2  
 3 - Veneer group 3

**Application Notes**

End counters mount at the ends of dual tables with two end counter cantilever brackets. Specify dual end legs for end counters instead of standard dual end legs (tables with end counters must be specified from components, not assemblies).

Specify 48" W for dual 24" tables, 60" W for dual 30" tables and 72" W for dual 36" tables.

Specify added length of 24" or 30" beyond end leg for end counters.



| description   | nominal depth | w   | l   | h      | pattern no.                      | L      | M        | V1       | V2       | V3       |
|---|---------------|-----|-----|--------|----------------------------------|--------|----------|----------|----------|----------|
| Extended end counter, tapered edge with hinged power access | 36"           | 48" | 36" | 1 1/4" | <b>XTTK4836D (L/M/1/2/3) ( )</b> | \$960. | \$1,110. | \$1,110. | \$1,206. | \$1,423. |
|   | 36"           | 60" | 36" | 1 1/4" | <b>XTTK6036D (L/M/1/2/3) ( )</b> | 985.   | 1,155.   | 1,155.   | 1,255.   | 1,486.   |
|   | 36"           | 72" | 36" | 1 1/4" | <b>XTTK7236D (L/M/1/2/3) ( )</b> | 1,055. | 1,241.   | 1,241.   | 1,346.   | 1,603.   |

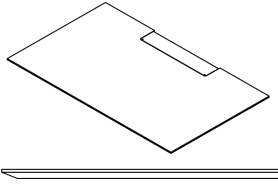

|   |     |     |     |        |                                  |      |      |      |        |        |
|---|-----|-----|-----|--------|----------------------------------|------|------|------|--------|--------|
| Extended end counter, tapered edge with grommet | 36" | 48" | 36" | 1 1/4" | <b>XTTK4836E (L/M/1/2/3) ( )</b> | 685. | 835. | 835. | 931.   | 1,148. |
|   | 36" | 60" | 36" | 1 1/4" | <b>XTTK6036E (L/M/1/2/3) ( )</b> | 710. | 880. | 880. | 980.   | 1,211. |
|   | 36" | 72" | 36" | 1 1/4" | <b>XTTK7236E (L/M/1/2/3) ( )</b> | 780. | 966. | 966. | 1,071. | 1,328. |

|   |     |     |     |        |                              |     |     |      |      |        |
|---|-----|-----|-----|--------|------------------------------|-----|-----|------|------|--------|
| Extended end counter, veneer square edge with hinged power access | 36" | 48" | 36" | 1 1/4" | <b>XTTS4836D (1/2/3) ( )</b> | n/a | n/a | 706. | 769. | 874.   |
|   | 36" | 60" | 36" | 1 1/4" | <b>XTTS6036D (1/2/3) ( )</b> | n/a | n/a | 779. | 853. | 1,029. |
|   | 36" | 72" | 36" | 1 1/4" | <b>XTTS7236D (1/2/3) ( )</b> | n/a | n/a | 853. | 931. | 1,141. |

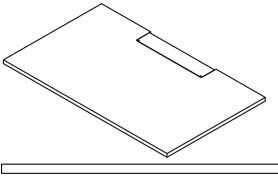

|   |     |     |     |        |                              |     |     |      |      |      |
|---|-----|-----|-----|--------|------------------------------|-----|-----|------|------|------|
| Extended end counter, veneer square edge with grommet | 36" | 48" | 36" | 1 1/4" | <b>XTTS4836E (1/2/3) ( )</b> | n/a | n/a | 431. | 494. | 599. |
|   | 36" | 60" | 36" | 1 1/4" | <b>XTTS6036E (1/2/3) ( )</b> | n/a | n/a | 504. | 578. | 754. |
|   | 36" | 72" | 36" | 1 1/4" | <b>XTTS7236E (1/2/3) ( )</b> | n/a | n/a | 578. | 656. | 866. |

|   |     |     |     |        |                          |        |     |     |     |     |
|---|-----|-----|-----|--------|--------------------------|--------|-----|-----|-----|-----|
| Extended end counter, postformed plastic with hinged power access | 36" | 48" | 36" | 1 1/4" | <b>XTTP4836D (L) ( )</b> | 831.   | n/a | n/a | n/a | n/a |
|   | 36" | 60" | 36" | 1 1/4" | <b>XTTP6036D (L) ( )</b> | 941.   | n/a | n/a | n/a | n/a |
|   | 36" | 72" | 36" | 1 1/4" | <b>XTTP7236D (L) ( )</b> | 1,050. | n/a | n/a | n/a | n/a |

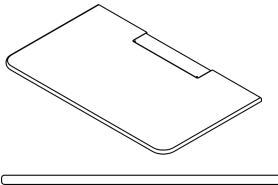

|   |     |     |     |        |                          |      |     |     |     |     |
|---|-----|-----|-----|--------|--------------------------|------|-----|-----|-----|-----|
| Extended end counter, postformed plastic with grommet | 36" | 48" | 36" | 1 1/4" | <b>XTTP4836E (L) ( )</b> | 556. | n/a | n/a | n/a | n/a |
|   | 36" | 60" | 36" | 1 1/4" | <b>XTTP6036E (L) ( )</b> | 666. | n/a | n/a | n/a | n/a |
|   | 36" | 72" | 36" | 1 1/4" | <b>XTTP7236E (L) ( )</b> | 775. | n/a | n/a | n/a | n/a |

| Order Code                                      | Specifications   | Application Notes  |
|---|--|--|
| Example: <b>XTTP6036DL 118</b>                  |  |  |
| <b>XT</b> Crinion Open Table                    | End counters are 1 1/4" thick with square edge or tapered edge option tapering to 1/2" thick front edge. End counters are tapered front and side edges only. | End counters mount at the ends of dual tables with two end counter cantilever brackets. Specify dual end legs for end counters instead of standard dual end legs (tables with end counters must be specified from components, not assemblies). |
| <b>T</b> Worksurface                            |  | Each extended end counter requires base assembly 12" longer than worksurfaces on eachy side.   |
| <b>P</b> Postformed plastic                     |  |  |
| <b>60</b> Width                                 |  |  |
| <b>36</b> Length                                |  |  |
| <b>D</b> End counter,center hinged power access | Specify finishes:<br>L - Laminate<br>M- Laminate/veneer edge   | Specify 48" W for dual 24" tables, 60" W for dual 30" tables and 72" W for dual 36" tables.  |
| <b>L</b> Finish Type                            | 1 - Veneer group 1<br>2 - Veneer group 2<br>3 - Veneer group 3   |  |
| <b>118</b> Surface                              |  |  |

# Complete base assemblies fixed height 24" D dual

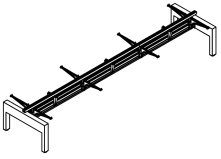
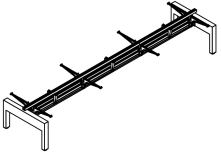
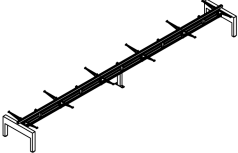
| description  | nominal        | w    | d   | h       | pattern number              | P2       | P3       |
|--|----------------|------|-----|---------|-----------------------------|----------|----------|
|  Base assembly, continuous            | 10' dual       | 120" | 44" | 28 1/2" | <b>XTB1 BAS 24D10CF ( )</b> | \$7,738. | \$7,939. |
|  | 12' dual       | 144" | 44" | 28 1/2" | <b>XTB1 BAS 24D12CF ( )</b> | 8,070.   | 8,271.   |
|  | 15' dual       | 180" | 44" | 28 1/2" | <b>XTB1 BAS 24D15CF ( )</b> | 9,275.   | 9,480.   |
|  Base assembly, segmented             | 10' + 5' dual  | 180" | 44" | 28 1/2" | <b>XTB1 BAS 24D15SF ( )</b> | 9,970.   | 10,176.  |
|  Base assembly, with intermediate leg | 12' + 6' dual  | 216" | 44" | 28 1/2" | <b>XTB1 BAS 24D18SF ( )</b> | 11,030.  | 11,235.  |
|  | 10' + 10' dual | 240" | 44" | 28 1/2" | <b>XTB1 BAS 24D20SF ( )</b> | 11,988.  | 12,198.  |
|  | 12' + 12' dual | 288" | 44" | 28 1/2" | <b>XTB1 BAS 24D24SF ( )</b> | 12,652.  | 12,861.  |
|  | 15' + 10' dual | 300" | 44" | 28 1/2" | <b>XTB1 BAS 24D25SF ( )</b> | 13,525.  | 13,739.  |

## Order Code

|            |                           |
|------------|---------------------------|
| Example:   | <b>XTB1BAS24D10CF 613</b> |
| <b>XT</b>  | Crinion Open Table        |
| <b>B1</b>  | Base components           |
| <b>BAS</b> | Assembly                  |
| <b>24</b>  | Depth                     |
| <b>D</b>   | Dual                      |
| <b>10</b>  | Width                     |
| <b>C</b>   | Continuous                |
| <b>F</b>   | Fixed height              |
| <b>613</b> | finish                    |

## Specifications

Base assemblies include end legs, beams, trusses, cantilever brackets, channels and end caps.

Fixed height base assemblies have shared cantilever brackets for adjacent worksurfaces and midspan support brackets for every worksurface.

For legs and cantilever brackets specify one paint finish for all.



## Application Notes

Complete base assemblies include all base components necessary to support worksurfaces. Specify screens, power components and cable trays separately. Base assemblies include end legs, intermediate leg (where required), beams, trusses, cantilever brackets, mid span support brackets, top channel and end caps.

No table on this page has beams longer than 15'.

Base assemblies correspond to:  
 10': four 60"x24"D worksurfaces  
 12': four 72"x24"D worksurfaces  
 15': six 60"x24"D worksurfaces  
 18': six 72"x24"D worksurfaces  
 20': eight 60"x24"D worksurfaces  
 24': eight 72"x24"D worksurfaces  
 25': ten 60"x24"D worksurfaces

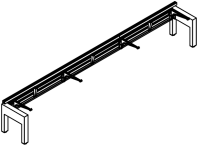
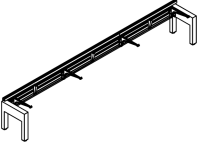
# Complete base assemblies fixed height 24" D single sided

| description  | nominal                | w    | d   | h       | pattern number              | P2       | P3       |
|--|------------------------|------|-----|---------|-----------------------------|----------|----------|
|  Base assembly, continuous            | 10' single sided       | 120" | 24" | 28 1/2" | <b>XTB1 BAS 24S10CF ( )</b> | \$7,128. | \$7,330. |
|  | 12' single sided       | 144" | 24" | 28 1/2" | <b>XTB1 BAS 24S12CF ( )</b> | 7,460.   | 7,661.   |
|  | 15' single sided       | 180" | 24" | 28 1/2" | <b>XTB1 BAS 24S15CF ( )</b> | 8,462.   | 8,667.   |
|  Base assembly, segmented             | 10' + 5' single sided  | 180" | 24" | 28 1/2" | <b>XTB1 BAS 24S15SF ( )</b> | 9,157.   | 9,363.   |
|  Base assembly, with intermediate leg | 12' + 6' single sided  | 216" | 24" | 28 1/2" | <b>XTB1 BAS 24S18SF ( )</b> | 10,216.  | 10,422.  |
|  | 10' + 10' single sided | 240" | 24" | 28 1/2" | <b>XTB1 BAS 24S20SF ( )</b> | 10,972.  | 11,182.  |
|  | 12' + 12' single sided | 288" | 24" | 28 1/2" | <b>XTB1 BAS 24S24SF ( )</b> | 11,635.  | 11,845.  |
|  | 15' + 10' single sided | 300" | 24" | 28 1/2" | <b>XTB1 BAS 24S25SF ( )</b> | 12,305.  | 12,519.  |

## Order Code

|            |                           |
|------------|---------------------------|
| Example:   | <b>XTB1BAS24S10CF 613</b> |
| <b>XT</b>  | Crinion Open Table        |
| <b>B1</b>  | Base components           |
| <b>BAS</b> | Assembly                  |
| <b>24</b>  | Depth                     |
| <b>S</b>   | Single                    |
| <b>10</b>  | Width                     |
| <b>C</b>   | Continuous                |
| <b>F</b>   | Fixed height              |
| <b>613</b> | finish                    |

## Specifications

Base assemblies include end legs, beams, trusses, cantilever brackets, channels and end caps.

Fixed height base assemblies have shared cantilever brackets for adjacent worksurfaces and midspan support brackets for every worksurface.

For legs and cantilever brackets specify one paint finish for all.

## Application Notes

Complete base assemblies include all base components necessary to support worksurfaces. Specify screens, power components and cable trays separately. Base assemblies include end legs, intermediate leg (where required), beams, trusses, cantilever brackets, mid span support brackets, top channel and end caps.

No table on this page has beams longer than 15'.

Base assemblies correspond to:  
 10': two 60"x24"D worksurfaces  
 12': two 72"x24"D worksurfaces  
 15': three 60"x24"D worksurfaces  
 18': three 72"x24"D worksurfaces  
 20': four 60"x24"D worksurfaces  
 24': four 72"x24"D worksurfaces  
 25': five 60"x24"D worksurfaces

# Complete base assemblies fixed height 30" D dual

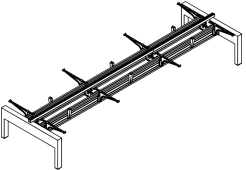
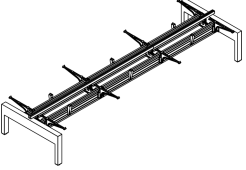
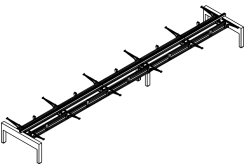
| description   | nominal        | w    | d   | h    | pattern number              | P2       | P3       |
|---|----------------|------|-----|------|-----------------------------|----------|----------|
| <br>Base assembly, continuous            | 10' dual       | 120" | 54" | 28½" | <b>XTB1 BAS 30D10CF ( )</b> | \$9,427. | \$9,694. |
|   | 12' dual       | 144" | 54" | 28½" | <b>XTB1 BAS 30D12CF ( )</b> | 9,812.   | 10,079.  |
|   | 15' dual       | 180" | 54" | 28½" | <b>XTB1 BAS 30D15CF ( )</b> | 11,421.  | 11,717.  |
| <br>Base assembly, segmented             | 10' + 5' dual  | 180" | 54" | 28½" | <b>XTB1 BAS 30D15SF ( )</b> | 12,384.  | 12,680.  |
| <br>Base assembly, with intermediate leg | 12' + 6' dual  | 216" | 54" | 28½" | <b>XTB1 BAS 30D18SF ( )</b> | 13,722.  | 14,060.  |
|   | 10' + 10' dual | 240" | 54" | 28½" | <b>XTB1 BAS 30D20SF ( )</b> | 15,299.  | 15,665.  |
|   | 12' + 12' dual | 288" | 54" | 28½" | <b>XTB1 BAS 30D24CF ( )</b> | 16,069.  | 16,435.  |
|   | 15' + 10' dual | 300" | 54" | 28½" | <b>XTB1 BAS 30D25CF ( )</b> | 17,293.  | 17,687.  |

## Order Code

|            |                           |
|------------|---------------------------|
| Example:   | <b>XTB1BAS30D18SF 613</b> |
| <b>XT</b>  | Crinion Open Table        |
| <b>B1</b>  | Base components           |
| <b>BAS</b> | Assembly                  |
| <b>30</b>  | Depth                     |
| <b>D</b>   | Dual                      |
| <b>18</b>  | Width                     |
| <b>S</b>   | Segmented                 |
| <b>F</b>   | Fixed height              |
| <b>613</b> | finish                    |

## Specifications

Base assemblies include end legs, beams, trusses, cantilever brackets, channels and end caps.

Fixed height base assemblies have shared cantilever brackets for adjacent worksurfaces and midspan support brackets for every worksurface.

For legs and cantilever brackets specify one paint finish for all.



## Application Notes

Complete base assemblies include all base components necessary to support worksurfaces. Specify screens, power components and cable trays separately. Base assemblies include end legs, intermediate leg (where required), beams, trusses, cantilever brackets, mid span support brackets, top channel and end caps.

No table on this page has beams longer than 15'.

Base assemblies correspond to:  
 10': four 60"x30"D worksurfaces  
 12': four 72"x30"D worksurfaces  
 15': six 60"x30"D worksurfaces  
 18': six 72"x30"D worksurfaces  
 20': eight 60"x30"D worksurfaces  
 24': eight 72"x30"D worksurfaces  
 25': ten 60"x30"D worksurfaces

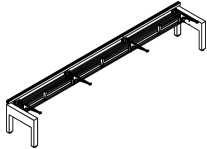
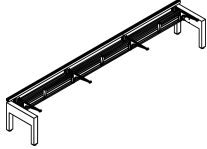
# Complete base assemblies fixed height 30" D single sided

| description  | nominal                | w    | d                                | h                                | pattern number              | P2       | P3       |
|--|------------------------|------|----------------------------------|----------------------------------|-----------------------------|----------|----------|
|  Base assembly, continuous            | 10' single sided       | 120" | 28 <sup>3</sup> / <sub>4</sub> " | 28 <sup>1</sup> / <sub>2</sub> " | <b>XTB1 BAS 30S10CF ( )</b> | \$8,298. | \$8,528. |
|  | 12' single sided       | 144" | 28 <sup>3</sup> / <sub>4</sub> " | 28 <sup>1</sup> / <sub>2</sub> " | <b>XTB1 BAS 30S12CF ( )</b> | 8,683.   | 8,913.   |
|  | 15' single sided       | 180" | 28 <sup>3</sup> / <sub>4</sub> " | 28 <sup>1</sup> / <sub>2</sub> " | <b>XTB1 BAS 30S15CF ( )</b> | 9,878.   | 10,122.  |
|  Base assembly, segmented             | 10' + 5' single sided  | 180" | 28 <sup>3</sup> / <sub>4</sub> " | 28 <sup>1</sup> / <sub>2</sub> " | <b>XTB1 BAS 30S15SF ( )</b> | 9,236.   | 9,480.   |
|  Base assembly, with intermediate leg | 12' + 6' single sided  | 216" | 28 <sup>3</sup> / <sub>4</sub> " | 28 <sup>1</sup> / <sub>2</sub> " | <b>XTB1 BAS 30S18SF ( )</b> | 10,028.  | 10,272.  |
|  | 10' + 10' single sided | 240" | 28 <sup>3</sup> / <sub>4</sub> " | 28 <sup>1</sup> / <sub>2</sub> " | <b>XTB1 BAS 30S20SF ( )</b> | 11,405.  | 11,663.  |
|  | 12' + 12' single sided | 288" | 28 <sup>3</sup> / <sub>4</sub> " | 28 <sup>1</sup> / <sub>2</sub> " | <b>XTB1 BAS 30S24SF ( )</b> | 13,781.  | 14,038.  |
|  | 15' + 10' single sided | 300" | 28 <sup>3</sup> / <sub>4</sub> " | 28 <sup>1</sup> / <sub>2</sub> " | <b>XTB1 BAS 30S25SF ( )</b> | 14,591.  | 14,862.  |

## Order Code

|            |                           |
|------------|---------------------------|
| Example:   | <b>XTB1BAS30S15CF 613</b> |
| <b>XT</b>  | Crinion Open Table        |
| <b>B1</b>  | Base components           |
| <b>BAS</b> | Assembly                  |
| <b>30</b>  | Depth                     |
| <b>S</b>   | Single                    |
| <b>15</b>  | Width                     |
| <b>C</b>   | Continuous                |
| <b>F</b>   | Fixed height              |
| <b>613</b> | finish                    |

## Specifications

Base assemblies include end legs, beams, trusses, cantilever brackets, channels and end caps.

Fixed height base assemblies have shared cantilever brackets for adjacent worksurfaces and midspan support brackets for every worksurface.

For legs and cantilever brackets specify one paint finish for all.

## Application Notes

Complete base assemblies include all base components necessary to support worksurfaces. Specify screens, power components and cable trays separately. Base assemblies include end legs, intermediate leg (where required), beams, trusses, cantilever brackets, mid span support brackets, top channel and end caps.

No table on this page has beams longer than 15'.

Base assemblies correspond to:  
 10': two 60"x30"D worksurfaces  
 12': two 72"x30"D worksurfaces  
 15': three 60"x30"D worksurfaces  
 18': three 72"x30"D worksurfaces  
 20': four 60"x30"D worksurfaces  
 24': four 72"x30"D worksurfaces  
 25': five 60"x30"D worksurfaces

# Complete base assemblies adjustable height 30" D dual

Crinion Open Table

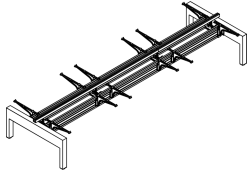
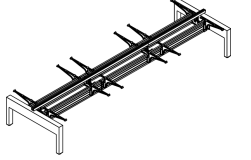
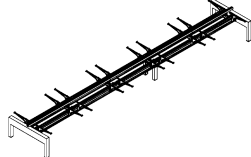
| description   | nominal        | w    | d   | h       | pattern number              | P2       | P3       |
|---|----------------|------|-----|---------|-----------------------------|----------|----------|
|  | 10' dual       | 120" | 54" | 28 1/2" | <b>XTB1 BAS 30D10CA ( )</b> | \$9,566. | \$9,844. |
|   | 12' dual       | 144" | 54" | 28 1/2" | <b>XTB1 BAS 30D12CA ( )</b> | 9,951.   | 10,229.  |
|   | 15' dual       | 180" | 54" | 28 1/2" | <b>XTB1 BAS 30D15CA ( )</b> | 11,824.  | 12,145.  |
|  | 10' + 5' dual  | 180" | 54" | 28 1/2" | <b>XTB1 BAS 30D15SA ( )</b> | 12,787.  | 13,108.  |
|  | 12' + 6' dual  | 216" | 54" | 28 1/2" | <b>XTB1 BAS 30D18SA ( )</b> | 14,124.  | 14,488.  |
|   | 10' + 10' dual | 240" | 54" | 28 1/2" | <b>XTB1 BAS 30D20SA ( )</b> | 15,964.  | 16,371.  |
|   | 12' + 12' dual | 288" | 54" | 28 1/2" | <b>XTB1 BAS 30D24CA ( )</b> | 16,735.  | 17,141.  |
|   | 15' + 10' dual | 300" | 54" | 28 1/2" | <b>XTB1 BAS 30D25CA ( )</b> | 18,222.  | 18,672.  |

## Order Code

|            |                           |
|------------|---------------------------|
| Example:   | <b>XTB1BAS30D18SA 613</b> |
| <b>XT</b>  | Crinion Open Table        |
| <b>B1</b>  | Base components           |
| <b>BAS</b> | Assembly                  |
| <b>30</b>  | Depth                     |
| <b>D</b>   | Dual                      |
| <b>18</b>  | Width                     |
| <b>S</b>   | Segmented                 |
| <b>A</b>   | Adjustable height         |
| <b>613</b> | finish                    |

## Specifications

Base assemblies include end legs, beams, trusses, cantilever brackets, channels and end caps.

For legs and cantilever brackets specify one paint finish for all.

## Application Notes



Complete base assemblies include all base components necessary to support worksurfaces. Specify screens, power components and cable trays separately. Base assemblies include end legs, intermediate leg (where required), beams, trusses, cantilever brackets, top channel and end caps.

No table on this page has beams longer than 15'.

Base assemblies correspond to:  
 10': four 60"x30"D worksurfaces  
 12': four 72"x30"D worksurfaces  
 15': six 60"x30"D worksurfaces  
 18': six 72"x30"D worksurfaces  
 20': eight 60"x30"D worksurfaces  
 24': eight 72"x30"D worksurfaces  
 25': ten 60"x30"D worksurfaces

# Complete base assemblies adjustable height 30" D single sided

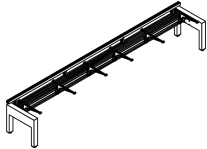
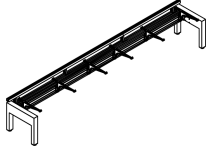
Crinion Open Table

| description  | nominal                | w    | d                                | h                                | pattern number              | P2       | P3       |
|--|------------------------|------|----------------------------------|----------------------------------|-----------------------------|----------|----------|
|  Base assembly, continuous            | 10' single sided       | 120" | 28 <sup>3</sup> / <sub>4</sub> " | 28 <sup>1</sup> / <sub>2</sub> " | <b>XTB1 BAS 30S10CA ( )</b> | \$8,389. | \$8,624. |
|  | 12' single sided       | 144" | 28 <sup>3</sup> / <sub>4</sub> " | 28 <sup>1</sup> / <sub>2</sub> " | <b>XTB1 BAS 30S12CA ( )</b> | 8,774.   | 9,009.   |
|  | 15' single sided       | 180" | 28 <sup>3</sup> / <sub>4</sub> " | 28 <sup>1</sup> / <sub>2</sub> " | <b>XTB1 BAS 30S15CA ( )</b> | 10,112.  | 10,368.  |
|  Base assembly, segmented             | 10' + 5' single sided  | 180" | 28 <sup>3</sup> / <sub>4</sub> " | 28 <sup>1</sup> / <sub>2</sub> " | <b>XTB1 BAS 30S15SA ( )</b> | 9,470.   | 9,726.   |
|  Base assembly, with intermediate leg | 12' + 6' single sided  | 216" | 28 <sup>3</sup> / <sub>4</sub> " | 28 <sup>1</sup> / <sub>2</sub> " | <b>XTB1 BAS 30S18SA ( )</b> | 10,475.  | 10,732.  |
|  | 10' + 10' single sided | 240" | 28 <sup>3</sup> / <sub>4</sub> " | 28 <sup>1</sup> / <sub>2</sub> " | <b>XTB1 BAS 30S20SA ( )</b> | 11,781.  | 12,059.  |
|  | 12' + 12' single sided | 288" | 28 <sup>3</sup> / <sub>4</sub> " | 28 <sup>1</sup> / <sub>2</sub> " | <b>XTB1 BAS 30S24SA ( )</b> | 14,156.  | 14,434.  |
|  | 15' + 10' single sided | 300" | 28 <sup>3</sup> / <sub>4</sub> " | 28 <sup>1</sup> / <sub>2</sub> " | <b>XTB1 BAS 30S25SA ( )</b> | 15,108.  | 15,408.  |

## Order Code

|            |                           |
|------------|---------------------------|
| Example:   | <b>XTB1BAS30S18SA 613</b> |
| <b>XT</b>  | Crinion Open Table        |
| <b>B1</b>  | Base components           |
| <b>BAS</b> | Assembly                  |
| <b>30</b>  | Depth                     |
| <b>S</b>   | Single                    |
| <b>18</b>  | Width                     |
| <b>S</b>   | Segmented                 |
| <b>A</b>   | Adjustable height         |
| <b>613</b> | finish                    |

## Specifications

Base assemblies include end legs, beams, trusses, cantilever brackets, channels and end caps.

For legs and cantilever brackets specify one paint finish for all.

## Application Notes

Complete base assemblies include all base components necessary to support worksurfaces. Specify screens, power components and cable trays separately. Base assemblies include end legs, intermediate leg (where required), beams, trusses, cantilever brackets, top channel and end caps.

No table on this page has beams longer than 15'.

Base assemblies correspond to:  
 10': two 60"x30"D worksurfaces  
 12': two 72"x30"D worksurfaces  
 15': three 60"x30"D worksurfaces  
 18': three 72"x30"D worksurfaces  
 20': four 60"x30"D worksurfaces  
 24': four 72"x30"D worksurfaces  
 25': five 60"x30"D worksurfaces

# Complete base assemblies fixed height 36" D dual

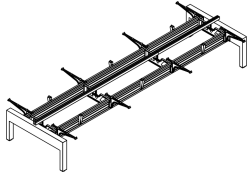
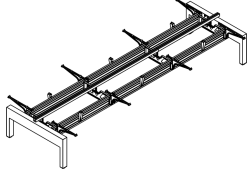
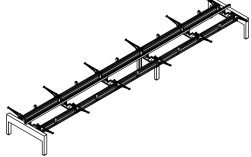
| description   | nominal        | w    | h    | d   | pattern number              | P2       | P3       |
|---|----------------|------|------|-----|-----------------------------|----------|----------|
|  | 10' dual       | 120" | 28½" | 54" | <b>XTB1 BAS 36D10CF ( )</b> | \$9,555. | \$9,823. |
|   | 12' dual       | 144" | 28½" | 54" | <b>XTB1 BAS 36D12CF ( )</b> | 9,940.   | 10,208.  |
|   | 15' dual       | 180" | 28½" | 54" | <b>XTB1 BAS 36D15CF ( )</b> | 11,592.  | 11,888.  |
|  | 10' + 5' dual  | 180" | 28½" | 54" | <b>XTB1 BAS 36D15SF ( )</b> | 12,555.  | 12,851.  |
|  | 12' + 6' dual  | 216" | 28½" | 54" | <b>XTB1 BAS 36D18SF ( )</b> | 13,893.  | 14,231.  |
|   | 10' + 10' dual | 240" | 28½" | 54" | <b>XTB1 BAS 36D20SF ( )</b> | 15,513.  | 15,879.  |
|   | 12' + 12' dual | 288" | 28½" | 54" | <b>XTB1 BAS 36D24CF ( )</b> | 16,283.  | 16,649.  |
|   | 15' + 10' dual | 300" | 28½" | 54" | <b>XTB1 BAS 36D25CF ( )</b> | 17,550.  | 17,944.  |

## Order Code

|            |                           |
|------------|---------------------------|
| Example:   | <b>XTB1BAS36D18SF 613</b> |
| <b>XT</b>  | Crinion Open Table        |
| <b>B1</b>  | Base components           |
| <b>BAS</b> | Assembly                  |
| <b>36</b>  | Depth                     |
| <b>D</b>   | Dual                      |
| <b>18</b>  | Width                     |
| <b>S</b>   | Segmented                 |
| <b>F</b>   | Fixed height              |
| <b>613</b> | finish                    |

## Specifications

Base assemblies include end legs, beams, trusses, cantilever brackets, channels and end caps.

Fixed height base assemblies have shared cantilever brackets for adjacent worksurfaces and midspan support brackets for every worksurface.

For legs and cantilever brackets specify one paint finish for all.

## Application Notes

Complete base assemblies include all base components necessary to support worksurfaces. Specify screens, power components and cable trays separately. Base assemblies include end legs, intermediate leg (where required), beams, trusses, cantilever brackets, mid span support brackets, top channel and end caps.

No table on this page has beams longer than 15'.

Base assemblies correspond to:  
 10': four 60"x36"D worksurfaces  
 12': four 72"x36"D worksurfaces  
 15': six 60"x36"D worksurfaces  
 18': six 72"x36"D worksurfaces  
 20': eight 60"x36"D worksurfaces  
 24': eight 72"x36"D worksurfaces  
 25': ten 60"x36"D worksurfaces

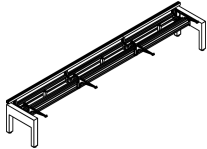
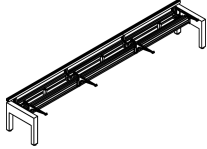
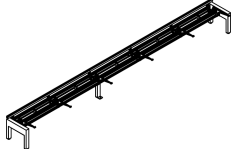

# Complete base assemblies fixed height 36" D single sided

| description  | nominal                | w    | d                                | h                                | pattern number              | P2       | P3       |
|--|------------------------|------|----------------------------------|----------------------------------|-----------------------------|----------|----------|
|  Base assembly, continuous            | 10' single sided       | 120" | 28 <sup>3</sup> / <sub>4</sub> " | 28 <sup>1</sup> / <sub>2</sub> " | <b>XTB1 BAS 36S10CF ( )</b> | \$8,426. | \$8,656. |
|  | 12' single sided       | 144" | 28 <sup>3</sup> / <sub>4</sub> " | 28 <sup>1</sup> / <sub>2</sub> " | <b>XTB1 BAS 36S12CF ( )</b> | 8,811.   | 9,042.   |
|  | 15' single sided       | 180" | 28 <sup>3</sup> / <sub>4</sub> " | 28 <sup>1</sup> / <sub>2</sub> " | <b>XTB1 BAS 36S15CF ( )</b> | 10,049.  | 10,293.  |
|  Base assembly, segmented             | 10' + 5' single sided  | 180" | 28 <sup>3</sup> / <sub>4</sub> " | 28 <sup>1</sup> / <sub>2</sub> " | <b>XTB1 BAS 36S15SF ( )</b> | 9,407.   | 9,651.   |
|  Base assembly, with intermediate leg | 12' + 6' single sided  | 216" | 28 <sup>3</sup> / <sub>4</sub> " | 28 <sup>1</sup> / <sub>2</sub> " | <b>XTB1 BAS 36S18SF ( )</b> | 10,413.  | 10,657.  |
|  | 10' + 10' single sided | 240" | 28 <sup>3</sup> / <sub>4</sub> " | 28 <sup>1</sup> / <sub>2</sub> " | <b>XTB1 BAS 36S20SF ( )</b> | 11,619.  | 11,877.  |
|  | 12' + 12' single sided | 288" | 28 <sup>3</sup> / <sub>4</sub> " | 28 <sup>1</sup> / <sub>2</sub> " | <b>XTB1 BAS 36S24SF ( )</b> | 13,995.  | 14,252.  |
|  | 15' + 10' single sided | 300" | 28 <sup>3</sup> / <sub>4</sub> " | 28 <sup>1</sup> / <sub>2</sub> " | <b>XTB1 BAS 36S25SF ( )</b> | 14,847.  | 15,119.  |

## Order Code

|            |                           |
|------------|---------------------------|
| Example:   | <b>XTB1BAS36S18SF 613</b> |
| <b>XT</b>  | Crinion Open Table        |
| <b>B1</b>  | Base components           |
| <b>BAS</b> | Assembly                  |
| <b>36</b>  | Depth                     |
| <b>S</b>   | Single                    |
| <b>18</b>  | Width                     |
| <b>S</b>   | Segmented                 |
| <b>F</b>   | Fixed height              |
| <b>613</b> | finish                    |

## Specifications

Base assemblies include end legs, beams, trusses, cantilever brackets, channels and end caps.

Fixed height base assemblies have shared cantilever brackets for adjacent worksurfaces and midspan support brackets for every worksurface.

For legs and cantilever brackets specify one paint finish for all.

## Application Notes

Complete base assemblies include all base components necessary to support worksurfaces. Specify screens, power components and cable trays separately. Base assemblies include end legs, intermediate leg (where required), beams, trusses, cantilever brackets, mid span support brackets, top channel and end caps.

No table on this page has beams longer than 15'.

Base assemblies correspond to:  
 10': two 60"x36"D worksurfaces  
 12': two 72"x36"D worksurfaces  
 15': three 60"x36"D worksurfaces  
 18': three 72"x36"D worksurfaces  
 20': four 60"x36"D worksurfaces  
 24': four 72"x36"D worksurfaces  
 25': five 60"x36"D worksurfaces

# Complete base assemblies adjustable height 36" D dual

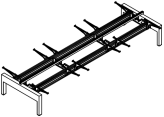
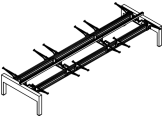
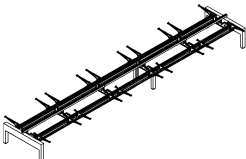
| description  | nominal        | w    | d   | h       | pattern number              | P2       | P3       |
|--|----------------|------|-----|---------|-----------------------------|----------|----------|
|  Base assembly, continuous            | 10' dual       | 120" | 54" | 28 1/2" | <b>XTB1 BAS 36D10CA ( )</b> | \$9,694. | \$9,972. |
|  | 12' dual       | 144" | 54" | 28 1/2" | <b>XTB1 BAS 36D12CA ( )</b> | 10,079.  | 10,358.  |
|  | 15' dual       | 180" | 54" | 28 1/2" | <b>XTB1 BAS 36D15CA ( )</b> | 11,995.  | 12,316.  |
|  Base assembly, segmented             | 10' + 5' dual  | 180" | 54" | 28 1/2" | <b>XTB1 BAS 36D15SA ( )</b> | 12,958.  | 13,279.  |
|  Base assembly, with intermediate leg | 12' + 6' dual  | 216" | 54" | 28 1/2" | <b>XTB1 BAS 36D18SA ( )</b> | 14,295.  | 14,659.  |
|  | 10' + 10' dual | 240" | 54" | 28 1/2" | <b>XTB1 BAS 36D20SA ( )</b> | 16,178.  | 16,585.  |
|  | 12' + 12' dual | 288" | 54" | 28 1/2" | <b>XTB1 BAS 36D24CA ( )</b> | 16,949.  | 17,355.  |
|  | 15' + 10' dual | 300" | 54" | 28 1/2" | <b>XTB1 BAS 36D25CA ( )</b> | 18,479.  | 18,928.  |

## Order Code

|                                    |                    |
|------------------------------------|--------------------|
| <b>Example: XTB1BAS36D18SA 613</b> |                    |
| <b>XT</b>                          | Crinion Open Table |
| <b>B1</b>                          | Base components    |
| <b>BAS</b>                         | Assembly           |
| <b>36</b>                          | Depth              |
| <b>D</b>                           | Dual               |
| <b>18</b>                          | Width              |
| <b>S</b>                           | Segmented          |
| <b>A</b>                           | Adjustable height  |
| <b>613</b>                         | finish             |

## Specifications

Base assemblies include end legs, beams, trusses, cantilever brackets, channels and end caps.

For legs and cantilever brackets specify paint finish.

## Application Notes



Complete base assemblies include all base components necessary to support worksurfaces. Specify screens, power components and cable trays separately. Base assemblies include end legs, intermediate leg (where required), beams, trusses, cantilever brackets, top channel and end caps.

No table on this page has beams longer than 15'.

Base assemblies correspond to:  
 10': four 60"x36"D worksurfaces  
 12': four 72"x36"D worksurfaces  
 15': six 60"x36"D worksurfaces  
 18': six 72"x36"D worksurfaces  
 20': eight 60"x36"D worksurfaces  
 24': eight 72"x36"D worksurfaces  
 25': ten 60"x36"D worksurfaces

# Complete base assemblies adjustable height 36" D single sided

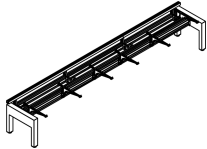
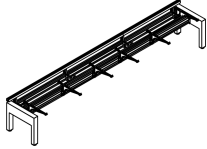
Crinion Open Table

| description  | nominal                | w    | d                                | h                                | pattern number              | P2       | P3       |
|--|------------------------|------|----------------------------------|----------------------------------|-----------------------------|----------|----------|
|  Base assembly, continuous            | 10' single sided       | 120" | 28 <sup>3</sup> / <sub>4</sub> " | 28 <sup>1</sup> / <sub>2</sub> " | <b>XTB1 BAS 36S10CA ( )</b> | \$8,517. | \$8,753. |
|  | 12' single sided       | 144" | 28 <sup>3</sup> / <sub>4</sub> " | 28 <sup>1</sup> / <sub>2</sub> " | <b>XTB1 BAS 36S12CA ( )</b> | 8,902.   | 9,138.   |
|  | 15' single sided       | 180" | 28 <sup>3</sup> / <sub>4</sub> " | 28 <sup>1</sup> / <sub>2</sub> " | <b>XTB1 BAS 36S15CA ( )</b> | 10,283.  | 10,540.  |
|  Base assembly, segmented             | 10' + 5' single sided  | 180" | 28 <sup>3</sup> / <sub>4</sub> " | 28 <sup>1</sup> / <sub>2</sub> " | <b>XTB1 BAS 36S15SA ( )</b> | 9,641.   | 9,898.   |
|  Base assembly, with intermediate leg | 12' + 6' single sided  | 216" | 28 <sup>3</sup> / <sub>4</sub> " | 28 <sup>1</sup> / <sub>2</sub> " | <b>XTB1 BAS 36S18SA ( )</b> | 10,647.  | 10,903.  |
|  | 10' + 10' single sided | 240" | 28 <sup>3</sup> / <sub>4</sub> " | 28 <sup>1</sup> / <sub>2</sub> " | <b>XTB1 BAS 36S20SA ( )</b> | 11,995.  | 12,273.  |
|  | 12' + 12' single sided | 288" | 28 <sup>3</sup> / <sub>4</sub> " | 28 <sup>1</sup> / <sub>2</sub> " | <b>XTB1 BAS 36S24SA ( )</b> | 14,370.  | 14,648.  |
|  | 15' + 10' single sided | 300" | 28 <sup>3</sup> / <sub>4</sub> " | 28 <sup>1</sup> / <sub>2</sub> " | <b>XTB1 BAS 36S25SA ( )</b> | 15,365.  | 15,665.  |

## Order Code

|                                    |                    |
|------------------------------------|--------------------|
| <b>Example: XTB1BAS36S18SA 613</b> |                    |
| <b>XT</b>                          | Crinion Open Table |
| <b>B1</b>                          | Base components    |
| <b>BAS</b>                         | Assembly           |
| <b>36</b>                          | Depth              |
| <b>S</b>                           | Single             |
| <b>18</b>                          | Width              |
| <b>S</b>                           | Segmented          |
| <b>A</b>                           | Adjustable height  |
| <b>613</b>                         | finish             |

## Specifications

Base assemblies include end legs, beams, trusses, cantilever brackets, channels and end caps.

For legs and cantilever brackets specify paint finish.

## Application Notes

Complete base assemblies include all base components necessary to support worksurfaces. Specify screens, power components and cable trays separately. Base assemblies include end legs, intermediate leg (where required), beams, trusses, cantilever brackets, top channel and end caps.

No table on this page has beams longer than 15'.

Base assemblies correspond to:  
 10': two 60"x36"D worksurfaces  
 12': two 72"x36"D worksurfaces  
 15': three 60"x36"D worksurfaces  
 18': three 72"x36"D worksurfaces  
 20': four 60"x36"D worksurfaces  
 24': four 72"x36"D worksurfaces  
 25': five 60"x36"D worksurfaces

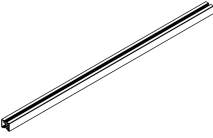
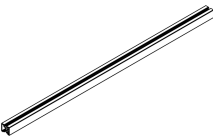
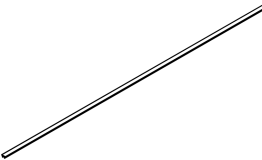
| description   | nominal | w    | d      | h  | pattern number    | list price |
|---|---------|------|--------|----|-------------------|------------|
|  <p>Top channel</p>                            | 4'      | 48"  | 2 1/2" | 2" | <b>XTC1 48A</b>   | \$144.     |
|   | 5'      | 60"  | 2 1/2" | 2" | <b>XTC1 60A</b>   | 182.       |
|   | 6'      | 72"  | 2 1/2" | 2" | <b>XTC1 72A</b>   | 214.       |
|   | 8'      | 96"  | 2 1/2" | 2" | <b>XTC1 96A</b>   | 289.       |
|   | 10'     | 120" | 2 1/2" | 2" | <b>XTC1 120A</b>  | 364.       |
|   | 12'     | 144" | 2 1/2" | 2" | <b>XTC1 144A</b>  | 428.       |
| Top channel end cap   |         |      | 2 1/2" | 2" | <b>XTC1 END</b>   | 32.        |
|  <p>Top channel for frameless glass addups</p> | 4'      | 48"  | 2 1/2" | 2" | <b>XTCA1 48A</b>  | 214.       |
|   | 5'      | 60"  | 2 1/2" | 2" | <b>XTCA1 60A</b>  | 257.       |
|   | 6'      | 72"  | 2 1/2" | 2" | <b>XTCA1 72A</b>  | 305.       |
|   | 8'      | 96"  | 2 1/2" | 2" | <b>XTCA1 96A</b>  | 396.       |
|   | 10'     | 120" | 2 1/2" | 2" | <b>XTCA1 120A</b> | 482.       |
|   | 12'     | 144" | 2 1/2" | 2" | <b>XTCA1 144A</b> | 599.       |
|  <p>Top channel filler</p>                    |         | 48"  |        |    | <b>XTCF 48</b>    | 27.        |
|   |         | 60"  |        |    | <b>XTCF 60</b>    | 37.        |
|   |         | 72"  |        |    | <b>XTCF 72</b>    | 37.        |

### Order Code

|                          |                    |
|--------------------------|--------------------|
| Example: <b>XTC1120A</b> |                    |
| <b>XT</b>                | Crinion open table |
| <b>C1</b>                | Top channel        |
| <b>120</b>               | Width              |
| <b>A</b>                 | Finish             |

### Specifications

Top channels are extruded aluminum with natural anodized finish.

Top channel end caps are die cast aluminum.

### Application Notes

Crinion Open Table top channel supports privacy screens and suspended raceway components at any point. Top channel is required at the center of dual tables.

Top channels and end caps are included in complete base assemblies.

Top channels correspond in width to one or two worksurface widths.

# Beams for single sided or dual tables

## 24" D

Crinion Open Table

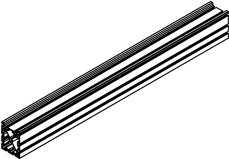
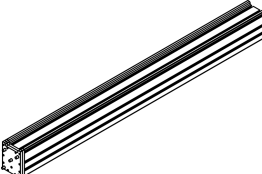
| description   | nominal | w    | d  | h  | pattern number   | list price |
|---|---------|------|----|----|------------------|------------|
|  Starter beam set for 24" D          | 5'      | 52"  | 3" | 8" | <b>XTB1TB5C</b>  | \$963.     |
|   | 6'      | 64"  | 3" | 8" | <b>XTB1TB6C</b>  | 1,070.     |
|   | 8'      | 88"  | 3" | 8" | <b>XTB1TB8C</b>  | 1,284.     |
|   | 10'     | 112" | 3" | 8" | <b>XTB1TB10C</b> | 1,552.     |
|   | 12'     | 136" | 3" | 8" | <b>XTB1TB12C</b> | 1,819.     |
|   | 15'     | 172" | 3" | 8" | <b>XTB1TB15C</b> | 2,247.     |
|  Extension beam set for 24" D tables | 4'      | 48"  | 3" | 8" | <b>XTB1TB4E</b>  | 1,284.     |
|   | 5'      | 60"  | 3" | 8" | <b>XTB1TB5E</b>  | 1,391.     |
|   | 6'      | 72"  | 3" | 8" | <b>XTB1TB6E</b>  | 1,498.     |
|   | 8'      | 96"  | 3" | 8" | <b>XTB1TB8E</b>  | 1,712.     |
|   | 10'     | 120" | 3" | 8" | <b>XTB1TB10E</b> | 1,980.     |
|   | 12'     | 144" | 3" | 8" | <b>XTB1TB12E</b> | 2,247.     |
|   | 15'     | 180" | 3" | 8" | <b>XTB1TB15E</b> | 2,675.     |

### Order Code

|                           |                    |
|---------------------------|--------------------|
| Example: <b>XTB1TB15C</b> |                    |
| <b>XT</b>                 | Crinion Open Table |
| <b>B1</b>                 | Base components    |
| <b>TB</b>                 | Dual beam set      |
| <b>15</b>                 | Width              |
| <b>C</b>                  | Starter            |

### Specifications

Beams are extruded aluminum with natural anodized finish.

### Application Notes

Crinion Open Table bases are assembled from beams, end legs, intermediate legs and trusses.

Beam sets can be used with either dual or single sided tables. Table bases require one starter beam and extension beam adding up to the length as the sum of the worksurface widths on one side.

Extension beam sets are specified only to add on to starter sets or other extension beams.

Beam sets must be supported by intermediate legs at least every 16'. Intermediate leg must be positioned at beam truss location, where two worksurfaces meet.

# Beams for dual tables

## 30" and 36" D

Crinion Open Table

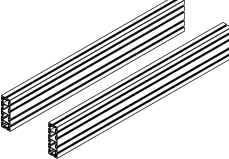
| description   | nominal | w    |    | h  | pattern number   | list price |
|---|---------|------|----|----|------------------|------------|
| Starter beam set for dual table<br>30" or 36" (pair of beams)  | 5'      | 52"  | 3" | 8" | <b>XTB1DB5C</b>  | \$1,284.   |
|   | 6'      | 64"  | 3" | 8" | <b>XTB1DB6C</b>  | 1,391.     |
|   | 8'      | 88"  | 3" | 8" | <b>XTB1DB8C</b>  | 1,819.     |
|   | 10'     | 112" | 3" | 8" | <b>XTB1DB10C</b> | 2,140.     |
|   | 12'     | 136" | 3" | 8" | <b>XTB1DB12C</b> | 2,461.     |
|   | 15'     | 172" | 3" | 8" | <b>XTB1DB15C</b> | 2,889.     |

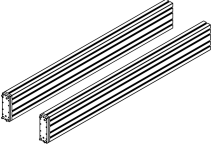
|   |     |      |    |    |                  |        |
|---|-----|------|----|----|------------------|--------|
| Extension beam set for dual table<br>30" or 36" (pair of beams)  | 4'  | 48"  | 3" | 8" | <b>XTB1DB4E</b>  | 1,712. |
|   | 5'  | 60"  | 3" | 8" | <b>XTB1DB5E</b>  | 1,712. |
|   | 6'  | 72"  | 3" | 8" | <b>XTB1DB6E</b>  | 1,819. |
|   | 8'  | 96"  | 3" | 8" | <b>XTB1DB8E</b>  | 2,247. |
|   | 10' | 120" | 3" | 8" | <b>XTB1DB10E</b> | 2,568. |
|   | 12' | 144" | 3" | 8" | <b>XTB1DB12E</b> | 2,889. |
|   | 15' | 180" | 3" | 8" | <b>XTB1DB15E</b> | 3,317. |

### Order Code

|                           |                    |
|---------------------------|--------------------|
| Example: <b>XTB1DB15C</b> |                    |
| <b>XT</b>                 | Crinion Open Table |
| <b>B1</b>                 | Base components    |
| <b>DB</b>                 | Dual beam set      |
| <b>15</b>                 | Width              |
| <b>C</b>                  | Starter            |

### Specifications

Beams are extruded aluminum with natural anodized finish.

Beam sets are starter or extension.

Extension beam sets are specified only to add on to starter sets or other extension beams.

### Application Notes

Crinion Open Table bases are assembled from beams, end legs, intermediate legs and trusses. Beam sets may be used with either worksurface depth. Dual tables require one pair of main beams of the same nominal width as the sum of the worksurfaces on each side.

Beam sets must be supported by intermediate legs at least every 16'. Intermediate leg must be positioned at beam truss location, where two worksurfaces meet.

# Beams for single sided tables 30" and 36" D

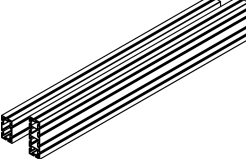
| description   | nominal | w    | d | h  | pattern number   | P3       |
|---|---------|------|---|----|------------------|----------|
| Starter beam set for single sided table<br>30" or 36" ( main and back beam)  | 5'      | 52"  |   | 8" | <b>XTB1SB5C</b>  | \$1,124. |
|   | 6'      | 64"  |   | 8" | <b>XTB1SB6C</b>  | 1,177.   |
|   | 8'      | 88"  |   | 8" | <b>XTB1SB8C</b>  | 1,552.   |
|   | 10'     | 112" |   | 8" | <b>XTB1SB10C</b> | 1,819.   |
|   | 12'     | 136" |   | 8" | <b>XTB1SB12C</b> | 2,140.   |
|   | 15'     | 172" |   | 8" | <b>XTB1SB15C</b> | 2,461.   |

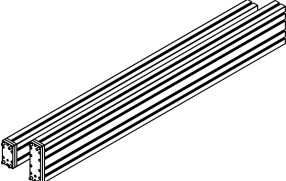
|   |     |      |  |    |                  |        |
|---|-----|------|--|----|------------------|--------|
| Extension beam set for single sided table<br>30" or 36" ( main and back beam)  | 4'  | 48"  |  | 8" | <b>XTB1SB4E</b>  | 1,498. |
|   | 5'  | 60"  |  | 8" | <b>XTB1SB5E</b>  | 1,552. |
|   | 6'  | 72"  |  | 8" | <b>XTB1SB6E</b>  | 1,605. |
|   | 8'  | 96"  |  | 8" | <b>XTB1SB8E</b>  | 1,980. |
|   | 10' | 120" |  | 8" | <b>XTB1SB10E</b> | 2,247. |
|   | 12' | 144" |  | 8" | <b>XTB1SB12E</b> | 2,568. |
|   | 15' | 180" |  | 8" | <b>XTB1SB15E</b> | 2,889. |

### Order Code

|                           |                    |
|---------------------------|--------------------|
| Example: <b>XTB1DB15C</b> |                    |
| <b>XT</b>                 | Crinion Open Table |
| <b>B1</b>                 | Base components    |
| <b>DB</b>                 | Dual beam set      |
| <b>15</b>                 | Width              |
| <b>C</b>                  | Starter            |

### Specifications

Beams are extruded aluminum with natural anodized finish.

Beam sets are starter or extension.

Extension beam sets are specified only to add on to starter sets or other extension beams.

### Application Notes

Crinion Open Table bases are assembled from beams, end legs, intermediate legs and trusses. Beam sets may be used with either worksurface depth. Single sided tables require one pair of main beams of the same nominal width as the sum of the worksurfaces on each side.

Beam sets must be supported by intermediate legs at least every 16'. Intermediate leg must be positioned at beam truss location, where two worksurfaces meet.

| description                               | application       | w  | d   | h   | pattern number       | P2       | P3       |
|---|-------------------|----|-----|-----|----------------------|----------|----------|
| End leg for dual tables<br>(pair of legs) | 24" D worksurface | 4" |     | 24" | <b>XTB1EDD24 ( )</b> | \$3,873. | \$4,066. |
|   | 30" D worksurface | 4" | 54" | 24" | <b>XTB1EDD30 ( )</b> | 3,873.   | 4,066.   |
|   | 36" D worksurface | 4" | 54" | 24" | <b>XTB1EDD36 ( )</b> | 3,873.   | 4,066.   |

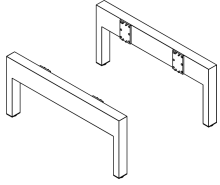

|   |                        |    |        |     |                      |      |      |
|---|------------------------|----|--------|-----|----------------------|------|------|
| Intermediate leg for dual table<br>(pair of legs) | 24" D worksurfaces     | 4" | 2 1/8" | 16" | <b>XTB1LDD24 ( )</b> | 562. | 589. |
|   | 30"&36" D worksurfaces | 4" | 2 1/8" | 16" | <b>XTB1LDD ( )</b>   | 813. | 856. |

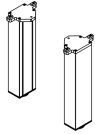

|  |       |  |  |  |                        |      |      |
|--|-------|--|--|--|------------------------|------|------|
| Shroud for intermediate leg infeed kit | 30" D |  |  |  | <b>XTB1 SLIK30 ( )</b> | 173. | 182. |
|  | 36" D |  |  |  | <b>XTB1 SLIK36 ( )</b> | 203. | 214. |

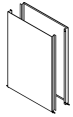

|  |                   |   |    |    |                      |        |        |
|--|-------------------|---|----|----|----------------------|--------|--------|
| End leg for end counters both ends<br>(pair of legs) | 48" W end counter | 4 | 44 | 24 | <b>XTB1XDD24 ( )</b> | 4,141. | 4,334. |
|  | 60" W end counter | 4 | 54 | 24 | <b>XTB1XDD30 ( )</b> | 4,141. | 4,334. |
|  | 72" W end counter | 4 | 54 | 24 | <b>XTB1XDD36 ( )</b> | 4,141. | 4,334. |

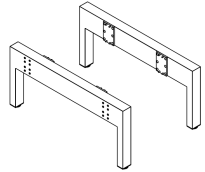

| Order Code                    | Specifications                                  | Application Notes  |
|-------------------------------|---|--|
| Example: <b>XTB1EDD30 118</b> | Specify paint finish code after pattern number. | <p>Crinion Open Table bases are assembled from main beams, end legs, intermediate legs and trusses. After selecting starter or segmented beam sets, specify legs to support each end of beams. End legs support main beams at each end of a table.</p> <p>Dual end legs for end counters have threaded metal inserts on the outside of the leg to accept two fixed height or adjustable cantilevers for end counters.</p> <p>Intermediate legs must be specified to provide support under beam sets spanning longer than 16'. Intermediate legs may be positioned under beams at any beam truss location. End legs include beam end plates and hardware.</p> |
| <b>XT</b> Crinion Open Table  |   |  |
| <b>B1</b> Base components     |   |  |
| <b>E</b> End leg              |   |  |
| <b>D</b> Dual                 |   |  |
| <b>D</b> Desk height          |   |  |
| <b>30</b> Depth of tops       |   |  |
| <b>118</b> Finish             |   |  |
|                               |   | <p>Shroud for intermediate leg kit encloses the space between legs to protect power, data and communication cables between floor and table base. Side covers may be removed for access.</p> <p>Shroud for 24"d intermediate leg is U-shaped cover that attaches to side of intermediate leg for 24"d or any single sided intermediate leg.</p>   |



| description  | application       | w | d  | h  | pattern number       | P2       | P3       |
|--|-------------------|---|----|----|----------------------|----------|----------|
| End leg for end counters one end only (pair of legs) | 48" W end counter | 4 | 44 | 24 | <b>XTB1YDD24 ( )</b> | \$4,007. | \$4,200. |
|  | 60" W end counter | 4 | 54 | 24 | <b>XTB1YDD30 ( )</b> | 4,007.   | 4,200.   |
|  | 72" W end counter | 4 | 54 | 24 | <b>XTB1YDD36 ( )</b> | 4,007.   | 4,200.   |

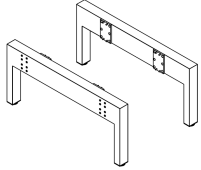

### Order Code

|            |                      |
|------------|----------------------|
| Example:   | <b>XTB1EDD30 118</b> |
| <b>XT</b>  | Crinion Open Table   |
| <b>B1</b>  | Base components      |
| <b>E</b>   | End leg              |
| <b>D</b>   | Dual                 |
| <b>D</b>   | Desk height          |
| <b>30</b>  | Depth of tops        |
| <b>118</b> | Finish               |

### Specifications

Specify paint finish code after pattern number.

### Application Notes

Crinion Open Table bases are assembled from main beams, end legs, intermediate legs and trusses. After selecting starter or segmented beam sets, specify legs to support each end of beams. End legs support main beams at each end of a table.

Dual end legs for end counters have threaded metal inserts on the outside of the leg to accept two fixed height or adjustable cantilevers for end counters.

Intermediate legs must be specified to provide support under beam sets spanning longer than 16'. Intermediate legs may be positioned under beams at any beam truss location. End legs include beam end plates and hardware.

Shroud for intermediate leg kit encloses the space between legs to protect power, data and communication cables between floor and table base. Side covers may be removed for access.

Shroud for 24"d intermediate leg is U-shaped cover that attaches to side of intermediate leg for 24"d or any single sided intermediate leg.

| description                                       | application       | width | depth | height | pattern number       | P2       | P3       |
|---|-------------------|-------|-------|--------|----------------------|----------|----------|
| End leg for single sided tables<br>(pair of legs) | 24" D worksurface | 4"    |       | 24"    | <b>XTB1ESD24 ( )</b> | \$3,873. | \$4,066. |
|   | 30" D worksurface | 4"    |       | 24"    | <b>XTB1ESD30 ( )</b> | 3,873.   | 4,066.   |
|   | 36" D worksurface | 4"    |       | 24"    | <b>XTB1ESD36 ( )</b> | 3,873.   | 4,066.   |

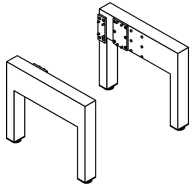

|   |                        |    |        |     |                      |      |      |
|---|------------------------|----|--------|-----|----------------------|------|------|
| Intermediate leg for single sided table<br>(pair of legs) | 24" D worksurfaces     | 4" | 2 1/8" | 16" | <b>XTB1LSD24 ( )</b> | 562. | 589. |
|   | 30"&36" D worksurfaces | 4" | 2 1/8" | 16" | <b>XTB1LSD ( )</b>   | 562. | 589. |

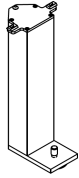

### Order Code

|            |                      |
|------------|----------------------|
| Example:   | <b>XTB1ESD30 118</b> |
| <b>XT</b>  | Crinion Open Table   |
| <b>B1</b>  | Base components      |
| <b>E</b>   | End leg              |
| <b>S</b>   | Single               |
| <b>D</b>   | Desk height          |
| <b>30</b>  | Depth of tops        |
| <b>118</b> | Finish               |

### Specifications

Specify paint finish code after pattern number.



### Application Notes

Crinion Open Table bases are assembled from main beams, end legs, intermediate legs and trusses. After selecting starter or segmented beam sets, specify legs to support each end of beams. End legs support main beams at each end of a table.

Dual end legs for end counters have threaded metal inserts on the outside of the leg to accept two fixed height or adjustable cantilevers for end counters.

Intermediate legs must be specified to provide support under beam sets spanning longer than 15'. Intermediate legs may be positioned under beams at any beam truss location. End legs include beam end plates and hardware.

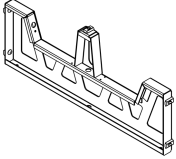
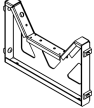
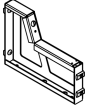
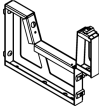

Shroud for intermediate leg kit encloses the space between legs to protect power, data and communication cables between floor and table base. Side covers may be removed for access.

| description   | application       | w  | d   | h   | pattern number       | P3     |
|---|-------------------|----|-----|-----|----------------------|--------|
|    | 30" D worksurface | 3" | 11" | 10" | <b>XTB1XD30 ( )</b>  | \$471. |
|   | 36" D worksurface | 3" | 23" | 10" | <b>XTB1XD36 ( )</b>  | 514.   |
|    | 30" D worksurface | 3" | 11" | 8"  | <b>XTB1XD30N ( )</b> | 289.   |
|   | 36" D worksurface | 3" | 23" | 8"  | <b>XTB1XD36N ( )</b> | 332.   |
|    | 30" D worksurface | 3" |     |     | <b>XTB1XS30N ( )</b> | 289.   |
|   | 36" D worksurface | 3" |     |     | <b>XTB1XS36N ( )</b> | 332.   |
|  | 30" D worksurface | 3" |     |     | <b>XTB1XS30 ( )</b>  | 471.   |
|   | 36" D worksurface | 3" |     |     | <b>XTB1XS36 ( )</b>  | 514.   |
|  | 24" D worksurface |    |     |     | <b>XTB1T24 ( )</b>   | 161.   |

| Order Code                          | Specifications                               | Application Notes   |
|-------------------------------------|--|---|
| Example: <b>XTB1XD30 613</b>        | Beam trusses are silver (613) paint finish . | Crinion Open Table bases are assembled from beams, end legs, intermediate legs and trusses. After selecting beams and leg kits, specify trusses between beams.<br><br>Specify beam trusses adjacent to each end leg and at each worksurface junction. |
| <b>XT</b> Crinion Open Table        |  |   |
| <b>B1</b> Base components           |  |   |
| <b>XD</b> Beam truss for dual table |  |   |
| <b>30</b> Depth                     |  |   |
| <b>613</b> Finish                   |  |   |
|                                     |  | Beam trusses with no top channel support must be specified in combination with intermediate legs planned other than at worksurface junctions (as for cable infeed shrouds).   |

# Worksurface support cantilever and mid span support

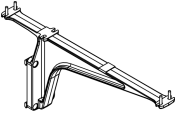
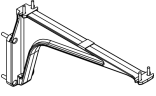
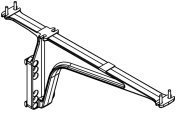
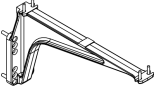
Crinion Open Table

| description   | w  | d   | h        | pattern number      | P2     | P3     |
|---|----|-----|----------|---------------------|--------|--------|
| Cantilever, fixed height 30" or 36" D<br>      | 3" | 24" | 9"       | <b>XTB1FC ( )</b>   | \$194. | \$203. |
| Cantilever, fixed height 24" D<br>             | 3" | 19" | 9"       | <b>XTB1FC24 ( )</b> | 194.   | 203.   |
| Cantilever, adjustable height 30" or 36" D<br> | 3" | 24" | 9" - 12" | <b>XTB1AC ( )</b>   | 214.   | 225.   |
| Cantilever, adjustable height 24" D<br>       | 3" | 24" | 9" - 12" | <b>XTB1AC24 ( )</b> | 214.   | 225.   |
| Mid span support<br>                         | 2  | 2   | 8        | <b>XTB1MB ( )</b>   | 92.    | 96.    |

| Order Code                        | Specifications   | Application Notes  |
|-----------------------------------|--|--|
| Example: <b>XTB1FC 118</b>        | Specify paint finish code after pattern number.  | Cantilever brackets are required to support each end of worksurfaces.  |
| <b>XT</b> Crinion Open Table      |  |  |
| <b>B1</b> Base components         |  | Brackets can be positioned at ends of worksurface, or inset at legs or floorstanding pedestal locations.   |
| <b>FC</b> Fixed height cantilever | <b>48" worksurfaces:</b> shared cantilevers each end or two adjustable per worksurface.                                    | Fixed height cantilevers can be shared between adjacent worksurfaces. Mid span support bracket must be specified for worksurface spans exceeding 4'. |
| <b>118</b> Finish                 | <b>60" and 72" worksurfaces:</b> shared cantilevers each end plus mid span support or two adjustable cantilevers inset 8". | Fixed height cantilever supports worksurface at 28 1/2" H.   |
|                                   | <b>96" worksurfaces:</b> shared cantilevers at ends plus one in center or three adjustable cantilevers.                    | Adjustable cantilevers enable worksurfaces to be set at 27", 27 3/4", 28 1/2", 29 1/4" or 30" H.   |
|                                   | <b>96"x 24" with hinged door:</b> shared cantilever each end plus two mid span supports.                                   |  |
|                                   | <b>96"x 30" with hinged door:</b> shared cantilever each end plus 24"d cantilever as center support.                       |  |
|                                   | <b>96"x 36" with hinged door:</b> shared cantilever each end plus 24", 30" or 36"d cantilever as center support.           |  |

# Worksurface support *linking plate and cantilever for end counters*

Crinion Open Table

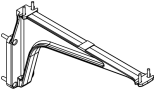
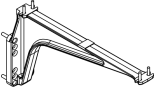
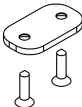
| description   | w  | d   | h        | pattern no.          | P2     | P3     |
|---|----|-----|----------|----------------------|--------|--------|
| Cantilever for end counters, fixed height   | 3" | 19" | 9"       | <b>XTB1FCEND ( )</b> | \$194. | \$203. |
|  |    |     |          |                      |        |        |
| Cantilever for end counters, adjustable height                                    | 3" | 19" | 9" - 12" | <b>XTB1ACEND ( )</b> | 214.   | 225.   |
|  |    |     |          |                      |        |        |
| Worksurface linking plate   |    |     |          | <b>XTB1LP</b>        |        | 26.    |
|  |    |     |          |                      |        |        |

| Order Code                        | Specification                                   | Application Notes   |
|-----------------------------------|---|---|
| Example: <b>XTB1FCEND 613</b>     | Specify paint finish code after pattern number. | Cantilever brackets are required to support each end of worksurface.  |
| <b>XT</b> Crinion Open Table      |   | Brackets attach to inserts on the outside face of end legs for end counters.  |
| <b>B1</b> Base components         |   | Fixed height cantilever supports for end counter at 28 1/2" H.  |
| <b>FC</b> Fixed height cantilever |   | Adjustable cantilevers for end counter enables end counter to be set at 28 1/2", 29 1/4" or 30" H.  |
| <b>END</b> for end counter        |   | A linking plate is recommended to join adjacent worksurfaces that are independently supported at the same height. Specify two linking plates at the junction of two worksurfaces, or four total for each end counter to two worksurfaces. A linking plate is not required where adjacent tops are supported by a shared fixed height cantilever bracket, as with complete fixed height base assemblies. Linking plates are recommended for complete adjustable height base assemblies in which tops are set at the same height. |
| <b>613</b> Finish                 |   |   |

# Modular Raceway

## 2 + 2 eight-wire Raceway with covers

Crinion Open Table

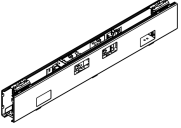
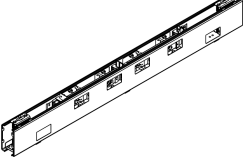
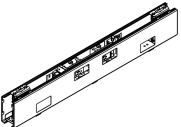
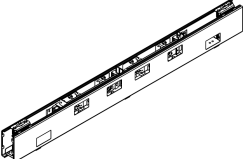

| description   | type | h  | w   | d  | pattern number       | list price |
|---|------|----|-----|----|----------------------|------------|
| Dual raceway, two power + two data outlets each side                                |      | 4" | 30" | 2" | <b>XTR1E30D ( )</b>  | \$239.     |
|    |      |    |     |    |                      |            |
| Dual raceway, four power + two data outlets each side                               |      | 4" | 42" | 2" | <b>XTR1E424D ( )</b> | 343.       |
|    |      |    |     |    |                      |            |
| Flat end cover  |      |    |     |    | <b>XTR1FE ( )</b>    | 20.        |
| Extended end cover  |      |    |     |    | <b>XTR1EE ( )</b>    | 20.        |
| Single sided raceway<br>two power + two data outlets each side                      |      | 4" | 30" | 2" | <b>XTR1E30S ( )</b>  | 239.       |
|   |      |    |     |    |                      |            |
| Single sided raceway<br>four power + two data outlets each side                     |      | 4" | 42" | 2" | <b>XTR1E424S ( )</b> | 343.       |
|  |      |    |     |    |                      |            |

| Order Code                    | Specifications  | Applications notes   |
|-------------------------------|---|--|
| Example: <b>XTR1E424D 613</b> |   |  |
| <b>XT</b> Crinion Open Table  | Eight wire 2+2 has two sets of circuits, each set with a separate ground and neutral.     | Raceway for Crinion Open Table is suspended from the top channel. For ideal access, worksurfaces should be specified with hinged power access. |
| <b>R1</b> Raceway             | Specify paint finish code after pattern number.   | Each raceway requires four or eight duplex outlets, on any of four circuits.   |
| <b>E</b> Eight wire system    | Covers have two openings for data/com outlet modules (Decora-size, specified separately). | Jumpers connect power from one raceway to another.   |
| <b>42</b> Width               |   | To join power between 30" raceways: specify 30" jumper for 60" desks and specify 42" jumper for 72" desks.                                     |
| <b>4</b> Extra outlets        |   | To join power between 42" raceways: specify 18" jumper for 60" desks and 30" jumper for 72" desks.   |
| <b>D</b> Dual Raceway         |   | Flat end covers enclose the end of a raceway at the end of a table.  |
| <b>613</b> Finish             |   | Extended end covers enclose the end of a raceway at the end of a table where power infeed is located   |

# Modular Raceway

## 2 + 2 eight-wire Raceway components

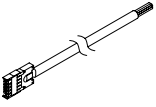
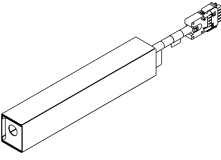
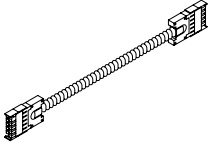
Crinion Open Table

| description   | type              | h | w   | d | pattern number  | list price |
|---|-------------------|---|-----|---|-----------------|------------|
| Modular infeed  |                   |   |     |   | <b>XTR1EPI</b>  | \$180.     |
|  |                   |   |     |   |                 |            |
| NYC infeed kit  |                   |   |     |   | <b>XTR1EPH</b>  | 411.       |
|  |                   |   |     |   |                 |            |
| Jumper  |                   |   | 18" |   | <b>XTR1EJ18</b> | 83.        |
|  |                   |   | 30" |   | <b>XTR1EJ30</b> | 94.        |
|   |                   |   | 42" |   | <b>XTR1EJ42</b> | 108.       |
| Duplex outlet   | Circuit A         |   |     |   | <b>XTR1DA</b>   | 30.        |
|  | Circuit B         |   |     |   | <b>XTR1DB</b>   | 30.        |
|   | Circuit X, orange |   |     |   | <b>XTR1DXO</b>  | 35.        |
|   | Circuit Y, orange |   |     |   | <b>XTR1DYO</b>  | 35.        |
| Outlet filler   | Set of 10         |   |     |   | <b>XTR1OF</b>   | 26.        |
| PDC module extension kit  | Set of 10         |   |     |   | <b>XTR1PDCX</b> | 105.       |

### Order Code

|                          |                    |
|--------------------------|--------------------|
| Example: <b>XTR1EJ18</b> |                    |
| <b>XT</b>                | Crinion Open Table |
| <b>R1</b>                | Raceway            |
| <b>E</b>                 | Eight wire         |
| <b>J</b>                 | Jumper             |
| <b>18</b>                | Width              |

### Specifications

Eight wire 2+2 has two sets of circuits, each set with a separate ground and neutral.

### Application Notes

Raceway for Crinion Open Table is suspended from the top channel. For ideal access, worksurfaces should be specified with hinged power access.

Each raceway requires four or eight duplex outlets, on any of four circuits.

Power infeed includes pigtail for connection to building power supply and connector to either end of any raceway.

NYC infeed kit includes junction box that mounts to inside face of beams in table base.

Jumper length is difference between worksurface width and specified raceway width.

# Modular Raceway

## 3 + 3 ten-wire Raceway with covers

Crinion Open Table

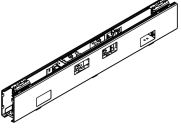
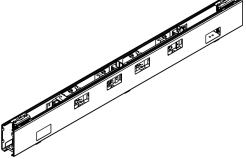
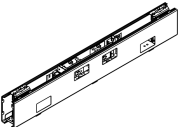
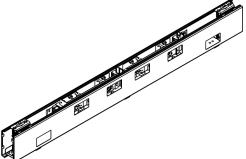
| description   | type | h  | w   | d  | pattern number       | list price |
|---|------|----|-----|----|----------------------|------------|
| Dual raceway, two power + two data outlets each side                                |      | 4" | 30" | 2" | <b>XTR1T30D ( )</b>  | \$250.     |
|    |      |    |     |    |                      |            |
| Dual raceway, four power + two data outlets each side                               |      | 4" | 42" | 2" | <b>XTR1T424D ( )</b> | 354.       |
|    |      |    |     |    |                      |            |
| Flat end cover  |      |    |     |    | <b>XTR1FE ( )</b>    | 20.        |
| Extended end cover  |      |    |     |    | <b>XTR1EE ( )</b>    | 20.        |
| Single sided raceway<br>two power + two data outlets each side                      |      | 4" | 30" | 2" | <b>XTR1T30S ( )</b>  | 250.       |
|   |      |    |     |    |                      |            |
| Single sided raceway<br>four power + two data outlets each side                     |      | 4" | 42" | 2" | <b>XTR1T424S ( )</b> | 354.       |
|  |      |    |     |    |                      |            |

### Order Code

|                               |                    |
|-------------------------------|--------------------|
| Example: <b>XTR1T424D 613</b> |                    |
| <b>XT</b>                     | Crinion Open Table |
| <b>R1</b>                     | Raceway            |
| <b>T</b>                      | Ten wire system    |
| <b>42</b>                     | Width              |
| <b>4</b>                      | Extra outlets      |
| <b>D</b>                      | Dual Raceway       |
| <b>613</b>                    | Finish             |

### Specifications

Ten wire 3+3 has two sets of three circuits, each set with a separate ground and neutral.

Specify paint finish code after pattern number.

Covers have two openings for data/com outlet modules (Decora-size, specified separately).

### Applications notes

Raceway for Crinion Open Table is suspended from the top channel. For ideal access, worksurfaces should be specified with hinged power access.

Each raceway requires four or eight duplex outlets, on any of six circuits.

Jumpers connect power from one raceway to another.

To join power between 42" raceways: specify 18" jumper for 60" desks and 30" jumper for 72" desks.

Flat end covers enclose the end of a raceway at the end of a table.

Extended end covers enclose the end of a raceway at the end of a table where power infeed is located.



To join power between 30" raceways: specify 30" jumper for 60" desks and specify 42" jumper for 72" desks.



# Modular Raceway

## 3 + 3 ten-wire Raceway components

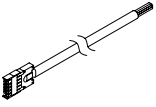
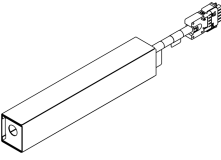
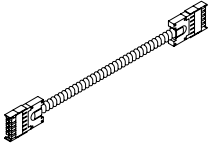
Crinion Open Table

| description   | type              | h | w   | d | pattern number  | list pricing |
|---|-------------------|---|-----|---|-----------------|--------------|
| Modular infeed  |                   |   |     |   | <b>XTR1TPI</b>  | \$202.       |
|  |                   |   |     |   |                 |              |
| NYC infeed kit  |                   |   |     |   | <b>XTR1TPH</b>  | 411.         |
|  |                   |   |     |   |                 |              |
| Jumper  |                   |   | 18" |   | <b>XTR1TJ18</b> | 94.          |
|  |                   |   | 30" |   | <b>XTR1TJ30</b> | 108.         |
|   |                   |   | 42" |   | <b>XTR1TJ42</b> | 125.         |
| Duplex outlet   | Circuit A         |   |     |   | <b>XTR1DA</b>   | 30.          |
|  | Circuit B         |   |     |   | <b>XTR1DB</b>   | 30.          |
|   | Circuit C         |   |     |   | <b>XTR1DC</b>   | 30.          |
|   | Circuit X, orange |   |     |   | <b>XTR1DXO</b>  | 35.          |
|   | Circuit Y, orange |   |     |   | <b>XTR1DYO</b>  | 35.          |
|   | Circuit Z, orange |   |     |   | <b>XTR1DZO</b>  | 35.          |
| Outlet filler   | Set of 10         |   |     |   | <b>XTR1OF</b>   | 26.          |
| PDC module extension kit  | Set of 10         |   |     |   | <b>XTR1PDCX</b> | 105.         |

### Order Code

|                          |                    |
|--------------------------|--------------------|
| Example: <b>XTR1TJ18</b> |                    |
| <b>XT</b>                | Crinion Open Table |
| <b>R1</b>                | Raceway            |
| <b>T</b>                 | Ten wire           |
| <b>J</b>                 | Jumper             |
| <b>18</b>                | Width              |

### Specifications

Ten wire 3+3 has two sets of three circuits, each set with a separate ground and neutral.

### Application Notes

Raceway for Crinion Open Table is suspended from the top channel. For ideal access, worksurfaces should be specified with hinged power access.

Each raceway requires four or eight duplex outlets, on any of six circuits.

Power infeed includes pigtail for connection to building power supply and connector to either end of any raceway.

NYC infeed kit includes junction box that mounts to inside face of beams in table base.

Jumper length is difference between worksurface width and specified raceway width.

| description  | type      | h  | w   | d  | pattern number      | list price |
|--|-----------|----|-----|----|---------------------|------------|
| Dual raceway, two power + two data outlets each side |           | 4" | 30" | 2" | <b>XTR1H30D ( )</b> | \$520.     |
| Flat end cover                                       |           |    |     |    | <b>XTR1FE ( )</b>   | 20.        |
| Extended end cover                                   |           |    |     |    | <b>XTR1EE ( )</b>   | 20.        |
| Outlet filler  | Set of 10 |    |     |    | <b>XTR1OF</b>       | 26.        |

| Order Code                   | Specifications  | Application Notes   |
|------------------------------|---|---|
| Example: <b>XTR1H30D 613</b> |   |   |
| <b>XT</b> Crinion Open Table | Specify paint finish code after pattern number.                                     | Raceway for Crinion Open Table is suspended from the top channel. For ideal access, worksurfaces should be specified with hinged power access.  |
| <b>R1</b> Raceway            |   |   |
| <b>H</b> Hard wire system    | Hardwired raceway components are designed for use in City of Chicago installations. |   |
| <b>30</b> Width              |   |   |
| <b>D</b> Dual Raceway        |   |   |
| <b>613</b> Finish            | Covers have two openings for data/com outlet modules (Decora-size, by others).      | Dual raceways are code-approved boxed with openings for two or four duplex outlets on each face, plus two additional openings for data/communications faceplates on each face. A continuous horizontal metal septum divides power wires and connections from data and communications cables. Each raceway requires Decora-type architectural power outlets, internal wiring and connecting cables, supplied by electrical contractor. |
|                              |   | Flat end covers enclose the raceway at the end of a table. Extended end covers provide an opening on the underside to permit cables to enter the raceway.   |
|                              |   | Specify outlet filler plates for unused outlet openings. Specify PDC extenders to create space behind data/com for cable distribution inside dual raceway.  |

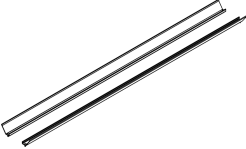
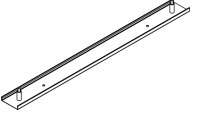
| description   | table size | w   | d  | pattern number        | list price |
|---|------------|-----|----|-----------------------|------------|
|  Cable trays, leg position, pair | 5', 30"D   | 53" | 1" | <b>XTCT6030LD ( )</b> | \$118.     |
|   | 5', 36"D   | 53" | 4" | <b>XTCT6036LD ( )</b> | 161.       |
|   | 6', 30"D   | 65" | 1" | <b>XTCT7230LD ( )</b> | 128.       |
|   | 6', 36"D   | 65" | 4" | <b>XTCT7236LD ( )</b> | 187.       |
|  Cable trays, full width, pair   | 5', 30"D   | 60" | 1" | <b>XTCT6030D ( )</b>  | 118.       |
|   | 5', 36"D   | 60" | 4" | <b>XTCT6036D ( )</b>  | 161.       |
|   | 6', 30"D   | 72" | 1" | <b>XTCT7230D ( )</b>  | 128.       |
|   | 6', 36"D   | 72" | 4" | <b>XTCT7236D ( )</b>  | 187.       |
| Data tray kit   |            | 42" |    | <b>XTDT423</b>        | 161.       |
|  Data + excess cable tray kit    |            | 42" |    | <b>XTDTX423</b>       | 268.       |
| Truss cable clips, set of 25  |            |     |    | <b>XTR1TCC25</b>      | 15.        |
| Beam cable clips, set of 50   |            |     |    | <b>XTR1BCC50</b>      | 214.       |
| Random attachment kit, set of 10  |            |     |    | <b>XTB1RAK</b>        | 75.        |

| Order Code  | Specifications  | Applications notes   |
|---|---|--|
| Example: <b>XTCT7230D 3</b><br><b>XT</b> Crinion Open Table<br><b>CT</b> Cable tray<br><b>72</b> Width<br><b>30</b> Depth<br><b>D</b> Dual table<br><b>3</b> Finish | Cable trays and Data tray kits are silver (613) paint finish. | Cable trays are optional kits to manage cables on each side of dual table bases. Specify cable trays for leg position at each end of the table. Specify cable trays, full width for other positions.<br><br>Data tray kit provides 3" wide horizontal open cable tray directly below either 30" or 42"W raceway module (at center of 60" or 72" desks). Data + excess tray kit provides two open trays below either raceway module, one 3"W and one 5"W. |
|   |   | Truss cable clips manage cables between raceway. Specify 2 clips per truss (one set of 10 for each five trusses).<br><br>Beam cable clips manage cables along the inside faces of each beam set.<br><br>Random attachment kit is a set of ten M8 slot nuts for attaching various products to the Crinion Open Table beams or top channel. Specify appropriate M8 screws separately.  |

# Center screens

## Acrylic, slatwall or combination surface

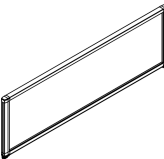
| description   | application            | w   | d   | h      | pattern no. | acrylic                   | slatwall | Combination acrylic / slatwall |     |
|---|------------------------|-----|-----|--------|-------------|---------------------------|----------|--------------------------------|-----|
|  | Center screen to 43" H | 48" | 48" | 1 1/4" | 14"         | <b>XTCS1 4814</b> ( ) ( ) | \$776.   | \$1,231.                       | n/a |
|   |                        | 60" | 60" | 1 1/4" | 14"         | <b>XTCS1 6014</b> ( ) ( ) | 1,017.   | 1,338.                         | n/a |
|   |                        | 72" | 72" | 1 1/4" | 14"         | <b>XTCS1 7214</b> ( ) ( ) | 1,070.   | 1,445.                         | n/a |

acrylic shown

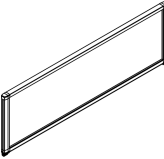
|   |   |     |     |        |     |                           |        |        |     |
|---|---|-----|-----|--------|-----|---------------------------|--------|--------|-----|
|  | Center screen to 43" H adjacent to end screen | 48" | 47" | 1 1/4" | 14" | <b>XTCS1 4714</b> ( ) ( ) | 776.   | 1,231. | n/a |
|   |   | 60" | 59" | 1 1/4" | 14" | <b>XTCS1 5914</b> ( ) ( ) | 1,017. | 1,338. | n/a |
|   |   | 72" | 71" | 1 1/4" | 14" | <b>XTCS1 7114</b> ( ) ( ) | 1,070. | 1,445. | n/a |

acrylic shown

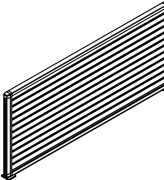
|  |                        |     |     |        |     |                           |        |        |        |
|--|------------------------|-----|-----|--------|-----|---------------------------|--------|--------|--------|
|  | Center screen to 50" H | 48" | 48" | 1 1/4" | 21" | <b>XTCS1 4821</b> ( ) ( ) | 910.   | 1,445. | 1,338. |
|  |                        | 60" | 60" | 1 1/4" | 21" | <b>XTCS1 6021</b> ( ) ( ) | 1,177. | 1,605. | 1,552. |
|  |                        | 72" | 72" | 1 1/4" | 21" | <b>XTCS1 7221</b> ( ) ( ) | 1,231. | 1,766. | 1,659. |

slatwall shown

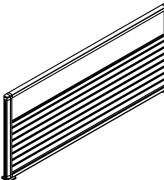
|   |   |     |     |        |     |                           |        |        |        |
|---|---|-----|-----|--------|-----|---------------------------|--------|--------|--------|
|  | Center screen to 50" H adjacent to end screen | 48" | 47" | 1 1/4" | 21" | <b>XTCS1 4721</b> ( ) ( ) | 910.   | 1,445. | 1,338. |
|   |   | 60" | 59" | 1 1/4" | 21" | <b>XTCS1 5921</b> ( ) ( ) | 1,177. | 1,605. | 1,552. |
|   |   | 72" | 71" | 1 1/4" | 21" | <b>XTCS1 7121</b> ( ) ( ) | 1,231. | 1,766. | 1,659. |

combination shown

| Order Code                   | Specifications   | Application Notes  |
|------------------------------|--|--|
| Example: <b>XTCS16014A O</b> |  |  |
| <b>XT</b> Crinion Open Table | Acrylic surface is always opal.                                  | Center screens mount to continuous channel at center of tables. Specify 14" H screens for a 43" horizon.                                       |
| <b>CS1</b> Center screen     | For acrylic screens specify suffixes AO.                         | Specify 21" H screens for a 50" horizon. Horizons are maintained regardless of worksurface height.   |
| <b>60</b> Width              | For Slatwall screens specify suffixes S613.                      | Combination screens include 14" high slatwall with acrylic above.  |
| <b>14</b> Height             | For combination acrylic/slatwall screens specify suffixes CO613. | Center screens include mounting hardware for standard top channel only.  |
| <b>A</b> Acrylic             | O - Opal   | Center screens adjacent to end screens allow space for dual or single sided end screens.   |
| <b>O</b> Opal                | Slatwall surface is painted silver.                              | Slatwall screens require buttresses to support Knoll Extra flat screen monitor arm. Consult Knoll Representative for pricing and availability. |
|                              | Frame is clear anodized aluminum.                                |  |

Side screens  
Acrylic surface only

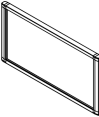
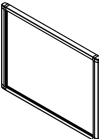
| description   | application                 | w   | d      | h   | pattern no.            | list | acrylic |
|---|-----------------------------|-----|--------|-----|------------------------|------|---------|
|  | 24" D worksurface           | 22" | 1 1/4" | 14" | <b>XTSS1 2414A ( )</b> |      | \$562.  |
|   | 30" D worksurface           | 28" | 1 1/4" | 14" | <b>XTSS1 3014A ( )</b> |      | 589.    |
|   | 36" D worksurface           | 34" | 1 1/4" | 14" | <b>XTSS1 3614A ( )</b> |      | 642.    |
|  | 24" D worksurface           | 22" | 1 1/4" | 21" | <b>XTSS1 2421A ( )</b> |      | 642.    |
|   | 30" D worksurface           | 28" | 1 1/4" | 21" | <b>XTSS1 3021A ( )</b> |      | 669.    |
|   | 36" D worksurface           | 34" | 1 1/4" | 21" | <b>XTSS1 3621A ( )</b> |      | 722.    |
| Side screen brackets ( pair )   | postformed edge worksurface |     |        |     | <b>XTSM1P</b>          | 225. |         |
|   | squared edge worksurface    |     |        |     | <b>XTSM1S</b>          | 150. |         |
|   | tapered edge worksurface    |     |        |     | <b>XTSM1K</b>          | 150. |         |

| Order Code                   | Specifications                    | Application Notes  |
|------------------------------|-----------------------------------|--|
| Example: <b>XTSS13014A O</b> | Acrylic surface is always opal.   | Side screens clamp to front and back edge of worksurface at any point (except at hinged access door). Specify side screen brackets separately. Specify 14" H screens for a 43" horizon. Specify 21" H screens for a 50" horizon. Side screens align in height with center screens when worksurfaces are set at 28 3/8" H.<br><br>* Consult your Knoll Representative for pricing and availability. |
| <b>XT</b> Crinion Open Table | O - Opal                          |  |
| <b>SS1</b> Side screen       | Frame is clear anodized aluminum. |  |
| <b>30</b> Width              |                                   |  |
| <b>14</b> Height             |                                   |  |
| <b>A</b> Acrylic             |                                   |  |
| <b>O</b> Opal                |                                   |  |

# Dual end screens

## Acrylic surface only

Crinion Open Table

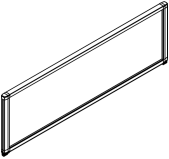
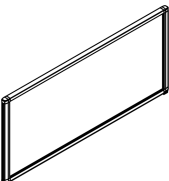
| description   | application                 | w   | d      | h   | pattern no.            | list | acrylic |
|---|-----------------------------|-----|--------|-----|------------------------|------|---------|
|  | 24" D dual                  | 48" | 1 1/4" | 14" | <b>XTES1 4814A ( )</b> |      | \$696.  |
|   | 30" D dual                  | 60" | 1 1/4" | 14" | <b>XTES1 6014A ( )</b> |      | 910.    |
|   | 36" D dual                  | 72" | 1 1/4" | 14" | <b>XTES1 7214A ( )</b> |      | 936.    |
| <i>acrylic shown</i>  |                             |     |        |     |                        |      |         |
|  | 24" D dual                  | 48" | 1 1/4" | 21" | <b>XTES1 4821A ( )</b> |      | 829.    |
|   | 30" D dual                  | 60" | 1 1/4" | 21" | <b>XTES1 6021A ( )</b> |      | 1,070.  |
|   | 36" D dual                  | 72" | 1 1/4" | 21" | <b>XTES1 7221A ( )</b> |      | 1,097.  |
| <i>acrylic shown</i>  |                             |     |        |     |                        |      |         |
| Replacement mast Kit  | acrylic center screen       |     |        |     | <b>XTSM1C</b>          | 91.  |         |
|   | slatwall center screen      |     |        |     | <b>XTSM1SLAT</b>       | 241. |         |
| End screen brackets ( pair )  | tapered edge worksurface    |     |        |     | <b>XTSM1KK</b>         | 150. |         |
| Side screen brackets ( pair )   | postformed edge worksurface |     |        |     | <b>XTSM1P</b>          | 225. |         |
|   | squared edge worksurface    |     |        |     | <b>XTSM1S</b>          | 150. |         |

| Order Code                   | Specifications                    | Application Notes   |
|------------------------------|-----------------------------------|---|
| Example: <b>XTES16014A O</b> | Arylic surface is always opal.    | Dual end screens clamp to front edge of worksurface on either side of table. Specify 14" H screens for a 43" horizon. Specify 21" H screens for a 50" horizon. Side screens align with center screens when worksurfaces are set at 28 3/8" H. |
| <b>XT</b> Crinion Open Table | O - Opal                          |   |
| <b>ES1</b> End screen        | Frame is clear anodized aluminum. |   |
| <b>60</b> Width              |                                   |   |
| <b>14</b> Height             |                                   | Specify end screen brackets separately for each screen.   |
| <b>A</b> Acrylic             |                                   |   |
| <b>O</b> Opal                |                                   |   |

• Consult your Knoll Representative for pricing and availability.

# Single sided end screen

## Acrylic surface only

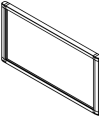
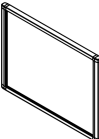
| description   | application                 | w   | d      | h   | pattern no.            | list | acrylic |
|---|-----------------------------|-----|--------|-----|------------------------|------|---------|
|  | 24" D Single                | 24" | 1 1/4" | 14" | <b>XTES1 2414A ( )</b> |      | \$562.  |
|   | 30" D Single                | 30" | 1 1/4" | 14" | <b>XTES1 3014A ( )</b> |      | 589.    |
|   | 36" D Single                | 36" | 1 1/4" | 14" | <b>XTES1 3614A ( )</b> |      | 642.    |
|  | 24" D single sided          | 24" | 1 1/4" | 21" | <b>XTES1 2421A ( )</b> |      | 642.    |
|   | 30" D single sided          | 30" | 1 1/4" | 21" | <b>XTES1 3021A ( )</b> |      | 669.    |
|   | 36" D single sided          | 36" | 1 1/4" | 21" | <b>XTES1 3621A ( )</b> |      | 722.    |
| Single sided end screen brackets ( pair )   | postformed edge worksurface |     |        |     | <b>XTSM1PC</b>         | 161. |         |
|   | square edge worksurface     |     |        |     | <b>XTSM1SC</b>         | 118. |         |
|   | tapered edge worksurface    |     |        |     | <b>XTSM1KC</b>         | 118. |         |

### Order Code

|                              |                    |
|------------------------------|--------------------|
| Example: <b>XTES13614A O</b> |                    |
| <b>XT</b>                    | Crinion Open Table |
| <b>ES1</b>                   | End screen         |
| <b>36</b>                    | Width              |
| <b>14</b>                    | Height             |
| <b>A</b>                     | Acrylic            |
| <b>O</b>                     | Opal               |

### Specifications

Acrylic surface is always opal.  
 O - Opal  
 Frame is clear anodized aluminum.

### Application Notes

Single sided end screens clamp to front edge of worksurface and attach to top of channel. Specify 14" H screens for a 43" horizon. Specify 21" H screens for a 50" horizon. Side screens align with center screens when worksurfaces are set at 28 3/8" H.  
 Specify end screen brackets separately for each screen.

• Consult your Knoll Representative for pricing and availability.

# Frameless glass Add up for Crinion Open Table

Crinion Open Table

| description             | w   | d    | h   | pattern no.           | clear tempered | powder |
|-------------------------|-----|------|-----|-----------------------|----------------|--------|
| Frameless glass Add ups | 48" | 1/2" | 12" | <b>XAUA 1248G ( )</b> | \$468.         | \$487. |
|                         | 60" | 1/2" | 12" | <b>XAUA 1260G ( )</b> | 572.           | 595.   |
|                         | 72" | 1/2" | 12" | <b>XAUA 1272G ( )</b> | 676.           | 703.   |

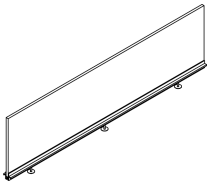

## Order Code

|             |                        |
|-------------|------------------------|
| Example:    | <b>XAUA 1248G TEMP</b> |
| <b>X</b>    | Crinion Open Table     |
| <b>AUA</b>  | Frameless addup screen |
| <b>48</b>   | Width                  |
| <b>12</b>   | Height                 |
| <b>G</b>    | Glass                  |
| <b>TEMP</b> | Finish                 |

## Specifications

*Add up type:*  
G Glass

Glass add-ups are available with the following glass options:  
TEMP Clear tempered  
GLI3 Powder

## Application Notes

Frameless glass addups for Crinion Open Table match those available for the AutoStrada spine.

Tempered glass in clear or powered finish is 1/2" thick. Base frame is secured with bolts to top channel for frameless glass addups.

Frameless addups cannot be mounted to standard top channel included with base assemblies.

Base extrusion is clear anodized aluminum.



| description                     | w   | d  | h   | pattern number         | list price |
|---------------------------------|-----|----|-----|------------------------|------------|
| Acrylic privacy screen to 41" H | 30" | 1" | 12" | <b>XTPS1 3012A ( )</b> | \$776.     |
|                                 | 36" | 1" | 12" | <b>XTPS1 3612A ( )</b> | 814.       |
|                                 | 60" | 1" | 12" | <b>XTPS1 6012A ( )</b> | 1,172.     |
|                                 | 72" | 1" | 12" | <b>XTPS1 7212A ( )</b> | 1,232.     |
| Acrylic privacy screen to 48" H | 30" | 1" | 19" | <b>XTPS1 3019A ( )</b> | 946.       |
|                                 | 36" | 1" | 19" | <b>XTPS1 3619A ( )</b> | 985.       |
|                                 | 60" | 1" | 19" | <b>XTPS1 6019A ( )</b> | 1,397.     |
|                                 | 72" | 1" | 19" | <b>XTPS1 7219A ( )</b> | 1,463.     |

| Order Code                   | Specifications  | Application Notes  |
|------------------------------|---|--|
| Example: <b>XTPS16012AO</b>  |   |  |
| <b>XT</b> Crinion Open Table | Specify acrylic finish code after the pattern number. | Privacy screens mount to continuous channel at center of tables. Specify 12" H screens for a 41" horizon. Specify 19" H screens for a 48" horizon. Horizons are maintained regardless of worksurface height. |
| <b>PS1</b> Privacy screen    | O - Opal  |  |
| <b>60</b> Width              |   |  |
| <b>12</b> Height             |   |  |
| <b>A</b> Acrylic             |   |  |
| <b>O</b> Opal                |   |  |
|                              |   | Original Crinion privacy screens have acrylic flush to both surfaces.  |

# Morrison Network privacy screens mounting kit for Crinion Open Table

Crinion Open Table

| description                | w | d | h | pattern number    | list price |
|----------------------------|---|---|---|-------------------|------------|
| Fabric screen mounting kit |   |   |   | <b>XTPS1MZKIT</b> | \$107.     |

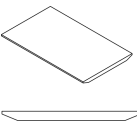
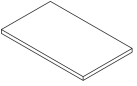
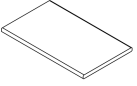

| Order Code                 | Specifications     | Applications notes   |
|----------------------------|--------------------|--|
| Example: <b>XTPS1MZKIT</b> |                    |  |
| <b>XT</b>                  | Crinion Open Table | <p>Crinion Open Tables are designed to accept Morrison Network privacy screens with fabric screen mounting kit. Screens are tackable fabric, <math>\frac{3}{4}</math>" thick, in widths corresponding to Crinion worksurfaces 48", 60" or 72" wide. Specify screens MZ1-B4815F, MZ1B6015F or MZ1B7215F.</p> <p>Specify one mounting kit for each screen. Fabric screen mounting kits include two uprights that fasten to the top channel at any point. Uprights slide into internal channels in screens. Fabric screens do not align in height with acrylic privacy screens.</p> |
| <b>PS1</b>                 | Privacy Screen     |  |
| <b>MZ</b>                  | Fabric             |  |
| <b>KIT</b>                 | Kit                |  |

| description   | w   | d      | h                                | pattern number                   | L      | M      | V1     | V2     | V3     |
|---|-----|--------|----------------------------------|----------------------------------|--------|--------|--------|--------|--------|
| File top, tapered edge<br>       | 30" | 18"    | 1 1/4"                           | <b>XTTK3018F (L/M/1/2/3) ( )</b> | \$291. | \$494. | \$483. | \$515. | \$746. |
|   | 30" | 36"    | 1 1/4"                           | <b>XTTK3036F (L/M/1/2/3) ( )</b> | 399.   | 622.   | 622.   | 698.   | 876.   |
|   | 36" | 18"    | 1 1/4"                           | <b>XTTK3618F (L/M/1/2/3) ( )</b> | 302.   | 504.   | 494.   | 520.   | 795.   |
|   | 36" | 36"    | 1 1/4"                           | <b>XTTK3636F (L/M/1/2/3) ( )</b> | 416.   | 681.   | 681.   | 764.   | 962.   |
|   | 42" | 18"    | 1 1/4"                           | <b>XTTK4218F (L/M/1/2/3) ( )</b> | 312.   | 515.   | 504.   | 530.   | 843.   |
|   | 42" | 36"    | 1 1/4"                           | <b>XTTK4236F (L/M/1/2/3) ( )</b> | 435.   | 708.   | 708.   | 800.   | 1,009. |
|   | 60" | 18"    | 1 1/4"                           | <b>XTTK6018F (L/M/1/2/3) ( )</b> | 494.   | 761.   | 761.   | 840.   | 1,050. |
|   | 60" | 36"    | 1 1/4"                           | <b>XTTK6036F (L/M/1/2/3) ( )</b> | 535.   | 812.   | 812.   | 917.   | 1,159. |
|   | 72" | 18"    | 1 1/4"                           | <b>XTTK7218F (L/M/1/2/3) ( )</b> | 520.   | 788.   | 788.   | 882.   | 1,103. |
|   | 72" | 36"    | 1 1/4"                           | <b>XTTK7236F (L/M/1/2/3) ( )</b> | 571.   | 823.   | 823.   | 927.   | 1,173. |
| 84"   | 18" | 1 1/4" | <b>XTTK8418F (L/M/1/2/3) ( )</b> | 562.                             | 840.   | 840.   | 945.   | 1,155. |        |
| 84"   | 36" | 1 1/4" | <b>XTTK8436F (L/M/1/2/3) ( )</b> | 612.                             | 885.   | 885.   | 1,007. | 1,278. |        |
| File top, veneer square edge<br> | 30" | 18"    | 1 1/4"                           | <b>XTTS3018F (1/2/3) ( )</b>     | n/a    | n/a    | 215.   | 236.   | 392.   |
|   | 36" | 18"    | 1 1/4"                           | <b>XTTS3618F (1/2/3) ( )</b>     | n/a    | n/a    | 221.   | 242.   | 424.   |
|   | 42" | 18"    | 1 1/4"                           | <b>XTTS4218F (1/2/3) ( )</b>     | n/a    | n/a    | 226.   | 247.   | 457.   |
| File top, postformed plastic<br> | 30" | 18"    | 1 1/4"                           | <b>XTPP3018F (L) ( )</b>         | 198.   | n/a    | n/a    | n/a    | n/a    |
|   | 36" | 18"    | 1 1/4"                           | <b>XTPP3618F (L) ( )</b>         | 208.   | n/a    | n/a    | n/a    | n/a    |
|   | 42" | 18"    | 1 1/4"                           | <b>XTPP4218F (L) ( )</b>         | 218.   | n/a    | n/a    | n/a    | n/a    |

| Order Code                     |                    |
|--------------------------------|--------------------|
| Example: <b>XTPP4218FL 118</b> |                    |
| <b>XT</b>                      | Crinion Open Table |
| <b>T</b>                       | Worksurface        |
| <b>P</b>                       | Postformed         |
| <b>42</b>                      | Width              |
| <b>18</b>                      | Depth              |
| <b>F</b>                       | File top           |
| <b>L</b>                       | Finish type        |
| <b>118</b>                     | Surface            |

| Specifications  |
|---|
| File tops are 1 1/4" thick with square edge or tapered edge option tapering to 1/2" thick front edge. Tapered edge file tops are tapered front and back edges only. |
| Specify finishes:<br>L - Laminate<br>M - Laminate/veneer edge<br>1 - Veneer group 1<br>2 - Veneer group 2<br>3 - Veneer group 3                                     |

| Application Notes   |
|---|
| File tops correspond to 30", 36" or 42"W lateral files. File tops on 2 high Calibre files positioned perpendicular to the Crinion Open Table serve as a worksurface return. |

| <i>pattern no.</i> | <i>page</i> | <i>pattern no.</i> | <i>page</i> | <i>pattern no.</i> | <i>page</i> | <i>pattern no.</i> | <i>page</i> |
|--------------------|-------------|--------------------|-------------|--------------------|-------------|--------------------|-------------|
| XAUA 1248G         | 40          | XTB1 BAS 36D20SA   | 18          | XTB1SB15E          | 23          | XTCS1 7121         | 36          |
| XAUA 1260G         | 40          | XTB1 BAS 36D20SF   | 16          | XTB1SB4E           | 23          | XTCS1 7214         | 36          |
| XAUA 1272G         | 40          | XTB1 BAS 36D24CA   | 18          | XTB1SB5C           | 23          | XTCS1 7221         | 36          |
| XTB1 BAS 24D10CF   | 10          | XTB1 BAS 36D24CF   | 16          | XTB1SB5E           | 23          | XTCT6030D          | 35          |
| XTB1 BAS 24D12CF   | 10          | XTB1 BAS 36D25CA   | 18          | XTB1SB6C           | 23          | XTCT6030LD         | 35          |
| XTB1 BAS 24D15CF   | 10          | XTB1 BAS 36D25CF   | 16          | XTB1SB6E           | 23          | XTCT6036D          | 35          |
| XTB1 BAS 24D15SF   | 10          | XTB1 BAS 36S10CA   | 19          | XTB1SB8C           | 23          | XTCT6036LD         | 35          |
| XTB1 BAS 24D18SF   | 10          | XTB1 BAS 36S10CF   | 17          | XTB1SB8E           | 23          | XTCT7230D          | 35          |
| XTB1 BAS 24D20SF   | 10          | XTB1 BAS 36S12CA   | 19          | XTB1T24            | 27          | XTCT7230LD         | 35          |
| XTB1 BAS 24D24SF   | 10          | XTB1 BAS 36S12CF   | 17          | XTB1TB10C          | 21          | XTCT7236D          | 35          |
| XTB1 BAS 24D25SF   | 10          | XTB1 BAS 36S15CA   | 19          | XTB1TB10E          | 21          | XTCT7236LD         | 35          |
| XTB1 BAS 24S10CF   | 11          | XTB1 BAS 36S15CF   | 17          | XTB1TB12C          | 21          | XTDT423            | 35          |
| XTB1 BAS 24S12CF   | 11          | XTB1 BAS 36S15SA   | 19          | XTB1TB12E          | 21          | XTDTX423           | 35          |
| XTB1 BAS 24S15CF   | 11          | XTB1 BAS 36S15SF   | 17          | XTB1TB15C          | 21          | XTES1 2414A        | 39          |
| XTB1 BAS 24S15SF   | 11          | XTB1 BAS 36S18SA   | 19          | XTB1TB15E          | 21          | XTES1 2421A        | 39          |
| XTB1 BAS 24S18SF   | 11          | XTB1 BAS 36S18SF   | 17          | XTB1TB4E           | 21          | XTES1 3014A        | 39          |
| XTB1 BAS 24S20SF   | 11          | XTB1 BAS 36S20SA   | 19          | XTB1TB5C           | 21          | XTES1 3021A        | 39          |
| XTB1 BAS 24S24SF   | 11          | XTB1 BAS 36S20SF   | 17          | XTB1TB5E           | 21          | XTES1 3614A        | 39          |
| XTB1 BAS 24S25SF   | 11          | XTB1 BAS 36S24SA   | 19          | XTB1TB6C           | 21          | XTES1 3621A        | 39          |
| XTB1 BAS 30D10CA   | 14          | XTB1 BAS 36S24SF   | 17          | XTB1TB6E           | 21          | XTES1 4814A        | 38          |
| XTB1 BAS 30D10CF   | 12          | XTB1 BAS 36S25SA   | 19          | XTB1TB8C           | 21          | XTES1 4821A        | 38          |
| XTB1 BAS 30D12CA   | 14          | XTB1 BAS 36S25SF   | 17          | XTB1TB8E           | 21          | XTES1 6014A        | 38          |
| XTB1 BAS 30D12CF   | 12          | XTB1 SLIK30        | 24          | XTB1XD30           | 27          | XTES1 6021A        | 38          |
| XTB1 BAS 30D15CA   | 14          | XTB1 SLIK36        | 24          | XTB1XD30N          | 27          | XTES1 7214A        | 38          |
| XTB1 BAS 30D15CF   | 12          | XTB1AC             | 28          | XTB1XD36           | 27          | XTES1 7221A        | 38          |
| XTB1 BAS 30D15SA   | 14          | XTB1AC24           | 28          | XTB1XD36N          | 27          | XTPS1 3012A        | 41          |
| XTB1 BAS 30D15SF   | 12          | XTB1ACEND          | 29          | XTB1XDD24          | 24          | XTPS1 3019A        | 41          |
| XTB1 BAS 30D18SA   | 14          | XTB1DB10C          | 22          | XTB1XDD30          | 24          | XTPS1 3612A        | 41          |
| XTB1 BAS 30D18SF   | 12          | XTB1DB10E          | 22          | XTB1XDD36          | 24          | XTPS1 3619A        | 41          |
| XTB1 BAS 30D20SA   | 14          | XTB1DB12C          | 22          | XTB1XS30           | 27          | XTPS1 6012A        | 41          |
| XTB1 BAS 30D20SF   | 12          | XTB1DB12E          | 22          | XTB1XS30N          | 27          | XTPS1 6019A        | 41          |
| XTB1 BAS 30D24CA   | 14          | XTB1DB15C          | 22          | XTB1XS36           | 27          | XTPS1 7212A        | 41          |
| XTB1 BAS 30D24CF   | 12          | XTB1DB15E          | 22          | XTB1XS36N          | 27          | XTPS1 7219A        | 41          |
| XTB1 BAS 30D25CA   | 14          | XTB1DB4E           | 22          | XTB1YDD24          | 25          | XTPSIMZKIT         | 42          |
| XTB1 BAS 30D25CF   | 12          | XTB1DB5C           | 22          | XTB1YDD30          | 25          | XTR1BCC50          | 35          |
| XTB1 BAS 30S10CA   | 15          | XTB1DB5E           | 22          | XTB1YDD36          | 25          | XTR1DA             | 31, 33      |
| XTB1 BAS 30S10CF   | 13          | XTB1DB6C           | 22          | XTC1 120A          | 20          | XTR1DB             | 31, 33      |
| XTB1 BAS 30S12CA   | 15          | XTB1DB6E           | 22          | XTC1 144A          | 20          | XTR1DC             | 33          |
| XTB1 BAS 30S12CF   | 13          | XTB1DB8C           | 22          | XTC1 48A           | 20          | XTR1DXO            | 31, 33      |
| XTB1 BAS 30S15CA   | 15          | XTB1DB8E           | 22          | XTC1 60A           | 20          | XTR1DYO            | 31, 33      |
| XTB1 BAS 30S15CF   | 13          | XTB1EDD24          | 24          | XTC1 72A           | 20          | XTR1DZO            | 33          |
| XTB1 BAS 30S15SA   | 15          | XTB1EDD30          | 24          | XTC1 96A           | 20          | XTR1E30D           | 30          |
| XTB1 BAS 30S15SF   | 13          | XTB1EDD36          | 24          | XTC1 END           | 20          | XTR1E30S           | 30          |
| XTB1 BAS 30S18SA   | 15          | XTB1ESD24          | 26          | XTCA1 120A         | 20          | XTR1E424D          | 30          |
| XTB1 BAS 30S18SF   | 13          | XTB1ESD30          | 26          | XTCA1 144A         | 20          | XTR1E424S          | 30          |
| XTB1 BAS 30S20SA   | 15          | XTB1ESD36          | 26          | XTCA1 48A          | 20          | XTR1EE             | 30, 32, 34  |
| XTB1 BAS 30S20SF   | 13          | XTB1FC             | 28          | XTCA1 60A          | 20          | XTR1EJ18           | 31          |
| XTB1 BAS 30S24SA   | 15          | XTB1FC24           | 28          | XTCA1 72A          | 20          | XTR1EJ30           | 31          |
| XTB1 BAS 30S24SF   | 13          | XTB1FCEND          | 29          | XTCA1 96A          | 20          | XTR1EJ42           | 31          |
| XTB1 BAS 30S25SA   | 15          | XTB1LDD            | 24          | XTCF 48            | 20          | XTR1EPH            | 31          |
| XTB1 BAS 30S25SF   | 13          | XTB1LDD24          | 24          | XTCF 60            | 20          | XTR1EPI            | 31          |
| XTB1 BAS 36D10CA   | 18          | XTB1LP             | 29          | XTCF 72            | 20          | XTR1FE             | 30, 32, 34  |
| XTB1 BAS 36D10CF   | 16          | XTB1LSD            | 26          | XTCS1 4714         | 36          | XTR1H30D           | 34          |
| XTB1 BAS 36D12CA   | 18          | XTB1LSD24          | 26          | XTCS1 4721         | 36          | XTR1IOF            | 31, 33, 34  |
| XTB1 BAS 36D12CF   | 16          | XTB1MB             | 28          | XTCS1 4814         | 36          | XTR1PDCX           | 31, 33      |
| XTB1 BAS 36D15CA   | 18          | XTB1RAK            | 35          | XTCS1 4821         | 36          | XTR1T30D           | 32          |
| XTB1 BAS 36D15CF   | 16          | XTB1SB10C          | 23          | XTCS1 5914         | 36          | XTR1T30S           | 32          |
| XTB1 BAS 36D15SA   | 18          | XTB1SB10E          | 23          | XTCS1 5921         | 36          | XTR1T424D          | 32          |
| XTB1 BAS 36D15SF   | 16          | XTB1SB12C          | 23          | XTCS1 6014         | 36          | XTR1T424S          | 32          |
| XTB1 BAS 36D18SA   | 18          | XTB1SB12E          | 23          | XTCS1 6021         | 36          | XTR1TCC25          | 35          |
| XTB1 BAS 36D18SF   | 16          | XTB1SB15C          | 23          | XTCS1 7114         | 36          | XTR1TJ18           | 33          |

| <i>pattern no.</i>    | <i>page</i> | <i>pattern no.</i>    | <i>page</i> | <i>pattern no.</i> | <i>page</i> |
|-----------------------|-------------|-----------------------|-------------|--------------------|-------------|
| XTRITJ30              | 33          | XTTK7236D (L/M/1/2/3) | 9           | XTTS3018F (1/2/3)  | 43          |
| XTRITJ42              | 33          | XTTK7236E (L/M/1/2/3) | 9           | XTTS3618F (1/2/3)  | 43          |
| XTRITPH               | 33          | XTTK7236F (L/M/1/2/3) | 43          | XTTS4218F (1/2/3)  | 43          |
| XTRITPI               | 33          | XTTK8418F (L/M/1/2/3) | 43          | XTTS4824A (1/2/3)  | 5           |
| XTSM1C                | 38          | XTTK8436F (L/M/1/2/3) | 43          | XTTS4824B (1/2/3)  | 6           |
| XTSM1K                | 37          | XTTK9624A (L/M/1/2/3) | 5           | XTTS4824C (1/2/3)  | 7           |
| XTSM1KC               | 39          | XTTK9624B (L/M/1/2/3) | 6           | XTTS4824E (1/2/3)  | 8           |
| XTSM1KK               | 38          | XTTK9624C (L/M/1/2/3) | 7           | XTTS4830A (1/2/3)  | 5           |
| XTSM1P                | 37, 38      | XTTK9630A (L/M/1/2/3) | 5           | XTTS4830B (1/2/3)  | 6           |
| XTSM1PC               | 39          | XTTK9630B (L/M/1/2/3) | 6           | XTTS4830C (1/2/3)  | 7           |
| XTSM1S                | 37, 38      | XTTK9630C (L/M/1/2/3) | 7           | XTTS4830E (1/2/3)  | 8           |
| XTSM1SC               | 39          | XTTK9636A (L/M/1/2/3) | 5           | XTTS4836A (1/2/3)  | 5           |
| XTSM1SLAT             | 38          | XTTK9636B (L/M/1/2/3) | 6           | XTTS4836B (1/2/3)  | 6           |
| XTSS1 2414A           | 37          | XTTK9636C (L/M/1/2/3) | 7           | XTTS4836C (1/2/3)  | 7           |
| XTSS1 2421A           | 37          | XTTP3018F (L)         | 43          | XTTS4836D (1/2/3)  | 9           |
| XTSS1 3014A           | 37          | XTTP3618F (L)         | 43          | XTTS4836E (1/2/3)  | 9           |
| XTSS1 3021A           | 37          | XTTP4218F (L)         | 43          | XTTS6024A (1/2/3)  | 5           |
| XTSS1 3614A           | 37          | XTTP4824A (L)         | 5           | XTTS6024B (1/2/3)  | 6           |
| XTSS1 3621A           | 37          | XTTP4824B (L)         | 6           | XTTS6024C (1/2/3)  | 7           |
| XTTK3018F (L/M/1/2/3) | 43          | XTTP4824C (L)         | 7           | XTTS6024E (1/2/3)  | 8           |
| XTTK3036F (L/M/1/2/3) | 43          | XTTP4824E (L)         | 8           | XTTS6030A (1/2/3)  | 5           |
| XTTK3618F (L/M/1/2/3) | 43          | XTTP4830A (L)         | 5           | XTTS6030B (1/2/3)  | 6           |
| XTTK3636F (L/M/1/2/3) | 43          | XTTP4830B (L)         | 6           | XTTS6030C (1/2/3)  | 7           |
| XTTK4218F (L/M/1/2/3) | 43          | XTTP4830C (L)         | 7           | XTTS6030E (1/2/3)  | 8           |
| XTTK4236F (L/M/1/2/3) | 43          | XTTP4830E (L)         | 8           | XTTS6036A (1/2/3)  | 5           |
| XTTK4824A (L/M/1/2/3) | 5           | XTTP4836A (L)         | 5           | XTTS6036B (1/2/3)  | 6           |
| XTTK4824B (L/M/1/2/3) | 6           | XTTP4836B (L)         | 6           | XTTS6036C (1/2/3)  | 7           |
| XTTK4824C (L/M/1/2/3) | 7           | XTTP4836C (L)         | 7           | XTTS6036D (1/2/3)  | 9           |
| XTTK4824E (L/M/1/2/3) | 8           | XTTP4836D (L)         | 9           | XTTS6036E (1/2/3)  | 9           |
| XTTK4830A (L/M/1/2/3) | 5           | XTTP4836E (L)         | 9           | XTTS7224A (1/2/3)  | 5           |
| XTTK4830B (L/M/1/2/3) | 6           | XTTP6024A (L)         | 5           | XTTS7224B (1/2/3)  | 6           |
| XTTK4830C (L/M/1/2/3) | 7           | XTTP6024B (L)         | 6           | XTTS7224C (1/2/3)  | 7           |
| XTTK4830E (L/M/1/2/3) | 8           | XTTP6024C (L)         | 7           | XTTS7224E (1/2/3)  | 8           |
| XTTK4836A (L/M/1/2/3) | 5           | XTTP6024E (L)         | 8           | XTTS7230A (1/2/3)  | 5           |
| XTTK4836B (L/M/1/2/3) | 6           | XTTP6030A (L)         | 5           | XTTS7230B (1/2/3)  | 6           |
| XTTK4836C (L/M/1/2/3) | 7           | XTTP6030B (L)         | 6           | XTTS7230C (1/2/3)  | 7           |
| XTTK4836D (L/M/1/2/3) | 9           | XTTP6030C (L)         | 7           | XTTS7230E (1/2/3)  | 8           |
| XTTK4836E (L/M/1/2/3) | 9           | XTTP6030E (L)         | 8           | XTTS7236A (1/2/3)  | 5           |
| XTTK6018F (L/M/1/2/3) | 43          | XTTP6036A (L)         | 5           | XTTS7236B (1/2/3)  | 6           |
| XTTK6024A (L/M/1/2/3) | 5           | XTTP6036B (L)         | 6           | XTTS7236C (1/2/3)  | 7           |
| XTTK6024B (L/M/1/2/3) | 6           | XTTP6036C (L)         | 7           | XTTS7236D (1/2/3)  | 9           |
| XTTK6024C (L/M/1/2/3) | 7           | XTTP6036D (L)         | 9           | XTTS7236E (1/2/3)  | 9           |
| XTTK6024E (L/M/1/2/3) | 8           | XTTP6036E (L)         | 9           | XTTS9624A (1/2/3)  | 5           |
| XTTK6030A (L/M/1/2/3) | 5           | XTTP7224A (L)         | 5           | XTTS9624B (1/2/3)  | 6           |
| XTTK6030B (L/M/1/2/3) | 6           | XTTP7224B (L)         | 6           | XTTS9624C (1/2/3)  | 7           |
| XTTK6030C (L/M/1/2/3) | 7           | XTTP7224C (L)         | 7           | XTTS9630A (1/2/3)  | 5           |
| XTTK6030E (L/M/1/2/3) | 8           | XTTP7224E (L)         | 8           | XTTS9630B (1/2/3)  | 6           |
| XTTK6036A (L/M/1/2/3) | 5           | XTTP7230A (L)         | 5           | XTTS9630C (1/2/3)  | 7           |
| XTTK6036B (L/M/1/2/3) | 6           | XTTP7230B (L)         | 6           | XTTS9636A (1/2/3)  | 5           |
| XTTK6036C (L/M/1/2/3) | 7           | XTTP7230C (L)         | 7           | XTTS9636B (1/2/3)  | 6           |
| XTTK6036D (L/M/1/2/3) | 9           | XTTP7230E (L)         | 8           | XTTS9636C (1/2/3)  | 7           |
| XTTK6036E (L/M/1/2/3) | 9           | XTTP7236A (L)         | 5           |                    |             |
| XTTK6036F (L/M/1/2/3) | 43          | XTTP7236B (L)         | 6           |                    |             |
| XTTK7218F (L/M/1/2/3) | 43          | XTTP7236C (L)         | 7           |                    |             |
| XTTK7224A (L/M/1/2/3) | 5           | XTTP7236D (L)         | 9           |                    |             |
| XTTK7224B (L/M/1/2/3) | 6           | XTTP7236E (L)         | 9           |                    |             |
| XTTK7224C (L/M/1/2/3) | 7           | XTTP9624A (L)         | 5           |                    |             |
| XTTK7224E (L/M/1/2/3) | 8           | XTTP9624B (L)         | 6           |                    |             |
| XTTK7230A (L/M/1/2/3) | 5           | XTTP9624C (L)         | 7           |                    |             |
| XTTK7230B (L/M/1/2/3) | 6           | XTTP9630A (L)         | 5           |                    |             |
| XTTK7230C (L/M/1/2/3) | 7           | XTTP9630B (L)         | 6           |                    |             |
| XTTK7230E (L/M/1/2/3) | 8           | XTTP9630C (L)         | 7           |                    |             |
| XTTK7236A (L/M/1/2/3) | 5           | XTTP9636A (L)         | 5           |                    |             |
| XTTK7236B (L/M/1/2/3) | 6           | XTTP9636B (L)         | 6           |                    |             |
| XTTK7236C (L/M/1/2/3) | 7           | XTTP9636C (L)         | 7           |                    |             |

# Selling Policy

|  |   |
|--|---|
|  | <p>This Selling Policy supercedes all previous selling policies. Prices, discounts and product offerings are subject to change without notice.</p>  |
| <b>Terms &amp; Conditions of Sales</b> | <p>Sales by Knoll, Inc. or Knoll North America Corp. ("Seller") of Knoll Product Lines (hereinafter "Products") within the United States and Canada are made only on the terms which are contained in this Selling Policy. Seller hereby gives notice of its objection to any different or additional terms and conditions. This sale is expressly conditional upon Purchaser's assent to the terms and conditions set forth below. Additional terms and conditions may apply to KnollStudio and KnollTextiles orders. These terms and conditions may be modified or supplemented only by a written document signed by an authorized representative of Seller. These terms and conditions supercede any prior and/or contemporaneous agreements or correspondence between Purchaser and Seller. Written quotations expire thirty (30) days from the date of issuance and can be withdrawn by written notice anytime during that period. Where Purchaser and Seller have entered into the Knoll Electronic Terms and Conditions, all orders, acknowledgements, invoices and other business communications placed or transmitted in accordance with the Knoll Electronic Terms and Conditions shall be deemed to be in writing and signed and shall be valid for all purposes as if they were originated and maintained in documentary form.</p>  |
| <b>Ordering Information</b>            | <p>All orders must be in writing. The product pattern number(s) contained on Seller's order acknowledgement shall be the final expression of the order.</p>   |
| <b>Order Confirmation</b>              | <p>A purchase order is not binding on Seller until Purchaser has received Seller's order confirmation or acknowledgment.</p>  |
| <b>Pricing Policies</b>                | <p>List prices are subject to change without notice.</p> <p>List prices shall be those prices in effect on the date of receipt of a complete purchase order unless shipment is requested more than ninety (90) days after order entry in which case prices in effect on the date of shipment apply. List prices include specified freight costs. Unless specified in writing by Seller, no other charges are included in Seller's list prices.</p>  |
| <b>Taxes</b>                           | <p>All sales, use, excise and other taxes applicable to the sale of the Products shall be paid by Purchaser. If Purchaser claims an exemption from any tax, Purchaser shall submit to Seller the appropriate exemption certificates.</p>  |
| <b>Terms of Payment</b>                | <p>Payment for one hundred percent (100%) of the net order amount is due within thirty (30) days of the date of invoice, which is issued upon shipment. In case of any discrepancies, such as shortages, and Seller is notified in writing within ten (10) days of receipt of Product, only that portion may be deducted and the balance paid. For orders greater than \$100,000 net, a one-third (1/3) deposit is due at the time of order placement, with the remainder due within thirty (30) days of the date of invoice.</p> <p>KnollStudio orders less than \$2,000 require payment for one hundred percent (100%) of the net order amount (including any applicable sales tax and charges for inside delivery, special packaging, etc.), due at time of order placement. For KnollStudio orders greater than \$2,000, a one-half (50%) deposit is due at time of order placement with the remainder (including any applicable sales tax and charges for inside delivery, special packaging, etc.) due prior to shipment.</p> <p>If, in the judgment of Seller, Purchaser's financial condition does not justify the terms of the payment, Seller may require full or partial payment in advance.</p> <p>Past due accounts shall be charged one and one-half percent (1.5%) per month, or the highest rate permitted by law, whichever is less, and will be added to the outstanding balance. In the event Purchaser defaults on payment, Purchaser shall be liable for all collection costs, including reasonable attorney's fees and costs.</p> |
| <b>Changes and Cancellation</b>        | <p>Purchase orders may not be changed or cancelled, in whole or in part, without prior written consent of Seller. Changes may effect delivery dates. Expenses incurred because of changes shall be charged to Purchaser. In the event of cancellations, Purchaser will be liable for reasonable cancellation charges established by Seller. Orders for special Product, orders including "COM" (hereinafter defined) material and orders pursuant to expedited delivery programs, may not be canceled.</p>  |
| <b>Freight Prepaid</b>                 | <p>Freight is prepaid and included in the price of all Products, except KnollTextiles, within the 48 contiguous United States and Canada, excluding the Yukon, Northwest Territories, Nunavut and Newfoundland. Packing is tested for rigorous motion and transportation but is not guaranteed to protect furniture from conditions over which the Seller has no control. If special packaging is required for any reason, please consult with your sales representative or dealer. Seller shall select the method of shipment and routing. All shipments shall be tailgate deliveries. Freight for all KnollTextiles orders is prepaid and added to the invoice.</p>   |
| <b>Delivery/Freight Charges</b>        | <p>Shipments outside the contiguous 48 United States and Canada shall be shipped F.O.B. Origin.</p> <p>For shipments outside the contiguous United States and Canada, Purchaser is responsible for the cost of freight from point of embarkation, including any handling and transportation charges incidental to loading at the point of departure and unloading at the final destination.</p> <p>Conditions beyond the control of Seller, including weather, available facilities and traffic conditions, may affect exact time of delivery. Seller shall not be responsible for specific carrier delivery date or time unless it has made a specific delivery commitment, in writing.</p> <p>Nonstandard methods of shipment and/or additional services are available upon request. Purchaser will be billed for the differential cost of any special services in excess of standard surface carrier freight costs. Premium charges, at Purchaser's request, will be added for airfreight, exclusive use of vehicle and extra, export or special packaging. Accessorial charges will be added for inside delivery, extra labor, reconsignment and redelivery.</p> <p>Partial shipments may be made and invoiced by Seller.</p>   |
| <b>Claims</b>                          | <p>All shipments for all Knoll Products within the contiguous United States and Canada are F.O.B. Origin. Risk of loss passes to Purchaser at time of delivery to carrier. Purchaser shall inspect all Products upon receipt and notify Seller within ten (10) working days after receipt of any damage or defects which are, or should be, apparent from an inspection of the Product and its packaging. Failure of Purchaser to make a claim against carrier or notify Seller during the ten (10) working day period shall constitute acceptance of the Products and waiver of any apparent defects, errors or shortages. Seller will agree to repair or replace Product damaged in shipment if Purchaser has notified Seller of freight damage within ten (10) working days after receipt and assigns its rights against the carrier.</p>  |
| <b>Seller's Security Interest</b>      | <p>Until Seller receives the full payment for the Product, Seller shall have a security interest in the Product. Purchaser agrees to perform all acts, including but not limited to the execution and filing of documentation, which may be necessary to perfect and assure the security interest of Seller.</p>  |
| <b>Returns</b>                         | <p>The return of Products without a written authorization by Seller shall not be accepted. To receive authorization for Product return, please call Customer Service. All Products that are returned pursuant to a valid authorization shall be subject to a twenty-five percent (25%) of list restocking charge. Products not currently offered for sale by Seller (including COM) shall not be authorized for return. All returned Products must be unused, in original condition and in the original Seller packing cartons. No refund or credit shall be given for damaged Products.</p>  |
| <b>Held Orders/Storage</b>             | <p>If Purchaser requests that an order be held or delayed, prices and terms and conditions in effect at the time of shipment shall apply. If Purchaser requests a delay after the time when Seller can defer production, Purchaser will be invoiced for the Product, payable in accordance with standard terms, when the order is ready for shipment. Seller may transfer the Product to storage, in which case all expenses incurred in connection with storage, including demurrage, preparation for storage, storage charges and handling shall be payable by Purchaser upon submission of invoices by Seller. Risk of loss to the Product shall pass to the Purchaser upon delivery of the Product into storage.</p>  |

# Selling Policy

|                                 |  |
|---------------------------------|--|
| <b>Customer's Own Material</b>  | <p>A Purchaser who requests a fabric or other surface material not standard to Seller's line of Products ("COM") must submit samples of the requested material to Seller prior to entry of a purchaser order. Seller shall determine if the material is suitable to its manufacturing processes and meets any requirements of Underwriters Laboratories. If the COM is acceptable, Seller will then establish a price for using the COM or the Product in question. For a description of the procedures for submitting samples and testing, contact customer resources or your sales representative. Seller shall have no responsibility for the appearance, condition, performance, durability, colorfastness or any other physical attribute of the COM. Purchaser shall indemnify and hold Seller harmless for any damages, injuries or losses arising out of or related to use of the COM on the Product.</p>  |
| <b>Warranty</b>                 | <p>Seller warrants to the original Purchaser only that the Products Seller manufactures and sells to Purchaser are free of defects in workmanship and materials, during the applicable warranty period set forth below.</p> <p>Should any failure to conform with this limited warranty appear to a Product listed below during the applicable warranty period from the date of shipment, Seller shall, upon prompt written notice, repair or replace, at its option and costs, the affected part or parts.</p> <p><i>Product and Period of Warranty</i></p> <p><i>Lifetime: AutoStrada, Calibre, Crinion Open Table, Currents, Dividends, Equity, Morrison, Reff</i> laminate and other non-wood components (except cascade edge worksurfaces, operational parts, controls, electrical, special or custom products, see below)</p> <p><i>10 Years: AutoStrada, Crinion Open Table and Reff</i> wood components, wood casegoods, <i>Interaction</i> tables (except height adjustment mechanisms for <i>Counterforce</i>, crank-adjustable, and split-top tables and worksurfaces, see below), <i>Reuter</i> overheads, <i>Reuter</i> vertical storage, <i>Bulldog, Chadwick, Essentials Work Chairs, Life, RPM</i> and <i>Sapper</i> seating structural and operational parts, controls, casters, pneumatic cylinders (except seating upholstery, finishes and labor, see below)</p> <p><i>5 Years:</i> Operational parts, controls, electrical (except light ballasts and bulbs, see below), cascade edge worksurfaces, special or custom product, wood veneer products, <i>A3, Currents</i> handcrank, <i>Interaction Counterforce, Interaction</i> crank-adjustable, and split-top mechanisms, <i>KnollStudio, KnollExtra</i> adjustable keyboard supports, VDT carousel, monitor platform, equipment storage drawers and all universal storage drawers, <i>Open Up, Visor</i> and <i>SoHo</i> seating structural and operational parts, controls, pneumatic cylinders (except seating upholstery, finishes and labor, see below)</p> <p><i>3 Years:</i> Upholstery, finishes and labor to repair the following chairs: <i>Bulldog, Chadwick, Life, Open Up, Parachute, RPM, Sapper</i> and <i>SoHo</i>.</p> <p><i>2 Years:</i> All other <i>KnollExtra</i> product</p> <p><i>1 Year:</i> Light ballasts and bulbs and <i>Equity</i> fiberglass panels, seating upholstered armpads and soft armpads, <i>Visor</i> finishes and labor to repair.</p> <p>This warranty does not apply to:</p> <ul style="list-style-type: none"><li>• Damage caused by a carrier other than the Seller.</li><li>• Normal wear and tear or acts or omissions of parties other than Seller (including user modification).</li><li>• COM or other third party materials applied to Products.</li><li>• Products not installed by or under the auspices of a certified dealer of Seller.</li><li>• Dramatic temperature variations or exposure to unusual conditions.</li><li>• Except as specifically noted above, textiles and upholstery supplied by <i>KnollTextiles</i> (consult current <i>KnollTextiles</i> price list for applicable warranty).</li><li>• Labor to repair or replace Essential Work Chairs affected part or parts, unless affected part or parts are returned to Seller with freight charges prepaid.</li></ul> <p>Natural variations occurring in wood, marble, and leather shall not be considered defects, and the Seller does not guarantee the colorfastness or matching of the colors, grains or textures, or surface hardness of such materials. The Seller also does not guarantee the colorfastness of fiberglass panel surfaces.</p> <p>THE EXPRESS WARRANTIES CONTAINED HEREIN ARE IN LIEU OF ALL OTHER WARRANTIES, EXPRESS OR IMPLIED, INCLUDING ANY WARRANTIES OF MERCHANTABILITY AND FITNESS FOR PARTICULAR PURPOSE AND ALL OTHER WARRANTIES ARISING FROM COURSE OF DEALING OR USAGE OF TRADE.</p> <p>The remedies provided above are the Purchaser's sole remedies for any failure of Seller to comply with its obligations regarding the workmanship of its Products. Correction of any nonconformity in the manner and for the period of time provided shall constitute complete fulfillment of all liabilities of Seller, with respect to or arising out of the Product furnished hereunder.</p> |
| <b>Delay/Force Majeure</b>      | <p>Seller shall not be liable for failure to perform or for delay in performance due to fire, flood, strike or other labor difficulty, act of God, act of any governmental authority or of the Purchaser, riot, embargo, fuel or energy shortage, wrecks or delay in transportation, inability to obtain necessary labor, materials or manufacturing facilities from usual sources or failure of suppliers to meet their contractual obligations, or due to any cause beyond its reasonable control. If any such event occurs, Seller may extend delivery dates by a period of time necessary to overcome the effect of such delay, allocate available Product or cancel any purchase order.</p>   |
| <b>Compliance with Law</b>      | <p>PURCHASER IS SOLELY RESPONSIBLE FOR COMPLIANCE WITH ALL APPLICABLE FEDERAL, STATE AND LOCAL LAWS, ORDINANCES, REGULATIONS, RULES AND STANDARDS RELATING TO THE INSTALLATION, MAINTENANCE, USE AND OPERATION OF THE PRODUCTS.</p>  |
| <b>Patents</b>                  | <p>Subject to the following provisions, Seller shall, at its own expense, defend or, at its option, settle any claim, suit or proceeding brought against the Purchaser, and/or its vendees, mediate and immediate, so far as based on an allegation that any Product or any part thereof furnished hereunder constitutes a direct or a contributory infringement of any claim of any patent of the United States or Canada. This obligation shall be effective only if Purchaser shall have made all payments then due hereunder and if Seller is notified promptly in writing and given authority, information and assistance for the defense of said claim, suit or proceeding. Seller shall pay all damages and costs awarded in such suit or proceedings so defended.</p> <p>The foregoing indemnity does not apply to the following:</p> <ul style="list-style-type: none"><li>• Products supplied according to a design other than that of Seller, and which is required by the Purchaser.</li><li>• Combination of the Product with another product not furnished hereunder unless Seller is a contributory infringer.</li><li>• Any settlements of a suit or proceeding made without Seller's written consent.</li></ul>   |
| <b>Limitations of Liability</b> | <p><b>SELLER, ITS CONTRACTORS, AUTHORIZED DEALERS AND SUBCONTRACTORS OR SUPPLIERS OF ANY TIER SHALL NOT BE LIABLE TO PURCHASER FOR ANY SPECIAL, INDIRECT, INCIDENTAL OR CONSEQUENTIAL DAMAGES ARISING FROM A BREACH OF THIS AGREEMENT.</b></p> <p>Purchaser's remedies set forth herein are exclusive and the liability of Seller with respect to the breach of this agreement or any contract entered into between the parties pursuant hereto shall not exceed the price of the Product or part on which such liability is based.</p>  |

# General Ordering Information

---

## **The Products**

This guide encompasses all standard products for this product group.

## **Sizes**

Dimensions listed in this guide are indicated as:

H = height

W = width

D = depth

Dia. = diameter

Rad. = radius

## **Pricing**

All prices shown are list.

## **How to Order**

Select pattern numbers and quantities required for your complete installation. Product questions can be addressed in the specific sections of this guide or by contacting your sales representative or customer resource representative at 1-800-343-5665.

Next, select options (if required), along with colors and finishes appropriate to each product. Reference the Finishes and Fabrics pages for color designations.

On large installations, an item's "designated area" can be specified to assist in product organization and handling.

To expedite complete / correct entry of your order, be certain all pattern numbers, quantities, colors and area identifications are completely specified. Also, include complete purchase order numbers, bill-to and ship-to addresses, a contact name and specific factory shipping dates required.

## **Mail all orders to:**

Knoll, Inc.

1235 Water Street

P.O. Box 157

East Greenville, PA 18041

Attention: Order Entry

Once your order is entered at Knoll, an acknowledgment will be mailed to you. You will be advised of your scheduled shipping date within five days of the original acknowledgment. If it is necessary to revise your order, please contact your customer resource representative.

## Sustainability Statement

---

Sustainable design is a key component of Knoll's environmental focus. Our commitment to social responsibility and a healthy environment has prompted us to further articulate our longstanding environmental programs and, with encouragement and support from our colleagues in the industry, we have re-energized our focus on such "green" initiatives as life cycle analysis and LEED™ certification. Knoll is proud to have contributed to projects that have received LEED certification from the U.S. Green Building Council.

For the latest information on Knoll products that help our customers achieve LEED certification, log on to [knoll.com](http://knoll.com), click on "About Knoll" and then "Environmental Focus."