

# Table of Contents

Introduction	Knoll and Sustainable Design	3
	Knoll and Ergonomic Design	4
	GREENGUARD Indoor Air Quality Certified®	5
	Placing Your Knoll Office Seating Order	6
	Office Seating Visual Index	7
	Office Seating Control Index	10
	KnollTextiles Fabric Application	11
	Customer's Own Material Seating Process Overview	12
Sapper™	Spinneybeck Leather Application	21
	Sapper™ : executive chair	26
	Sapper™ : management chair	28
	Sapper™ : side chair	30
Open Up®	Sapper™ Dimensions and Operating Instructions	32
	Open Up® : high-back chair	34
	Open Up® : mid-back chair	38
	Open Up® : replacement seats	42
	Open Up® : side chair	44
Life®	Open Up® Dimensions and Operating Instructions	46
	Life® : plastic base, knitted seat topper, no back topper	48
	Life® : plastic base, seat topper, no back topper	50
	Life® : plastic base, seat topper and back topper	52
	Life® : aluminum base, knitted seat topper, no back topper	54
	Life® : aluminum base, seat topper, no back topper	56
	Life® : aluminum base, seat topper and back topper	58
	Life® : replacement parts	60
	How to Specify a Life® Chair	62
	Life® Upholstery Options and Construction Information	64
Chadwick™	Life® Dimensions and Operating Instructions	66
	Chadwick™ : tilt stop control	68
	Chadwick™ : basic control	70
	Chadwick™ : high task chair	72
	Chadwick™ Construction Information	76
Bulldog®	Chadwick™ Dimensions and Operating Instructions	78
	Bulldog® : executive chair	80
	Bulldog® : management chair	82
	Bulldog® : operational chair	84
	Bulldog® : high task chair	86
	Bulldog® : side chair	88
	Bulldog® Controls, Options and Construction Information	90
RPM®	Bulldog® Dimensions and Operating Instructions	92
	RPM® : basic control	94
	RPM® : advanced control	96
	RPM® : high task chair	98
	RPM® : side chair	102
	RPM® Dimensions and Operating Instructions	104
Essentials Work Chairs™	RPM® Control Index and Construction Information	106
	EWC Pro™ : upholstered mid-back task chair	108
	EWC Pro™ : upholstered mid-back conference chair	112
	EWC Pro™ : upholstered high-back task chair	116
	EWC Pro™ : upholstered high-back conference chair	120
	EWC Pro™ : upholstered side chair	124
	EWC Pro™ : seat and back replacements for task, conference and side chairs	126
	EWC Pro™ Task Dimensions and Operating Instructions	128
	EWC Pro™ Conference Dimensions and Operating Instructions	130
	EWC Tech™ : suspension back task chair	132
	EWC Tech™ : suspension back conference chair	136
	EWC Tech™ : suspension back side chair	140
	EWC Tech™ : seat and back replacements for task, conference and side chairs	142

Essentials Work Chairs™ (cont'd.)	EWC Tech™ Task Dimensions and Operating Instructions	144
	EWC Tech™ Conference Dimensions and Operating Instructions	146
	EWC Sport™ : upholstered mid-back task chair	148
	EWC Sport™ : upholstered mid-back conference chair	152
	EWC Sport™ : seat and back replacements for task and conference chairs	156
	EWC Sport™ Task Dimensions and Operating Instructions	158
	EWC Sport™ Conference Dimensions and Operating Instructions	160
SoHo™	SoHo™ : task chair	162
	SoHo™ : side chair	164
	SoHo™ dolly	166
	SoHo Dimensions and Operating Instructions	168
Alpha-Numeric Index		170
Selling Policy		171
General Ordering Information		173

# Knoll and Sustainable Design

---

Each year Knoll sets key initiatives in our journey to sustainability. We are members of a global consortium on energy, have adopted a scientific, metrics-based approach to sustainable product design, and maintain a leadership position in establishing universal, verifiable, sustainability standards for our industry.

Knoll promotes independent third-party certification because it provides the most impartial and trustworthy foundation for industry-wide environmental compliance. Certification by established and respected third parties ensures that all manufacturers are held to the same high standards and that customers can trust a company's declaration about the environmental benefits of its products. Knoll third-party partners include: the International Standards Organization (ISO); Forest Stewardship Council (FSC); GREENGUARD® Environmental Institute; and Chicago Climate Exchange (CCX®).

In addition, Knoll is aligned with the U.S. Green Building Council and can help companies, healthcare organizations and educational institutions achieve Leadership in Energy and Environmental Design (LEED®) workplace certification.

## 1. Global Climate Change

- Knoll is a sponsor of the Clinton Global Initiative, which brings together a community of global leaders to devise and implement solutions to some of the world's most pressing challenges, including environmental change.
- Knoll is a member of the Chicago Climate Exchange, which promotes greenhouse gas reduction through the trading of credits earned for reducing emissions.
- Knoll has a comprehensive Energy Management Program to increase energy efficiency in products and processes.

## 2. Life Cycle Assessment (LCA) Tool

Life Cycle Assessment is a science-based measurement of a product's environmental impacts throughout its life cycle, from raw materials sourcing through manufacture, shipping, use, and re-use or end-of-life. LCA enables cradle-to-cradle implementation of sustainable practices.

- Knoll partners with The Green Standard.org (formerly the International Design Center for the Environment, or IDCE) to develop an affordable, universal, ISO-compliant computer-based LCA tool that can be used by the entire contract furniture industry.

An affordable universal LCA tool has enormous potential value to:

- Help stop dangerous and irreversible climate change
- Conserve natural resources and reduce waste
- Improve quality of life
- Eliminate market confusion about green products using real metrics and sound science
- Facilitate design innovation
- Advance the sustainability triple bottom line: environment, economics and social equity

## 3. Setting Industry Standards

- Knoll partners with MTS (The Institute for Market Transformation to Sustainability) to develop the SMaRT® Consensus Sustainable Products Standards, a set of consensus-based sustainable product standards based on the LEED® model, for all building products, fabric, apparel, flooring and carpet. MTS, the developer of SMaRT®, is an accredited American National Standards Institute (ANSI) standard developer.
- Knoll also participates in an ongoing BIFMA (Business and Institutional Furniture Manufacturers Association) initiative to establish sustainability standards for the contract furniture industry.
- Our goal is to encourage all manufacturers in the contract furniture and related industries to adopt standards that will lead to sustainable products and practices.

For more information about Knoll environmental, health and safety programs, visit [knoll.com/environment](http://knoll.com/environment).

The philosophy underlying the science of **ergonomics** seeks to adapt tasks and tools to fit the person. It's a way of looking at the designs of tasks, tools, equipment and workplace layouts and the overall organization of work to fit the job to the person, rather than the person to the job.

**Benefit of implementing ergonomics in the workplace:**

- Making ergonomic improvements is effective in increasing productivity and preventing workplace injuries
- Simple changes can have immediate and far-reaching results

**Ergonomic Design:**

To keep your body working in neutral, you should adjust your workstation to your body, rather than adjust your body to your workstation. These adjustments are made possible through ergonomic design: the practice of designing workplaces, machines and tasks to match the capabilities and limitations of the human body.

**The goal is to create a workplace in which employees can work in neutral, minimizing wear and tear on their bodies.**

Employees come in all shapes and sizes, yet most work using the same office equipment and furniture. The following elements of the work environment should be adjusted to fit each individual employee:

- Chairs
- Keyboards and mice
- Computer monitors
- Work habits
- Visual comfort

Knoll provides a comprehensive line of ergonomically-designed products from task seating to work tools which allows an individual to customize his or her own workstation, providing a more comfortable and safe work environment. For more information, see the Knoll Office Ergonomics Handbook on Knoll.com.

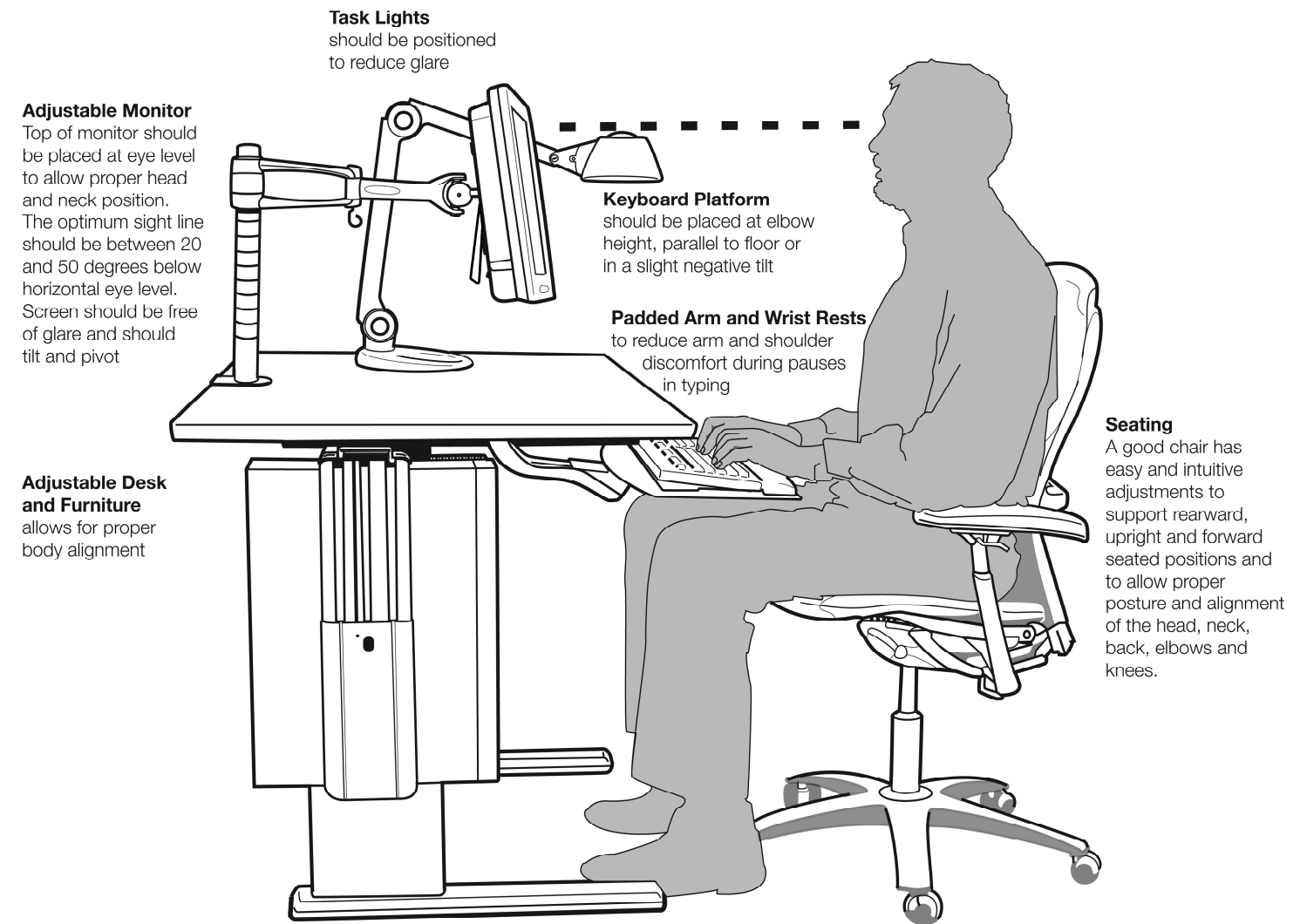

All Knoll Office Seating is GREENGUARD Indoor Air Quality® certified and GREENGUARD for Children & Schools<sup>SM</sup> certified.

Visit GREENGUARD.org for more information and to find printable certificates for Knoll Office Seating that can be used for verification and LEED® submission.

GREENGUARD provides the only guide to certified low-emitting interior products and building materials. Its goal is to help building owners and managers, architects, interior designers and product specifiers build and furnish healthier offices, hospitals, schools and homes by providing a register of tested and certified low-emitting products and materials.

GREENGUARD certification is recognized by the U.S. Green Building Council's LEED® Program. Air Quality Science, an independent indoor air quality laboratory, tests products submitted for certification using stringent environmental chamber testing protocols and current indoor air quality standard. Certification is administered by the GREENGUARD Environmental Institute (GEI), an industry-independent, non-profit organization.

GREENGUARD for Children & Schools<sup>SM</sup> certification complies with the State of California's Department of Health Services Standard Practice (CA Section 01350) for testing chemical emissions from building products used in schools, offices and other sensitive environments. Certified products can contribute to achieving credits in the CHPS Best Practices Manual for K-12 schools, the LEED® Green Building Rating System, Green Guide for Healthcare™, NAHB Green Building Guidelines, Green Globes, Regreen and numerous other local authorities' green building codes.

Knoll Office Seating products can contribute to achieving LEED® credits. GREENGUARD-tested and certified office furniture is required for Credit 4.5 in the LEED-CI Indoor Environmental Quality section.

#### GREENGUARD Certification Program

- Internationally recognized for evaluating product emissions and certifying building materials, furnishings, finishes and cleaning products and processes that meet stringent indoor air quality criteria defined by GEI.
- Products undergo rigorous, third-party testing to determine their impact on indoor air pollution with requirements for ongoing testing and verification.
- Certification confirms a manufacturer's environmental responsibility, and signifies their environmental achievements through independent, third-party testing and verification.
- GREENGUARD Certified products are recommended by leading sustainable building programs, including:
  - U.S Green Building Council's (USGBC) LEED Rating System,
  - National Association of Home Builders (NAHB) Green Building Guidelines,
  - Green Guide for Health Care (GGHC),
  - Collaborative for High Performance Schools (CHPS) Best Practices Manual,
  - New York City Department of Design and Construction Sustainable Design Specifications, among others.

---

## Use the Following Addresses

If you would like to send a standard lead time order to our order entry department, please use the following address:

*For North American orders:*  
Knoll, Inc.  
1235 Water Street  
East Greenville, PA 18041  
Attn: Order Entry

Fax: 215 679-1788  
Tel: 800 343-KNOLL (5665)

All accepted orders will be confirmed in writing on the Knoll standard order confirmation form.

## For More Information

For complete Knoll Selling Policy and warranty information, please refer to page 171 of this price list.















For additional information on Knoll Office Seating, contact your Knoll representative, a Knoll dealer, or telephone Customer Services at 800 343-KNOLL (5665).

## Shipping Method

All RPM chairs, Essentials Work Chairs (EWC Pro, EWC Tech and EWC Sport task and conference versions), and Chadwick task chairs in this price list will ship boxed in two pieces.

If you would like a fully assembled, blanket wrapped RPM chair, Essentials Work Chair (EWC Pro, EWC Tech and EWC Sport task and conference versions), or Chadwick task chair, please consult the Office Seating Standard Specials price list for pattern numbers and associated upcharges.

---

<b>Sapper™</b>	Executive, p. 26	Management, p. 28	Side, p. 30
			
<b>Open Up®</b>	High-back, p. 34	Mid-back, p. 38	Side, p. 44
			
<b>Life®</b>	Plastic base, p. 48	Aluminum base, p. 54	Aluminum base, seat topper and back topper, p. 58
			
<b>Chadwick™</b>	Task, p. 68	High task, p. 72	
			
<b>Bulldog®</b>	Executive, p. 80	Management, p. 82	Operational, p. 84
			

**Bulldog® (continued)**

High task, p. 86



Side, p. 88



**RPM®**

Basic control, p. 94



Advanced control, p. 96



High task, p. 98



Side, p. 102



**Essentials Work Chairs™**

EWC Pro™ mid-back task, p. 108



EWC Pro™ mid-back conference, p.112



EWC Pro™ high-back task, p. 116



EWC Pro™ high-back conference, p. 120



EWC Pro™ side, p. 124



EWC Tech™ task, p. 132



EWC Tech™ conference, p. 136



EWC Tech™ side, p. 140



EWC Sport™ task, p. 148



EWC Sport™ conference, p. 152





---

SoHo™

Task, p. 162



Side, p. 164



Dolly, p. 166

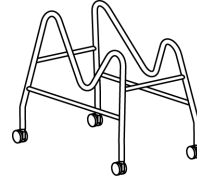

Control	Illustration	Description	Application
Synchronized Recline with Auto-Balanced Tension		<p>360° swivel; utilizes user's body weight for resistance and recline so the chair is perfectly adjusted by sitting in it — no tension knobs or levers needed; allows for constant sightline — no need to refocus; promotes movement and balance; preference control accommodates a wider range of users.</p>	Life task chairs
Synchronized Tilt Control		<p>360° swivel; back and seat recline in one synchronized movement to support the user's back throughout the recline. As back reclines, the seat drops down slightly, relieving pressure points.</p>	<p>Bulldog task chairs (advanced and basic controls)                      Open Up task chairs (advanced and basic controls)                      RPM task chairs (basic and advanced controls)                      Chadwick task chairs (tilt stop and basic controls)                      Essentials Work Chairs task and conference versions</p>
Advanced Knee-Tilt Control		<p>360° swivel; seat and back tilt at the same ratio at a pivot point under the front edge of the seat.</p>	Sapper task chairs
Sliding Seat with Synchronized Back Tilt		<p>360° swivel; back tilts while seat slides forward.</p>	SoHo task chairs
Swivel Tilt Control		<p>360° swivel; seat and back tilt at the same ratio at a pivot point under the middle of the seat.</p>	Essential Work Chairs task and conference versions

**Fabric Application**

The application of KnollTextiles fabrics on Knoll Office Seating provides the broadest and most exciting selection of standard fabrics in the contract furniture industry.

Developed in collaboration with leading designers, KnollTextiles upholstery harmonizes pattern, color and texture in the Modernist tradition. Choose from a wide selection of fabrics that are appropriate for corporate, hospitality, and healthcare use, ranging from natural fibers such as wool and cotton, to high performance options like Crypton® fabrics. Visit KnollTextiles.com to search the online database.

Fabrics are grouped into categories referred to as “grades.” The selection of approved fabrics varies by chair.

**Always check with KnollTextiles for textile changes or new applications on seating.**

Visit KnollTextiles.com and click on “Textile Matrices” to find the link to the most up-to-date Seating Approval Matrix.

**Performance Upholstery Fabrics**

KnollTextiles offers a wide selection of high durability and high performance fabric options. For excellent stain resistance, choose from upholstery products with a Nano-Tex™ finish. For a complete moisture barrier, so that nothing penetrates the fabric into the cushion, you can select from among Crypton® stain, moisture, odor and bacteria resistant fabrics. In addition, there are bleach-cleanable upholstery products, such as vinyl and solution-dyed nylon. Visit KnollTextiles.com and click on “Upholstery” or “Technical Documents” for details.

**Nano-Tex™ and Teflon®:** Both Nano-Tex and Teflon provide additional performance—spill and stain protection—and come stocked on a number of fabrics. These finishes can also be applied to dozens of KnollTextiles fabrics for an upcharge and additional lead time. For a moisture barrier, we also offer Crypton, Gore and Nano-Tex with DuraBlock.

**Crypton®:** KnollTextiles stocks over a dozen patterns with Crypton. It has a moisture barrier plus stain, odor and bacteria resistance, to protect the fabric and the cushion.

**Gore™ Seating Protection or**

**Nano-Tex with DuraBlock:** Gore and Nano-Tex with DuraBlock provide a durable moisture barrier with a soil and stain resistant topical treatment. Even under high pressure, no liquid can travel through the treatment into the cushion. These finish options are not stocked on products, but can be added to many existing KnollTextiles upholstery fabrics for an additional upcharge and lead time.

**Environmental Options**

KnollTextiles offers dozens of upholstery patterns with recycled content or natural fiber. Included in the line is a selection of 100% recycled upholstery fabrics that have no added backing or finish. Visit KnollTextiles.com and click on “Environmental Fabrics” for details.

**California Technical Bulletin 133 (Cal 133)**

Cal 133 is a flammability test procedure for seating furniture for use in public occupancies. Testing must be performed on the designated chair and textile together. Component data alone cannot be used to certify compliance with the regulation. Under Cal 133, one cannot assume that seating or textiles that have passed individually will pass together.

**Cal 133 (cont.)**

Many Knoll Office Seating products can be specified to comply with Cal 133. Applicable upcharge and specification rules are listed on the respective price list page. Chadwick is Cal 133 approved standard. Please refer to the textile matrix for pre-approved Cal 133 upholstery options for the following chairs:

- Sapper
- Open Up (side chair only)
- Life
- Bulldog (not available with upholstered outer back)
- RPM
- Essentials Work Chairs

If any other KnollTextiles fabric or COM is desired, Knoll will test the compliance of the specified fabric on the specified chair. The cost of the test will be the price of the chair in the specified fabric plus \$520. The additional fee is to cover the cost of the test. Please see the respective price list page for yardage requirements. The process time for test results is 4-8 weeks. Contact your Knoll customer service representative at 800 343-KNOLL (5665) for further test processing instructions.

	Soil & Stain Resistance		Moisture Barrier Plus Soil & Stain Resistance		
	Teflon® (Topical)	Nano-Tex™ (Immersion)	Crypton®	Gore™	Nano-Tex with DuraBlock
Soil and Stain Resistant Topical Treatment	Yes	Yes	Yes	Yes	Yes
Water Repellant Finish	No	Yes	Yes	Yes	Yes
Moisture Resistant Backing/Barrier	No	No	Yes	Yes	Yes
Breathable	Yes	Yes	Yes	Yes	Yes
Microbial Resistant	No	Yes	Yes	Yes	Yes
Fabrics Stocked with Finish	Some	Some	Yes	No	No
Minimum Yardage on Non-Stocked Fabrics	5	5	n/a	5	5

Knoll is pleased to cooperate with Customer's Own Material (COM) or Customer's Own Leather (COL) selections after they have been approved by Knoll.

Please refer to the table below for COM process overview. See price list pages for specific chair information. For additional information see Customer's Own Material section in the Selling Policy.

Seating	Pre-Approval				Application Testing		
	Color Specific Testing?	Send to CSR/PM:	Process Time	Application Test Required?	Requires:	Yardage Required for Test	Process Time
Sapper	No	COM Seating Form & Memo Sample	2-3 days	No*	25 chair minimum order OR PO for \$300	2	2-3 weeks
Open Up	No	COM Seating Form & Memo Sample	2-3 days	No*			
Life	No	COM Seating Form & Memo Sample	2-3 days	No*			
Bulldog	No	COM Seating Form & Memo Sample	2-3 days	No*	25 chair minimum order OR PO for \$100	1	2-3 weeks
RPM	No	COM Seating Form & Memo Sample	2-3 days	Yes	25 chair minimum order OR PO for \$300	1.5	2-3 weeks
RPM Side Chair	Yes	COM Seating Form & Memo Sample	2-3 days	Yes	25 chair minimum order OR PO for \$300	5	2-3 weeks
Essentials Work Chairs	No	COM Seating Form & Memo Sample	2-3 days	No*		1	2-3 weeks
SoHo	Yes	COM Seating Form & Memo Sample	2-3 days	Yes	25 chair minimum order OR PO for \$300	3	2-3 weeks

**\*Guideline only – subject to the discretion of the production floor. Sapper requires testing for vinyl. Bulldog requires testing when fabric contains Crypton® or Teflon®.**

#### Cal 133 COM Process Overview

If COM is desired, the fire barrier must be attached when fabric arrives at Knoll. Intek F187 fire barrier is recommended. Knoll will test the compliance of the specified fabric on the specified chair. The cost of the test will include the price of the chair and COM fabric plus \$520. The fee is to cover the cost of the test. Please see respective price list page for yardage requirement. The process time for test results is 4-8 weeks. Contact your Knoll Customer Service Representative at 800-343-KNOLL (5665) for further test processing instructions.

**This page intentionally left blank**

Textile Name	Grade	Direction	Part #	Bulldog Side	Bulldog Task	EWC Pro & EWC Tech Side	EWC Pro & EWC Tech Task	EWC Sport
Abacus	B	NR	K715	■ ♣	■ ♣	■ ♣	■ ♣	■ ♣
Alignment	A	NR	K349	■ ♣	■ ♣	■ ♣	■ ♣	■ ♣
Analogy	A	NR	K614	■ **	■ **	■ **	■ **	■
Arno	H	NR*	K128	■ ♣	■ ♣	■	■	■
Atlas	C	NR*	K1236	■ **	■ **	■ **	■ **	○
Autobahn	C	NR	K491	■	■	■ ♣	■ ♣	○
Backdrop	B	NR*	W302	○	■ **	■ **	■ **	○
Bank Shot	B	NR*	K134	○	○	○	○	○
Belize	B	NR	K1165	■	■	■	■	■
Betwixt	B	NR	K1074	■ ** ♣	■ ** ♣	■ ** ♣	■ **	■
Bifold CR	B	RR	HC193	■ **	■ **	○	○	○
Biota	C		K1297	■ **	■ **	■ ** ♣	■ **	■
Calais Cotton Velvet	F	NR	K787	○	○	○	○	○
Campagna	B	NR*	K387	■ ♣	■ ♣	■ ♣	■	■
Cato	I	RR	KH800	○	○	○	○	○
Cavalier	D	NR	K217	■ ** ♣	■ ** ♣	■ **	■ **	■
Century	F	NR	K1051	■ **	■ **	■ **	■ **	■
Charade	C	NR	K468	■	■	■	■	■
Charade Healthcare	C	NR	HC468	○	○	○	○	○
Charm	C	NR	K1049	■ **	■ **	■ ** ♣	■ **	■
Chroma	B	NR	K345	■ ** ♣	■ ** ♣	■ ** ♣	■ ** ♣	■ ♣
Circa	C	NR	K1054	○	■ **	■ **	■ **	■
Classic Boucle	B	NR*	K162	■ ♣	■ ♣	■	■	■
Close Knit	B	NR	K201	■	■ #	■ ♣	■ ♣	■ ♣
Coco	F	NR	K1024	■	■	■	■	■
Common Ground	A	NR*	K448	■ ** ♣	■ ** ♣	■ ** ♣	■ ** ♣	■ ♣
Compass CR	D	NR	HC1183	■ **	■ **	■ **	■ **	■
Cotton Duck	A	ND	K131	○	○	○	○	○
Cross Stitch	E	NR	K1026	■ ♣	■ ♣	■	■	■
Cuddle Cloth	F	NR*	K231	■	■	■	■	■
Decade	C	NR	K1053	○	■ **	■ **	■ **	■
Digit	B	NR	K891	■	■	■ ♣	■	○
Digital Tape	B	NR	W304	○	■ **	■ **	■ **	○
Dovetail	B	NR	K1150	■ ** ♣	■ ** ♣	■ ** ♣	■ ** ♣	■ ♣
Dristi	A	NR*	K872	■	■	■	■	■
Earthwork	C	NR	K1238	■	■	■ ♣	■	■
Echo	C	NR	K1019	■	■	■	■	■
Eclat Weave	D	NR	K1104	■ **	■ **	■ **	■ **	■
Eclipse	F	NR*	K377	■	■	■	■	■
Empire Stripe	C	NR	K1025	○	■ **	■ **	■ **	○
English Accent	C	NR	K1027	○	■ **	■ **	■ **	■
Enmesh	C	NR	K1092	■ ♣	■ ♣	■ ♣	■ ♣	■ ♣
EWC Sport	A	ND	K1196	○	○	■ **	■ **	■ ♣
Fable CR	C	RR	HC1122	■ **	■ **	■ **	■ **	■
Fast Forward	B	NR*	W301	○	■ **	■ **	■ **	■
Fibra	C	NR	K1105	■ **	■ **	■ ** ♣	■ **	■

■ = Available

○ = Not Available

♣ = Cal 133 Pre-approved

\* = Can be Railroad Cut

\*\* = Not available with upholstered outer back

Textile Name	Life Back Topper	Life Seat Topper	Open Up Task	Open Up Side	RPM Side	RPM Task	Sapper	SoHo
Abacus	■ ^	■ ^	■	■ ^	○	■ ^	■ ^	○
Alignment	■ ^	■ ^	■	■ ^	○	■ ^	■ ^	○
Analogy	■	■	■	■	○	■	○	■
Arno	○	○	■	■	■	■ ^	■	■
Atlas	■	■	■	■	○	■	○	○
Autobahn	○	○	■	■	○	■	■	○
Backdrop	○	○	○	○	○	○	○	○
Bank Shot	○	○	○	○	○	○	■	○
Belize	■	■	■	■	○	■	■	■
Betwixt	○	○	■	■ ^	○	■	■ ^	○
Bifold CR	○	○	■	■	○	■	■	○
Biota	■	■	■	■	○	■	■	■
Calais Cotton Velvet	○	○	○	○	○	○	○	○
Campagna	■	■	■	■	○	■	■	○
Cato	○	○	○	○	■	■	■	○
Cavalier	■ ^	■ ^	■	■	○	■ ^	○	○
Century	■ ^	■ ^	■	■	■	■	○	○
Charade	■	■	■	■	■	■	■	○
Charade Healthcare	○	○	○	○	○	○	■	○
Charm	■ ^	■ ^	■	■	○	■	■	○
Chroma	■ ^	■ ^	■	■	■	■ ^	■ ^	○
Circa	■ ^	■ ^	■	■	○	■	■	○
Classic Boucle	■ ^	■ ^	■	■	■	■ ^	■	■
Close Knit	■	■	■	■ ^	■	■	■	■
Coco	■	■	○	○	■	■	■	○
Common Ground	■ ^	■ ^	■	■	○	■ ^	■ ^	■
Compass CR	■	■	■	■	○	■	■	○
Cotton Duck	○	○	○	○	○	○	○	○
Cross Stitch	■ ^	■ ^	■	■	■	■ ^	■	■
Cuddle Cloth	■	■	■	■	■	■	■	■
Decade	■ ^	■ ^	■	■	○	■	■	○
Digit	○	○	■	■	○	■	■	○
Digital Tape	○	○	○	○	○	○	○	○
Dovetail	■ ^	■ ^	■	■ ^	○	○	■ ^	○
Dristi	○	○	○	○	■	■	○	■
Earthwork	■	■	■	■	■	■	■	■
Echo	■	■	■	■	○	■	■	○
Eclat Weave	■	■	■	■	○	■	■	■
Eclipse	■	■	■	■	○	■	■	○
Empire Stripe	■ ^	■ ^	○	○	○	○	■	○
English Accent	■	■	■	■	○	■	■	○
Enmesh	■ ^	■ ^	■	■ ^	■ ^	■	■	■
EWC Sport	○	○	○	○	○	○	○	○
Fable CR	■	■	■	■	○	■	■	○
Fast Forward	○	○	○	○	○	○	○	○
Fibra	■	■	■	■	○	■	■	○

Textile Name	Grade	Direction	Part #	Bulldog Side	Bulldog Task	EWC Pro & EWC Tech Side	EWC Pro & EWC Tech Task	EWC Sport
Field Day	B	NR*	K124	■ ♣	■ ♣	■ ♣	■ ♣	■ ♣
Foil Rap	A	NR	W535	○	○	○	○	○
Forza	B	NR*	K584	○	○	○	○	○
Fox Trot CR	C	NR	HC777	■	■	■	■	■
Gala	C	NR	K558	■ ** ♣	■ ** ♣	■ ** ♣	■ ** ♣	■ ♣
Gibson	G	NR	K1086	■ **	■ **	■ **	■ **	■
Grande	B	NR*	K180	■ **	■ **	■ **	■ **	■
Groove Line	F	NR	K488	○	■	■	■	■
Gusto CR	B	NR	HC759	■ **	■ **	■ **	■ **	○
Harrison	D	NR	K1084	■ **	■ **	■ **	■ **	■
Haze	G	NR	K109	■	■	■	■	■
Heavy Metal	A	NR	W539	○	○	○	○	○
Highline CR	C	NR	HC1064	■ **	■ **	■ **	■ **	■
Hologram	D	NR	K500	■ ** ♣	■ ** ♣	■ **	■ ** ♣	■ ♣
Hula Hoop	C	NR	K753	■ **	■ **	■ ** ♣	■ **	■
Icon	F	NR	K1028	■	■	■ ♣	■	■
In The Loop	D	NR	K490	■	■	■	■	■
Kaleidoscope CR	C	NR	HC1186	○	○	○	○	○
Kimono	E	NR	K1174	■ **	■ **	■ **	■ **	■
Knoll Felt	B	NR	K1207	■ ♣	■ ♣	■	■	■
Knoll Hopsack	B	NR	K1206	■ ♣	■ ♣	■	■	■
Knoll Velvet	I	RR	K784	○	○	○	○	○
Kora CR	C	NR	HC1010	■ **	■ **	■ **	■ **	■
Legend CR	C	NR	HC1124	○	○	○	○	○
Lore CR	C	NR	HC1123	■ ** ♣	■ ** ♣	■ **	■ ** ^	■
Luberon	E	NR	K676	■	■	■	■	■
Lyonese Velvet	H	NR*	K530	○	■	■	■	○
Lyric	B	NR	K698	■	■	■	■	■
Madison	E	NR	K1085	○	■ **	■ **	■ **	○
Mamba	E	NR	K549	■	■	■	■	■
Mariner	A	NR*	K642	■ **	■ **	■ **	■ **	■
Masquerade	D	NR	K806	■	■	■	■	■
Metaphor	A	NR	K612	○	○	■ **	■ **	■
Metro	C	NR	K1018	■ **	■ **	■ **	■ **	○
Mini Stitch	B	RR	K1130	■ ** ♣	■ ** ♣	■ ** ♣	■ ** ♣	■ ♣
Mixed Media	E	NR	K600	■ **	■ **	■ **	■ **	■
Monarch	A	NR	K1149	■ ♣	■ ♣	■ ♣	■ ♣	■ ♣
Moto CR	C	NR	HC1002	■	■	■ ♣	■ ♣	■ ♣
Night Life	B	NR	K181	■	■	■	■	○
Nonchalant CR	B	NR	HC198	○	■ **	○	○	○
Obi	D	NR	K1175	■	■	■	■	■
Panache CR	C	NR	HC1047	■ **	■ **	■ **	■ **	■
Paradigm	B	NR	K1101	■	■	■ ♣	■	■
Plus	E	NR	K423	■	■	■ ♣	■	■
Pogo	B	NR	K1100	■ ** ♣	■ ** ♣	■ ** ♣	■ ** ♣	■ ♣
Pop	B	NR *	K782	○	■ **	■ **	■ **	■
Posh	C	NR	K1163	○	○	○	○	○

■ = Available      ○ = Not Available      ♣ = Cal 133 Pre-approved      \* = Can be Railroad Cut      \*\* = Not available with upholstered outer back



Textile Name	Life Back Topper	Life Seat Topper	Open Up Task	Open Up Side	RPM Side	RPM Task	Sapper	SoHo
Field Day	■ ^	■ ^	■	■ ^	■	■ ^	■ ^	■
Foil Rap	○	○	○	○	○	○	○	■
Forza	○	○	■	■	○	○	○	○
Fox Trot CR	■	■	■	■	○	■	■	○
Gala	■ ^	■ ^	■	■	○	■ ^	■ ^	○
Gibson	■	■	○	○	○	■	○	○
Grande	■	■	■	■	○	■	■	■
Groove Line	■	■	■	■	○	■	■	○
Gusto CR	■	■	○	○	○	■	○	○
Harrison	■	■	■	■	■	■	■	■
Haze	■	■	■	■	○	■	■	○
Heavy Metal	○	○	○	○	○	○	○	■
Highline CR	■	■	■	■	○	■	■	○
Hologram	■	■	■	■	○	■	■	○
Hula Hoop	■ ^	■ ^	■	■	■	■	■	■
Icon	■ ^	■ ^	■	■	○	■	■	○
In The Loop	■	■	■	■	○	■	■	○
Kaleidoscope CR	○	○	■	■	○	○	○	○
Kimono	■	■	■	■	○	■	■	○
Knoll Felt	■ ^	■ ^	■	■	○	■ ^	■	■
Knoll Hopsack	■ ^	■ ^	■	■	○	■ ^	■	■
Knoll Velvet	○	○	○	○	○	○	○	○
Kora CR	■	■	■	■	○	■	■	○
Legend CR	○	○	■	■	○	○	○	○
Lore CR	■	■	■	■	○	■	■	○
Luberon	■	■	■	■	○	■	■	○
Lyonese Velvet	○	○	○	○	○	■	■	○
Lyric	■	■	■	■	○	■	■	■
Madison	○	○	○	○	○	○	■	○
Mamba	■	■	■	■	○	■	■	○
Mariner	■	■	■	■	■	■	■ ^	■
Masquerade	■	■	■	■	○	■	■	○
Metaphor	■	■	■	■	○	■	■	■
Metro	○	○	■	■	○	■	■	○
Mini Stitch	■ ^	■ ^	■	■ ^	○	■ ^	■ ^	○
Mixed Media	■	■	■	■	○	■	■	■
Monarch	■ ^	■ ^	○	○	■ ^	■ ^	■ ^	■
Moto CR	■	■	■	■	○	■	■	○
Night Life	○	○	■	■	○	■	■	○
Nonchalant CR	○	■	■	■	○	■	■	○
Obi	■	■	■	■	○	■	■	■
Panache CR	■	■	■	■	■	■	■	■
Paradigm	■ ^	■ ^	■	■	■	■	■	○
Plus	■	■	■	■	○	■	■	■
Pogo	■ ^	■ ^	■	■	○	○	■ ^	○
Pop	■	■	■	■	○	■	○	○
Posh	○	○	○	○	○	○	○	○

Textile Name	Grade	Direction	Part #	Bulldog Side	Bulldog Task	EWC Pro & EWC Tech Side	EWC Pro & EWC Tech Task	EWC Sport
Prep	A	NR	K1076	○	■**♣	■**♣	■**	■
Presto	A	NR	K1000	■♣	■♣	■♣	■♣	■♣
Quark	C	NR	K781	■	■	■	■	■
Rattan	G	NR*	K138	■**♣	■**♣	■**	■**	■
Regard CR	C	NR	HC1063	○	■**	○	○	○
Ricochet	B	NR*	K498	■♣	■♣	■♣	■♣	■♣
Rio	C	NR	K1164	■**	■**	■**	■**	■
Rivington	F	NR	K1080	■	■	■	■	■
Rochelle	B	ND	K721	■♣	■♣	■♣	■♣	■♣
Roots & Rhythms	E	NR	K489	■	■	■	■	■
Satellite	D	NR*	K503	■	■	■♣	■	■
Satin Chisel	D	NR	K487	■	■	■	■	■
Sequin CR	C	NR	HC1009	■	■	■	■	■
Spark	B	NR	K1075	■♣	■♣	■♣	■	■
Spencer	G	NR	K1106	○	■**	■**	■**	○
Spinoff Nuance	B	NR*	K319	○	○	○	○	○
Spotlight	B	NR	K772	■	■	■	■	■
Stacks	A	NR	K528	■	■	■	■	■
Star Struck	C	NR	K1048	■**	■**	■**♣	■**	■
Starry Night	B	NR*	K529	■♣	■♣	■♣	■♣	■♣
Stepping Stones	C	RR	K346	○	■**	■**	■**	■
Striae Epingle	G	NR	K390	■**	■**	■**	■**	■
Suburban	F	NR	K407	■	■	■	■	■
Swing	C	NR	K479	■	■	■	■	■
Techno Tweed	B	NR*	K771	■	■	■	■	○
Topography	F	NR	K1052	■	■	■	■	■
Transition	C	NR	K816	■**♣	■**♣	■**♣	■**♣	■♣
Treble CR	C	NR	HC1062	■	■	■	■	■
Triple Lace	B	NR	K1116	○	○	○	○	○
Tsunami	C	NR*	K130	■**♣	■**♣	■**	■**	○
Tweed Frieze	F	NR	K754	○	○	○	○	○
Ultrasuede	G	NR	K1021	○	■**♣	■**♣	■**♣	■♣
Una	F	NR	K451	○	■**	■**	■**	■
Vibe	C	NR*	K1029	○	○	○	○	○
Vinyl	B	ND	K242	■**	■**	■**	■**	○
Wide Angle	B	NR	K244	■♣	■♣	■♣	■♣	■♣
Zari CR	C	NR	HC1008	■**	■**	■**	■**	■
Zephyr	B	NR	K724	■**	■**	■**	■**	■
Zoom	D	NR	K113	■**♣	■**♣	■**	■**♣	○

■=Available

○=Not Available

♣=Cal 133 Pre-approved

\*=Can be Railroad Cut

\*\*=Not available with upholstered outer back

Textile Name	Life Back Topper	Life Seat Topper	Open Up Task	Open Up Side	RPM Side	RPM Task	Sapper	SoHo
Prep	○	○	■	■	○	○	■ ♯	○
Presto	■ ♯	■ ♯	■	■ ♯	○	■ ♯	■ ♯	■
Quark	■	■	■	■	■	■	■	■
Rattan	■	■	■	■	■	■	■	○
Regard CR	■ ♯	■ ♯	■	■	○	○	■	○
Ricochet	■ ♯	■ ♯	■	■ ♯	■	■	○	■
Rio	■	■	■	■	○	■	■	■
Rivington	■	■	■	■	■	■	■	■
Rochelle	■ ♯	■ ♯	■	■	■ ♯	■ ♯	■ ♯	■
Roots & Rhythms	■	■	■	■	■	■	■	■
Satellite	■	■	■	■	○	■	■	○
Satin Chisel	○	○	■	■	■	■	■	○
Sequin CR	■ ♯	■ ♯	■	■	○	■	■	■
Spark	■ ♯	■ ♯	■	■	○	■ ♯	■ ♯	■
Spencer	○	○	○	○	○	○	○	○
Spinoff Nuance	■	■	■	■	■ ♯	■	○	■
Spotlight	■	■	■	■	○	■	■	■
Stacks	■	■	■	■	○	■	■	■
Star Struck	■	■	■	■	○	■	■	○
Starry Night	■ ♯	■ ♯	■	■ ♯	■	■	■ ♯	■
Stepping Stones	■	■	○	○	○	■	■	○
Striae Epingle	■	■	■	■	○	■	■	○
Suburban	■	■	■	■	○	■	■	○
Swing	■	■	■	■	■	■	■	■
Techno Tweed	○	○	■	■	○	■	○	■
Topography	■ ♯	■ ♯	■	■	■	○	■	○
Transition	■ ♯	■ ♯	■	■ ♯	■	■ ♯	○	○
Treble CR	■ ♯	■ ♯	■	■	○	■	■	■
Triple Lace	○	○	○	○	○	○	○	○
Tsunami	○	○	■	■	○	■	■	○
Tweed Frieze	○	○	■	■	○	○	■	○
Ultrasuede	■	■	■	■ ♯	○	○	■ ♯	○
Una	■	■	■	■	○	■	■	○
Vibe	■	■	■	■	○	■	○	○
Vinyl	■	■	■	■	○	■	○	○
Wide Angle	■ ♯	■ ♯	■	■ ♯	○	■	■ ♯	○
Zari CR	■ ♯	■ ♯	■	■	○	■	■	○
Zephyr	■	■	■	■	○	■	■	○
Zoom	○	○	■	■	○	○	■	○

**This page intentionally left blank**

For the ultimate in comfort, durability, and prestige, many Knoll Office Seating products can be upholstered in Spinneybeck leathers.

Spinneybeck leathers are made from the top 2% of the world's finest hides, inspected numerous times during production.

After tanning, all Spinneybeck leathers are drum-dyed, a time-consuming procedure which ensures color penetration throughout the hide. Then each hide is finished in the manner which will best bring out its individual character.

Spinneybeck leathers are all full-grain aniline drum-dyed products imported from Italy.

The following Spinneybeck leathers are approved for application on Knoll Office Seating products. Leathers are grouped into five price categories referred to as "grades." The selection of approved leathers varies by product. Please refer to the pricing page for each product line for more information.

Square footage requirements for Customer's Own Leather (COL) are listed on each chair's pricing page. Please refer to COM Seating Process Overview for further information regarding COL.

For further information, call Spinneybeck at 1 800 482-7777.

### Grades

#### T

Vicenza

### Characteristics

Finished cowhide, corrected grain that is slightly raised; 20 colorways.

#### U

Verona

Volo

Finished cowhide, corrected grain and raised texture; 11 colorways.

Finished cowhide, corrected grain, slightly raised grain texture; 56 colorways.

#### V

Acqua

Andes

España

Hand Tipped

Maremma

Velluto Pelle

Water-repellent finished cowhide, corrected grain, slightly raised grain texture; 66 colorways.

Slightly pronounced grain, finished cowhide and enhanced grain; 59 colorways.

Smooth, tight grain cowhide; breathable, protective finish, enhanced grain; 75 colorways.

Two-toned leather, lightly finished cowhide, pronounced pebble grain texture; 34 colorways.

Full grain textured suede with impregnated soil-resistant treatment; 17 colorways.

Slightly pronounced grain, finished cowhide and enhanced grain; 67 colorways.

#### W

Alaska

Amazon

Antique

Pearlized-iridescent protective finish cowhide, full grain with smooth texture; 22 colorways.

Mid-weight, full grain cowhide; colors of the Amazonian jungle, raised grain texture; 22 colorways.

Smooth tight grain cowhide, lightly antiqued to produce an elegant patina, enhanced grain; 7 colorways.

Arizona

Derby

Forte

Lucente

Sabrina

Full grain, lightly finished kip; ironed for tight, smooth texture, glove-like hand; 42 colorways.

Combination-tanned cowhide; full grain, lightly finished and raised grain texture; 26 colorways.

High performance, full grain leather with slightly pronounced grain texture. 81 colorways.

Smooth, very tight grain cowhide; subtle sheen; light casein finish; 17 colorways.

Smooth, tight and full grain cowhide with a breathable protective finish; 114 colorways.

#### X

Ducale

Ducale Velour

Embossed shrunken grain cowhide with protective finish, full grain; 13 colorways.

Full grain-sueded cowhide, embossed shrunken grain, scotch-guarded; 36 colorways.

#### Y

Capri

Copenhagen

Cordovan

Distressed

Marissa

Portofino

Prima

Riva

Saddle

Salon

Chrome-free, light protective finish, full grain cowhide; 10 colorways.

Full aniline, 100% vegetable tanned leather, full grain; 14 colorways.

Aniline-dyed cowhide, light waxy finish, supple hand, full grain; 18 colorways.

Aniline-dyed, paraffin wax final ironing process with a smooth finish, and full grain; 4 colorways.

Grain-sueded cowhide, smooth suede grain with soil resistant treatment; 19 colorways.

Full grain, lightly finished cowhide with a pronounced raised texture; 21 colorways.

Full aniline, special oils provide a very elegant and supple hand; 8 colorways.

Slightly pronounced grain texture, water-repellent, full grain; 16 colorways.

Full aniline, smooth very tight grain surface takes on a rich patina over time; 23 colorways.

Full aniline cowhide, ironing process provides a lustrous sheen of traditional leathers; 8 colorways.

Leather Name	Grade	Part #	Bulldog Side	Bulldog Task	EWC Pro & EWC Tech Side	EWC Pro & EWC Tech Task	EWC Sport
Acqua	V	AU	■**	■	■♣	■♣	■♣
Alaska	W	AL	■**	■	■♣	■♣	■♣
Amazon	W	AM	■**	■	○	○	○
Andes	V	AD	■**	■	■♣	■♣	■♣
Antique	W	AQ	■**	■	■♣	■♣	■♣
Arizona	W	AR	■**	■	■	■	■♣
Capri	Y	CP	■**	■	○	○	○
Copenhagen	Y	CO	■**	■**	■**	■**	■
Cordovan	Y	CD	■**	■	○	○	○
Derby	W	DE	■**	■	○	○	○
Distressed	Y	DT	■**	■**	■**	■**	■
Ducale	X	DL	■**	■**	○	○	○
Ducale Velours	X	DV	■**	■**	○	○	○
España	V	ES	■**	■	■♣	■♣	■♣
Forte	W	FE	■**	■	■♣	■♣	■♣
Hand Tipped	V	HT	■**	■**	○	○	○
Lucente	W	LU	○	○	○	○	○
Maremma	V	MM	■**	■	○	○	○
Marissa	Y	MA	○	■	■♣	■♣	■♣
Portofino	Y	PT	○	■**	○	○	○
Prima	Y	PR	■**	■	■♣	■♣	○
Riva	Y	RA	■**	■	■	■	■♣
Sabrina	W	SA	■**	■	■♣	■♣	■♣
Saddle	Y	SL	■**	■	○	○	○
Salon	Y	SN	■**	■	○	○	○
Velluto Pelle	V	VP	■**	■	■♣	■♣	■♣
Verona	U	VR	■**	■	■	■	■♣
Vicenza	T	VZ	■**	■**	■	■	■♣
Volo	U	VO	■**	■	■♣	■♣	■♣

Leather Name	Life Back Topper	Life Seat Topper	Open Up Seat Pad	RPM Side	RPM Task	Sapper	SoHo Upholstered
Acqua	■ ♣	■ ♣	■	○	■	■	○
Alaska	■ ♣	■ ♣	■	○	■	■	○
Amazon	■	■	■	○	○	■	○
Andes	■ ♣	■ ♣	■	○	■	■	○
Antique	■ ♣	■ ♣	■	○	■	■	○
Arizona	■ ♣	■ ♣	■	○	■	■	○
Capri	■	■	■	○	■	■	○
Copenhagen	■	■	■	○	■	■	○
Cordovan	■ ♣	■ ♣	■	○	■	■	○
Derby	■	■	■	○	■	■	○
Distressed	■	■	■	○	■	■	○
Ducale	○	○	○	○	○	■	○
Ducale Velours	○	○	○	○	○	■	○
España	■ ♣	■ ♣	■	○	■	■	○
Forte	■ ♣	■ ♣	■	○	■	■	○
Hand Tipped	○	■	○	○	○	■	○
Lucente	○	○	○	○	○	■	○
Maremma	■	■	■	○	○	○	○
Marissa	■ ♣	■ ♣	■	○	○	■	○
Portofino	○	○	○	○	○	■	○
Prima	■ ♣	■ ♣	■	○	○	■	○
Riva	■ ♣	■ ♣	■	○	○	■	○
Sabrina	■ ♣	■ ♣	■	○	■	■	○
Saddle	○	○	○	○	○	■	○
Salon	○	■	○	○	○	■	○
Velluto Pelle	■ ♣	■ ♣	■	○	■	■	○
Verona	■ ♣	■ ♣	■	○	■	■	○
Vizenca	■ ♣	■ ♣	■	■**	■	■	○
Volo	■ ♣	■ ♣	■	■	■	■ ♣	○

Any of our leather grades may be perforated with any of the patterns shown below to create a crisp, contemporary look.

Perforated Leather is a specialty product, available only on a custom order basis. Please use pattern numbers below. Perforated Leather is available in half hides only. Not recommended on outside back applications (e.g. Bulldog)

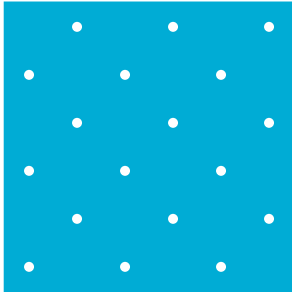

Pattern #265  
.052 in. diameter  
diagonal pattern  
8 holes per square inch

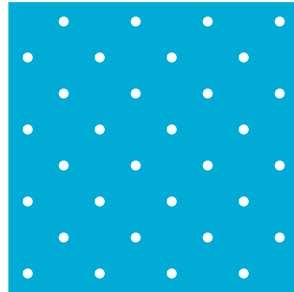

Pattern #330  
.052 in. diameter  
diagonal pattern  
12 holes per square inch

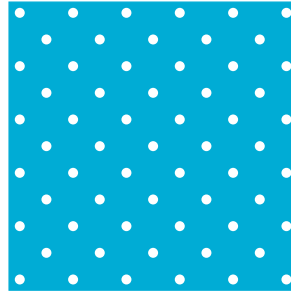

Pattern #457  
.052 in. diameter  
diagonal pattern  
21 holes per square inch

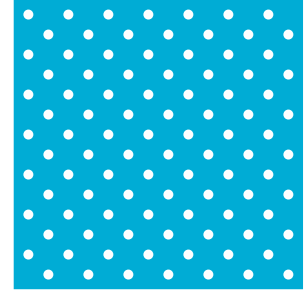

Pattern #914  
Mini Perf  
.052 in. diameter  
straight line pattern  
70 holes per square inch

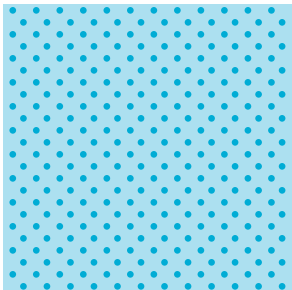

Pattern #528  
Emossed Micro Perf  
.050 in. diameter  
staggered pattern  
75 holes per square inch

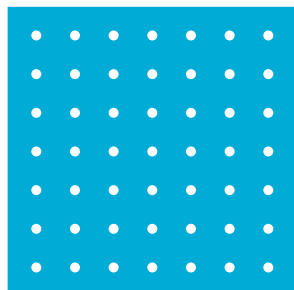

Pattern #1875  
.052 in. diameter  
diagonal pattern  
25 holes per square inch

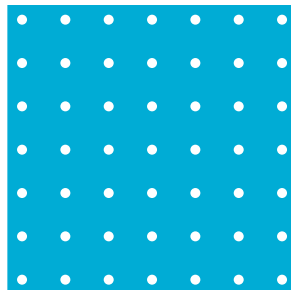

Pattern #0250S  
.052 in. diameter  
straight line pattern  
16 holes per square inch

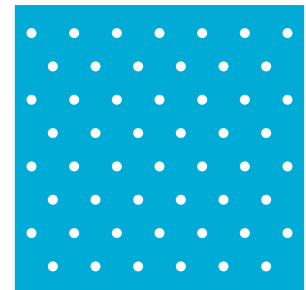

Pattern #560  
.052 in. diameter  
staggered pattern  
22 holes per square inch

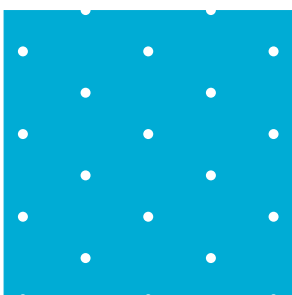

Pattern #280\*  
.052 in. diameter  
staggered pattern  
7 holes per square inch

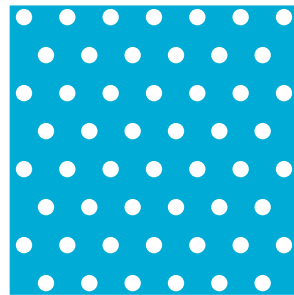

Pattern #560-85  
.085 in. diameter  
staggered pattern  
20 holes per square inch

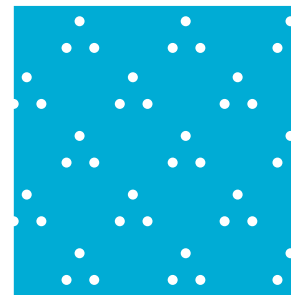

Pattern Tri-Star  
Multiple Diamond  
.052 in. diameter  
staggered pattern  
18 holes per square inch

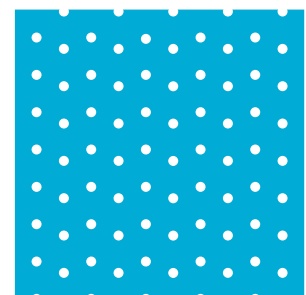



Pattern #1250  
.052 in. diameter  
staggered pattern  
35 holes per square inch

\* Not available on Bulldog Side Chair or RPM



**This page intentionally left blank**

# Sapper™ executive chair

	pattern no.	description
<p><i>Designer(s):</i> Richard Sapper, 1979</p> <p><i>Award(s):</i> IBD Product Design Award, 1985</p>	<p><b>45A3-A5G-H</b></p> 	<p>armchair, cantilevered arms, Advanced knee-tilt control, no lumbar, pneumatic seat height adjustment</p>
	<p><b>45C3-A5G-H</b></p> 	<p>armless version, pneumatic seat height adjustment</p>

Order Code	Ordering Information	Options	Construction
<i>Example:</i> <b>45A3-A5G-H-VO947</b>	<i>Specify:</i>	<i>Code: Upchg: Description:</i>	<i>Finish color:</i>
<b>45A3</b> Sapper executive armchair	1. Pattern number	<b>L</b> \$247 Height-adjustable lumbar (5" range) (substitute L for G)	Black
<b>A5G</b> Advanced knee-tilt control with pneumatic seat height adjustment	2. Upholstery selection with color	<b>C</b> \$145 CAL 133 upholstery (add C to end)	<i>Internal construction:</i> Steel perimeter frame. Elastic webbed straps suspended between seat frame. Steel internal back support structure.
<b>H</b> 2" dual, hooded hard-wheel casters	List prices shown include fabric or leather upholstery. Contact your Knoll representative for colors.	<b>R</b> \$50 Soft caster for hardwood floors (substitute R for H)	<i>Upholstery:</i> High resilient, variable density molded urethane foam. Polyester batting with quilted, horizontally stitched cover. Standard upholstered back.
<b>VO947</b> Volo/Coffee Bean	<i>COM/COL ordering information:</i> For Customer's Own Material/Leather, see approval requirements, important processing instructions and full ordering information in the Fabric Application and Selling Policy sections of the Price List.		<i>Standard cantilevered arms:</i> Integrally colored, textured, self-skinning polyurethane over steel insert.
<i>Example for Cal 133:</i> <b>45A3-A5G-H-C-VO947</b>	When specifying suede and shrunken cowhide, add 10% to the leather square footage requirement. When specifying calf-skin, add 15% to the leather square footage requirement.		

pattern no.	grades A	COM B	C	D	E	F	G	H	I	T	COL U	V	W	X	Y
<b>45A3-A5G-H</b>	\$2,333.	\$2,394.	\$2,455.	\$2,499.	\$2,539.	\$2,572.	\$2,611.	\$2,710.	\$2,887.	\$3,058.	\$3,160.	\$3,326.	\$3,861.	\$3,935.	\$3,961.
<b>45C3-A5G-H</b>	2,231.	2,292.	2,352.	2,395.	2,434.	2,469.	2,510.	2,608.	2,786.	2,955.	3,057.	3,223.	3,755.	3,831.	3,859.

*Optional adjustable lumbar:*  
Lumbar contour mechanically adjusts 4" vertically by activating lever under left side of the seat.

Available on either Advanced or Basic control models.

*Column cover:*  
Integrally colored, textured plastic.

*Base:*  
Die cast aluminum with epoxy finish. Five-star design.

*Casters:*  
Black, integrally colored, textured nylon; 2" dual, hooded hard-wheel or soft-wheel design.

**Controls**

*Advanced knee-tilt control:*  
360° swivel, knee-tilt with tilt tension, forward tilt, upright and forward tilt lock and pneumatic seat height adjustments.

**COM/COL Textile Requirement**



	<i>fabric</i> yds	<i>leather</i> sq. ft.
chair	2.0	35

*Cal 133:*  
‡ = Cal 133 upholstery available. See textile matrix at the beginning of the Price List for pre-approved Cal 133 textiles.

**Knoll Textiles and Spinneyback Leathers**

Please refer to the matrices at the beginning of the price list for Approved Textiles and Leathers.

# Sapper™ management chair

	pattern no.	description
<i>Designer(s):</i> Richard Sapper, 1979  <i>Award(s):</i> IBD Product Design Award, 1985	<b>45A1-A5G-H</b> 	armchair, cantilevered arms, Advanced knee-tilt control, pneumatic seat height adjustment
	<b>45C1-A5G-H</b> 	armless version, pneumatic seat height adjustment

Order Code	Ordering Information	Options	Construction
<i>Example:</i> <b>45A1-A5G-H-VOBLK</b>	<i>Specify:</i>	<i>Code: Upchg: Description:</i>	<i>Finish color:</i>
<b>45A1</b> Sapper management armchair	1. Pattern number	<b>L</b> \$247 Adjustable lumbar (substitute L for G)	Black
<b>A5G</b> Advanced knee-tilt control with pneumatic seat height adjustment	2. Upholstery selection with color	<b>C</b> \$145 CAL 133 upholstery (add C to end)	<i>Internal construction:</i> Steel perimeter frame. Elastic webbed straps suspended between seat frame. Steel internal back support structure.
<b>H</b> 2" dual, hooded hardwheel casters	List prices shown include fabric or leather upholstery. Contact your Knoll representative for colors.	<b>R</b> \$50 Soft caster for hardwood floors (substitute R for H)	<i>Upholstery:</i> High resilient, variable density molded urethane foam. Polyester batting with quilted, horizontally stitched cover. Standard upholstered back.
<b>VOBLK</b> Volof/Black	<i>COM/COL ordering information:</i> For Customer's Own Material/Leather, see approval requirements, important processing instructions and full ordering information in the Fabric Application and Selling Policy sections of the Price List.		<i>Standard cantilevered arms:</i> Integrally colored, textured, self-skinning polyurethane over steel insert.
<i>Example for Cal 133:</i> <b>45A1-A5G-H-C-VOBLK</b>	When specifying suede and shrunken cowhide, add 10% to the leather square footage requirement. When specifying calf-skin, add 15% to the leather square footage requirement.		

pattern no.	grades A	COM B	C	D	E	F	G	H	I	T	COL U	V	W	X	Y
<b>45A1-A5G-H</b>	\$1,984.	\$2,033.	\$2,085.	\$2,121.	\$2,156.	\$2,184.	\$2,217.	\$2,299.	\$2,454.	\$2,602.	\$2,685.	\$2,825.	\$3,286.	\$3,350.	\$3,370.
<b>45C1-A5G-H</b>	1,880.	1,930.	1,984.	2,019.	2,053.	2,081.	2,116.	2,199.	2,351.	2,498.	2,582.	2,722.	3,183.	3,246.	3,266.

Optional adjustable lumbar:  
Lumbar contour mechanically adjusts 4" vertically by activating lever under left side of the seat.

Available on either Advanced or Basic control models.

*Column cover:*  
Integrally colored, textured plastic.

*Base:*  
Die cast aluminum with epoxy finish.  
Five-star design.

*Standard casters:*  
Black, integrally colored, textured nylon;  
2" dual, hooded hard-wheel design.

**Controls**

*Advanced knee-tilt control:*  
360° swivel, knee-tilt with tilt tension, forward tilt, upright and forward tilt lock and pneumatic seat height adjustments.

**COM/COL Textile Requirement**



	<i>fabric yds</i>	<i>leather sq. ft.</i>
chair	1.7	30

*Cal 133:*  
‡ = Cal 133 upholstery available. See textile matrix at the beginning of the Price List for pre-approved Cal 133 textiles.

**KnollTextiles and Spinneybeck Leathers**

Please refer to the matrices at the beginning of the price list for Approved Textiles and Leathers.

# Sapper™ side chair

	pattern no.	description
<i>Designer(s):</i> Richard Sapper, 1979	<b>45A1-SL</b>	armchair, cantilevered arms
	<b>45C1-SL</b>	armless chair
		

## Order Code

*Example:* **45A1-SL-K1021/5**

**45A1** Sapper side armchair

**SL** sled base

**K1021/5** Ultrasuede, Aztec

*Example for Cal 133:*

**45A1-SL-C-K1021/5**

## Ordering Information

### *Specify:*

1. Pattern number
2. Upholstery selection with color

List prices shown include fabric or leather upholstery. Contact your Knoll representative for colors.

### *COM/COL ordering information:*

For Customer's Own Material/Leather, see approval requirements, important processing instructions and full ordering information in the Fabric Application and Selling Policy sections of the Price List.

When specifying suede and shrunken cowhide, add 10% to the leather square footage requirement. When specifying calf-skin, add 15% to the leather square footage requirement.

## Options

<i>Code:</i>	<i>Upchg:</i>	<i>Description:</i>
<b>C</b>	\$145	Cal 133 upholstery (add C to end)

pattern no.	grades A	COM B	C	D	E	F	G	H	I	T	COL U	V	W	X	Y
<b>45A1-SL</b>	\$1,573.	\$1,625.	\$1,674.	\$1,713.	\$1,747.	\$1,777.	\$1,808.	\$1,892.	\$2,043.	\$2,179.	\$2,263.	\$2,406.	\$2,892.	\$2,965.	\$2,986.
<b>45C1-SL</b>	1,472.	1,520.	1,572.	1,610.	1,645.	1,674.	1,706.	1,790.	1,941.	2,076.	2,157.	2,302.	2,790.	2,861.	2,882.

**Construction**

*Finish color:*  
Black.

*Internal construction:*  
Steel perimeter frame. Elastic webbed straps suspended between seat frame. Steel internal back support structure.

*Upholstery:*  
High resilient, variable density molded urethane foam. Polyester batting with quilted, horizontally stitched cover. Standard upholstered back.

*Standard cantilevered arms:*  
Integrally colored, textured, self-skinning polyurethane over steel insert.

*Frame:*  
12-gauge, 7/8" diameter round steel tube with epoxy finish.

*Glides:*  
Opaque nylon.

**COM/COL Textile Requirement**

	<i>fabric yds</i>	<i>leather sq.ft.</i>
chair	1.7	30

*Cal 133:*  
‡ = Cal 133 upholstery available. See textile matrix at the beginning of the Price List for pre-approved Cal 133 textiles.

**Knoll Textiles and Spinneyback Leathers**

Please refer to the matrices at the beginning of the price list for Approved Textiles and Leathers.

# Sapper™ Dimensions and Operating Instructions

## Seat

	Seat Height	Seat Depth	Seat Width	Seat Pan Angle	Seat Back/ Seat Pan Angle
Executive (Pneum.)	17" - 20 1/2"	18"	22 1/2"	6.5°	95°
Manager (Pneum.)	17" - 20 1/2"	18"	20 1/2"	6.5°	95°
Side Chair	17 3/4"	18"	20 1/2"	3°	95°

## Back

	Lumbar Support Height	Lumbar Support Width	Lumbar Support Center	Seat Back Width
Executive (Pneum.)	8	16 1/2"	7 1/2"	22 1/2"
Manager (Pneum.)	8	16 1/2"	7 1/2"	22 1/2"
Side Chair	8	16 1/2"	7 1/2"	22 1/2"

## Armrests

Width Between Armrests
22 1/2"
20 1/2"
20 1/2"

\*Note: Measurements taken with the BIFMA Chair Measuring Device.

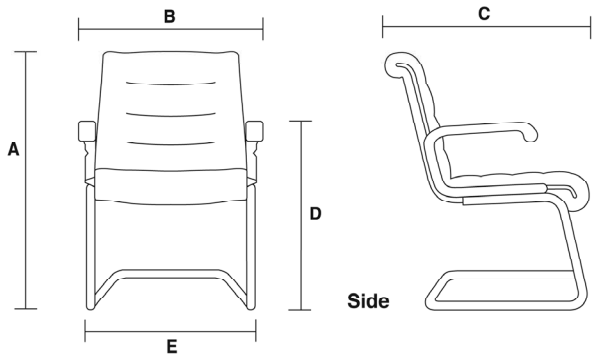
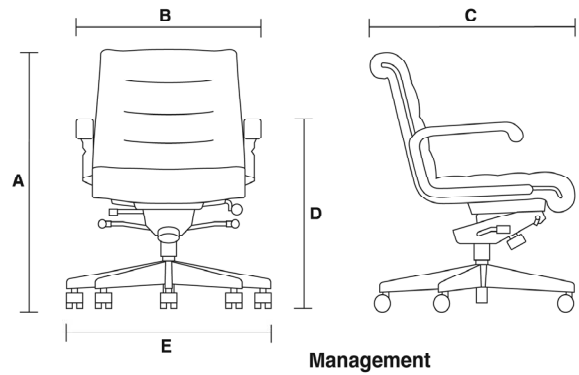
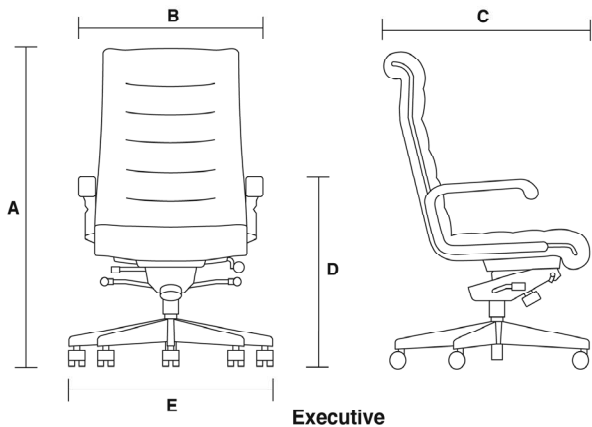

	Executive (pneumatic)	Management (pneumatic)	Side
A overall height	40 3/4" - 43 7/8"	33 3/4" - 37 1/4"	34 3/4"
B overall width	26 3/4"	24 3/4"	24 3/4"
C overall depth	28 3/4"	28"	27 1/2"
D arm height	23 1/2" - 27"	23 1/2" - 27"	26 3/4"
E base dimensions	28" diameter	28" diameter	26" width
weight with arms	55 1/2 lbs.	51 lbs.	36 lbs.

Compliance: ANSI/BIFMA x5.1 – 1993, Cal 117, Cal 133 (with approved FR upholstery)





**Pneumatic Seat Height Adjustment**  
To adjust the height, lift the handle on the right side of the seat.

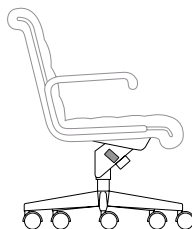

**Tilt Lock**  
To lock the chair upright, push down on the handle under the left side of the chair. Pull up to release.

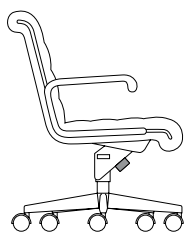

**Tension Adjustment**  
Lean back and recline. If tension needs adjusting, reach under the front-center of the seat and increase tension by turning the knob to the left, or decrease tension by turning the knob to the right.

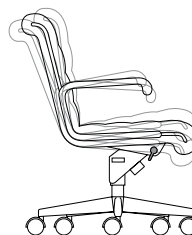



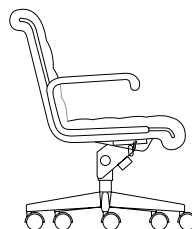

**Forward Tilt**  
Reach under the right side of the chair toward the front and twist the lever to the front while slightly reclining to activate forward tilt. To deactivate forward tilt, recline slightly and twist the lever to the rear.



**Adjustable Lumbar Support**  
*(optional)*  
To raise the lumbar support, slide the curved lever on the left side of the chair toward the rear of the chair. To lower the lumbar, slide the lever toward the front edge of the chair.

# Open Up<sup>®</sup> high-back chair

	pattern no.	description	
<p><i>Designer(s):</i> Mathias Seiler for Sedus, 2001</p> <p><i>Award(s):</i> International Baden - Württemberg 2002 Design Prize, Silver, Germany German Design Prize, 2002, Germany NeoCon Silver, Best of NeoCon, Task Chair Seating Design, June 2001, USA</p> 	<b>S901P-(2,4,C)- F5G-D-(S,H)- (1,2,3,4)</b>	3D plastic arms, advanced control, standard seat	
		<b>S901A-(2,4,C)- F5G-D-(S,H)- (1,2,3,4)</b>	fixed arms, advanced control, standard seat
		<b>S901C-(2,4,C)- F5G-D-(S,H)- (1,2,3,4)</b>	armless, advanced control, standard seat
		<b>S901P-(2,4,C)- B5G-D-(S,H)- (1,2,3,4)</b>	3D plastic arms, basic control, standard seat
		<b>S901A-(2,4,C)- B5G-D-(S,H)- (1,2,3,4)</b>	fixed arms, basic control, standard seat

## Order Code

<i>Example:</i>	<b>S901P-4-F5G-D-H-2- K451/4</b>
<b>S901P</b>	Open Up high-back with 3D plastic arms
<b>4</b>	silver painted base
<b>F5G</b>	advanced control
<b>D</b>	standard seat
<b>H</b>	black hard caster
<b>2</b>	black mesh back
<b>K451/4</b>	Una/Ebony seat pad

## Ordering Information

*Specify:*

- Chair family and arm type
- Specify Finish color  
Black painted aluminum (2)  
Silver painted aluminum (4)  
Polished aluminum (C)
- Specify mesh color  
Navy (1)  
Black (2)  
Wine (3)  
Light Grey (4)
- Upholstery selection with color

Note: Headrest is always covered in black leather

List prices shown include fabric or leather upholstery. Contact your Knoll representative for colors.

*COM/COL ordering information:*  
For Customer's Own Material/Leather, see approval requirements, important processing instructions and full ordering information in the Fabric Application and Selling Policy sections of the Price List.

When specifying suede and shrunken cowhide, add 10% to the leather square footage requirement. When specifying calf-skin, add 15% to the leather square footage requirement.

### Options

Code:	Upchg:	Description:
<b>C</b>	\$350	Polished aluminum finish
<b>G</b>	\$114	Gel armpads (insert a G into the pattern code after the P or A indicating type of arm. Available on both fixed and 3D arms.)

Code:	Upchg:	Description:
<b>J</b>	\$84	Black leather arm pad (substitute J for P) not available on fixed arms
<b>R</b>	n/c	Shorter seat - 16.9" depth (substitute R for D)
<b>L</b>	\$29	Adjustable lumbar (substitute L for G)
<b>H</b>	n/c	Black hard caster
<b>S</b>	n/c	Soft grey caster
<b>Perf- (528)</b>	\$120	For perforated leather insert code Perf-(528) after the leather selection (or see Perforated Leather information sheet in the Spinneybeck Leather Application section at the beginning of this Price List for more codes)

pattern no.	grades A	COM B	C	D	E	F	G	H	I	T	COL U	V	W	X	Y
<b>S901P-(2,4,C)- F5G-D-(S,H)- (1,2,3,4)</b>	\$2,674.	\$2,681.	\$2,740.	\$2,766.	\$2,791.	\$2,809.	\$2,891.	\$2,933.	\$2,957.	\$3,197.	\$3,232.	\$3,317.	\$3,512.	\$3,530.	\$3,614.
<b>S901A-(2,4,C)- F5G-D-(S,H)- (1,2,3,4)</b>	2,557.	2,565.	2,624.	2,651.	2,674.	2,692.	2,774.	2,815.	2,842.	3,077.	3,113.	3,199.	3,395.	3,410.	3,497.
<b>S901C-(2,4,C)- F5G-D-(S,H)- (1,2,3,4)</b>	2,423.	2,432.	2,490.	2,517.	2,541.	2,557.	2,640.	2,681.	2,708.	2,941.	2,977.	3,063.	3,257.	3,275.	3,361.
<b>S901P-(2,4,C)- B5G-D-(S,H)- (1,2,3,4)</b>	2,651.	2,658.	2,714.	2,740.	2,766.	2,782.	2,867.	2,908.	2,933.	3,169.	3,206.	3,291.	3,486.	3,503.	3,588.
<b>S901A-(2,4,C)- B5G-D-(S,H)- (1,2,3,4)</b>	2,531.	2,541.	2,600.	2,624.	2,651.	2,665.	2,748.	2,791.	2,815.	3,051.	3,087.	3,172.	3,368.	3,385.	3,469.

**Construction***Inner seat structure:*

Polypropylene.

*J-Bar structure:*

Die-cast aluminum with vulcanized rubber disk.

*Back suspension fabric:*

100% polyester.

*Control:*

Die-cast aluminum with plastic handles.

*Cushions:*

Insert molded high resilient urethane foam.

*Fixed height arms/3-D arms:*

Integrally colored, textured glass-reinforced nylon.

*Armpads:*

ABS plastic with optional padded black leather covering.

*Base:*

Die-cast aluminum with powder coating or polished aluminum.

*Casters:*

Integrally colored, textured nylon.

*Headrest:*

Glass-filled nylon molded frame with integrally molded urethane foam and black leather upholstery.

**Controls***Advanced control:*Pneumatic seat height, synchronized tilt with side crank tension adjustment, forward tilt, multiple position tilt lock, 360° swivel, adjustable headrest.*Basic control:*Pneumatic seat height, synchronized tilt with side crank tension adjustment, no forward tilt, multiple position tilt lock, 360° swivel, adjustable headrest.**COM/COL Textile Requirement**

	<i>fabric yds</i>	<i>leather sq. ft.</i>
chair	0.8	12

**Knoll Textiles and Spinneybeck Leathers**

Please refer to the matrices at the beginning of the price list for Approved Textiles and Leathers.

# Open Up<sup>®</sup> high-back chair

pattern no. description

*Designer(s):*  
Mathias Seiler for Sedus, 2001

**S901C-(2,4,C)-  
B5G-D-(S,H)-  
(1,2,3,4)**

armless, basic control, standard seat

*Award(s):*  
International Baden -  
Württemberg 2002  
Design Prize, Silver, Germany  
German Design Prize, 2002,  
Germany  
NeoCon Silver, Best of NeoCon,  
Task Chair Seating Design,  
June 2001, USA



## Order Code

<i>Example:</i>	<b>S901P-4-F5G-D-H-2-K451/4</b>
<b>S901P</b>	Open Up high-back with 3D plastic arms
<b>4</b>	silver painted base
<b>F5G</b>	advanced control
<b>D</b>	standard seat
<b>H</b>	black hard caster
<b>2</b>	black mesh back
<b>K451/4</b>	Una/Ebony seat pad

## Ordering Information

### *Specify:*

- Chair family and arm type
- Specify Finish color  
Black painted aluminum (2)  
Silver painted aluminum (4)  
Polished aluminum (C)
- Specify mesh color  
Navy (1)  
Black (2)  
Wine (3)  
Light Grey (4)
- Upholstery selection with color

Note: Headrest is always covered in black leather

List prices shown include fabric or leather upholstery. Contact your Knoll representative for colors.

### *COM/COL ordering information:*

For Customer's Own Material/Leather, see approval requirements, important processing instructions and full ordering information in the Fabric Application and Selling Policy sections of the Price List.

When specifying suede and shrunken cowhide, add 10% to the leather square footage requirement. When specifying calf-skin, add 15% to the leather square footage requirement.

### Options

<i>Code:</i>	<i>Upchg:</i>	<i>Description:</i>
<b>C</b>	\$350	Polished aluminum finish
<b>G</b>	\$114	Gel arm pads (insert a G into the pattern code after the P or A indicating type of arm. Available on both fixed and 3D arms.)

<i>Code:</i>	<i>Upchg:</i>	<i>Description:</i>
<b>J</b>	\$84	Black leather arm pad (substitute J for P) not available on fixed arms
<b>R</b>	n/c	Shorter seat - 16.9" depth (substitute R for D)
<b>L</b>	\$29	Adjustable lumbar (substitute L for G)
<b>H</b>	n/c	Black hard caster
<b>S</b>	n/c	Soft grey caster
<b>Perf- (528)</b>	\$120	For perforated leather insert code Perf-(528) after the leather selection (or see Perforated Leather information sheet in the Spinneybeck Leather Application section at the beginning of this Price List for more codes)

pattern no.	grades A	COM B	C	D	E	F	G	H	I	T	COL U	V	W	X	Y
<b>S901C-(2,4,C)- B5G-D-(S,H)- (1,2,3,4)</b>	\$2,399.	\$2,407.	\$2,465.	\$2,490.	\$2,517.	\$2,531.	\$2,617.	\$2,658.	\$2,681.	\$2,915.	\$2,951.	\$3,035.	\$3,232.	\$3,247.	\$3,333.

**Construction***Inner seat structure:*

Polypropylene.

*J-Bar structure:*

Die-cast aluminum with vulcanized rubber disk.

*Back suspension fabric:*

100% polyester.

*Control:*

Die-cast aluminum with plastic handles.

*Cushions:*

Insert molded high resilient urethane foam.

*Fixed height arms/3-D arms:*

Integrally colored, textured glass-reinforced nylon.

*Armpads:*

ABS plastic with optional padded black leather covering.

*Base:*

Die-cast aluminum with powder coating or polished aluminum.

*Casters:*

Integrally colored, textured nylon.

*Headrest:*

Glass-filled nylon molded frame with integrally molded urethane foam and black leather upholstery.

**Controls***Advanced control:*Pneumatic seat height, synchronized tilt with side crank tension adjustment, forward tilt, multiple position tilt lock, 360° swivel, adjustable headrest.*Basic control:*Pneumatic seat height, synchronized tilt with side crank tension adjustment, no forward tilt, multiple position tilt lock, 360° swivel, adjustable headrest.**COM/COL Textile Requirement**

	<i>fabric yds</i>	<i>leather sq. ft.</i>
chair	0.8	12





**Knoll Textiles and Spinneybeck  
Leathers**

Please refer to the matrices at the beginning of the price list for Approved Textiles and Leathers.

# Open Up<sup>®</sup> mid-back chair

Designer(s):  
Mathias Seiler for Sedus



pattern no.	description
<b>S903P-(2,4,C)- F5G-D-(S,H)- (1,2,3,4)</b>	3D plastic arms, advanced control, standard seat
	
<b>S903A-(2,4,C)- F5G-D-(S,H)- (1,2,3,4)</b>	fixed arms, advanced control, standard seat
	
<b>S903C-(2,4,C)- F5G-D-(S,H)- (1,2,3,4)</b>	armless, advanced control, standard seat
	
<b>S903P-(2,4,C)- B5G-D-(S,H)- (1,2,3,4)</b>	3D plastic arms, basic control, standard seat
	
<b>S903A-(2,4,C)- B5G-D-(S,H)- (1,2,3,4)</b>	fixed arms, basic control, standard seat
	

## Order Code

<i>Example:</i>	<b>S903P-4-F5G-D-H-2-K451/4</b>
<b>S903P</b>	Open Up mid-back with 3D plastic arms
<b>4</b>	silver painted base
<b>F5G</b>	advanced control
<b>D</b>	standard seat
<b>H</b>	black hard caster
<b>2</b>	black mesh back
<b>K451/4</b>	Una/Ebony seat pad

## Ordering Information

Gel armpads (insert a G into the pattern code after the P or A indicating type of arm. Available on both fixed and 3D arms.)

### Specify:

- Chair family and arm type
- Finish color  
Black painted aluminum (2)  
Silver painted aluminum (4)  
Polished aluminum (C)
- Specify mesh color  
Navy (1)  
Black (2)  
Wine (3)  
Light Grey (4)
- Upholstery selection with color

List prices shown include fabric or leather upholstery. Contact your Knoll representative for colors.

### COM/COL ordering information:

For Customer's Own Material/Leather, see approval requirements, important processing instructions and full ordering information in the Fabric Application and Selling Policy sections of the Price List.

When specifying suede and shrunken cowhide, add 10% to the leather square footage requirement. When specifying calf-skin, add 15% to the leather square footage requirement.

### Options

Code:	Upchg:	Description:
<b>C</b>	\$350	Polished aluminum finish
<b>G</b>	\$114	Gel armpads (insert a G into the pattern code after the P or A indicating type of arm. Available on both fixed and 3D arms.)

Code:	Upchg:	Description:
<b>J</b>	\$84	Black leather arm pad (substitute J for P) not available on fixed arms
<b>R</b>	n/c	Shorter seat - 16.9" depth (substitute R for D)
<b>L</b>	\$29	Adjustable lumbar (substitute L for G)
<b>H</b>	n/c	Black hard caster
<b>S</b>	n/c	Soft grey caster
<b>Perf- (528)</b>	\$120	For perforated leather insert code Perf-(528) after the leather selection (or see the Perforated Leather sheet in the Spinneybeck Leather Application section at the beginning of this price list for more codes)

pattern no.	grades A	COM B	C	D	E	F	G	H	I	T	COL U	V	W	X	Y
<b>S903P-(2,4,C)- F5G-D-(S,H)- (1,2,3,4)</b>	\$1,973.	\$1,981.	\$2,040.	\$2,065.	\$2,089.	\$2,106.	\$2,190.	\$2,232.	\$2,256.	\$2,484.	\$2,521.	\$2,604.	\$2,800.	\$2,815.	\$2,902.
<b>S903A-(2,4,C)- F5G-D-(S,H)- (1,2,3,4)</b>	1,856.	1,864.	1,921.	1,945.	1,973.	1,988.	2,074.	2,114.	2,140.	2,363.	2,401.	2,485.	2,680.	2,699.	2,781.
<b>S903C-(2,4,C)- F5G-D-(S,H)- (1,2,3,4)</b>	1,722.	1,731.	1,789.	1,812.	1,837.	1,856.	1,940.	1,981.	2,007.	2,229.	2,265.	2,348.	2,544.	2,563.	2,645.
<b>S903P-(2,4,C)- B5G-D-(S,H)- (1,2,3,4)</b>	1,945.	1,954.	2,014.	2,040.	2,065.	2,081.	2,163.	2,207.	2,232.	2,457.	2,493.	2,579.	2,775.	2,790.	2,875.
<b>S903A-(2,4,C)- B5G-D-(S,H)- (1,2,3,4)</b>	1,831.	1,837.	1,898.	1,921.	1,945.	1,965.	2,047.	2,089.	2,114.	2,340.	2,377.	2,459.	2,655.	2,672.	2,755.

**Construction***Inner seat structure:*

Polypropylene.

*J-Bar structure:*

Die-cast aluminum with vulcanized rubber disk.

*Back suspension fabric:*

100% polyester.

*Control:*

Die-cast aluminum with plastic handles.

*Cushions:*

Insert molded high resilient urethane foam.

*Fixed height arms/3-D arms:*

Integrally colored, textured glass-reinforced nylon.

*Armpads:*

ABS plastic with optional padded black leather covering.

*Base:*

Die-cast aluminum with powder coating or polished aluminum.

*Casters:*

Integrally colored, textured nylon.

**Controls***Advanced control:*Pneumatic seat height, synchronized tilt with side crank tension adjustment, forward tilt, multiple position tilt lock, 360° swivel.*Basic control:*Pneumatic seat height, synchronized tilt with side crank tension adjustment, no forward tilt, multiple position tilt lock, 360° swivel.**COM/COL Textile Requirement**

	<i>fabric yds</i>	<i>leather sq. ft.</i>
chair	0.8	12

**KnollTextiles and Spinneybeck  
Leathers**

Please refer to the matrices at the beginning of the price list for Approved Textiles and Leathers.

# Open Up<sup>®</sup> mid-back chair

Designer(s):  
Mathias Seiler for Sedus



pattern no.	description
<b>S903C-(2,4,C)- B5G-D-(S,H)- (1,2,3,4)</b>	armless, basic control, standard seat



## Order Code

<i>Example:</i>	<b>S903P-4-F5G-D-H-2-K451/4</b>
<b>S903P</b>	Open Up mid-back with 3D plastic arms
<b>4</b>	silver painted base
<b>F5G</b>	advanced control
<b>D</b>	standard seat
<b>H</b>	black hard caster
<b>2</b>	black mesh back
<b>K451/4</b>	Una/Ebony seat pad

## Ordering Information

Gel armpads (insert a G into the pattern code after the P or A indicating type of arm. Available on both fixed and 3D arms.)

### Specify:

- Chair family and arm type
- Finish color  
Black painted aluminum (2)  
Silver painted aluminum (4)  
Polished aluminum (C)
- Specify mesh color  
Navy (1)  
Black (2)  
Wine (3)  
Light Grey (4)
- Upholstery selection with color

List prices shown include fabric or leather upholstery. Contact your Knoll representative for colors.

### COM/COL ordering information:

For Customer's Own Material/Leather, see approval requirements, important processing instructions and full ordering information in the Fabric Application and Selling Policy sections of the Price List.

When specifying suede and shrunken cowhide, add 10% to the leather square footage requirement. When specifying calf-skin, add 15% to the leather square footage requirement.

### Options

Code:	Upchg:	Description:
<b>C</b>	\$350	Polished aluminum finish
<b>G</b>	\$114	Gel armpads (insert a G into the pattern code after the P or A indicating type of arm. Available on both fixed and 3D arms.)

Code:	Upchg:	Description:
<b>J</b>	\$84	Black leather arm pad (substitute J for P) not available on fixed arms
<b>R</b>	n/c	Shorter seat - 16.9" depth (substitute R for D)
<b>L</b>	\$29	Adjustable lumbar (substitute L for G)
<b>H</b>	n/c	Black hard caster
<b>S</b>	n/c	Soft grey caster
<b>Perf- (528)</b>	\$120	For perforated leather insert code Perf-(528) after the leather selection (or see the Perforated Leather sheet in the Spinneybeck Leather Application section at the beginning of this price list for more codes)



pattern no.	grades <b>A</b>	COM <b>B</b>	<b>C</b>	<b>D</b>	<b>E</b>	<b>F</b>	<b>G</b>	<b>H</b>	<b>I</b>	<b>T</b>	COL <b>U</b>	<b>V</b>	<b>W</b>	<b>X</b>	<b>Y</b>
<b>S903C-(2,4,C)- B5G-D-(S,H)- (1,2,3,4)</b>	\$1,697.	\$1,703.	\$1,763.	\$1,789.	\$1,812.	\$1,831.	\$1,913.	\$1,954.	\$1,981.	\$2,203.	\$2,240.	\$2,324.	\$2,521.	\$2,535.	\$2,622.

**Construction**

*Inner seat structure:*  
Polypropylene.

*J-Bar structure:*  
Die-cast aluminum with vulcanized rubber disk.

*Back suspension fabric:*  
100% polyester.

*Control:*  
Die-cast aluminum with plastic handles.

*Cushions:*  
Insert molded high resilient urethane foam.

*Fixed height arms/3-D arms:*  
Integrally colored, textured glass-reinforced nylon.

*Armpads:*  
ABS plastic with optional padded black leather covering.

*Base:*  
Die-cast aluminum with powder coating or polished aluminum.

*Casters:*  
Integrally colored, textured nylon.

**Controls**

*Advanced control:*  
Pneumatic seat height, synchronized tilt with side crank tension adjustment, forward tilt, multiple position tilt lock, 360° swivel.

*Basic control:*  
Pneumatic seat height, synchronized tilt with side crank tension adjustment, no forward tilt, multiple position tilt lock, 360° swivel.

**COM/COL Textile Requirement**

	<i>fabric yds</i>	<i>leather sq. ft.</i>
chair	0.8	12

**Knoll Textiles and Spinneybeck Leathers**

Please refer to the matrices at the beginning of the price list for Approved Textiles and Leathers.

# Open Up<sup>®</sup> replacement seats

Designer(s):  
Mathias Seiler for Sedus



pattern no.	description
<b>S9013DSEAT</b>	seat upholstery assembly - standard, 18.4" depth
<b>S9013RSEAT</b>	seat upholstery assembly - shorter, 16.9" depth

## Order Code

*Example:* **S9013DSEAT**  
**S9013D SEAT** Open Up replacement seat option - Standard Seat depth

**K451/4** Una/Ebony seat pad

## Ordering Information

*Specify:*

1. Pattern number
2. Specify upholstery selection with color

List prices shown include fabric or leather upholstery. Contact your Knoll representative for colors.

*COM/COL ordering information:*  
For Customer's Own Material/Leather, see approval requirements, important processing instructions and full ordering information in the Fabric Application and Selling Policy sections of the Price List.

When specifying suede and shrunken cowhide, add 10% to the leather square footage requirement. When specifying calf-skin, add 15% to the leather square footage requirement.

## Options

Code:	Upchg:	Description:
<b>Perf- (528)</b>	\$120	For perforated leather insert code Perf-(528) after the leather selection (or see Perforated Leather information sheet in the Spinneybeck Leather Application section at the beginning of this Price List for more choices and codes)

pattern no.	grades A	COM B	C	D	E	F	G	H	I	T	COL U	V	W	X	Y
<b>S9013DSEAT</b>	\$233.	\$242.	\$301.	\$325.	\$352.	\$368.	\$452.	\$492.	\$518.	\$719.	\$754.	\$840.	\$1,034.	\$1,052.	\$1,136.
<b>S9013RSEAT</b>	233.	242.	301.	325.	352.	368.	452.	492.	518.	719.	754.	840.	1,034.	1,052.	1,136.

**Construction**

*Inner seat structure:*  
Polypropylene.

*Cushions:*  
Insert molded high resilient urethane foam.

**COM/COL Textile Requirement**

	<i>fabric</i>	<i>leather</i>
	<i>yds</i>	<i>sq.ft.</i>
chair	0.8	12

**KnollTextiles and Spinneybeck  
Leathers**

Please refer to the matrices at the beginning of the price list for Approved Textiles and Leathers.

# Open Up<sup>®</sup> side chair

	pattern no.	description
<i>Designer(s):</i> Mathias Seiler for Sedus  	<b>S908-2-SL-2</b>	Stacking side chair / black painted base
	<b>S908-4-SL-2</b>	Stacking side chair / silver painted base
	<b>S908-C-SL-2</b>	Stacking side chair / chrome base

## Order Code

<i>Example:</i>	<b>S908-4-SL-2 K451/4</b>
<b>S908</b>	Open Up stacking side chair (stacks 5-high)
<b>4-SL</b>	silver painted base
<b>2</b>	black mesh back
<b>K451/4</b>	Una/Ebony seat pad

*Example for Cal 133:*

**S908-4-SL-2-C-K451/4**

## Ordering Information

*Specify:*

1. Pattern number
2. Finish color  
Black painted aluminum (2)  
Silver painted aluminum (4)  
Chrome (C)
3. Specify mesh color  
Black only (2)
4. Insert C for Cal 133, if applicable
5. Seat upholstery selection with color

List prices shown include fabric or leather upholstery. Contact your Knoll representative for colors.

*COM/COL ordering information:*

For Customer's Own Material/Leather, see approval requirements, important processing instructions and full ordering information in the Fabric Application and Selling Policy sections of the Price List.

When specifying suede and shrunken cowhide, add 10% to the leather square footage requirement. When specifying calf-skin, add 15% to the leather square footage requirement.

## Options

Code:	Upchg:	Description:
<b>Perf-</b>	\$114	For perforated leather insert code
<b>(528)</b>		Perf-(528) after the leather selection (or see the Perforated Leather sheet in the Spinneybeck Leather Application section at the beginning of this Price List for more choices and codes)
<b>C</b>	\$90	Cal 133 (available for side chair only). Insert C after mesh color in pattern logic.

Note: The Open Up side chair stacks 5-high on the floor, measuring 41.5" high, 34" deep and 22.75" wide.

pattern no.	grades A	COM B	C	D	E	F	G	H	I	T	COL U	V	W	X	Y
<b>S908-2-SL-2</b>	\$1,085.	\$1,104.	\$1,133.	\$1,153.	\$1,168.	\$1,188.	\$1,217.	\$1,243.	\$1,271.	\$1,353.	\$1,388.	\$1,479.	\$1,620.	\$1,682.	\$1,746.
<b>S908-4-SL-2</b>	1,085.	1,104.	1,133.	1,153.	1,168.	1,188.	1,217.	1,243.	1,271.	1,353.	1,388.	1,479.	1,620.	1,682.	1,746.
<b>S908-C-SL-2</b>	1,210.	1,231.	1,259.	1,281.	1,296.	1,317.	1,344.	1,380.	1,401.	1,487.	1,522.	1,613.	1,756.	1,822.	1,887.

**Construction**

*Inner seat structure:*  
Polypropylene.

*Back suspension fabric:*  
100% polyester.

*Cushions:*  
Insert molded high resilient urethane foam.

*Frame:*  
Black or silver painted aluminum, or chrome.

**COM/COL Textile Requirement**

	<i>fabric yds</i>	<i>leather sq. ft.</i>
chair	0.8	12

*Cal 133:*  
♣ = Cal 133 upholstery available. See textile matrix at the beginning of the Price List for pre-approved Cal 133 textiles.

**KnollTextiles and Spinneybeck  
Leathers**

Please refer to the matrices at the beginning of the price list for Approved Textiles and Leathers.

# Open Up<sup>®</sup> Dimensions and Operating Instructions

## Seat

	Seat Height	Seat Depth	Seat Width
Open Up complies with BIFMA G1-2002 Ergonomic Guidelines.			
<b>Mid-Back</b>	16" - 21"	16.9" Shorter 18.4" Standard	19.5"
<b>High-Back</b>	16" - 21"	16.9" Shorter 18.4" Standard	19.5"
<b>Side Chair</b>	18.5"	17"	19.5"

## Back

## Armrests

	Backrest Height	Head Rest	Backrest Width	Armrest Height (From Floor)	Armrest Height (From Seat)	Width between Armrests
<b>High-Back</b>	22 1/2"	7"	18"	<b>3D</b> 23" - 28 1/2"	7 1/2" - 11 1/2"	20"
<b>Mid-Back</b>	22 1/2"	—	18"	<b>Fixed</b> 26"	8"	20"
<b>Side Chair</b>	17"	—	18.5"	26"	8 1/2"	19 1/4"

\*Range achieved with single chair, or combination of chairs. Open Up's low cylinder, medium and high cylinder options exceed the 15" - 19.9" seat height range. Open Up's medium cylinder range is shown above.

\*\*Adjustable: Include part of 0° - 4° rearward \*\*\*Adjustable: Includes part of 5.9" - 9.8"

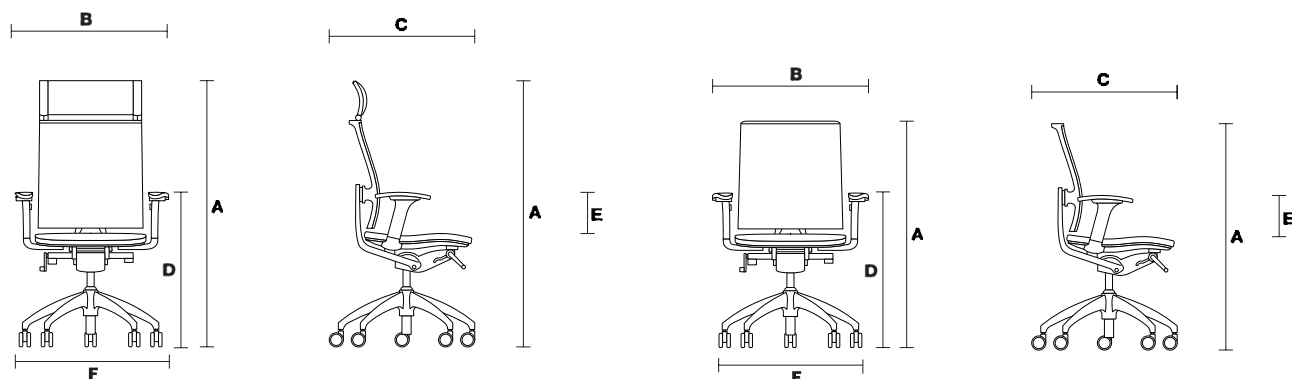

	High-Back	Mid-Back	Side Chair
<b>A</b> overall height	46" - 51 1/4" *	38" - 43 1/4"	35"
<b>B</b> overall width	27"	27"	22 3/4"
<b>C</b> overall depth	26"	26"	25"
<b>D</b> 3D arm height (from floor)	26" - 30"	26" - 30"	26"
<b>E</b> 3D arm height (from seat ref. pt.)	7 1/2" - 11 1/2"	7 1/2" - 11 1/2"	8"
<b>F</b> base diameter	27"	27"	19"

\*High-back overall height includes headrest adjustments.



### Pneumatic seat height adjustment

To raise seat:  
Remove your weight from chair; lift lever on right side of chair, releasing lever at desired seat height.

To lower seat:  
While seated, lift lever on right side of chair, releasing lever at desired seat height.



### Lumbar adjustment - optional

Using both hands, move lumbar support up or down to desired position.



### Tilt lock and multiple lock

To unlock backrest:  
On left side of chair, pull lever upward and release it. Lean against backrest and it will automatically release.

To lock backrest into position:  
Lean back until backrest reaches desired angle. On left side of chair, pull lever down and release it to lock backrest into position.



### 3-D arm adjustment - optional

**Armpad height:**  
Press button on inside of armrest and lift or lower armrest to desired height. Release button and armrest will engage.

**Armpad depth:**  
Push armrest backward or forward to desired position. It will engage automatically.

**Armpad pivot:**  
Grasp armpad at front and back. Pivot armpad clockwise to angle in, or counterclockwise to return to original position.



### Tension adjustment

On right side of chair, pull out handle. Crank handle clockwise (forward) to increase tension or counterclockwise (backward) to decrease tension. Return handle to its original position by pushing it back in and out of way.



### Headrest adjustment - high-back only

**Headrest height:**  
Grasp headrest from top and bottom, move it up or down to desired position.







**Headrest angle:**  
Grasp headrest from each side, push forward or backward to desired position.





### Forward tilt - advanced control only

While standing, twist lever under left side of seat backward 180° to engage forward tilt. Twist lever forward 180° to return seat to level position.

Life®  
*plastic base, knitted seat topper, no back topper*

	arm	description	pattern no. *
<i>Designer(s):</i> Formway Design Studio, 2002	Armless 	Plastic base, Life Knitted Seat Topper (KST), no back topper	<b>55C-3-(2 or 6)-A-5-K-GH BSF( )-KST( )-NB</b>
<i>Award(s):</i> Good Design Award, Chicago Athenaeum, 2003, USA NeoCon Gold, Best of NeoCon, Task Chair - Seating Design, June 2002, USA IIDEX/NeoCon, Sustainable Design Gold Award, 2002, Canada	Fixed Plastic 	Plastic base, Life Knitted Seat Topper (KST), no back topper	<b>55A-3-(2 or 6)-A-5-K-GH BSF( )-KST( )-NB</b>
	Fixed Aluminum 	Plastic base, Life Knitted Seat Topper (KST), no back topper	<b>55M-3-(2 or 6)-A-5-K-GH BSF( )-KST( )-NB</b>
	Height Adjustable 	Plastic base, Life Knitted Seat Topper (KST), no back topper	<b>55H-3-(2 or 6)-A-5-K-GH BSF( )-KST( )-NB</b>
	High Performance 	Plastic base, Life Knitted Seat Topper (KST), no back topper	<b>55P-3-(2 or 6)-A-5-K-GH BSF( )-KST( )-NB</b>

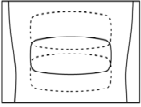
\*For specification directions, please see page 62.  
 For upholstery selections and pricing see facing page.

Order Code	Ordering Information	Options
<i>Example:</i> <b>55H-3-6-A5K-GH-BSF33-ST-K1206/9-NB</b>	<i>Specify:</i>	<i>Cylinder Height Options:</i>
<b>55</b> Life chair	1. Pattern number with back suspension fabric BSF( ).	For height ranges see Life Dimensions and Operating Instructions. Replace 5 in pattern with one of the following options:
<b>H</b> Height adjustable arms	2. Seat topper textile, either KST( ) for knitted seat topper or ST( ) for fabric or leather. NS for no seat topper.	<i>Code: Upchg: Description:</i>
<b>3</b> High back	3. Back topper textile, BT( ) for fabric or leather. NB for no back topper.	L n/c low cylinder
<b>6</b> Grey base and grey levers		H n/c high cylinder
<b>A</b> Advanced control with sliding seat		
<b>5</b> Standard height cylinder		<i>Lumbar Options:</i>
<b>K</b> No lumbar		For lumbar, replace K with L( ) in the pattern number. Specify color code in the parentheses after L.
<b>GH</b> Grey hard caster		<i>Code: Upchg: Description:</i>
<b>BSF33</b> Plum Back Suspension Fabric	<i>Armpad Options:</i>	L(K1029/13) \$98 Vibe, Glam
<b>ST-K1206/9</b> Knoll Hopsack, Magenta seat topper	For leather armpads, add J after the arm pattern code (Example: 55PJ) and specify leather. Available in Spinneybeck Volo (Grade U) and Sabrina (Grade W) leathers.	L(K1029/14) \$98 Vibe, Poise
<b>NB</b> No back topper		L(K1029/BLK) \$98 Vibe, Black
	<i>Code: Upchg: Description:</i>	<i>Lumbar detail</i>
	J \$258 Spinneybeck Volo	
	J \$347 Spinneybeck Sabrina	
	<i>Base Options:</i>	<i>Caster Options:</i>
	<i>Code: Upchg: Description:</i>	Replace GH in pattern with one of the following options:
	2 n/c black plastic base	<i>Code: Upchg: Description:</i>
	6 n/c grey plastic base	BH n/c hard black caster
		BR \$42 soft black caster
		GR \$42 soft grey caster
		CH \$25 hard clear caster
		CR \$67 soft clear caster
		<i>Glides:</i>
		Replace GH in pattern with GG. No upcharge for this option.
		<i>Glide detail</i>
		







KST or COM	A	B	C	D	E	F	G	H	I	T	COL U	V	W	X	Y
\$1,243.															
1,403.															
1,454.															
1,458.															
1,538.															

**Back Suspension Fabric - Standard****Knitted Seat Topper - Base Grade****Textile Options**

<i>Code:</i>	<i>Description:</i>	<i>Code:</i>	<i>Description:</i>		<i>CAL 133 Options:</i>
BSF 15	Eclipse	KST 15	Eclipse/Blackout	Please refer to the matrices at the beginning of the price list for approved KnollTextiles fabrics and Spinneybeck leathers for seat and back toppers.  <i>Ultra Seat Topper Options:</i> For ultra seat topper, which is 1/2" thicker foam than standard seat topper, add U before the seat topper pattern code.  <i>Code: Upchg: Description:</i> UST \$59 Ultra Seat Topper in fabric or leather UKST \$59 Ultra Knitted Seat Topper  <i>Perforated Leather Option:</i> For perforated patterns in leather seat and/or back toppers, insert PERF() after ST() and/or BT() in pattern number. Seat topper upcharge is \$105. Back topper upcharge is \$220. See Spinneybeck Leather Application section for pattern codes.  <b>COM/COL Textile Requirements</b> <i>Seat Topper:</i> 0.7 yards fabric 9.0 sq ft leather  <i>Back Topper:</i> 1.3 yards fabric 16.0 sq ft leather	To meet Cal 133 requirements, Life must have seat topper or seat and back toppers with approved FR upholstery. Not compliant with KST. See textile matrix at the beginning of the price list for pre-approved Cal 133 textiles. * = Cal 133 pre-approved.  Insert C after ST() option. See below for upcharges.  <i>Code: Upchg: Description:</i> C \$81 CAL 133 fabric seat topper C \$277 CAL 133 fabric seat and back toppers C \$159 CAL 133 leather seat topper C \$390 CAL 133 leather seat and back toppers. No minimum order required
BSF 17	Blackout	KST 18	Camel		
BSF 19	Beige	KST 19	Beige		
BSF 22	Grain	KST 31	Dark Blue		
BSF 31	Navy	KST 32	Scarlet		
BSF 32	Rouge	KST 33	Grape		
BSF 33	Plum	KST 36	Olive		
BSF 34	Sunset	KST 38	Dark Brown		
BSF 35	Avocado	KST 40	Dark Grey		
BSF 37	Bronze				
BSF 38	Chestnut				
BSF 39	Platinum				
BSF 40	Charcoal				
BSF 41	Frost				
			For no seat topper (NS), subtract \$51 from KST base grade list price.		
			Ordering Samples/Viewing online: To view BSF and KST colors see Surface Finish Library on knoll.com. Physical samples are the best representation of color. To order samples, contact a Knoll sales representative or Knoll dealer.		



# Life®

*plastic base, seat topper, no back topper*

	arm	description	pattern no. *
<b>Designer(s):</b> Formway Design Studio, 2002  <b>Award(s):</b> Good Design Award, Chicago Athenaeum, 2003, USA NeoCon Gold, Best of NeoCon, Task Chair - Seating Design, June 2002, USA IIDEX/NeoCon, Sustainable Design Gold Award, 2002, Canada	Armless 	Plastic base, fabric or leather seat topper, no back topper	<b>55C-3-(2 or 6)-A-5-K-GH BSF( )-ST( )-NB</b>
	Fixed Plastic 	Plastic base, fabric or leather seat topper, no back topper	<b>55A-3-(2 or 6)-A-5-K-GH BSF( )-ST( )-NB</b>
	Fixed Aluminum 	Plastic base, fabric or leather seat topper, no back topper	<b>55M-3-(2 or 6)-A-5-K-GH BSF( )-ST( )-NB</b>
	Height Adjustable 	Plastic base, fabric or leather seat topper, no back topper	<b>55H-3-(2 or 6)-A-5-K-GH BSF( )-ST( )-NB</b>
	High Performance 	Plastic base, fabric or leather seat topper, no back topper	<b>55P-3-(2 or 6)-A-5-K-GH BSF( )-ST( )-NB</b>

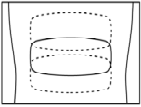

\*For specification directions, please see page 62.  
 For upholstery selections and pricing see facing page.

Order Code	Ordering Information	Options	
Example: <b>55H-3-6-A5K-GH-BSF33-ST-K1206/9-NB</b> <b>55</b> Life chair <b>H</b> Height adjustable arms <b>3</b> High back <b>6</b> Grey base and grey levers <b>A</b> Advanced control with sliding seat <b>5</b> Standard height cylinder <b>K</b> No lumbar <b>GH</b> Grey hard caster <b>BSF33</b> Plum Back Suspension Fabric <b>ST-K1206/9</b> Knoll Hopsack, Magenta seat topper <b>NB</b> No back topper	<b>Specify:</b> <ol style="list-style-type: none"> <li>1. Pattern number with back suspension fabric BSF( ).</li> <li>2. Seat topper textile, either KST( ) for knitted seat topper or ST( ) for fabric or leather. NS for no seat topper.</li> <li>3. Back topper textile, BT( ) for fabric or leather. NB for no back topper.</li> </ol> <b>Options</b> <b>Armpad Options:</b> For leather armpads, add J after the arm pattern code (Example: 55PJ) and specify leather. Available in Spinneybeck Volo (Grade U) and Sabrina (Grade W) leathers. Code: Upchg: Description: J \$258 Spinneybeck Volo J \$347 Spinneybeck Sabrina  <b>Base Options:</b> Code: Upchg: Description: 2 n/c black plastic base 6 n/c grey plastic base	<b>Cylinder Height Options:</b> For height ranges see Life Dimensions and Operating Instructions. Replace 5 in pattern with one of the following options: Code: Upchg: Description: L n/c low cylinder H n/c high cylinder  <b>Lumbar Options:</b> For lumbar, replace K with L( ) in the pattern number. Specify color code in the parentheses after L. Code: Upchg: Description: L(K1029/13) \$98 Vibe, Glam L(K1029/14) \$98 Vibe, Poise L(K1029/BLK) \$98 Vibe, Black  <b>Lumbar detail</b> 	<b>Caster Options:</b> Replace GH in pattern with one of the following options: Code: Upchg: Description: BH n/c hard black caster BR \$42 soft black caster GR \$42 soft grey caster CH \$25 hard clear caster CR \$67 soft clear caster  <b>Glides:</b> Replace GH in pattern with GG. No upcharge for this option.  <b>Glide detail</b> 

KST or COM	A	B	C	D	E	F	G	H	I	T	COL U	V	W	X	Y
\$1,243.	\$1,294.	\$1,300.	\$1,325.	\$1,349.	\$1,366.	\$1,391.	\$1,403.	\$1,422.	\$1,447.	\$1,639.	\$1,669.	\$1,732.	\$1,881.	\$1,896.	\$1,983.
1,403.	1,454.	1,460.	1,485.	1,509.	1,526.	1,551.	1,563.	1,582.	1,607.	1,799.	1,829.	1,892.	2,041.	2,056.	2,143.
1,454.	1,505.	1,511.	1,536.	1,560.	1,577.	1,602.	1,614.	1,633.	1,658.	1,850.	1,880.	1,943.	2,092.	2,107.	2,194.
1,458.	1,509.	1,515.	1,540.	1,564.	1,581.	1,606.	1,618.	1,637.	1,662.	1,854.	1,884.	1,947.	2,096.	2,111.	2,198.
1,538.	1,589.	1,595.	1,620.	1,644.	1,661.	1,686.	1,698.	1,717.	1,742.	1,934.	1,964.	2,027.	2,176.	2,191.	2,278.

**Back Suspension Fabric - Standard**

Code:	Description:
BSF 15	Eclipse
BSF 17	Blackout
BSF 19	Beige
BSF 22	Grain
BSF 31	Navy
BSF 32	Rouge
BSF 33	Plum
BSF 34	Sunset
BSF 35	Avocado
BSF 37	Bronze
BSF 38	Chestnut
BSF 39	Platinum
BSF 40	Charcoal
BSF 41	Frost

**Knitted Seat Topper - Base Grade**

Code:	Description:
KST 15	Eclipse/Blackout
KST 18	Camel
KST 19	Beige
KST 31	Dark Blue
KST 32	Scarlet
KST 33	Grape
KST 36	Olive
KST 38	Dark Brown
KST 40	Dark Grey

For no seat topper (NS), subtract \$51 from KST base grade list price.

Ordering Samples/Viewing online:  
To view BSF and KST colors see Surface Finish Library on knoll.com. Physical samples are the best representation of color. To order samples, contact a Knoll sales representative or Knoll dealer.

**Textile Options**

Please refer to the matrices at the beginning of the price list for approved Knoll Textiles fabrics and Spinneybeck leathers for seat and back toppers.

**Ultra Seat Topper Options:**

For ultra seat topper, which is 1/2" thicker foam than standard seat topper, add U before the seat topper pattern code.

Code:	Upchg:	Description:
UST	\$59	Ultra Seat Topper in fabric or leather
UKST	\$59	Ultra Knitted Seat Topper

**Perforated Leather Option:**

For perforated patterns in leather seat and/or back toppers, insert PERF() after ST() and/or BT() in pattern number. Seat topper upcharge is \$105. Back topper upcharge is \$220. See Spinneybeck Leather Application section for pattern codes.

**COM/COL Textile Requirements**

**Seat Topper:**  
0.7 yards fabric  
9.0 sq ft leather

**Back Topper:**  
1.3 yards fabric  
16.0 sq ft leather

**CAL 133 Options:**

To meet Cal 133 requirements, Life must have seat topper or seat and back toppers with approved FR upholstery. Not compliant with KST. See textile matrix at the beginning of the price list for pre-approved Cal 133 textiles. # = Cal 133 pre-approved.





Insert C after ST() option. See below for upcharges.

Code:	Upchg:	Description:
C	\$81	CAL 133 fabric seat topper
C	\$277	CAL 133 fabric seat and back toppers
C	\$159	CAL 133 leather seat topper
C	\$390	CAL 133 leather seat and back toppers

**Minimum order of 3 chairs required**  
No minimum order required



# Life®

plastic base, seat topper and back topper

	arm	description	pattern no. *
<b>Designer(s):</b> Formway Design Studio, 2002  <b>Award(s):</b> Good Design Award, Chicago Athenaeum, 2003, USA NeoCon Gold, Best of NeoCon, Task Chair - Seating Design, June 2002, USA IIDEX/NeoCon, Sustainable Design Gold Award, 2002, Canada	Armless 	Plastic base, fabric or leather seat and back toppers	<b>55C-3-(2 or 6)-A-5-K-GH BSF( )-ST( )-BT( )</b>
	Fixed Plastic 	Plastic base, fabric or leather seat and back toppers	<b>55A-3-(2 or 6)-A-5-K-GH BSF( )-ST( )-BT( )</b>
	Fixed Aluminum 	Plastic base, fabric or leather seat and back toppers	<b>55M-3-(2 or 6)-A-5-K-GH BSF( )-ST( )-BT( )</b>
	Height Adjustable 	Plastic base, fabric or leather seat and back toppers	<b>55H-3-(2 or 6)-A-5-K-GH BSF( )-ST( )-BT( )</b>
	High Performance 	Plastic base, fabric or leather seat and back toppers	<b>55P-3-(2 or 6)-A-5-K-GH BSF( )-ST( )-BT( )</b>

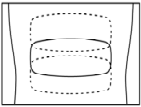

\*For specification directions, please see page 62.  
 For upholstery selections and pricing see facing page.

Order Code	Ordering Information	Options
Example: <b>55H-3-6-A5K-GH-BSF33-ST-K1206/9-NB</b> <b>55</b> Life chair <b>H</b> Height adjustable arms <b>3</b> High back <b>6</b> Grey base and grey levers <b>A</b> Advanced control with sliding seat <b>5</b> Standard height cylinder <b>K</b> No lumbar <b>GH</b> Grey hard caster <b>BSF33</b> Plum Back Suspension Fabric <b>ST-K1206/9</b> Knoll Hopsack, Magenta seat topper <b>NB</b> No back topper	Specify: 1. Pattern number with back suspension fabric BSF( ). 2. Seat topper textile, either KST( ) for knitted seat topper or ST( ) for fabric or leather. NS for no seat topper. 3. Back topper textile, BT( ) for fabric or leather. NB for no back topper.  <b>Options</b>  Armpad Options: For leather armpads, add J after the arm pattern code (Example: 55PJ) and specify leather. Available in Spinneybeck Volo (Grade U) and Sabrina (Grade W) leathers.  Code: Upchg: Description: J \$258 Spinneybeck Volo J \$347 Spinneybeck Sabrina  Base Options:  Code: Upchg: Description: 2 n/c black plastic base 6 n/c grey plastic base	Cylinder Height Options: For height ranges see Life Dimensions and Operating Instructions. Replace 5 in pattern with one of the following options:  Code: Upchg: Description: L n/c low cylinder H n/c high cylinder  Lumbar Options: For lumbar, replace K with L( ) in the pattern number. Specify color code in the parentheses after L.  Code: Upchg: Description: L(K1029/13) \$98 Vibe, Glam L(K1029/14) \$98 Vibe, Poise L(K1029/BLK) \$98 Vibe, Black  Lumbar detail   Caster Options: Replace GH in pattern with one of the following options:  Code: Upchg: Description: BH n/c hard black caster BR \$42 soft black caster GR \$42 soft grey caster CH \$25 hard clear caster CR \$67 soft clear caster  Glides: Replace GH in pattern with GG. No upcharge for this option.  Glide detail 

KST or COM	A	B	C	D	E	F	G	H	I	T	COL U	V	W	X	Y
\$1,453.	\$1,540.	\$1,572.	\$1,628.	\$1,687.	\$1,731.	\$1,761.	\$1,879.	\$1,904.	\$1,942.	\$2,241.	\$2,359.	\$2,479.	\$2,942.	\$2,968.	\$3,099.
1,613.	1,700.	1,732.	1,788.	1,847.	1,891.	1,921.	2,039.	2,064.	2,102.	2,401.	2,519.	2,639.	3,102.	3,128.	3,259.
1,664.	1,751.	1,783.	1,839.	1,898.	1,942.	1,972.	2,090.	2,115.	2,153.	2,452.	2,570.	2,690.	3,153.	3,179.	3,310.
1,668.	1,755.	1,787.	1,843.	1,902.	1,946.	1,976.	2,094.	2,119.	2,157.	2,456.	2,574.	2,694.	3,157.	3,183.	3,314.
1,748.	1,835.	1,867.	1,923.	1,982.	2,026.	2,056.	2,174.	2,199.	2,237.	2,536.	2,654.	2,774.	3,237.	3,263.	3,394.

**Back Suspension Fabric - Standard**

Code:	Description:
BSF 15	Eclipse
BSF 17	Blackout
BSF 19	Beige
BSF 22	Grain
BSF 31	Navy
BSF 32	Rouge
BSF 33	Plum
BSF 34	Sunset
BSF 35	Avocado
BSF 37	Bronze
BSF 38	Chestnut
BSF 39	Platinum
BSF 40	Charcoal
BSF 41	Frost

**Knitted Seat Topper - Base Grade**

Code:	Description:
KST 15	Eclipse/Blackout
KST 18	Camel
KST 19	Beige
KST 31	Dark Blue
KST 32	Scarlet
KST 33	Grape
KST 36	Olive
KST 38	Dark Brown
KST 40	Dark Grey

For no seat topper (NS), subtract \$51 from KST base grade list price.

Ordering Samples/Viewing online:  
To view BSF and KST colors see Surface Finish Library on knoll.com. Physical samples are the best representation of color. To order samples, contact a Knoll sales representative or Knoll dealer.

**Textile Options**

Please refer to the matrices at the beginning of the price list for approved Knoll Textiles fabrics and Spinneybeck leathers for seat and back toppers.

**Ultra Seat Topper Options:**

For ultra seat topper, which is 1/2" thicker foam than standard seat topper, add U before the seat topper pattern code.

Code:	Upchg:	Description:
UST	\$59	Ultra Seat Topper in fabric or leather
UKST	\$59	Ultra Knitted Seat Topper

**Perforated Leather Option:**

For perforated patterns in leather seat and/or back toppers, insert PERF() after ST() and/or BT() in pattern number. Seat topper upcharge is \$105. Back topper upcharge is \$220. See Spinneybeck Leather Application section for pattern codes.

**COM/COL Textile Requirements**

**Seat Topper:**  
0.7 yards fabric  
9.0 sq ft leather

**Back Topper:**  
1.3 yards fabric  
16.0 sq ft leather

**CAL 133 Options:**

To meet Cal 133 requirements, Life must have seat topper or seat and back toppers with approved FR upholstery. Not compliant with KST. See textile matrix at the beginning of the price list for pre-approved Cal 133 textiles. \* = Cal 133 pre-approved.

Insert C after ST() option. See below for upcharges.

Code:	Upchg:	Description:
C	\$81	CAL 133 fabric seat topper
C	\$277	CAL 133 fabric seat and back toppers
C	\$159	CAL 133 leather seat topper
C	\$390	CAL 133 leather seat and back toppers



**Minimum order of 3 chairs required**  
No minimum order required

Life®

*aluminum base, knitted seat topper, no back topper*

	arm	description	pattern no. *
<p><i>Designer(s):</i> Formway Design Studio, 2002</p> <p><i>Award(s):</i> Good Design Award, Chicago Athenaeum, 2003, USA NeoCon Gold, Best of NeoCon, Task Chair - Seating Design, June 2002, USA IIDEX/NeoCon, Sustainable Design Gold Award, 2002, Canada</p> 	Armless	Aluminum base, Life Knitted Seat Topper (KST), no back topper	<b>55C-3-(3 or 4)-A-5-K-GH BSF( )-KST( )-NB</b>
	Fixed Plastic	Aluminum base, Life Knitted Seat Topper (KST), no back topper	<b>55A-3-(3 or 4)-A-5-K-GH BSF( )-KST( )-NB</b>
	Fixed Aluminum	Aluminum base, Life Knitted Seat Topper (KST), no back topper	<b>55M-3-(3 or 4)-A-5-K-GH BSF( )-KST( )-NB</b>
	Height Adj.	Aluminum base, Life Knitted Seat Topper (KST), no back topper	<b>55H-3-(3 or 4)-A-5-K-GH BSF( )-KST( )-NB</b>
	High Perf.	Aluminum base, Life Knitted Seat Topper (KST), no back topper	<b>55P-3-(3 or 4)-A-5-K-GH BSF( )-KST( )-NB</b>

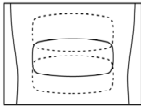
\*For specification directions, please see page 62.  
For upholstery selections and pricing see facing page.





Order Code	Ordering Information	Options
<p><i>Example:</i> <b>55H-3-6-A5K-GH-BSF33-ST-K1206/9-NB</b></p> <p><b>55</b> Life chair</p> <p><b>H</b> Height adjustable arms</p> <p><b>3</b> High back</p> <p><b>6</b> Grey base and grey levers</p> <p><b>A</b> Advanced control with sliding seat</p> <p><b>5</b> Standard height cylinder</p> <p><b>K</b> No lumbar</p> <p><b>GH</b> Grey hard caster</p> <p><b>BSF33</b> Plum Back Suspension Fabric</p> <p><b>ST-K1206/9</b> Knoll Hopsack, Magenta seat topper</p> <p><b>NB</b> No back topper</p>	<p><i>Specify:</i></p> <ol style="list-style-type: none"> <li>1. Pattern number with back suspension fabric BSF( ).</li> <li>2. Seat topper textile, either KST( ) for knitted seat topper or ST( ) for fabric or leather. NS for no seat topper.</li> <li>3. Back topper textile, BT( ) for fabric or leather. NB for no back topper.</li> </ol> <p><b>Options</b></p> <p><i>Armpad Options:</i> For leather armpads, add J after the arm pattern code (Example: 55PJ) and specify leather. Available in Spinneybeck Volo (Grade U) and Sabrina (Grade W) leathers.</p> <p><i>Code: Upchg: Description:</i> J \$258 Spinneybeck Volo J \$347 Spinneybeck Sabrina</p> <p><i>Base Options:</i></p> <p><i>Code: Upchg: Description:</i> 3 n/c painted matte aluminum base 4 n/c polished aluminum base</p>	<p><i>Cylinder Height Options:</i> For height ranges see Life Dimensions and Operating Instructions. Replace 5 in pattern with one of the following options:</p> <p><i>Code: Upchg: Description:</i> L n/c low cylinder H n/c high cylinder</p> <p><i>Lumbar Options:</i> For lumbar, replace K with L( ) in the pattern number. Specify color code in the parentheses after L.</p> <p><i>Code: Upchg: Description:</i> L(K1029/13) \$98 Vibe, Glam L(K1029/14) \$98 Vibe, Poise L(K1029/BLK) \$98 Vibe, Black</p> <p><i>Lumbar detail</i></p>  <p><i>Caster Options:</i> Replace GH in pattern with one of the following options:</p> <p><i>Code: Upchg: Description:</i> BH n/c hard black caster BR \$42 soft black caster GR \$42 soft grey caster CH \$25 hard clear caster CR \$67 soft clear caster</p> <p><i>Glides:</i> Replace GH in pattern with GG. No upcharge for this option.</p> <p><i>Glide detail</i></p> 

KST or COM	A	B	C	D	E	F	G	H	I	T	COL U	V	W	X	Y
\$1,297.															
1,458.															
1,508.															
1,512.															
1,594.															

**Back Suspension Fabric - Standard****Knitted Seat Topper - Base Grade****Textile Options**



<i>Code:</i>	<i>Description:</i>	<i>Code:</i>	<i>Description:</i>		<i>CAL 133 Options:</i>
BSF 15	Eclipse	KST 15	Eclipse/Blackout	Please refer to the matrices at the beginning of the price list for approved KnollTextiles fabrics and Spinneybeck leathers for seat and back toppers.  <i>Ultra Seat Topper Options:</i> For ultra seat topper, which is 1/2" thicker foam than standard seat topper, add U before the seat topper pattern code.  <i>Code: Upchg: Description:</i> UST \$59 Ultra Seat Topper in fabric or leather UKST \$59 Ultra Knitted Seat Topper  <i>Perforated Leather Option:</i> For perforated patterns in leather seat and/or back toppers, insert PERF() after ST() and/or BT() in pattern number. Seat topper upcharge is \$105. Back topper upcharge is \$220. See Spinneybeck Leather Application section for pattern codes.  <b>COM/COL Textile Requirements</b> <i>Seat Topper:</i> 0.7 yards fabric 9.0 sq ft leather  <i>Back Topper:</i> 1.3 yards fabric 16.0 sq ft leather	To meet Cal 133 requirements, Life must have seat topper or seat and back toppers with approved FR upholstery. Not compliant with KST. See textile matrix at the beginning of the price list for pre-approved Cal 133 textiles. * = Cal 133 pre-approved.  Insert C after ST() option. See below for upcharges.  <i>Code: Upchg: Description:</i> C \$81 CAL 133 fabric seat topper C \$277 CAL 133 fabric seat and back toppers C \$159 CAL 133 leather seat topper <b>Minimum order of 3 chairs required</b> C \$390 CAL 133 leather seat and back toppers No minimum order required
BSF 17	Blackout	KST 18	Camel		
BSF 19	Beige	KST 19	Beige		
BSF 22	Grain	KST 31	Dark Blue		
BSF 31	Navy	KST 32	Scarlet		
BSF 32	Rouge	KST 33	Grape		
BSF 33	Plum	KST 36	Olive		
BSF 34	Sunset	KST 38	Dark Brown		
BSF 35	Avocado	KST 40	Dark Grey		
BSF 37	Bronze				
BSF 38	Chestnut				
BSF 39	Platinum				
BSF 40	Charcoal				
BSF 41	Frost				
			For no seat topper (NS), subtract \$51 from KST base grade list price.		
			Ordering Samples/Viewing online: To view BSF and KST colors see Surface Finish Library on knoll.com. Physical samples are the best representation of color. To order samples, contact a Knoll sales representative or Knoll dealer.		

Life®  
aluminum base, seat topper, no back topper

	arm	description	pattern no. *
<b>Designer(s):</b> Formway Design Studio, 2002  <b>Award(s):</b> Good Design Award, Chicago Athenaeum, 2003, USA NeoCon Gold, Best of NeoCon, Task Chair - Seating Design, June 2002, USA IIDEX/NeoCon, Sustainable Design Gold Award, 2002, Canada	Armless 	Aluminum base, fabric or leather seat topper, no back topper	<b>55C-3-(3 or 4)-A-5-K-GH BSF( )-ST( )-NB</b>
	Fixed Plastic 	Aluminum base, fabric or leather seat topper, no back topper	<b>55A-3-(3 or 4)-A-5-K-GH BSF( )-ST( )-NB</b>
	Fixed Aluminum 	Aluminum base, fabric or leather seat topper, no back topper	<b>55M-3-(3 or 4)-A-5-K-GH BSF( )-ST( )-NB</b>
	Height Adj. 	Aluminum base, fabric or leather seat topper, no back topper	<b>55H-3-(3 or 4)-A-5-K-GH BSF( )-ST( )-NB</b>
	High Perf. 	Aluminum base, fabric or leather seat topper, no back topper	<b>55P-3-(3 or 4)-A-5-K-GH BSF( )-ST( )-NB</b>

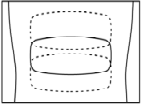

\*For specification directions, please see page 62.  
For upholstery selections and pricing see facing page.

Order Code	Ordering Information	Options
<b>Example:</b> 55H-3-6-A5K-GH-BSF33-ST-K1206/9-NB <b>55</b> Life chair <b>H</b> Height adjustable arms <b>3</b> High back <b>6</b> Grey base and grey levers <b>A</b> Advanced control with sliding seat <b>5</b> Standard height cylinder <b>K</b> No lumbar <b>GH</b> Grey hard caster <b>BSF33</b> Plum Back Suspension Fabric <b>ST-K1206/9</b> Knoll Hopsack, Magenta seat topper <b>NB</b> No back topper	<b>Specify:</b> 1. Pattern number with back suspension fabric BSF( ). 2. Seat topper textile, either KST( ) for knitted seat topper or ST( ) for fabric or leather. NS for no seat topper. 3. Back topper textile, BT( ) for fabric or leather. NB for no back topper.  <b>Options</b>  <b>Armpad Options:</b> For leather armpads, add J after the arm pattern code (Example: 55PJ) and specify leather. Available in Spinneybeck Volo (Grade U) and Sabrina (Grade W) leathers.  <b>Code: Upchg: Description:</b> J \$258 Spinneybeck Volo J \$347 Spinneybeck Sabrina  <b>Base Options:</b>  <b>Code: Upchg: Description:</b> 3 n/c painted matte aluminum base 4 n/c polished aluminum base	<b>Cylinder Height Options:</b> For height ranges see Life Dimensions and Operating Instructions. Replace 5 in pattern with one of the following options:  <b>Code: Upchg: Description:</b> L n/c low cylinder H n/c high cylinder  <b>Lumbar Options:</b> For lumbar, replace K with L( ) in the pattern number. Specify color code in the parentheses after L.  <b>Code: Upchg: Description:</b> L(K1029/13) \$98 Vibe, Glam L(K1029/14) \$98 Vibe, Poise L(K1029/BLK) \$98 Vibe, Black  <b>Lumbar detail</b>   <b>Caster Options:</b> Replace GH in pattern with one of the following options:  <b>Code: Upchg: Description:</b> BH n/c hard black caster BR \$42 soft black caster GR \$42 soft grey caster CH \$25 hard clear caster CR \$67 soft clear caster  <b>Glides:</b> Replace GH in pattern with GG. No upcharge for this option.  <b>Glide detail</b> 



KST or COM	A	B	C	D	E	F	G	H	I	T	COL U	V	W	X	Y
\$1,297.	\$1,348.	\$1,354.	\$1,379.	\$1,403.	\$1,420.	\$1,445.	\$1,457.	\$1,476.	\$1,501.	\$1,693.	\$1,723.	\$1,786.	\$1,935.	\$1,950.	\$2,037.
1,458.	1,509.	1,515.	1,540.	1,564.	1,581.	1,606.	1,618.	1,637.	1,662.	1,854.	1,884.	1,947.	2,096.	2,111.	2,198.
1,508.	1,559.	1,565.	1,590.	1,614.	1,631.	1,656.	1,668.	1,687.	1,712.	1,904.	1,934.	1,997.	2,146.	2,161.	2,248.
1,512.	1,563.	1,569.	1,594.	1,618.	1,635.	1,660.	1,672.	1,691.	1,716.	1,908.	1,938.	2,001.	2,150.	2,165.	2,252.
1,594.	1,645.	1,651.	1,676.	1,700.	1,717.	1,742.	1,754.	1,773.	1,798.	1,990.	2,020.	2,083.	2,232.	2,247.	2,334.

**Back Suspension Fabric - Standard**

Code:	Description:
BSF 15	Eclipse
BSF 17	Blackout
BSF 19	Beige
BSF 22	Grain
BSF 31	Navy
BSF 32	Rouge
BSF 33	Plum
BSF 34	Sunset
BSF 35	Avocado
BSF 37	Bronze
BSF 38	Chestnut
BSF 39	Platinum
BSF 40	Charcoal
BSF 41	Frost

**Knitted Seat Topper - Base Grade**

Code:	Description:
KST 15	Eclipse/Blackout
KST 18	Camel
KST 19	Beige
KST 31	Dark Blue
KST 32	Scarlet
KST 33	Grape
KST 36	Olive
KST 38	Dark Brown
KST 40	Dark Grey

For no seat topper (NS), subtract \$51 from KST base grade list price.

Ordering Samples/Viewing online:  
To view BSF and KST colors see Surface Finish Library on knoll.com. Physical samples are the best representation of color. To order samples, contact a Knoll sales representative or Knoll dealer.

**Textile Options**

Please refer to the matrices at the beginning of the price list for approved Knoll Textiles fabrics and Spinneybeck leathers for seat and back toppers.

**Ultra Seat Topper Options:**  
For ultra seat topper, which is 1/2" thicker foam than standard seat topper, add U before the seat topper pattern code.

Code:	Upchg:	Description:
UST	\$59	Ultra Seat Topper in fabric or leather
UKST	\$59	Ultra Knitted Seat Topper

**Perforated Leather Option:**  
For perforated patterns in leather seat and/or back toppers, insert PERF() after ST() and/or BT() in pattern number. Seat topper upcharge is \$105. Back topper upcharge is \$220. See Spinneybeck Leather Application section for pattern codes.

**COM/COL Textile Requirements**

**Seat Topper:**  
0.7 yards fabric  
9.0 sq ft leather

**Back Topper:**  
1.3 yards fabric  
16.0 sq ft leather





**CAL 133 Options:**

To meet Cal 133 requirements, Life must have seat topper or seat and back toppers with approved FR upholstery. Not compliant with KST. See textile matrix at the beginning of the price list for pre-approved Cal 133 textiles. # = Cal 133 pre-approved.

Insert C after ST() option. See below for upcharges.

Code:	Upchg:	Description:
C	\$81	CAL 133 fabric seat topper
C	\$277	CAL 133 fabric seat and back toppers
C	\$159	CAL 133 leather seat topper <b>Minimum order of 3 chairs required</b>
C	\$390	CAL 133 leather seat and back toppers No minimum order required

Life®  
aluminum base, seat topper and back topper

	arm	description	pattern no. *
<b>Designer(s):</b> Formway Design Studio, 2002  <b>Award(s):</b> Good Design Award, Chicago Athenaeum, 2003, USA NeoCon Gold, Best of NeoCon, Task Chair - Seating Design, June 2002, USA IIDEX/NeoCon, Sustainable Design Gold Award, 2002, Canada	Armless 	Aluminum base, fabric or leather seat and back topper	<b>55C-3-(3 or 4)-A-5-K-GH BSF( )-ST( )-BT( )</b>
	Fixed Plastic 	Aluminum base, fabric and leather seat and back topper	<b>55A-3-(3 or 4)-A-5-K-GH BSF( )-ST( )-BT( )</b>
	Fixed Aluminum 	Aluminum base, fabric and leather seat and back topper	<b>55M-3-(3 or 4)-A-5-K-GH BSF( )-ST( )-BT( )</b>
	Height Adj. 	Aluminum base, fabric and leather seat and back topper	<b>55H-3-(3 or 4)-A-5-K-GH BSF( )-ST( )-BT( )</b>
	High Perf. 	Aluminum base, fabric and leather seat and back topper	<b>55P-3-(3 or 4)-A-5-K-GH BSF( )-ST( )-BT( )</b>

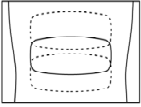

\*For specification directions, please see page 62.  
For upholstery selections and pricing see facing page.

Order Code	Ordering Information	Options
<b>Example:</b> 55H-3-6-A5K-GH-BSF33-ST-K1206/9-NB <b>55</b> Life chair <b>H</b> Height adjustable arms <b>3</b> High back <b>6</b> Grey base and grey levers <b>A</b> Advanced control with sliding seat <b>5</b> Standard height cylinder <b>K</b> No lumbar <b>GH</b> Grey hard caster <b>BSF33</b> Plum Back Suspension Fabric <b>ST-K1206/9</b> Knoll Hopsack, Magenta seat topper <b>NB</b> No back topper	<b>Specify:</b> 1. Pattern number with back suspension fabric BSF( ). 2. Seat topper textile, either KST( ) for knitted seat topper or ST( ) for fabric or leather. NS for no seat topper. 3. Back topper textile, BT( ) for fabric or leather. NB for no back topper.  <b>Options</b>  <b>Armpad Options:</b> For leather armpads, add J after the arm pattern code (Example: 55PJ) and specify leather. Available in Spinneybeck Volo (Grade U) and Sabrina (Grade W) leathers.  <b>Code: Upchg: Description:</b> J \$258 Spinneybeck Volo J \$347 Spinneybeck Sabrina  <b>Base Options:</b>  <b>Code: Upchg: Description:</b> 3 n/c painted matte aluminum base 4 n/c polished aluminum base	<b>Cylinder Height Options:</b> For height ranges see Life Dimensions and Operating Instructions. Replace 5 in pattern with one of the following options:  <b>Code: Upchg: Description:</b> L n/c low cylinder H n/c high cylinder  <b>Lumbar Options:</b> For lumbar, replace K with L( ) in the pattern number. Specify color code in the parentheses after L.  <b>Code: Upchg: Description:</b> L(K1029/13) \$98 Vibe, Glam L(K1029/14) \$98 Vibe, Poise L(K1029/BLK) \$98 Vibe, Black  <b>Lumbar detail</b> 

**Caster Options:**  
Replace GH in pattern with one of the following options:  
  
**Code: Upchg: Description:**  
 BH n/c hard black caster  
 BR \$42 soft black caster  
 GR \$42 soft grey caster  
 CH \$25 hard clear caster  
 CR \$67 soft clear caster

**Glides:**  
Replace GH in pattern with GG. No upcharge for this option.

**Glide detail**



KST or COM	A	B	C	D	E	F	G	H	I	T	COL U	V	W	X	Y
\$1,507.	\$1,594.	\$1,626.	\$1,682.	\$1,741.	\$1,785.	\$1,815.	\$1,933.	\$1,958.	\$1,996.	\$2,295.	\$2,413.	\$2,533.	\$2,996.	\$3,022.	\$3,153.
1,668.	1,755.	1,787.	1,843.	1,902.	1,946.	1,976.	2,094.	2,119.	2,157.	2,456.	2,574.	2,694.	3,157.	3,183.	3,314.
1,718.	1,805.	1,837.	1,893.	1,952.	1,996.	2,026.	2,144.	2,169.	2,207.	2,506.	2,624.	2,744.	3,207.	3,233.	3,364.
1,722.	1,809.	1,841.	1,897.	1,956.	2,000.	2,030.	2,148.	2,173.	2,211.	2,510.	2,628.	2,748.	3,211.	3,237.	3,368.
1,804.	1,891.	1,923.	1,979.	2,038.	2,082.	2,112.	2,230.	2,255.	2,293.	2,592.	2,710.	2,830.	3,293.	3,319.	3,450.

**Back Suspension Fabric - Standard**

Code:	Description:
BSF 15	Eclipse
BSF 17	Blackout
BSF 19	Beige
BSF 22	Grain
BSF 31	Navy
BSF 32	Rouge
BSF 33	Plum
BSF 34	Sunset
BSF 35	Avocado
BSF 37	Bronze
BSF 38	Chestnut
BSF 39	Platinum
BSF 40	Charcoal
BSF 41	Frost

**Knitted Seat Topper - Base Grade**

Code:	Description:
KST 15	Eclipse/Blackout
KST 18	Camel
KST 19	Beige
KST 31	Dark Blue
KST 32	Scarlet
KST 33	Grape
KST 36	Olive
KST 38	Dark Brown
KST 40	Dark Grey

For no seat topper (NS), subtract \$51 from KST base grade list price.

Ordering Samples/Viewing online:  
To view BSF and KST colors see Surface Finish Library on knoll.com. Physical samples are the best representation of color. To order samples, contact a Knoll sales representative or Knoll dealer.

**Textile Options**

Please refer to the matrices at the beginning of the price list for approved Knoll Textiles fabrics and Spinneybeck leathers for seat and back toppers.

**Ultra Seat Topper Options:**

For ultra seat topper, which is 1/2" thicker foam than standard seat topper, add U before the seat topper pattern code.

Code:	Upchg:	Description:
UST	\$59	Ultra Seat Topper in fabric or leather
UKST	\$59	Ultra Knitted Seat Topper

**Perforated Leather Option:**

For perforated patterns in leather seat and/or back toppers, insert PERF() after ST() and/or BT() in pattern number. Seat topper upcharge is \$105. Back topper upcharge is \$220. See Spinneybeck Leather Application section for pattern codes.

**COM/COL Textile Requirements**

**Seat Topper:**  
0.7 yards fabric  
9.0 sq ft leather

**Back Topper:**  
1.3 yards fabric  
16.0 sq ft leather

**CAL 133 Options:**

To meet Cal 133 requirements, Life must have seat topper or seat and back toppers with approved FR upholstery. Not compliant with KST. See textile matrix at the beginning of the price list for pre-approved Cal 133 textiles. \* = Cal 133 pre-approved.

Insert C after ST() option. See below for upcharges.

Code:	Upchg:	Description:
C	\$81	CAL 133 fabric seat topper
C	\$277	CAL 133 fabric seat and back toppers
C	\$159	CAL 133 leather seat topper
C	\$390	CAL 133 leather seat and back toppers

**Minimum order of 3 chairs required**  
No minimum order required

Life®  
replacement parts

	description	pattern no. *
<i>Designer(s):</i> Formway Design Studio, 2002  <i>Award(s):</i> Good Design Award, Chicago Athenaeum, 2003, USA NeoCon Gold, Best of NeoCon, Task Chair - Seating Design, June 2002, USA IINDEX/NeoCon, Sustainable Design Gold Award, 2002, Canada	Replacement KST or leather seat topper upholstery	<b>55SEATTOPPER</b>
	Replacement fabric seat topper	<b>55FABRICTOPPER</b>
	Replacement fabric or leather back topper	<b>55BACKTOPPER</b>
	Replacement lumbar	<b>55LUMBAR</b>



\*For upholstery selections and pricing see facing page.

Order Code	Ordering Information	Options
<i>Example:</i> <b>55FABRICTOPPER-ST-K1206/9</b>	<i>Specify:</i>	<i>Lumbar Options:</i>
<b>55</b> Life chair	1. Pattern number	For lumbar, specify color code in the parentheses after L.
<b>FABRIC TOPPER</b> Replacement fabric seat topper	2. Textile	<i>Code: Upchg: Description:</i>
<b>ST</b> Seat topper		K1029/13 \$98 Vibe, Glam
<b>K1206/9</b> Knoll Hopsack, Magenta		K1029/14 \$98 Vibe, Poise
		K1029/BLK \$98 Vibe, Black

Lumbar detail

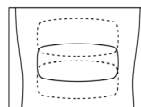

KST or COM	A	B	C	D	E	F	G	H	I	T	COL U	V	W	X	Y
\$51.										\$447.	\$477.	\$540.	\$689.	\$704.	\$791.
51.	102.	108.	133.	157.	174.	199.	211.	230.	255.						
210.	246.	272.	303.	338.	365.	370.	476.	482.	495.	602.	690.	747.	1,061.	1,072.	1,116.
98.															

**Knitted Seat Topper - Base Grade**

<i>Code:</i>	<i>Description:</i>
KST 15	Eclipse/Blackout
KST 18	Camel
KST 19	Beige
KST 31	Dark Blue
KST 32	Scarlet
KST 33	Grape
KST 36	Olive
KST 38	Dark Brown
KST 40	Dark Grey

Ordering Samples/Viewing online:  
To view BSF and KST colors see Surface Finish Library on knoll.com. Physical samples are the best representation of color. To order samples, contact a Knoll sales representative or Knoll dealer.

**Textile Options**

Please refer to the matrices at the beginning of the price list for approved Knoll Textiles fabrics and Spinneybeck leathers for seat and back toppers.

*Ultra Seat Topper Options:*  
For ultra seat topper, which is 1/2" thicker foam than standard seat topper, add U before the seat topper pattern code.

<i>Code:</i>	<i>Upchg:</i>	<i>Description:</i>
UST	\$59	Ultra Seat Topper in fabric or leather
UKST	\$59	Ultra Knitted Seat Topper

*Perforated Leather Option:*  
For perforated patterns in leather seat and/or back toppers, insert PERF() after ST() and/or BT() in pattern number. Seat topper upcharge is \$105. Back topper upcharge is \$220. See Spinneybeck Leather Application section for pattern codes.

**COM/COL Textile Requirements**

*Seat Topper:*  
0.7 yards fabric  
9.0 sq ft leather

*Back Topper:*  
1.3 yards fabric  
16.0 sq ft leather

**CAL 133 Options:**

To meet Cal 133 requirements, Life must have seat topper or seat and back toppers with approved FR upholstery. Not compliant with KST. See textile matrix at the beginning of the price list for pre-approved Cal 133 textiles. \* = Cal 133 pre-approved.

Insert C after ST() option. See below for upcharges.

<i>Code:</i>	<i>Upchg:</i>	<i>Description:</i>
C	\$81	CAL 133 fabric seat topper
C	\$277	CAL 133 fabric seat and back toppers
C	\$159	CAL 133 leather seat topper
C	\$390	CAL 133 leather seat and back toppers

**Minimum order of 3 chairs required**  
No minimum order required

## How to Specify a Life Chair

<b>Step 1</b>																							
<b>Basic Pattern Number</b>																							
Select a Chair Type (including arm, base, cylinder, lumbar and caster type)																							
	Arm					Base				Cylinder	Lumbar	Caster											
Life Chair	Height Adjustable Arms	High Performance Arms	Fixed Plastic Arms	Fixed Aluminum Arms	Armless	Leather Armpads	High Back	Grey Plastic Base & Levers	Polished Aluminum Base & Levers	Painted Matte Aluminum Base & Levers	Black Plastic Base & Levers	Advanced Control with Sliding Seat	Medium Height Cylinder	Low Height Cylinder	High Height Cylinder	Height Adjustable Lumbar, Color #	No Lumbar	Grey Hard Caster	Grey Soft Caster	Clear Hard Caster	Clear Soft Caster	Black Hard Caster	Black Soft Caster
<b>55</b>	<b>H</b>	<b>P</b>	<b>A</b>	<b>M</b>	<b>C</b>	<b>J</b>	<b>3</b>	<b>6</b>	<b>4</b>	<b>3</b>	<b>2</b>	<b>A</b>	<b>5</b>	<b>L</b>	<b>H</b>	<b>L</b>	<b>K</b>	<b>GH</b>	<b>GR</b>	<b>CH</b>	<b>CR</b>	<b>BH</b>	<b>BR</b>

The basic pattern numbers are configured for you in the price list.

### EXAMPLES:

**55PJ-3-6-A5L-K1029-13-GH-BSF17-ST-K451/4-BT-K451/4**

*(Life with plastic base and upholstered seat and back toppers)*

Life / High Performance Arm / Leather Armpads / Grey Base /  
Height Adjustable Lumbar, Vibe K1029-13 Glam / Grey Hard Caster /  
Life Back Suspension Fabric-Blackout / Seat Topper Fabric-Una, Ebony /  
Back Topper Fabric-Una, Ebony

**55H-3-4-A5K-CH-BSF22-KST19-NB**

*(Life with aluminum base and knitted seat topper, no back topper)*

Life / Height Adjustable Arms / Polished Aluminum Base / No Lumbar /  
Clear Hard Caster / Life Back Suspension Fabric-Grain /  
Life Knitted Seat Topper / No Back Topper

Step 2		Step 3		Step 4	
	Select Back Suspension Fabric color	Select No Seat Topper	or Select Seat Topper and Upholstery Choice	Select No Back Topper	or Select Back Topper and Upholstery Choice
	Life Back Suspension Fabric	No Seat Topper (-\$51 from base grade list price)	Seat Topper and Upholstery Number Life Knitted Seat Toppers are base grade. Additional options include all approved KnollTextiles fabrics, Spinneybeck leathers, COM or COL	No Back Topper	Back Topper and Upholstery Code Options include all approved KnollTextiles fabrics, Spinneybeck leathers, COM or COL
	<b>BSF(15-41)</b>	<b>NS</b>	Life Knitted Seat Topper <b>KST(15-40)</b> <i>(base grade)</i> or <b>UKST(15-40)</b> <i>(optional Ultra Knitted Seat Topper)</i> or <b>ST-(KnollTextiles or Spinneybeck Upholstery Code*)</b> <i>(optional fabric or leather seat topper)</i> or <b>UST-(Upholstery Code*)</b> <i>(optional fabric or leather Ultra Seat Topper)</i> or <b>COM or COL</b>	<b>NB</b>	No base grade available  or <b>BT-(KnollTextiles or Spinneybeck Upholstery Code*)</b> <i>(optional fabric or leather back topper)</i>  or <b>COM or COL</b>

\* Please refer to the matrices at the beginning of the price list for approved fabrics and leathers.



### Back Suspension Fabric with No Seat Topper

Life Back Suspension Fabric (BSF) is required for every chair and comes in 14 updated colors including warm and cool neutrals and vibrant, saturated colors.



### Back Suspension Fabric with Upholstered Seat Topper

You may choose to add a seat topper. In addition to a wide range of approved KnollTextiles fabrics and Spinneybeck leathers, an exclusive Life Knitted Seat Topper (KST) is available in a palette to match the Life BSF. Life KST is base grade and included in the basic model pricing.



### Back Suspension Fabric with Upholstered Seat and Back Toppers

Change the look of Life by adding an upholstered back topper. A wide range of approved KnollTextiles fabrics and Spinneybeck leathers are available as back toppers. Life KST is not available as a back topper. There is no base grade back topper.

To view fabrics online, refer to the Knoll Surface Finish Library on [knoll.com](http://knoll.com) (go to the top menu bar and click on “Resources” and click on “Surface Finish Library”).

## Construction

### COM/COL Approval Procedure

Prior to order placement a sample\* of the actual COM/COL must be submitted to Knoll East Greenville, with completed Knoll COM/COL Approval Request Form. Even after such preliminary approval, Knoll reserves the right to reject COM, including, if necessary, the item intended for use with COM, if Knoll considers the customer-supplied material inadequate for any reason. When specifying suede and shrunken cowhide, add 10% to the square footage requirement. When specifying calfskin, add 15% to the square footage requirement. COM is graded at Life KST base grade and COL is grade U.

\*Sample Requirement: 8" x 8" minimum memo sample if solid; if COM has a repeat, the sample must be large enough to show the repeat.

Call Customer Service at 800-343-5665 to obtain a copy of the COM/COL Approval Request Form.

### Cleaning Note:

Life BSF is cleaning code W, meaning water-based cleaning agents or foam may be used.

Life KST is cleaning code W-S, meaning water-based cleaning agents and foam or mild water-free solvents may be used.

See KnollTextiles Price List for further details on cleaning codes.

### Back:

Glass filled nylon frame. Polyester multi-filament yarn with co-polymer polyester elastomeric knit back suspension fabric.

### Upholstery toppers:

MDI polyurethane foam material  
 3/4" foam - back thickness  
 1 3/4" foam - seat thickness  
 2 1/4" foam - ultra seat thickness

### Flexing Seatpad:

Glass filled nylon seat structure.

### Fixed Plastic Arms:

Grey plastic armpost with soft integrally colored thermoplastic urethane pad and glass filled nylon foam insert.

### Fixed Aluminum Arms:

Aluminum armpost with soft integrally colored thermoplastic urethane pad and glass filled nylon foam insert.

### Height Adjustable and High Performance Arms:

Aluminum armpost with soft integrally colored thermoplastic urethane pad and glass filled nylon foam insert.

### Black and Grey Plastic Base:

Glass filled nylon.

### Polished and painted matte aluminum base:

Aluminum

### Optional Lumbar:

Slow recovery urethane foam with KnollTextiles vibe fabric cover. Attaches with neodymium magnets in TPU back frame.

### Casters:

Nylon 6 hard caster.  
 Nylon 6 soft caster with urethane overmolding.



**Visual impression and scale:**

Doesn't dominate the look of the work environment, it complements it. Translucent back, sculpted mechanism and thin profile integrate Life into the landscape. Generous scale and features accommodate all size users.

**Synchronized recline with auto-balanced tension:**

Utilizes user's body weight for resistance and recline. Allows for constant sightline — no need to refocus. Promotes movement and balance. Preference control accommodates a wider range of users.

**Dynamic seat pan with forward flex:**

Unique cut-out pattern with ribbed understructure provides dynamic movement and structural stability. Cradles and accommodates ischials (sit bones) without pressure points. Automatic flex responds to user's every move. Flex front automatically supports perching and enables a balanced posture. Flex front includes waterfall edge (gradual radius at the front edge that does not cause pressure under the knee). Ribs prevent "hammocking" or sagging and allow for easier movement.

**Back flex:**

The back frame is also a flexible plane like the seat that moves with you as you recline in the chair.

**Life Back Suspension Fabric (BSF):**

Exclusive elastomeric knit has built in lumbar support and is available in 14 color options. Has a soft feel that is not harsh to skin or clothing.

**Arms:**

Soft armpads alleviate pressure points. Types available: fixed, height adjustable, high performance (includes height adjustment and armpad positioning). Retrofittable or changeable.

**High performance arms:**

One-hand operation. Armposts are set toward the rear of the seat for a better fit. Soft armpads float in an orbital motion with locked stops. A great deal of adjustment in a surprisingly slim package.

**Optional lumbar attachment:**

Made of slow recovery foam, it magnetically attaches anywhere on the Life Back Suspension Fabric (BSF), and is covered in Vibe by KnollTextiles.

**Low profile base and casters:**

Feet can rest on the base comfortably. Low profile enables easier foot movement. Caster ribs absorb energy, flex and spread the static load for easier rolling.

**Controls:**

Adjustable from the seated position. Easy, obvious and labeled. Automated where possible.

**Environmental:****SMaRT<sup>®</sup> Sustainable Gold certified.**

Life was the first product in the industry to be SMaRT<sup>®</sup> certified. SMaRT<sup>®</sup> Consensus Sustainable Product Standard is a comprehensive, transparent, sustainable product standard that measures a product's environmental, economic and social benefits over its life and throughout its global supply chain, from raw materials through reclamation or re-use. Life can contribute to achieving a LEED<sup>®</sup> Innovation in Design Credit.

**GREENGUARD<sup>®</sup> certified.**

Life is GREENGUARD Indoor Air Quality<sup>®</sup> and GREENGUARD for Children & Schools<sup>SM</sup> certified and can contribute to achieving LEED<sup>®</sup> credits.

**Durability:**

10 year, 24-hour, 7 days a week, multi-shift warranty, including Life Back Suspension Fabric. See details in the Selling Policy at the end of the Price List.

**Life Awards:**

Good Design Award, Chicago Athenaeum, 2003, USA  
NeoCon Gold, Best of NeoCon, Task Chair - Seating Design, June 2002, USA  
IINDEX/NeoCon, Sustainable Design Gold Award, 2002, Canada  
IINDEX/NeoCon, Seating Desk, Workstation Chair Gold Award, 2002, Canada  
FX Awards, Seating Product of the Year, 2002, UK  
FX Awards, Overall Interior Product of the Year, 2002, UK

# Life® Dimensions and Operating Instructions

	<b>BIFMA G1-2002 Ergonomic Guidelines</b>	<b>Life Ergonomic Dimensions</b>		
<b>Seat*</b>				
		Standard Cylinder	Low Cylinder	High Cylinder
Seat Height	15" - 19.9" minimum range (one or combination of chairs)	15.25" - 20.5" (no seat topper) 15.75" - 21" (seat topper) 16" - 21.25" (ultra seat topper)	14.25" - 18" (no ST) 14.75" - 18.5" (ST) 15" - 18.75" (UST)	17" - 22" (no ST) 17.5" - 22.5" (ST) 17.75" - 22.75" (UST)
Seat Depth (Adjustable)	Include 16.9" or less in range	15" - 19"		
Seat Width	18" minimum	18.75"		
Seat Pan Angle (Fixed)	In range of 0° - 4° rearward	4° rearward		

<b>Back*</b>				
Backrest Height	12.2" minimum	25"		
Backrest Width	14.2" minimum	18.25"		
Lumbar Support (Fixed)	In range of 5.9" - 9.8"	7.5"		
Lumbar Support (Adjustable)	Include part of 5.9" - 9.8" range	Exceeds 5.5" - 9.8" (optional lumbar)		
Angle Between Seat and Back	≥90°, include 10° movement in 90° - 115° range	95° - 119°		
Tilt Range of Back	10° minimum	24°		

<b>Arms*</b>				
		Seat Topper	No Seat Topper	Ultra Seat Topper
Armrest Height (Fixed)	In range of 7.9" - 9.8"	9.5" (fixed arm)	10.5" (fixed arm)	8.5" (fixed arm)
Armrest Height (Adjustable)	6.9" - 10.8" minimum range (single or multiple sets of arms)	6.8" - 10.8" (height adjustable) 6.8" - 10.8" (high performance)	7.8" - 11.8" (height adjustable) 7.8" - 11.8" (high performance)	5.8" - 9.8" (height adjustable) 5.8" - 9.8" (high performance)
Inside Distance Between Armrests (Fixed)	18" minimum	18.5" (fixed) 18.25" (height adjustable)		
Inside Distance Between Armrests (Adjustable)	Include 18" in range	17.25" - 19.75" (high performance)		

\* All measurements taken with BIFMA Chair Measuring Device using the Universal Measurement Procedure which has a measurement uncertainty of ± 5%

## Life Chair Measurements\*\*

A. Overall Height	38.5" - 43.75" (back topper adds 0.5")
B. Overall Width	26.5"
C. Overall Depth	24.5"
D. Arm Height from Floor	25" - 30" (fixed arm) 22" - 31.5" (height adjustable) 22" - 31.5" (high performance)
E. Base Diameter	26"
Weight	36.5 lbs. (plastic base, high performance arms, seat topper) 38 lbs. (aluminum base, high performance arms, seat topper)

\*\*Standard cylinder

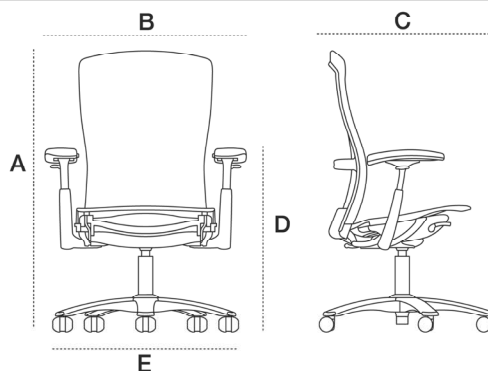

## Life - Additional Information

Synchronized recline ratio seat : back is 1° : 4.8°

High performance arms adjust 2.5" in armpad width (1.25" per side) and 3" armpad fore/aft movement

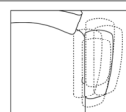

Optional lumbar measures 11.5" x 5.5"



Compliance: ANSI/BIFMA X5.1-2002, BIFMA G1-2002 Ergonomic Guidelines, CSA/CGSB 44.232-2002, DIN EN 1335-2002  
Cal 117, Cal 133 (with approved FR upholstery)

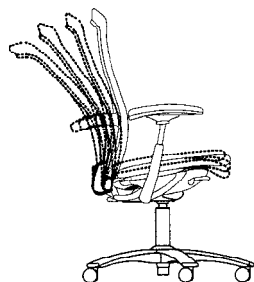

#### **Standard Features:**

##### **Synchronized recline with auto-balanced tension**

No need to adjust tension. Automatic recline tension counter-balances your body weight, resulting in perfect balance as you recline.

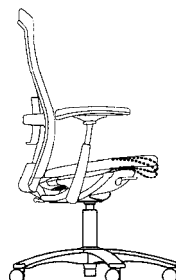

##### **Forward seat flex**

No knobs or levers needed. Lean forward or perch toward the edge of the seat and Life's seat pan automatically adjusts to support your position.

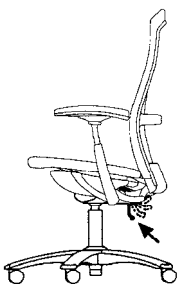

##### **Tension preference selector**

To perfect the tension adjust the preference lever located at the back left of the chair while in the upright position.

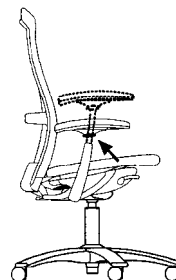

#### **Arm Options:**

**Fixed arms:**  
Non-adjustable.

##### **Height Adjustable Arms:**

Lift the lever on the outside of the armrest to adjust arm height.

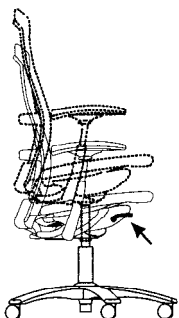

##### **Seat height adjustment**

To raise or lower the height, lift the lever on the right side of the chair and adjust to the proper height.

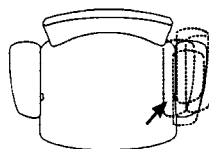

##### **High Performance Arms:**

Lift the lever on the outside of the armrest to adjust arm height.

The armrests adjust in an orbital motion and lock into a fixed position by pressing the button on the inside of the pad. The armrests can be positioned to the front or back and in width.

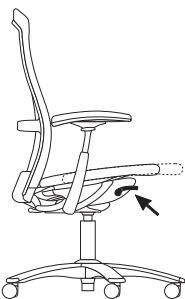

##### **Sliding seat depth adjustment**

Using the same lever as the seat height, push down to slide the seat within the 4" seat depth range. Release the lever to lock the seat into position.

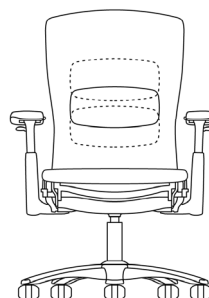

#### **Lumbar Options:**

##### **Height Adjustable Lumbar**

The lumbar support is held on to the chair with magnets for easy installation and a maximum range of adjustability.

To install the lumbar, separate the halves of the magnetic lumbar and place it in the desired position on your chair. Secure it by putting both halves back together around the back suspension fabric on the chair.

Adjust the lumbar by sliding the lumbar pad up and down the back of the chair.

Note: Product contains magnets. Consult the lumbar hangtag for more information.

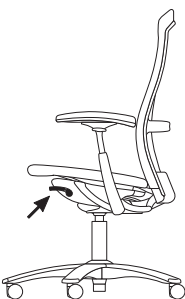





##### **Upright tilt lock**

To lock the seat in an upright position, push down the lever located on the left side of seat. Lift lever to unlock.

# Chadwick™

## *tilt stop control*

	pattern no.	description
Designer(s): Don Chadwick, 2005  	<b>33-NA-1-BK-T-S-X-HC</b>	Armless, tilt stop control Note: Arms cannot be added later
		
	<b>33-FA-1-BK-T-S-X-HC</b>	Fixed arms, tilt stop control
		
	<b>33-AA-1-BK-T-S-X-HC</b>	Height and width adjustable arms, tilt stop control. Note: A tall adjustable arm option is available. See below for details.
		

For Chadwick Fabric selections and pricing, see facing page.

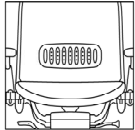
Order Code	Ordering Information	Options
<i>Example:</i> <b>33-AA-1-BK-T-S-X-HC-05</b>	<i>Specify:</i>	<i>Arm Option:</i>
<b>33</b> Chadwick Chair	1. Pattern number	For Tall Adjustable Arm, replace AA with TA in the pattern number. The tall arm is 1/4" higher than the standard adjustable arm. No upcharge for this option.
<b>AA</b> Adjustable Arms	2. Fabric color	<i>Cylinder Height Options:</i>
<b>1</b> Task Chair	<i>Finish color:</i>	For height ranges see Chadwick Dimensions and Operating Instructions. Replace S in pattern with one of the following options:
<b>BK</b> Black Frame	Black	<i>Code: Upchg: Description:</i>
<b>T</b> Tilt Stop Control		L n/c low cylinder
<b>S</b> Standard Cylinder		H n/c high cylinder
<b>X</b> No Lumbar		<i>Lumbar Option:</i>
<b>HC</b> Hard Black Caster		For lumbar, replace X with L in the pattern number. Add \$84 to list price
<b>05</b> Black Chadwick Fabric		<i>Note:</i>
		To order a lumbar separately, use pattern number 33LUMBAR. The list price is \$84.
		<i>Lumbar detail</i>
		
		

pattern no.	list
<b>33-NA-1-BK-T-S-X-HC #</b>	\$887.

<b>33-FA-1-BK-T-S-X-HC #</b>	956.
------------------------------	------

<b>33-AA-1-BK-T-S-X-HC #</b>	1,034.
------------------------------	--------

### Chadwick Fabric

#### Caster Option:

For soft casters, replace HC with SC in the pattern number, and add \$41 to the list price

#### Glides:

For glides, replace HC with GL in the pattern number. No upcharge for this option.

#### Glide detail



#### Black Monofilament:

Code:	Desc:	Upcharge:
01	Beige	n/c
02	Brown	n/c
03	Silver	n/c
04	Green	n/c
05	Black	n/c
06	Red	n/c
07	Blue	n/c

#### Silver Monofilament:





Code:	Desc:	Upcharge:
08	Jade	\$18
09	Platinum	\$18

#### Cal 133:

Chadwick is Cal 133 approved standard.  
No options or upcharge required.

# Chadwick™

## basic control

	pattern no.	description
<p><i>Designer(s):</i> Don Chadwick, 2005</p> 	<b>33-NA-1-BK-B-S-X-HC</b>	Armless, basic control Note: Arms cannot be added later.
		
	<b>33-FA-1-BK-B-S-X-HC</b>	Fixed arms, basic control
		
	<b>33-AA-1-BK-B-S-X-HC</b>	Height and width adjustable arms, basic control. Note: A tall adjustable arm option is available. See below for details.
		

For Chadwick Fabric selections and pricing, see facing page.

Order Code	Ordering Information	Options
<i>Example:</i> <b>33-AA-1-BK-B-S-X-HC-05</b>	<i>Specify:</i>	<i>Arm Option:</i>
<b>33</b> Chadwick Chair	1. Pattern number	For Tall Adjustable Arm, replace AA with TA in the pattern number. The tall arm is 1/4" higher than the standard adjustable arm. No upcharge for this option.
<b>AA</b> Adjustable Arms	2. Fabric color	
<b>1</b> Task Chair	<i>Finish color:</i>	<i>Tall Adjustable Arm detail</i>
<b>BK</b> Black Frame	Black	
<b>B</b> Basic Control		<i>Cylinder Height Options:</i>
<b>S</b> Standard Cylinder		For height ranges see Chadwick Dimensions and Operating Instructions. Replace S in pattern with one of the following options:
<b>X</b> No Lumbar		<i>Code: Upchg: Description:</i>
<b>HC</b> Hard Black Caster		L n/c low cylinder
<b>05</b> Black Chadwick Fabric		H n/c high cylinder

*Lumbar Option:*  
For lumbar, replace X with L in the pattern number. Add \$84 to list price

Note:  
To order a lumbar separately, use pattern number 33LUMBAR. The list price is \$84.

Lumbar detail

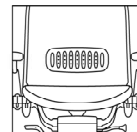

pattern no.	list
<b>33-NA-1-BK-B-S-X-HC#</b>	<b>\$833.</b>

<b>33-FA-1-BK-B-S-X-HC#</b>	<b>903.</b>
-----------------------------	-------------

<b>33-AA-1-BK-B-S-X-HC#</b>	<b>981.</b>
-----------------------------	-------------

**Chadwick Fabric**

*Caster Option:*  
For soft casters, replace HC with SC in the pattern number, and add \$41 to the list price

*Glides:*  
For glides, replace HC with GL in the pattern number. No upcharge for this option.

Glide detail



Black Monofilament:

Code:	Desc:	Upcharge:
01	Beige	n/c
02	Brown	n/c
03	Silver	n/c
04	Green	n/c
05	Black	n/c
06	Red	n/c
07	Blue	n/c

Silver Monofilament:

Code:	Desc:	Upcharge:
08	Jade	\$18
09	Platinum	\$18

*Cal 133:*  
Chadwick is Cal 133 approved standard.  
No options or upcharge required.

# Chadwick™

## high task chair

### tilt stop control

Designer(s):  
Don Chadwick, 2005



pattern no.                      description

**33-NA-2-BK-T-S-X-  
HC**                      Armless, tilt stop control  
Note: Arms cannot be added later



**33-FA-2-BK-T-S-X-  
HC**                      Fixed arms, tilt stop control



**33-AA-2-BK-T-S-X-  
HC**                      Height and width adjustable arms, tilt stop control. Note: A tall adjustable arm option is available. See below for details.



For Chadwick Fabric selections and pricing, see facing page.

Order Code	Ordering Information	Options
<i>Example:</i> <b>33-AA-2-BK-T-S-X-HC-05</b>	<i>Specify:</i>	<i>Arm Option:</i>
<b>33</b> Chadwick Chair	1. Pattern number	For Tall Adjustable Arm, replace AA with TA in the pattern number. The tall arm is 1/4" higher than the standard adjustable arm. No upcharge for this option.
<b>AA</b> Adjustable Arms	2. Fabric color	<i>Lumbar Option:</i>
<b>2</b> High Task Chair	<i>Finish color:</i>	For lumbar, replace X with L in the pattern number. Add \$84 to list price
<b>BK</b> Black Frame	Black	Note: To order a lumbar separately, use pattern number 33LUMBAR. The list price is \$84.
<b>T</b> Tilt Stop Control		
<b>S</b> Standard Cylinder		
<b>X</b> No Lumbar		
<b>HC</b> Hard Black Caster		
<b>05</b> Black Chadwick Fabric		

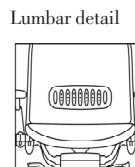



pattern no.	list
<b>33-NA-2-BK-T-S-X-HC#</b>	<b>\$1,102.</b>

<b>33-FA-2-BK-T-S-X-HC#</b>	<b>1,171.</b>
-----------------------------	---------------

<b>33-AA-2-BK-T-S-X-HC#</b>	<b>1,248.</b>
-----------------------------	---------------

### Chadwick Fabric

#### Caster Option:

For soft casters, replace HC with SC in the pattern number, and add \$41 to the list price

#### Glides:

For glides, replace HC with GL in the pattern number. No upcharge for this option.

#### Glide detail



#### Black Monofilament:

Code:	Desc:	Upcharge:
01	Beige	n/c
02	Brown	n/c
03	Silver	n/c
04	Green	n/c
05	Black	n/c
06	Red	n/c
07	Blue	n/c





#### Silver Monofilament:

Code:	Desc:	Upcharge:
08	Jade	\$18
09	Platinum	\$18

#### Cal 133:

Chadwick is Cal 133 approved standard.  
No options or upcharge required.

Chadwick™  
*high task chair*  
*basic control*

	pattern no.	description
 <p>Designer(s): Don Chadwick, 2005</p>	<b>33-NA-2-BK-B-S-X-HC</b>	Armless, basic control, pneumatic seat height Note: Arms cannot be added later
		
	<b>33-FA-2-BK-B-S-X-HC</b>	Fixed arms, basic control, pneumatic seat height
		
	<b>33-AA-2-BK-B-S-X-HC</b>	Height and width adjustable arms, basic control, pneumatic seat height. Note: A tall adjustable arm option is available. See below for details.
		

For Chadwick Fabric selections and pricing, see facing page.

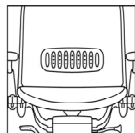
Order Code	Ordering Information	Options
<i>Example:</i> <b>33-AA-2-BK-T-S-X-HC-05</b>	<i>Specify:</i>	<i>Arm Option:</i>
<b>33</b> Chadwick Chair	1. Pattern number	For Tall Adjustable Arm, replace AA with TA in the pattern number. The tall arm is 1/4" higher than the standard adjustable arm. No upcharge for this option.
<b>AA</b> Adjustable Arms	2. Fabric color	
<b>2</b> High Task Chair	<i>Finish color:</i>	<i>Lumbar Option:</i>
<b>BK</b> Black Frame	Black	For lumbar, replace X with L in the pattern number. Add \$84 to list price.
<b>T</b> Tilt Stop Control		Note:
<b>S</b> Standard Cylinder		To order a lumbar separately, use pattern number 33LUMBAR. The list price is \$84.
<b>X</b> No Lumbar		
<b>HC</b> Hard Black Caster		
<b>05</b> Black Chadwick Fabric		
		Tall Adjustable Arm detail
		
		Lumbar detail
		

pattern no.	list
<b>33-NA-2-BK-B-S-X-HC#</b>	\$1,048.

<b>33-FA-2-BK-B-S-X-HC#</b>	1,118.
-----------------------------	--------

<b>33-AA-2-BK-B-S-X-HC#</b>	1,195.
-----------------------------	--------

**Chadwick Fabric**

*Caster Option:*  
For soft casters, replace HC with SC in the pattern number, and add \$41 to the list price

*Glides:*  
For glides, replace HC with GL in the pattern number. No upcharge for this option.

Glide detail



Black Monofilament:

Code:	Desc:	Upcharge:
01	Beige	n/c
02	Brown	n/c
03	Silver	n/c
04	Green	n/c
05	Black	n/c
06	Red	n/c
07	Blue	n/c

Silver Monofilament:

Code:	Desc:	Upcharge:
08	Jade	\$18
09	Platinum	\$18

*Cal 133:*  
Chadwick is Cal 133 approved standard.  
No options or upcharge required.

# Chadwick™

## Construction Information

### Features and Benefits



Standard Features	Benefits
Active Suspension™ Technology includes: 1. Responsive synchronized control and tilt tension	The synchronized control and tilt tension allow the user's torso to open up, promoting healthy circulation and creating a ride that is characterized by a cradled feeling that keeps the user's back in contact with the chair.
2. Resilient, breathable seat and back suspension fabric	Chadwick Fabric provides inherent, energizing support all day long, conforming to the user's shape and minimizing pressure points. The open weave provides aeration.
Forward Tilt: Mechanism automatically includes forward tilt movement	Chadwick offers automatic support for forward seated positions without requiring any additional adjustments.
Variable Seat Depth: Seat depth automatically expands while reclining in the chair	Fits a multitude of users comfortably, no additional adjustments required.
Generous Lumbar Curvature	Chadwick's ample lumbar curvature and conforming back suspension fabric eliminate the need for an additional lumbar mechanism or attachment.
Flexing Arm Pads on Fixed and Adjustable Arms	Suspended design and shape allows the arm pads to flex for additional softness to alleviate pressure points on the wrists.
2 Simple Adjustments: Tension and Seat Height	With so much responsive movement built in, Chadwick only needs two adjustments. They are obvious and simple to operate.

Optional Features	Benefits
Tilt Stop Control	Limits the recline in the upright position to 5 degrees.
Adjustable Arms or Tall Adjustable Arms: both include width adjustment	One finger, ratchet adjustment quickly and easily adjusts. Width adjustment can be accomplished with $\frac{5}{32}$ " Allen wrench.
Optional Lumbar	Magnetic for easy installation, the lumbar provides a maximum range of adjustability.

To view fabrics online, refer to the Knoll Surface Library at [knoll.com](http://knoll.com) (go to the menu bar and click on "Resources" and click on "Surface Finish Library").

#### Care:

Frequent vacuuming or light brushing to remove dust and grime is recommended. Spot clean, with a mild upholstery shampoo or the foam from a mild detergent. When using a cleaning product, follow instructions carefully and clean only in a well-ventilated room. Avoid any product that contains carbon tetrachloride or other toxic materials. With any method, pretest a small area before proceeding. Use a professional furniture cleaning service when an overall soiled conditioned has been reached, or call Knoll Field Service at 800-445-5045 with questions.

#### Cleaning code

**W** or **W-S**, meaning water-based cleaning agents and foam or mild, water-free solvents may be used. See KnollTextiles price List for further details on cleaning codes.

#### Healthcare Cleaning Agents:

Chadwick successfully passed third-party testing for the following five cleaning agents commonly used in healthcare facilities:

- Clorox Germicidal Liquid Bleach diluted 1:5 ratio to tap water (pH 3.7)
- Clorox Cleanup undiluted 100% solution (pH 9.7)
- Wexcide 128 Concentrate Phenolic Germicide by Wexford Labs diluted 1 ounce to 1 gallon tap water (pH 3.7)
- Formula 880 Quarternary Germicide by Grand Technologies diluted  $\frac{1}{2}$  ounce to 1 gallon tap water (pH 8.1)
- Hydroxi Pro concentrate 128 by Core Products diluted 1:8 ratio to tap water (pH 7.2)

#### Environmental:

##### SMaRT® Sustainable Gold certified.

SMaRT® Consensus Sustainable Product Standard is a comprehensive, transparent, sustainable product standard that measures a product's environmental, economic and social benefits over its life and throughout its global supply chain, from raw materials through reclamation or re-use. Chadwick can contribute to achieving a LEED® Innovation in Design Credit.

##### Cal 133 approved.

##### GREENGUARD® certified.

Chadwick is GREENGUARD Indoor Air Quality® and GREENGUARD for Children & Schools™ certified and can contribute to achieving LEED® credits.

#### Construction:

##### Back

##### Frame

Integrally-colored glass filled nylon

##### Chadwick Fabric

Polyester monofilament warp with multifilament fill fibers

##### Seat

##### Frame

Integrally-colored glass filled nylon

##### Chadwick Fabric

Polyester monofilament warp with multifilament fill fibers

##### Soft Edge

Polyurethane foam

---

**Arms***Fixed/Adjustable Arm Pads*

Urethane armpad with flexible spring steel insert

*Fixed/Adjustable Arm Supports*

Integrally-colored glass filled nylon

**Base & Casters***Base*

Integrally-colored glass filled nylon

*Casters and Glides*

Integrally-colored nylon

*Soft Casters*

Integrally-colored urethane covered nylon

**Cylinder**

Gas-activated steel seat height mechanism with steel tube (contains nitrogen)

**Control**

Control housing-aluminum casting and ABS top cover  
Component parts-steel, rubber and engineered plastics

**Optional Lumbar**

Neodymium magnets, polypropylene carrier, TPE pad and back frame

**Durability**

10 year, 24-hour, 7 days a week, multi-shift warranty including Chadwick Fabric. See details in the Selling Policy at the end of the Price List.

Chadwick Fabric exceeds 100,000 double rubs Wyzenbeek Method.

# Chadwick™ Dimensions and Operating Instructions

	BIFMA G1-2002 Ergonomic Guidelines	Chadwick Ergonomic Dimensions	
<b>Seat*</b>			
Seat Height	15" - 19.9" minimum range (one or combination of chairs)	Chadwick 15" - 19.1" (low cylinder) 15.9" - 20" (standard cylinder) 16.9" - 21.6" (high cylinder)	Chadwick High Task 23.25" - 30.75"
Seat Depth (Adjustable)	Include 16.9" or less in range	16.9" - 19.4" (range includes reclined position)	16.9" - 19.4" (range includes reclined position)
Seat Width	18" minimum	19.6"	19.6"
Seat Pan Angle (Adjustable)	Include part of 0° - +4° range	-5° - +7° (range includes forward and reclined positions)	-5° - +7° (range includes forward and reclined positions)
<b>Back*</b>			
Backrest Height	12.2" minimum	22.8"	22.8"
Backrest Width	14.2" minimum	18.5"	18.5"
Lumbar Support (Fixed)	In range of 5.9" - 9.8"	7"	7"
Lumbar Support (Adjustable)	Include part of 5.9" - 9.8" range	Exceeds 5.9" - 9.9" (optional lumbar)	Exceeds 5.9" - 9.9" (optional lumbar)
Angle Between Seat and Back	≥90°, include 10° movement in 90° - 115° range	94° - 120°	94° - 120°
Tilt Range of Back	10° minimum	26°	26°
<b>Arms*</b>			
Armrest Height (Fixed)	In range of 7.9" - 9.8"	8.5" (fixed arm)	8.5" (fixed arm)
Armrest Height (Adjustable)	6.9" - 10.8" minimum range (single or multiple sets of arms)	6.9" - 9.4" (adjustable) 8.3" - 10.8" (tall adjustable)	6.9" - 9.4" (adjustable) 8.3" - 10.8" (tall adjustable)
Inside Distance Between Armrests (Fixed)	18" minimum	19.5" (fixed)	19.5" (fixed)
Inside Distance Between Armrests (Adjustable)	Include 18" in range	18.5" - 20.5" (adjustable and tall adjustable)	18.5" - 20.5" (adjustable and tall adjustable)

\* All measurements taken with BIFMA Chair Measuring Device using the Universal Measurement Procedure which has a measurement uncertainty of ± 5%

## Chadwick Chair Measurements

	Chadwick**	Chadwick High Task
A. Overall Height	37.5" - 42"	44.5" - 52"
B. Overall Width	26.5"	26.5"
C. Overall Depth	25.5"	25.5"
D. Arm Height from Floor	25.5" - 30" (fixed arm) 24" - 31" (adjustable) 24.75" - 31.75" (tall adjustable)	32.5" - 40" (fixed arm) 31" - 41" (adjustable) 31.75" - 41.75" (adjustable)
E. Base Diameter	26.5"	26.5"
Weight	37 lbs. (with arms)	41 lbs. (with arms)

\*\*Standard cylinder

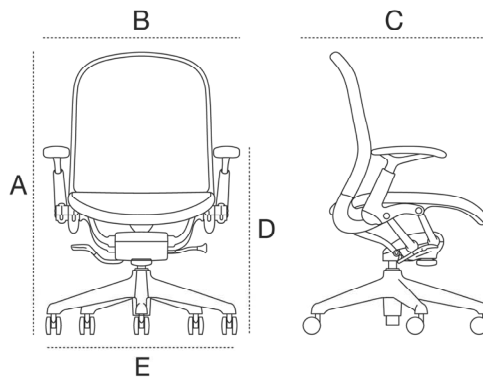

## Chadwick - Additional Information

Synchronized recline ratio seat : back is 1° : 1.2°

Adjustable and tall adjustable arms adjust 2" in armpad width (1" per side) with 5/32" Allen wrench

Optional lumbar measures 11.25" x 4.4"

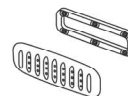

Chadwick High Task footring measures 19.875" in diameter

Chadwick High Task footring adjusts 5" in height by a single lever mechanism with 11 locking positions in 1/2" increments

Compliance: ANSI/BIFMA X5.1-2002, BIFMA G1-2002 Ergonomic Guidelines, Cal 117, Cal 133

## Chadwick Operating Instructions

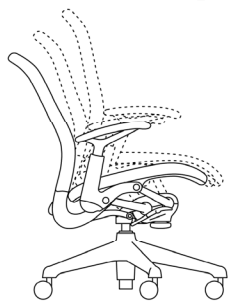

**Synchronized Recline with Tilt Tension**  
Chadwick has a synchronized recline that allows the torso to open up while reclining. To customize the tension of the recline, adjust the tension knob. To decrease the tension, turn the tension knob clockwise (while seated in the chair), and turn it counterclockwise to increase the tension. The underside of the knob also indicates the instructions with arrows.

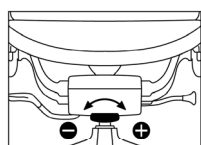

Front View

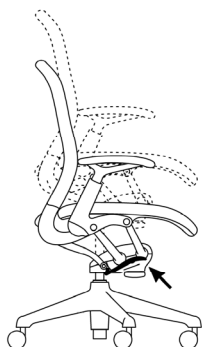

**Seat Height Adjustment**  
To raise the seat height, remove your weight from the chair while lifting the lever on the right side of the chair. To lower the seat height, lift the lever while sitting in the chair.

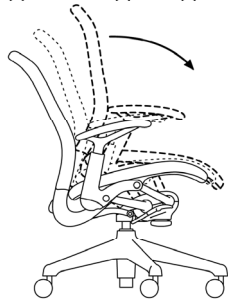

**Forward Tilt**  
Chadwick has a built-in forward tilt that automatically follows and supports the user in the forward posture for typing. No adjustment is required.

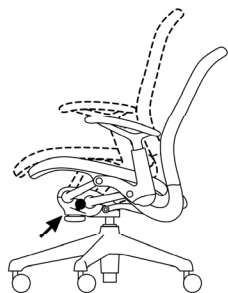

**Tilt Stop (Option)**  
The tilt stop is an upright tilt limiter. When specified, it is the lever on the left side of the chair. If your chair does not have a lever on the left side of the chair, it does not have this feature. The in-and-out lever design operates with an audible click, whereby “out” is engaged, “in” is not engaged.

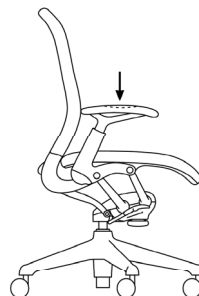

**Spring Loaded Arms**  
Both fixed and adjustable armrests have a spring suspension, which provides the user with armrest softness and flexibility.

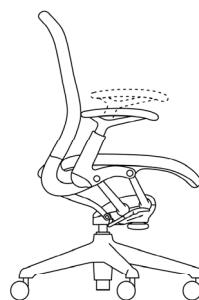

**Adjustable Arm Height (Option)**  
The arm height is adjusted by lifting the armrests upward. No lever is required. Simply move the arms up in five,  $\frac{1}{2}$ " increments for a total of  $2\frac{1}{2}$ ". To lower the arms, lift them to the highest point and at the highest point pull up firmly; and they will return to the lowest point. The arm height adjustment is easy to maneuver with one hand.

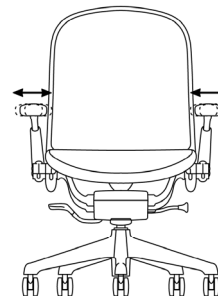

**Adjustable Arm Width (Option)**  
The armrests have a width adjustment of  $\frac{1}{2}$ " inward or  $\frac{1}{2}$ " outward for 1" in total adjustability on each side. A  $\frac{3}{32}$ " Allen wrench is required to adjust the armrest width.

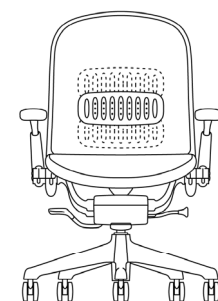





**Adjustable Lumbar (Option)**  
Chadwick has an adjustable lumbar support, if needed. It is secured to the chair with magnets for easy installation and a maximum range of adjustability.

Separate both halves of the lumbar support and place them in the desired position on your chair. Secure the support by putting both halves together around the back suspension fabric of the chair.

Adjust the lumbar by sliding the lumbar pad up and down the back of the chair.

Note: Contains magnets. Consult the Knoll lumbar support hangtag for more information.

# Bulldog® executive chair

	pattern no.	description *
<b>Designer(s):</b> Dale Fahnstrom and Michael McCoy, 1990  <b>Award(s):</b> Bulldog Chair Adjustable Arm - IBD Product Design Bronze Award, 1993; IDEA Bronze Annual Design Award, 1991; Outstanding Performance, Product Design Achievement Award, IBD Southern California Chapter, 1990; IFMA and Facilities Design&Management Gold Award, 1990; IBD Product Design Bronze Award, 1990	<b>7A3-1-A5G-H</b> 	<b>Armchair, Advanced control</b>  Synchronized tilt, 4" back height, forward tilt, tilt lock, variable position tilt stop, pneumatic seat height, 360 degree swivel, heavy duty spring
	<b>7C3-1-A5G-H</b> 	<b>Armless, Advanced control</b>  Synchronized tilt, 4" back height, forward tilt, tilt lock, variable position tilt stop, pneumatic seat height, 360 degree swivel, heavy duty spring
	<b>7A3-1-B5G-H</b> 	<b>Armchair, Basic control</b>  Synchronized tilt, 4" back height, tilt lock, variable position tilt stop, pneumatic seat height, 360 degree swivel, heavy duty spring
	<b>7C3-1-B5G-H</b> 	<b>Armless, Basic control</b>  Synchronized tilt, 4" back height, tilt lock, variable position tilt stop, pneumatic seat height, 360 degree swivel, heavy duty spring
	<b>7RS3</b>	seat reupholstery assembly
	<b>7RB3</b>	back reupholstery assembly
	<b>U</b>	upholstered outer back shell (insert U after 7A or 7C in pattern number)
	<b>C</b>	Cal 133 (add C after pattern number and add 133 after upholstery code). Not available on upholstered outer back chairs.

\* For additional information on controls, options and construction, see page 90

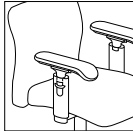
Order Code	Ordering Information	Options
<i>Example:</i> <b>7A3-1-B5G-H-K349/12</b>	<i>Specify:</i>	<i>Arm Option:</i>
<b>7A3</b> Bulldog executive armchair	1. Pattern number	For high performance arms with soft armpads, substitute 7P for 7A in pattern.
<b>1</b> dark grey finish	2. Upholstery selection	<i>Code: Upchg: Description:</i>
<b>B5G</b> Basic control	<i>Finish color:</i>	P \$250 High performance arms
<b>H</b> 2" dual, hooded hard-wheel casters	Dark Grey	High Performance Arm detail
<b>K349/12</b> Alignment, Harbor		
<i>Example for Cal 133:</i>		<i>Cylinder Height Options:</i>
<b>7A3-1-B5G-H-C-K349/12-133</b>		For height ranges see Bulldog Dimensions and Operating Instructions. Replace 5 in pattern with one of the following options:
		<i>Code: Upchg: Description:</i>
		L n/c low cylinder
		H n/c high cylinder
		<i>Sliding Seat Option:</i>
		Substitute K for G in pattern.
		<i>Code: Upchg: Description:</i>
		K \$118 Sliding seat
		<i>Caster and Glide Options:</i>
		Substitute H in pattern with one of the following:
		<i>Code: Upchg: Description:</i>
		R \$51 Soft casters for hard surfaces
		G n/c Glides



pattern no.	grades <b>A</b>	COM <b>B</b>	<b>C</b>	<b>D</b>	<b>E</b>	<b>F</b>	<b>G</b>	<b>H</b>	<b>I</b>	<b>T</b>	COL <b>U</b>	<b>V</b>	<b>W</b>	<b>X</b>	<b>Y</b>
<b>7A3-1-A5G-H</b>	\$1,608.	\$1,679.	\$1,748.	\$1,798.	\$1,846.	\$1,885.	\$1,931.	\$2,042.	\$2,247.	\$2,473.	\$2,577.	\$2,741.	\$3,278.	\$3,350.	\$3,378.
<b>7C3-1-A5G-H</b>	1,493.	1,562.	1,633.	1,683.	1,729.	1,769.	1,815.	1,924.	2,131.	2,356.	2,460.	2,623.	3,158.	3,232.	3,259.
<b>7A3-1-B5G-H</b>	1,500.	1,569.	1,638.	1,690.	1,734.	1,775.	1,821.	1,932.	2,136.	2,363.	2,468.	2,630.	3,165.	3,241.	3,263.
<b>7C3-1-B5G-H</b>	1,381.	1,451.	1,522.	1,573.	1,618.	1,658.	1,703.	1,816.	2,021.	2,245.	2,347.	2,511.	3,047.	3,121.	3,148.
<b>7RS3</b>	361.	389.	418.	438.	459.	475.	494.	540.	627.	1,069.	1,114.	1,193.	1,604.	1,750.	1,815.
<b>7RB3</b>	306.	333.	364.	383.	404.	421.	438.	487.	572.	1,001.	1,058.	1,137.	1,549.	1,693.	1,757.
<b>U</b>	197.	225.	251.	273.	289.	306.	326.	368.	449.	530.	530.	595.	792.	819.	831.
<b>C</b>	80.	80.	80.	80.	80.	80.	80.	80.	80.	111.	111.	111.	111.	111.	111.

### Upholstery Options

#### KnollTextiles Fabrics and Spinneybeck Leathers

Please refer to the textile matrices at the beginning of the price list for approved fabrics and leathers.

#### Split upholstery option:

Bulldog Executive Chair seats and backs can be upholstered in any two approved KnollTextiles or Spinneybeck upholsteries. To specify, first indicate the seat upholstery (labeled "seat upholstery") and then indicate the back upholstery (labeled "back upholstery"). The list price of the chair equals the list price of the higher of the two upholstery grades.





#### Cal 133:

‡ = Cal 133 upholstery available. See textile matrices at the beginning of the price list for pre-approved Cal 133 textiles. Not available on chairs with upholstered outer back.

#### COM/COL Textile Requirement

	<i>fabric</i> yds.	<i>leather</i> sq. ft.
chair	2.3	35
outer back shell	0.9	13

# Bulldog® management chair

	pattern no.	description *
<b>Designer(s):</b> Dale Fahnstrom and Michael McCoy  <b>Award(s):</b> Bulldog Chair Adjustable Arm - IBD Product Design Bronze Award, 1993; IDEA Bronze Annual Design Award, 1991; Outstanding Performance, Product Design Achievement Award, IBD Southern California Chapter, 1990; IFMA and Facilities Design&Management Gold Award, 1990; IBD Product Design Bronze Award, 1990	<b>7A1-1-A5G-H</b> 	Armchair, Advanced control  Synchronized tilt, 4" back height, forward tilt, tilt lock, variable position tilt stop, pneumatic seat height, 360 degree swivel.
	<b>7C1-1-A5G-H</b> 	Armless, Advanced control  Synchronized tilt, 4" back height, forward tilt, tilt lock, variable position tilt stop, pneumatic seat height, 360 degree swivel.
	<b>7A1-1-B5G-H</b> 	Armchair, Basic control  Synchronized tilt, 4" back height, tilt lock, variable position tilt stop, pneumatic seat height, 360 degree swivel.
	<b>7C1-1-B5G-H</b> 	Armless, Basic control  Synchronized tilt, 4" back height, tilt lock, variable position tilt stop, pneumatic seat height, 360 degree swivel.
	<b>7RS3</b> <b>7RB1</b> <b>U</b> <b>C</b>	seat reupholstery assembly back reupholstery assembly upholstered outer back shell (insert U after 7A or 7C in pattern number) Cal 133 (add C after pattern number and add 133 after upholstery code) Not available on upholstered outer back chairs.

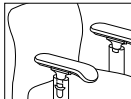

\* For additional information on controls, options and construction, see page 90

Order Code	Ordering Information	Options
<b>Example:</b> <b>7A1-1-B5G-H-K349/12</b> <b>7A1</b> Bulldog management armchair <b>1</b> dark grey finish <b>B5G</b> Basic control <b>H</b> 2" dual, hooded hard-wheel casters <b>K349/12</b> Alignment, Harbor  <b>Example for Cal 133:</b> <b>7A1-1-B5G-H-C-K349/12-133</b>	<b>Specify:</b> 1. Pattern number 2. Upholstery selection  <b>Finish color:</b> Dark Grey	<b>Arm Option:</b> For high performance arms with soft armpads, substitute 7P for 7A in pattern.  <b>Code: Upchg: Description:</b> P \$250 High performance arms  High Performance Arm detail 

**Cylinder Height Options:**  
 For height ranges see Bulldog Dimensions and Operating Instructions. Replace 5 in pattern with one of the following options:  
**Code: Upchg: Description:**  
 L n/c low cylinder  
 H n/c high cylinder

arm height/width, pad rotation/slide

pattern no.	grades		COM												
	A	B	C	D	E	F	G	H	I	T	U	V	W	X	Y
<b>7A1-1-A5G-H</b>	\$1,348.	\$1,404.	\$1,460.	\$1,499.	\$1,535.	\$1,566.	\$1,601.	\$1,689.	\$1,850.	\$2,132.	\$2,223.	\$2,367.	\$2,843.	\$2,909.	\$2,932.
<b>7C1-1-A5G-H</b>	1,232.	1,287.	1,342.	1,380.	1,418.	1,448.	1,483.	1,572.	1,733.	2,013.	2,104.	2,249.	2,727.	2,790.	2,813.
<b>7A1-1-B5G-H</b>	1,237.	1,292.	1,348.	1,386.	1,423.	1,454.	1,492.	1,576.	1,740.	2,020.	2,110.	2,256.	2,732.	2,796.	2,821.
<b>7C1-1-B5G-H</b>	1,121.	1,176.	1,232.	1,270.	1,308.	1,338.	1,375.	1,461.	1,624.	1,902.	1,993.	2,137.	2,612.	2,678.	2,701.
<b>7RS3</b>	361.	389.	418.	438.	459.	475.	494.	540.	627.	1,069.	1,114.	1,193.	1,604.	1,750.	1,815.
<b>7RB1</b>	264.	292.	321.	341.	364.	379.	397.	444.	531.	971.	1,016.	1,095.	1,508.	1,654.	1,715.
<b>U</b>	133.	156.	175.	192.	203.	219.	230.	265.	327.	426.	426.	478.	645.	669.	679.
<b>C</b>	80.	80.	80.	80.	80.	80.	80.	80.	80.	111.	111.	111.	111.	111.	111.

### Upholstery Options

**Heavy Duty Spring Option:**  
Insert HD after A or B in pattern.

**Code: Upchg: Description:**  
HD \$13 Heavy duty spring

**Sliding Seat Option:**  
Substitute K for G in pattern.

**Code: Upchg: Description:**  
K \$118 Sliding seat

**Caster and Glide Options:**  
Substitute H in pattern with one of the following:

**Code: Upchg: Description:**  
R \$51 Soft casters for hard surfaces  
G n/c Glides

**KnollTextiles Fabrics and Spinneybeck Leathers**  
Please refer to the textile matrices at the beginning of the price list for approved fabrics and leathers.





**Split upholstery option:**  
Bulldog Executive Chair seats and backs can be upholstered in any two approved KnollTextiles or Spinneybeck upholsteries. To specify, first indicate the seat upholstery (labeled "seat upholstery") and then indicate the back upholstery (labeled "back upholstery"). The list price of the chair equals the list price of the higher of the two upholstery grades.

**Cal 133:**  
♣ = Cal 133 upholstery available. See textile matrices at the beginning of the price list for pre-approved Cal 133 textiles. Not available on chairs with upholstered outer back.

#### COM/COL Textile Requirement

	fabric yds.	leather sq. ft.
chair	1.8	31
outer back shell	0.7	11

# Bulldog® operational chair

	pattern no.	description *
<b>Designer(s):</b> Dale Fahnstrom and Michael McCoy  <b>Award(s):</b> Bulldog Chair Adjustable Arm - IBD Product Design Bronze Award, 1993; IDEA Bronze Annual Design Award, 1991; Outstanding Performance, Product Design Achievement Award, IBD Southern California Chapter, 1990; IFMA and Facilities Design&Management Gold Award, 1990; IBD Product Design Bronze Award, 1990	<b>7A4-1-A5G-H</b> 	Armchair, Advanced control  Synchronized tilt, 4" back height, forward tilt, tilt lock, variable position tilt stop, pneumatic seat height, 360 degree swivel.
	<b>7C4-1-A5G-H</b> 	Armless, Advanced control  Synchronized tilt, 4" back height, forward tilt, tilt lock, variable position tilt stop, pneumatic seat height, 360 degree swivel.
	<b>7A4-1-B5G-H</b> 	Armchair, Basic control  Synchronized tilt, 4" back height, tilt lock, variable position tilt stop, pneumatic seat height, 360 degree swivel.
	<b>7C4-1-B5G-H</b> 	Armless, Basic control  Synchronized tilt, 4" back height, tilt lock, variable position tilt stop, pneumatic seat height, 360 degree swivel.
	<b>7RS2</b> <b>7RB4</b> <b>U</b> <b>C</b>	seat reupholstery assembly back reupholstery assembly upholstered outer back shell (insert U after 7A or 7C in pattern number) Cal 133 (add C after pattern number and add 133 after upholstery code) Not available on upholstered outer back chairs.



\* For additional information on controls, options and construction, see page 90

Order Code	Ordering Information	Options
<b>Example:</b> <b>7A4-1-A5G-H-K349/12</b> <b>7A4</b> Bulldog operational armchair <b>1</b> dark grey finish <b>A5G</b> Advanced control <b>H</b> 2" dual, hooded hard-wheel casters <b>K349/12</b> Alignment, Harbor  <b>Example for Cal 133:</b> <b>7A4-1-A5G-H-C-K349/12-133</b>	<b>Specify:</b> 1. Pattern number 2. Upholstery selection  <b>Finish color:</b> Dark Grey	<b>Arm Option:</b> For high performance arms with soft armpads, substitute 7P for 7A in pattern.  <b>Code: Upchg: Description:</b> P \$250 High performance arms  High Performance Arm detail 
		<b>Cylinder Height Options:</b> For height ranges see Bulldog Dimensions and Operating Instructions. Replace 5 in pattern with one of the following options: <b>Code: Upchg: Description:</b> L n/c low cylinder H n/c high cylinder

arm height/width, pad rotation/slide

pattern no.	grades		COM												
	A	B	C	D	E	F	G	H	I	T	U	V	W	X	Y
<b>7A4-1-A5G-H</b>	\$1,338.	\$1,393.	\$1,439.	\$1,472.	\$1,504.	\$1,528.	\$1,558.	\$1,633.	\$1,765.	\$2,041.	\$2,114.	\$2,222.	\$2,622.	\$2,677.	\$2,697.
<b>7C4-1-A5G-H</b>	1,223.	1,276.	1,323.	1,356.	1,386.	1,410.	1,440.	1,514.	1,647.	1,923.	1,995.	2,103.	2,503.	2,559.	2,576.
<b>7A4-1-B5G-H</b>	1,229.	1,282.	1,328.	1,364.	1,393.	1,418.	1,448.	1,520.	1,656.	1,917.	1,990.	2,109.	2,508.	2,564.	2,584.
<b>7C4-1-B5G-H</b>	1,112.	1,164.	1,210.	1,245.	1,276.	1,300.	1,331.	1,405.	1,539.	1,797.	1,870.	1,992.	2,390.	2,445.	2,466.
<b>7RS2</b>	318.	345.	374.	396.	415.	431.	452.	499.	585.	743.	783.	851.	1,044.	1,099.	1,107.
<b>7RB4</b>	192.	221.	249.	272.	290.	308.	327.	373.	459.	622.	654.	724.	917.	972.	978.
<b>U</b>	115.	136.	158.	174.	188.	199.	215.	246.	310.	410.	410.	461.	626.	651.	659.
<b>C</b>	80.	80.	80.	80.	80.	80.	80.	80.	80.	111.	111.	111.	111.	111.	111.

### Upholstery Options

#### Heavy Duty Spring Option:

Insert HD after A or B in pattern.

*Code: Upchg: Description:*  
 HD \$13 Heavy duty spring

#### Sliding Seat Option:

Substitute K for G in pattern.

*Code: Upchg: Description:*  
 K \$118 Sliding seat

#### Caster and Glide Options:

Substitute H in pattern with one of the following:

*Code: Upchg: Description:*  
 R \$51 Soft casters for hard surfaces  
 G n/c Glides

#### KnollTextiles Fabrics and Spinneybeck Leathers

Please refer to the textile matrices at the beginning of the price list for approved fabrics and leathers.

#### Split upholstery option:

Bulldog Executive Chair seats and backs can be upholstered in any two approved KnollTextiles or Spinneybeck upholsteries. To specify, first indicate the seat upholstery (labeled "seat upholstery") and then indicate the back upholstery (labeled "back upholstery"). The list price of the chair equals the list price of the higher of the two upholstery grades.

#### Cal 133:





▲ = Cal 133 upholstery available. See textile matrices at the beginning of the price list for pre-approved Cal 133 textiles. Not available on chairs with upholstered outer back.

#### COM/COL Textile Requirement

	fabric yds.	leather sq. ft.
chair	1.5	26
outer back shell	0.7	11

# Bulldog®

## high task chair

	pattern no.	description *
<b>Designer(s):</b> Dale Fahnstrom and Michael McCoy  <b>Award(s):</b> Bulldog Chair Adjustable Arm - IBD Product Design Bronze Award, 1993; IDEA Bronze Annual Design Award, 1991; Outstanding Performance, Product Design Achievement Award, IBD Southern California Chapter, 1990; IFMA and Facilities Design&Management Gold Award, 1990; IBD Product Design Bronze Award, 1990	<b>7A5-1-A5G-H</b> 	Armchair, Advanced control  Synchronized tilt, 4" back height, forward tilt, tilt lock, variable position tilt stop, pneumatic seat height, 360 degree swivel, pneumatic footrest.
	<b>7C5-1-A5G-H</b> 	Armless, Advanced control  Synchronized tilt, 4" back height, forward tilt, tilt lock, variable position tilt stop, pneumatic seat height, 360 degree swivel, pneumatic footrest.
	<b>7A5-1-B5G-H</b> 	Armchair, Basic control  Synchronized tilt, 4" back height, tilt lock, variable position tilt stop, pneumatic seat height, 360 degree swivel, pneumatic footrest.
	<b>7C5-1-B5G-H</b> 	Armless, Basic control  Synchronized tilt, 4" back height, tilt lock, variable position tilt stop, pneumatic seat height, 360 degree swivel, pneumatic footrest.
	<b>7RS2</b>	seat reupholstery assembly
<b>7RB4</b>	back reupholstery assembly	
<b>U</b>	upholstered outer shell (insert U after 7A or 7C in pattern number)	
<b>C</b>	Cal 133 (add C after pattern number and add 133 after upholstery code) Not available on upholstered outer back chairs.	

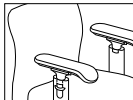

\* For additional information on controls, options and construction, see page 90

Order Code	Ordering Information	Options
Example: <b>7C5-1-B5G-H-K349/12</b> <b>7C5</b> Bulldog high task armless chair <b>1</b> dark grey finish <b>B5G</b> Basic control <b>H</b> 2" dual, hooded hard-wheel casters <b>K349/12</b> Alignment, Harbor  Example for Cal 133: <b>7C5-1-B5G-H-C-K349/12-133</b>	Specify: 1. Pattern number 2. Upholstery selection  Finish color: Dark Grey	Arm Option: For high performance arms with soft arm pads, substitute 7P for 7A in pattern.  Code: Upchg: Description: P \$250 High performance arms  High Performance Arm detail   Caster and Glide Options: Substitute H in pattern with one of the following:  Code: Upchg: Description: R \$51 Soft casters for hard surfaces G n/c Glides

arm height/width, pad rotation/slide

pattern no.	grades		COM															
	A	B	C	D	E	F	G	H	I	T	COL			U	V	W	X	Y
<b>7A5-1-A5G-H</b>	\$1,836.	\$1,885.	\$1,933.	\$1,970.	\$2,001.	\$2,027.	\$2,060.	\$2,136.	\$2,281.	\$2,567.	\$2,640.	\$2,768.	\$3,192.	\$3,251.	\$3,269.			
<b>7C5-1-A5G-H</b>	1,722.	1,769.	1,817.	1,853.	1,883.	1,912.	1,943.	2,021.	2,162.	2,448.	2,519.	2,649.	3,071.	3,132.	3,152.			
<b>7A5-1-B5G-H</b>	1,727.	1,775.	1,824.	1,858.	1,890.	1,918.	1,948.	2,026.	2,170.	2,455.	2,530.	2,654.	3,077.	3,138.	3,158.			
<b>7C5-1-B5G-H</b>	1,609.	1,658.	1,705.	1,741.	1,774.	1,800.	1,832.	1,911.	2,054.	2,338.	2,409.	2,537.	2,959.	3,021.	3,040.			
<b>7RS2</b>	318.	345.	374.	396.	415.	431.	452.	499.	585.	743.	783.	851.	1,044.	1,099.	1,107.			
<b>7RB4</b>	192.	221.	249.	272.	290.	308.	327.	373.	459.	622.	654.	724.	917.	972.	978.			
<b>U</b>	115.	136.	158.	174.	188.	199.	215.	246.	310.	410.	410.	461.	626.	651.	659.			
<b>C</b>	80.	80.	80.	80.	80.	80.	80.	80.	80.	111.	111.	111.	111.	111.	111.			

### Upholstery Options

#### KnollTextiles Fabrics and Spinneybeck Leathers

Please refer to the textile matrices at the beginning of the price list for approved fabrics and leathers.

#### Split upholstery option:

Bulldog Executive Chair seats and backs can be upholstered in any two approved KnollTextiles or Spinneybeck upholsteries. To specify, first indicate the seat upholstery (labeled "seat upholstery") and then indicate the back upholstery (labeled "back upholstery"). The list price of the chair equals the list price of the higher of the two upholstery grades.

#### Cal 133:



‡ = Cal 133 upholstery available. See textile matrices at the beginning of the price list for pre-approved Cal 133 textiles. Not available on chairs with upholstered outer back.

#### COM/COL Textile Requirement

	<i>fabric</i> yds.	<i>leather</i> sq.ft.
chair	1.5	26
outer back shell	0.7	11

# Bulldog®

## side chair

	pattern no.	description *
<i>Designer(s):</i> Dale Fahnstrom and Michael McCoy	<b>7A8-1-SL</b> 	Armchair, sled base
<i>Award(s):</i> IDEA Bronze Annual Design Award, 1991; Outstanding Performance, Product Design Achievement Award, IBD Southern California Chapter, 1990; IFMA and Facilities Design&Management Gold Award, 1990; IBD Product Design Bronze Award, 1990	<b>7C8-1-SL</b> 	Armless , sled base
	<b>U</b>	upholstered outer shell (insert U after 7A or 7C in pattern number)
	<b>C</b>	Cal 133 (add C after pattern number and add 133 after upholstery code. ) Not available on upholstered outer shell chairs



\* For construction information, see page 91

### Order Code

*Example:* **7A8-1-SL-K349/12**  
**7A8** Bulldog side armchair  
**1** dark grey finish  
**SL** sled base  
**K349/12** Alignment, Harbor

*Example for Cal 133:*

**7A8-1-SL-C-K349/12-133**

### Ordering Information

*Specify:*  
 1. Pattern number  
 2. Upholstery selection

*Finish color:*  
 Dark Grey



pattern no.	grades		COM										COL				
	A	B	C	D	E	F	G	H	I	T	U	V	W	X	Y		
<b>7A8-1-SL</b>	\$713.	\$752.	\$794.	\$822.	\$846.	\$870.	\$897.	\$958.	\$1,079.	\$1,217.	\$1,261.	\$1,358.	\$1,600.	\$1,634.	\$1,649.		
<b>7C8-1-SL</b>	653.	695.	735.	763.	790.	812.	836.	900.	1,019.	1,158.	1,202.	1,297.	1,540.	1,576.	1,590.		
<b>U</b>	123.	154.	187.	210.	230.	249.	272.	321.	415.								
<b>C</b>	80.	80.	80.	80.	80.	80.	80.	80.	80.								

**Upholstery Options**

**Knoll Textiles Fabrics and Spinneybeck Leathers**

Please refer to the textile matrices at the beginning of the price list for approved fabrics and leathers.

*Cal 133:*  
 ‡ = Cal 133 upholstery available. See textile matrices at the beginning of the price list for pre-approved Cal 133 textiles. Not available on chairs with upholstered outer back.

**COM/COL Textile Requirement**

	<i>fabric</i> yds.	<i>leather</i> sq. ft.
chair	1.3	17
outer back shell	1.0	13

## For Executive, Management, Operational and High Task Chairs:

### Executive page 80



### Management page 82



### Operational page 84



### High Task page 86



## Controls and Options

### Advanced control:

360° swivel, synchronized tilt with tilt tension, forward tilt, tilt lock, variable position tilt stop, 4" back height and pneumatic seat height adjustments.

### Basic control:

360° swivel, synchronized tilt with tilt tension, tilt lock, variable position tilt stop, 4" back height and pneumatic seat height adjustments.

### Sliding seat:

2 1/4" adjustment.

### High performance arms:

Arm height adjusts 7" - 11" (4" total range) from the seat reference point. Arm support width adjusts 1 1/2" on each side (3" total range) via lever activation. Armpads rotate 42° (each arm) with locked positions in the rotation range. Armpads slide 1 1/2" forward via push button mechanism. Standard soft armpads.



### Heavy-Duty Spring:

The heavy duty spring adds approximately 20% more tension to the chair, especially benefiting individuals in the upper percentiles. Please be advised that tension will not be as loose on the low end of the range. The heavy-duty spring is standard on the Executive chair and available as an option in the Management and Operational chairs.

## Construction

### Outer back shell:

Integrally colored, textured polypropylene.

*Internal seat/back support shell:*  
Glass-reinforced polypropylene.

### Upholstery:

High resilient, variable density molded, urethane foam with textile cover; seat cover top-stitched.

### Sliding seat:

Steel plate and glass-reinforced nylon and nylon GS components.

### Arms supports:

Integrally colored, textured, glass-reinforced polyester supports.

### High performance arm supports:

Integrally colored, textured, glass-reinforced nylon and all other engineered thermoplastics with zinc die-cast housing.

### Soft armpad:

Self skinning urethane molded over steel substrate. Soft armpad is standard on high-performance arm.

### Column cover:

Integrally colored, textured polypropylene.

### Base:

Integrally colored, textured, glass-reinforced nylon.

### High Tech Footrest:

Die cast support element with resilient thermoplastic cover. Pneumatic operation.

### Casters:



Black, integrally colored, textured nylon; 2" dual, hooded hard- or soft-wheel design.

### Glides:



Black, integrally colored, molded nylon; does not reduce height of chair.

---

For Side Chairs:

**Side Chairs,  
page 88**

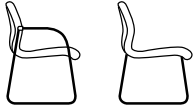

---

**Construction**

*Outer shell:*

Integrally colored, textured polypropylene.

*Internal support shell:*

Glass-reinforced polypropylene.

*Upholstery:*

High resilient, molded, urethane foam with top-stitched textile cover.

*Frame:*

16-gauge steel tube with textured epoxy powder coat paint.

*Glides:*

Black, integrally colored nylon.

# Bulldog® Dimensions and Operating Instructions

## Seat

	Seat Height*	Seat Depth**	Seat Width	Seat Pan Angle	Seat Back/ Seat Pan Angle
ANSI HFS 100-1988 Ergonomic Guidelines:					
	16" - 20½"	15" - 17"	18.2" min.	0° - 10° fixed	90°-105° at rest
<b>Executive</b>	16" - 21"*	17½"	21"	2°	101°
<b>Management</b>	16" - 21"*	17½"	21"	2°	101°
<b>Operational</b>	16" - 21"	16 <sup>15</sup> / <sub>16</sub> "	20"	2°	100°
<b>High Task</b>	22½" - 32½"	16 <sup>15</sup> / <sub>16</sub> "	20"	2°	100°

## Back

	Backrest	Lumbar Support Height	Lumbar Support Width	Seat Back Width
ANSI HFS 100-1988 Ergonomic Guidelines:				
	yes	6" - 9"	12" min.	12" min.
<b>Executive</b>	yes	5" - 9"	19"	22½"
<b>Management</b>	yes	5" - 9"	19"	22½"
<b>Operational</b>	yes	5" - 9"	16"	16"
<b>Task</b>	yes	5" - 9"	16"	16"
<b>High Task</b>	yes	5" - 9"	16"	16"

## Armrests

Width Between Armrests	Width Between Std. Adjustable	Width Between High Perf. Arm
18.2" min.		
19"	17.5" - 18.5"	19" - 22"
19"	17.5" - 18.5"	19" - 22"
18½"	16.5" - 17.5"	18" - 21"
18½"	16.5" - 17.5"	18" - 21"
18½"	16.5" - 17.5"	18" - 21"

\*Three seat height options are available. Medium is displayed above. Low is 14½" - 19<sup>10</sup>/<sub>16</sub>". High is 17" - 22". High Task is not included.

\*\*Adjustable seat depth dimensions for Task or Operational are 16<sup>15</sup>/<sub>16</sub>" - 19<sup>15</sup>/<sub>16</sub>" and for Management or Executive are 17½" - 19½" (with back in lowest position).

Side chair seat height from floor is 17.5"; inside distance between arms is 21<sup>1</sup>/<sub>8</sub>".

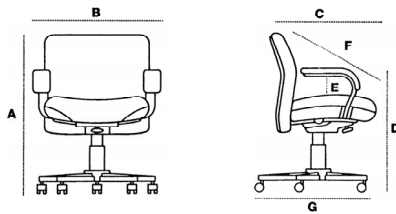

	Executive	Management	Operational	High Task	Side
<b>A</b> overall height	36" - 45"	30" - 39"	31 <sup>1</sup> / <sub>4</sub> "-40 <sup>1</sup> / <sub>4</sub> "	36½" - 51"	31 <sup>1</sup> / <sub>4</sub> "
<b>B</b> overall width	25½"	25½"	23½"	23½"	25 <sup>1</sup> / <sub>4</sub> " with arms, 21" a
<b>C</b> overall depth	21 <sup>1</sup> / <sub>4</sub> "	21 <sup>1</sup> / <sub>4</sub> "	21 <sup>1</sup> / <sub>4</sub> "	20½"	23"
<b>D</b> arm height (from floor)	23 <sup>1</sup> / <sub>4</sub> " - 28 <sup>1</sup> / <sub>4</sub> "	23 <sup>1</sup> / <sub>4</sub> " - 28 <sup>1</sup> / <sub>4</sub> "	24" - 29"	30 <sup>1</sup> / <sub>4</sub> "-40 <sup>1</sup> / <sub>4</sub> "	25 <sup>1</sup> / <sub>8</sub> "
<b>E</b> arm height (from seat ref. pt.)	8½"	8½"	8 <sup>3</sup> / <sub>8</sub> "	8 <sup>3</sup> / <sub>8</sub> "	7 <sup>1</sup> / <sub>4</sub> "
<b>F</b> recline range	17.2°	17.2°	19°	19°	n/a
<b>G</b> base dimension	27" dia.	27" dia.	27" dia.	27" dia.	24" width
<b>H</b> weight (with fixed arms)	50 lbs.	47 lbs.	44 lbs.	52 lbs.	28 lbs.

(Measurements of arm chairs, advanced control with pneumatic seat height adjustment, in inches.)

## Adjustable Arm Options:

High Performance Arms

**Height**  
(from Seat Reference Point)

7" - 11" (4" range)

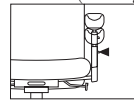

**Width Between Arms**

Oper. 18½" - 21½"  
Mgt/Exec. 21" - 24"  
(3" range for supports)  
Distance between arm supports

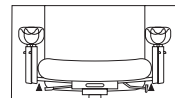

**Rotation**

42° total  
(21° left, 21° right)  
(fixed increment rotation)

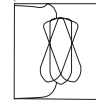

**Pad Slide**

1½" forward

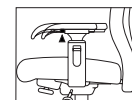

**Retrofittable**

Yes

Compliance: ANSI/BIFMA x5.1 - 1993, ANSI/HFS 100-1988, Cal 117, Cal 133 (with approved FR upholstery)



### Seat Height Adjustment

For pneumatic seat height chairs, lift the handle on the right to adjust height. If your chair does not have pneumatic seat height, it has mechanical seat height. To raise, rotate the seat counterclockwise and to lower, rotate the seat clockwise.

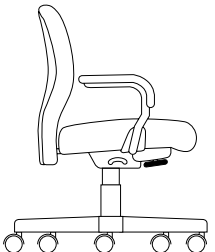

### Tension Adjustment

Lean back and recline. Adjust tension if necessary. To adjust tension, reach under the front of the seat to find the knob. Turn left to tighten and right to loosen.

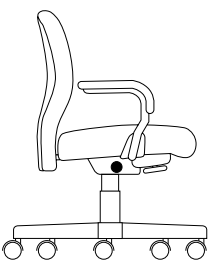

### Tilt Lock

On the left side of the chair, push the circular knob in to lock and pull out to unlock the tilt.

### Variable Tilt Stop

*(on all models with tilt lock)*

Using the same control as the tilt lock (see above), recline in the chair and push knob to set. This limits the amount of recline.

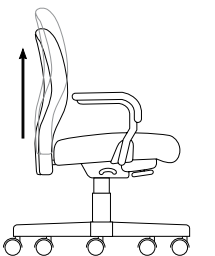

### Back Height Adjustment

*(2-piece chairs)*

Place both hands on the base of the back and lift to raise the back height. The back height adjusts 8 notches upward for a total of 4" adjustability. The 9th notch brings the back down to the lowest position.

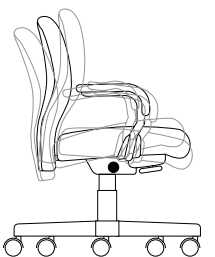

### Forward Tilt

*(optional)*

Recline slightly and rotate the lever on the left side of the chair in a forward motion. Recline and rotate the same knob rearward to return to the original position.

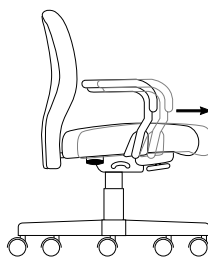

### Sliding Seat Depth Adjustment

*(optional)*

Pull the lever located under the right side of the seat cushion to the rear of the arm. Slide the seat to the desired location. Release the lever in one of the six stops within the 2 1/4" range.

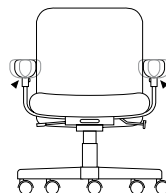

### Armpad Width

Remove the two screws under the armpad with a screwdriver. Remove the armpads 1/2" right or left of center for 1" of adjustability. Reinsert the screws.

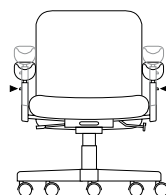

### High Performance Arms

*(optional):*

#### Armpad Height

Lift the lever on the outside of the arm support for 4" of height adjustability.

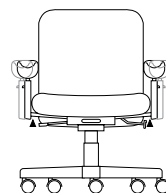

### Arm Support Width

Lift the lever located beneath the arm support. Adjust the arm support to the desired width and tighten the lever by pushing it down. The arm supports can be adjusted 1 1/2" on each side for a total of 3" in width adjustment.

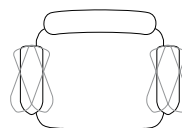

### Armpad Rotation

Lift slightly and rotate the armpads 21° right or left of center for a total of 42° in adjustability.

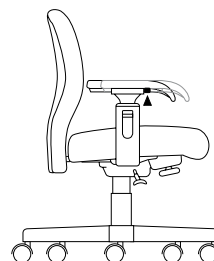



### Armpad Slide

Press on the buttons located on either side of the armpad and slide the armpad to the desired position.

RPM®  
basic control

Designer(s):  
Carl Magnusson, 2000



pattern no.	description *
<b>8P4-2-A5GH</b>	high performance arm, basic control Basic control: synchronized tilt, 4" back height, forward tilt, tilt lock (5 position), side-position tension knob, pneumatic seat height, 360° swivel, instructions attached to side of control
	
<b>8A4-2-A5GH</b>	fixed height arms, basic control Basic control: synchronized tilt, 4" back height, forward tilt, tilt lock (5 position), side-position tension knob, pneumatic seat height, 360° swivel, instructions attached to side of control
	
<b>8C4-2-A5GH</b>	armless, basic control Basic control: synchronized tilt, 4" back height, forward tilt, tilt lock (5 position), side-position tension knob, pneumatic seat height, 360° swivel, instructions attached to side of control
	
<b>8RSEAT</b>	Replacement seat
<b>8RBACK</b>	Replacement back, prior to 11/01/2005
<b>8UPHBACK</b>	Replacement back, after 11/01/2005

\* For control and construction information, see page 106

Order Code	Ordering Information	Options
<i>Example:</i> <b>8A4-2-A5GH SP7</b>	<i>Specify:</i>	<i>Cylinder Height Options:</i>
<b>8A4</b> RPM task chair, fixed arms	1. Pattern number	For height ranges see RPM Dimensions and Operating Instructions. Replace 5 in pattern with one of the following options:
<b>2</b> Black finish and black levers	2. Upholstery selection	
<b>A5G</b> Basic control	<i>Finish color:</i>	<i>Code: Upchg: Description:</i>
<b>H</b> Hard caster for carpet	Black	L n/c low cylinder
<b>SP7</b> Speedway, Black		H n/c high cylinder
		<i>Caster and Glide Options:</i>
		Substitute H in pattern with one of the following:
		<i>Code: Upchg: Description:</i>
		R \$49 Soft casters for hard surfaces
		G n/c Glides

pattern no.	RPM grade	grades A	COM B	C	D	E	F	G	H	I	T	COL U	V	W	Y
<b>8P4-2-A5GH</b>	\$972.	\$1,105.	\$1,152.	\$1,206.	\$1,233.	\$1,267.	\$1,308.	\$1,367.	\$1,441.	\$1,480.	\$1,766.	\$1,857.	\$1,966.	\$2,646.	\$2,783.
<b>8A4-2-A5GH</b>	897.	1,033.	1,080.	1,131.	1,158.	1,193.	1,233.	1,294.	1,367.	1,408.	1,691.	1,783.	1,891.	2,571.	2,709.
<b>8C4-2-A5GH</b>	857.	992.	1,039.	1,093.	1,119.	1,152.	1,193.	1,252.	1,328.	1,367.	1,650.	1,741.	1,849.	2,529.	2,667.
<b>8RSEAT</b>	277.	405.	449.	501.	525.	557.	596.	652.	725.	763.	1,019.	1,110.	1,214.	1,861.	2,172.
<b>8RBACK</b>	287.	412.	459.	509.	534.	567.	606.	663.	733.	771.	1,029.	1,120.	1,223.	1,871.	2,211.
<b>8UPHBACK</b>	287.	412.	459.	509.	534.	567.	606.	663.	733.	771.	1,029.	1,120.	1,223.	1,871.	2,211.

**RPM Grade Upholsteries***Radial*

RAD6	Teal/Silver Leaf
RAD7	Midnight/Huckleberry
RAD8	Black/Batik
RAD9	Black/Crimson
RAD10	Claret/Jute
RAD20	Chocolate/Palomino
RAD21	Prune/Ribbon
RAD22	Spice/Jute
RAD23	Cappuccino/Pebble Beige
RAD24	Basil/Tin
RAD25	Basil/Xanadu
RAD26	Chocolate/Steel Blue
RAD27	Black/Smoke
RAD28	Smoke/Black
RAD29	Smoke/Pebble Beige

*Speedway*

SP2	Smoke
SP3	Steel Blue
SP5	Midnight
SP6	Crimson
SP7	Black
SP10	Basil
SP33	Wine
SP36	Chocolate

## Ordering Samples/Viewing online:

To view RPM upholstery colors refer to the Surface Finish Library on [knoll.com](http://knoll.com). Physical samples are the best representation of color. To order samples, contact a Knoll sales representative or Knoll dealer.

**Textile Options****KnollTextiles Fabrics and Spinneybeck Leathers**

Please refer to the textile matrices at the beginning of the price list for approved fabrics and leathers.

**COM/COL Textile Requirement**

	fabric yds.	leather sq. ft.
chair	1.4	25

*Cal 133:*

‡ = Cal 133 upholstery available. See textile matrices at the beginning of the price list for pre-approved Cal 133 textiles.

To specify, add C after pattern number and 133 after upholstery code.

Code:	Upchg:	Description:
C()133	\$129	Cal 133 textile

RPM®  
advanced control

Designer(s):  
Carl Magnusson, 2000



pattern no.	description *
<b>8P4-2-A5KH</b>	high performance arm, advanced control (sliding seat pan) Advanced control: synchronized tilt, 4" back height, sliding seat adjustment, forward tilt, tilt lock (5 position), side-position tension knob, pneumatic seat height, 360° swivel, instructions attached to side of control
<b>8A4-2-A5KH</b>	fixed height arms, advanced control (sliding seat pan) Advanced control: synchronized tilt, 4" back height, sliding seat adjustment, forward tilt, tilt lock (5 position), side-position tension knob, pneumatic seat height, 360° swivel, instructions attached to side of control
<b>8C4-2-A5KH</b>	armless, advanced control (sliding seat pan) Advanced control: synchronized tilt, 4" back height, sliding seat adjustment, forward tilt, tilt lock (5 position), side-position tension knob, pneumatic seat height, 360° swivel, instructions attached to side of control
<b>8RSEAT</b>	Replacement seat
<b>8RBACK</b>	Replacement back, prior to 11/01/2005
<b>8UPHBACK</b>	Replacement back, after 11/01/2005

\* For control and construction information, see page 106

Order Code	Ordering Information	Options
<i>Example:</i> <b>8A4-2-A5KH SP7</b>	<i>Specify:</i>	<i>Cylinder Height Options:</i>
<b>8A4</b> RPM task chair, fixed arms	1. Pattern number	For height ranges see RPM Dimensions and Operating Instructions. Replace 5 in pattern with one of the following options:
<b>2</b> Black finish and black levers	2. Upholstery selection	
<b>A5K</b> Advanced control with sliding seat	<i>Finish color:</i>	<i>Code: Upchg: Description:</i>
<b>H</b> Hard caster for carpet	Black	L n/c low cylinder
<b>SP7</b> Speedway, Black		H n/c high cylinder
		<i>Caster and Glide Options:</i>
		Substitute H in pattern with one of the following:
		<i>Code: Upchg: Description:</i>
		R \$49 Soft casters for hard surfaces
		G n/c Glides



pattern no.	RPM grade	grades A	COM B	C	D	E	F	G	H	I	T	COL U	V	W	Y
<b>8P4-2-A5KH</b>	\$1,009.	\$1,137.	\$1,181.	\$1,232.	\$1,257.	\$1,290.	\$1,328.	\$1,384.	\$1,455.	\$1,494.	\$1,762.	\$1,851.	\$1,955.	\$2,605.	\$2,734.
<b>8A4-2-A5KH</b>	938.	1,066.	1,111.	1,162.	1,187.	1,218.	1,257.	1,315.	1,384.	1,423.	1,690.	1,781.	1,886.	2,532.	2,663.
<b>8C4-2-A5KH</b>	898.	1,026.	1,073.	1,123.	1,148.	1,181.	1,218.	1,277.	1,347.	1,384.	1,651.	1,742.	1,846.	2,494.	2,625.
<b>8RSEAT</b>	277.	405.	449.	501.	525.	557.	596.	652.	725.	763.	1,019.	1,110.	1,214.	1,861.	2,172.
<b>8RBACK</b>	287.	412.	459.	509.	534.	567.	606.	663.	733.	771.	1,029.	1,120.	1,223.	1,871.	2,211.
<b>8UPHBACK</b>	287.	412.	459.	509.	534.	567.	606.	663.	733.	771.	1,029.	1,120.	1,223.	1,871.	2,211.

**RPM Grade Upholsteries***Radial*

RAD6	Teal/Silver Leaf
RAD7	Midnight/Huckleberry
RAD8	Black/Batik
RAD9	Black/Crimson
RAD10	Claret/Jute
RAD20	Chocolate/Palomino
RAD21	Prune/Ribbon
RAD22	Spice/Jute
RAD23	Cappuccino/Pebble Beige
RAD24	Basil/Tin
RAD25	Basil/Xanadu
RAD26	Chocolate/Steel Blue
RAD27	Black/Smoke
RAD28	Smoke/Black
RAD29	Smoke/Pebble Beige

*Speedway*

SP2	Smoke
SP3	Steel Blue
SP5	Midnight
SP6	Crimson
SP7	Black
SP10	Basil
SP33	Wine
SP36	Chocolate

## Ordering Samples/Viewing online:

To view RPM upholstery colors refer to the Surface Finish Library on [knoll.com](http://knoll.com). Physical samples are the best representation of color. To order samples, contact a Knoll sales representative or Knoll dealer.

**Textile Options****KnollTextiles Fabrics and Spinneybeck Leathers**

Please refer to the textile matrices at the beginning of the price list for approved fabrics and leathers.

**COM/COL Requirement**

	fabric yds.	leather sq. ft.
chair	1.4	25

*Cal 133:*

‡ = Cal 133 upholstery available. See textile matrices at the beginning of the price list for pre-approved Cal 133 textiles.



To specify, add C after pattern number and 133 after upholstery code.

Code:	Upchg:	Description:
C()133	\$129	Cal 133 textile

RPM®  
*high task chair*  
*basic control*

Designer(s):  
 Carl Magnusson, 2000



pattern no.	description *	
<b>8P5-2-A5GH</b>		high performance arm, basic control, mechanical height footring (9" - 18" height range)  Basic control: synchronized tilt, 4" back height adjustment, forward tilt, tilt lock (5 position), side-position tension knob, pneumatic seat height, 360 degree swivel, instructions attached to side of control, mechanical height footring
<b>8A5-2-A5GH</b>		fixed height arms, basic control, mechanical height footring (9" - 18" height range)  Basic control: synchronized tilt, 4" back height adjustment, forward tilt, tilt lock (5 position), side-position tension knob, pneumatic seat height, 360 degree swivel, instructions attached to side of control, mechanical height footring
<b>8C5-2-A5GH</b>		armless, basic control, mechanical height footring (9" - 18" height range)  Basic control: synchronized tilt, 4" back height adjustment, forward tilt, tilt lock (5 position), side-position tension knob, pneumatic seat height, 360 degree swivel, instructions attached to side of control, mechanical height footring
<b>8RSEAT</b>	Replacement seat	
<b>8RBACK</b>	Replacement back, prior to 11/01/2005	
<b>8UPHBACK</b>	Replacement back, after 11/01/2005	

\* For control and construction information, see page 106

Order Code	Ordering Information	Options
<i>Example:</i> <b>8A5-2-A5GH SP7</b>	<i>Specify:</i>	<i>Caster and Glide Options:</i>
<b>8A5</b> RPM high task chair, fixed arms	1. Pattern number	Substitute H in pattern with one of the following:
<b>2</b> Black finish and black levers	2. Upholstery selection	
<b>A5G</b> Basic control	<i>Finish color:</i>	<i>Code: Upchg: Description:</i>
<b>H</b> Hard caster for carpet	Black	R \$49 Soft casters for hard surfaces
<b>SP7</b> Speedway, Black		G n/c Glides

pattern no.	RPM grade	grades A	COM B	C	D	E	F	G	H	I	T	COL U	V	W	Y
<b>8P5-2-A5GH</b>	\$1,251.	\$1,385.	\$1,434.	\$1,487.	\$1,512.	\$1,545.	\$1,589.	\$1,649.	\$1,721.	\$1,761.	\$2,050.	\$2,142.	\$2,249.	\$2,930.	\$3,289.

<b>8A5-2-A5GH</b>	1,180.	1,314.	1,359.	1,413.	1,440.	1,475.	1,512.	1,573.	1,649.	1,689.	1,977.	2,066.	2,178.	2,856.	3,217.
-------------------	--------	--------	--------	--------	--------	--------	--------	--------	--------	--------	--------	--------	--------	--------	--------

<b>8C5-2-A5GH</b>	1,139.	1,272.	1,319.	1,375.	1,400.	1,434.	1,475.	1,534.	1,607.	1,649.	1,936.	2,027.	2,136.	2,815.	3,184.
-------------------	--------	--------	--------	--------	--------	--------	--------	--------	--------	--------	--------	--------	--------	--------	--------

<b>8RSEAT</b>	277.	405.	449.	501.	525.	557.	596.	652.	725.	763.	1,019.	1,110.	1,214.	1,861.	2,172.
<b>8RBACK</b>	287.	412.	459.	509.	534.	567.	606.	663.	733.	771.	1,029.	1,120.	1,223.	1,871.	2,211.
<b>8UPHBACK</b>	287.	412.	459.	509.	534.	567.	606.	663.	733.	771.	1,029.	1,120.	1,223.	1,871.	2,211.

**RPM Grade Upholsteries***Radial*

RAD6	Teal/Silver Leaf
RAD7	Midnight/Huckleberry
RAD8	Black/Batik
RAD9	Black/Crimson
RAD10	Claret/Jute
RAD20	Chocolate/Palomino
RAD21	Prune/Ribbon
RAD22	Spice/Jute
RAD23	Cappuccino/Pebble Beige
RAD24	Basil/Tin
RAD25	Basil/Xanadu
RAD26	Chocolate/Steel Blue
RAD27	Black/Smoke
RAD28	Smoke/Black
RAD29	Smoke/Pebble Beige

*Speedway*

SP2	Smoke
SP3	Steel Blue
SP5	Midnight
SP6	Crimson
SP7	Black
SP10	Basil
SP33	Wine
SP36	Chocolate

## Ordering Samples/Viewing online:

To view RPM upholstery colors refer to the Surface Finish Library on [knoll.com](http://knoll.com). Physical samples are the best representation of color. To order samples, contact a Knoll sales representative or Knoll dealer.

**Textile Options****KnollTextiles Fabrics and Spinneybeck Leathers**

Please refer to the textile matrices at the beginning of the price list for approved fabrics and leathers.

**COM/COL Textile Requirement**

	fabric yds.	leather sq. ft.
chair	1.4	25

*Cal 133:*

‡ = Cal 133 upholstery available. See textile matrices at the beginning of the price list for pre-approved Cal 133 textiles.



To specify, add C after pattern number and 133 after upholstery code.

Code:	Upchg:	Description:
C()133	\$129	Cal 133 textile

RPM®  
*high task chair*  
*advanced control*

Designer(s):  
 Carl Magnusson, 2000



pattern no.	description *
<b>8P5-2-A5KH</b>	high performance arm, advanced control, mechanical height footring (9" - 18" height range) Advanced control: synchronized tilt, 4" back height, adjustment forward tilt, tilt lock (5 position), sliding seat-depth adjustment, side-position tension knob, pneumatic seat height, 360 degree swivel, instructions, mechanical height footring
	
<b>8A5-2-A5KH</b>	fixed height arms, advanced control, mechanical height footring (9" - 18" height range) Advanced control: synchronized tilt, 4" back height adjustment, forward tilt, tilt lock (5 position), sliding seat-depth adjustment, side-position tension knob, pneumatic seat height, 360 degree swivel, instructions, mechanical height footring
	
<b>8C5-2-A5KH</b>	armless, advanced control, mechanical height footring (9" - 18" height range) Advanced control: synchronized tilt, 4" back height adjustment, forward tilt, tilt lock (5 position), sliding seat-depth adjustment, side-position tension knob, pneumatic seat height, 360 degree swivel, instructions, mechanical height footring
	
<b>8RSEAT</b>	Replacement seat
<b>8RBACK</b>	Replacement back, prior to 11/01/2005
<b>8UPHBACK</b>	Replacement back, after 11/01/2005

\* For control and construction information, see page 106

Order Code	Ordering Information	Options
<i>Example:</i> <b>8A5-2-A5KH SP7</b>	<i>Specify:</i>	<i>Caster and Glide Options:</i>
<b>8A5</b> RPM high task chair, fixed arms	1. Pattern number	Substitute H in pattern with one of the following:
<b>2</b> Black finish and black levers	2. Upholstery selection	
<b>A5K</b> Advanced control	<i>Finish color:</i>	<i>Code: Upchg: Description:</i>
<b>H</b> Hard caster for carpet	Black	R \$49 Soft casters for hard surfaces
<b>SP7</b> Speedway, Black		G n/c Glides

pattern no.	RPM grade	grades A	COM B	C	D	E	F	G	H	I	T	COL U	V	W	Y
<b>8P5-2-A5KH</b>	\$1,290.	\$1,416.	\$1,462.	\$1,511.	\$1,538.	\$1,570.	\$1,607.	\$1,665.	\$1,736.	\$1,775.	\$2,047.	\$2,138.	\$2,241.	\$2,889.	\$3,240.

<b>8A5-2-A5KH</b>	1,218.	1,347.	1,392.	1,442.	1,469.	1,501.	1,538.	1,595.	1,665.	1,730.	1,976.	2,065.	2,169.	2,817.	3,173.
-------------------	--------	--------	--------	--------	--------	--------	--------	--------	--------	--------	--------	--------	--------	--------	--------

<b>8C5-2-A5KH</b>	1,181.	1,309.	1,352.	1,405.	1,429.	1,462.	1,501.	1,557.	1,627.	1,665.	1,937.	2,029.	2,130.	2,780.	3,144.
-------------------	--------	--------	--------	--------	--------	--------	--------	--------	--------	--------	--------	--------	--------	--------	--------

<b>8RSEAT</b>	277.	405.	449.	501.	525.	557.	596.	652.	725.	763.	1,019.	1,110.	1,214.	1,861.	2,172.
<b>8RBACK</b>	287.	412.	459.	509.	534.	567.	606.	663.	733.	771.	1,029.	1,120.	1,223.	1,871.	2,211.
<b>8UPHBACK</b>	287.	412.	459.	509.	534.	567.	606.	663.	733.	771.	1,029.	1,120.	1,223.	1,871.	2,211.

**RPM Grade Upholsteries***Radial*

RAD6	Teal/Silver Leaf
RAD7	Midnight/Huckleberry
RAD8	Black/Batik
RAD9	Black/Crimson
RAD10	Claret/Jute
RAD20	Chocolate/Palomino
RAD21	Prune/Ribbon
RAD22	Spice/Jute
RAD23	Cappuccino/Pebble Beige
RAD24	Basil/Tin
RAD25	Basil/Xanadu
RAD26	Chocolate/Steel Blue
RAD27	Black/Smoke
RAD28	Smoke/Black
RAD29	Smoke/Pebble Beige

*Speedway*

SP2	Smoke
SP3	Steel Blue
SP5	Midnight
SP6	Crimson
SP7	Black
SP10	Basil
SP33	Wine
SP36	Chocolate

## Ordering Samples/Viewing online:

To view RPM upholstery colors refer to the Surface Finish Library on [knoll.com](http://knoll.com). Physical samples are the best representation of color. To order samples, contact a Knoll sales representative or Knoll dealer.

**Textile Options****KnollTextiles Fabrics and Spinneybeck Leathers**

Please refer to the textile matrices at the beginning of the price list for approved fabrics and leathers.

**COM/COL Textile Requirement**

	fabric yds.	leather sq. ft.
chair	1.4	25

*Cal 133:*

‡ = Cal 133 upholstery available. See textile matrices at the beginning of the price list for pre-approved Cal 133 textiles.

To specify, add C after pattern number and 133 after upholstery code.

Code:	Upchg:	Description:
C()133	\$129	Cal 133 textile

RPM®  
side chair

	pattern no.	description
<i>Designer(s):</i> Dragomir Ivcevic	<b>6A8-(2)-SL</b>	armchair, armcap painted frame
	<b>6C8-(2)-SL</b>	armless, painted frame
<i>Award(s):</i> Arango Design Foundation Exhibit, Refuse: Good Everyday Products from Reused and Recycled Materials, 1995	<b>6RS8</b>	reupholstery assembly



**Order Code**

<i>Example:</i>	<b>6A8-2-SL-SP7</b>
<b>6A8</b>	RPM Side armchair
<b>2</b>	black finish
<b>SL</b>	sled base
<b>SP7</b>	Speedway, Black

**Ordering Information**

<i>Specify:</i>
1. Pattern number.
2. Upholstery selection
<i>Finish color:</i>
Black

pattern no.	grades	COM									COL
	A	B	C	D	E	F	G	H	I	T	U
<b>6A8-(2)-SL</b>	\$582.	\$616.	\$648.	\$672.	\$696.	\$712.	\$734.	\$769.	\$781.	\$1,143.	\$1,176.
<b>6C8-(2)-SL</b>	541.	577.	609.	632.	654.	674.	696.	728.	741.	1,105.	1,138.
<b>6RS8</b>	270.	299.	333.	356.	377.	394.	417.	457.	471.	811.	842.

**KnollTextiles and Spinneybeck Leathers**

Please refer to the textile matrices at the beginning of the price list for approved fabrics and leathers.

**COM/COL Textile Requirement**

	fabric	leather
	yds.	sq. ft.
chair	1.3	17

**Cal 133:**

♣ = Cal 133 upholstery available. See textile matrices at the beginning of the price list for pre-approved Cal 133 textiles.

To specify, add C after pattern number and 133 after upholstery code.

Code:	Upchg:	Description:
C()133	\$99	Cal 133 textile

**RPM Knits**

RPM Knits Speedway and Radial are priced at Grade A for the RPM side chair.

**Construction****Outer shell:**

Integrally colored, textured polypropylene.

**Internal support:**

Cold rolled, mild carbon 14-gauge steel J-Bar.

**Upholstery:**

Integrally colored, textured ABS plastic upholstery liner with molded urethane foam; fabric is permanently bonded to the CFC-free foam.

**Frame:**

Cold rolled mild carbon 12-gauge steel tube with textured epoxy powder coat paint finish.

**Arm caps:**

Integrally colored, textured ABS plastic.

**Glides:**

Black, integrally colored, textured, glass-reinforced nylon.

# RPM® Dimensions and Operating Instructions

	BIFMA G1-2002 Ergonomic Guidelines	RPM Ergonomic Dimensions	
<b>Seat*</b>			
		RPM	RPM High Task
Seat Height	15" - 19.9" minimum range (one or combination of chairs)	15" - 17.75" (low cylinder) 16.5" - 20.5" (medium cylinder) 18.75" - 23.75" (high cylinder)	23.5" - 31.25"
Seat Depth (Fixed)	16.9" or less	17.5" (basic control)	17.5" (basic control)
Seat Depth (Adjustable)	Include 16.9" or less in range	16.5" - 18.5" (advanced control)	16.5" - 18.5" (advanced control)
Seat Width	18" minimum	20.5"	20.5"
Seat Pan Angle (Adjustable)	Include part of 0° - +4° range	-3° - +2° (includes forward tilt)	-3° - +2° (includes forward tilt)
<b>Back*</b>			
Backrest Height	12.2" minimum	21" - 25"	21" - 25"
Backrest Width	14.2" minimum	19"	19"
Lumbar Support (Adjustable)	Include part of 5.9" - 9.8" range	5.9" - 9.9"	5.9" - 9.9"
Angle Between Seat and Back	≥90°, include 10° movement in 90° - 115° range	93° - 118°	93° - 118°
Tilt Range of Back	10° minimum	25°	25°
<b>Arms*</b>			
Armrest Height (Fixed)	In range of 7.9" - 9.8"	8.4" (fixed arm)	8.4" (fixed arm)
Armrest Height (Adjustable)	6.9" - 10.8" minimum range (single or multiple sets of arms)	7.25" - 10.5" (high performance)	7.25" - 10.5" (high performance)
Inside Distance Between Armrests (Adjustable)	Include 18" in range	16.5" - 19" (fixed arm) 17.75" - 19.75" (high performance)	16.5" - 19" (fixed arm) 17.75" - 19.75" (high performance)

\* All measurements taken with BIFMA Chair Measuring Device using the Universal Measurement Procedure which has a measurement uncertainty of ± 5%

## RPM Chair Measurements\*\*

	RPM	RPM High Task	RPM Side
A. Overall Height	37.1" - 45.6" (medium cylinder)	43.75" - 51"	32.5"
B. Overall Width	27"	27"	22"
C. Overall Depth	26.5" (basic control) 25.5" - 26.5" (advanced control)	26.5" (basic control) 25.5" - 26.5" (advanced control)	23.5"
D. Arm Height from Floor	25" - 29.5" (fixed arm) 23.75" - 31.5" (high performance)	25" - 29.5" (fixed arm) 23.75" - 31.5" (high performance)	25"
E. Base Diameter	28"	28"	22.5" wide
Weight	44 lbs.	51 lbs.	28 lbs.

\*\* With arms

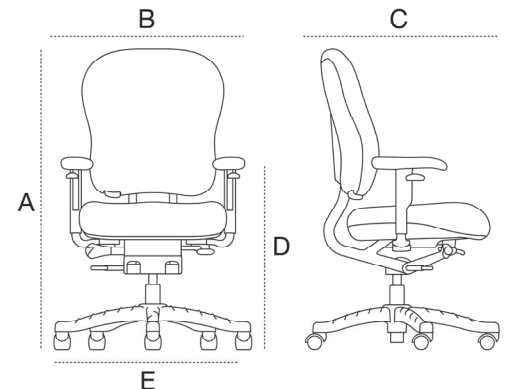

## RPM - Additional Information

High performance arm pads pivot 30° (±15°, 3 fixed positions);  
on advanced control chairs, high performance arms slide 1" in range fore/aft at base of arm

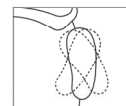

RPM High Task footing measures 20" in diameter and adjusts 9" - 18" in height

RPM Side chair seat is 17.75" from the floor; arms are 7.75" from seat; the inside distance between the arms is 19.9"

Compliance: ANSI/BIFMA X5.1-1993, BIFMA G1-2002 Ergonomic Guidelines, Cal 117, Cal 133 (with approved FR upholstery)



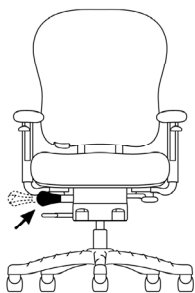

#### Tilt Tension

On the right side of the seat, there is a retractable knob which facilitates the adjustment when the knob is extended. Turn the knob forward to tighten and backward to loosen. When finished, tuck the knob under the seat.

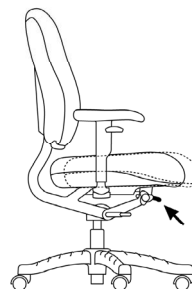

#### Seat Depth

The sliding seat activation is located underneath the seat on the front, left-hand side of the control. The adjustment mechanism is a button that has a space for two fingers. To activate, push up on the button and move the seat forward or backward. There are 4 positions within a 2" range.

*(on Advanced Models only)*

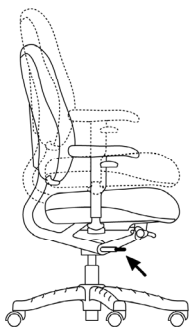

#### Seat Height

While seated, lift the lever on the right side of the chair to lower seat height. Remove your weight from the chair and lift the handle to raise the chair to the highest position.

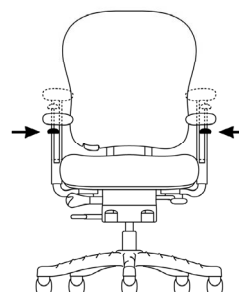

#### High Performance Arms

High Performance arms are controlled by the lever next to the armrest and from the knob beneath the arm support.

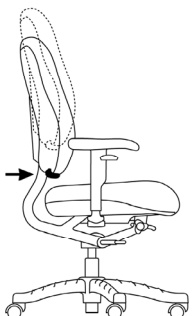

#### Back Height

Press the lever on the bottom of the right side of the back cushion to reposition the back height within a four inch range. It is necessary to press the lever to make the back move.

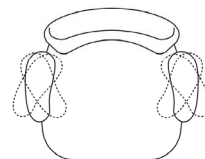

#### Arm Height and Armpad Pivot

Press the lever next to the armpad to adjust the arm height and to set the arm pivot in one of three fixed positions.

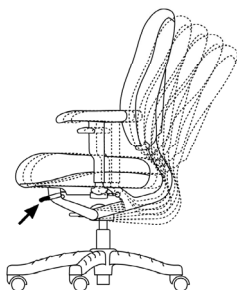

#### Multiple Stop Tilt Lock and Upright Tilt Lock

To lock the chair upright or in a reclined position, lift the lever on the front left side of the chair. Push down on the lever and recline to unlock the chair.

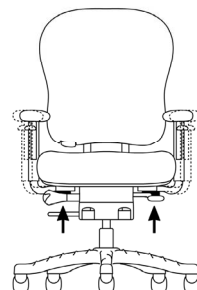

#### Arm Width

Loosen the knob under the arm support to adjust the arm support placement on the chair. There is a 2" total width adjustment for all arms (fixed and height-adjustable)

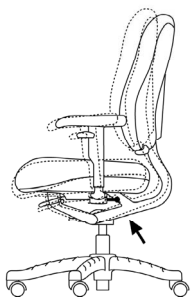

#### Forward Tilt

The forward tilt button is located on the rear, left-hand side of the control—to activate, push the lever in, lift your weight off the seat, and pull up on the rear of the seat to tilt it forward.

# RPM® Control Index and Construction Information

## Control Index

Advanced Control	Features	Explanations
	Synchronized tilt (1:1.9)	Back reclines 1.9 times faster than seat
	Tilt lock (5 positions)	Chair back can be locked in upright and reclined positions
	Forward tilt (3°)	Chair locks in a forward tilting position for intensive keyboarding application
	4" back height adjustment	Allows for correct positioning of lumbar support
	2" seat depth adjustments	Seat adjusts in depth to provide proper support under the legs of both taller and shorter users
	Retractable tension knob	Tension knob is easy to reach and tucks out of the way when not in use
	Instructions	Easy to reach instruction card attached to chair makes adjusting the chair easy for everyone
	Dual J-Bar	Provides additional support for the back
	360° swivel	

Basic Control	Features	Explanations
	Synchronized tilt (1:1.9)	Back reclines 1.9 times faster than seat
	Tilt lock (5 positions)	Chair can be locked in upright and reclined positions
	Forward tilt (3°)	Chair locks in a forward tilting position for intensive keyboarding application
	4" back height adjustment	Allows for correct positioning of lumbar support
	Retractable tension knob	Tension knob is easy to reach and tucks out of the way when not in use
	Instructions	Easy to reach instruction card attached to chair makes adjusting the chair easy for everyone
	Dual J-Bar	Provides additional support for the back
	360° swivel	

RPM Task and High Task Construction Information	Part	Materials
	Outer shells:	Integrally colored, textured polypropylene.
	Seat structure:	Glass-reinforced nylon with steel connectors (for basic control, laminated plywood).
	Back and J-Bar structure:	Glass-reinforced nylon, ABS and steel connector plate.
	Cushions and upholstery:	Insert molded high resilient urethane foam. Back is permanently bonded to CFC free foam. RPM grade covers are knitted to fit the cushion.
	Fixed height arms/high performance arms:	Integrally colored, textured glass-reinforced nylon.
	Armpads:	Molded urethane and steel substructure.
	Base:	Integrally colored, textured, glass-reinforced nylon.
	Casters and glides:	Black, integrally colored, textured nylon.

This page intentionally left blank.





# EWC Pro™

## *upholstered mid-back task chair*

### *synchronized tilt control*

Designer(s):  
Jeffrey Bernett and  
Nicholas Dodziuk, 2005



pattern no.	description
<b>77W-MB-2-SY-NA-5-HC</b>	Upholstered mid-back task chair with plastic outer back, 2.5" back height adjustment, synchronized control, armless
	
<b>77W-MB-2-SY-LA-5-HC</b>	Upholstered mid-back task chair with plastic outer back, 2.5" back height adjustment, synchronized control, loop arms
	
<b>77W-MB-2-SY-FA-5-HC</b>	Upholstered mid-back task chair with plastic outer back, 2.5" back height adjustment, synchronized control, fixed arms
	
<b>77W-MB-2-SY-HA-5-HC</b>	Upholstered mid-back task chair with plastic outer back, 2.5" back height adjustment, synchronized control, height/width adjustable arms
	
<b>U</b>	Upholstered outer back (insert <b>U</b> after <b>MB</b> in the pattern number)

For upholstery options and pricing, see facing page.

Order Code	Ordering Information	Options
<i>Example:</i> <b>77W-MB-2-SY-HA-5-SL-HC K1000/8</b>	<i>Specify:</i> 1. Pattern number 2. Seat and back upholstery	<i>Cylinder Height Option:</i> For low height cylinder (15"-19" seat height range), replace 5 in pattern number with L.
<b>77W</b> EWC Pro task chair	<i>Code:</i> 2 <i>Finish Color:</i> Black	<i>Caster and Glide Options:</i> Substitute HC in pattern with one of the following options: <i>Code: Upchg: Description:</i> SC    n/c    soft black casters for hard surfaces GL    n/c    glides
<b>MB</b> Mid-back		
<b>2</b> Black finish		
<b>SY</b> Synchronized tilt control		
<b>HA</b> Height and width adjustable arms		
<b>5</b> Standard height cylinder		<i>Sliding Seat Option:</i> For sliding seat with 2.75" of depth adjustment insert SL after cylinder choice in pattern number. Adds 0.5" to seat height.
<b>SL</b> Sliding seat		<i>Code: Upchg: Description:</i> SL    \$39    sliding seat
<b>HC</b> Hard wheel black casters		
<b>K1000/8</b> Presto, Red Carpet		

pattern no.	list price Presto base grade	A	COM B	C	D	E	F	G	H	I	T	COL U	V	W	X	Y
<b>77W-MB-2-SY- NA-5-HC</b>	\$616.	\$622.	\$639.	\$663.	\$690.	\$716.	\$746.	\$763.	\$769.	\$787.	\$1,051.	\$1,189.	\$1,319.	\$1,547.	n/a	\$1,759.
<b>77W-MB-2-SY- LA-5-HC</b>	671.	678.	695.	718.	745.	773.	802.	817.	824.	842.	1,108.	1,244.	1,376.	1,605.	n/a	1,816.
<b>77W-MB-2-SY- FA-5-HC</b>	671.	678.	695.	718.	745.	773.	802.	817.	824.	842.	1,108.	1,244.	1,376.	1,605.	n/a	1,816.
<b>77W-MB-2-SY- HA-5-HC</b>	700.	707.	724.	747.	775.	801.	830.	846.	853.	872.	1,136.	1,274.	1,405.	1,634.	n/a	1,845.
<b>U</b>	72.	74.	82.	91.	102.	112.	123.	131.	133.	141.	244.	298.	351.	442.	n/a	526.

**Presto - Base Grade Fabric***Color options:*

Presto Winter White K1000/1  
Presto Sand K1000/2  
Presto Stone K1000/3  
Presto Saffron K1000/4  
Presto Spring Green K1000/5  
Presto Blue Chip K1000/6  
Presto Scarlet K1000/7  
Presto Red Carpet K1000/8  
Presto Beige Taupe K1000/9  
Presto Olive K1000/10  
Presto Navy Blue K1000/11  
Presto Clear Gray K1000/12  
Presto Charcoal Gray K1000/13  
Presto Black Tie K1000/14

*For split seat and back upholstery,  
indicate the words "seat" and "back"  
before the selected color.*

**COM/COL Upholstery Requirements**

Textile yardage required: 2 yards  
Leather sq. ft. required: 28 sq. ft.  
Outer back shell: .8 yards or 12 sq. ft.

*Split Upholstery Option:*

EWC Pro seats and backs can be upholstered in any two approved KnollTextiles or Spinneybeck upholsteries. To specify, first indicate the seat upholstery (labeled "seat upholstery") and then indicate the back upholstery (labeled "back upholstery"). The list price of the chair equals the list price of the higher of the two upholstery grades.





*CAL 133 Options:*

<i>Code:</i>	<i>Upchg:</i>	<i>Description:</i>
C133	\$78	CAL 133 textile on seat and back. No additional upcharge for upholstered outer back (add C133 to the end of the pattern number)

**EWC Pro™**  
*upholstered mid-back task chair*  
*swivel tilt control*

*Designer(s):*  
 Jeffrey Bernett and  
 Nicholas Dodziuk, 2005



pattern no.	description
<b>77W-MB-2-ST-NA-5-HC</b>	Upholstered mid-back task chair with plastic outer back, 2.5" back height adjustment, swivel-tilt control, armless
	
<b>77W-MB-2-ST-LA-5-HC</b>	Upholstered mid-back task chair with plastic outer back, 2.5" back height adjustment, swivel-tilt control, loop arms
	
<b>77W-MB-2-ST-FA-5-HC</b>	Upholstered mid-back task chair with plastic outer back, 2.5" back height adjustment, swivel-tilt control, fixed arms
	
<b>77W-MB-2-ST-HA-5-HC</b>	Upholstered mid-back task chair with plastic outer back, 2.5" back height adjustment, swivel-tilt control, height/width adjustable arms
	
<b>U</b>	Upholstered outer back (insert <b>U</b> after <b>MB</b> in the pattern number)

For upholstery options and pricing, see facing page.

Order Code	Ordering Information	Options
<i>Example:</i> <b>77W-MB-2-ST-HA-5-SL-HC K1000/8</b>	<i>Specify:</i> 1. Pattern number 2. Seat and back upholstery	<i>Cylinder Height Option:</i> For low height cylinder (15"-19" seat height range), replace 5 in pattern number with L.
<b>77W</b> EWC Pro task chair	<i>Code:</i> <b>2</b> <i>Finish Color:</i> Black	<i>Code: Upchg: Description:</i> L \$71 low cylinder
<b>MB</b> Mid-back		<i>Sliding Seat Option:</i> For sliding seat with 2.75" of depth adjustment insert SL after cylinder choice in pattern number. Adds 0.5" to seat height.
<b>2</b> Black finish		<i>Code: Upchg: Description:</i> SL \$39 sliding seat
<b>ST</b> Swivel tilt control		<i>Caster and Glide Options:</i> Substitute HC in pattern with one of the following options: <i>Code: Upchg: Description:</i> SC n/c soft black casters for hard surfaces GL n/c glides
<b>HA</b> Height and width adjustable arms		
<b>5</b> Standard height cylinder		
<b>SL</b> Sliding seat		
<b>HC</b> Hard wheel black casters		
<b>K1000/8</b> Presto, Red Carpet		

pattern no.	list price Presto base grade	A	COM B	C	D	E	F	G	H	I	T	COL U	V	W	X	Y
<b>77W-MB-2-ST-NA-5-HC</b>	\$517.	\$524.	\$542.	\$567.	\$593.	\$620.	\$650.	\$666.	\$673.	\$692.	\$957.	\$1,097.	\$1,229.	\$1,461.	n/a	\$1,676.
<b>77W-MB-2-ST-LA-5-HC</b>	574.	580.	598.	622.	649.	677.	706.	722.	728.	748.	1,015.	1,152.	1,288.	1,519.	n/a	1,734.
<b>77W-MB-2-ST-FA-5-HC</b>	574.	580.	598.	622.	649.	677.	706.	722.	728.	748.	1,015.	1,152.	1,288.	1,519.	n/a	1,734.
<b>77W-MB-2-ST-HA-5-HC</b>	603.	610.	628.	651.	679.	705.	736.	751.	759.	778.	1,044.	1,183.	1,317.	1,549.	n/a	1,763.
<b>U</b>	72.	74.	82.	91.	102.	112.	123.	131.	133.	141.	244.	298.	351.	442.	n/a	526.

**Presto - Base Grade Fabric***Color options:*

Presto Winter White K1000/1  
Presto Sand K1000/2  
Presto Stone K1000/3  
Presto Saffron K1000/4  
Presto Spring Green K1000/5  
Presto Blue Chip K1000/6  
Presto Scarlet K1000/7  
Presto Red Carpet K1000/8  
Presto Beige Taupe K1000/9  
Presto Olive K1000/10  
Presto Navy Blue K1000/11  
Presto Clear Gray K1000/12  
Presto Charcoal Gray K1000/13  
Presto Black Tie K1000/14

*For split seat and back upholstery, indicate the words "seat" and "back" before the selected color.*

**COM/COL Upholstery Requirements**

Textile yardage required: 2 yards  
Leather sq. ft. required: 28 sq. ft.  
Outer back shell: .8 yards or 12 sq. ft.

*Split Upholstery Option:*

EWC Pro seats and backs can be upholstered in any two approved KnollTextiles or Spinneybeck upholsteries. To specify, first indicate the seat upholstery (labeled "seat upholstery") and then indicate the back upholstery (labeled "back upholstery"). The list price of the chair equals the list price of the higher of the two upholstery grades.

*CAL 133 Options:*

<i>Code:</i>	<i>Upchg:</i>	<i>Description:</i>
C133	\$78	CAL 133 textile on seat and back. No additional upcharge for upholstered outer back (add C133 to the end of the pattern number)

# EWC Pro™

## *upholstered mid-back conference chair synchronized tilt control*

Designer(s):  
Jeffrey Bernett and  
Nicholas Dodziuk, 2007



pattern no.	description
<b>77C-MB-2-SY-LA-5-HC</b>	Upholstered mid-back conference chair with plastic outer back, fixed back height, synchronized control, loop arms
<b>U</b>	Upholstered outer back (insert <b>U</b> after <b>MB</b> in the pattern number)



For upholstery options and pricing, see facing page.

Order Code	Ordering Information	Options
<i>Example:</i> <b>77C-MB-2-SY-LA-5-SL-HC</b> <b>K1000/8</b>	<i>Specify:</i> 1. Pattern number 2. Seat and back upholstery	<i>Cylinder Height Option:</i> For low height cylinder (15"-19" seat height range), replace 5 in pattern number with L.
<b>77C</b> EWC Pro conference chair	<i>Code:</i> 2	<i>Code: Upchg: Description:</i> L \$71 low cylinder
<b>MB</b> Mid-back	<i>Finish Color:</i> Black	<i>Caster and Glide Options:</i> Substitute HC in pattern with one of the following options: <i>Code: Upchg: Description:</i> SC n/c soft black casters for hard surfaces GL n/c glides
<b>2</b> Black finish		
<b>SY</b> Synchronized tilt control		
<b>LA</b> Loop width adjustable arms		
<b>5</b> Standard height cylinder		
<b>SL</b> Sliding seat		<i>Sliding Seat Option:</i> For sliding seat with 2.75" of depth adjustment insert SL after cylinder choice in pattern number. Adds 0.5" to seat height.
<b>HC</b> Hard wheel black casters		<i>Code: Upchg: Description:</i> SL \$39 sliding seat
<b>K1000/8</b> Presto, Red Carpet		



pattern no.	list price Presto base grade	A	COM B	C	D	E	F	G	H	I	T	COL U	V	W	X	Y
<b>77C-MB-2-SY- LA-5-HC</b>	\$666.	\$673.	\$690.	\$713.	\$740.	\$767.	\$797.	\$812.	\$818.	\$837.	\$1,103.	\$1,238.	\$1,371.	\$1,600.	n/a	\$1,811.
<b>U</b>	72.	74.	82.	91.	102.	112.	123.	131.	133.	141.	244.	298.	351.	442.	n/a	526.

### Presto - Base Grade Fabrics

#### Color options:

Presto Winter White K1000/1  
Presto Sand K1000/2  
Presto Stone K1000/3  
Presto Saffron K1000/4  
Presto Spring Green K1000/5  
Presto Blue Chip K1000/6  
Presto Scarlet K1000/7  
Presto Red Carpet K1000/8  
Presto Beige Taupe K1000/9  
Presto Olive K1000/10  
Presto Navy Blue K1000/11  
Presto Clear Gray K1000/12  
Presto Charcoal Gray K1000/13  
Presto Black Tie K1000/14

*For split seat and back upholstery,  
indicate the words "seat" and "back"  
before the selected color.*

#### **COM/COL Upholstery Requirements**

Textile yardage required: 2 yards  
Leather sq. ft. required: 28 sq. ft.  
Outer back shell: .8 yards or 12 sq. ft.

#### Split Upholstery Option:

EWC Pro seats and backs can be upholstered in any two approved KnollTextiles or Spinneybeck upholsteries. To specify, first indicate the seat upholstery (labeled "seat upholstery") and then indicate the back upholstery (labeled "back upholstery"). The list price of the chair equals the list price of the higher of the two upholstery grades.

#### CAL 133 Options:

Code:	Upchg:	Description:
C133	\$78	CAL 133 textile on seat and back. No additional upcharge for upholstered outer back (add C133 to the end of the pattern number)

EWC Pro™  
*upholstered mid-back conference chair*  
*swivel tilt control*

Designer(s):  
 Jeffrey Bernett and  
 Nicholas Dodziuk, 2007



pattern no.	description
<b>77C-MB-2-ST-LA-5-HC</b>	Upholstered mid-back conference chair with plastic outer back, fixed back height, swivel-tilt control, loop arms
<b>U</b>	Upholstered outer back (insert <b>U</b> after <b>MB</b> in the pattern number)



For upholstery options and pricing, see facing page.

Order Code	Ordering Information	Options
<i>Example:</i> <b>77C-MB-2-ST-LA-5-SL-HC K1000/8</b>	<i>Specify:</i> 1. Pattern number 2. Seat and back upholstery  <i>Code:</i> <i>Finish Color:</i> 2              Black	<i>Cylinder Height Option:</i>  For low height cylinder (15"-19" seat height range), replace 5 in pattern number with L.  <i>Code: Upchg: Description:</i> L    \$71    low cylinder
<b>77C</b> EWC Pro conference chair		<i>Caster and Glide Options:</i>  Substitute HC in pattern with one of the following options:  <i>Code: Upchg: Description:</i> SC    n/c    soft black casters for hard surfaces GL    n/c    glides
<b>MB</b> Mid-back		
<b>2</b> Black finish		
<b>ST</b> Swivel tilt control		
<b>LA</b> Loop width adjustable arms		
<b>5</b> Standard height cylinder		
<b>SL</b> Sliding seat		<i>Sliding Seat Option:</i>  For sliding seat with 2.75" of depth adjustment insert SL after cylinder choice in pattern number. Adds 0.5" to seat height.  <i>Code: Upchg: Description:</i> SL    \$39    sliding seat
<b>HC</b> Hard wheel black casters		
<b>K1000/8</b> Presto Red Carpet		

pattern no.	list price Presto base grade	A	COM B	C	D	E	F	G	H	I	T	COL U	V	W	X	Y
<b>77C-MB-2-ST- LA-5-HC</b>	\$569.	\$575.	\$593.	\$617.	\$643.	\$671.	\$701.	\$717.	\$723.	\$742.	\$1,010.	\$1,147.	\$1,282.	\$1,513.	n/a	\$1,729.
<b>U</b>	72.	74.	82.	91.	102.	112.	123.	131.	133.	141.	244.	298.	351.	442.	n/a	526.

### Presto - Base Grade Fabrics

#### Color options:

Presto Winter White K1000/1  
Presto Sand K1000/2  
Presto Stone K1000/3  
Presto Saffron K1000/4  
Presto Spring Green K1000/5  
Presto Blue Chip K1000/6  
Presto Scarlet K1000/7  
Presto Red Carpet K1000/8  
Presto Beige Taupe K1000/9  
Presto Olive K1000/10  
Presto Navy Blue K1000/11  
Presto Clear Gray K1000/12  
Presto Charcoal Gray K1000/13  
Presto Black Tie K1000/14

*For split seat and back upholstery,  
indicate the words "seat" and "back"  
before the selected color.*

#### COM/COL Upholstery Requirements

Textile yardage required: 2 yards  
Leather sq. ft. required: 28 sq. ft.  
Outer back shell: .8 yards or 12 sq. ft.

#### Split Upholstery Option:

EWC Pro seats and backs can be upholstered in any two approved KnollTextiles or Spinneybeck upholsteries. To specify, first indicate the seat upholstery (labeled "seat upholstery") and then indicate the back upholstery (labeled "back upholstery"). The list price of the chair equals the list price of the higher of the two upholstery grades.

#### CAL 133 Options:

Code:	Upchg:	Description:
C133	\$78	CAL 133 textile on seat and back. No additional upcharge for upholstered outer back (add C133 to the end of the pattern number)





# EWC Pro™

## *upholstered high-back task chair*

### *synchronized tilt control*

Designer(s):  
Jeffrey Bernett and  
Nicholas Dodziuk, 2005



pattern no.	description
<b>77W-HB-2-SY-NA-5-HC</b>	Upholstered high-back task chair with plastic outer back, 2.5" back height adjustment, synchronized control, armless
	
<b>77W-HB-2-SY-LA-5-HC</b>	Upholstered high-back task chair with plastic outer back, 2.5" back height adjustment, synchronized control, loop arms
	
<b>77W-HB-2-SY-FA-5-HC</b>	Upholstered high-back task chair with plastic outer back, 2.5" back height adjustment, synchronized control, fixed arms
	
<b>77W-HB-2-SY-HA-5-HC</b>	Upholstered high-back task chair with plastic outer back, 2.5" back height adjustment, synchronized control, height/width adjustable arms
	
<b>U</b>	Upholstered outer back (insert <b>U</b> after <b>HB</b> in the pattern number)

For upholstery options and pricing, see facing page.

Order Code	Ordering Information	Options
<i>Example:</i> <b>77W-HB-2-SY-HA-5-SL-HC K1000/8</b>	<i>Specify:</i>	<i>Cylinder Height Option:</i>
<b>77W</b> EWC Pro task chair	1. Pattern number	For low height cylinder (15"-19" seat height range), replace 5 in pattern number with L.
<b>HB</b> High-back	2. Seat and back upholstery	<i>Caster and Glide Options:</i>
<b>2</b> Black finish	<i>Code:</i> <i>Finish Color:</i>	Substitute HC in pattern with one of the following options:
<b>SY</b> Synchronized tilt control	2 Black	<i>Code: Upchg: Description:</i>
<b>HA</b> Height and width adjustable arms		SC n/c soft black casters for hard surfaces
<b>5</b> Standard height cylinder		GL n/c glides
<b>SL</b> Sliding seat		<i>Sliding Seat Option:</i>
<b>HC</b> Hard wheel black casters		For sliding seat with 2.75" of depth adjustment insert SL after cylinder choice in pattern number. Adds 0.5" to seat height.
<b>K1000/8</b> Presto, Red Carpet		<i>Code: Upchg: Description:</i>
		SL \$39 sliding seat

pattern no.	list price Presto base grade	A	COM B	C	D	E	F	G	H	I	T	COL U	V	W	X	Y
<b>77W-HB-2-SY- NA-5-HC</b>	\$671.	\$681.	\$703.	\$729.	\$763.	\$793.	\$829.	\$847.	\$855.	\$878.	\$1,164.	\$1,317.	\$1,466.	\$1,722.	n/a	\$1,963.
<b>77W-HB-2-SY- LA-5-HC</b>	726.	737.	756.	785.	817.	848.	886.	902.	910.	933.	1,221.	1,374.	1,523.	1,779.	n/a	2,020.
<b>77W-HB-2-SY- FA-5-HC</b>	726.	737.	756.	785.	817.	848.	886.	902.	910.	933.	1,221.	1,374.	1,523.	1,779.	n/a	2,020.
<b>77W-HB-2-SY- HA-5-HC</b>	754.	766.	786.	814.	846.	877.	914.	931.	938.	963.	1,249.	1,402.	1,551.	1,809.	n/a	2,049.
<b>U</b>	72.	77.	84.	97.	110.	121.	138.	144.	147.	157.	271.	334.	396.	500.	n/a	598.

**Presto - Base Grade Fabric***Color options:*

Presto Winter White K1000/1  
Presto Sand K1000/2  
Presto Stone K1000/3  
Presto Saffron K1000/4  
Presto Spring Green K1000/5  
Presto Blue Chip K1000/6  
Presto Scarlet K1000/7  
Presto Red Carpet K1000/8  
Presto Beige Taupe K1000/9  
Presto Olive K1000/10  
Presto Navy Blue K1000/11  
Presto Clear Gray K1000/12  
Presto Charcoal Gray K1000/13  
Presto Black Tie K1000/14

*For split seat and back upholstery,  
indicate the words "seat" and "back"  
before the selected color.*

**COM/COL Upholstery Requirements**

Textile yardage required: 2.2 yards  
Leather sq. ft. required: 31 sq. ft.  
Outer back shell: .9 yards or 13.5 sq. ft.

*Split Upholstery Option:*

EWC Pro seats and backs can be upholstered in any two approved KnollTextiles or Spinneybeck upholsteries. To specify, first indicate the seat upholstery (labeled "seat upholstery") and then indicate the back upholstery (labeled "back upholstery"). The list price of the chair equals the list price of the higher of the two upholstery grades.

*CAL 133 Options:*

Code:	Upchg:	Description:
C133	\$78	CAL 133 textile on seat and back. No additional upcharge for upholstered outer back (add C133 to the end of the pattern number)





# EWC Pro™

## upholstered high-back task chair

### swivel tilt control

Designer(s):  
Jeffrey Bernett and  
Nicholas Dodziuk, 2005



pattern no.	description
<b>77W-HB-2-ST-NA-5-HC</b>	Upholstered high-back task chair with plastic outer back, 2.5" back height adjustment, swivel-tilt control, armless
	
<b>77W-HB-2-ST-LA-5-HC</b>	Upholstered high-back task chair with plastic outer back, 2.5" back height adjustment, swivel-tilt control, loop arms
	
<b>77W-HB-2-ST-FA-5-HC</b>	Upholstered high-back task chair with plastic outer back, 2.5" back height adjustment, swivel-tilt control, fixed arms
	
<b>77W-HB-2-ST-HA-5-HC</b>	Upholstered high-back task chair with plastic outer back, 2.5" back height adjustment, swivel-tilt control, height/width adjustable arms
	
<b>U</b>	Upholstered outer back (insert <b>U</b> after <b>HB</b> in the pattern number)

For upholstery options and pricing, see facing page.

Order Code	Ordering Information	Options
<i>Example:</i> <b>77W-HB-2-ST-HA-5-SL-HC VOBLK</b>	<i>Specify:</i> 1. Pattern number 2. Seat and back upholstery	<i>Cylinder Height Option:</i> For low height cylinder (15"-19" seat height range), replace 5 in pattern number with L.
<b>77W</b> EWC Pro task chair	<i>Code:</i> 2	<i>Code: Upchg: Description:</i> L \$71 low cylinder
<b>HB</b> High-back	<i>Finish Color:</i> Black	<i>Sliding Seat Option:</i> For sliding seat with 2.75" of depth adjustment insert SL after cylinder choice in pattern number. Adds 0.5" to seat height.
<b>2</b> Black finish		<i>Code: Upchg: Description:</i> SL \$39 sliding seat
<b>ST</b> Swivel tilt control		<i>Caster and Glide Options:</i> Substitute HC in pattern with one of the following options: <i>Code: Upchg: Description:</i> SC n/c soft black casters for hard surfaces GL n/c glides
<b>HA</b> Height and width adjustable arms		
<b>5</b> Standard height cylinder		
<b>SL</b> Sliding seat		
<b>HC</b> Hard wheel black casters		
<b>VOBLK</b> Volo black Spinneybeck leather		

pattern no.	list price Presto base grade	A	COM B	C	D	E	F	G	H	I	T	COL U	V	W	X	Y
<b>77W-HB-2-ST-NA-5-HC</b>	\$574.	\$585.	\$606.	\$633.	\$666.	\$698.	\$735.	\$753.	\$761.	\$785.	\$1,073.	\$1,227.	\$1,378.	\$1,638.	n/a	\$1,883.
<b>77W-HB-2-ST-LA-5-HC</b>	630.	640.	662.	690.	722.	754.	791.	809.	817.	840.	1,130.	1,286.	1,436.	1,697.	n/a	1,941.
<b>77W-HB-2-ST-FA-5-HC</b>	630.	640.	662.	690.	722.	754.	791.	809.	817.	840.	1,130.	1,286.	1,436.	1,697.	n/a	1,941.
<b>77W-HB-2-ST-HA-5-HC</b>	660.	670.	691.	719.	751.	784.	821.	838.	846.	870.	1,158.	1,315.	1,465.	1,725.	n/a	1,970.
<b>U</b>	72.	77.	84.	97.	110.	121.	138.	144.	147.	157.	271.	334.	396.	500.	n/a	598.

**Presto - Base Grade Fabric***Color options:*

Presto Winter White K1000/1  
Presto Sand K1000/2  
Presto Stone K1000/3  
Presto Saffron K1000/4  
Presto Spring Green K1000/5  
Presto Blue Chip K1000/6  
Presto Scarlet K1000/7  
Presto Red Carpet K1000/8  
Presto Beige Taupe K1000/9  
Presto Olive K1000/10  
Presto Navy Blue K1000/11  
Presto Clear Gray K1000/12  
Presto Charcoal Gray K1000/13  
Presto Black Tie K1000/14

*For split seat and back upholstery, indicate the words "seat" and "back" before the selected color.*

**COM/COL Upholstery Requirements**

Textile yardage required: 2.2 yards  
Leather sq. ft. required: 31 sq. ft.  
Outer back shell: .9 yards or 13.5 sq. ft.

*Split Upholstery Option:*

EWC Pro seats and backs can be upholstered in any two approved KnollTextiles or Spinneybeck upholsteries. To specify, first indicate the seat upholstery (labeled "seat upholstery") and then indicate the back upholstery (labeled "back upholstery"). The list price of the chair equals the list price of the higher of the two upholstery grades.

*CAL 133 Options:*

Code:	Upchg:	Description:
C133	\$78	CAL 133 textile on seat and back. No additional upcharge for upholstered outer back (add C133 to the end of the pattern number)

**EWC Pro™**  
*upholstered high-back conference chair*  
*synchronized tilt control*

Designer(s):  
 Jeffrey Bennett and  
 Nicholas Dodziuk, 2007



pattern no.	description
<b>77C-HB-2-SY-LA-5-HC</b>	Upholstered high-back conference chair with plastic outer back, fixed back height, synchronized control, loop arms
<b>U</b>	Upholstered outer back (insert <b>U</b> after <b>HB</b> in the pattern number)



For upholstery options and pricing, see facing page.

Order Code	Ordering Information	Options
<i>Example:</i> <b>77C-HB-2-SY-LA-5-SL-HC</b> <b>K1000/8</b>	<i>Specify:</i> 1. Pattern number 2. Seat and back upholstery	<i>Cylinder Height Option:</i> For low height cylinder (15"-19" seat height range), replace 5 in pattern number with L.
<b>77C</b> EWC Pro conference chair	<i>Code:</i> 2	<i>Code: Upchg: Description:</i> L \$71 low cylinder
<b>HB</b> High-back	<i>Finish Color:</i> Black	<i>Caster and Glide Options:</i> Substitute HC in pattern with one of the following options: <i>Code: Upchg: Description:</i> SC n/c soft black casters for hard surfaces GL n/c glides
<b>2</b> Black finish		
<b>SY</b> Synchronized tilt control		
<b>LA</b> Loop width adjustable arms		
<b>5</b> Standard height cylinder		
<b>SL</b> Sliding seat		<i>Sliding Seat Option:</i> For sliding seat with 2.75" of depth adjustment insert SL after cylinder choice in pattern number. Adds 0.5" to seat height.
<b>HC</b> Hard wheel black casters		<i>Code: Upchg: Description:</i> SL \$39 sliding seat
<b>K1000/8</b> Presto, Red Carpet		



pattern no.	list price Presto base grade	A	COM B	C	D	E	F	G	H	I	T	COL U	V	W	X	Y
<b>77C-HB-2-SY- LA-5-HC</b>	\$721.	\$730.	\$751.	\$780.	\$812.	\$842.	\$880.	\$897.	\$905.	\$928.	\$1,215.	\$1,369.	\$1,517.	\$1,773.	n/a	\$2,013.

<b>U</b>	72.	77.	84.	97.	110.	121.	138.	144.	147.	157.	271.	334.	396.	500.	n/a	598.
----------	-----	-----	-----	-----	------	------	------	------	------	------	------	------	------	------	-----	------

### Presto - Base Grade Fabric

#### Color options:

Presto Winter White K1000/1  
Presto Sand K1000/2  
Presto Stone K1000/3  
Presto Saffron K1000/4  
Presto Spring Green K1000/5  
Presto Blue Chip K1000/6  
Presto Scarlet K1000/7  
Presto Red Carpet K1000/8  
Presto Beige Taupe K1000/9  
Presto Olive K1000/10  
Presto Navy Blue K1000/11  
Presto Clear Gray K1000/12  
Presto Charcoal Gray K1000/13  
Presto Black Tie K1000/14

For split seat and back upholstery,  
indicate the words "seat" and "back"  
before the selected color.

#### COM/COL Upholstery Requirements

Textile yardage required: 2.2 yards  
Leather sq. ft. required: 31 sq. ft.  
Outer back shell: .9 yards or 13.5 sq. ft.

#### Split Upholstery Option:

EWC Pro seats and backs can be upholstered in any two approved KnollTextiles or Spinneybeck upholsteries. To specify, first indicate the seat upholstery (labeled "seat upholstery") and then indicate the back upholstery (labeled "back upholstery"). The list price of the chair equals the list price of the higher of the two upholstery grades.

#### CAL 133 Options:

Code:	Upchg:	Description:
C133	\$78	CAL 133 textile on seat and back. No additional upcharge for upholstered outer back (add C133 to the end of the pattern number)

**EWC Pro™**  
*upholstered high-back conference chair*  
*swivel tilt control*

*Designer(s):*  
 Jeffrey Bernett and  
 Nicholas Dodziuk, 2007



pattern no.	description
<b>77C-HB-2-ST-LA-5-HC</b>	Upholstered high-back conference chair with plastic outer back, fixed back height, swivel-tilt control, loop arms
<b>U</b>	Upholstered outer back (insert <b>U</b> after <b>HB</b> in the pattern number)



For upholstery options and pricing, see facing page.

Order Code	Ordering Information	Options
<i>Example:</i> <b>77C-HB-2-ST-LA-5-SL-HC</b> <b>VOBLK</b>	<i>Specify:</i> 1. Pattern number 2. Seat and back upholstery	<i>Cylinder Height Option:</i> For low height cylinder (15"-19" seat height range), replace 5 in pattern number with L.
<b>77C</b> EWC Pro conference chair	<i>Code:</i> 2 <i>Finish Color:</i> Black	<i>Code: Upchg: Description:</i> L    \$71    low cylinder
<b>HB</b> High-back		<i>Sliding Seat Option:</i> For sliding seat with 2.75" of depth adjustment insert SL after cylinder choice in pattern number. Adds 0.5" to seat height.
<b>2</b> Black finish		<i>Code: Upchg: Description:</i> SL    \$39    sliding seat
<b>ST</b> Swivel tilt control		<i>Caster and Glide Options:</i> Substitute HC in pattern with one of the following options: <i>Code: Upchg: Description:</i> SC    n/c    soft black casters for hard surfaces GL    n/c    glides
<b>LA</b> Loop width adjustable arms		
<b>5</b> Standard height cylinder		
<b>SL</b> Sliding seat		
<b>HC</b> Hard wheel black casters		
<b>VOBLK</b> Volo black Spinneybeck leather		

pattern no.	list price Presto base grade	A	COM B	C	D	E	F	G	H	I	T	COL U	V	W	X	Y
<b>77C-HB-2-ST- LA-5-HC</b>	\$624.	\$634.	\$657.	\$684.	\$717.	\$748.	\$786.	\$804.	\$811.	\$834.	\$1,124.	\$1,280.	\$1,430.	\$1,692.	n/a	\$1,934.
<b>U</b>	72.	77.	84.	97.	110.	121.	138.	144.	147.	157.	271.	334.	396.	500.	n/a	598.

**Presto - Base Grade Fabric**

*Color options:*

- Presto Winter White K1000/1
- Presto Sand K1000/2
- Presto Stone K1000/3
- Presto Saffron K1000/4
- Presto Spring Green K1000/5
- Presto Blue Chip K1000/6
- Presto Scarlet K1000/7
- Presto Red Carpet K1000/8
- Presto Beige Taupe K1000/9
- Presto Olive K1000/10
- Presto Navy Blue K1000/11
- Presto Clear Gray K1000/12
- Presto Charcoal Gray K1000/13
- Presto Black Tie K1000/14

*For split seat and back upholstery, indicate the words "seat" and "back" before the selected color.*

**COM/COL Upholstery Requirements**

- Textile yardage required: 2.2 yards
- Leather sq. ft. required: 31 sq. ft.
- Outer back shell: .9 yards or 13.5 sq. ft.

*Split Upholstery Option:*



EWC Pro seats and backs can be upholstered in any two approved KnollTextiles or Spinneybeck upholsteries. To specify, first indicate the seat upholstery (labeled "seat upholstery") and then indicate the back upholstery (labeled "back upholstery"). The list price of the chair equals the list price of the higher of the two upholstery grades.

*CAL 133 Options:*

Code:	Upchg:	Description:
C133	\$78	CAL 133 textile on seat and back. No additional upcharge for upholstered outer back (add C133 to the end of the pattern number)

# EWC Pro™

## *upholstered side chair*

	pattern no.	description
<p><i>Designer(s):</i> Jeffrey Bennett and Nicholas Dodziuk, 2005</p> 	<b>77S-2-FA-HC</b>	Upholstered side chair with plastic outer back, fixed arms
		
	<b>77S-2-NA-HC</b>	Upholstered side chair with plastic outer back, armless
		
	<b>U</b>	Upholstered outer back (insert <b>U</b> after <b>S</b> in the pattern number)

For upholstery options and pricing, see facing page.

Order Code	Ordering Information	Options
<i>Example:</i> <b>77S-2-FA-HC K1000/10</b>	<i>Specify:</i>	<i>Caster and Glide Options:</i>
<b>77S</b> EWC Pro side chair	1. Pattern number	Substitute HC in pattern with one of the following options:
<b>2</b> Black finish	2. Seat and back upholstery	
<b>FA</b> Fixed arms	<i>Code:</i> <i>Finish Color:</i>	<i>Code: Upchg: Description:</i>
<b>HC</b> Hard wheel black casters	2 Black	SC n/c soft black casters for hard surfaces
<b>K1000/10</b> Presto Olive		GL n/c glides

pattern no.	list price Presto base grade	A	COM B	C	D	E	F	G	H	I	T	COL U	V	W	X	Y
<b>77S-2-FA-HC</b>	\$384.	\$388.	\$404.	\$425.	\$448.	\$473.	\$500.	\$513.	\$520.	\$536.	\$803.	\$933.	\$1,062.	\$1,281.	n/a	\$1,485.
<b>77S-2-NA-HC</b>	356.	361.	377.	399.	423.	447.	476.	489.	496.	514.	788.	924.	1,056.	1,284.	n/a	1,493.
<b>U</b>	49.	51.	59.	65.	72.	80.	88.	93.	97.	102.	188.	230.	273.	344.	n/a	412.

### Presto - Base Grade Fabric

#### Color options:

Presto Winter White K1000/1  
Presto Sand K1000/2  
Presto Stone K1000/3  
Presto Saffron K1000/4  
Presto Spring Green K1000/5  
Presto Blue Chip K1000/6  
Presto Scarlet K1000/7  
Presto Red Carpet K1000/8  
Presto Beige Taupe K1000/9  
Presto Olive K1000/10  
Presto Navy Blue K1000/11  
Presto Clear Gray K1000/12  
Presto Charcoal Gray K1000/13  
Presto Black Tie K1000/14

For split seat and back upholstery,  
indicate the words "seat" and "back"  
before the selected color.

#### COM/COL Upholstery Requirements

Textile yardage required: 1.8 yards  
Leather sq. ft. required: 25 sq. ft.  
Outer back shell: .6 yards or 9 sq. ft.

#### Split Upholstery Option:

EWC Pro seats and backs can be upholstered in any two approved KnollTextiles or Spinneybeck upholsteries. To specify, first indicate the seat upholstery (labeled "seat upholstery") and then indicate the back upholstery (labeled "back upholstery"). The list price of the chair equals the list price of the higher of the two upholstery grades.

#### CAL 133 Options:

Code:	Upchg:	Description:
C133	\$56	CAL 133 textile on seat and back. No additional upcharge for upholstered outer back (add C133 to the end of the pattern number)

# EWC Pro™

## seat and back replacements for task, conference and side chairs

	pattern no.	description
<p><i>Designer(s):</i> Jeffrey Bernett and Nicholas Dodziuk, 2007</p> 	<b>ESSENWORK-SEAT</b>	Replacement upholstered seat for EWC Pro and EWC Tech task and conference chair
	<b>77WMIDBACK</b>	Replacement upholstered EWC Pro Task Midback with plastic outer back and 2.5" back height adjustment
	<b>77WUMIDBACK</b>	Replacement upholstered EWC Pro Task Midback with upholstered outer back and 2.5" back height adjustment
	<b>77CMIDBACK</b>	Replacement upholstered EWC Pro Conference Midback with plastic outer back and fixed back height
	<b>77CUMIDBACK</b>	Replacement upholstered EWC Pro Conference Midback with upholstered outer back and fixed back height
	<b>77WHIGHBACK</b>	Replacement upholstered EWC Pro Task Highback with plastic outer back and 2.5" back height adjustment
	<b>77WUHIGHBACK</b>	Replacement upholstered EWC Pro Task Highback with upholstered outer back and 2.5" back height adjustment
	<b>77CHIGHBACK</b>	Replacement upholstered EWC Pro Conference Highback with plastic outer back and fixed back height
	<b>77CUHIGHBACK</b>	Replacement upholstered EWC Pro Conference Highback with upholstered outer back and fixed back height
	<b>ESSENSIDESEAT</b>	Replacement upholstered seat for EWC Pro and EWC Tech side chair
	<b>77SBACK</b>	Replacement upholstered EWC Pro Side back with plastic outer back
	<b>77SUBACK</b>	Replacement upholstered EWC Pro Side back with upholstered outer back

For upholstery options and pricing, see facing page.

Order Code	Ordering Information	Presto - Base Grade Fabric	Options
<i>Example:</i> <b>ESSENWORKSEAT - K1000/8</b>	<i>Specify:</i>	<i>Color options:</i>	<i>CAL 133 Options:</i>
<b>ESSENWORKSEAT</b> Upholstered seat replacement	1. Pattern number	Presto Winter White K1000/1	<i>Code: Upchg: Description:</i>
<b>K1000/8</b> Presto, Red Carpet	2. Textile	Presto Sand K1000/2	C133 \$50 CAL 133 textile on seat. (add C133 to the end of the pattern number)
	<b>COM/COL Upholstery Requirements</b>	Presto Stone K1000/3	
	See yardage requirements on respective price list pages.	Presto Saffron K1000/4	
		Presto Spring Green K1000/5	<i>Code: Upchg: Description:</i>
		Presto Blue Chip K1000/6	C133 \$50 CAL 133 textile on back. No additional upcharge for upholstered outer back (add C133 to the end of the pattern number)
		Presto Scarlet K1000/7	
		Presto Red Carpet K1000/8	
		Presto Beige Taupe K1000/9	
		Presto Olive K1000/10	
		Presto Navy Blue K1000/11	
		Presto Clear Gray K1000/12	
		Presto Charcoal Gray K1000/13	
		Presto Black Tie K1000/14	

pattern no.	list price	COM														
	Presto base grade	A	B	C	D	E	F	G	H	I	T	COL			X	Y
												U	V	W		
<b>ESSENWORK-SEAT</b>	\$107.	\$128.	\$142.	\$159.	\$180.	\$200.	\$222.	\$235.	\$239.	\$256.	\$286.	\$338.	\$392.	\$485.	n/a	\$571.
<b>77WMIDBACK</b>	258.	290.	309.	334.	365.	395.	429.	445.	455.	476.	576.	674.	768.	931.	n/a	1,083.
<b>77WUMID-BACK</b>	304.	359.	392.	435.	483.	532.	588.	616.	629.	665.	831.	990.	1,145.	1,420.	n/a	1,670.
<b>77CMIDBACK</b>	258.	290.	309.	334.	365.	395.	429.	445.	455.	476.	576.	674.	768.	931.	n/a	1,083.
<b>77CUMID-BACK</b>	304.	359.	392.	435.	483.	532.	588.	616.	629.	665.	831.	990.	1,145.	1,420.	n/a	1,670.
<b>77WHIGH-BACK</b>	272.	309.	332.	363.	397.	431.	471.	490.	501.	526.	645.	758.	870.	1,062.	n/a	1,242.
<b>77WUHIGH-BACK</b>	322.	383.	420.	471.	526.	582.	648.	681.	697.	740.	930.	1,115.	1,295.	1,609.	n/a	1,902.
<b>77CHIGH-BACK</b>	272.	309.	332.	363.	397.	431.	471.	490.	501.	526.	645.	758.	870.	1,062.	n/a	1,242.
<b>77CUHIGH-BACK</b>	322.	383.	420.	471.	526.	582.	648.	681.	697.	740.	930.	1,115.	1,295.	1,609.	n/a	1,902.
<b>ESSENSIDE-SEAT</b>	110.	135.	148.	166.	186.	205.	227.	238.	245.	259.	289.	341.	394.	485.	n/a	568.
<b>77SBACK</b>	158.	190.	208.	228.	254.	278.	305.	320.	326.	343.	427.	507.	586.	721.	n/a	846.
<b>77SUBACK</b>	204.	256.	282.	316.	355.	393.	437.	460.	470.	499.	630.	755.	881.	1,096.	n/a	1,293.

# EWC Pro™ Task Dimensions and Operating Instructions

Seat*	BIFMA G1-2002 Ergonomic Guidelines	EWC Pro Mid-back Task Ergonomic Dimensions	EWC Pro High-back Task Ergonomic Dimensions	EWC Pro Side
Seat Height	15"-19.9" minimum range (one or combination of chairs)	without seat slider 16.25" - 20.75" (std.) 15" - 19" (low)  with seat slider 16.75" - 21.25" (std.) 15.5" - 19.5 (low)	without seat slider 16.25" - 20.75" (std.) 15" - 19" (low)  with seat slider 16.75" - 21.25" (std.) 15.5" - 19.5 (low)	17"
Seat Depth	16.9" or less fixed, include if adjustable	16.9" (fixed), 16.25" to 19" (adjustable)	16.9" (fixed), 16.25" to 19" (adjustable)	16.9"
Seat Width	18" min	19"	19"	19"
Seat Pan Angle (at rest)	0° - 4° rearward	2°	2°	2°
<b>Back*</b>				
Backrest Height	12.2" min	22" - 24.5"	24.5" - 27"	17.5"
Backrest Width	14.2" min	18"	19"	18.5"
Lumbar support	5.9" - 9.8" (adjustable include part of range)	5.75" - 8.75"	5.75" - 8.75"	6.75"
Angle Between Seat and Back	90°-115°	96°	96°	103°
Tilt Range of Back	10° min	26° (synchro) 12° (swivel)	26° (synchro) 12° (swivel)	N/A
<b>Arms*</b>				
Armrest Height (fixed)	7.9" - 9.8"	8.2"	8.2"	9.4"
Armrest Height (loop)	7.9" - 9.8"	8"	8"	N/A
Armrest Height (adjustable)	6.9" - 10.8"	7" - 10.5"	7" - 10.5"	N/A
Inside Distance Between Armrests (fixed/adjustable)	18" min fixed include 18" adjustable	19.5" - 21.5"	19.5" - 21.5"	19.5"
Inside Distance Between Armrest (loop)	18" min	19.7" - 21.9"	19.7" - 21.9"	N/A
*All measurements taken with BIFMA Chair Measuring Device using the Universal Measurement Procedure which as a measurement uncertainty of ±5%				
<b>Chair Measurements</b>				
<b>A</b> Overall Height (std cylinder)		36.5" - 40.5"	39" - 43.5"	32"
<b>B</b> Overall Width		27"	27"	21.75" (armless) 24.3" (with arms)
<b>C</b> Overall Depth		27"	27"	24"
<b>D</b> Fixed Arm Height From Floor (std. cylinder)		24.2" - 28.7"	24.2" - 28.7"	25.8"
Loop Arm Height From Floor (std. cylinder)		24" - 28.8"	24" - 28.8"	N/A
Adj. Arm Height From Floor (std. cylinder)		23" - 31.2"	23" - 31.2"	N/A
<b>E</b> Recline Range		98° - 124° (synchro) 98° - 110° (swivel)	98° - 124° (synchro) 98° - 110° (swivel)	N/A N/A
Back Recline Ratio		1:3 (synchro) 1:1 (swivel)	1:3 (synchro) 1:1 (swivel)	N/A N/A
<b>F</b> Base Diameter		27"	27"	N/A
<b>G</b> Weight		41.3 lbs.	43.3 lbs.	20.2 lbs. (armless) 23.5 lbs. (with arms)



Compliance: ANSI/BIFMA x5.1-2002, BIFMA G1-2002 Ergonomic Guidelines, Cal 117, Cal 133 (with approved FR upholstery) for all EWC Pro chairs; CAN/CSG 44.232-2002 for EWC Pro High-back and Mid-back task chairs and EWC Pro side, not for EWC Pro High-back and Mid-back conference chairs



## EWC Pro High-back and Mid-back Task Chairs

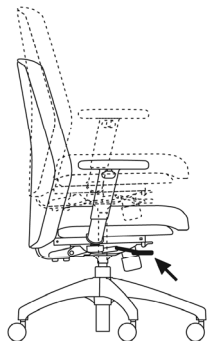

### Seat Height

To raise the seat height, remove your weight from the chair while lifting the lever under the right side of the seat. To lower the seat height, lift the lever while sitting in the chair.

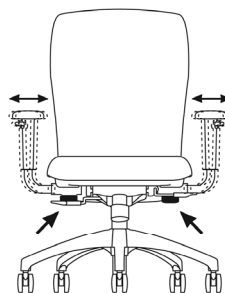

### Adjustable Arm Width

To adjust the arm width, loosen the knob under the arm support by turning clockwise. Slide the support toward or away from the seat to adjust the arm width. Tighten the knob under the arm. The arms adjust 1" in width per side (2" total).

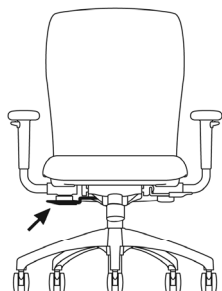

### Tilt Lock

To recline, pull out the lever under the right side of the seat. To lock the chair upright, push the lever in.

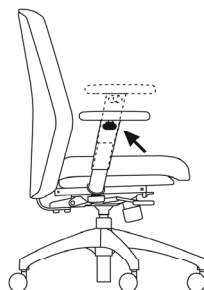

### Adjustable Arm Height (Optional)

To adjust the arm pad height, lift the lever on the outside of the arm support and move the arm up or down. Release the lever to lock. The arms have a 3.5" range of adjustment.



### Tilt Tension

To adjust the tilt tension, turn the knob under the front of the seat. Turn counterclockwise to tighten, and clockwise to loosen.

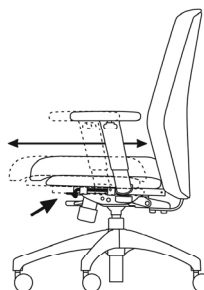

### Sliding Seat Depth Adjustment (Optional)

To adjust the seat depth, lift the lever under the left side of the seat and slide the seat to the desired location. Release the lever to lock. There are 6 positions within a 2.75" range.



### Back Height (Task chairs only)

To raise the back height, firmly hold both sides of the back and lift. The back height adjust 9 notches upward for a total of 2.5" of adjustability. To lower the back height, first raise the back to the highest position; the top notch releases the back to the lowest position.

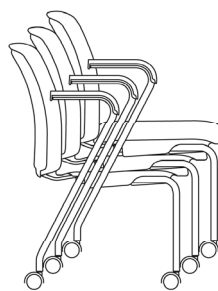

## EWC Pro Side Chair

### This is a stacking side chair.

Chairs should not be stacked more than 3 units high. To stack chairs, place the rear legs of the top chair in front of the rear legs of the bottom chair. The bottom of the top chair's seat should rest on the lower chair's seat.

# EWC Pro™ Conference Dimensions and Operating Instructions

Seat*	BIFMA G1-2002 Ergonomic Guidelines	EWC Pro Mid-back Conference Ergonomic Dimensions	EWC Pro High-back Conference Ergonomic Dimensions
Seat Height	15" - 19.9" min range (one or combination of chairs)	without seat slider 16.25" - 20.75" (std.) 15" - 19" (low)  with seat slider 16.75" - 21.25" (std.) 15.5" - 19.5 (low)	without seat slider 16.25" - 20.75" (std.) 15" - 19" (low)  with seat slider 16.75" - 21.25" (std.) 15.5" - 19.5 (low)
Seat Depth	16.9" (or less fixed, include if adjustable)	16.9" (fixed), 16.25" to 19" (adjustable)	16.9" (fixed), 16.25" to 19" (adjustable)
Seat Width	18" min	19"	19"
Seat Pan Angle (at rest)	0° - 4° rearward	2°	2°

Back*			
Backrest Height	12.2" min	22.75"	24.75"
Backrest Width	14.2" min	18"	19"
Lumbar support	5.9" - 9.8"	7.25"	7.25"
Angle Between Seat and Back	90° - 115°	92.5°	92.5°
Tilt Range of Back	10° min	26° (synchro) 12° (swivel)	26° (synchro) 12° (swivel)

Arms*			
Armrest Height (loop)	7.9" - 9.8"	8"	8"
Inside Distance Between Armrest (loop)	18" min	19.7" - 21.9"	19.7" - 21.9"

\*All measurements taken with BIFMA Chair Measuring Device using the Universal Measurement Procedure which has a measurement uncertainty of ±5%

Chair		
<b>A</b> Overall Height (std cylinder)	36.5" - 40.5"	39" - 43.5"
<b>B</b> Overall Width	27"	27"
<b>C</b> Overall Depth	27"	27"
<b>D</b> Loop Arm Height From Floor	24" - 28.8"	24" - 28.8"
<b>E</b> Recline Range	98° - 124° (synchro) 98° - 110° (swivel)	98° - 124° (synchro) 98° - 110° (swivel)
Back Recline Ratio	1:3 (synchro) 1:1 (swivel)	1:3 (synchro) 1:1 (swivel)
<b>F</b> Base Diameter	27"	27"
<b>G</b> Weight	41.3 lbs.	43.3 lbs.

EWC Pro Conference

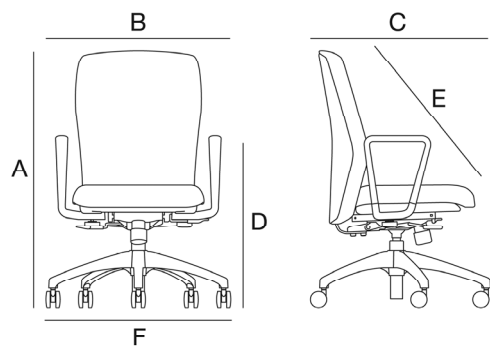

Compliance: ANSI/BIFMA x5.1-2002, BIFMA G1-2002 Ergonomic Guidelines, Cal 117, Cal 133 (with approved FR upholstery)

---

## EWC Pro High-back and Mid-back Conference Chairs

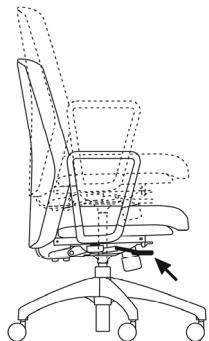

### Seat Height

To raise the seat height, remove your weight from the chair while lifting the lever under the right side of the seat. To lower the seat height, lift the lever while sitting in the chair.

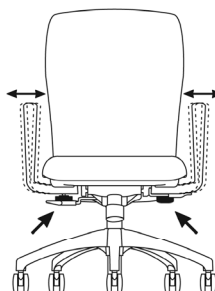

### Adjustable Arm Width

To adjust the arm width, loosen the knob under the arm support by turning clockwise. Slide the support toward or away from the seat to adjust the arm width. Tighten the knob under the arm. The arms adjust 1" in width per side (2" total).

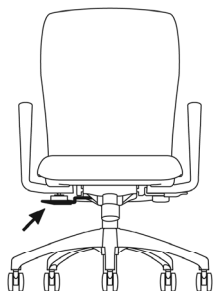

### Tilt Lock

To recline, pull out the lever under the right side of the seat. To lock the chair upright, push the lever in.

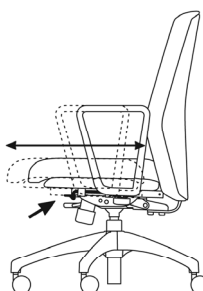

### Sliding Seat Depth Adjustment (Optional)

To adjust the seat depth, lift the lever under the left side of the seat and slide the seat to the desired location. Release the lever to lock. There are 6 positions within a 2.75" range.







### Tilt Tension

To adjust the tilt tension, turn the knob under the front of the seat. Turn counterclockwise to tighten, and clockwise to loosen.

EWC Tech™  
*suspension back task chair*  
*synchronized tilt control*

Designer(s):  
 Jeffrey Bernett and  
 Nicholas Dodziuk, 2005



pattern no.	description
<b>88W-MB-2-SY-NA-5-HC</b>	Suspension mid-back task chair, synchronized control, armless
	
<b>88W-MB-2-SY-LA-5-HC</b>	Suspension mid-back task chair, synchronized control, loop arms
	
<b>88W-MB-2-SY-FA-5-HC</b>	Suspension mid-back task chair, synchronized control, fixed arms
	
<b>88W-MB-2-SY-HA-5-HC</b>	Suspension mid-back task chair, synchronized control, height/width adjustable arms
	

For upholstery options and pricing, see facing page.

Order Code	Ordering Information	Options
<i>Example:</i> <b>88W-MB-2-SY-HA 5-SL-HC Seat: K1000/8 - Back: S08</b>	<i>Specify:</i> 1. Pattern number 2. Seat upholstery 3. Suspension back color  <i>Code: Finish Color:</i> 2 Black	<i>Cylinder Height Option:</i> For low height cylinder (15"-19" seat height range), replace 5 in pattern number with L.  <i>Code: Upchg: Description:</i> L \$71 low cylinder
<b>88W</b> EWC Tech suspension back task chair		<i>Caster and Glide Options:</i> Substitute HC in pattern with one of the following options:  <i>Code: Upchg: Description:</i> SC n/c soft black casters for hard surfaces GL n/c glides
<b>MB</b> Mid-back		
<b>2</b> Black finish		
<b>SY</b> Synchronized tilt control		
<b>HA</b> Height and width adjustable arms		<i>Sliding Seat Option:</i> For sliding seat with 2.75" of depth adjustment insert SL after cylinder choice in pattern number. Adds 0.5" to seat height.  <i>Code: Upchg: Description:</i> SL \$39 sliding seat
<b>5</b> Standard height cylinder		
<b>SL</b> Sliding seat		
<b>HC</b> Hard wheel black caster		
<b>SEAT K1000/8</b> Presto, Red Carpet		
<b>BACK S08</b> Red Carpet		

pattern no.	list price Presto base grade	A	COM B	C	D	E	F	G	H	I	T	COL U	V	W	X	Y
<b>88W-MB-2-SY-NA-5-HC</b>	\$677.	\$689.	\$701.	\$716.	\$735.	\$752.	\$775.	\$784.	\$788.	\$802.	\$837.	\$888.	\$935.	\$1,018.	n/a	\$1,098.
<b>88W-MB-2-SY-LA-5-HC</b>	732.	744.	755.	773.	790.	809.	829.	839.	844.	857.	895.	943.	991.	1,076.	n/a	1,154.
<b>88W-MB-2-SY-FA-5-HC</b>	732.	744.	755.	773.	790.	809.	829.	839.	844.	857.	895.	943.	991.	1,076.	n/a	1,154.
<b>88W-MB-2-SY-HA-5-HC</b>	761.	774.	785.	801.	819.	837.	859.	868.	873.	887.	923.	974.	1,020.	1,104.	n/a	1,184.

**Presto - Base Grade Fabric**

**FOR SEAT ONLY**

*Color options:*

- Presto Winter White K1000/1
- Presto Sand K1000/2
- Presto Stone K1000/3
- Presto Saffron K1000/4
- Presto Spring Green K1000/5
- Presto Blue Chip K1000/6
- Presto Scarlet K1000/7
- Presto Red Carpet K1000/8
- Presto Beige Taupe K1000/9
- Presto Olive K1000/10
- Presto Navy Blue K1000/11
- Presto Clear Gray K1000/12
- Presto Charcoal Gray K1000/13
- Presto Black Tie K1000/14

**Suspension Back-Standard**

**FOR BACK ONLY**

*Color options:*

- Red Carpet S08
- Beige Taupe S09
- Olive S10
- Navy Blue S11
- Clear Gray S12
- Charcoal Gray S13
- Black Tie S14

EWC Tech Suspension Back is cleaning code W-S. It is rated Heavy Duty for abrasion (exceeds 30,000 double rubs with Wyzenbeek method).

**COM/COL Upholstery Requirements**

Textile yardage required: .8 yards  
Leather sq. ft. required: 10 sq. ft.





*CAL 133 Options:*

<i>Code:</i>	<i>Upchg:</i>	<i>Description:</i>
C133	\$50	CAL 133 textile on seat only. (add C133 to the end of the pattern number)

EWC Tech™  
*suspension back task chair*  
*swivel tilt control*

Designer(s):  
 Jeffrey Bernett and  
 Nicholas Dodziuk, 2005



pattern no.	description
<b>88W-MB-2-ST-NA-5-HC</b>	Suspension mid-back task chair, swivel-tilt control, armless
	
<b>88W-MB-2-ST-LA-5-HC</b>	Suspension mid-back task chair, swivel-tilt control, loop arms
	
<b>88W-MB-2-ST-FA-5-HC</b>	Suspension mid-back task chair, swivel-tilt control, fixed arms
	
<b>88W-MB-2-ST-HA-5-HC</b>	Suspension mid-back task chair, swivel-tilt control, height/width adjustable arms
	

For upholstery options and pricing, see facing page.

Order Code	Ordering Information	Options
<i>Example:</i> <b>88W-MB-2-ST-HA 5-SL-HC Seat: K1000/8 Back: S08</b>	<i>Specify:</i> 1. Pattern number 2. Seat upholstery 3. Suspension back color  <i>Code: Finish Color:</i> 2 Black	<i>Cylinder Height Option:</i> For low height cylinder (15"-19" seat height range), replace 5 in pattern number with L.  <i>Code: Upchg: Description:</i> L \$71 low cylinder
<b>88W</b> EWC Tech upholstered task chair		<i>Caster and Glide Options:</i> Substitute HC in pattern with one of the following options:  <i>Code: Upchg: Description:</i> SC n/c soft black casters for hard surfaces GL n/c glides
<b>MB</b> Mid-back		
<b>2</b> Black finish		
<b>ST</b> Swivel tilt control		
<b>HA</b> Height and width adjustable arms		<i>Sliding Seat Option:</i> For sliding seat with 2.75" of depth adjustment insert SL after cylinder choice in pattern number. Adds 0.5" to seat height.  <i>Code: Upchg: Description:</i> SL \$39 sliding seat
<b>5</b> Standard height cylinder		
<b>SL</b> Sliding seat		
<b>HC</b> Hard wheel black caster		
<b>SEAT K1000/8</b> Presto, Red Carpet		
<b>BACK S08</b> Red Carpet		

pattern no.	list price Presto base grade	A	COM B	C	D	E	F	G	H	I	T	COL U	V	W	X	Y
<b>88W-MB-2-ST-NA-5-HC</b>	\$579.	\$592.	\$605.	\$620.	\$639.	\$658.	\$679.	\$688.	\$693.	\$706.	\$740.	\$791.	\$841.	\$925.	n/a	\$1,004.
<b>88W-MB-2-ST-LA-5-HC</b>	635.	648.	661.	677.	696.	714.	735.	744.	749.	763.	799.	848.	898.	983.	n/a	1,063.
<b>88W-MB-2-ST-FA-5-HC</b>	635.	648.	661.	677.	696.	714.	735.	744.	749.	763.	799.	848.	898.	983.	n/a	1,063.
<b>88W-MB-2-ST-HA-5-HC</b>	665.	678.	690.	705.	724.	742.	764.	775.	779.	792.	828.	878.	927.	1,012.	n/a	1,093.

**Presto - Base Grade Fabric****FOR SEAT ONLY***Color options:*

Presto Winter White K1000/1  
Presto Sand K1000/2  
Presto Stone K1000/3  
Presto Saffron K1000/4  
Presto Spring Green K1000/5  
Presto Blue Chip K1000/6  
Presto Scarlet K1000/7  
Presto Red Carpet K1000/8  
Presto Beige Taupe K1000/9  
Presto Olive K1000/10  
Presto Navy Blue K1000/11  
Presto Clear Gray K1000/12  
Presto Charcoal Gray K1000/13  
Presto Black Tie K1000/14

**Suspension Back-Standard****FOR BACK ONLY***Color options:*

Red Carpet S08  
Beige Taupe S09  
Olive S10  
Navy Blue S11  
Clear Gray S12  
Charcoal Gray S13  
Black Tie S14

EWC Tech Suspension Back is cleaning code W-S. It is rated Heavy Duty for abrasion (exceeds 30,000 double rubs Wyzenbeek method).

**COM/COL Upholstery Requirements**

Textile yardage required: .8 yards  
Leather sq. ft. required: 10 sq. ft.

*CAL 133 Options:*

*Code: Upchg:*

C133 \$50

*Description:*

CAL 133 textile on seat only, (add C133 to the end of the pattern number)

EWC Tech™  
*suspension back conference chair*  
*synchronized tilt control*

pattern no.	description
<b>88C-MB-2-SY-LA-5-HC</b>	Suspension mid-back conference chair, synchronized control, loop arms

Designer(s):  
 Jeffrey Bernett and  
 Nicholas Dodziuk, 2007



For upholstery options and pricing, see facing page.

Order Code	Ordering Information	Options
<i>Example:</i> <b>88C-MB-2-SY-LA-5-SL-HC</b> <b>Seat: K1000/8 - Back: S08</b>	<i>Specify:</i> 1. Pattern number 2. Seat upholstery 3. Suspension back color	<i>Cylinder Height Option:</i> For low height cylinder (15"-19" seat height range), replace 5 in pattern number with L.  <i>Code: Upchg: Description:</i> L \$71 low cylinder
<b>88C</b> EWC Tech suspension back conference chair	<i>Code: Finish Color:</i> 2 Black	<i>Caster and Glide Options:</i> Substitute HC in pattern with one of the following options:  <i>Code: Upchg: Description:</i> SC n/c soft black casters for hard surfaces GL n/c glides
<b>MB</b> Mid-back		
<b>2</b> Black finish		
<b>SY</b> Synchronized tilt control		
<b>LA</b> Loop width adjustable arms		
<b>5</b> Standard height cylinder		
<b>SL</b> Sliding seat		<i>Sliding Seat Option:</i> For sliding seat with 2.75" of depth adjustment insert SL after cylinder choice in pattern number. Adds 0.5" to seat height.
<b>HC</b> Hard wheel black caster		<i>Code: Upchg: Description:</i> SL \$39 sliding seat
<b>SEAT K1000/8</b> Presto, Red Carpet		
<b>BACK S08</b> Red Carpet		



pattern no.	list price Presto base grade	A	COM B	C	D	E	F	G	H	I	T	COL U	V	W	X	Y
<b>88C-MB-2-SY- LA-5-HC</b>	\$732.	\$744.	\$755.	\$773.	\$790.	\$809.	\$829.	\$839.	\$844.	\$857.	\$895.	\$943.	\$991.	\$1,076.	n/a	\$1,154.

**Presto - Base Grade Fabric****FOR SEAT ONLY***Color options:*

Presto Winter White K1000/1  
Presto Sand K1000/2  
Presto Stone K1000/3  
Presto Saffron K1000/4  
Presto Spring Green K1000/5  
Presto Blue Chip K1000/6  
Presto Scarlet K1000/7  
Presto Red Carpet K1000/8  
Presto Beige Taupe K1000/9  
Presto Olive K1000/10  
Presto Navy Blue K1000/11  
Presto Clear Gray K1000/12  
Presto Charcoal Gray K1000/13  
Presto Black Tie K1000/14

**Suspension Back-Standard****FOR BACK ONLY***Color options:*

Red Carpet S08  
Beige Taupe S09  
Olive S10  
Navy Blue S11  
Clear Gray S12  
Charcoal Gray S13  
Black Tie S14

EWC Tech Suspension Back is cleaning code W-S. It is rated Heavy Duty for abrasion (exceeds 30,000 double rubs Wyzenbeek method).

**COM/COL Upholstery Requirements**

Textile yardage required: .8 yards  
Leather sq. ft. required: 10 sq. ft.

*CAL 133 Options:**Code: Upchg: Description:*

C133 \$50 CAL 133 textile on seat only. (add C133 to the end of the pattern number)

EWC Tech™  
*suspension back conference chair*  
*swivel tilt control*

pattern no.	description
<b>88C-MB-2-ST-LA-5-HC</b>	Suspension mid-back conference chair, swivel-tilt control, loop arms

Designer(s):  
 Jeffrey Bernett and  
 Nicholas Dodziuk, 2007



For upholstery options and pricing, see facing page.

Order Code	Ordering Information	Options
<i>Example:</i> <b>88C-MB-2-ST-LA 5-SL-HC</b> <b>Seat: K1000/8 Back: S08</b>	<i>Specify:</i> 1. Pattern number 2. Seat upholstery 3. Suspension back color	<i>Cylinder Height Option:</i> For low height cylinder (15"-19" seat height range), replace 5 in pattern number with L.
<b>88C</b>	EWC Tech suspension back conference chair	<i>Code: Upchg: Description:</i> L \$71 low cylinder
<b>MB</b>	Mid-back	<i>Caster and Glide Options:</i> Substitute HC in pattern with one of the following options: <i>Code: Upchg: Description:</i> SC n/c soft black casters for hard surfaces GL n/c glides
<b>2</b>	Black finish	
<b>ST</b>	Swivel tilt control	
<b>LA</b>	Loop width adjustable arms	
<b>5</b>	Standard height cylinder	<i>Sliding Seat Option:</i> For sliding seat with 2.75" of depth adjustment insert SL after cylinder choice in pattern number. Adds 0.5" to seat height.
<b>SL</b>	Sliding seat	<i>Code: Upchg: Description:</i> SL \$39 sliding seat
<b>HC</b>	Hard wheel black caster	
<b>SEAT</b>	Presto, Red Carpet	
<b>K1000/8</b>		
<b>BACK S08</b>	Red Carpet	

pattern no.	list price Presto base grade	A	COM B	C	D	E	F	G	H	I	T	COL U	V	W	X	Y
<b>88C-MB-2-ST- LA-5-HC</b>	\$635.	\$648.	\$661.	\$677.	\$696.	\$714.	\$735.	\$744.	\$749.	\$763.	\$799.	\$848.	\$898.	\$983.	n/a	\$1,063.

**Presto - Base Grade Fabric**

**FOR SEAT ONLY**

*Color options:*

- Presto Winter White K1000/1
- Presto Sand K1000/2
- Presto Stone K1000/3
- Presto Saffron K1000/4
- Presto Spring Green K1000/5
- Presto Blue Chip K1000/6
- Presto Scarlet K1000/7
- Presto Red Carpet K1000/8
- Presto Beige Taupe K1000/9
- Presto Olive K1000/10
- Presto Navy Blue K1000/11
- Presto Clear Gray K1000/12
- Presto Charcoal Gray K1000/13
- Presto Black Tie K1000/14

**Suspension Back-Standard**

**FOR BACK ONLY**

*Color options:*

- Red Carpet S08
- Beige Taupe S09
- Olive S10
- Navy Blue S11
- Clear Gray S12
- Charcoal Gray S13
- Black Tie S14

EWC Tech Suspension Back is cleaning code W-S. It is rated Heavy Duty for abrasion (exceeds 30,000 double rubs Wyzenbeek method).

**COM/COL Upholstery Requirements**



Textile yardage required: .8 yards  
Leather sq. ft. required: 10 sq. ft.

*CAL 133 Options:*

<i>Code:</i>	<i>Upchg:</i>	<i>Description:</i>
C133	\$50	CAL 133 textile on seat only. (add C133 to the end of the pattern number)

# EWC Tech™

## *suspension back side chair*

	pattern no.	description
Designer(s): Jeffrey Bennett and Nicholas Dodziuk, 2005  	<b>88S-2-FA-HC</b>	Suspension back side chair, fixed arms
		
	<b>88S-2-NA-HC</b>	Suspension back side chair, armless
		

For upholstery options and pricing, see facing page.

Order Code	Ordering Information	Options
<i>Example:</i> <b>88S-2-FA-HC Seat:</b> <b>K1000/8 Back: S08</b>	<i>Specify:</i>	<i>Caster and Glide Options:</i>
<b>88S</b> EWC Tech suspension back side chair	1. Pattern number	Substitute HC in pattern with one of the following options:
<b>2</b> Black finish	2. Seat upholstery	<i>Code: Upchg: Description:</i>
<b>FA</b> Fixed arms	3. Suspension back color	SC n/c soft black casters for hard surfaces
<b>HC</b> Hard wheel black caster	<i>Code: Finish Color:</i>	GL n/c glides
<b>SEAT</b> Presto, Red Carpet	2 Black	
<b>K1000/8</b>		
<b>BACK S08</b> Red Carpet suspension back		

pattern no.	list price Presto base grade	A	COM B	C	D	E	F	G	H	I	T	COL U	V	W	X	Y
<b>88S-2-FA-HC</b>	\$409.	\$424.	\$436.	\$451.	\$471.	\$488.	\$509.	\$520.	\$524.	\$537.	\$569.	\$619.	\$667.	\$749.	n/a	\$828.
<b>88S-2-NA-HC</b>	381.	398.	409.	426.	444.	464.	485.	495.	501.	514.	546.	596.	645.	733.	n/a	811.

**Presto - Base Grade Fabric****FOR SEAT ONLY***Color options:*

Presto Winter White K1000/1  
Presto Sand K1000/2  
Presto Stone K1000/3  
Presto Saffron K1000/4  
Presto Spring Green K1000/5  
Presto Blue Chip K1000/6  
Presto Scarlet K1000/7  
Presto Red Carpet K1000/8  
Presto Beige Taupe K1000/9  
Presto Olive K1000/10  
Presto Navy Blue K1000/11  
Presto Clear Gray K1000/12  
Presto Charcoal Gray K1000/13  
Presto Black Tie K1000/14

**Suspension Back-Standard****FOR BACK ONLY***Color options:*

Red Carpet S08  
Beige Taupe S09  
Olive S10  
Navy Blue S11  
Clear Gray S12  
Charcoal Gray S13  
Black Tie S14

EWC Tech Suspension Back is cleaning code W-S. It is rated Heavy Duty for abrasion (exceeds 30,000 double rubs Wyzenbeek method).

**COM/COL Upholstery Requirements**

Textile yardage required: .8 yards  
Leather sq. ft. required: 10 sq. ft.

*CAL 133 Options:**Code: Upchg: Description:*

C133 \$50 CAL 133 textile on seat only. (add C133 to the end of the pattern number)

# EWC Tech™

## seat and back replacements for task, conference and side chairs

pattern no.	description
<b>ESSENWORK-SEAT</b>	Replacement upholstered seat for EWC Pro and EWC Tech task and conference chair
<b>ESSENSIDESEAT</b>	Replacement upholstered seat for EWC Pro and EWC Tech side chair
<b>88WBACK</b>	Replacement EWC Tech task and conference back
<b>88SBACK</b>	Replacement EWC Tech side back

Designer(s):  
Jeffrey Bernett and  
Nicholas Dodziuk, 2007



Order Code	Ordering Information	Presto - Base Grade Fabric	Suspension Back-Standard
<i>Example:</i> <b>ESSENWORKSEAT - K1000/8</b>	<i>Specify:</i> 1. Pattern number 2. Seat upholstery or Suspension back color	<b>FOR SEAT ONLY</b> <i>Color options:</i> Presto Winter White K1000/1 Presto Sand K1000/2 Presto Stone K1000/3 Presto Saffron K1000/4 Presto Spring Green K1000/5 Presto Blue Chip K1000/6 Presto Scarlet K1000/7 Presto Red Carpet K1000/8 Presto Beige Taupe K1000/9 Presto Olive K1000/10 Presto Navy Blue K1000/11 Presto Clear Gray K1000/12 Presto Charcoal Gray K1000/13 Presto Black Tie K1000/14	<b>FOR BACK ONLY</b> <i>Color options:</i> Red Carpet S08 Beige Taupe S09 Olive S10 Navy Blue S11 Clear Gray S12 Charcoal Gray S13 Black Tie S14  EWC Tech Suspension Back is cleaning code W-S. It is rated Heavy Duty for abrasion (exceeds 30,000 double rubs Wyzenbeek method).
<b>ESSENWORK-SEAT</b>	Upholstered seat replacement		
<b>K1000/8</b>	Presto, Red Carpet		
	<b>COM/COL Upholstery Requirements</b> Textile yardage required: .8 yards Leather sq. ft. required: 10 sq. ft.		

pattern no.	list price Presto base grade	COM											COL			
		A	B	C	D	E	F	G	H	I	T	U	V	W	X	Y
<b>ESSENWORK- SEAT</b>	\$107.	\$128.	\$142.	\$159.	\$180.	\$200.	\$222.	\$235.	\$239.	\$256.	\$286.	\$338.	\$392.	\$485.	n/a	\$571.
<b>ESSENSIDE- SEAT</b>	110.	135.	148.	166.	186.	205.	227.	238.	245.	259.	289.	341.	394.	485.	n/a	568.
<b>88WBACK</b>	173.															
<b>88SBACK</b>	142.															

**Options**

*CAL 133 Options:*

Code:	Upchg:	Description:
C133	\$50	CAL 133 textile on seat only. (add C133 to the end of the pattern number)

# EWC Tech™ Task Dimensions and Operating Instructions

Seat*	BIFMA G1-2002 Ergonomic Guidelines	EWC Tech Mid-back Task Ergonomic Dimensions	EWC Tech Side
Seat Height	15" - 19.9" minimum range (one or combination of chairs)	without seat slider 16.25" - 20.75" (std.) 15" - 19" (low)  with seat slider 16.75" - 21.25" (std.) 15.5" - 19.5 (low)	17"
Seat Depth	16.9" or less fixed, include if adjustable	16.9" (fixed) 16.25" to 19" (adjustable)	16.9"
Seat Width	18" min	19"	19"
Seat Pan Angle (at rest)	0° - 4° rearward	2°	2°
<b>Back*</b>			
Backrest Height	12.2" min	23"	17.5"
Backrest Width	14.2" min	19"	18.5"
Lumbar support	5.9" - 9.8"	6.5"	6.25"
Angle Between Seat and Back	90° - 115°	96°	103°
Tilt Range of Back	10° min	26° (synchro) 12° (swivel)	N/A
<b>Arms*</b>			
Armrest Height (fixed)	7.9" - 9.8"	8.2"	9.4"
Armrest Height (loop)	7.9" - 9.8"	8"	N/A
Armrest Height (adjustable)	6.9" - 10.8"	7" - 10.5"	N/A
Inside Distance Between Armrest (fixed/adjustable)	18" min fixed, include 18" adjustable	19.5" - 21.5"	19.5"
Inside Distance Between Armrest (loop)	18" min	19.7" - 21.9"	N/A
*All measurements taken with BIFMA Chair Measuring Device using the Universal Measurement Procedure which has a measurement uncertainty of ±5%			
<b>Chair</b>			
<b>A</b> Overall Height (std cylinder)		38.25" - 42.75"	32"
<b>B</b> Overall Width		27"	21.75" (armless) 24.3" (with arms)
<b>C</b> Overall Depth		27"	24"
<b>D</b> Fixed Arm Height From Floor (std. cylinder)		24.2" - 28.7"	25.8"
Loop Arm Height From Floor (std. cylinder)		24" - 28.8"	N/A
Adj. Arm Height From Floor (std. cylinder)		23" - 31.2"	N/A
<b>E</b> Recline Range		98° - 124° (synchro) 98° - 110° (swivel)	N/A N/A
Back Recline Ratio		1:3 (synchro) 1:1 (swivel)	N/A N/A
<b>F</b> Base Diameter		27"	N/A
<b>G</b> Weight		38.6 lbs.	19.2 lbs. (armless) 22.5 lbs. (with arms)



Compliance: ANSI/BIFMA x5.1-2002, BIFMA G1-2002 Ergonomic Guidelines, CAN/CGSB 44.232-2002 (EWC Tech task chairs and EWC Tech Side only), Cal 117, Cal 133 (with approved FR upholstery)



## EWC Tech Task Chairs

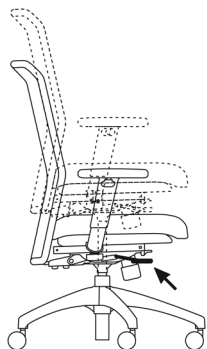

### Seat Height

To raise the seat height, remove your weight from the chair while lifting the lever under the right side of the seat. To lower the seat height, lift the lever while sitting in the chair.

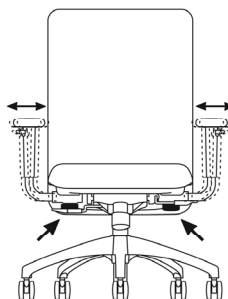

### Adjustable Arm Width

To adjust the arm width, loosen the knob under the arm support by turning clockwise. Slide the support toward or away from the seat to adjust the arm width. Tighten the knob under the arm. The arms adjust 1" in width per side (2" total).

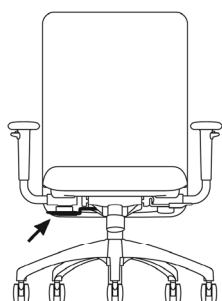

### Tilt Lock

To recline, pull out the lever under the right side of the seat. To lock the chair upright, push the lever in.

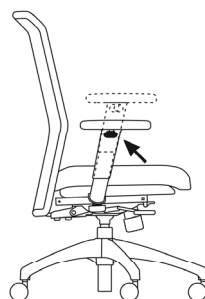

### Adjustable Arm Height (Optional)

To adjust the arm pad height, lift the lever on the outside of the arm support and move the arm up or down. Release the lever to lock. The arms have a 3.5" range of adjustment.



### Tilt Tension

To adjust the tilt tension, turn the knob under the front of the seat. Turn counterclockwise to tighten, and clockwise to loosen.

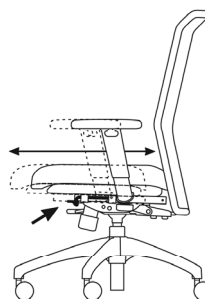

### Sliding Seat Depth Adjustment (Optional)

To adjust the seat depth, lift the lever under the left side of the seat and slide the seat to the desired location. Release the lever to lock. There are 6 positions within a 2.75" range.

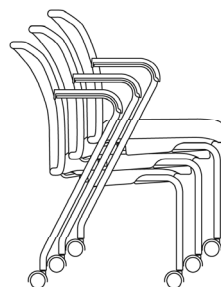

## EWC Tech Side Chair

### This is a stacking side chair.

Chairs should not be stacked more than 3 units high. To stack chairs, place the rear legs of the top chair in front of the rear legs of the bottom chair. The bottom of the top chair's seat should rest on the lower chair's seat.

# EWC Tech™ Conference Dimensions and Operating Instructions

Seat*	BIFMA G1-2002 Ergonomic Guidelines	EWC Tech Mid-back Conference Ergonomic Dimensions
Seat Height	15" - 19.9 minimum range" (one or combination of chairs)	without seat slider 16.25" - 20.75" (std.) 15" - 19" (low)  with seat slider 16.75" - 21.25" (std.) 15.5" - 19.5" (low)
Seat Depth	16.9" or less fixed, include if adjustable	16.9" (fixed) 16.25" to 19" (adjustable)
Seat Width	18" min	19"
Seat Pan Angle (at rest)	0° - 4° rearward	2°
<b>Back*</b>		
Backrest Height	12.2" min	23"
Backrest Width	14.2" min	19"
Lumbar support	5.9" - 9.8"	6.5"
Angle Between Seat and Back	90° - 115°	96°
Tilt Range of Back	10° min	26° (synchro) 12° (swivel)
<b>Arms*</b>		
Armrest Height (loop)	7.9" - 9.8"	8"
Inside Distance Between Armrest (loop)	18" min	19.7" - 21.9"
*All measurements taken with BIFMA Chair Measuring Device using the Universal Measurement Procedure which has a measurement uncertainty of ±5%		
<b>Chair</b>		
<b>A</b> Overall Height (std cylinder)		38.25" - 42.75"
<b>B</b> Overall Width		27"
<b>C</b> Overall Depth		27"
<b>D</b> Loop Arm Height From Floor		24" - 28.8"
<b>E</b> Recline Range		98° - 124° (synchro) 98° - 110° (swivel)
Back Recline Ratio		1:3 (synchro) 1:1 (swivel)
<b>F</b> Base Diameter		27"
<b>G</b> Weight		38.6 lbs.

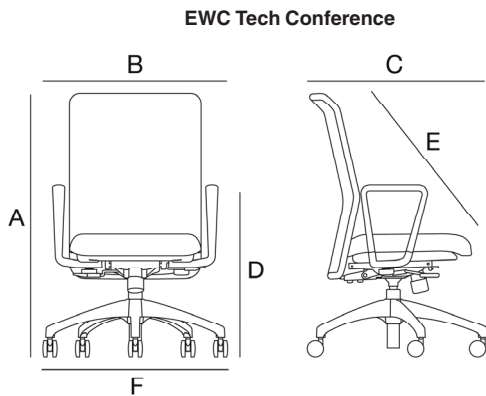

Compliance: ANSI/BIFMA x5.1-2002, BIFMA G1-2002 Ergonomic Guidelines, Cal 117, Cal 133 (with approved FR upholstery)

## EWC Tech Conference Chairs

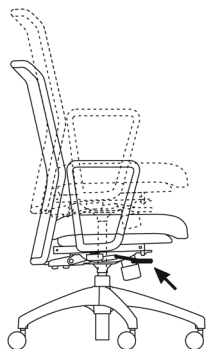

### Seat Height

To raise the seat height, remove your weight from the chair while lifting the lever under the right side of the seat. To lower the seat height, lift the lever while sitting in the chair.

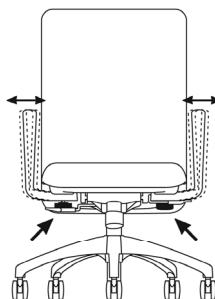

### Adjustable Arm Width

To adjust the arm width, loosen the knob under the arm support by turning clockwise. Slide the support toward or away from the seat to adjust the arm width. Tighten the knob under the arm. The arms adjust 1" in width per side (2" total).

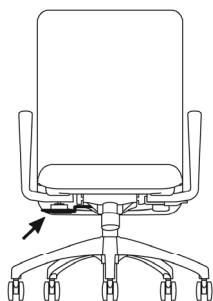

### Tilt Lock

To recline, pull out the lever under the right side of the seat. To lock the chair upright, push the lever in.

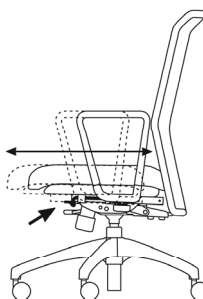

### Sliding Seat Depth Adjustment (Optional)

To adjust the seat depth, lift the lever under the left side of the seat and slide the seat to the desired location. Release the lever to lock. There are 6 positions within a 2.75" range.

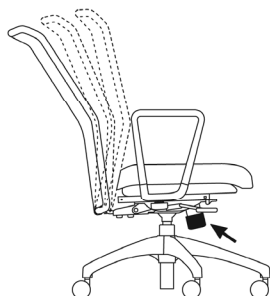







### Tilt Tension

To adjust the tilt tension, turn the knob under the front of the seat. Turn counterclockwise to tighten, and clockwise to loosen.

# EWC Sport™

## upholstered mid-back task chair

### synchronized tilt control

	pattern no.	description
<i>Designer(s):</i> Jeffrey Bernett and Nicholas Dodziuk, 2007	<b>99W-MBU-2-SY-NA-5-HC</b>	Upholstered mid-back task chair with upholstered outer back, 2.5" back height adjustment, synchronized control, armless
		
	<b>99W-MBU-2-SY-LA-5-HC</b>	Upholstered mid-back task chair with upholstered outer back, 2.5" back height adjustment, synchronized control, loop arms
		
	<b>99W-MBU-2-SY-FA-5-HC</b>	Upholstered mid-back task chair with upholstered outer back, 2.5" back height adjustment, synchronized control, fixed arms
		
(Shown with EWC Sport Fabric Seat Accent Option)	<b>99W-MBU-2-SY-HA-5-HC</b>	Upholstered mid-back task chair with upholstered outer back, 2.5" back height adjustment, synchronized control, height/width adjustable arms
		

For upholstery options and pricing, see facing page.

Order Code	Ordering Information	Options
<i>Example:</i> <b>99W-MBU-2-SY-HA-5-SL-HC K1000/8 K1000/8 K1000/8 K1196/14</b>	<i>Specify:</i>	<i>Cylinder Height Option:</i>
<b>99W</b> EWC Sport task chair	1. Pattern number	For low height cylinder (14.4"-18.5" seat height range), replace 5 in pattern number with L.
<b>MB</b> Mid-back	2. Seat upholstery	<i>Code: Upchg: Description:</i>
<b>U</b> Upholstered outer back	3. Seat accent upholstery	L \$71 low cylinder
<b>2</b> Black finish	4. Back upholstery	
<b>SY</b> Synchronized tilt control	5. Back accent upholstery	
<b>HA</b> Height and width adjustable arms	<i>Code: Finish Color:</i>	<i>Caster and Glide Options:</i>
<b>5</b> Standard height cylinder	2 Black	Substitute HC in pattern with one of the following options:
<b>SL</b> Sliding seat		<i>Code: Upchg: Description:</i>
<b>HC</b> Hard wheel black casters		SC n/c soft black casters for hard surfaces
<b>K1000/8</b> Presto, Red Carpet		GL n/c glides
<b>K1000/8</b> Presto, Red Carpet		
<b>K1000/8</b> Presto, Red Carpet		
<b>K1196/14</b> EWC Sport Black		
		<i>Sliding Seat Option:</i>
		For sliding seat with 2.75" of depth adjustment insert SL after cylinder choice in pattern number. Adds 0.5" to seat height.
		<i>Code: Upchg: Description:</i>
		SL \$39 sliding seat

pattern no.	list price Presto base grade	A	COM B	C	D	E	F	G	H	I	T	COL U	V	W	X	Y
<b>99W-MBU-2- SY-NA-5-HC</b>	\$682.	\$713.	\$745.	\$778.	\$820.	\$864.	\$906.	\$949.	\$1,014.	\$1,089.	\$1,091.	\$1,166.	\$1,334.	\$1,543.	n/a	\$1,738.
<b>99W-MBU-2- SY-LA-5-HC</b>	735.	767.	799.	831.	874.	918.	961.	1,004.	1,069.	1,143.	1,144.	1,221.	1,388.	1,599.	n/a	1,792.
<b>99W-MBU-2- SY-FA-5-HC</b>	735.	767.	799.	831.	874.	918.	961.	1,004.	1,069.	1,143.	1,144.	1,221.	1,388.	1,599.	n/a	1,792.
<b>99W-MBU-2- SY-HA-5-HC</b>	765.	796.	828.	861.	903.	946.	990.	1,033.	1,098.	1,173.	1,175.	1,250.	1,417.	1,627.	n/a	1,822.

**Presto - Base Grade Fabric***Color options:*

Presto Winter White K1000/1  
Presto Sand K1000/2  
Presto Stone K1000/3  
Presto Saffron K1000/4  
Presto Spring Green K1000/5  
Presto Blue Chip K1000/6  
Presto Scarlet K1000/7  
Presto Red Carpet K1000/8  
Presto Beige Taupe K1000/9  
Presto Olive K1000/10  
Presto Navy Blue K1000/11  
Presto Clear Gray K1000/12  
Presto Charcoal Gray K1000/13  
Presto Black Tie K1000/14

*For split seat and back upholstery,  
indicate the words "seat" and "back"  
before the selected color.*

**EWC Sport Fabric***Back and Seat Accent Options:*

All EWC Sport chairs come standard with an EWC Sport fabric upholstered outer back accent. They can also be specified with optional EWC Sport fabric seat accents for an upcharge of \$27. EWC Sport fabric is available in three colors as outlined below. Chair can be fully upholstered in EWC Sport fabric as well (Grade A pricing).

*Color Options:*

EWC Sport Beige Taupe K1196/9  
EWC Sport Charcoal Gray K1196/13  
EWC Sport Black K1196/14

EWC Sport Fabric exceeds 100,000 double rubs Wyzenbeek method and is cleaning code W-S.

*Split Upholstery Option:*

EWC Sport seats and backs can be upholstered in any two approved Knoll Textiles or Spinneybeck upholsteries. To specify, first indicate the seat upholstery (labeled "seat upholstery") and then indicate the back upholstery (labeled "back upholstery"). The list price of the chair equals the list price of the higher of the two upholstery grades.

**COM/COL Upholstery Requirements**

Textile yardage required: 1.9 yards  
Leather sq. ft. required: 22 sq. ft.







*CAL 133 Options:*

*Code: Upchg: Description:*  
C133 \$78 CAL 133 textile on seat and back. Add C133 to the end of the pattern number

# EWC Sport™

## upholstered mid-back task chair

### swivel tilt control

	type	description
<p>Designer(s): Jeffrey Bernett and Nicholas Dodziuk, 2007</p>   <p>(Shown with EWC Sport Fabric Seat Accent Option)</p>	<p><b>99W-MBU-2-ST-NA-5-HC</b></p> 	Upholstered mid-back task chair with upholstered outer back, 2.5" back height adjustment, swivel-tilt control, armless
	<p><b>99W-MBU-2-ST-LA-5-HC</b></p> 	Upholstered mid-back task chair with upholstered outer back, 2.5" back height adjustment, swivel-tilt control, loop arms
	<p><b>99W-MBU-2-ST-FA-5-HC</b></p> 	Upholstered mid-back task chair with upholstered outer back, 2.5" back height adjustment, swivel-tilt control, fixed arms
	<p><b>99W-MBU-2-ST-HA-5-HC</b></p> 	Upholstered mid-back task chair with upholstered outer back, 2.5" back height adjustment, swivel-tilt control, height/width adjustable arms

For upholstery options and pricing, see facing page.

Order Code	Ordering Information	Options
<p><i>Example:</i> <b>99W-MBU-2-ST-HA-5-SL-HC K1000/8 K1000/8 K1000/8 K1196/14</b></p> <p><b>99W</b> EWC Sport task chair</p> <p><b>MB</b> Mid-back</p> <p><b>U</b> Upholstered outer back</p> <p><b>2</b> Black finish</p> <p><b>ST</b> Swivel tilt control</p> <p><b>HA</b> Height and width adjustable arms</p> <p><b>5</b> Standard height cylinder</p> <p><b>SL</b> Sliding seat</p> <p><b>HC</b> Hard wheel black casters</p> <p><b>K1000/8</b> Presto, Red Carpet</p> <p><b>K1000/8</b> Presto, Red Carpet</p> <p><b>K1000/8</b> Presto, Red Carpet</p> <p><b>K1196/14</b> EWC Sport Black</p>	<p><i>Specify:</i></p> <ol style="list-style-type: none"> <li>1. Pattern number</li> <li>2. Seat upholstery</li> <li>3. Seat accent upholstery</li> <li>4. Back upholstery</li> <li>5. Back accent upholstery</li> </ol> <p><i>Code:</i>      <i>Finish Color:</i></p> <p>2              Black</p>	<p><i>Cylinder Height Option:</i> For low height cylinder (14.4"-18.5" seat height range), replace 5 in pattern number with L.</p> <p><i>Code:</i>    <i>Upchg:</i>    <i>Description:</i></p> <p>L        \$71        low cylinder</p> <p><i>Sliding Seat Option:</i> For sliding seat with 2.75" of depth adjustment insert SL after cylinder choice in pattern number. Adds 0.5" to seat height.</p> <p><i>Code:</i>    <i>Upchg:</i>    <i>Description:</i></p> <p>SL        \$39        sliding seat</p> <p><i>Caster and Glide Options:</i> Substitute HC in pattern with one of the following options:</p> <p><i>Code:</i>    <i>Upchg:</i>    <i>Description:</i></p> <p>SC        n/c        soft black casters for hard surfaces</p> <p>GL        n/c        glides</p>

pattern no.	list price Presto base grade	A	COM B	C	D	E	F	G	H	I	T	COL			U	V	W	X	Y
<b>99W-MBU-2- ST-NA-5-HC</b>	\$585.	\$616.	\$649.	\$682.	\$725.	\$769.	\$812.	\$856.	\$921.	\$998.	\$998.	\$1,075.	\$1,244.	\$1,456.	n/a	\$1,654.			
<b>99W-MBU-2- ST-LA-5-HC</b>	639.	671.	703.	736.	780.	824.	868.	911.	977.	1,053.	1,054.	1,130.	1,299.	1,512.	n/a	1,710.			
<b>99W-MBU-2- ST-FA-5-HC</b>	639.	671.	703.	736.	780.	824.	868.	911.	977.	1,053.	1,054.	1,130.	1,299.	1,512.	n/a	1,710.			
<b>99W-MBU-2- ST-HA-5-HC</b>	669.	700.	733.	766.	809.	852.	897.	940.	1,006.	1,083.	1,083.	1,159.	1,330.	1,542.	n/a	1,739.			

**Presto - Base Grade Fabric***Color options:*

Presto Winter White K1000/1  
Presto Sand K1000/2  
Presto Stone K1000/3  
Presto Saffron K1000/4  
Presto Spring Green K1000/5  
Presto Blue Chip K1000/6  
Presto Scarlet K1000/7  
Presto Red Carpet K1000/8  
Presto Beige Taupe K1000/9  
Presto Olive K1000/10  
Presto Navy Blue K1000/11  
Presto Clear Gray K1000/12  
Presto Charcoal Gray K1000/13  
Presto Black Tie K1000/14

*For split seat and back upholstery,  
indicate the words "seat" and "back"  
before the selected color.*

**EWC Sport Fabric***Back and Seat Accent Options:*

All EWC Sport chairs come standard with an EWC Sport fabric upholstered outer back accent. They can also be specified with optional EWC Sport fabric seat accents for an upcharge of \$27. EWC Sport fabric is available in three colors as outlined below. Chair can be fully upholstered in EWC Sport fabric as well (Grade A pricing).

*Color Options:*

EWC Sport Beige Taupe K1196/9  
EWC Sport Charcoal Gray K1196/13  
EWC Sport Black K1196/14

EWC Sport Fabric exceeds 100,000 double rubs Wyzenbeek method and is cleaning code W-S.

*Split Upholstery Option:*

EWC Sport seats and backs can be upholstered in any two approved Knoll Textiles or Spinneybeck upholsteries. To specify, first indicate the seat upholstery (labeled "seat upholstery") and then indicate the back upholstery (labeled "back upholstery"). The list price of the chair equals the list price of the higher of the two upholstery grades.

**COM/COL Upholstery Requirements**

Textile yardage required: 1.9 yards  
Leather sq. ft. required: 22 sq. ft.

*CAL 133 Options:*

*Code: Upchg: Description:*  
C133 \$78 CAL 133 textile on seat and back. Add C133 to the end of the pattern number

# EWC Sport™

*upholstered mid-back conference chair*  
*synchronized tilt control*

Designer(s):	type	description
Jeffrey Bennett and Nicholas Dodziuk, 2007	<b>99C-MBU-2-SY- LA-5-HC</b>	Upholstered mid-back conference chair with upholstered outer back, fixed back height, synchronized control, loop arms



(Shown with EWC Sport Fabric  
Seat Accent Option)

For upholstery options and pricing, see facing page.

Order Code	Ordering Information	Options
<i>Example:</i> <b>99C-MBU-2-SY-LA-5-SL-HC K1000/8 K1000/8 K1000/8 K1196/14</b>	<i>Specify:</i> 1. Pattern number 2. Seat upholstery 3. Seat accent upholstery 4. Back upholstery 5. Back accent upholstery	<i>Cylinder Height Option:</i> For low height cylinder (14.4"-18.5" seat height range), replace 5 in pattern number with L.  <i>Code: Upchg: Description:</i> L \$71 low cylinder
<b>99C</b>	EWC Sport conference chair	<i>Caster and Glide Options:</i> Substitute HC in pattern with one of the following options:  <i>Code: Upchg: Description:</i> SC n/c soft black casters for hard surfaces GL n/c glides
<b>MB</b>	Mid-back	
<b>U</b>	Upholstered outer back	
<b>2</b>	Black finish	
<b>SY</b>	Synchronized tilt control	
<b>LA</b>	Loop width adjustable arms	
<b>5</b>	Standard height cylinder	
<b>SL</b>	Sliding seat	<i>Sliding Seat Option:</i> For sliding seat with 2.75" of depth adjustment insert SL after cylinder choice in pattern number. Adds 0.5" to seat height.  <i>Code: Upchg: Description:</i> SL \$39 sliding seat
<b>HC</b>	Hard wheel black casters	
<b>K1000/8</b>	Presto, Red Carpet	
<b>K1000/8</b>	Presto, Red Carpet	
<b>K1000/8</b>	Presto, Red Carpet	
<b>K1196/14</b>	EWC Sport Black	



pattern no.	list price Presto base grade	A	COM B	C	D	E	F	G	H	I	T	COL U	V	W	X	Y
<b>99C-MBU-2- SY-LA-5-HC</b>	\$729.	\$761.	\$794.	\$826.	\$869.	\$912.	\$955.	\$998.	\$1,064.	\$1,138.	\$1,139.	\$1,215.	\$1,383.	\$1,593.	n/a	\$1,787.

**Presto - Base Grade Fabric***Color options:*

Presto Winter White K1000/1  
Presto Sand K1000/2  
Presto Stone K1000/3  
Presto Saffron K1000/4  
Presto Spring Green K1000/5  
Presto Blue Chip K1000/6  
Presto Scarlet K1000/7  
Presto Red Carpet K1000/8  
Presto Beige Taupe K1000/9  
Presto Olive K1000/10  
Presto Navy Blue K1000/11  
Presto Clear Gray K1000/12  
Presto Charcoal Gray K1000/13  
Presto Black Tie K1000/14

*For split seat and back upholstery,  
indicate the words "seat" and "back"  
before the selected color.*

**EWC Sport Fabric***Back and Seat Accent Options:*

All EWC Sport chairs come standard with an EWC Sport fabric upholstered outer back accent. They can also be specified with optional EWC Sport fabric seat accents for an upcharge of \$27. EWC Sport fabric is available in three colors as outlined below. Chair can be fully upholstered in EWC Sport fabric as well (Grade A pricing).

*Color Options:*

EWC Sport Beige Taupe K1196/9  
EWC Sport Charcoal Gray K1196/13  
EWC Sport Black K1196/14

EWC Sport Fabric exceeds 100,000 double rubs Wyzenbeek method and is cleaning code W-S.

*Split Upholstery Option:*

EWC Sport seats and backs can be upholstered in any two approved Knoll Textiles or Spinneybeck upholsteries. To specify, first indicate the seat upholstery (labeled "seat upholstery") and then indicate the back upholstery (labeled "back upholstery"). The list price of the chair equals the list price of the higher of the two upholstery grades.

**COM/COL Upholstery Requirements**

Textile yardage required: 1.9 yards  
Leather sq. ft. required: 22 sq. ft.

*CAL 133 Options:*

<i>Code:</i>	<i>Upchg:</i>	<i>Description:</i>
C133	\$78	CAL 133 textile on seat and back. Add C133 to the end of the pattern number

# EWC Sport™

*upholstered mid-back conference chair*  
*swivel tilt control*

	type	description
<p><i>Designer(s):</i> Jeffrey Bernett and Nicholas Dodziuk, 2007</p>	<p><b>99C-MBU-2-ST-LA-5-HC</b></p>	<p>Upholstered mid-back conference chair with upholstered outer back, fixed back height, swivel-tilt control, loop arms</p>



(Shown with EWC Sport Fabric  
Seat Accent Option)

For upholstery options and pricing, see facing page.

Order Code	Ordering Information	Options	
<p><i>Example:</i> <b>99C-MBU-2-ST-LA-5-SL-HC K1000/8 K1000/8 K1000/8 K1196/14</b></p>	<p><i>Specify:</i></p> <ol style="list-style-type: none"> <li>1. Pattern number</li> <li>2. Seat upholstery</li> <li>3. Seat accent upholstery</li> <li>4. Back upholstery</li> <li>5. Back accent upholstery</li> </ol>	<p><i>Cylinder Height Option:</i> For low height cylinder (15"-19" seat height range), replace 5 in pattern number with L.</p>	<p><i>Caster and Glide Options:</i> Substitute HC in pattern with one of the following options:</p>
<p><b>99C</b> EWC Sport conference chair</p>	<p><i>Code:</i> <b>2</b> <i>Finish Color:</i> Black</p>	<p><i>Code: Upchg: Description:</i> L \$71 low cylinder</p>	<p><i>Code: Upchg: Description:</i> SC n/c soft black casters for hard surfaces</p>
<p><b>MB</b> Mid-back</p>			<p>GL n/c glides</p>
<p><b>U</b> Upholstered outer back</p>			
<p><b>2</b> Black finish</p>			
<p><b>ST</b> Swivel tilt control</p>		<p><i>Sliding Seat Option:</i> For sliding seat with 2.75" of depth adjustment insert SL after cylinder choice in pattern number. Adds 0.5" to seat height.</p>	
<p><b>LA</b> Loop width adjustable arms</p>		<p><i>Code: Upchg: Description:</i> SL \$39 sliding seat</p>	
<p><b>5</b> Standard height cylinder</p>			
<p><b>SL</b> Sliding seat</p>			
<p><b>HC</b> Hard wheel black casters</p>			
<p><b>K1000/8</b> Presto, Red Carpet</p>			
<p><b>K1000/8</b> Presto, Red Carpet</p>			
<p><b>K1000/8</b> Presto, Red Carpet</p>			
<p><b>K1196/14</b> EWC Sport Black</p>			

pattern no.	list price Presto base grade	A	COM B	C	D	E	F	G	H	I	T	COL U	V	W	X	Y
<b>99C-MBU-2- ST-LA-5-HC</b>	\$633.	\$665.	\$698.	\$730.	\$775.	\$818.	\$863.	\$906.	\$972.	\$1,047.	\$1,047.	\$1,124.	\$1,294.	\$1,507.	n/a	\$1,704.

**Presto - Base Grade Fabric**

*Color options:*

- Presto Winter White K1000/1
- Presto Sand K1000/2
- Presto Stone K1000/3
- Presto Saffron K1000/4
- Presto Spring Green K1000/5
- Presto Blue Chip K1000/6
- Presto Scarlet K1000/7
- Presto Red Carpet K1000/8
- Presto Beige Taupe K1000/9
- Presto Olive K1000/10
- Presto Navy Blue K1000/11
- Presto Clear Gray K1000/12
- Presto Charcoal Gray K1000/13
- Presto Black Tie K1000/14

*For split seat and back upholstery, indicate the words "seat" and "back" before the selected color.*

**EWC Sport Fabric**

*Back and Seat Accent Options:*

All EWC Sport chairs come standard with an EWC Sport fabric upholstered outer back accent. They can also be specified with optional EWC Sport fabric seat accents for an upcharge of \$27. EWC Sport fabric is available in three colors as outlined below. Chair can be fully upholstered in EWC Sport fabric as well (Grade A pricing).

*Color Options:*

- EWC Sport Beige Taupe K1196/9
- EWC Sport Charcoal Gray K1196/13
- EWC Sport Black K1196/14

EWC Sport Fabric exceeds 100,000 double rubs Wyzenbeek method and is cleaning code W-S.

*Split Upholstery Option:*

EWC Sport seats and backs can be upholstered in any two approved Knoll Textiles or Spinneybeck upholsteries. To specify, first indicate the seat upholstery (labeled "seat upholstery") and then indicate the back upholstery (labeled "back upholstery"). The list price of the chair equals the list price of the higher of the two upholstery grades.

**COM/COL Upholstery Requirements**

Textile yardage required: 1.9 yards  
Leather sq. ft. required: 22 sq. ft.

*CAL 133 Options:*

<i>Code:</i>	<i>Upchg:</i>	<i>Description:</i>
C133	\$78	CAL 133 textile on seat and back. Add C133 to the end of the pattern number

# EWC Sport™

## seat and back replacements for task and conference chairs

	pattern no.	description
<i>Designer(s):</i> Jeffrey Bernett and Nicholas Dodziuk, 2007	<b>ESSENSPORT-SEAT</b>	Replacement upholstered seat for EWC Sport Task and conference chairs
	<b>99WMBSPORT-BACK</b>	Replacement upholstered back for EWC Sport Task chair with upholstered outer back and 2.5" back height adjustment
	<b>99CMBSPORT-BACK</b>	Replacement upholstered back for EWC Sport conference chair with upholstered outer back and fixed back height



(Shown with EWC Sport Fabric Seat Accent Option)

For upholstery options and pricing, see facing page.

Order Code	Ordering Information	Presto - Base Grade Fabric	EWC Sport Fabric
<i>Example:</i> <b>ESSENSPORTSEAT - K1000/8 K1196/14</b>	<i>Specify:</i> 1. Pattern number 2. Seat upholstery and seat accent upholstery 3. Back upholstery and back accent upholstery	<i>Color options:</i> Presto Winter White K1000/1 Presto Sand K1000/2 Presto Stone K1000/3 Presto Saffron K1000/4 Presto Spring Green K1000/5 Presto Blue Chip K1000/6 Presto Scarlet K1000/7 Presto Red Carpet K1000/8 Presto Beige Taupe K1000/9 Presto Olive K1000/10 Presto Navy Blue K1000/11 Presto Clear Gray K1000/12 Presto Charcoal Gray K1000/13 Presto Black Tie K1000/14	<i>Back and Seat Accent Options:</i> All EWC Sport chairs come standard with an EWC Sport fabric upholstered outer back accent. They can also be specified with optional EWC Sport fabric seat accents for an upcharge of \$27. EWC Sport fabric is available in three colors as outlined below. Chair can be fully upholstered in EWC Sport fabric as well (Grade A pricing). Color Options: EWC Sport Beige Taupe K1196/9 EWC Sport Charcoal Grey K1196/13 EWC Sport Black K1196/14 EWC Sport Fabric exceeds 100,000 double rubs Wyzenbeek method and is cleaning code W-S.
<b>ESSEN SPORT-SEAT</b> Upholstered seat replacement <b>K1000/8</b> Presto Red Carpet <b>K1196/14</b> EWC Sport Black	<b>COM/COL Upholstery Requirements</b> <i>Textile yardage required: 1.9 yds.</i> <i>Leather sq. ft. required: 22 sq. ft.</i>		

pattern no.	list price Presto base grade	A	COM B	C	D	E	F	G	H	I	T	COL U	V	W	X	Y
<b>ESSENSPORT SEAT</b>	\$148.	\$170.	\$180.	\$192.	\$207.	\$213.	\$230.	\$234.	\$274.	\$280.	\$314.	\$345.	\$415.	\$504.	n/a	\$586.
<b>99WMB-SPORTBACK</b>	337.	381.	405.	438.	478.	517.	564.	584.	596.	623.	754.	882.	1,006.	1,216.	n/a	1,418.
<b>99CMB-SPORTBACK</b>	337.	381.	405.	438.	478.	517.	564.	584.	596.	623.	754.	882.	1,006.	1,216.	n/a	1,418.

**Options**

*CAL 133 Options:*

Code:	Upchg:	Description:
C133	\$78	CAL 133 textile on seat and back. Add C133 to the end of the pattern number

# EWC Sport™ Task Dimensions and Operating Instructions

<b>Seat*</b>	<b>BIFMA G1-2002 Ergonomic Guidelines</b>	<b>EWC Sport Mid-back Task Ergonomic Dimensions</b>
Seat Height	15" - 19.9" minimum range (one or combination of chairs)	without seat slider 15.6" - 20.25" (std.) 14.4" - 18.5" (low)  with seat slider 16.1" - 20.75" (std.) 14.9" - 19" (low)
Seat Depth	16.9" or less fixed, include if adjustable	16.9" (fixed) 16.25" to 19" (adjustable)
Seat Width	18" min	19.75"
Seat Pan Angle (at rest)	0° - 4° rearward	3.5°
<b>Back*</b>		
Backrest Height	12.2" min	22" - 24.5"
Backrest Width	14.2" min	19.25"
Lumbar support	5.9" - 9.8" (adjustable include part of range)	6.5" - 9.25"
Angle Between Seat and Back	90° - 115°	98°
Tilt Range of Back	10° min	26° (synchro) 12° (swivel)
<b>Arms*</b>		
Armrest Height (fixed)	7.9" - 9.8"	8.2"
Armrest Height (loop)	7.9" - 9.8"	8"
Armrest Height (adjustable)	6.9" - 10.8"	7" - 10.5"
Inside Distance Between Armrest (fixed/adjustable)	18" min fixed, include 18" if adjustable	18.4" - 20.4"
Inside Distance Between Armrest (loop)	18" min	19.7" - 21.9"
*All measurements taken with BIFMA Chair Measuring Device using the Universal Measurement Procedure which has a measurement uncertainty of ±5%		
<b>Chair</b>		
<b>A</b> Overall Height (std cylinder)		37.1" - 41.75"
<b>B</b> Overall Width		29"
<b>C</b> Overall Depth		27"
<b>D</b> Fixed Arm Height From Floor (std. cylinder) Loop Arm Height From Floor (std. cylinder) Adj. Arm Height From Floor (std. cylinder)		23.75" - 28.5" 24" - 28.8" 22.5" - 30.75"
<b>E</b> Recline Range  Back Recline Ratio		98° - 124° (synchro) 98° - 110° (swivel) 1:3 (synchro) 1:1 (swivel)
<b>F</b> Base Diameter		27"
<b>G</b> Weight		46 lbs.

**EWC Sport Task**

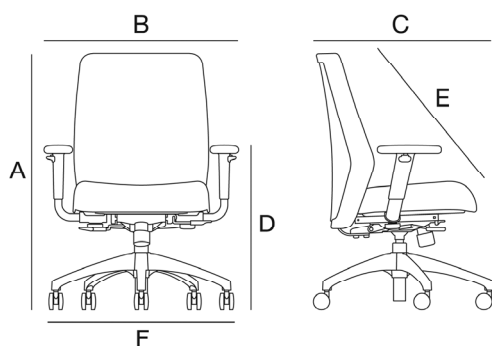

Compliance: ANSI/BIFMA x5.1-2002, BIFMA G1-2002 Ergonomic Guidelines, Cal 117, Cal 133 (with approved FR upholstery)

## EWC Sport Task Chairs

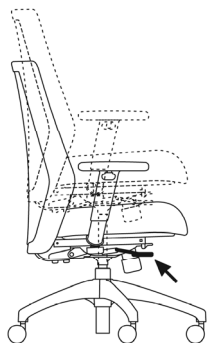

### Seat Height

To raise the seat height, remove your weight from the chair while lifting the lever under the right side of the seat. To lower the seat height, lift the lever while sitting in the chair.

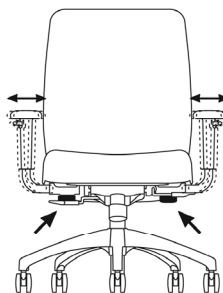

### Adjustable Arm Width

To adjust the arm width, loosen the knob under the arm support by turning clockwise. Slide the support toward or away from the seat to adjust the arm width. Tighten the knob under the arm. The arms adjust 1" in width per side (2" total).

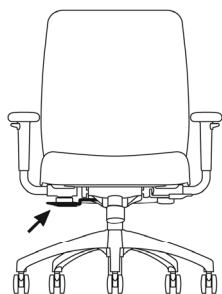

### Tilt Lock

To recline, pull out the lever under the right side of the seat. To lock the chair upright, push the lever in.

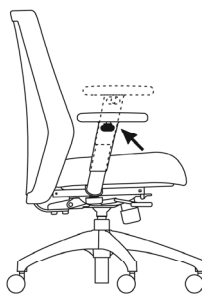

### Adjustable Arm Height (Optional)

To adjust the arm pad height, lift the lever on the outside of the arm support and move the arm up or down. Release the lever to lock. The arms have a 3.5" range of adjustment.



### Tilt Tension

To adjust the tilt tension, turn the knob under the front of the seat. Turn counterclockwise to tighten, and clockwise to loosen.

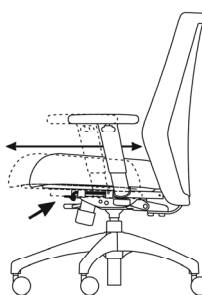

### Sliding Seat Depth Adjustment (Optional)

To adjust the seat depth, lift the lever under the left side of the seat and slide the seat to the desired location. Release the lever to lock. There are 6 positions within a 2.75" range.

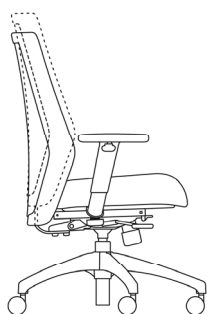

### Back Height (Task chairs only)

To raise the back height, firmly hold both sides of the back and lift. The back height adjust 9 notches upward for a total of 2.5" of adjustability. To lower the back height, first raise the back to the highest position; the top notch releases the back to the lowest position.

# EWC Sport™ Conference Dimensions and Operating Instructions

<b>Seat*</b>	<b>BIFMA G1-2002 Ergonomic Guidelines</b>	<b>EWC Sport Mid-back Conference Ergonomic Dimensions</b>
Seat Height	15" - 19.9" minimum range (one or combination of chairs)	without seat slider 15.6" - 20.25" (std.) 14.4" - 18.5" (low)  with seat slider 16.10" - 20.75" (std.) 14.9" - 19" (low)
Seat Depth	16.9" or less fixed, include if adjustable	16.9" (fixed) 16.25" to 19" (adjustable)
Seat Width	18" min	19.75"
Seat Pan Angle (at rest)	0° - 4° rearward	3.5°
<b>Back*</b>		
Backrest Height	12.2" min	22.75"
Backrest Width	14.2" min	19.25"
Lumbar support	5.9" - 9.8"	8.25"
Angle Between Seat and Back	90° - 115°	94.8°
Tilt Range of Back	10° min	26° (synchro) 12° (swivel)
<b>Arms*</b>		
Arm Rest Height (loop)	7.9" - 9.8"	8"
Inside Distance Between Armrest (loop)	18" min	19.7" - 21.9"
*All measurements taken with BIFMA Chair Measuring Device using the Universal Measurement Procedure which has a measurement uncertainty of ±5%		
<b>Chair</b>		
<b>A</b> Overall Height (std cylinder)		37.1" - 41.75"
<b>B</b> Overall Width		29"
<b>C</b> Overall Depth		27"
<b>D</b> Loop Arm Height From Floor (std. cylinder)		24" - 28.8"
<b>E</b> Recline Range		98° - 124° (synchro) 98° - 110° (swivel)
Back Recline Ratio		1:3 (synchro) 1:1 (swivel)
<b>F</b> Base Diameter		27"
<b>G</b> Weight		46 lbs.

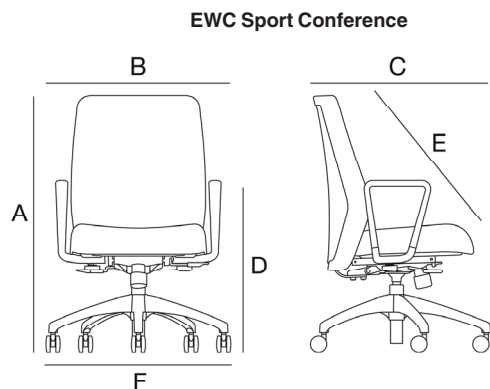

Compliance: ANSI/BIFMA x5.1-2002, BIFMA G1-2002 Ergonomic Guidelines, Cal 117, Cal 133 (with approved FR upholstery)



## EWC Sport Conference Chairs

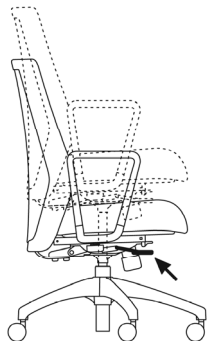

### Seat Height

To raise the seat height, remove your weight from the chair while lifting the lever under the right side of the seat. To lower the seat height, lift the lever while sitting in the chair.

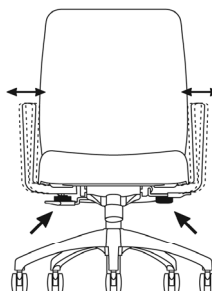

### Adjustable Arm Width

To adjust the arm width, loosen the knob under the arm support by turning clockwise. Slide the support toward or away from the seat to adjust the arm width. Tighten the knob under the arm. The arms adjust 1" in width per side (2" total).

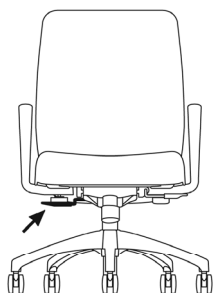

### Tilt Lock

To recline, pull out the lever under the right side of the seat. To lock the chair upright, push the lever in.

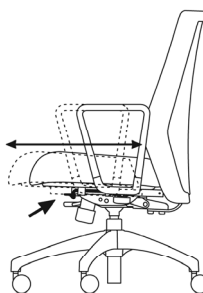

### Sliding Seat Depth Adjustment (Optional)







To adjust the seat depth, lift the lever under the left side of the seat and slide the seat to the desired location. Release the lever to lock. There are 6 positions within a 2.75" range.



### Tilt Tension

To adjust the tilt tension, turn the knob under the front of the seat. Turn counterclockwise to tighten, and clockwise to loosen.

# SoHo™ task chair

	pattern no.	description	
<p><i>Designer(s):</i> Roberto Lucci and Paolo Orlandini, 1994</p> <p><i>Award(s):</i> I.D. Design Distinction Award, 1996; IIDA, L.A. Chapter, Acclaim Award, 1995</p> 	<b>28A-1-FD5GH</b>	armchair, upholstered seat and back	
			
	<b>28A-1-SD5GH</b>	armchair, upholstered seat only	
			
	<b>28A-1-ND5GH</b>	armchair, non-upholstered	
			
	<b>28C-1-FD5GH</b>	armless chair, upholstered seat and back	
			
	<b>28C-1-SD5GH</b>	armless chair, upholstered seat only	
			
<b>28C-1-ND5GH</b>	armless chair, non-upholstered		
			
	<b>28FSEAT</b>	seat reupholstery assembly	
	<b>28F1BACK</b>	back reupholstery assembly	

## Order Code

<i>Example:</i>	<b>28C-1-SD5GH-K642/28</b>
<b>28C</b>	SoHo armless chair
<b>1</b>	dark grey finish
<b>S</b>	upholstered seat only
<b>D5G</b>	task chair
<b>H</b>	hard-wheel caster
<b>K642/28</b>	Mariner/tomato

## Ordering Information

*Specify:*

1. Pattern number with finish color code.
2. Upholstery selection with color.

List prices shown include fabric or leather upholstery. Contact your Knoll representative for colors.

*Finish color:*  
Dark grey (code 1)

## Options

Code	Upchg:	Description:
R	\$51	soft caster for hardwood floors (substitute R for H in pattern number)
G	n/c	glides (substitute G for H at the end of pattern number.)

## Construction

*Shell:*  
Integrally colored, textured polypropylene.

*Upholstery:*  
High density CFC-free molded urethane foam. Fabric is permanently bonded to seat and back cushions.

*Arms:*  
Integrally colored, textured, glass-reinforced nylon with polypropylene arm caps.

*Base:*  
Integrally colored, textured glass-reinforced nylon. Five-star design. *Standard casters:* Black, integrally colored, textured nylon; 2" dual hooded, hard-wheel design.

*Glides:*



Black, integrally colored, molded nylon; 2" caster; does not reduce height of chair.

pattern no.	list price	grades <b>A</b>	COM <b>B</b>	<b>C</b>	<b>D</b>	<b>E</b>	<b>F</b>	<b>G</b>	<b>H</b>	<b>I</b>
<b>28A-1-FD5GH</b>		\$688.	\$737.	\$787.	\$818.	\$843.	\$864.	\$894.	\$907.	\$945.
<b>28A-1-SD5GH</b>		627.	675.	723.	754.	780.	804.	830.	850.	883.
<b>28A-1-ND5GH</b>	567.									
<b>28C-1-FD5GH</b>		657.	704.	754.	785.	809.	830.	862.	874.	912.
<b>28C-1-SD5GH</b>		595.	641.	693.	722.	747.	773.	800.	818.	850.
<b>28C-1-ND5GH</b>	531.									
<b>28FSEAT</b>		136.	187.	237.	247.	253.	259.	292.	294.	340.
<b>28F1BACK</b>		136.	187.	237.	247.	253.	259.	292.	294.	340.

#### COM/COL Textile Requirement

chair fabric  
yds.  
.75

*COM Policy:*  
Please see COM Process Overview at the beginning of this Price List.

Upholstery on SoHo chairs is standard either on seat only, or on seat and back. Seat and back pads are shipped mounted to the chairs, and can be removed and reattached with special instructions from Customer Service.







*Split upholstery option:*  
SoHo Chair seats and backs can be upholstered in any two fabric colors on standard lead time orders. To specify, first indicate the seat upholstery (labeled “seat upholstery”) and then indicate the back upholstery (labeled “back upholstery”). The list price of the chair equals the list price of the higher of the two upholstery grades.

#### KnollTextiles and Spinneybeck Leathers

Please refer to the matrices at the beginning of the price list for Approved Textiles and Leathers.

SoHo™  
side chair

	pattern no.	description
<p><i>Designer(s):</i> Roberto Lucci and Paolo Orlandini, 1994</p> 	<b>28C-1-NSL</b>	unupholstered seat and back, stacks to 10 high stacks to 10 high
		
	<b>28C-1-SSL</b>	upholstered seat only, non-stacking non-stacking
		
	<b>28C-1-FSL</b>	fully upholstered, non-stacking non-stacking
		
	<b>28FSEAT</b>	seat reupholstery assembly
	<b>28F1BACK</b>	back reupholstery assembly

Order Code	Ordering Information	Construction	COM/COL Textile Requirement
<i>Example:</i> <b>28C-1-SSL-K642/28</b>	<i>Specify:</i>	<i>Shell:</i>	fabric
<b>28C</b> SoHo armless chair	1. Pattern number with finish color code.	Integrally colored, textured polypropylene.	yds.
<b>1</b> dark grey finish	2. Upholstery selection with color.		chair .75
<b>S</b> upholstered seat only	List prices shown include fabric or leather upholstery. Contact your Knoll representative for colors.	<i>Upholstery:</i> High density CFC-free molded urethane foam. Fabric is permanently bonded to seat and back cushions.	<i>COM Policy:</i> Please see COM Process Overview at the beginning of this Price List.
<b>SL</b> side chair	<i>Finish color:</i> Dark grey (code 1)	<i>Base:</i> Powder coated steel frame.	
<b>K642/28</b> Mariner/tomato			

pattern no.	list price	grades <b>A</b>	COM <b>B</b>	<b>C</b>	<b>D</b>	<b>E</b>	<b>F</b>	<b>G</b>	<b>H</b>	<b>I</b>
<b>28C-1-NSL</b>	\$275.									
<b>28C-1-SSL</b>		405.	450.	495.	524.	546.	568.	596.	614.	645.
<b>28C-1-FSL</b>		491.	534.	580.	609.	631.	653.	682.	698.	732.
<b>28FSEAT</b>		136.	187.	237.	247.	253.	259.	292.	294.	340.
<b>28F1BACK</b>		136.	187.	237.	247.	253.	259.	292.	294.	340.

**KnollTextiles and Spinneybeck Leathers**

Upholstery on SoHo chairs is standard either on seat only, or on seat and back. Seat and back pads are shipped mounted to the chairs, and can be removed and reattached with special instructions from Customer Service.



*Split upholstery option:*  
SoHo Chair seats and backs can be upholstered in any two fabric colors on standard lead time orders. To specify, first indicate the seat upholstery (labeled “seat upholstery”) and then indicate the back upholstery (labeled “back upholstery”). The list price of the chair equals the list price of the higher of the two upholstery grades.

Please refer to the matrices at the beginning of the price list for Approved Textiles and Leathers.

# SoHo™ dolly

pattern no. description

**28DOLLY**

Dolly to transport up to 10 unupholstered SoHo side chairs



## Order Code

*Example:* **28DOLLY**

**28DOLLY** SoHo dolly

*Specify:*

1. Pattern number.

## Construction

Powder coated, silver-grey steel frame with rubber wheels.

Holds up to 10 unupholstered SoHo side chairs.

Upholstered chairs are not stackable.

Dollies can be stacked three high for compact storage.

---

pattern no.	list price
<b>28DOLLY</b>	<b>\$422.</b>

---

# SoHo Dimensions and Operating Instructions

## Seat

	Seat Height	Seat Depth	Seat Width	Seat Pan Angle	Seat Back/ Seat Pan Angle
ANSI HFS 100-1988, Ergonomic Guidelines:					
	16" - 20 <sup>1</sup> / <sub>2</sub> "	15" - 17"	18 <sup>1</sup> / <sub>8</sub> " min.	0° - 10°	90° - 105°
<b>Task</b>	16" - 20 <sup>1</sup> / <sub>2</sub> "	17" - 18 <sup>1</sup> / <sub>2</sub> "	19"	7°	95° - 105°
<b>Side</b>	18 <sup>3</sup> / <sub>4</sub> "	18"	20"	7°	95° - 105°

## Back

	Backrest	Lumbar Support Height	Lumbar Support Width	Lumbar Support Center	Seat Back Width
ANSI HFS 100-1988, Ergonomic Guidelines:					
	yes	6" - 9"	12" min.	6" - 10"	12" min.
<b>Task</b>	yes	7"	17"	8"	19"
<b>Side</b>	yes	7"	17"	8"	19"

## Armrests

Width Between Armrests
18 <sup>1</sup> / <sub>8</sub> " min.
19 <sup>1</sup> / <sub>4</sub> "
n/a

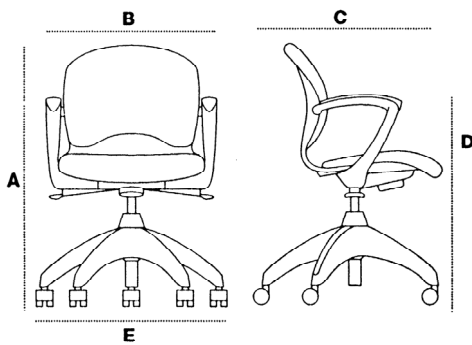

## Arm Chair

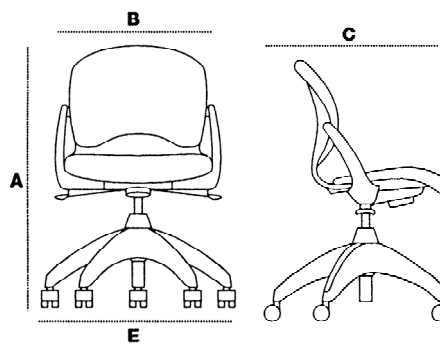
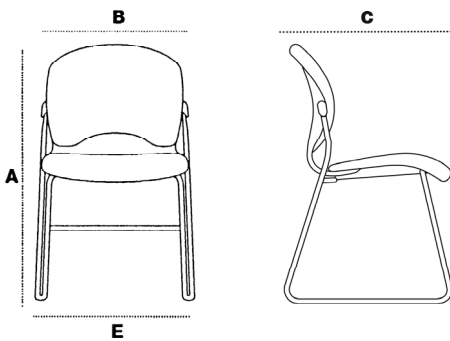

## Armless Chair

## Side Chair

	Task Arm	Task Armless	Side
<b>A</b> overall height	30 <sup>1</sup> / <sub>4</sub> " - 35 <sup>1</sup> / <sub>4</sub> "	30" - 35"	32 <sup>1</sup> / <sub>2</sub> "
<b>B</b> overall width	24"	22"	22"
<b>C</b> overall depth	22"	22"	23"
<b>D</b> arm height	24" - 28 <sup>1</sup> / <sub>2</sub> "	n/a	n/a
<b>E</b> base diameter/depth	25 <sup>1</sup> / <sub>2</sub> "	25 <sup>1</sup> / <sub>2</sub> "	21 <sup>1</sup> / <sub>4</sub> "
weight	23 lbs.		

SoHo dolly measures 18" wide, 30" deep and 23.5" high



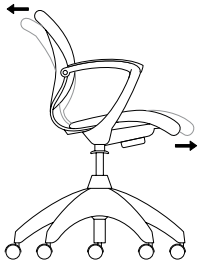

**Synchronized Sliding Seat and Back Tilt Mechanism**

To recline lean back with your weight and allow the seat to slide forward slightly as you recline.

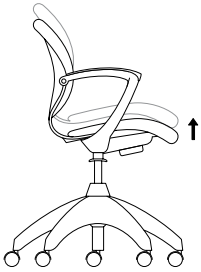

**Seat Height Adjustment**

To adjust the height, lift the handle on the right side of the seat.

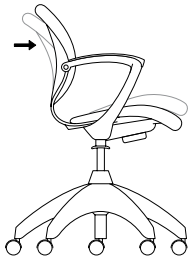

**Tilt Lock**

To lock the chair upright push down on the handle under the left side of the chair. Pull up on the lever to recline again.

# Alpha-Numeric Index

<i>pattern no.</i>	<i>page</i>	<i>pattern no.</i>	<i>page</i>	<i>pattern no.</i>	<i>page</i>
28A-1-FD5GH	162	77W-HB-2-SY-NA-5-HC	116	8P5-2-A5KH	100
28A-1-ND5GH	162	77WHIGHBACK	126	8RBACK	94, 96, 98, 100
28A-1-SD5GH	162	77W-MB-2-ST-FA-5-HC	110	8RSEAT	94, 96, 98, 100
28C-1-FD5GH	162	77W-MB-2-ST-HA-5-HC	110	8UPHBACK	94, 96, 98, 100
28C-1-FSL	164	77W-MB-2-ST-LA-5-HC	110	99CMBSPOORTBACK	156
28C-1-ND5GH	162	77W-MB-2-ST-NA-5-HC	110	99C-MBU-2-ST-LA-5-HC	154
28C-1-NSL	164	77W-MB-2-SY-FA-5-HC	108	99C-MBU-2-SY-LA-5-HC	152
28C-1-SD5GH	162	77W-MB-2-SY-HA-5-HC	108	99WMBSPOORTBACK	156
28C-1-SSL	164	77W-MB-2-SY-LA-5-HC	108	99W-MBU-2-ST-FA-5-HC	150
28DOLLY	166	77W-MB-2-SY-NA-5-HC	108	99W-MBU-2-ST-HA-5-HC	150
28F1BACK	162, 164	77WMIDBACK	126	99W-MBU-2-ST-LA-5-HC	150
28FSEAT	162, 164	77WUHIGHBACK	126	99W-MBU-2-ST-NA-5-HC	150
33-AA-1-BK-B-S-X-HC	70	77WUMIDBACK	126	99W-MBU-2-SY-FA-5-HC	148
33-AA-1-BK-T-S-X-HC	68	7A1-1-A5G-H	82	99W-MBU-2-SY-HA-5-HC	148
33-AA-2-BK-B-S-X-HC	74	7A1-1-B5G-H	82	99W-MBU-2-SY-LA-5-HC	148
33-AA-2-BK-T-S-X-HC	72	7A3-1-A5G-H	80	99W-MBU-2-SY-NA-5-HC	148
33-FA-1-BK-B-S-X-HC	70	7A3-1-B5G-H	80	C	80, 82, 84, 86, 88
33-FA-1-BK-T-S-X-HC	68	7A4-1-A5G-H	84	ESSENSIDESEAT	126, 142
33-FA-2-BK-B-S-X-HC	74	7A4-1-B5G-H	84	ESSENSPOORT SEAT	156
33-FA-2-BK-T-S-X-HC	72	7A5-1-A5G-H	86	ESSENWORKSEAT	126, 142
33-NA-1-BK-B-S-X-HC	70	7A5-1-B5G-H	86	S9013DSEAT	42
33-NA-1-BK-T-S-X-HC	68	7A8-1-SL	88	S9013RSEAT	42
33-NA-2-BK-B-S-X-HC	74	7C1-1-A5G-H	82	S901A	34
33-NA-2-BK-T-S-X-HC	72	7C1-1-B5G-H	82	S901C	34, 36
45A1-A5G-H	28	7C3-1-A5G-H	80	S901P	34
45A1-SL	30	7C3-1-B5G-H	80	S903A	38
45A3-A5G-H	26	7C4-1-A5G-H	84	S903C	38, 40
45C1-A5G-H	28	7C4-1-B5G-H	84	S903P	38
45C1-SL	30	7C5-1-A5G-H	86	S908-2-SL-2	44
45C3-A5G-H	26	7C5-1-B5G-H	86	S908-4-SL-2	44
55A-3	48, 50, 52, 54, 56, 58	7C8-1-SL	88	S908-C-SL-2	44
55BACKTOPPER	60	7RB1	82	U 80, 82, 84, 86, 88, 108, 110, 112, 114, 116, 118, 120, 122, 124	
55C-3	48, 50, 52, 54, 56, 58	7RB3	80		
55FABRICTOPPER	60	7RB4	84, 86		
55H-3	48, 50, 52, 54, 56, 58	7RS2	84, 86		
55LUMBAR	60	7RS3	80, 82		
55M-3	48, 50, 52, 54, 56, 58	88C-MB-2-ST-LA-5-HC	138		
55P-3	48, 50, 52, 54, 56, 58	88C-MB-2-SY-LA-5-HC	136		
55SEATTOPPER	60	88S-2-FA-HC	140		
6A8	102	88S-2-NA-HC	140		
6C8	102	88SBACK	142		
6RS8	102	88WBACK	142		
77C-HB-2-ST-LA-5-HC	122	88W-MB-2-ST-FA-5-HC	134		
77C-HB-2-SY-LA-5-HC	120	88W-MB-2-ST-HA-5-HC	134		
77CHIGHBACK	126	88W-MB-2-ST-LA-5-HC	134		
77C-MB-2-ST-LA-5-HC	114	88W-MB-2-ST-NA-5-HC	134		
77C-MB-2-SY-LA-5-HC	112	88W-MB-2-SY-FA-5-HC	132		
77CMIDBACK	126	88W-MB-2-SY-HA-5-HC	132		
77CUHIGHBACK	126	88W-MB-2-SY-LA-5-HC	132		
77CUMIDBACK	126	88W-MB-2-SY-NA-5-HC	132		
77S-2-FA-HC	124	8A4-2-A5GH	94		
77S-2-NA-HC	124	8A4-2-A5KH	96		
77SBACK	126	8A5-2-A5GH	98		
77SUBACK	126	8A5-2-A5KH	100		
77W-HB-2-ST-FA-5-HC	118	8C4-2-A5GH	94		
77W-HB-2-ST-HA-5-HC	118	8C4-2-A5KH	96		
77W-HB-2-ST-LA-5-HC	118	8C5-2-A5GH	98		
77W-HB-2-ST-NA-5-HC	118	8C5-2-A5KH	100		
77W-HB-2-SY-FA-5-HC	116	8P4-2-A5GH	94		
77W-HB-2-SY-HA-5-HC	116	8P4-2-A5KH	96		
77W-HB-2-SY-LA-5-HC	116	8P5-2-A5GH	98		

# Selling Policy

	<p>This Selling Policy supercedes all previous selling policies. Prices, discounts and product offerings are subject to change without notice.</p>
<b>Terms &amp; Conditions of Sales</b>	<p>Sales by Knoll, Inc. or Knoll North America Corp. ("Seller") of Knoll Product Lines (hereinafter "Products") within the United States and Canada are made only on the terms which are contained in this Selling Policy. Seller hereby gives notice of its objection to any different or additional terms and conditions. This sale is expressly conditional upon Purchaser's assent to the terms and conditions set forth below. Additional terms and conditions may apply to KnollStudio and KnollTextiles orders. These terms and conditions may be modified or supplemented only by a written document signed by an authorized representative of Seller. These terms and conditions supercede any prior and/or contemporaneous agreements or correspondence between Purchaser and Seller. Written quotations expire thirty (30) days from the date of issuance and can be withdrawn by written notice anytime during that period. Where Purchaser and Seller have entered into the Knoll Electronic Terms and Conditions, all orders, acknowledgements, invoices and other business communications placed or transmitted in accordance with the Knoll Electronic Terms and Conditions shall be deemed to be in writing and signed and shall be valid for all purposes as if they were originated and maintained in documentary form.</p>
<b>Ordering Information</b>	<p>All orders must be in writing. The product pattern number(s) contained on Seller's order acknowledgement shall be the final expression of the order.</p>
<b>Order Confirmation</b>	<p>A purchase order is not binding on Seller until Purchaser has received Seller's order confirmation or acknowledgment.</p>
<b>Pricing Policies</b>	<p>List prices are subject to change without notice.</p> <p>List prices shall be those prices in effect on the date of receipt of a complete purchase order unless shipment is requested more than ninety (90) days after order entry in which case prices in effect on the date of shipment apply. List prices include specified freight costs. Unless specified in writing by Seller, no other charges are included in Seller's list prices.</p>
<b>Taxes</b>	<p>All sales, use, excise and other taxes applicable to the sale of the Products shall be paid by Purchaser. If Purchaser claims an exemption from any tax, Purchaser shall submit to Seller the appropriate exemption certificates.</p>
<b>Terms of Payment</b>	<p>Payment for one hundred percent (100%) of the net order amount is due within thirty (30) days of the date of invoice, which is issued upon shipment. In case of any discrepancies, such as shortages, and Seller is notified in writing within ten (10) days of receipt of Product, only that portion may be deducted and the balance paid. For orders greater than \$100,000 net, a one-third (1/3) deposit is due at the time of order placement, with the remainder due within thirty (30) days of the date of invoice.</p> <p>KnollStudio orders less than \$2,000 require payment for one hundred percent (100%) of the net order amount (including any applicable sales tax and charges for inside delivery, special packaging, etc.), due at time of order placement. For KnollStudio orders greater than \$2,000, a one-half (50%) deposit is due at time of order placement with the remainder (including any applicable sales tax and charges for inside delivery, special packaging, etc.) due prior to shipment.</p> <p>If, in the judgment of Seller, Purchaser's financial condition does not justify the terms of the payment, Seller may require full or partial payment in advance.</p> <p>Past due accounts shall be charged one and one-half percent (1.5%) per month, or the highest rate permitted by law, whichever is less, and will be added to the outstanding balance. In the event Purchaser defaults on payment, Purchaser shall be liable for all collection costs, including reasonable attorney's fees and costs.</p>
<b>Changes and Cancellation</b>	<p>Purchase orders may not be changed or cancelled, in whole or in part, without prior written consent of Seller. Changes may effect delivery dates. Expenses incurred because of changes shall be charged to Purchaser. In the event of cancellations, Purchaser will be liable for reasonable cancellation charges established by Seller. Orders for special Product, orders including "COM" (hereinafter defined) material and orders pursuant to expedited delivery programs, may not be canceled.</p>
<b>Freight Prepaid</b>	<p>Freight is prepaid and included in the price of all Products, except KnollTextiles, within the 48 contiguous United States for orders placed with Knoll, Inc. and within Canada, excluding the Yukon, Northwest Territories, Nunavut and Newfoundland for orders placed with Knoll North America Corp. Packing is tested for rigorous motion and transportation but is not guaranteed to protect furniture from conditions over which the Seller has no control. If special packaging is required for any reason, please consult with your sales representative or dealer. Seller shall select the method of shipment and routing. All shipments shall be tailgate deliveries. Freight for all KnollTextiles orders is prepaid and added to the invoice.</p>
<b>Delivery/Freight Charges</b>	<p>Shipments outside the contiguous 48 United States and Canada shall be shipped F.O.B. Origin.</p> <p>For shipments outside the contiguous United States and Canada, Purchaser is responsible for the cost of freight from point of embarkation, including any handling and transportation charges incidental to loading at the point of departure and unloading at the final destination.</p> <p>Conditions beyond the control of Seller, including weather, available facilities and traffic conditions, may affect exact time of delivery. Seller shall not be responsible for specific carrier delivery date or time unless it has made a specific delivery commitment, in writing.</p> <p>Nonstandard methods of shipment and/or additional services are available upon request. Purchaser will be billed for the differential cost of any special services in excess of standard surface carrier freight costs. Premium charges, at Purchaser's request, will be added for airfreight, exclusive use of vehicle and extra, export or special packaging. Accessorial charges will be added for inside delivery, extra labor, reassignment and redelivery.</p> <p>Partial shipments may be made and invoiced by Seller.</p>
<b>Claims</b>	<p>All shipments for all Knoll Products within the contiguous United States and Canada are F.O.B. Origin. Risk of loss passes to Purchaser at time of delivery to carrier. Purchaser shall inspect all Products upon receipt and notify Seller within ten (10) working days after receipt of any damage or defects which are, or should be, apparent from an inspection of the Product and its packaging. Failure of Purchaser to make a claim against carrier or notify Seller during the ten (10) working day period shall constitute acceptance of the Products and waiver of any apparent defects, errors or shortages. Seller will agree to repair or replace Product damaged in shipment if Purchaser has notified Seller of freight damage within ten (10) working days after receipt and assigns its rights against the carrier.</p>
<b>Seller's Security Interest</b>	<p>Until Seller receives the full payment for the Product, Seller shall have a security interest in the Product. Purchaser agrees to perform all acts, including but not limited to the execution and filing of documentation, which may be necessary to perfect and assure the security interest of Seller.</p>
<b>Returns</b>	<p>The return of Products without a written authorization by Seller shall not be accepted. To receive authorization for Product return, please call Customer Service. All Products that are returned pursuant to a valid authorization shall be subject to a twenty-five percent (25%) of list restocking charge. Products not currently offered for sale by Seller (including COM) shall not be authorized for return. All returned Products must be unused, in original condition and in the original Seller packing cartons. No refund or credit shall be given for damaged Products.</p>
<b>Held Orders/Storage</b>	<p>If Purchaser requests that an order be held or delayed, prices and terms and conditions in effect at the time of shipment shall apply. If Purchaser requests a delay after the time when Seller can defer production, Purchaser will be invoiced for the Product, payable in accordance with standard terms, when the order is ready for shipment. Seller may transfer the Product to storage, in which case all expenses incurred in connection with storage, including demurrage, preparation for storage, storage charges and handling shall be payable by Purchaser upon submission of invoices by Seller. Risk of loss to the Product shall pass to the Purchaser upon delivery of the Product into storage.</p>

# Selling Policy

<b>Customer's Own Material</b>	A Purchaser who requests a fabric or other surface material not standard to Seller's line of Products ("COM") must submit samples of the requested material to Seller prior to entry of a purchaser order. Seller shall determine if the material is suitable to its manufacturing processes and meets any requirements of Underwriters Laboratories. If the COM is acceptable, Seller will then establish a price for using the COM or the Product in question. For a description of the procedures for submitting samples and testing, contact customer resources or your sales representative. Seller shall have no responsibility for the appearance, condition, performance, durability, colorfastness or any other physical attribute of the COM. Purchaser shall indemnify and hold Seller harmless for any damages, injuries or losses arising out of or related to use of the COM on the Product.
<b>Warranty</b>	<p>Seller warrants to the original Purchaser only that the Products Seller manufactures and sells to Purchaser are free of defects in workmanship and materials, during the applicable warranty period set forth below.</p> <p>Warranty period set forth below for <i>Bulldog, Chadwick, Essentials Work Chairs, Life, Open Up, RPM, Sapper</i> and <i>SoHo</i> seating is for 24-hour, 7 days a week, multi shift use.</p> <p>Should any failure to conform with this limited warranty appear to a Product listed below during the applicable warranty period from the date of shipment, Seller shall, upon prompt written notice, repair or replace, at its option and costs, the affected part or parts.</p> <p><i>Product and Period of Warranty</i></p> <p><i>Lifetime: AutoStrada, Calibre, Crinion Open Table, Currents, Dividends Horizon, Equity, Morrison, Reff</i> laminate, <i>Series 2 Storage</i> and other non-wood components (except cascade edge worksurfaces, operational parts, controls, electrical, <i>Series 2 Veneer Front Storage</i>, special or custom products or other materials specifically called out below, see below)</p> <p><i>10 Years: AutoStrada, Crinion Open Table, Reff</i> wood components, <i>Series 2 Veneer Front Storage, Wood Casegoods (Magnusson, The Graham Collection), Interaction</i> tables (except height adjustment mechanisms for <i>Counterforce</i>, crank-adjustable, and split-top tables and worksurfaces, see below), <i>Reuter</i> overheads, <i>Reuter</i> vertical storage, <i>Bulldog, Chadwick, Essentials Work Chairs, Life, RPM</i> and <i>Sapper</i> seating structural and operational parts, controls, casters, pneumatic cylinders, seat and back mesh (except seating upholstery, finishes and labor, wood casegoods upholstered surfaces, see below)</p> <p><i>5 Years: Operational parts, controls, electrical (except light ballasts and bulbs, see below), cascade edge worksurfaces, special or custom product, wood veneer products, A3, Currents</i> handcrank, <i>Interaction Counterforce, Interaction</i> crank-adjustable, and split-top mechanisms, <i>KnollStudio, KnollExtra</i> adjustable keyboard supports, VDT carousel, monitor platform, equipment storage drawers and all universal storage drawers, <i>Open Up and SoHo</i> seating structural and operational parts, controls, pneumatic cylinders (except seating upholstery, finishes and labor, see below)</p> <p><i>3 Years: Upholstery, finishes and labor to repair the following chairs: Bulldog, Chadwick, Essentials Work Chairs, Life, Open Up, RPM, Sapper</i> and <i>SoHo.</i></p> <p><i>2 Years: All other KnollExtra</i> product</p> <p><i>1 Year: Light ballasts and bulbs, seating upholstered armpads and soft armpads, wood casegoods upholstered surfaces.</i></p> <p>This warranty does not apply to:</p> <ul style="list-style-type: none"><li>• Damage caused by a carrier other than the Seller.</li><li>• Normal wear and tear or acts or omissions of parties other than Seller (including user modification).</li><li>• COM or other third party materials applied to Products.</li><li>• Products not installed by or under the auspices of a certified dealer of Seller.</li><li>• Dramatic temperature variations or exposure to unusual conditions.</li><li>• Except as specifically noted above, textiles and upholstery supplied by <i>KnollTextiles</i> (consult current <i>KnollTextiles</i> price list for applicable warranty).</li></ul> <p>Natural variations occurring in wood, marble, and leather shall not be considered defects, and the Seller does not guarantee the colorfastness or matching of the colors, grains or textures, or surface hardness of such materials. The Seller also does not guarantee the colorfastness of fiberglass panel surfaces. THE EXPRESS WARRANTIES CONTAINED HEREIN ARE IN LIEU OF ALL OTHER WARRANTIES, EXPRESS OR IMPLIED, INCLUDING ANY WARRANTIES OF MERCHANTABILITY AND FITNESS FOR PARTICULAR PURPOSE AND ALL OTHER WARRANTIES ARISING FROM COURSE OF DEALING OR USAGE OF TRADE.</p> <p>The remedies provided above are the Purchaser's sole remedies for any failure of Seller to comply with its obligations regarding the workmanship of its Products. Correction of any nonconformity in the manner and for the period of time provided shall constitute complete fulfillment of all liabilities of Seller, with respect to or arising out of the Product furnished hereunder.</p>
<b>Delay/Force Majeure</b>	Seller shall not be liable for failure to perform or for delay in performance due to fire, flood, strike or other labor difficulty, act of God, act of any governmental authority or of the Purchaser, riot, embargo, fuel or energy shortage, wrecks or delay in transportation, inability to obtain necessary labor, materials or manufacturing facilities from usual sources or failure of suppliers to meet their contractual obligations, or due to any cause beyond its reasonable control. If any such event occurs, Seller may extend delivery dates by a period of time necessary to overcome the effect of such delay, allocate available Product or cancel any purchase order.
<b>Compliance with Law</b>	PURCHASER IS SOLELY RESPONSIBLE FOR COMPLIANCE WITH ALL APPLICABLE FEDERAL, STATE AND LOCAL LAWS, ORDINANCES, REGULATIONS, RULES AND STANDARDS RELATING TO THE INSTALLATION, MAINTENANCE, USE AND OPERATION OF THE PRODUCTS.
<b>Patents</b>	<p>Subject to the following provisions, Seller shall, at its own expense, defend or, at its option, settle any claim, suit or proceeding brought against the Purchaser, and/or its vendees, mediate and immediate, so far as based on an allegation that any Product or any part thereof furnished hereunder constitutes a direct or a contributory infringement of any claim of any patent of the United States or Canada. This obligation shall be effective only if Purchaser shall have made all payments then due hereunder and if Seller is notified promptly in writing and given authority, information and assistance for the defense of said claim, suit or proceeding. Seller shall pay all damages and costs awarded in such suit or proceedings so defended.</p> <p>The foregoing indemnity does not apply to the following:</p> <ul style="list-style-type: none"><li>• Products supplied according to a design other than that of Seller, and which is required by the Purchaser.</li><li>• Combination of the Product with another product not furnished hereunder unless Seller is a contributory infringer.</li><li>• Any settlements of a suit or proceeding made without Seller's written consent.</li></ul>
<b>Limitations of Liability</b>	<p><b>SELLER, ITS CONTRACTORS, AUTHORIZED DEALERS AND SUBCONTRACTORS OR SUPPLIERS OF ANY TIER SHALL NOT BE LIABLE TO PURCHASER FOR ANY SPECIAL, INDIRECT, INCIDENTAL OR CONSEQUENTIAL DAMAGES ARISING FROM A BREACH OF THIS AGREEMENT.</b></p> <p>Purchaser's remedies set forth herein are exclusive and the liability of Seller with respect to the breach of this agreement or any contract entered into between the parties pursuant hereto shall not exceed the price of the Product or part on which such liability is based.</p>

# General Ordering Information

---

## **The Products**

This guide encompasses all standard products for this product group.

## **Sizes**

Dimensions listed in this guide are indicated as:

H = height

W = width

D = depth

Dia. = diameter

Rad. = radius

## **Pricing**

All prices shown are list.

## **How to Order**

Select pattern numbers and quantities required for your complete installation. Product questions can be addressed in the specific sections of this guide or by contacting your sales representative or customer resource representative at 1-800-343-5665.

Next, select options (if required), along with colors and finishes appropriate to each product. Reference the Finishes and Fabrics pages for color designations.

On large installations, an item's "designated area" can be specified to assist in product organization and handling.

To expedite complete / correct entry of your order, be certain all pattern numbers, quantities, colors and area identifications are completely specified. Also, include complete purchase order numbers, bill-to and ship-to addresses, a contact name and specific factory shipping dates required.

## **Mail all orders to:**

Knoll, Inc.  
1235 Water Street  
P.O. Box 157  
East Greenville, PA 18041  
Attention: Order Entry

Once your order is entered at Knoll, an acknowledgment will be mailed to you. You will be advised of your scheduled shipping date within five days of the original acknowledgment. If it is necessary to revise your order, please contact your customer resource representative.

## Sustainability Statement

---

Sustainable design is a key component of Knoll's environmental focus. Our commitment to social responsibility and a healthy environment has prompted us to further articulate our longstanding environmental programs and, with encouragement and support from our colleagues in the industry, we have re-energized our focus on such "green" initiatives as life cycle analysis and LEED™ certification. Knoll is proud to have contributed to projects that have received LEED certification from the U.S. Green Building Council.

For the latest information on Knoll products that help our customers achieve LEED certification, log on to [knoll.com](http://knoll.com), click on "About Knoll" and then "Environmental Focus."