

Table of Contents

Introduction	Knoll and Sustainable Design	3
	Introduction to Currents	4
	Currents Textiles	7
	Currents Color Program	8
	Currents Legacy Finishes	9
	Introduction to Upstart	10
	Original Upstart Planning Examples	11
	Upstart Color Program	13
	Upstart Legacy Finishes	14
Service walls and components	Service wall frames	15
	Fence frames	16
	Crown and raceway covers	17
	Structural base cover kits	18
	Access covers	20
	Wall ends and connectors	27
	Wall frame accessories	33
	Spine ends and connectors	35
	End Starters	39
	Panel system starters and T-ends	41
	Panel system starters for Dividends	49
	Power, data and communications components for service walls	51
Screens and add-up panels	Linkable screens	59
	Wall-connected screens	66
	Mobile screens	67
	Add-up panels	68
	Add up glass panels, for spine	71
	Add-up panel connectors and fillers	72
	Stackable add-up panels	74
	Stackable add-up connectors and fillers	78
Worksurfaces	Worksurfaces, universal	83
	Currents worksurfaces for Morrison panels and linkable screens	89
	Cascade edge worksurfaces	95
	Worksurface supports	102
Floorstanding storage	Pedestals	104
	Pedestal accessories	106
	Vertical storage cabinets	109
Service wall-mounted storage and lighting	Reuter overhead cabinet	111
	Reuter open overhead	112
	Reuter open shelf	113
	Reuter ganging bracket	114
	Overhead brackets	115
	T5 Task Light for Reuter Overhead Storage	116
	Portable shelf and counter surface	117
	Ambient lighting and awning	118
Desk, credenzas and worktables	Desks	119
	Desks with service beam	127
	Basic credenzas	135
	Credenzas	138
	Credenzas with service beam	140
	Service beams for desks or credenzas	142
	Power, data and communications components for desks and credenzas	144
	Above-desk storage and lighting for desks and credenzas	148
	Privacy screens for desks and credenzas	149
	Desk and credenza accessories	152
	Worktables	153
	Power monument and components	156

Upstart table desks and storage	Upstart Tables	157
	Plannable Upstart Tables	162
	Accessories	171
	Upstart Privacy Screens	172
	Plannable Upstart Privacy Screens	173
	Upstart Storage	175
Alpha-Numeric Index		177
Selling Policy		184
KnollKey Lock Program		186
General Ordering Information		187

Knoll and Sustainable Design

Each year Knoll sets key initiatives in our journey to sustainability. We are members of a global consortium on energy, have adopted a scientific, metrics-based approach to sustainable product design, and maintain a leadership position in establishing universal, verifiable, sustainability standards for our industry.

Knoll promotes independent third-party certification because it provides the most impartial and trustworthy foundation for industry-wide environmental compliance. Certification by established and respected third parties ensures that all manufacturers are held to the same high standards and that customers can trust a company's declaration about the environmental benefits of its products. Knoll third-party partners include: the International Standards Organization (ISO); Forest Stewardship Council (FSC); GREENGUARD® Environmental Institute; and Chicago Climate Exchange (CCX®).

In addition, Knoll is aligned with the U.S. Green Building Council and can help companies, healthcare organizations and educational institutions achieve Leadership in Energy and Environmental Design (LEED®) workplace certification.

1. Global Climate Change

- Knoll is a sponsor of the Clinton Global Initiative, which brings together a community of global leaders to devise and implement solutions to some of the world's most pressing challenges, including environmental change.
- Knoll is a member of the Chicago Climate Exchange, which promotes greenhouse gas reduction through the trading of credits earned for reducing emissions.
- Knoll has a comprehensive Energy Management Program to increase energy efficiency in products and processes.

2. Life Cycle Assessment (LCA) Tool

Life Cycle Assessment is a science-based measurement of a product's environmental impacts throughout its life cycle, from raw materials sourcing through manufacture, shipping, use, and re-use or end-of-life. LCA enables cradle-to-cradle implementation of sustainable practices.

- Knoll partners with The Green Standard.org (formerly the International Design Center for the Environment, or IDCE) to develop an affordable, universal, ISO-compliant computer-based LCA tool that can be used by the entire contract furniture industry.

An affordable universal LCA tool has enormous potential value to:

- Help stop dangerous and irreversible climate change
- Conserve natural resources and reduce waste
- Improve quality of life
- Eliminate market confusion about green products using real metrics and sound science
- Facilitate design innovation
- Advance the sustainability triple bottom line: environment, economics and social equity

3. Setting Industry Standards

- Knoll partners with MTS (Market Transformation to Sustainability) to develop the SMART® Standard, a set of consensus-based sustainable product standards based on the LEED® model, for all building products, fabric, apparel, flooring and carpet. MTS, the developer of the SMART Standard, is an accredited American National Standards Institute (ANSI) standard developer.
- Knoll also participates in an ongoing BIFMA (Business and Institutional Furniture Manufacturers Association) initiative to establish sustainability standards for the contract furniture industry.
- Our goal is to encourage all manufacturers in the contract furniture and related industries to adopt standards that will lead to sustainable products and practices.

For more information about Knoll environmental, health and safety programs, visit knoll.com/environment.

Currents creates dynamic, advanced performance work environments from coordinated, independent elements – service walls, plannable desks, mobile storage – and existing Knoll office products.

Currents workspaces may be spine-supported or freestanding, or planned in combination with conventional panel systems.

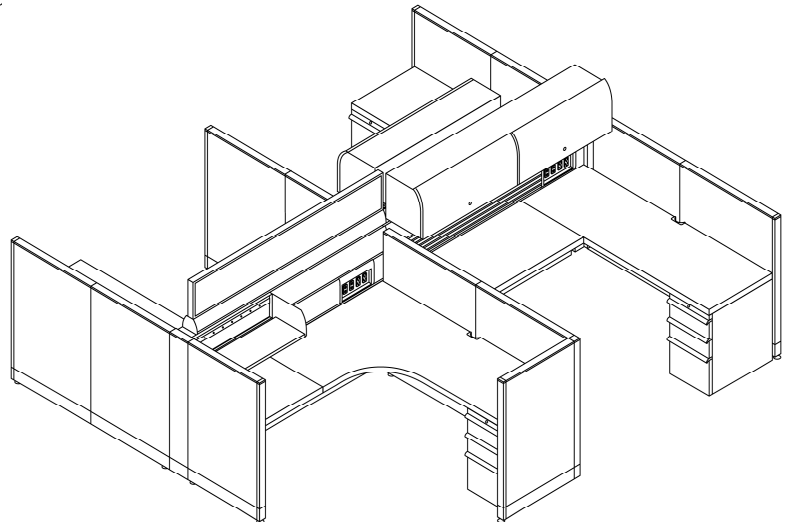
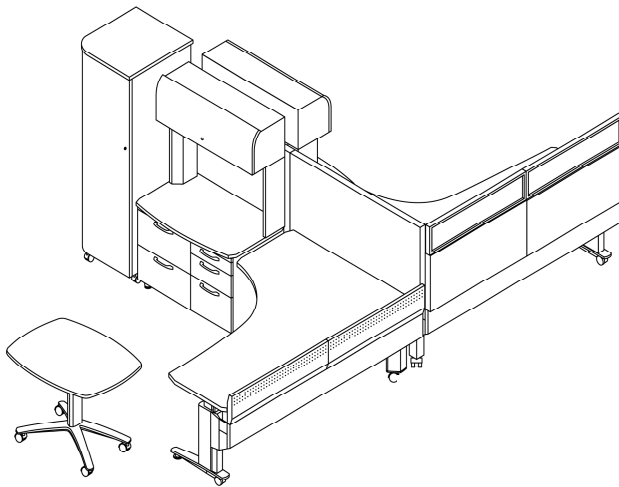
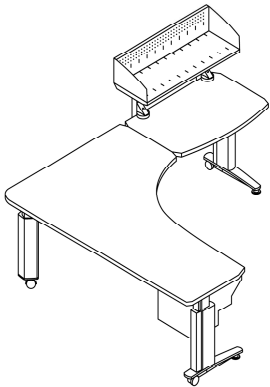
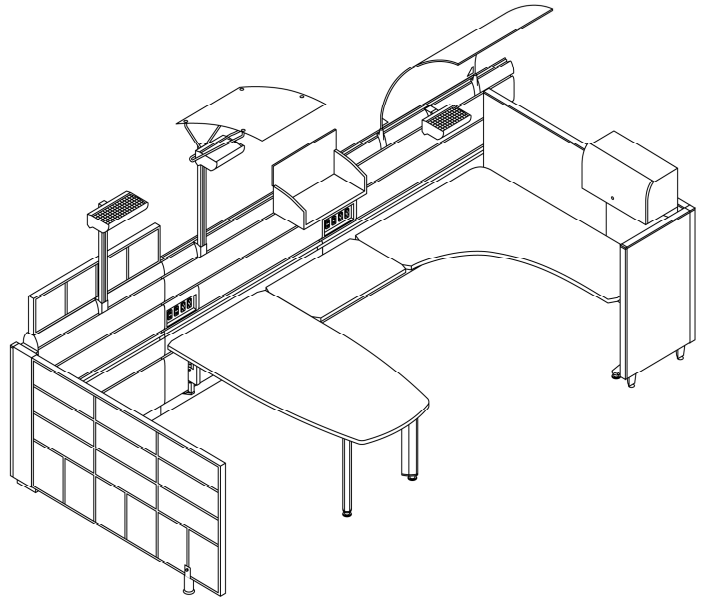

Currents service walls

Currents service walls form the structural core and primary path of services distribution for a cluster of workstations. Currents service walls may also create borders for team workspaces, conference areas, or corridors. Service walls are 5" thick, and are available in three heights: 39" for seated visual access; 48" for seated privacy, the most versatile height for open plan areas requiring some overhead storage; and 64" for standing privacy in executive or conference areas.

Service walls are composed of frames and covers. Frames include studs on 12" centers, base raceway with levelling glides, crown and base. Frames may be specified with 1"H compact crown or 4"H standard crown. All studs have brackets to support covers at 5", 21", 30", 39", 48" and 64" above the floor. Crown and raceway covers, structural base covers from 5" to 21" above the floor, and covers above 21" must be specified separately.

Structural base covers enable perpendicular panels, worksurface supports, or outriggers to be attached at any point. Structural base covers may be painted steel, perforated, or upholstered.

Wall covers above 21" snap into wall frame brackets at 12" intervals, and are removable without tools. Covers may be painted, upholstered, acoustical/tackable upholstered, cable tray, slatwall, or marker surface.

Currents walls plan in any combination of 48", 60" or 72" widths corresponding to the total length of wall required. Add stabilizer end cabinet, outriggers, T-end and L-end panels, or 90° or 120° post connections at each end of service wall spine. Straight connectors are included with each frame kit to join frames of the same height in a straight line. High-low straight connectors are available separately. Service wall spines require outriggers or perpendicular systems panels every 8'.

Power components are specified separately. Knoll universal 2+2 or 3+3 power components may be installed in the base of the wall or at worksurface height. Base power rails accept two duplex outlets on each side of a panel at raceway height. Desk-height outlet modules accept two duplex outlets on each face above or below the worksurface. One or two modules (four duplex outlets each side) may be located in any 12" wide stud bay. Locate outlet modules and related 12"W outlet covers before specifying widths of adjacent panel covers.

The interior of the wall between 21" and the crown offers unobstructed, 1" deep, lay-in cabling on each surface. Vertical wire management and excess cord capability is unobstructed 2½" x 10" between studs.

Service walls with standard 4"H crown enable upmounted shelves and overhead storage cabinets, canopy lighting and awnings at any point on one or both sides. Translucent, perforated, upholstered or frameless glass add-up panels fit into a center channel anywhere along the crown for 12", 21" or 28" of additional enclosure.

Stackable add-up panels are also available in translucent, perforated, upholstered, marker or glazed surface. First up panels are 12", 21" or 28" high; next up stacking panels are 16" high.

First up panels can be mounted on any 3" increment along service wall crown, or correspond in width to linkable screens.

Wall mounted components

Worksurface supports, perpendicular wall-connected linkable screens, and systems panels may be connected to the Currents wall at any point. Mobile screens are also available, in translucent fiberglass or upholstered surface.

Currents linkable screens, in translucent, perforated, glazed, upholstered or marker surface, define workstations and extend the service wall horizon. Linkable screens connect in L, T, X, Y and V configurations and accept stackable add-up panels. First up panels are 16", 25" or 32"H. Next up panels are 16"H.

Currents worksurfaces are designed for computer use as the primary work activity. Deep corners are shaped for large monitors, and include wide keyboard/mouse areas. Straight worksurfaces feature softly curved or flat fronts. Extended corners incorporate an adjacent work area and a computer corner into a single, uninterrupted surface. Universal worksurfaces include a steel stiffener for high load capacity and cord management.

Service walls cantilever worksurfaces up to 24"D, or provide end support for any size worksurface. Support columns, independent C-legs, and floorstanding pedestals are also available for worksurface support. Cantilevers are adjustable in 1" increments for 24"-34"H worksurface. End support brackets and C-legs are fixed height for 28"H worksurface, or adjust for 24"-34" worksurface height.

Service wall standard height 4"H crowns can upmount portable open shelves, task and ambient lighting, add-up panels, and awnings for light control.

Service wall standard height 4"H crowns can upmount or downmount Reuter overhead storage, open shelves, or Equity overhead at any point. Reuter storage and Equity overheads can only be downmounted from walls with 1"H compact crown. Brackets are available to downmount Morrison Options, Series 2 for Morrison, Dividends, Series for Dividends or Equity overhead cabinets from 64"H service wall with either compact or standard crown.

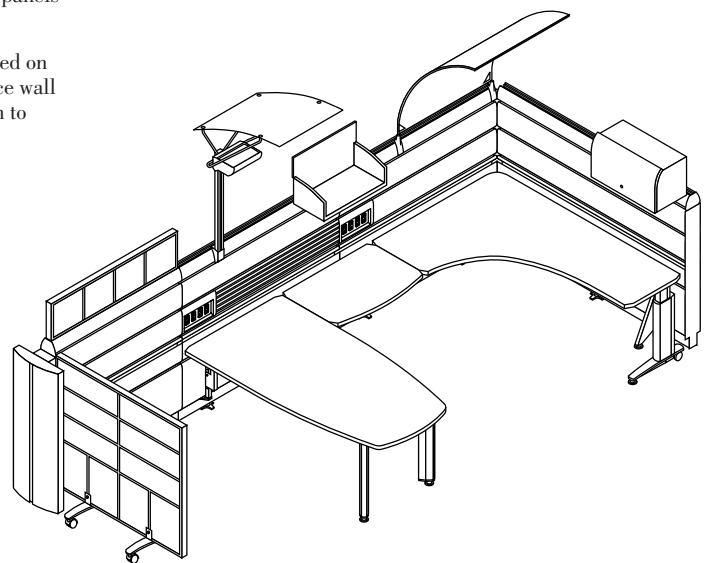

Currents desks and credenzas

Currents desks and credenzas are freestanding furniture elements optimized for the high-mobility, computer-based office. Currents corner desks and credenzas can work together to form efficient, two-element workstations.

They are available in basic versions for use with Currents service walls and screens, or equipped with service beams to support privacy screens, modular power distribution, and expanded data cabling. Desk and credenza beams can be linked in powered clusters. Beam-mounted privacy screens may be shared back-to-back; both sides are tackable. Upholstered screen heights reach 39" or 48" horizons. 9"H translucent windows can be added to either height. Perforated metal screens to 30"H conceal desktop cables on open desks.

All desks include horizontal and vertical cable managers. Optional service beam may be powered with Knoll 2+2 or 3+3 modular power components, and carries up to 50 lay-in Category 5 cables. Data cabling can be protected by optional data tray covers. Standard knockouts are provided at each end of the data tray for Knoll PDC Module data connector plates.

All Currents desks are height-adjustable. Pin-set version has range of 24" to 30"H in 1" increments. Handcrank version lets the user adjust continuously from 24" to 34"H. Desks have C-legs for knee clearance, and have interchangeable rear casters or glides for easy mobility.

Desks are available in corner, extended corner, and curved-front straight shapes. Worksurface corners are eased to make alignment of mobile units less critical.

Desks, credenzas, and wall-mounted worksurfaces accept clamp-on workshelves. Workshelves provide convenient binder/book access adjacent to computer displays.

Credenzas are integrated units which provide the equivalent of one or two pedestals, enclosed shelf storage, and a worksurface top that extends the usable desk top area. A cable storage area is provided at the rear of the credenza cabinet, accessed by sliding the worksurface forward. Optional linkable service beam accepts privacy screens and extends the wireway capabilities. Credenzas accept clamp-on workshelves or stanchion-mounted Reuter overhead storage units.

Stanchions can be equipped with outlet modules that link to adjacent desks.

Currents Worktables

Currents mobile worktables extend the worksurface area and provide flexible guest/conference spaces. Rounded corners enable informal placement near other worksurfaces. All worktables are available with casters or levelling glides.

Adjustable height worktables adjust from 24" to 30" high in 1" increments.

Currents Storage

Currents freestanding storage components are designed for mobility and space efficiency.

Pedestals are available mobile or fixed, with 2 files or combination 4" personal, 7" data, and 11" file drawer fronts, fitting below standard 28" worksurface height. Data/file mobile pedestals are low enough to roll under desks set lower than 28". Mobile pedestals include top, casters and handle. Fixed pedestals include 2" levelling glides.

Reuter vertical storage has a rotating door, shelves and pull-out file frames, and a wardrobe area. Reuter storage is 21" wide so open door fits within 24" planning footprint.

Reuter vertical storage is available 48"H, with painted or worksurface top, or 64"H with painted top only.

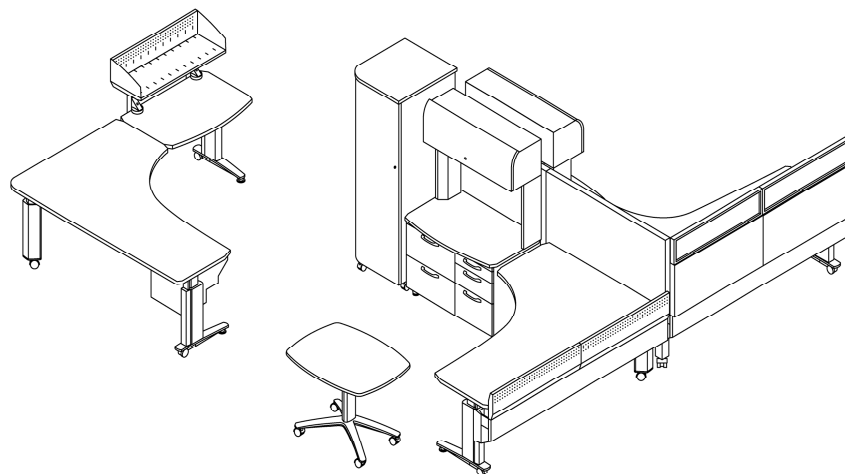

Approved for wall covers, mobile screens and privacy screens.

Fabric Group 10

Bailey II (W359)
Broadcloth (W288)
Element (W1077)
Foundation (W351)
Growth Spurt (W692)
Newbury (W812)
Symbolic Details (W693)
Tailor Made (W133)
Versatility (W432)

Fabric Group 15

Regency/Fairfield (W210/B)

Fabric Group 20

Banyan (W443)
Bauhaus Block (W296)
Boardwalk (W911)
Clarity (W281)
Criss Cross (W305)
Devon (W809)
Frequency (W340)
Melbourne (W228)
Outback (W229)
Reflect (W884)
Resolution (W280)
Walkabout (W230)
Weave Three (W298)

Fabric Group 30

Basket Draft (W249)
Flow (W565)
Harmony (W232)
Interknit (W1090)
Micro (W465)
Progression (W403)
Progression Striae (W463)
Raku Cloth (W566)
Relay (W1020)

Fabric Group 35

Saxony Plus (S)

Fabric Group 40

Analogy (K614)
Eurythmic (W268)
Foil Rap (W535)
Hard Rock (W1007)
Metaphor (K612)
Ornament (W1078)
Palladium (W1030)

Fabric Group 45

Backdrop (W302)
Casual Elegance (W920)
Dristi (K872) with backing only
Fast Forward (W301)

Fabric Group 50

Glo (K757)
Ingot (K531)
Presto (K1000)
Ricochet (K498)

Fabric Group 55

Transition (W816)

Additional textiles are available on linkable screens and stackable add-up panels: see Morrison price list for approved fabrics.

Customer's Own Material is subject to an application testing fee of \$750 per fabric and a \$2500 fee for UL testing. Fabric requirements - application test, 10 yards; UL test, 15 yards. COM is also subject to extended leadtimes. COM panels are priced at Group 10 plus cost of fabric.

Please consult your Knoll representative for fabrics available for pedestal seat cushions.

Core finishes

Specify Core finishes for all new customers

Core	Legacy	Wall covers	Wall ends, trim, brackets and outriggers	Storage fronts	Storage cases	Work-surfaces and shelves	Currents worksurface edges	Currents for Morrison worksurface edges	Pedestals and Reuter Over-head
611	Beige Mist Metallic	•	•	•	•				P2
118	Bright White	•	•	•	•	•		•	P3
112	Brown	•	•	•	•				P1
123	Brushed Grey					•			
122	Brushed Sand					•			
113	Dark Grey	Y3	•	•	•				P1
128	Fog					•		•	
114	Folkstone Grey	LA	•	•	•	•		•	P1
111	Jet Black		•	•	•	•		•	P1
124	Medium Cherry					•			
115	Medium Grey	Y2	•	•	•				P1
612	Medium Metallic Grey	J	•	•	•				P2
121	Micro Grey					•			
129	Micro Sand					•			
126	Natural Cherry					•			
125	Natural Maple					•			
119	Pumice	F				•		•	
116	Sandstone		•	•	•				P1
613	Silver	3	•	•	•				P3
117	Soft Grey	E/M42	•	•	•	•		•	P1
813	Trim Grey	5					•	•	
127	Walnut					•			
	Maple Techgrain®	V2			M	4			M
	Cherry Techgrain®	V2			R	6			R
	Medium brown mahogany Techgrain®	V2			I	7			I
	Medium red mahogany Techgrain®	V2			C	8			C
	American cherry Techgrain®	V2			P	9			P
	Maple	V3			K	K			K
	American cherry	V3			X	X			X
	Medium red mahogany	V3			Z	Z			Z

Default trim information:

Trim Grey is the integral color for worksurface, desk, credenza and worktable top edge, mobile screens, linkable screen and add-up panel trim, privacy screen and window trim, pedestal pulls and awning brackets.

Black: wall frames and drawers interior, wall, screen, storage glides and casters.

Light grey: perforated add-up panels and ambient lights

Translucent crystal: fiberglass surfaces for mobile screens, linkable screens and add-up panels

The new Core finish 113 Dark Grey is not a match to the Currents Legacy finish NV. It is a match to the Dividends Legacy finish Y3.

The new Core finish 115 Medium Grey is not a match to the Currents Legacy finish NJ. It is a match to the Dividends Legacy finish Y2.

		Work-surfaces	Wall and Structural Base covers	Crown Covers	Crown end caps, connectors and connector top caps, raceway covers, worksurface brackets and outriggers	Straight legs, C-legs, corner legs, desk screen clamps, window frames (textured only)	Storage fronts	Storage Cases
Plastic Laminates	Light Grey	L						
	Pumice	F						
	Winter grey	V						
	Slate	S						
	Snow	B						
	Folkstone Grey	U						
	Pearwood	PA						
	Fiber	E						
	Sand	D						
	Medium Grey	G						
	Soft grey	M42						
Wood Grain Laminates	Clear Maple	CM						
Veneer Group 2	Maple Techgrain®	4					M	
	Cherry Techgrain®	6					R	
	Medium brown mahogany Techgrain®	7					I	
	Medium red mahogany Techgrain®	8					C	
	American cherry Techgrain®	9					P	
Veneer Group 3	Maple	K					K	
	American cherry	X					X	
	Medium red mahogany	Z					Z	
Paint Group 2	Metallic Flint *		2	2	2	2	2	2
	Light metallic grey *		U	U	U	U	U	U
	Medium metallic grey *		J	J	J	J	J	J
	Dark metallic grey *		V	V	V	V	V	V
	Light metallic tan *		W	W	W	W	W	W
	Metallic beige *		H	H	H	H	H	H
	Soft Grey *		E	E	E			
	Medium Grey (Slate) *		Y2	Y2	Y2			
	Taupe *		R	R	R			
	Aluminum			A				
Paint Group 3	Silver *		3	3	3	3	3	3
	White *		B	B	B	B	B	B

Specify legacy finishes to match existing product only. Legacy finishes are not available for new customers.

Trim grey is the integral color for worksurface, desk, credenza and worktable top edge, mobile screen and add-up panel trim, privacy screen and window trim, pedestal pulls and awning brackets

Wall, screen and storage glides, glide cones and casters are integral color Black.

Wall frames and pedestal drawer interiors are painted Black.

Perforated add-up panels and ambient lights are painted Light grey

Fiberglass surfaces for mobile screens, linkable screens and add-up panels is Translucent crystal

Linkable screen feet are painted Trim grey

Knoll Upstart is a collection of tables, screens, storage and services distribution components for computer-intensive, active, and open work environments.

Upstart plans as single-surface, L- or U-shape workstations, or freestanding worktables and storage in combination with other systems furniture. Tables are available on casters or glides and are adjustable in height.

Original Upstart tops have a plastic laminate surface with a continuous T-mold edge. The corners of Original Upstart tops are rounded. Original Upstart legs are curved.

New Plannable Upstart tops have a plastic laminate or Veneer surface with a T-mold edge on the front and a thin edgeband on the sides and back. The corners of Plannable Upstart tops are 90 degrees and allow two tables to meet at right angles. Plannable Upstart legs are straight.

Complementary products include Currents workshelves, which clamp on to Upstart tables, mobile screens, linkable screens and service wall, monitor supports and desktop accessories. Consult the Currents and KnollExtra price lists for product details and pricing.

Screens

Upstart screens mount to the back edge of Original Upstart tables to provide seated visual privacy at a horizon of 39 or 48 inches. Upstart Screens are available in translucent or marker surface, and may be combined with magnet rail.

Plannable Upstart tables use Morrison Network upholstered screens, which are available in a variety of sizes.

Storage

Storage includes the Upstart cart, for suspended filing and personal storage, and the Upstart tower, which houses binders as well as suspended files and personal storage.

Accessories

Flat Bracket

Bracket joins 2-legged table to another Upstart table at same height.

Cable Tray

Cable tray adds on to worksurface stiffener to control cable bundles and power strips (where permitted by code).

Pencil Drawer

Pencil drawer attaches to the underside of a worksurface at any location.

Important Note: Plannable Upstart straight legs may not be used with Original Upstart tops due to stability issues.

Primary and Secondary Worksurfaces

Original Upstart

Rectangular table desk/Return

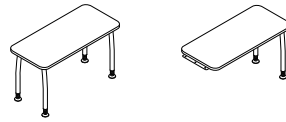

Corner table desk, 120°

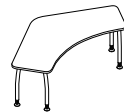

Extended Corner table desk

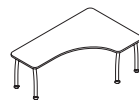

Y-shape table desk, M-shape table desk

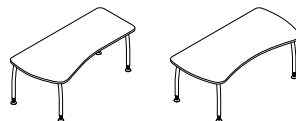

Conference Worksurfaces

Original Upstart

Round, Half round table desk

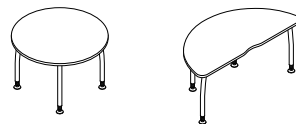

Oval table desk



Wiper table desk, Tripod table

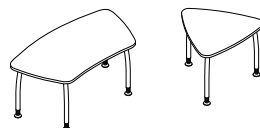

48 x 24 Original Upstart

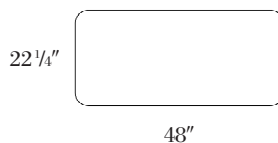

New Plannable Upstart

Rectangular table desk/Return

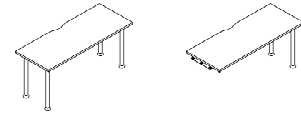

Corner table desk, 90°

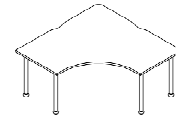

Extended Corner table desk

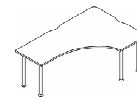

P-shape table desk

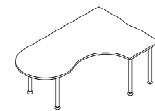

New Plannable Upstart

Half round table desk

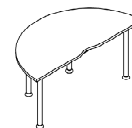

48 x 24 Plannable Upstart

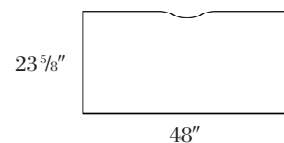

Basic stand-alone Y desk

- the core Upstart application
- 30" x 72" nominal shown; conference depth is approximately 36"

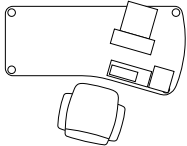

Oval table with Y desk

- 36" x 66" oval table
- 30" x 72" Y return

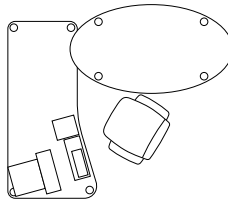

Curved wiper with Y desk

- wiper 66" W
- 30" x 72" Y return

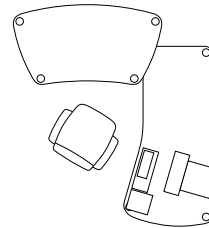

Y desk with 42" round table

- conference table

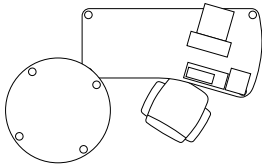

Rectangular table with bracketed return surface

- 72" x 76" approximate footprint
- optional work shelf

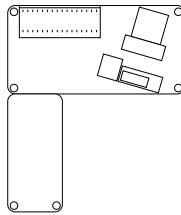

Y and M back-to-back, with 42" conference tables

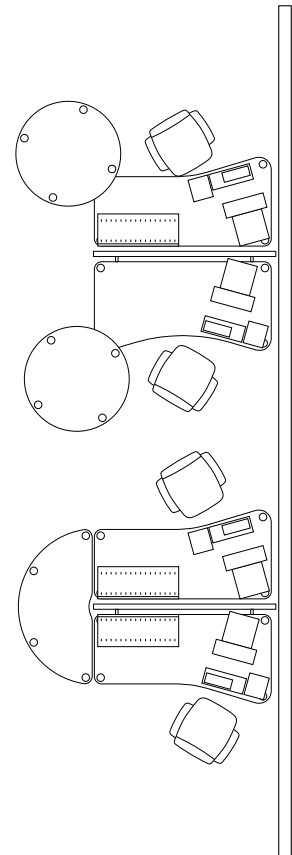

Y desk with tripod table

- 30" x 72" Y desk, work shelf, and mobile pedestal

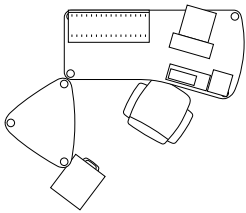

Dual-monitor M desk workstation

- 72" x 100" approximate footprint
- optional work shelf
- flat ends allow placement along wall

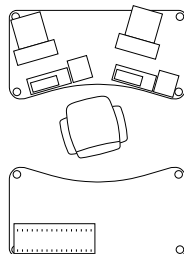

Dual-monitor M desk with tripod table

- 30" x 72" nominal M desk

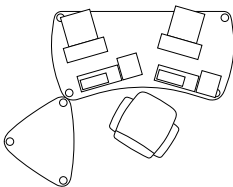

Y desks back-to-back, with half-round shared table

- please note 1.75" setback from the back edge of each top to module line, same as Currents desks.

Y desk with Upstart storage

- 72" x 96" footprint
- 72" table with screen
- cart and tower

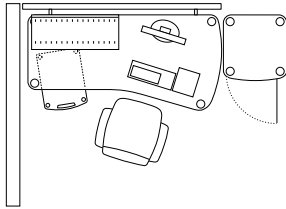

Extended corner desk and tower

- 72" x 72" footprint
- 48" and 72" screens
- cart and tower

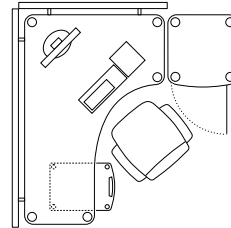

Extended corner desk and adjacent worktable

- 72" x 96" footprint
- 72" x 48" corner and 48" straight desks
- cart and privacy screen

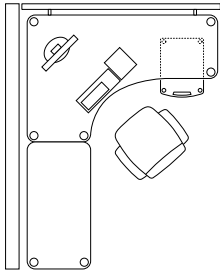

Upstart 120° planning

- group of three 120° corners
- 48" shared privacy screens
- carts

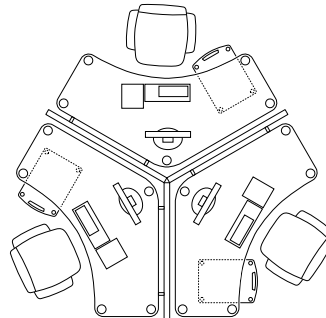

U-shape plannable desks

- 96" x 96" footprint
- two 48" x 72" extended corners
- cart and tower
- 72" privacy screen

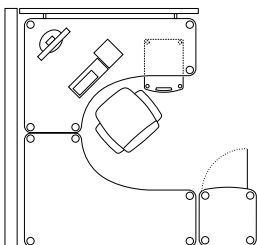

Upstart work group

- 120° corners and shared worktable 48 x 24"
- carts and towers
- 48" privacy screens

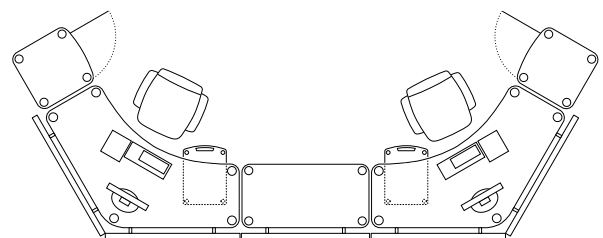

Core finishes

Specify Core finishes for all new customers

Core	Legacy	Table legs, screen brackets, magnet rail	Upstart Work-surfaces	Plan-nable Upstart Work-surfaces	Upstart Work-surface edges	Plan-nable Upstart Work-surface edges	Cart	Tower top and bottom	Tower door
611	Beige Mist Metallic	•						•	•
118	Bright White	•	•	•	•	•		•	•
112	Brown	•						•	•
123	Brushed Grey		•	•					
122	Brushed Sand		•	•					
113	Dark Grey	Y3	•					•	•
128	Fog		•	•	•	•			
114	Folkstone Grey	LA	•	•	•	•		•	•
111	Jet Black		•	•	•	•		•	•
124	Medium Cherry		•	•					
115	Medium Grey	Y2	•					•	•
612	Medium Metallic Grey	J	•					•	•
121	Micro Grey		•	•					
129	Micro Sand		•	•					
126	Natural Cherry		•	•					
125	Natural Maple		•	•					
119	Pumice	F	•	•	•	•			
116	Sandstone		•					•	•
613	Silver	3	•					•	•
117	Soft Grey	E/M42	•	•	•	•		•	•
813	Trim grey	5			•	•			
127	Walnut		•	•					
	Translucent orange	O			•				
	Translucent blue	P			•				
	Frosty white	W			•				
	Light grey (integral)	U					•		
	Glider grey (integral)	G1					•		
	Maple Techgrain®	V2		•					M
	Cherry Techgrain®	V2		•					R
	Med. brown mahogany Techgrain®	V2		•					I
	Med. red mahogany Techgrain®	V2		•					C
	American cherry Techgrain®	V2		•					P
	Maple	V3							K
	American cherry	V3							X
	Medium red mahogany	V3							Z

Default trim information:

Trim Grey is the integral color for caster and glide leg levellers and screen corners

Black: flat bracket, cable tray and casters

Light grey: Cart pencil tray and divider

Natural anodized aluminum: Cart legs and Tower posts

Screen available in Ribbed Polycarbonate or Marker surface

For Plannable Upstart Veneer Group 2, only black or trim grey edgebands can be specified.

Translucent orange, Translucent blue, and Frosty white edgebands are not available for Plannable Upstart tables.

Specify Legacy Finishes for existing customers only. Legacy Finishes are not available for new customers.

		Table legs, screen brackets, magnet rail	Work- surfaces and shelves	Work- surface edges	Cart	Tower top and bottom	Tower door
B	Snow		•				
L	Light grey		•	•			
E	Fiber		•				
V	Winter grey		•				
S	Slate		•				
F	Pumice		•	•			
U	Folkstone grey		•	•			
M42	Soft grey		•	•			
D	Sand		•	•			
CM	Clear Maple		•				
PA	Pearwood		•				
WM	Warm Cherry		•				
5	Trim grey			•			
N	Black			•			
O	Translucent orange			•			
P	Translucent blue			•			
W	Frosty white			•			
N2	Flint					•	•
NU	Light grey					•	•
NJ	Medium grey					•	•
NV	Dark grey					•	•
NW	Light Tan					•	•
NH	Beige					•	•
3	Silver	•				•	•
B	White	•				•	•
2	Metallic flint	•					
U	Light metallic grey	•					
J	Medium metallic grey	•					
V	Dark metallic grey	•					
H	Metallic beige	•					
W	Light metallic tan	•					
E	Soft grey	•					
M	Maple Techgrain®						•
R	Cherry Techgrain®						•
C	Med. red mahogany Techgrain®						•
P	American cherry Techgrain®						•
K	Maple						•
X	American cherry						•
Z	Medium red mahogany						•
U	Light grey (integral)				•		
G1	Glider grey (integral)				•		

Default trim information:

Trim Grey is the integral color for caster and glide leg levellers and screen corners

Black: flat bracket, cable tray and casters

Light grey: Cart pencil tray and divider

Natural anodized aluminum: Cart legs and Tower posts

Screen available in Ribbed Polycarbonate or Marker surface

For Plannable Upstart Veneer Group 2, only black or trim grey edgebands can be specified.

Translucent orange, Translucent blue, and Frosty white edgebands are not available for Plannable Upstart tables.

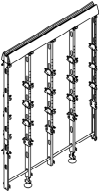
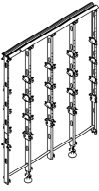
description	type	w	d	h	pattern no.	black
 <p>Wall frame, standard crown</p>	39"H	48"	5"	43"	APF1 3948	\$435.
		60"	5"	43"	APF1 3960	501.
		72"	5"	43"	APF1 3972	620.
	48"H	48"	5"	52"	APF1 4848	479.
		60"	5"	52"	APF1 4860	548.
		72"	5"	52"	APF1 4872	684.
	64"H	48"	5"	68"	APF1 6448	571.
		60"	5"	68"	APF1 6460	652.
		72"	5"	68"	APF1 6472	817.
 <p>Wall frame, compact crown</p>	39"H	48"	5"	40"	APFA1 3948	348.
		60"	5"	40"	APFA1 3960	401.
		72"	5"	40"	APFA1 3972	494.
	48"H	48"	5"	49"	APFA1 4848	382.
		60"	5"	49"	APFA1 4860	438.
		72"	5"	49"	APFA1 4872	547.
	64"H	48"	5"	65"	APFA1 6448	457.
		60"	5"	65"	APFA1 6460	521.
		72"	5"	65"	APFA1 6472	652.

Order Code	Specification Information	Application Notes
Example: APF1 4860	Wall frame pattern numbers begin with APF prefix.	Service wall frames are the structural component of a Currents spine. Specify frames in any combination of widths to create the overall wall length required.
APF1 Wall frame		Crown is bored to accept stackable add-up panels at 3" increments.
48 Height	<i>Specify:</i> <i>Fifth position: height</i>	Wall frames include two levelling feet with 2" travel, 12" from each side edge.
60 Width	39 39"H 48 48"H 64 64"H	The base of the wall accepts Knoll 2 + 2 or 3 + 3 raceway power rails, and allows cables to enter or exit anywhere between glides.
	<i>Seventh position: width</i>	Specify crown covers, raceway covers, structural base covers, and wall covers for each face of frame, and specify power components separately.
	48 48"W 60 60"W 72 72"W	Frames include vertical studs every 12" on center, with cover mounting clips and cable manager inserts on both sides. Frames also include 4"H or 1" top crown with continuous channel for add-up panels. Standard crown frames include shaped crowns for upmounting shelves and overhead storage cabinets, canopy lighting, or awnings at any point. Compact crown frames feature a slim profile crown with downmounting capability only.
	All wall frames include 3" diameter, 2" levelling glides and one set of connectors to adjacent frame or wall connector. Frames are black painted finish.	

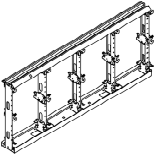
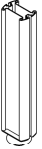
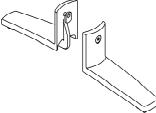
description	width	depth	height	pattern number	black
Fence frames (legs not included) 	48"	5"	20 1/2"	APF 1848	\$411.
	60"	5"	20 1/2"	APF 1860	491.
	72"	5"	20 1/2"	APF 1872	590.
Leg with glide 	2 3/4"	4"	18 1/2"	AX1 LEG ()	63.
Stabilizer feet (set of 2) 	2 1/2"	7 1/2"	4 1/2"	AX1 FF ()	97.

Order Code

Example: APF 1872
APF Wall frame
18 Height
72 Width

Specification Information

Specify painted finishes for legs and feet.

Fence frames include four barrel connectors, crown and bottom rail covers in trim grey. Frames must be enclosed with two rows of 9"H Currents wall covers on each face.

Specify Currents power components separately. Outlet modules mount at any point along the top row only.

Application Notes

Currents Fence provides independent services distribution to a cluster of tables, desks or workstations.

Installed Fence frames are 40"H and include vertical studs with cover mounting clips and cable manager inserts every 12".



A continuous top channel accepts Currents crown top caps and supports panes, add up panels or stackable add up panels 12" high. 21"H stackable add up panels may be used on Fence runs supported by perpendicular panels or linkable screens.

Fence legs with glides mount 12" from each frame side edge under the first full vertical stud. Stabilizer feet mount on both faces of Fence legs.

For freestanding Fence runs, specify a leg with feet 12" from each run end plus a leg with feet for each intermediate frame connection. Intermediate legs may be positioned on either side of the frame connection.

Legs with feet 12" from each end of connected Fence frames can be replaced by stabilizer end cabinets or T-ends with panels or linkable screens. Intermediate support may also be provided by legs without feet in combination with perpendicular panels or linkable screens with Fence panel starters.

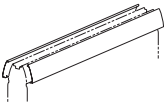
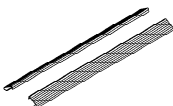
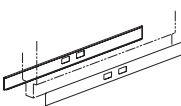
Fence frames can end support worksurfaces but cannot cantilever worksurfaces or upmounted storage.

description	type	w	d	h	pattern no.	paint	metal finish (A)	list
Crown covers (pair) 		48"	5"	4"	APT 48 ()	\$30.	\$37.	
		60"	5"	4"	APT 60 ()	37.	41.	
		72"	5"	4"	APT 72 ()	41.	50.	
Crown covers, compact (pair) integral color 		48"	5"	1"	APTA 48 ()			48.
		60"	5"	1"	APTA 60 ()			57.
		72"	5"	1"	APTA 72 ()			97.
Raceway covers (pair) 	no outlets	48"	–	2 1/2"	APR 480 ()	30.		
		60"	–	2 1/2"	APR 600 ()	37.		
		72"	–	2 1/2"	APR 720 ()	41.		
	outlets	48"	–	2 1/2"	APR 48 ()()	37.		
		60"	–	2 1/2"	APR 60 ()()	41.		
		72"	–	2 1/2"	APR 72 ()()	50.		
Crown top cap 		24"	2"	–	APT C24 ()			8.
		24"	2"	–	APT1 C24 ()			8.
		36"	2"	–	APT C36 ()			14.
		36"	2"	–	APT1 C36 ()			14.
		48"	2"	–	APT C48 ()			22.
		48"	2"	–	APT1 C48 ()			22.
		60"	2"	–	APT C60 ()			25.
		60"	2"	–	APT1 C60 ()			25.
		72"	2"	–	APT C72 ()			30.
	72"	2"	–	APT1 C72 ()			30.	

integral color only, plastic

Order Code	Specification Information	Application Notes
Example: APR 480 612 APR Raceway 48 Width 0 Outlet openings 612 Finish	Wall crown pattern numbers begin with APT-prefix, then frame width. Specify: Sixth position: paint or metal finish Raceway Covers begin with APR-prefix, then frame width. Specify: Sixth position: outlet openings 0 no outlets 2 two outlets, each side (48", 60" only) 4 four outlets, each side 6 six outlets (72" only), each side Specify: Seventh position: Raceway cover finish	Crown, raceway, and structural base covers are required for every wall frame in corresponding widths. Covers are specified in pairs to cover both sides of a frame. Raceway covers may be specified with no openings (desk-height raceway), two openings in the center, or four outlets at all possible locations in 48" or 60"W raceway. 72"W raceway may have four outlet openings in the center or six in all, each side. Raceway cover sets with outlet openings include black filler plates for one cover only.

Structural base cover kits *non-upholstered*

description	type	w	d	h	pattern no.	smooth solid	textured solid	perforated	textured perforated
Structural base covers (pair)	non upholstered	48"	1"	16"	APC AZ48 () ()	\$211.	\$233.	\$299.	\$329.
		60"	1"	16"	APC AZ60 () ()	243.	270.	343.	379.
		72"	1"	16"	APC AZ72 () ()	277.	305.	387.	426.

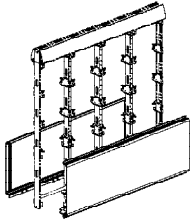

Order Code

Example:	APC AZ48 H 612
APC	Wall cover
AZ	Attachment zone
48	Width
H	Perforated
612	Finish

Specification Information

Structural base cover kit pattern numbers begin with APC AZ prefix, then cover width.

Specify:

Eighth position:

- P painted
- PT textured painted
- H perforated painted
- HT textured perforated painted

Ninth position: paint finish or fabric group

Specify paint finish for all covers.

Textured paint finishes for structural base covers only.

Application Notes

Crown, raceway, and structural base covers are required for every wall frame in corresponding widths. Covers are specified in pairs to cover both sides of a frame.

Structural base covers bolt to each side of the wall frame up to 21"H for structure and continuous attachment capability.

Structural base cover kits *upholstered*

description	type	w	d	h	pattern no.	10	15	20	30	35	40	45	50	55
Structural base covers (pair)	upholstered	48"	1"	16"	APC AZ48 F ()	\$303.	\$315.	\$325.	\$349.	\$357.	\$370.	\$381.	\$401.	\$424.
		60"	1"	16"	APC AZ60 F ()	357.	370.	383.	409.	422.	434.	447.	470.	500.
		72"	1"	16"	APC AZ72 F ()	n/a	424.	n/a	n/a	n/a	n/a	n/a	n/a	n/a

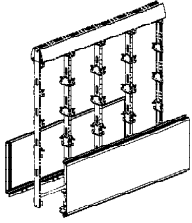

Order Code

Example: APC AZ48 F 10
APC Wall cover
AZ Attachment zone
48 Width
F Upholstered
10 Fabric

Specification Information

Structural base cover kit pattern numbers begin with APC AZ prefix, then cover width.

Specify:
Eighth position:

F fabric

Ninth position: paint finish or fabric group

Fabric groups:
Specify two-digit fabric group number

Application Notes

Crown, raceway, and structural base covers are required for every wall frame in corresponding widths. Covers are specified in pairs to cover both sides of a frame.

Structural base covers bolt to each side of the wall frame up to 21"H for structure and continuous attachment capability.

When ordering 60" wide or greater width upholstered structural base covers, please check the width of the fabric selected.

Access covers

outlets cover

Currents

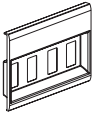
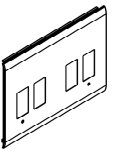
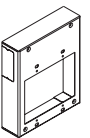
description	type	w	d	h	pattern no.	black	no finish	smooth
Outlets cover	9"H cover	12"	1"	9"	APC OC ()			\$26.
								
Hinged outlet flap (each)					APC OCF			25.
Outlet fillers (Set of 10)					AR OF		30.	
Hardwire outlets cover		12"	9"		APC HOC ()			40.
								
Hardwire outlet box, desk height	quad	2"			AR1 HOB			183.
	two quad	12"			AR1 HOB2			242.

Order Code

Example: APC OC 612	
APC	Service wall cover
OC	Outlets cover
612	Finish

Specification Information

Specify finish.

Application Notes

Locate outlets covers on wall frames before specifying other wall covers.

Outlets cover mounts between 21" and 30" (below standard desk height), 30" - 39" (above desk height) or 39" - 48" on service wall frame.

Outlets cover is 12" wide, and mounts anywhere on wall frame between 21" and 48" above the floor. Outlets cover corresponds to power components (specified separately) mounted on wall frame.

Outlets covers have four openings for power or PDC outlets. Specify outlet fillers for unused outlet openings in cover. Specify hinged outlet flap to conceal power or data outlet plugs. Each flap covers two openings; two flaps conceal all four openings in outlets cover.

For hardwire power applications (required in City of Chicago) specify hardwire outlets cover and hardwire outlets box. Do not specify cable tray covers at same level as hardwire power.

Hardwire outlet box accepts two Decora-style duplex outlets, and includes mounting brackets for one face of wall between 21" and 48"H. Two quad hardwire outlet box accepts four duplex outlets on one face. Also specify hardwire outlets cover, which has four outlet openings. Specify outlet fillers for any unused outlet openings.

Outlet boxes include openings to permit continuous lay-in wiring with Wiremold® raceway. Electrical contractor supplies infeed cable, Wiremold 2400®, and duplex outlets. Outlet boxes can be planned back to back, with distribution on one side of service wall. Wiremold will not fit behind cable tray covers.

Access covers

cable tray and slatwall covers

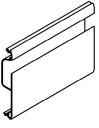
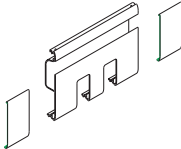
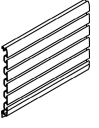
description	w	d	h	pattern no.	smooth
 9"H cable tray covers	12"	1"	9"	APC 0912 C ()	\$62.
	24"	1"	9"	APC 0924 C ()	74.
	36"	1"	9"	APC 0936 C ()	85.
	48"	1"	9"	APC 0948 C ()	111.
	60"	1"	9"	APC 0960 C ()	141.
	72"	1"	9"	APC 0972 C ()	171.
 9"H cable tray exit cover	12"	1"	9"	APC 0912 CX ()	122.
 9"H slatwall covers	12"	1"	9"	APC 0912 S ()	55.
	24"	1"	9"	APC 0924 S ()	63.
	36"	1"	9"	APC 0936 S ()	75.
	48"	1"	9"	APC 0948 S ()	97.
	60"	1"	9"	APC 0960 S ()	122.
	72"	1"	9"	APC 0972 S ()	148.

Order Code

Example:	APC 0948 C 612
APC	Service wall cover
09	Height
48	Width
C	Surface type
612	Finish

Specification Information

Specify finish.

Application Notes

Cable tray and slatwall covers provide integral performance surface on one or both sides of a wall frame. Cable tray and slatwall may be planned in combination with other painted or upholstered covers to enclose frames between 21"H and 48"H.

Cable tray mounts from 21" - 30" only on any panel frame. Adjacent trays form continuous, easily accessible cable management at worksurface or table height. Shorter segments provide local cable management below outlet modules. Covers may span across a straight wall frame connection.

Bottom half of cable tray cover permits cables to be managed on surface of studs with one cable holder (55 CAT5 cables) or two clips (28 cables).

Cable tray exit cover permits power jumpers and data/communication cables to pass from wall to Currents desk service beam. Cable tray exit cover, 12"W only, has two openings with sliding covers.

Slatwall supports KnollExtra task lights, monitor arms, paper trays, file holders and other accessories.

Access covers

marker surface and painted steel covers

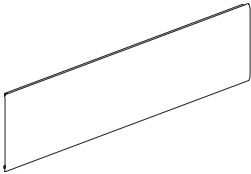
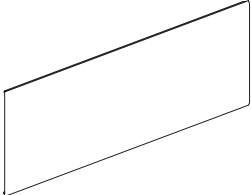
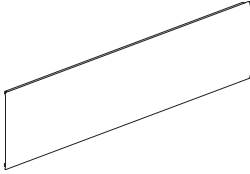
description	type	w	d	h	pattern no.	M	smooth	textured
9"H Marker surface covers 		24"	1	9"	APC 0924 M	\$36.		
		36"	1	9"	APC 0936 M	43.		
		48"	1	9"	APC 0948 M	49.		
		60"	1	9"	APC 0960 M	56.		
		72"	1	9"	APC 0972 M	61.		
16"H Marker surface covers 		48"	1	16"	APC 1648 M	72.		
		60"	1	16"	APC 1660 M	85.		
		72"	1	16"	APC 1672 M	97.		
9"H Painted steel covers 	smooth	12"	1"	9"	APC 0912 P ()		28.	
		24"	1"	9"	APC 0924 P ()		33.	
		36"	1"	9"	APC 0936 P ()		37.	
		48"	1"	9"	APC 0948 P ()		45.	
		60"	1"	9"	APC 0960 P ()		50.	
	textured	12"	1"	9"	APC 0912 PT ()			30.
		24"	1"	9"	APC 0924 PT ()			36.
		36"	1"	9"	APC 0936 PT ()			43.
		48"	1"	9"	APC 0948 PT ()			49.
		60"	1"	9"	APC 0960 PT ()			56.

Order Code	Specification Information	Application Notes
Example: APC 0948 P 117 APC Service wall cover 09 Height 48 Width P Surface type 117 Finish	9"H covers plan at any 9"H level in 39", 48", or 64" walls. For active face of 39"H frame, specify two 9"H covers each side. For active face of 48"H frame, specify three 9"H covers each side. For active face of 64"H frame, specify three 9"H covers and one 16"H cover each side. <i>Surface type:</i> P Painted PT Textured painted M Marker <i>Specify smooth or textured painted finish for steel covers.</i>	Marker surface covers are steel with a bright white dry-erase marker finish. Painted steel covers provide a durable wall-like surface in smooth or textured finish. Service wall covers enclose frames between 21"H and the top crown. Covers may be specified in any combination of widths corresponding to the total wall length. Covers may span across a straight wall frame connection. For active surfaces with access to cables and power/data/communications outlets, specify 9" and 16"H segmented covers as described in Specification Information. Normally, 9" cover from 21" to 30" above floor is cable tray or painted steel, and higher covers are painted, marker, upholstered, tackable, or slatwall surfaces.

Access covers

marker surface and painted steel covers

description	type	w	d	h	pattern no.	M	smooth	textured
9"H Painted steel covers	textured	72"	1"	9"	APC 0972 PT ()			\$61.
16"H Painted steel covers	smooth	48"	1"	16"	APC 1648 P ()		65.	
		60"	1"	16"	APC 1660 P ()		79.	
		72"	1"	16"	APC 1672 P ()		88.	
	textured	48"	1"	16"	APC 1648 PT ()			72.
		60"	1"	16"	APC 1660 PT ()			85.
		72"	1"	16"	APC 1672 PT ()			97.

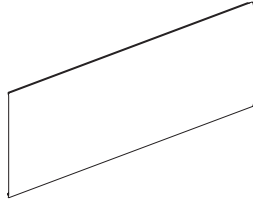

Order Code	Specification Information	Application Notes
Example: APC 0948 P 117	9"H covers plan at any 9"H level in 39", 48", or 64" walls.	Marker surface covers are steel with a bright white dry-erase marker finish.
APC Service wall cover		
09 Height	For active face of 39"H frame, specify two 9"H covers each side.	Painted steel covers provide a durable wall-like surface in smooth or textured finish.
48 Width		
P Surface type	For active face of 48"H frame, specify three 9"H covers each side.	Service wall covers enclose frames between 21"H and the top crown. Covers may be specified in any combination of widths corresponding to the total wall length. Covers may span across a straight wall frame connection.
117 Finish	For active face of 64"H frame, specify three 9"H covers and one 16"H cover each side.	
	<p><i>Surface type:</i></p> <p>P Painted PT Textured painted M Marker</p> <p><i>Specify smooth or textured painted finish for steel covers.</i></p>	For active surfaces with access to cables and power/data/communications outlets, specify 9" and 16"H segmented covers as described in Specification Information. Normally, 9" cover from 21" to 30" above floor is cable tray or painted steel, and higher covers are painted, marker, upholstered, tackable, or slatwall surfaces.

Access covers upholstered

Currents

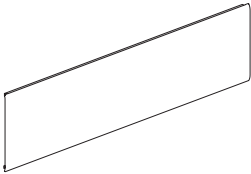
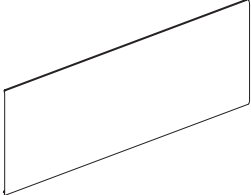
description	w	d	h	pattern no.	10	15	20	30	40	45	50	55
9"H Wall covers 	12"	1"	9"	APC 0912 F ()	\$54.	\$54.	\$57.	\$60.	\$61.	\$62.	\$63.	\$67.
	24"	1"	9"	APC 0924 F ()	66.	67.	70.	74.	77.	80.	84.	89.
	36"	1"	9"	APC 0936 F ()	80.	83.	84.	90.	96.	98.	103.	112.
	48"	1"	9"	APC 0948 F ()	88.	90.	95.	103.	110.	113.	117.	125.
	60"	1"	9"	APC 0960 F ()	104.	110.	114.	123.	133.	138.	145.	152.
	72"	1"	9"	APC 0972 F ()	n/a	124.	n/a	n/a	n/a	n/a	n/a	n/a
16"H Wall covers 	36"	1"	16"	APC 1636 F ()	117.	123.	126.	136.	145.	148.	153.	163.
	48"	1"	16"	APC 1648 F ()	130.	138.	144.	153.	163.	170.	178.	188.
	60"	1"	16"	APC 1660 F ()	157.	163.	172.	184.	197.	204.	215.	230.
	72"	1"	16"	APC 1672 F ()	n/a	185.	n/a	n/a	n/a	n/a	n/a	n/a

Order Code	Specification Information	Application Notes
Example: APC 0948 F15 APC Service wall cover 09 Height 48 Width F Surface type 15 Fabric group	For active face of 39"H frame, specify two 9"H covers. For active face of 48"H frame, specify three 9"H covers. For active face of 64"H frame, specify three 9"H covers and one 16"H cover. For full fabric surface between 5" and 21", order upholstered attachment zone cover. <i>Surface type:</i> F Upholstered <i>Specify fabric group:</i> 10 Fabric group 10 15 Fabric group 15 20 Fabric group 20 30 Fabric group 30 40 Fabric group 40 45 Fabric group 45 50 Fabric group 50 55 Fabric group 55	Upholstered service wall covers enclose frame between 21" and the top crown. Specify widths corresponding to wall frame width, or in any 12" increment to accommodate 12"W outlets covers or slatwall covers. Covers may span across a straight wall frame connection. For active surfaces with access to cables and power/data/communications outlets, specify 9" and 16"H segmented covers as described in Specification Information. Normally, 9" cover from 21" to 30" above floor is cable tray or painted steel, and higher covers are painted, marker, upholstered, tackable, or slatwall surfaces. When ordering 60" or wider covers, please check width of fabric specified.

Access covers tackable upholstered

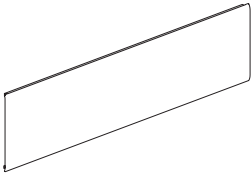
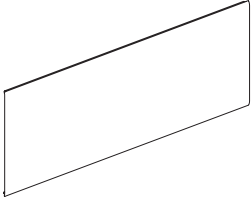
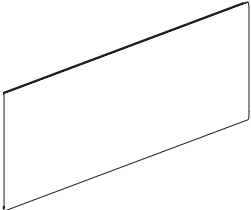
description	w	d	h	pattern no.	10	15	20	30	40	45	50	55
9"H Wall covers 	12"	1"	9"	APC 0912 A ()	\$104.	\$108.	\$111.	\$116.	\$125.	\$128.	\$134.	\$144.
	24"	1"	9"	APC 0924 A ()	104.	108.	111.	116.	125.	128.	134.	144.
	36"	1"	9"	APC 0936 A ()	104.	108.	111.	116.	125.	128.	134.	144.
	48"	1"	9"	APC 0948 A ()	113.	118.	123.	133.	142.	147.	154.	164.
	60"	1"	9"	APC 0960 A ()	135.	142.	148.	160.	172.	178.	187.	200.
	72"	1"	9"	APC 0972 A ()	n/a	162.	n/a	n/a	n/a	n/a	n/a	n/a
16"H Wall covers 	36"	1"	16"	APC 1636 A ()	154.	160.	166.	175.	186.	191.	202.	213.
	48"	1"	16"	APC 1648 A ()	171.	178.	185.	200.	213.	220.	232.	245.
	60"	1"	16"	APC 1660 A ()	204.	213.	224.	241.	258.	268.	279.	300.
	72"	1"	16"	APC 1672 A ()	n/a	242.	n/a	n/a	n/a	n/a	n/a	n/a
18"H Wall cover (replaces (2) 9"H) 	36"	1"	18"	APC 1836 A ()	184.	189.	196.	207.	218.	225.	237.	248.
	48"	1"	18"	APC 1848 A ()	231.	237.	244.	258.	272.	279.	290.	308.
	60"	1"	18"	APC 1860 A ()	276.	285.	292.	310.	327.	333.	344.	361.
	72"	1"	18"	APC 1872 A ()	n/a	321.	n/a	n/a	n/a	n/a	n/a	n/a

Order Code

Example: APC 0948 A20	
APC	Service wall cover
09	Height
48	Width
A	Surface type
20	Fabric group

Specification Information

For active face of 39"H frame, specify two 9"H covers. For passive face (along corridor or wall) specify one 18" cover.

For active face of 48"H frame, specify three 9"H covers or one 9"H and one 18"H cover. For passive face, specify 27"H cover.

For active face of 64"H frame, specify three 9"H covers and one 16"H cover or one 9"H, one 18"H, and one 16"H cover. For passive face, specify one 27" and one 16"H cover.

For full fabric surface between 5" and 21", order upholstered attachment zone cover.

Surface type:
A tackable upholstered

Specify fabric group:

10	Fabric group 10
15	Fabric group 15
20	Fabric group 20
30	Fabric group 30
40	Fabric group 40
45	Fabric group 45
50	Fabric group 50
55	Fabric group 55

Application Notes

Tackable upholstered service wall covers enclose wall frames between 21" and the top crown. Covers incorporate a tackable, acoustical core in the same outward profile as other upholstered covers.

Specify widths corresponding to wall frame width, or in any 12" increment to accommodate 12"W outlets covers or slatwall covers. Covers may span across a straight wall frame connection.

For active surfaces with access to cables and power/data/communications outlets, specify 9" and 16"H segmented covers as described in Specification Information. Normally, 9" cover from 21" to 30" above floor is cable tray or painted steel, and higher covers are painted, marker, upholstered, tackable, or slatwall surfaces.

For passive wall surfaces (corridors or conference areas) specify 18"H or 27"H covers in place of two or three 9"H covers.

18"H covers may also be specified above 9"H covers including outlets covers below desk height on 48" or 64"H service walls.

Service wall with upholstered tackable covers has been tested to NRC .40 and STC 22.

When ordering 60" or wider covers, please check width of fabric specified.

Access covers
tackable upholstered

description	w	d	h	pattern no.	10	15	20	30	40	45	50	55
27"H Wall cover (replaces (3) 9"H)	36"	1"	27"	APC 2736 A ()	\$276.	\$285.	\$292.	\$310.	\$327.	\$333.	\$344.	\$361.
	48"	1"	27"	APC 2748 A ()	346.	356.	363.	385.	402.	413.	427.	444.
	60"	1"	27"	APC 2760 A ()	417.	427.	431.	459.	479.	490.	504.	521.
	72"	1"	27"	APC 2772 A ()	n/a	485.	n/a	n/a	n/a	n/a	n/a	n/a



Order Code	Specification Information	Application Notes
Example: APC 0948 A20		
APC Service wall cover	For active face of 39"H frame, specify two 9"H covers. For passive face (along corridor or wall) specify one 18" cover.	Tackable upholstered service wall covers enclose wall frames between 21" and the top crown. Covers incorporate a tackable, acoustical core in the same outward profile as other upholstered covers.
09 Height		For passive wall surfaces (corridors or conference areas) specify 18"H or 27"H covers in place of two or three 9"H covers.
48 Width		18"H covers may also be specified above 9"H covers including outlets covers below desk height on 48" or 64"H service walls.
A Surface type	For active face of 48"H frame, specify three 9"H covers or one 9"H and one 18"H cover. For passive face, specify 27"H cover.	Service wall with upholstered tackable covers has been tested to NRC .40 and STC 22.
20 Fabric group	For active face of 64"H frame, specify three 9"H covers and one 16"H cover or one 9"H, one 18"H, and one 16"H cover. For passive face, specify one 27" and one 16"H cover.	When ordering 60" or wider covers, please check width of fabric specified.
	For full fabric surface between 5" and 21", order upholstered attachment zone cover.	
	<i>Surface type:</i> A tackable upholstered	
	<i>Specify fabric group:</i> 10 Fabric group 10 15 Fabric group 15 20 Fabric group 20 30 Fabric group 30 40 Fabric group 40 45 Fabric group 45 50 Fabric group 50 55 Fabric group 55	For active surfaces with access to cables and power/data/communications outlets, specify 9" and 16"H segmented covers as described in Specification Information. Normally, 9" cover from 21" to 30" above floor is cable tray or painted steel, and higher covers are painted, marker, upholstered, tackable, or slatwall surfaces.

Wall ends and connectors

90° and 120° spine connectors

Currents

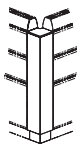
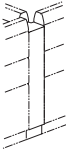
Service walls and components

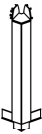
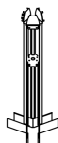
description	w	d	h	pattern no.	paint
 L connector, 90°	6"	6"	39"	AX1 L39 () ()	\$304.
	6"	6"	48"	AX1 L48 () ()	364.
	6"	6"	64"	AX1 L64 () ()	426.
 T connector, 90°	6"	7"	39"	AX1 T39 () ()	304.
	6"	7"	48"	AX1 T48 () ()	364.
	6"	7"	64"	AX1 T64 () ()	426.
 X connector, 90°	7"	7"	39"	AX1 X39 ()	304.
	7"	7"	48"	AX1 X48 ()	332.
	7"	7"	64"	AX1 X64 ()	364.
 V connector, 120°	5 1/2"	5 1/2"	39"	AX1 V39 () ()	304.
	5 1/2"	5 1/2"	48"	AX1 V48 () ()	364.
	5 1/2"	5 1/2"	64"	AX1 V64 () ()	426.
 Y connector, 120°	6 1/2"	5 1/2"	39"	AX1 Y39 () ()	304.
	6 1/2"	5 1/2"	48"	AX1 Y48 () ()	364.
	6 1/2"	5 1/2"	64"	AX1 Y64 () ()	426.

Order Code

Example:	AX1 L39 612 612
AX1	Currents connector
L	Type
39	Height
612	Trim/raceway cover finish
612	Top/end cap finish

Specification Information

For L, T, V, Y connectors specify:

Seventh position:
painted finish for vertical trim cover and raceway cover

Eighth position, and X connectors:
painted finish for top cap and crown end caps

Specify painted finishes for connector trim covers and crown end caps.

When ordering connectors for the spine frame with compact crown, specify compact crown end caps separately.

Application Notes

L, T, and X connectors join Currents frames at 90° angles and include vertical trim covers, top cap and standard crown end caps, and one spare set of straight connectors.

V and Y connectors join Currents frames at 120° angles and include vertical trim covers, top cap and standard crown end cap.

Wall ends and connectors

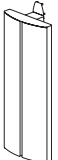

other ends and connectors

description	type	w	d	h	pattern no.	paint	list price
 Outrigger	deep	3"	15"	21"	AA1ORD ()	\$148.	
	standard	3"	8"	21"	AA1OR ()	107.	
 Stabilizer end cabinet	no lock	6 - 8"	19"	39"	AX1 STC39 3 ()()	1,353.	
		6 - 8"	19"	48"	AX1 STC48 3 ()()	1,466.	
		6 - 8"	19"	64"	AX1 STC64 3 ()()	1,690.	
	with lock	6 - 8"	19"	39"	AX1 STC39 L3 ()()	1,524.	
		6 - 8"	19"	48"	AX1 STC48 L3 ()()	1,635.	
		6 - 8"	19"	64"	AX1 STC64 L3 ()()	1,861.	
High low straight connector	48 - 39"	–	5"	48"	AX1 HLS4839 ()()	164.	
	64 - 39"	–	5"	64"	AX1 HLS6439 ()()	281.	
	64 - 48"	–	5"	64"	AX1 HLS6448 ()()	189.	
Service wall starter	39"	1"	2"	39"	AX1 SWS39 ()	94.	
	48"	1"	2"	48"	AX1 SWS48 ()	105.	
	64"	1"	2"	64"	AX1 SWS64 ()	119.	
Straight connector kit (replacement)		–	–	–	AX1 S	18.	

Order Code	Specification Information	Application Notes
Example: AX1 HLS4839 612 612 AX1 Currents connector HLS Type 4839 Height 612 Vertical cover finish 612 Crown end finish	For stabilizer end specify: <i>Tenth position:</i> cabinet finish <i>Eleventh position:</i> top cap finish <i>Specify painted finishes for outrigger, stabilizer end cabinet, top and standard crown end caps.</i> <i>For flat ends specify:</i> <i>Seventh position:</i> painted finish for outside trim cover and raceway cover <i>Eighth position:</i> painted finish for crown end cap When specifying a flat end for a frame with the 1 inch compact crown, compact crown end caps must be ordered separately. <i>Specify painted finish for standard crown end cap.</i> Specify trim grey or easy grey integral color for compact crown end cap. Standard crown end caps are included with all Currents connectors except Equity end trim kits.	Outrigger connects to structural base cover at any point. Outriggers (or perpendicular systems panels) are required every 8' and adjacent to flat end for adequate support. Specify deep outriggers when cantilevering 24"D worksurfaces without adjacent perpendicular systems panels or Currents service wall connectors. Standard outrigger should be specified when desks or credenzas with service beam are positioned along service wall. Stabilizer end cabinet supports one end of Currents service wall spine. Hinged cover panels in cabinet open for access to data/telecom consolidation point and cable storage. Stabilizer end cabinet with lock has recessed KnollKey lock in finger pull reveal.
		Stabilizer end cabinet expands the end of the Currents spine 3 1/2" to accommodate intermediate panel divisions between workstations. In the 3 1/2" x 5" space above this extension a ceiling infeed panel may be added. Inside back corner covers may be removed for unobstructed access to cabinet and wall frame surface. High-low straight connectors join service wall of different heights in a straight line. Service wall starter connects service wall to building wall. Straight connector is replacement hardware kit to join Currents wall frames of the same height end to end. Kit includes four barrel-shape connectors and hardware. Flat end finishes end of corresponding height spine when end of wall is supported by outriggers.

Wall ends and connectors

other ends and connectors

description	type	w	d	h	pattern no.	paint	list price
 Flat end		–	5"	39"	AX1 F39 () ()	\$96.	
		–	5"	48"	AX1 F48 () ()	110.	
		–	5"	64"	AX1 F64 () ()	122.	
Crown end cap					APT ()	5.	
 Crown end cap compact	Kit of 1				APTA CC1 ()		12.
	Kit of 10				APTA CC ()		98.

Order Code

Example:	AX1 HLS4839 612 612
AX1	Currents connector
HLS	Type
4839	Height
612	Vertical cover finish
612	Crown end finish

Specification Information

For stabilizer end specify:

Tenth position:
cabinet finish

Eleventh position:
top cap finish

Specify painted finishes for outrigger, stabilizer end cabinet, top and standard crown end caps.

For flat ends specify:

Seventh position:
painted finish for outside trim cover and raceway cover

Eighth position:
painted finish for crown end cap

When specifying a flat end for a frame with the 1 inch compact crown, compact crown end caps must be ordered separately.

Specify painted finish for standard crown end cap.

Specify trim grey or easy grey integral color for compact crown end cap. Standard crown end caps are included with all Currents connectors except Equity end trim kits.

Application Notes

Outrigger connects to structural base cover at any point. Outriggers (or perpendicular systems panels) are required every 8' and adjacent to flat end for adequate support. Specify deep outriggers when cantilevering 24"D worksurfaces without adjacent perpendicular systems panels or Currents service wall connectors.

Standard outrigger should be specified when desks or credenzas with service beam are positioned along service wall.

Stabilizer end cabinet supports one end of Currents service wall spine. Hinged cover panels in cabinet open for access to data/telecom consolidation point and cable storage. Stabilizer end cabinet with lock has recessed KnollKey lock in finger pull reveal.

Stabilizer end cabinet expands the end of the Currents spine 3 1/2" to accommodate intermediate panel divisions between workstations. In the 3 1/2" x 5" space above this extension a ceiling infeed panel may be added. Inside back corner covers may be removed for unobstructed access to cabinet and wall frame surface.

High-low straight connectors join service wall of different heights in a straight line.

Service wall starter connects service wall to building wall.

Straight connector is replacement hardware kit to join Currents wall frames of the same height end to end. Kit includes four barrel-shape connectors and hardware.

Flat end finishes end of corresponding height spine when end of wall is supported by outriggers.

Wall ends and connectors

fence ends and connectors

connectors

Currents

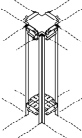
description	w	d	h	pattern no.	list price
L connector, 90 degrees	6"	6"	19"	AX1 L18 ()	\$316.
					
T connector, 90 degrees	6"	7"	19"	AX1 T18 ()	322.
					
X connector, 90 degrees	7"	7"	19"	AX1 X18	266.
					
V connector, 120 degrees	5 1/2"	5 1/2"	19"	AX1 V18 ()	288.
					
Y connector, 120 degrees	6 1/2"	5 1/2"	19"	AX1 Y18 ()	134.
					

Order Code

Example: AX1 L 18 613	
AX1	Fence connector
L	Type
18	Height
613	Trim finish

Specification Notes

Specify painted finishes for connector trim covers.

For L, T, V and Y connectors specify finish for vertical trim.

All top caps and crown covers are trim grey. Specify finish for outside trim of flat end.

Application Notes

L, T and X connectors join frames at 90° angles and include vertical trim covers, top cap and crown end caps and one set of straight connectors.

Y and V connectors join frames at 120° angles.

Flat end finishes end of Fence frames and includes crown end detail.

Wall ends and connectors
fence ends and connectors
connectors

description	w	d	h	pattern no.	list price
Flat end	-	5"	19"	AX1 F18 ()	\$121.



Order Code

Example: AX1 L 18 613
AX1 Fence connector
L Type
18 Height
613 Trim finish

Specification Notes

Specify painted finishes for connector trim covers.

For L, T, V and Y connectors specify finish for vertical trim.

All top caps and crown covers are trim grey. Specify finish for outside trim of flat end.

Application Notes





L, T and X connectors join frames at 90° angles and include vertical trim covers, top cap and crown end caps and one set of straight connectors.

Y and V connectors join frames at 120° angles.

Flat end finishes end of Fence frames and includes crown end detail.

Wall ends and connectors
fence ends and connectors
other hardware

Currents

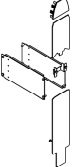
description	type	w	d	h	pattern no.	list price
T-end adapter 	0" or 1 1/8" extension	1 3/8"	2 1/8"	2 3/8"	AX1 AK1 ()	\$18.
						
T-end and stabilizer end cabinet adapter 	3 1/2" extension	4"	5"	16 1/2"	AX1 AK3 ()	72.
						
Flat wall starter 	48"H service wall		3 1/4"	27"	AX1 FWS 48	61.
	64"H service wall		3 1/4"	43"	AX1 FWS 64	66.
	Fence and 39"H wall		3 1/4"	18"	AX1 FWS 39	55.
High-low straight connector 	48"H wall - Fence				AX1 FHLS4818 ()	344.

Order Code

Example: AX1 FWS 39	
AX1	Fence end
FWS	Type
39	Height

Specification Information

Specify painted finishes for T-end adapter kits.
 Flat wall starter is black only.
 Crown end covers are trim grey.

Application Notes

Fence accepts Currents T-ends for 39" service wall and 39"H stabilizer end cabinet.
 High-low fence connector joins fence and 48"H Currents service wall.
 Specify AX1 AK1 adapter kit to complete bottom trim and crown end of T-ends with 0" or 1 1/8" extension.
 Specify AX1 AK3 adapter kit to complete bottom trim and crown end of T-ends with 3" extension and 39"H stabilizer end cabinet.
 Flat wall starter connects Fence frames and Currents service wall to building wall.

Wall frame accessories

wall frame

Currents

Service walls and
components

description	type	w	d	h	pattern no.	list price
Acoustical inserts	39"H	12"	2"	34"	APA 39	\$25.
	48"H	12"	2"	43"	APA 48	29.
	64"H	12"	2"	59"	APA 64	40.

Order Code

Specification Information

Application Notes

Example: **APT 612**

APT Service wall trim

612 Painted finish

Acoustical inserts fit between studs in service wall frame to increase control of sound transmission. Inserts are bagged in heights corresponding to wall frame. Specify four inserts for 48"W frame, five for 60"W frame, and six for 72"W frame. Service walls with acoustical inserts have been tested to STC 33.

Wall frame accessories

fence frame

Currents

description	type	w	d	h	pattern no.	list price
Wire manager cover (set of 2)		3 1/2"	3"	18 3/8"	AR1 VCM	\$53.
						
Carpet grips (set of 10)					AA1CG	12.
Non-skid pads (set of 10)					AA1NSK	31.
Hardwire fence infeed (NYC)	2 + 2				AR1 EPHF	408.
	3 + 3				AR1 TPHF	434.

Order Code

Example	AR1 VCM
AR1	Raceway
VCM	Type

Specification Information

Wire manager covers are integral color trim grey.



Application Notes

Wire manager covers snap into the sides of the fence legs to guide cables from the floor to the underside of the frame.

Carpet grips and/or non-skid pads snap onto bottom of stabilizer feet to prevent legs from sliding.

Hardwire fence infeed is approved for City of New York installation. Infeed includes wire manager cover, junction box and connector to desk height outlet module.

Spine end connectors for linkable screens and Morrison panels

description	application	h	w	d	pattern no.	list
 Spine end connector	39" h spine	39"	5"	1/2"	AX1SEC3939 () () ()	\$210.
	48" h spine	48"	5"	1/2"	AX1SEC4848 () () ()	220.
	64" h spine	64"	5"	1/2"	AX1SEC6464 () () ()	263.
Spine end connector to top of compact 1" h crown	39" h spine	40"	5"	1/2"	AX1SEC4039 L () ()	210.
	48" h spine	49"	5"	1/2"	AX1SEC4948 L () ()	220.
	64" h spine	65"	5"	1/2"	AX1SEC6564 L () ()	263.
 Spine end connector to top of Currents 4" h crown	39" h spine	43"	5"	1/2"	AX1SEC4339 C () ()	210.
	48" h spine	52"	5"	1/2"	AX1SEC5248 C () ()	220.
	64" h spine	68"	5"	1/2"	AX1SEC6864 C () ()	263.
Inside base trim cover for Currents raceway		4"	5"		AX1SECBT ()	42.

Order Code	Specification Information	Application Notes
Example: AX1 SEC 3939 L 613 812 <hr/> AX1 Spine connector <hr/> SEC Type <hr/> 39 Connector height <hr/> 39 Spine height <hr/> L Crown type <hr/> 613 Crown end cap finish <hr/> 613 Vertical cover finish <hr/> 812 Top cap finish	For spine end connectors specify: 1.Crown type C=Currents standard 4" h L=low profile flat 1" H=high profile flat 1 1/4" F=compact crown 1" 2.Crown end cap finish Standard, low and high profile flat and compact crown end caps are available in all standard paint finishes and 813 Trim Grey. Compact crown end caps are also available in 812 Easy Grey. 3.Vertical cover finish: All standard paint finishes 4.Top cap for vertical cover: 812=Easy Grey 813=Trim Grey And all standard paint finishes Spine end connectors on this page align with spine base covers ^{13/16"} above the floor.	Spine end connectors are complete vertical cover and top trim for the end of an AutoStrada or Currents spine. Side edges of end connectors accept end starters for linkable screens and other systems panels of the same height or lower. Spine end connectors include painted aluminum cover with beveled top cap and the specified flat, compact, or standard crown end cap. Spine end connectors to top of compact crown are a visual alternative that replaces the crown end cap with a taller aluminum end cover and flat top cap. Spine end connectors to top of Currents crown are recommended when attaching any end started panel that is between the nominal height of the spine and the actual height with crown, such as 42" h panel to 39" h spine with 4" h crown. Spine end connectors to top of Currents crown enclose the end of spine and standard crown and include flat top cap and inside top trim cover.

Spine ends and connectors
*High-low spine end connectors
 for linkable screens and Morrison panels*

description	application	h	w	d	pattern no.	list
 Spine end connector	42" h panel/39" h spine	39"	5"	1/2"	AX1SEC4239 () ()	\$210.
	48" h panel/39" h spine	48"	5"	1/2"	AX1SEC4839 () ()	220.
	56" h panel/39" h spine	56"	5"	1/2"	AX1SEC5639 () ()	252.
	64" h panel/39" h spine	64"	5"	1/2"	AX1SEC6439 () ()	263.
	56" h panel/48" h spine	56"	5"	1/2"	AX1SEC5648 () ()	252.
	64" h panel/48" h spine	64"	5"	1/2"	AX1SEC6448 () ()	263.
	80" h panel/48" h spine	80"	5"	1/2"	AX1SEC8048 () ()	400.
	80" h panel/64" h spine	80"	5"	1/2"	AX1SEC8064 () ()	383.
Inside base trim cover for Currents raceway		4"	5"		AX1SECBT ()	42.

Order Code	Specification Information	Application Notes
Example: AX1 SEC 6448 613 812 AX1 Spine connector SEC Type 64 Panel height 48 Spine height 613 Painted finish 613 Trim finish	For spine end connectors specify: 1. Vertical cover finish: All standard paint finishes 2. Top cap for vertical cover 812=Easy Grey 813=Trim Grey And all standard painted finishes Spine end connectors on this page align with spine base covers ¹³ / ₁₆ " above the floor.	High low spine end connectors are complete end cover and trim for an AutoStrada or Currents spine, when attached panels are taller than the spine. High low spine end connectors match the height of the attached linkable screen or Morrison panel. Side edges of spine end connectors accept end starters for linkable screens and Morrison panels of the same height or lower. High low spine end connectors include painted aluminum outside cover with flat top cap and inside cover over the end of the spine. Inside base trim for Currents raceway is recommended to finish inside of any spine end connector when combined with standard Currents recessed base raceway covers. Base trim is not required with AutoStrada spine base covers.

Note: 42" h panel/39" h spine combination (AX1SEC4239) can only be specified with compact or flat crown versions of the spine. For combination of 39" h spine with standard 4" h crown and 42" h panels specify AX1SEC4339C () ().

Spine ends and connectors

Spine end connectors for Dividends Horizon panels

description	application	h	w	d	pattern no.	list
Spine end connector	36"h panel/39"h spine	39"	5"	1/2"	AX1SED3939 () () ()	\$210.
	36"h-42"h panel/ 48"h spine	48"	5"	1/2"	AX1SED4848 () () ()	220.
	36"h-64"h panel/ 64"h spine	64"	5"	1/2"	AX1SED6464 () () ()	263.
	42"h panel/ 39"h spine + 1" crown	42"	5"	1/2"	AX1SED4239 () ()	210.
	42"h panel/ 39"h spine + 4" crown	43"	5"	1/2"	AX1SED4339C () ()	210.
	50"h panel/ 39"h spine	50"	5"	1/2"	AX1SED5039 () ()	220.
	50"h panel/ 48"h spine + 1" crown	50"	5"	1/2"	AX1SED5048 () ()	231.
	50"h panel/ 48"h spine + 4" crown	52"	5"	1/2"	AX1SED5248C () ()	220.
	57"h panel/ 39"h spine	57"	5"	1/2"	AX1SED5739 () ()	252.
	57"h panel/ 48"h spine	57"	5"	1/2"	AX1SED5748 () ()	252.
	64"h panel/ 39"h spine	64"	5"	1/2"	AX1SED6439 () ()	263.
	64"h panel/ 48"h spine	64"	5"	1/2"	AX1SED6448 () ()	263.
	78"h panel/ 48"h spine	78"	5"	1/2"	AX1SED7848 () ()	400.
78"h panel/ 64"h spine	78"	5"	1/2"	AX1SED7864 () ()	383.	
Inside base trim cover for Currents raceway		4"	5"		AX1SECBT ()	42.

Order Code	Specification Information	Application Notes												
<p>Example: AX1 SED 6448 613 812</p> <table border="1"> <tr> <td>AX1</td> <td>Spine connector</td> </tr> <tr> <td>SED</td> <td>Type</td> </tr> <tr> <td>64</td> <td>Panel height</td> </tr> <tr> <td>48</td> <td>Spine height</td> </tr> <tr> <td>613</td> <td>Vertical cover finish</td> </tr> <tr> <td>812</td> <td>Top cap finish</td> </tr> </table>	AX1	Spine connector	SED	Type	64	Panel height	48	Spine height	613	Vertical cover finish	812	Top cap finish	<p>For spine end connectors with panel lower than spine specify crown type and finish for crown end cap.</p> <ol style="list-style-type: none"> Crown type: C=Currents standard 4"h L=low profile flat 1"h H=high profile flat 1 1/4"h F=compact 1"h All crown end caps are available in all painted finishes. For all spine end connectors specify vertical cover and top trim finish: Vertical cover finish: All standard paint finishes Top cap for vertical cover: 812=Easy Grey 813=Trim Grey And all standard painted finishes <p>End connectors on this page begin 1/2" above floor.</p>	<p>Spine end connectors are complete end cover and trim for an AutoStrada or Currents spine. Side edges of spine end connectors accept end starters for Dividends panels.</p> <p>In most cases spine end connectors match the height of the attached Dividends panel. When attached panel is lower than the spine, the spine end connector is as high as the nominal height of the spine and the crown requires an end cap.</p> <p>When attached panel is between the nominal height of the spine and the top of the Currents 4"h crown, spine end connector must cover the entire height of the spine with crown.</p> <p>Spine end connectors include painted aluminum outside cover with flat top cap and inside cover (where applicable) over the end of the spine.</p> <p>Inside base trim for Currents raceway is recommended to finish inside when combined with standard Currents recessed base raceway covers. Base trim is not required with AutoStrada spine base covers.</p> <p>Spine end connectors, end starters, panel starters and panel starter end trim for Dividends Horizon panels cannot be used to attach Dividends Horizon screens (open weave, glass or other screens) directly to an AutoStrada or Currents spine. In applications where Dividends Horizon open weave, glass or other screens are specified perpendicular to an AutoStrada or Currents spine, you must first connect a Dividends Horizon panel to the spine via a spine end connector and end starter or panel starter, and then connect the Dividends Horizon panel to the Dividends Horizon open weave, glass or other screen.</p>
AX1	Spine connector													
SED	Type													
64	Panel height													
48	Spine height													
613	Vertical cover finish													
812	Top cap finish													

3 1/2" spine extender kit for use with ceiling infeed or panels

description	application	h	w	d	pattern no.	list
Spine extender	39"h spine	39"	5"	4"	AX1SX39 (A/C)(L/C/P)() ()	n/a
	48"h spine	48"	5"	4"	AX1SX48 (A/C)(L/C/P)() ()	n/a
	64"h spine	64"	5"	4"	AX1SX64 (A/C)(L/C/P)() ()	n/a

Order Code	Specification Information	Application Notes
Example: AX1 SX 48 AL 613 613	For all 3 1/2" spine extenders specify spine base type:	Spine extenders include brackets, side and top trim covers between the end of a spine and any spine end connector to add 3 1/2" to the length of a spine.
AX1 Spine connector	A AutoStrada C Currents	
SX Type		Spine extender dimension matches that of the Currents 3 1/2"x 5" ceiling infeed panel which may be added between nominal spine height and ceiling for connection to building power, data and communications supply.
48 Spine height	Then specify crown end type. L=Square, C=Standard and Compact, P=Power Pole.	
A Spine type		In most cases the spine end connector matches the height of the attached Dividends panel, but the extending area is only as high as the nominal height of the spine (bottom of crown) so the crown always requires an end cap.
L Crown end type		
613 Vertical finish	Then specify finish for vertical trim covers, all standard painted finishes.	When attached panel is lower than the spine, the spine end connector should be the same height as the nominal height of the spine.
613 Base trim finish		
613 Top cap finish	Then specify base cover finish. AutoStrada spine base covers are clear anodized aluminum (AA) or painted finish excluding silver. Currents spine base covers are available in any painted finish only.	
	Then specify top cap finish (if applicable).	

To attach linkable screens or Morrison panels to spine end connector

description	application	h	w	d	pattern no.	00	02	04
End starters for linkable screens	30" h screen	25"	1"	1/2" - 4 1/2"	AX1LES30 () ()	\$126.	\$137.	\$147.
	39" h screen	34"	1"	1/2" - 4 1/2"	AX1LES39 () ()	137.	147.	163.
	48" h screen	43"	1"	1/2" - 4 1/2"	AX1LES48 () ()	158.	178.	200.
	64" h screen	59"	1"	1/2" - 4 1/2"	AX1LES64 () ()	184.	215.	247.
End starters for Morrison panels	30" h screen	30"	1"	1/2" - 4 1/2"	AX1MES30 () ()	132.	137.	147.
	39" h screen	39"	1"	1/2" - 4 1/2"	AX1MES39 () ()	158.	163.	178.
	42" h screen	42"	1"	1/2" - 4 1/2"	AX1MES42 () ()	158.	163.	184.
	48" h screen	48"	1"	1/2" - 4 1/2"	AX1MES48 () ()	163.	168.	190.
	56" h screen	56"	1"	1/2" - 4 1/2"	AX1MES56 () ()	190.	210.	237.
	64" h screen	64"	1"	1/2" - 4 1/2"	AX1MES64 () ()	190.	210.	237.
	80" h screen	80"	1"	1/2" - 4 1/2"	AX1MES80 () ()	273.	315.	378.
End starter top cap for Morrison panel with linkable screen trim	00, 02 or 04 offset		1"	2 1/4"	AX1LES E ()	10.	10.	10.

Order Code	Specification Information	Application Notes
Example: AX1 LES48 02 613 812	For spine end starters specify:	End starters connect a linkable screen or panel to either side of a spine end connector of the same height or taller.
AX1 Spine connector	1. Configuration	End starters for linkable screens and Morrison panels include connector track and top cap.
L for linkable screens	00=Flush	For Morrison panels that have linkable screen trim also specify end starter linkable screen end cap.
ES End starter	02=Offset one panel	End starters are available in three configurations: flush with end of spine or offset one or two screen/panel thickness beyond end of spine.
48 Panel height	04=Offset two panels	For full access to entire width of spine surface specify end starters offset one panel thickness (02 suffix).
02 Offset	2. Paint finish for end starter: All standard paint finishes	For a cluster of two workstations with one screen or panel between specify one end starter offset two panel thicknesses (04 suffix) and one offset one thickness (02 suffix).
613 Painted finish	3. Trim finish for top cap: 812=Easy Grey 813=Trim Grey	For a cluster of three workstations (two intermediate panels) specify two end starters offset two panel thicknesses (04 suffix).
812 Trim finish	End starters on this page align with spine base covers 13/16" above the floor.	For a cluster of four workstations (three intermediate panels) extend the spine 12" and specify two flush end starters (00 suffix).
		When specifying an end starter top cap for a Morrison panel with linkable screen trim, note that the 02 offset top cap will also work in an 04 offset application.

To attach Dividends Horizon panels to spine end connector

description	application	h	w	d	pattern no.	list
End starters for Dividends panels	36" h panel	36"	1"	1/2-3"	AX1DES36 () ()	\$124.
	42" h panel	42"	1"	1/2-3"	AX1DES42 () ()	134.
	50" h panel	50"	1"	1/2-3"	AX1DES50 () ()	144.
	57" h panel	57"	1"	1/2-3"	AX1DES57 () ()	144.
	64" h panel	64"	1"	1/2-3"	AX1DES64 () ()	149.
	78" h panel	78"	1"	1/2-3"	AX1DES78 () ()	165.

Order Code	Specification Information	Application Notes
Example: AX1 DES 50		
AX1 Spine connector	1.Top cap type	End starters connect a Dividends panel to either side of a same height or taller spine end connector. End starters for Dividends panels include specified end top cap.
D Dividends	4=Metal Radius or Plastic Enhanced Smooth Radius	
ES End starter	5=Metal Flat	End starters may be positioned in either of two configurations: flush with end of spine or offset one panel thickness beyond end of spine. For full access to entire width of spine surface, position end starters offset one panel thickness.
50 Panel height	2.Paint finish	
5 Top cap type	All standard paint finishes	
613 Painted finish	End starters on this page begin 1/2" above floor.	For a single workstation (0 intermediate panels), specify 2 spine end connectors and 2 end starters positioned offset by 1 panel thickness.
	Spine end connectors, end starters, panel starters and panel starter end trim for Dividends Horizon panels cannot be used to attach Dividends Horizon screens (open weave, glass or other screens) directly to an AutoStrada or Currents spine. In applications where Dividends Horizon open weave, glass or other screens are specified perpendicular to an AutoStrada or Currents spine, you must first connect a Dividends Horizon panel to the spine via a spine end connector and end starter or panel starter, and then connect the Dividends Horizon panel to the Dividends Horizon open weave, glass or other screen.	For a cluster of 2 workstations (1 intermediate panel), specify 1 panel starter, 2 spine end connectors, 1 spine extender, and 2 end starters positioned offset by 1 panel thickness.
		For a cluster of 3 workstations, (2 intermediate panels), extend the spine another 12", specify 2 panel starters, 2 spine and connectors, and 2 end starters positioned inset.
		For a cluster of 4 workstations (3 intermediate panels), extend the spine 12" and specify 3 panels starters, 2 spine end connectors, and 2 end starters (1 end starter inset and the other offset by 1 panel thickness).
		For a cluster of 5 workstations (4 intermediate panels) extend the spine by 12" and specify 4 panel starters, 2 spine end connectors, and 2 end starters positioned offset by 1 panel thickness.

Panel system starters and T-ends

Morrison or linkable screen panel starters

description	type	w	d	h	pattern no.	paint	
	Morrison and linkable screen panel starters	30"H panel	4"	1"	26"	AA1MPS30()	\$97.
	39"H panel/screen	4"	1"	35"	AA1MPS39()	97.	
	42"H panel	4"	1"	38"	AA1MPS42()	97.	
	48"H panel/screen	4"	1"	44"	AA1MPS48()	102.	
	56"H panel	4"	1"	52"	AA1MPS56()	107.	
	64"H panel/screen	4"	1"	60"	AA1MPS64()	111.	
	74"H panel	4"	1"	70"	AA1MPS74()	116.	
	80"H panel	4"	1"	76"	AA1MPS80()	116.	
	Morrison raceway shroud	2 1/4"	3"	4"	AA1MRS()	42.	
	panel/screen top clip				AA2 MTC ()	49.	

	Morrison end trim	30"H panel	1"	2 1/4"	9"	AA1MET30()	33.
	39"H panel	1"	2 1/4"	18"	AA1MET39()	33.	
	42"H panel	1"	2 1/4"	21"	AA1MET42()	36.	
	48"H panel	1"	2 1/4"	27"	AA1MET48()	38.	
	56"H panel	1"	2 1/4"	35"	AA1MET56()	40.	
	64"H panel	1"	2 1/4"	43"	AA1MET64()	47.	
	74"H panel	1"	2 1/4"	53"	AA1MET74()	52.	
	80"H panel	1"	2 1/4"	59"	AA1MET80()	55.	

Currents end trim	39" linkable screen	1"	2"	18"	AA1CET39()	33.
	48" linkable screen	1"	2"	27"	AA1CET48()	38.
	64" linkable screen	1"	2"	43"	AA1CET64()	47.

Order Code	Specification Information	Application Notes
Example: AA1 MPS48 612		
AA1 Accessory	<i>Specify paint finishes for panel starters, Morrison raceway shroud and end trim.</i>	Panel starters attach perpendicular panels or linkable screens to Currents service wall structural base covers (5" - 21"H).
M Morrison		Optional Morrison end trim fills 5/8" reveal between panel end and Currents wall surface. End trim also includes end top cap (high/low corner top cap is not required in this application).
PS Panel starter	Specify trim grey or easy grey integral color for Currents end trim.	Panel starters include clamp bracket to any height Currents wall and full height connector track with modified top wedge block. For Morrison also specify high/low corner top cap MT5 HLC () in width of first panel.
48 Panel height		Currents end trims are optional fillers for linkable screen starters. End trims may interfere with easy access to wall covers.
612 Finish		Top clip connects panel connector track to Currents crown. Specify top clip for added stiffness of panels higher than 48" or whenever cantilevering components from panel. Top clip is not compatible with end trim.
		Specify raceway shroud if connecting power from Currents service wall to Morrison panel.

Panel system starters and T-ends

Currents

Morrison, Currents screens and linkable screen T-ends non-upholstered

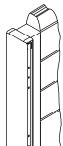
description	type	w	d	h	pattern no.	0" or 1 1/8" extension	3 1/2" extension
 T ends for Currents screens and linkable screens	39" screen/39" spine	2 1/4"-5 3/4"	7"	39"	AX2 C3939 () ()	\$666.	\$746.
	48" screen/39" spine	2 1/4"-5 3/4"	7"	48"	AX2 C4839 () ()	773.	853.
	48" screen/48" spine	2 1/4"-5 3/4"	7"	48"	AX2 C4848 () ()	719.	799.
	64" screen/39" spine	2 1/4"-5 3/4"	7"	64"	AX2 C6439 () ()	881.	959.
	64" screen/48" spine	2 1/4"-5 3/4"	7"	64"	AX2 C6448 () ()	826.	906.
	64" screen/64" spine	2 1/4"-5 3/4"	7"	64"	AX2 C6464 () ()	826.	906.

description	type	w	d	h	pattern no.	0" or 1 1/8" extension	3 1/2" extension
 T ends for Morrison panels	39" panel/39" spine	6"	7"	39"	AX1 M3939 () ()	666.	746.
	42" panel/39" spine	6"	7"	42"	AX1 M4239 () ()	719.	799.
	48" panel/39" spine	6"	7"	48"	AX1 M4839 () ()	773.	853.
	48" panel/48" spine	6"	7"	48"	AX1 M4848 () ()	719.	799.
	56" panel/39" spine	6"	7"	56"	AX1 M5639 () ()	826.	906.
	56" panel/48" spine	6"	7"	56"	AX1 M5648 () ()	773.	853.
	64" panel/39" spine	6"	7"	64"	AX1 M6439 () ()	881.	959.
	64" panel/48" spine	6"	7"	64"	AX1 M6448 () ()	826.	906.
	64" panel/64" spine	6"	7"	64"	AX1 M6464 () ()	826.	906.
	80" panel/39" spine	6"	7"	80"	AX1 M8039 () ()	1,066.	1,172.
	80" panel/48" spine	6"	7"	80"	AX1 M8048 () ()	1,066.	1,172.
	80" panel/64" spine	6"	7"	80"	AX1 M8064 () ()	1,066.	1,172.

Order Code

Example:	AX1 M6448 3 612, 612
AX1	Currents connector
M	Morrison
64	Morrison height
48	Currents height
3	Extension
612	Top cap finish
612	Vertical trim cover

Specification Information

T-ends begin with AX1-prefix.
Fourth position indicates attached panel system:

C Currents screen/linkable screen
M Morrison panel

Fifth/sixth position: height of panel.

Seventh/eighth position: height of service wall.

Ninth position: extension at end of spine.

0 0" extension
1 1 1/8" extension
3 3 1/2" extension

Tenth position: painted finish for Morrison top caps and crown end.

Eleventh position: painted finish for vertical trim cover.

When ordering T-ends for spine, specify crown end caps separately.

Application Notes

T-end encloses the end of a Currents service wall and connects to perpendicular Currents wall-attached screens, linkable screens or panels on one or both sides. T-ends include Morrison-style top trim for the 7" wide connection to panels or screens.

Currents T-end includes 5" and 6" wide trim and two end caps.

Morrison T-end includes 7" wide trim.

Use 5" wide trim and two end caps when connecting to Currents screens on both sides.

Use 6" wide trim and one end cap when connecting to Currents screens on one side only. Specify Morrison end connector separately to finish side edge without a connected screen.

Use 7" wide trim when connecting to Morrison panels.

Specify Morrison end connector, top cap and raceway cover kits separately to finish side edge of Morrison T-ends without a connected panel.

Specify Morrison straight connector separately to attach linkable screen or panel.

Specify T-ends for Morrison or Currents to capture the end of the wall (no extension) or to extend the wall 1 1/8" or 3 1/2". This extension enables precise planning of multiple workstations and intermediate panels between workstations.

Specify two 0" T-ends for a single workstation on each side (no intermediate panels).

Specify two 1 1/8" T-ends for one intermediate panel, one 1 1/8" and one 3 1/2" for two panels, and two 3 1/2" for three intermediate panels.





T-ends with 3 1/2" extension have removable inside covers and accept ceiling infed panel.

Panel system starters and T-ends

Equity panel starters, end starters and trim kits

Currents

Service walls and components

description	type	pattern no.	list price
 Equity panel starters	40"	AA1EPS40	\$235.
	41"	AA3EPS41	276.
	48"	AA1EPS48	245.
	49"	AA3EPS49	289.
	53"	AA1EPS53	255.
	54"	AA3EPS54	302.
	60"	AA1EPS60	267.
	61"	AA3EPS61	315.
	64"	AA3EPS64	325.
	65"	AA1EPS65	277.
 Equity end starters	40"	AX1 E40	235.
	41"	AX3E41	276.
	48"	AX1 E48	245.
	49"	AX3E49	289.
	53"	AX1 E53	255.
	54"	AX3E54	302.
	60"	AX1 E60	267.
	61"	AX3E61	315.
	64"	AX3E64	325.
	65"	AX1 E65	277.
 Equity end trim kits	39"H wall	AX1 EET39(T,R,L)	97.
	48"H wall	AX1 EET48(T,R,L)	129.
	64"H wall	AX1 EET64(T,R,L)	161.
	Crown end cap	APT ()	5.
 Gap filler	40"/64"	AX1 EGF24	20.
	48"/64"	AX1 EGF16	10.
	53"/64"	AX1 EGF11	8.
	60"/64"	AX1 EGF4	6.

Order Code

Example:	AX1EET64T 612
AX1	Accessory
EET	Equity end trim
64	Panel height
T	"T" both sides
612	Trim finish

Specification Information

Specify paint finish for Equity end and panel starters, trim kits and crown end cap.

Note:

For more specific application information, please refer to the 1999 Equity Planning Guide. Additional finishes are available for crown end cap.

Application Notes

Equity panel starters attach perpendicular panels to Currents wall structural base covers. Equity panel starter includes clamp bracket and adapter. Both end and panel starters include top clip for added stiffness. No connector post is required for either starter.

Equity end starter supports perpendicular panel run on the centerline of the end of the wall. Perpendicular panels should be at the same height or higher than the service wall.

The Equity end trim kit encloses and flushes out the end of the Currents service wall with attached, end started Equity panels.

Specify trim kit suffix "T" for panels on both sides, "L" or "R" for attached panels only on left or right side of end of the Currents wall (as seen from outside of "T" end). Also specify crown end cap for all end conditions.

Gap fillers fill the gap when attaching a lower height Equity panel at the end of a 64"H Currents service wall.

Panel system starters and T-ends

Reff panel starters and T-ends

Currents

description	type	pattern no.	price	0" or 1 1/8" extension	3 1/2" extension
 Reff panel starter	34"H (includes AA1RTC bracket)	AA1RPS34 () () ()	\$107.		
	42"H (includes AA1RTC bracket)	AA1RPS42 () () ()	186.		
	49"H (includes AA1RTC bracket)	AA1RPS49 () () ()	192.		
	64"H (includes AA1RTC bracket)	AA1RPS64 () () ()	203.		
	79"H (includes AA1RTC bracket)	AA1RPS79 () () ()	212.		

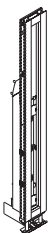
T-end frame for Reff panels					
	42" Reff panel to 39" Currents	AX1 R34239 () ()		799.	881.
	49" Reff panel to 39" Currents	AX1 R34939 () ()		809.	890.
	49" Reff panel to 48" Currents	AX1 R34948 () ()		757.	836.
	64" Reff panel to 39" Currents	AX1 R36439 () ()		894.	974.
	64" Reff panel to 48" Currents	AX1 R36448 () ()		842.	922.
	64" Reff panel to 64" Currents	AX1 R36464 () ()		842.	922.
	79" Reff panel to 39" Currents	AX1 R37939 () ()		900.	982.
	79" Reff panel to 48" Currents	AX1 R37948 () ()		848.	928.
	79" Reff panel to 64" Currents	AX1 R37964 () ()		821.	900.

Top clip (replacement part)	AA1RTC ()	80.
-----------------------------	-------------------	-----

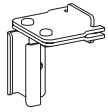



Order Code	Specification Information	Application Notes
Example: AA1-RPS64 48 A 613	<i>For T-end specify extension at end of spine, then paint finish. Extension at end of spine:</i>	Panel starters attach perpendicular Reff panels to Currents service wall. Panel starter includes clamp bracket to structural base cover, top clip, vertical extrusion corresponding to Reff panel height and top trim for adjoining panel.
AA1 Accessory	0 0" extension	Specify two 0" T-ends for a single workstation on each side (no intermediate panels).
R Reff	1 1 1/8" extension	
PS Panel starter	3 3 1/2" extensions	
64 Panel height	<i>Specify following for panel starter:</i>	Specify two 1 1/8" T-ends for one intermediate panel, one 1 1/8" and one 3 1/2" for two panels, and two 3 1/2" for three intermediate panels.
48 Adjoining panel width	1 Adjoining panel width	T-end encloses the end of a Currents service wall and connects to perpendicular Reff panels on one or both sides.
A Panel top trim profile	2 Top trim profile of adjoining panel	
613 Finish, panel starter	3 Painted finish for panel starter	Specify Reff straight connector separately to attach panel.
613 Panel top trim finish	4 Top trim finish	Specify Reff end connector to finish side edge without a connected wall.
	In addition to Currents finishes, all standard Reff system painted finishes are available.	Specify T-end with 0", 1 1/8", or 3 1/2" of extension to accommodate the "creep" of panels between workstations on each side of service wall.
	When ordering T-ends for the spine, specify crown end caps separately.	Only Reff finishes are available for AA1RTC() top clip.

Panel system starters and T-ends

Reff T-end fabric and wood cover sets

Currents

Service walls and components

description	type	height	pattern no.	list price
Monolithic cover set 	Fabric	42"	R3B0P0F4207	\$120.
		49"	R3B0P0F4907	136.
		64"	R3B0P0F6407	161.
		79"	R3B0P0F7907	184.
	Wood	42"	R3B0P0H4207	124.
		49"	R3B0P0H4907	139.
		64"	R3B0P0H6407	164.
		79"	R3B0P0H7907	188.
Tiled cover set 	Fabric	42"	R3B0T0F4207	120.
		49"	R3B0T0F4907	136.
		64"	R3B0T0F6407	161.
		79"	R3B0T0F7907	184.
	Wood	42"	R3B0T0H4207	124.
		49"	R3B0T0H4907	139.
		64"	R3B0T0H6407	164.
		79"	R3B0T0H7907	188.

Order Code

Example:	R3B0P0F4207
R3B	Reff
0P0F	Monolithic
42	Panel height
07	Width

Specification Information

See Reff System for full selection of painted finishes, fabrics and wood veneers for T-end cover sets.

Specify:

1. Top trim profile
2. Panel finishes
3. Top trim finish
4. Base finish

Top trim profile:

- A Flat
- B Square
- C Bullnose

Base height:

- 4 4" base height

6" base height is currently not available.

Application Notes

Specify covers in monolithic or tiled sets to complete T-end frames for Reff.

Monolithic cover sets include a raceway cover and a single snap-in panel above.

Tiled sets include raceway cover and segmented tiles corresponding to adjacent Reff tiled panels.



Reff tiled module horizontal reveals are at nominal 19", 34", 49" and 64" above the floor and do not align with service wall cover reveals.

When ordering T-ends for the spine, specify crown end caps separately.

Panel system starters and T-ends

Universal panel starters and T-ends

Currents

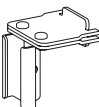
description	w	d	h	pattern no.	paint
 Universal T-end adapter	2-6"	7"	39"	AA1UA39()	\$66.
	2-6"	7"	48"	AA1UA48()	80.
	2-6"	7"	64"	AA1UA64()	89.
 Universal panel starters	3"	1"	39"	AA1UPS39()	148.
	3"	1"	48"	AA1UPS48()	161.
	3"	1"	64"	AA1UPS64()	170.
 Universal top clip				AA2 UTC ()	64.

Order Code

Example:	AA1 UPS48 612
AA1	Accessory
UPS	Panel starter
48	Panel height
612	Finish

Specification Information

Specify paint finishes for Universal end and panel starter.

Application Notes

Universal adapters and starters integrate other panel systems with the service wall. Vertical surface accepts architectural wall starter of most other systems.

T-end adapters include connector to corresponding height T-end for Currents screen (specified separately).

Panel starter includes clamp bracket to structural base cover on service wall.





Top clip gives added stability to attached panels of the same height or higher than the service wall.

Panel system starters and T-ends

fence panel starters

Currents

Service walls and components

description	type	w	d	h	pattern no.	list price
Panel starter for Morrison panels/ Currents linkable screens 	30"H panel	4"	1"	26"	AA1FMPS30()	\$63.
	39"H panel/screen	4"	1"	35"	AA1FMPS39()	64.
	42"H panel	4"	1"	38"	AA1FMPS42()	64.
	48" H panel/screen	4"	1"	44"	AA1FMPS48()	70.
	56"H panel	4"	1"	52"	AA1FMPS56()	70.
	64" H panel/screen	4"	1"	60"	AA1FMPS64()	75.
Universal panel starter 		3"	1"	35"	AA1FUPS39()	99.
Universal top clip 					AA2 UTC ()	64.
Morrison and linkable screen panel starters 	panel/screen top clip				AA2 MTC ()	49.

Order Code

Example: AA1 FMPS48 613	
AA1	Accessory
F	Fence
MPS	Morrison panel starter
48	Panel height
613	Finish

Specification Information

Specify paint finish for panel starters and top clip.

Application Notes

Panel starters attach perpendicular panels to the Fence bottom rail.

Panel starters include clamp bracket and full height connector track with modified top wedge block. For Morrison also specify high/low corner topcap in width of first panel.

Top clip connects panel connector track with the Fence crown. Specify top clip for added stiffness of panels higher than 48" or whenever cantilevering components from panel.



Top clip is not compatible with end trim.

Universal panel starters integrate other panel systems with the Currents Fence. Vertical surface accepts architectural wall starters of most other systems.

Panel system starters and T-ends

end trim for fence panel starters

Currents

description	type	w	d	h	pattern no.	list price
 End trim for Morrison panels	30"H panel	1"	2 1/4"	30"	AA1FMET30()	\$86.
	39"H panel	1"	2 1/4"	39"	AA1FMET39()	86.
	42"H panel	1"	2 1/4"	42"	AA1FMET42()	89.
	48" H panel	1"	2 1/4"	48"	AA1FMET48()	92.
	56" H panel	1"	2 1/4"	56"	AA1FMET56()	94.
	64" H panel	1"	2 1/4"	64"	AA1FMET64()	100.
 End trim for linkable screens	39" H screen	1"	2"	35"	AA1FCET39	71.
	48" H screen	1"	2"	44"	AA1FCET48	80.
	64" H screen	1"	2"	60"	AA1FCET64	89.

Order Code

Example: **AA1 FMET39 612**

AA1	Accessory
F	Fence
MET	Morrison end trim
39	Panel height
612	Finish

Specification Notes

Specify paint finish for end trim for Morrison panels.

Morrison end trim includes end raceway cover in matching color.

Linkable screen end trim is trim grey integral color.

Application Notes

Optional end trim is available for the panel starter connector track. End trim covers the connector track above and below the panel starter clamp bracket.

Panel system starters for Dividends

Dividends Horizon panel starters

Currents

Service walls and components

description	application	h	w	d	pattern no.	list
Panel starters for Dividends panels	Any height panel	16"	3"	1/2"	AA1DPS ()	\$215.
Top clip for Dividends to lower spine					AA1DTC ()	90.

Order Code	Specification Information	Application Notes
Example: AA1 DPS 613	Specify paint finish for panel starter and top clip.	Panel starter includes a clamp bracket that attaches to the structural base cover of the spine to start a Dividends panel run perpendicular to the face of the spine anywhere other than at the end of the spine. For panel starters, specify trim separately (see next page). Top clip, which secures top edge of panel to underside of spine crown, is required in addition to panel starter for stability of 57" or higher panels or 50"H panels with cantilevered shelves overhead storage.
AA1 Accessory		
D For Dividends		
PS Panel starter		
613 Painted finish		
		Spine end connectors, end starters, panel starters and panel starter end trim for Dividends Horizon panels cannot be used to attach Dividends Horizon screens (open weave, glass or other screens) directly to an AutoStrada or Currents spine. In applications where Dividends Horizon open weave, glass or other screens are specified perpendicular to an AutoStrada or Currents spine, you must first connect a Dividends Horizon panel to the spine via a spine end connector and end starter or panel starter, and then connect the Dividends Horizon panel to the Dividends Horizon open weave, glass or other screen.

Panel system starters for Dividends

End trim kits for Dividends Horizon panel starters

Currents

description	application	h	w	d	pattern no.	list
End trim kit for Dividends panel above 21" to top of panel	36"h panel	15"	1/2"	3"	AX1DET36 () ()	\$57.
	42"h panel	21"	1/2"	3"	AX1DET42 () ()	57.
	50"h panel	29"	1/2"	3"	AX1DET50 () ()	59.
	57"h panel	36"	1/2"	3"	AX1DET57 () ()	59.
	64"h panel	43"	1/2"	3"	AX1DET64 () ()	60.
End trim kit for Dividends panel between 21" and top of panel with top clip at 39"H	50"h panel	29"	1/2"	3"	AX1DET5039 () ()	69.
	57"h panel	36"	1/2"	3"	AX1DET5739 () ()	69.
	64"h panel	43"	1/2"	3"	AX1DET6439 () ()	70.
End trim kit for Dividends panel between 21" and top of panel with top clip at 48"H	50"h panel	29"	1/2"	3"	AX1DET5048 () ()	69.
	57"h panel	36"	1/2"	3"	AX1DET5748 () ()	69.
	64"h panel	43"	1/2"	3"	AX1DET6448 () ()	70.
	78"h panel	57"	1/2"	3"	AX1DET7848 () ()	73.
End trim kit for Dividends panel between 21" and top of panel with top clip at 64"H	64"h panel	64"	1/2"	3"	AX1DET6464 () ()	70.
	78"h panel	78"	1/2"	3"	AX1DET7864 () ()	73.

Order Code	Specification Information	Application Notes
Example: AX1 DET 36	For end trim kits specify:	End trim kits for Dividends Horizon panel starters fit the space above the panel starter clamp bracket (21" above floor) to top of panel.
AX1 Spine connector	1. End trim type	End trim kits for Dividends Horizon panel starters with top clip are segmented into two pieces. One piece fits the space between clamp bracket and top clip and the other fits between top clip and top of panel.
D Dividends	5= Metal Flat	
ET End trim kit	2. Paint finishes	Spine end connectors, end starters, panel starters and panel starter end trim for Dividends Horizon panels cannot be used to attach Dividends Horizon screens (open weave, glass or other screens) directly to an AutoStrada or Currents spine.
36 Panel height	All standard paint finishes	
5 End trim type		
613 Trim finish		In applications where Dividends Horizon open weave, glass or other screens are specified perpendicular to an AutoStrada or Currents spine, you must first connect a Dividends Horizon panel to the spine via a spine end connector and end starter or panel starter, and then connect the Dividends Horizon panel to the Dividends Horizon open weave, glass or other screen.

Power, data and communications components for service walls
 2+2 raceway
 outlet module, central switch and outlets

description	type	w	d	h	pattern no.	black	orange (-O) or orange triangle (-T)	no finish
Desk height outlet module	21-48"H	5"	-	6"	AR1 EOM			\$142.

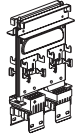

Central switch	21-48"H				AR1-ELS-B			397.
Duplex outlet	Circuit A				AR1 DA	34.		
	Circuit B				AR1 DB	34.		
	Circuit X				AR1 DX	34.	39.	
	Circuit Y				AR1 DY	34.	39.	

Order Code	Specification Information	Application Notes
Example: AR1 EOM		
AR1 Raceway	Raceway components distribute four 20-amp circuits at desk height or service wall base: two convenience circuits and two protected circuits, with separate grounds and heavy duty #10 neutrals.	Service wall power may be distributed point-to-point between outlet modules at desk height or in the base raceway.
E 2+2		
OM Outlet module		
	Outlet housings and power rails accept two duplex outlets on each face and four connector/jumper cables.	Central switch includes white rocker switch, connector to adjacent outlet module, and three simplex outlets on circuit B (2+2 or 3+3).
	Modular desk-height outlet module mounts between frame studs at any height from 21" - 48", above or below adjacent worksurfaces. Each 12"W frame bay can accept two outlet housings (up to four duplex outlets on each side.)	Outlet modules and power rails accept two duplex outlets on each face. Specify outlets with black face for convenience circuits. Specify orange face or black with orange triangle for protected circuits with separate ground and neutral in building power supply.
	Central switch controls three outlets inside wall frame for task or ambient lights. Switch occupies right-hand outlet opening in outlets cover on one side of wall.	
	Switches cannot be positioned back-to-back in combination with an outlet module.	

Power, data and communications components for service walls
 2+2 raceway
 other hardware

Currents

description	type	w	d	h	pattern no.	no finish
Power infeeds, modular	Base power	49"			AR1 EPI2	\$136.
	Desk height power	85"			AR1 EPI5	164.
	Ceiling infeed	145"			AR1 EPIC	205.
Hardwire base infeeds (NYC)	One connector				AR1 EPH1	273.
	Two connectors				AR1 EPH2	409.
Transitional connectors for Morrison or Reff	12"	61"			AR1 ET1	150.
	36"	85"			AR1 ET3	190.
	60"	109"			AR1 ET5	218.
	96"	133"			AR1 ET8	244.
Jumper cable	12" wall/36" desk	37"			AR1 EJ1	82.
	24" wall/48" desk	49"			AR1 EJ2	108.
	36" wall/60" desk	61"			AR1 EJ3	123.
	48" wall/84" desk	73"			AR1 EJ4	135.
	60" wall/84" desk	85"			AR1 EJ5	150.
	72" wall/96" desk	97"			AR1 EJ6	164.
	96" wall/120" desk	121"			AR1 EJ8	190.
	120" wall/144" desk	145"			AR1 EJ10	217.
144" wall	169"			AR1 EJ12	244.	

Order Code

Example:	AR1 ET1
AR1	Raceway
E	2+2
T	Transitional
1	Length

Specification Information

Raceway components distribute four 20-amp circuits at desk height or panel base: two convenience circuits and two protected circuits, with separate grounds and heavy duty #10 neutrals.

NOTE: The City of New York does not approve use of liquid-tight PVC conduit. For installations anywhere in the City of New York, specify NYC infeed kits (AR1 EPH1 or 2, AR1 TPH1 or 2), which do not contain PVC. To connect power from the Currents service wall to wall-started panels: specify standard (not transitional) jumper cables. Also specify Raceway Cable Managers (AR1 RCM) to support power jumpers within the Currents wall base between the base or desk-height power module and the attached panel.

Application Notes

Desk height power infeed connects from floor box to desk height outlets module inside service wall.

Ceiling infeed connects from ceiling junction box to desk height outlet module or to base power rail. Specify Currents ceiling infeed panel separately.

Base power infeed connects building power to either end of base raceway power rail.

Hardwire base infeed is approved for City of New York installations. Infeed includes junction box for base raceway and connector to desk height outlet module, or two connectors to adjacent base raceway power rails.

Transitional connectors connect Currents service wall power components to powered Morrison or Reff panels or Morrison Network desks. Application dimension indicates distance

from service wall desk-height outlet module to perpendicular panel with powered base.

Specify jumper cables between outlet modules. Application dimension indicates maximum wall cover width between outlets covers at the same height. Excess cable may be stored in interior of wall frame.

Base raceway power rail is suspended between panel supports 3" above floor. 48" wall accepts one 12" rail, 60" wall accepts one 24" rail, 72" accepts two 12" rails. 12" rails may also be inserted at any straight connection.

Specify 12" base power connector between 12" rails in a 72"W wall base, or straddling a wall connection. Specify 36" base power connector to pass through a connection between adjacent powered bases.

2+2 raceway
other hardware

description	type	w	d	h	pattern no.	no finish
Base raceway power rail	48" or 72" frame	12"	–	2"	AR1 E2	\$150.
	60" frame	24"	–	2"	AR1 E3	177.
Base power connector	Within a frame	12"			AR1 EPC1	68.
	Frame to frame	36"			AR1 EPC2	82.

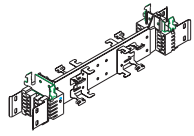

Order Code

Example:	AR1 ET1
AR1	Raceway
E	2+2
T	Transitional
1	Length

Specification Information

Raceway components distribute four 20-amp circuits at desk height or panel base: two convenience circuits and two protected circuits, with separate grounds and heavy duty #10 neutrals.

NOTE: The City of New York does not approve use of liquid-tight PVC conduit. For installations anywhere in the City of New York, specify NYC infeed kits (AR1 EPH1 or 2, AR1 TPH1 or 2), which do not contain PVC. To connect power from the Currents service wall to wall-started panels: specify standard (not transitional) jumper cables. Also specify Raceway Cable Managers (AR1 RCM) to support power jumpers within the Currents wall base between the base or desk-height power module and the attached panel.

Application Notes

Desk height power infeed connects from floor box to desk height outlets module inside service wall.

Ceiling infeed connects from ceiling junction box to desk height outlet module or to base power rail. Specify Currents ceiling infeed panel separately.

Base power infeed connects building power to either end of base raceway power rail.

Hardwire base infeed is approved for City of New York installations. Infeed includes junction box for base raceway and connector to desk height outlet module, or two connectors to adjacent base raceway power rails.

Transitional connectors connect Currents service wall power components to powered Morrison or Reff panels or Morrison Network desks. Application dimension indicates distance

from service wall desk-height outlet module to perpendicular panel with powered base.

Specify jumper cables between outlet modules. Application dimension indicates maximum wall cover width between outlets covers at the same height. Excess cable may be stored in interior of wall frame.

Base raceway power rail is suspended between panel supports 3" above floor. 48" wall accepts one 12" rail, 60" wall accepts one 24" rail, 72" accepts two 12" rails. 12" rails may also be inserted at any straight connection.

Specify 12" base power connector between 12" rails in a 72"W wall base, or straddling a wall connection. Specify 36" base power connector to pass through a connection between adjacent powered bases.

*3+3 raceway**outlet module, central switch and outlets*

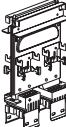
description	type	w	d	h	pattern no.	black	orange (-O) or orange triangle (-T)	no finish
Desk-height outlet module	21"-48"H	6"	1"	9"	AR1 TOM			\$164.
								
Central switch	21-48"H				AR1-ELS-B			397.
Duplex outlet	Circuit A				AR1 DA	34.		
	Circuit B				AR1 DB	34.		
	Circuit C				AR1 DC	34.		
	Circuit X				AR1 DX	34.	39.	
	Circuit Y				AR1 DY	34.	39.	
	Circuit Z				AR1 DZ	34.	39.	

Order Code	Specification Information	Application Notes
Example: AR1 TOM		
AR1 Raceway	Raceway components distribute six 20-amp circuits at desk height or wall base: three convenience circuits and three protected circuits, with separate grounds and heavy-duty #10 neutrals.	Service wall power may be distributed point-to-point between outlet modules at desk height or in the base raceway. Outlet modules and power rails accept two duplex outlets on each face and four connector/jumper cables. Modular desk-height outlet module mounts between frame studs at any height from 21" - 48", above or below adjacent worksurfaces. Each 12"W frame bay can accept two outlet housings (up to four duplex outlets on each side.) Central switch controls three outlets inside wall frame for task or ambient lights. Switch occupies right-hand outlet opening in outlets cover on one side of wall. Central switch includes white rocker switch, connector to adjacent outlet module, and three simplex outlets on circuit B (2+2 or 3+3).
T 3+3		
OM Outlet Module		
		Outlet modules and power rails accept two duplex outlets on each face. Specify outlets with black face for convenience circuits. Specify orange face or black with orange triangle for protected circuits with separate ground and neutral in building power supply.

Power, data and communications components for service walls
 3+3 raceway
 other hardware

description	type	w	d	h	pattern no.	no finish
Power infeeds	Base power	49"			AR1 TPI2	\$164.
	Desk height power	85"			AR1 TPI5	190.
	Ceiling infeed	145"			AR1 TPIC	232.
Hardwire base infeeds (NYC)	One connector				AR1 TPH1	300.
	Two connectors				AR1 TPH2	465.
Jumper cable	12" wall/36" desk	37"			AR1 TJ1	95.
	24" wall/48" desk	49"			AR1 TJ2	123.
	36" wall/60" desk	61"			AR1 TJ3	150.
	48" wall/72" desk	73"			AR1 TJ4	164.
	60" wall/84" desk	85"			AR1 TJ5	177.
	72" wall/96" desk	97"			AR1 TJ6	190.
	96" wall/120" desk	121"			AR1 TJ8	217.
	120" wall/144" desk	145"			AR1 TJ10	244.
Transitional connectors for Morrison or Reff	12" wall	169"			AR1 TJ12	272.
	12"	61"			AR1 TT1	177.
	36"	85"			AR1 TT3	218.
	60"	109"			AR1 TT5	244.
Base raceway power rail	48" or 72" frame	12"			AR1 T2	177.
	60" frame	24"			AR1 T3	205.
Base power connectors	Within a frame	13"			AR1 TPC1	82.
	Frame to frame	37"			AR1 TPC2	95.

Order Code	Specification Information	Application Notes
Example: AR1 TT5	Raceway components distribute six 20-amp circuits at desk height or wall base: three convenience circuits and three protected circuits, with separate grounds and heavy-duty #10 neutrals. NOTE: The City of New York does not approve use of liquid-tight PVC conduit. For installations anywhere in the City of New York, specify NYC infeed kits (AR1 EPH1 or 2, AR1 TPH1 or 2), which do not contain PVC. To connect power from the Currents service wall to wall-started panels: specify standard (not transitional) jumper cables. Also specify Raceway Cable Managers (AR1 RCM) to support power jumpers within the Currents wall base between the base or desk-height power module and the attached panel.	Desk height power infeed connects from floor box to desk height outlets module inside service wall.
AR1 Raceway		Ceiling infeed connects from ceiling junction box to desk height outlet module or to base power rail. Specify Currents ceiling infeed panel separately.
T 3+3		Base power infeed connects building power to either end of base raceway power rail.
T Transitional		Hardwire base infeed is approved for City of New York installations. Infeed includes junction box for base raceway and connector to desk height outlet module, or two connectors to adjacent base raceway power rails.
5 Length		Transitional connectors connect Currents service wall power components to powered Morrison or Reff panels or Morrison Network desks.
		Specify jumper cables between outlet modules. Application dimension indicates maximum wall cover width between outlets covers at the same height. Excess cable may be stored in interior of wall frame. Base raceway power rail is suspended between panel supports 3" above floor. 48" wall accepts one 12" rail, 60" wall accepts one 24" rail, 72" accepts two 12" rails. 12" rails may also be inserted at any straight connection. Specify 12" base power connector between 12" rails in a 72"W wall base, or straddling a wall connection. Specify 36" base power connector to pass through a connection between adjacent powered bases.
		Application dimension indicates distance from service wall outlet module to perpendicular panel.

Power, data and communications components for service walls
replacement components for Equity

Currents

description	type	w	d	h	pattern no.	no finish	black	orange (-O) or orange triangle (-T)
Replacement duplexes for Equity	Circuit A				ARE1 DA		\$34.	
	Circuit B				ARE1 DB		34.	
	Circuit C				ARE1 DC		34.	
	Circuit X				ARE1 DX		34.	
	Circuit X, orange face or orange triangle				ARE1 DX (O or T)			39.
	Circuit Y				ARE1 DY		34.	
	Circuit Y, orange face or orange triangle				ARE1 DY (O or T)			39.
	Circuit Z				ARE1 DZ		34.	
	Circuit Z, orange face or orange triangle				ARE1 DZ (O or T)			39.
Transitional power connector Equity 2+2	12"		61"		ARE1 ET1		150.	
	36"		85"		ARE1 ET3		190.	
	60"		109"		ARE1 ET5		218.	
Transitional power connector Equity 3+3	12"		61"		ARE1 TT1		177.	
	36"		85"		ARE1 TT3		218.	
	60"		109"		ARE1 TT5		244.	
Replacement power infeed, Equity panel	2+2				ARE1 EP1		225.	
	3+3				ARE1 TP1		259.	

Order Code

Specification Information

Application Notes

Example:	ARE1 ET3
ARE1	Currents/Equity raceway
E	Eight wire 2+2
T	Transitional connector
3	Width

Replacement duplexes for Equity convert existing 3+1 terminal blocks in Equity panels to 2+2 when connected to and supplied by Currents service wall 2+2 or 3+3 power.

Transitional power connector connects service wall power components to Equity panel base power.





Application dimension indicates distance between service wall outlet module (at 30"-39"H) and perpendicular panel.

Specify replacement power infeed when supplying power to Currents service wall from Equity panel base infeed.

Power, data and communications components for service walls accessories, ceiling infeed panel

Currents

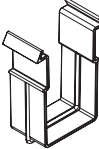
Service walls and components

description	w	d	h	pattern no.	no finish	paint
Cable clips for wall studs (100) 	1/4"	1/2"	1 1/2"	AR1 PCC 100	\$68.	
High capacity cable holders (10) 	1"	3/4"	2 1/2"	AR1 HCC H10	28.	
Raceway cable managers (10) 				AR1 RCM 10	54.	
Ceiling infeed panel for stabilizer end cabinet, T-end or power monument 	3 1/2"	5"	48"	APX CIP4 ()		398.
	3 1/2"	5"	72"	APX CIP6 ()		464.
	3 1/2"	5"	96"	APX CIP8 ()		531.

Order Code	Specification Information	Application Notes
Example: AR1 PCC 100	Cable clips and cable managers are black plastic.	Specify cable clips, approximately 50 per wall frame to support and manage cables on the face of studs in the Currents wall frame. Each clip manages up to 14 Category 5 or fiber optic cables; four clips attach between 21"-30", 30"-39", 39"-48"; six between 48"-64"H. Only two clips fit behind a cable tray cover at the 21"-30" height.
AR1 Raceway	Cable holders are light grey plastic.	
PCC Cable clip	<i>Specify painted finish for hardwire outlets cover or ceiling infeed panel.</i>	
100 Size/Quantity		Specify high capacity cable holders approximately 20 per wall frame to support and manage larger bundles of cables. Each holds up to 55 Cat 5 cables; two holders attach to studs at each 9" level; three holders at the 16" level of a 64"H wall. Only one holder fits behind a cable tray cover at the 21"-30" height (upside down).
		Raceway cable managers are U-shape cable supports that snap into the underside of the panel frame. Plan one per foot to contain data cables or power jumpers in the base raceway.
		Ceiling infeed panel attaches to end of spine adjacent to stabilizer end cabinet or Currents, Morrison, or Ref T-end panel with 3 1/2" extension, or to power monument. Center channel, 2" x 2 1/2", accommodates one or two power infeed cables. Each side channel is 1 1/2" x 3 1/2" lay-in cable raceway, for continuous lay-in cabling from ceiling to wall surface.
		Specify ceiling infeed separately.

Power, data and communications components for service walls
PDC modules, modular communications

Currents

description	type	application	pattern no.	black
PDC Module accessories	PDC Module extender (set of 10)		MR3 PDCX	\$124.
AMP PDC Modules	Faceplate and 4 Enhanced Category 5 outlets		AMC PDC 5E4N	183.
AMP Modular components	Blank insert (10)		AMC B10	20.
	Category 3 outlet (RJ11 six position)	Punch-down back	AMC O3	20.
	Category 6 quantum (RJ45, 110)	Punch-down back	AMC O6	44.
	Communications faceplates	AMP outlet faceplate, 2-port	AMC FP2 (L or N)	20.
	Communications faceplates	AMP outlet faceplate, 3-port	AMC FP3 (L or N)	20.
	Enhanced Category 5 outlet (RJ45, 110)	Punch-down back	AMC O5E	29.
	Fiber optics outlet 50/125 micron fiber jack		AMC OF500	147.
	Fiber optics outlet 62.5/125 micron fiber jack		AMC OF625	147.
AMP modular communications/ zone distribution	AMP NetConnect consolidation point, 12-port		AMC5 CP12	579.
	AMP NetConnect mounting bracket		AMB CP12-AMP	39.
	AMP pre-terminated outlet cable, 20'		AMC5 OC20(A or B)	74.
	AMP pre-terminated outlet cable, 30'		AMC5 OC30(A or B)	82.
	AMP pre-terminated outlet cable, 40'		AMC5 OC40(A or B)	88.
	AMP pre-terminated outlet cable, 50'		AMC5 OC50(A or B)	94.
Lucent zone distribution	Hinged mounting brackets for 24-port consolidation point (pair)		AMB CP24 LUC	106.
Outlet fillers (Set of 10)			AR OF	30.

Order Code	Specification Information	Application Notes
Example: MR3 AMP3B	<i>For AMP pre-terminated outlet cables specify:</i>	PDC Modules are preconfigured or created from modular components and faceplate that snaps into service wall outlets cover, raceway cover, desk service beam, credenza stanchion outlets cover, or power monument.
MR3 Raceway/PDC	T568A or T568B wiring.	
AMP Type	<i>For AMP outlet faceplates specify:</i>	See Morrison price list for additional PDC module configurations.
3B Configuration	L Light grey N Black	
	Amp outlets are black. Lucent faceplates are light grey.	Specify PDC Module extenders for adequate clearance between modules in back-to-back applications, or for fiber optics ST connectors.
		Specify blank filler plates for any unused outlet openings in outlets covers or raceway covers.
		AMP NetConnect mounting bracket supports one 12-port consolidation point on stud or two in stabilizer end cabinet.
		AMP pre-terminated outlet cables include outlet and plug into consolidation point. AMP outlet faceplate snaps into outlets cover and supports cable outlet.
		Each Lucent mounting bracket supports one 24-port consolidation point and is hinged for easy access. Bracket mounts on service wall frame or stabilizer end cabinet.

Linkable screens

glazed, translucent, and perforated

Currents

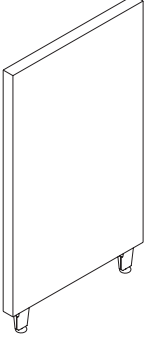
description	type	w	d	h	pattern no.	glazed G(C/S/T)	fiberglass TC	perforated H
	39"H	24"	2"	39"	AP1 3924 () ()	\$775.	\$1,139.	\$1,558.
		36"	2"	39"	AP1 3936 () ()	929.	1,429.	2,033.
		48"	2"	39"	AP1 3948 () ()	1,117.	1,814.	2,605.
		60"	2"	39"	AP1 3960 () ()	n/a	2,069.	3,043.
	48"H	18"	2"	48"	AP1 4818 () ()	774.	n/a	n/a
		24"	2"	48"	AP1 4824 () ()	853.	1,291.	1,800.
		30"	2"	48"	AP1 4830 () ()	947.	n/a	n/a
		36"	2"	48"	AP1 4836 () ()	1,023.	1,523.	2,281.
		42"	2"	48"	AP1 4842 () ()	1,140.	n/a	n/a
		48"	2"	48"	AP1 4848 () ()	1,229.	1,972.	2,962.
		60"	2"	48"	AP1 4860 () ()	n/a	2,325.	3,542.
	64"H	18"	2"	64"	AP1 6418 () ()	899.	n/a	n/a
		24"	2"	64"	AP1 6424 () ()	1,009.	1,600.	2,306.
		30"	2"	64"	AP1 6430 () ()	1,103.	n/a	n/a
		36"	2"	64"	AP1 6436 () ()	1,212.	1,996.	3,007.
		42"	2"	64"	AP1 6442 () ()	1,307.	n/a	n/a
		48"	2"	64"	AP1 6448 () ()	1,450.	2,574.	3,895.
		60"	2"	64"	AP1 6460 () ()	n/a	2,988.	n/a

Screens and add-up panels

Order Code	Specification Information	Application Notes
Example: AP1 3924 GT 612 813	<i>Surface types:</i>	Linkable screens divide workstations perpendicular to service wall where base raceway is not required. Linkable screens connect with standard Morrison/Currents wall starters and Currents linkable screen connectors.
AP1 Currents screen	G Glazed	
39 Height	TC Translucent fiberglass	Screens are supported by two legs with leveling glides and include Currents top cap. Specify connectors separately.
24 Width	H Perforated	
G Surface type	<i>For glazed panels specify:</i>	Glazed linkable screens use Morrison glazed panel construction. Fiberglass and perforated screen surfaces are bonded to D-frame panel construction.
T Surface finish	C Clear tempered glass	
612 Frame finish	S Smoked acrylic	
813 Trim color	T Translucent acrylic	
	Perforated surface is light grey.	
	<i>Specify painted finish for glazed panel frame.</i>	
	<i>Specify trim grey or easy grey integral color for top cap.</i>	
	Linkable screen legs are trim grey.	

Linkable screens upholstered

Currents

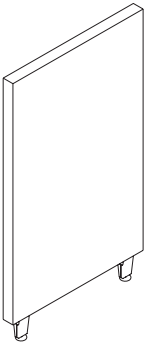
description	type	w	d	h	pattern no.	10	15	20	30	35	40	45	50	55
	39"H	18"	2 1/4"	39"	AP1 3918 N() ()	\$269.	\$298.	\$314.	\$360.	\$374.	\$396.	\$438.	\$459.	\$482.
		24"	2 1/4"	39"	AP1 3924 N() ()	305.	337.	356.	407.	422.	449.	494.	519.	545.
		30"	2 1/4"	39"	AP1 3930 N() ()	329.	366.	384.	440.	459.	487.	536.	564.	591.
		36"	2 1/4"	39"	AP1 3936 N() ()	368.	410.	431.	491.	512.	544.	599.	629.	659.
		42"	2 1/4"	39"	AP1 3942 N() ()	415.	462.	486.	554.	577.	615.	678.	710.	745.
		48"	2 1/4"	39"	AP1 3948 N() ()	452.	502.	527.	603.	628.	668.	736.	773.	810.
		60"	2 1/4"	39"	AP1 3960 N() ()	526.	583.	614.	699.	729.	777.	855.	n/a	n/a
	48"H	18"	2 1/4"	48"	AP1 4818 N() ()	316.	352.	367.	420.	438.	466.	514.	539.	567.
		24"	2 1/4"	48"	AP1 4824 N() ()	358.	396.	417.	477.	496.	528.	580.	608.	640.
		30"	2 1/4"	48"	AP1 4830 N() ()	388.	432.	453.	518.	540.	574.	631.	661.	695.
		36"	2 1/4"	48"	AP1 4836 N() ()	436.	484.	508.	579.	603.	643.	707.	743.	779.
		42"	2 1/4"	48"	AP1 4842 N() ()	489.	543.	571.	652.	681.	723.	796.	834.	877.
		48"	2 1/4"	48"	AP1 4848 N() ()	532.	591.	622.	709.	739.	785.	864.	908.	954.
		60"	2 1/4"	48"	AP1 4860 N() ()	620.	688.	723.	827.	860.	915.	1,008.	n/a	n/a
	64"H	18"	2 1/4"	64"	AP1 6418 A() ()	411.	457.	479.	546.	571.	605.	667.	699.	736.
		24"	2 1/4"	64"	AP1 6424 A() ()	452.	502.	527.	603.	628.	668.	736.	773.	810.
		30"	2 1/4"	64"	AP1 6430 A() ()	508.	565.	592.	679.	706.	749.	827.	865.	909.
		36"	2 1/4"	64"	AP1 6436 A() ()	548.	610.	642.	734.	764.	811.	893.	938.	986.
		42"	2 1/4"	64"	AP1 6442 A() ()	605.	673.	707.	808.	842.	895.	986.	1,036.	1,086.
		48"	2 1/4"	64"	AP1 6448 A() ()	649.	721.	754.	863.	901.	957.	1,054.	1,107.	1,161.
		60"	2 1/4"	64"	AP1 6460 A() ()	736.	815.	857.	980.	1,020.	1,084.	1,194.	n/a	n/a

Order Code

Example:	AP1 3924 N15 813
AP1	Currents screen
39	Height
24	Width
N	Surface type
15	Fabric group
813	Trim color

Specification Information

Surface types:

N	Upholstered
A	High performance acoustical upholstered

Specify fabric group:

10	Fabric group 10
15	Fabric group 15
20	Fabric group 20
30	Fabric group 30
35	Fabric group 35
40	Fabric group 40
45	Fabric group 45
50	Fabric group 50
55	Fabric group 55

Specify trim grey or easy grey integral color for top cap.

Linkable screen legs are trim grey.

Application Notes

Linkable screens divide workstations perpendicular to service wall where base raceway is not required. Linkable screens connect with standard Morrison/Currents wall starters and Currents linkable screen connectors.

Screens are supported by two legs with leveling glides and include Currents top cap. Specify connectors separately.

Upholstered 39" and 48" screens use Morrison Options panel construction. Upholstered 64" screens use high performance acoustical Morrison panel construction.

Linkable screens

marker surface both sides

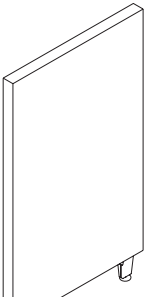
description	type	w	d	h	pattern no.	list price
Linkable screens 	48"H	24"	2 1/8"	48"	AP1 4824M()	\$613.
		30"	2 1/8"	48"	AP1 4830M()	659.
		36"	2 1/8"	48"	AP1 4836M()	728.
		42"	2 1/8"	48"	AP1 4842M()	816.
		48"	2 1/8"	48"	AP1 4848M()	914.
	64"H	24"	2 1/8"	64"	AP1 6424M()	694.
		30"	2 1/8"	64"	AP1 6430M()	787.
		36"	2 1/8"	64"	AP1 6436M()	894.
		42"	2 1/8"	64"	AP1 6442M()	994.
		48"	2 1/8"	64"	AP1 6448M()	1,110.

Screens and add-up panels

Order Code	Specification Information	Application Notes
Example: AP1 4824M 813	<i>Surface types:</i>	Linkable screens divide workstations perpendicular to service wall where base raceway is not required. Linkable screens connect with standard Morrison/Currents wall starters and Currents linkable screen connectors.
AP1 Currents screen	M Marker surface	
48 Height	Specify trim grey or easy grey integral color for top cap.	Screens are supported by two legs with leveling glides and include Currents top cap. Specify connectors separately.
24 Width	Linkable screen legs are trim grey.	
M Surface type		
813 Trim color		Marker surface linkable screens use Morrison veneer panel construction.

Linkable screens

marker/upholstered combination

Currents

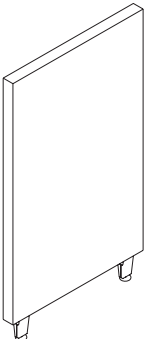
description	type	w	d	h	pattern no.	10	15	20	30	35	40	45	50	55
	48"H	24"	2 1/8"	48"	AP1 4824M() ()	\$545.	\$570.	\$580.	\$616.	\$627.	\$645.	\$676.	\$690.	\$713.
		30"	2 1/8"	48"	AP1 4830M() ()	592.	614.	625.	664.	675.	694.	732.	749.	775.
		36"	2 1/8"	48"	AP1 4836M() ()	651.	679.	687.	732.	744.	772.	809.	829.	858.
		42"	2 1/8"	48"	AP1 4842M() ()	736.	764.	774.	825.	836.	864.	908.	931.	964.
		48"	2 1/8"	48"	AP1 4848M() ()	813.	843.	855.	909.	932.	970.	1,005.	1,030.	1,065.
	64"H	24"	2 1/8"	64"	AP1 6424M() ()	639.	678.	686.	734.	752.	789.	828.	846.	877.
		30"	2 1/8"	64"	AP1 6430M() ()	718.	763.	771.	825.	843.	879.	917.	940.	972.
		36"	2 1/8"	64"	AP1 6436M() ()	799.	843.	858.	910.	935.	979.	1,015.	1,041.	1,076.
		42"	2 1/8"	64"	AP1 6442M() ()	876.	934.	947.	1,009.	1,030.	1,067.	1,113.	1,141.	1,180.
		48"	2 1/8"	64"	AP1 6448M() ()	1,000.	1,061.	1,075.	1,140.	1,165.	1,208.	1,263.	1,295.	1,337.

Order Code

Example:	AP1 4824M20 813
AP1	Currents screen
48	Height
24	Width
M	Surface type
20	Fabric group
813	Trim color

Specification Information

Specify fabric group:

10	Fabric group 10
15	Fabric group 15
20	Fabric group 20
30	Fabric group 30
35	Fabric group 35
40	Fabric group 40
45	Fabric group 45
50	Fabric group 50
55	Fabric group 55

Specify trim grey or easy grey integral color for top cap.

Linkable screen legs are trim grey.

Application Notes

Linkable screens divide workstations perpendicular to service wall where base raceway is not required. Linkable screens connect with standard Morrison/Currents wall starters and Currents linkable screen connectors.

Screens are supported by two legs with leveling glides and include Currents top cap. Specify connectors separately.

Combination upholstered screens use Morrison veneer/combination panel construction.

Linkable screens trim

Currents

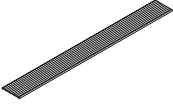
description	type	w	d	h	pattern no.	price
End trim, linkable screens (no connector) 	39" screen	–	2"	39"	AA139E()	\$38.
	48" screen	–	2"	48"	AA148E()	39.
	64" screen	–	2"	64"	AA164E()	40.
Raceway cover for Currents end connector or end trim on Morrison panel					AA1RE()	26.
Top trim, linkable screens (replacement part) 		6"	2"	–	AA1T06()	8.
		18"	2"	–	AA1T18()	11.
		24"	2"	–	AA1T24()	13.
		30"	2"	–	AA1T30()	19.
		36"	2"	–	AA1T36()	21.
		42"	2"	–	AA1T42()	22.
		48"	2"	–	AA1T48()	24.
	60"	2"	–	AA1T60()	27.	
Linkable screen feet, pair (replacement part)					AP1 LF	53.
Carpet grips (set of 10)					MM2-CG	18.
Non-skid pads (set of 10)					AA1NSK	31.

Screens and add-up panels

Order Code

Example: AA1 T06 813
AA1 T Top trim, panel
06 Width
813 Trim color

Specification Information

Specify painted finish for raceway cover for Currents end connector.

Specify trim grey or easy grey integral color for end trim and top trim.

Linkable screen legs are trim grey.

Application Notes

End trim is economical vertical trim cover for linkable screen where no end connector (or cantilever track) is required. End trim includes top cap.

Raceway cover encloses end of Morrison panel raceway under Currents end trim or end connector.



Top trim corresponds in width to linkable screens or Morrison panels. No Currents top trim is available for Morrison connectors (specify linkable screen connectors).

Top caps are included with Currents screen connectors.

Linkable screen feet may be ordered to convert Morrison panels with raceway to Currents linkable screens.

Linkable screens

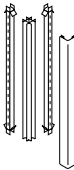
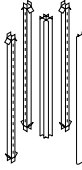
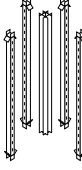
90° and end connectors

description	type	w	d	h	pattern no.	no finish	trim grey
Connector track 	No trim	–	–	39"	MC1-39S1	\$41.	
	No trim	–	–	48"	MC1-48S1	46.	
	No trim	–	–	64"	MC1-64S1	50.	
90° 2-way L 		2"	2"	39"	AC1 39L2()		137.
		2"	2"	48"	AC1 48L2()		145.
		2"	2"	64"	AC1 64L2()		156.
90° 3-way T 		2 1/4"	2"	39"	AC1 39T3()		174.
		2 1/4"	2"	48"	AC1 48T3()		184.
		2 1/4"	2"	64"	AC1 64T3()		198.
90° 4-way X 		2 1/4"	2 1/4"	39"	AC1 39X4()	205.	
		2 1/4"	2 1/4"	48"	AC1 48X4()	228.	
		2 1/4"	2 1/4"	64"	AC1 64X4()	254.	
End connector (with connector track) 		1"	2"	39"	AC1 39E1()		61.
		1"	2"	48"	AC1 48E1()		65.
		1"	2"	64"	AC1 64E1()		73.

Order Code	Specification Information	Application Notes
Example: AC1 39L2 813		
AC1 Linkable screen connector	Specify trim grey or easy grey integral color for top and vertical trim.	Connectors join linkable screens or Morrison panels in straight, 90° or 120° post configurations.
39 Height	Connector post is painted black extrusion.	Linkable screen connectors include connector tracks, universal posts and top and vertical trim (where required).
L2 90° 2-way L	Carpet grips are black integral color surface.	Connector tracks have cantilever slots for worksurface and storage support.
813 Trim color		L, T and X connectors include a universal post and 2, 3 or 4 connector tracks and top cap.
		End trim may be specified instead of an end connector if cantilever capability is not required.
		Carpet grips snap into linkable screen glides to prevent components from sliding. Glide rotates in carpet grip to permit levelling.
		Non-skid grips snap into glides to prevent sliding on hard surface floors.

Linkable screens

120° connectors

Currents

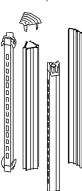
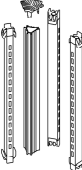
description	h	pattern no.	list price
 120°, 2-way	39"	AC1 39V2()	\$153.
	48"	AC1 48V2()	159.
	64"	AC1 64V2()	173.
 120°, 3-way	39"	AC1 39Y3()	187.
	48"	AC1 48Y3()	194.
	64"	AC1 64Y3()	208.

Screens and add-up panels

Order Code

Example: AC1 39V2 813
AC1 Linkable screen connector
39 Height
V2 120° 2-way
813 Trim color

Specification Information

Specify trim grey or easy grey integral color for top and vertical trim.

Connector post is painted black extrusion.

Carpet grips are black integral color surface.



Application Information

Connectors join linkable screens or Morrison panels in straight, 90° or 120° post configurations.

The connectors include connector tracks, a triangular post and top and vertical trim (where required).

Wall-connected screens *translucent surfaces*

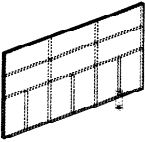
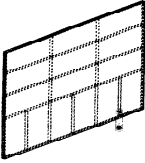
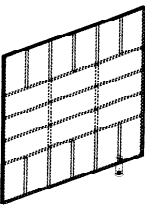
Currents

description	w	d	h	pattern no.	translucent
 39" H wall-connected screen	24"	2"	39"	AF 3924 TCP ()	\$958.
	36"	2"	39"	AF 3936 TCP ()	1,039.
	48"	2"	39"	AF 3948 TCP ()	1,118.
	60"	2"	39"	AF 3960 TCP ()	1,359.
	72"	2"	39"	AF 3972 TCP ()	1,597.
 48" H wall-connected screen	24"	2"	48"	AF 4824 TCP ()	1,118.
	36"	2"	48"	AF 4836 TCP ()	1,199.
	48"	2"	48"	AF 4848 TCP ()	1,278.
	60"	2"	48"	AF 4860 TCP ()	1,518.
	72"	2"	48"	AF 4872 TCP ()	1,758.
 64" H wall-connected screen	24"	2"	64"	AF 6424 TCP ()	1,278.
	36"	2"	64"	AF 6436 TCP ()	1,518.
	48"	2"	64"	AF 6448 TCP ()	1,758.
	60"	2"	64"	AF 6460 TCP ()	2,078.
 Screen starter	4"	1"	16"	AA1B()	134.
 Screen-to-worksurface bracket				AFWB	72.

Order Code	Specification Information	Application Notes
Example: AF 4872 TCP 612		
AF Screen	<i>Surface types:</i> T Translucent	Translucent screens have full surfaces of luminous fiberglass enclosing a lightweight, rigid frame. Continuous edge trim is trim grey.
48 Height	<i>Surface finishes:</i> C Crystal	Wall connected screens have one support post with levelling glide.
72 Width	<i>Specify base and screen starter paint finish.</i>	Wall connected screens attach to service wall or Currents T-end only, and cannot be linked.
T Surface type	<i>Base type:</i> P Wall-connected	Specify screen starter to connect screen perpendicular to service wall face. Clamp bracket attaches wall-connected screen anywhere along structural base. Outside surface of screen at end of wall will be approximately 1" from end.
C Surface finish		No screen starter is needed to attach service wall-connected screen to corresponding height Currents T-end at end of spine.
P Base type		Screen-to-worksurface bracket stabilizes wall-connected screen by attaching to underside of worksurface at any height.
612 Base finish		Specify left or right end of worksurface.

Mobile screens

translucent and upholstered surfaces

Currents

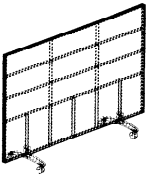
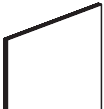
description	type	w	d	h	pattern no.	non-upholstered									
						10	15	20	30	35	40	45	50	55	
 Mobile screen, translucent	48"H	48"	2"	48"	AF 4848 TCM ()	\$1,439.									
		60"	2"	48"	AF 4860 TCM ()	1,678.									
		72"	2"	48"	AF 4872 TCM ()	1,919.									
	64"H	48"	2"	64"	AF 6448 TCM ()	1,919.									
		60"	2"	64"	AF 6460 TCM ()	2,239.									
 Mobile screen, upholstered	48"H	48"	2"	48"	AF 4848 AM ()()	1,381.	1,419.	1,457.	1,536.	1,574.	1,614.	1,650.	1,729.	1,807.	
		60"	2"	48"	AF 4860 AM ()()	1,509.	1,547.	1,587.	1,666.	1,704.	1,742.	1,780.	1,857.	1,936.	
	64"H	48"	2"	64"	AF 6448 AM ()()	1,499.	1,547.	1,600.	1,704.	1,754.	1,807.	1,857.	1,961.	2,065.	
		60"	2"	64"	AF 6460 AM ()()	1,754.	1,807.	1,857.	1,961.	2,013.	2,065.	2,115.	2,219.	2,323.	

Screens and add-up panels

Order Code	Specification Information	Application Notes
Example: AF 4872 TCM 612		
AF Screen	<i>Surface types:</i> T Translucent A Tackable upholstered	Translucent screens have full surfaces of luminous fiberglass enclosing a lightweight, rigid frame. Continuous edge trim is trim grey.
48 Height		
72 Width	<i>Surface finishes:</i> C Crystal	Upholstered screens are tackable, acoustical surface both sides. Continuous edge trim is trim grey.
T Surface type		
C Surface finish	<i>Specify base finish.</i>	The bottom 15" of upholstered mobile screens consists of supporting ballast board and is not tackable area.
M Base type	<i>Base type:</i> M Mobile	Mobile screens are supported by stabilizer feet.
612 Base finish	<i>Specify fabric group:</i> 10 Fabric group 10 15 Fabric group 15 20 Fabric group 20 30 Fabric group 30 35 Fabric group 35 40 Fabric group 40 45 Fabric group 45 50 Fabric group 50 55 Fabric group 55	Non-locking casters to meet BIFMA stability standards. When ordering 60" wide upholstered screens, please check width of fabric selected.

Add-up panels

*translucent or perforated surface
service wall crown applications*

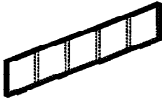
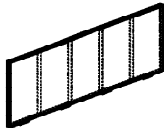
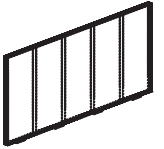
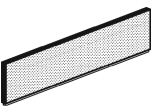
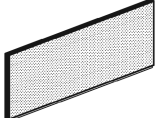
description	w	d	h	pattern no.	list price
 12"H add-up panels, translucent fiberglass	24"	2"	12"	AU 1224 TC	\$413.
	36"	2"	12"	AU 1236 TC	473.
	48"	2"	12"	AU 1248 TC	530.
	60"	2"	12"	AU 1260 TC	620.
	72"	2"	12"	AU 1272 TC	708.
 21"H add-up panels, translucent fiberglass	24"	2"	21"	AU 2124 TC	620.
	36"	2"	21"	AU 2136 TC	708.
	48"	2"	21"	AU 2148 TC	796.
	60"	2"	21"	AU 2160 TC	930.
	72"	2"	21"	AU 2172 TC	1,062.
 28"H add-up panels, translucent fiberglass	24"	2"	28"	AU 2824 TC	620.
	36"	2"	28"	AU 2836 TC	708.
	48"	2"	28"	AU 2848 TC	796.
	60"	2"	28"	AU 2860 TC	930.
	72"	2"	28"	AU 2872 TC	1,062.
 12"H add-up panels, perforated	24"	2"	12"	AU 1224 H	631.
	36"	2"	12"	AU 1236 H	722.
	48"	2"	12"	AU 1248 H	815.
	60"	2"	12"	AU 1260 H	948.
	72"	2"	12"	AU 1272 H	1,085.
 21"H add-up panels, perforated	24"	2"	21"	AU 2124 H	948.
	36"	2"	21"	AU 2136 H	1,085.
	48"	2"	21"	AU 2148 H	1,218.
	60"	2"	21"	AU 2160 H	1,422.
	72"	2"	21"	AU 2172 H	1,624.

Order Code	Specification Information	Application Notes																														
Example: AU 2848 TC																																
AU Add up panel	<i>Surface type:</i> TC Translucent fiberglass	Add-up panels add privacy and light control above any height Currents service wall. Bottom edge, with wedge-shape plugs, inserts in center of crown at any point, regardless of upmounted storage. Add-up panels include continuous edge trim.																														
28 Height	H Perforated																															
48 Width	Perforated panel finish is light grey. Edge trim for add-up panels is integral color trim grey.	Panels add privacy above Fence and any height Currents service wall. Bottom edge inserts in center of crown at any point.																														
T Surface type	Panes are molded translucent finish and are ordered in sets of 4.																															
C Finish																																
		<i>Overall height of service wall with 4" standard crown and Add-up panels:</i> <table border="1"> <thead> <tr> <th>Nominal wall height</th> <th>Add-up height</th> <th>Overall height</th> </tr> </thead> <tbody> <tr><td>39"</td><td>12"</td><td>55"</td></tr> <tr><td>39"</td><td>21"</td><td>64"</td></tr> <tr><td>39"</td><td>28"</td><td>71"</td></tr> <tr><td>48"</td><td>12"</td><td>64"</td></tr> <tr><td>48"</td><td>21"</td><td>73"</td></tr> <tr><td>48"</td><td>28"</td><td>80"</td></tr> <tr><td>64"</td><td>12"</td><td>80"</td></tr> <tr><td>64"</td><td>21"</td><td>89"</td></tr> <tr><td>64"</td><td>28"</td><td>96"</td></tr> </tbody> </table>	Nominal wall height	Add-up height	Overall height	39"	12"	55"	39"	21"	64"	39"	28"	71"	48"	12"	64"	48"	21"	73"	48"	28"	80"	64"	12"	80"	64"	21"	89"	64"	28"	96"
Nominal wall height	Add-up height	Overall height																														
39"	12"	55"																														
39"	21"	64"																														
39"	28"	71"																														
48"	12"	64"																														
48"	21"	73"																														
48"	28"	80"																														
64"	12"	80"																														
64"	21"	89"																														
64"	28"	96"																														

Add-up panels

*translucent or perforated surface
service wall crown applications*

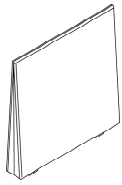

description	w	d	h	pattern no.	list price
panes (set of 4)	12"	1 3/4"	12"	AU 1212 T 4	\$307.



Order Code	Specification Information	Application Notes
Example: AU 2848 TC	<i>Surface type:</i>	Add-up panels add privacy and light control above any height Currents service wall. Bottom edge, with wedge-shape plugs, inserts in center of crown at any point, regardless of upmounted storage. Add-up panels include continuous edge trim.
AU Add up panel	TC Translucent fiberglass	
28 Height	H Perforated	Panels add privacy above Fence and any height Currents service wall.
48 Width	Perforated panel finish is light grey. Edge trim for add-up panels is integral color trim grey.	
T Surface type	Panes are molded translucent finish and are ordered in sets of 4.	Bottom edge inserts in center of crown at any point.
C Finish		

<i>Overall height of service wall with 4" standard crown and Add-up panels:</i>		
Nominal wall height	Add-up height	Overall height
39"	12"	55"
39"	21"	64"
39"	28"	71"
48"	12"	64"
48"	21"	73"
48"	28"	80"
64"	12"	80"
64"	21"	89"
64"	28"	96"

Add-up panels
 upholstered surface
 service wall crown applications

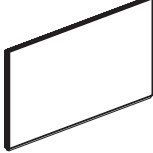
description	w	d	h	pattern no.	10	15	20	30	35	40	45	50	55
12"H add-up panels 	24"	2"	12"	AU 1224 A ()	\$362.	\$377.	\$390.	\$417.	\$432.	\$444.	\$458.	\$485.	\$511.
	36"	2"	12"	AU 1236 A ()	417.	432.	444.	472.	485.	497.	511.	538.	567.
	48"	2"	12"	AU 1248 A ()	472.	485.	497.	525.	538.	551.	567.	592.	619.
	60"	2"	12"	AU 1260 A ()	551.	567.	579.	607.	619.	633.	645.	673.	700.
21"H add-up panels 	24"	2"	21"	AU 2124 A ()	450.	472.	490.	531.	551.	573.	592.	633.	673.
	36"	2"	21"	AU 2136 A ()	519.	538.	558.	598.	619.	640.	661.	700.	740.
	48"	2"	21"	AU 2148 A ()	584.	607.	626.	666.	687.	706.	727.	767.	808.
	60"	2"	21"	AU 2160 A ()	687.	706.	727.	767.	788.	808.	827.	867.	909.
28"H add-up panels 	24"	2"	28"	AU 2824 A ()	538.	567.	592.	645.	673.	700.	727.	782.	833.
	36"	2"	28"	AU 2836 A ()	619.	645.	673.	727.	755.	782.	808.	860.	915.
	48"	2"	28"	AU 2848 A ()	700.	727.	755.	808.	833.	860.	888.	942.	996.
	60"	2"	28"	AU 2860 A ()	821.	848.	877.	928.	955.	984.	1,009.	1,064.	1,118.

Order Code

Example:	AU 2848 A20
AU	Add up panel
28	Height
48	Width
A	Surface type
20	Fabric group

Specification Information

Surface types:
 A Tackable upholstered
 Specify fabric group for upholstered add-up panels:
 10 Fabric group 10
 15 Fabric group 15
 20 Fabric group 20
 30 Fabric group 30
 35 Fabric group 35
 40 Fabric group 40
 45 Fabric group 45
 50 Fabric group 50
 55 Fabric group 55
 Edge trim is integral color trim grey finish.

Application Notes

Add-up panels add visual and acoustical privacy above any height Currents service wall. Bottom edge, with wedge-shape plugs, inserts in center of crown at any point, regardless of upmounted storage. Add-up panels include continuous edge trim.
 Upholstered add-up panels have been tested to NRC .60 and STC 21.
 When ordering 60" wide panels, please check width of fabric selected.

Overall height of service wall with 4" standard crown and Add-up panels:

Nominal wall height	Add-up height	Overall height
39"	12"	55"
39"	21"	64"
39"	28"	71"
48"	12"	64"
48"	21"	73"
48"	28"	80"
64"	12"	80"
64"	21"	89"
64"	28"	96"

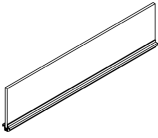
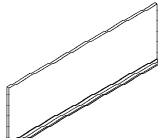
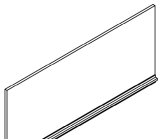
description	type	width	depth	height	pattern number	clear tempered	powder
Add up panels	 frameless glass, 8"h	24"	1/2"	8"	AUA1 0824 G () ()	\$227.	\$278.
		36"	1/2"	8"	AUA1 0836 G () ()	258.	371.
		48"	1/2"	8"	AUA1 0848 G () ()	335.	464.
		60"	1/2"	8"	AUA1 0860 G () ()	412.	597.
		72"	1/2"	8"	AUA1 0872 G () ()	464.	721.
	 frameless glass, 12"h	24"	1/2"	12"	AUA1 1224 G () ()	273.	300.
		36"	1/2"	12"	AUA1 1236 G () ()	382.	422.
		48"	1/2"	12"	AUA1 1248 G () ()	491.	542.
		60"	1/2"	12"	AUA1 1260 G () ()	600.	662.
		72"	1/2"	12"	AUA1 1272 G () ()	711.	782.
	 frameless glass, 15"h	24"	1/2"	15"	AUA1 1524 G () ()	278.	487.
		36"	1/2"	15"	AUA1 1536 G () ()	386.	541.
		48"	1/2"	15"	AUA1 1548 G () ()	494.	778.
		60"	1/2"	15"	AUA1 1560 G () ()	608.	876.
		72"	1/2"	15"	AUA1 1572 G () ()	716.	1,025.

Screens and add-up panels

Order Code	Specification Information	Application Notes
Example: AUA1 1248 G TEMP AA AUA1 Autostrada add up panel 12 Height 48 Width G Type TEMP Glass Finish AA Trim Finish	Add up type: G Glass Glass add-ups are available with the following glass options: TEMP Clear tempered GL13 Powder	Add-up panels add acoustical privacy and light control above any height spine wall. Anodized aluminum or painted base frame inserts in center of any spine crown and is secured by bolts within crown. Frameless glass add-ups can be positioned at any 3" increment in standard or compact crown with any cover type.
		Any height add up can be used on any height AutoStrada spine or Currents service wall or fence. <ul style="list-style-type: none"> • 8"h Add ups are designed primarily for use on 39"h spine with 1"h crown to create a 48"h horizon. • 12"h Add ups are designed for use on 48"h spine for a 61" horizon with 1"h crown or a 64" horizon with 4"h crown. • 15"h Add ups are designed primarily for use on 48"h spine with 1"h crown for a 64" horizon.

Add-up panel connectors and fillers

field retrofit kits

Currents

description	type	pattern no.	list price
Field Retrofit Trim Kit for non-stackable add-up panels	12 x 24	AUA1224	n/c
	12 x 36	AUA1236	n/c
	12 x 48	AUA1248	n/c
	12 x 60	AUA1260	n/c
	12 x 72	AUA1272	n/c
	21 x 24	AUA2124	n/c
	21 x 36	AUA2136	n/c
	21 x 48	AUA2148	n/c
	21 x 60	AUA2160	n/c
	21 x 72	AUA2172	n/c
	28 x 24	AUA2824	n/c
	28 x 36	AUA2836	n/c
	28 x 48	AUA2848	n/c
	28 x 60	AUA2860	n/c
	28 x 72	AUA2872	n/c

Order Code

Example: **AUA1224**

AU Add-up

A Type

12 Height

24 Width

Specification Information





Finish is trim grey.

Fillers require retrofitting add-up panels with new trim.

Retrofit trim kits are no-charge (n/c) items specified separately.

Add-up panel connectors and fillers service wall applications

Currents

description	w	d	h	pattern no.	list price
Straight alignment clip 	3"	2"	–	AU1 CS	\$11.
L connector add-up fillers 	6"	6"	16"	AU1 CL12	311.
	6"	6"	25"	AU1 CL21	372.
	6"	6"	32"	AU1 CL28	435.
T connector add-up fillers 	6"	6"	16"	AU1 CT12	311.
	6"	6"	25"	AU1 CT21	372.
	6"	6"	32"	AU1 CT28	435.
T-end 1 1/8" extension fillers 	2"	1 1/8"	16"	AU1 X112	186.
	2"	1 1/8"	25"	AU1 X121	216.
	2"	1 1/8"	32"	AU1 X128	248.
T-end 3 1/2" extension fillers 	2"	3 1/2"	16"	AU1 X312	248.
	2"	3 1/2"	25"	AU1 X321	279.
	2"	3 1/2"	32"	AU1 X328	311.

Screens and add-up panels

Order Code

Example:	AU1 CL12
AU1	Add-up
CL	Connector type
12	Application

Specification Information

Add-up fillers and alignment clip are painted trim grey finish.
Pattern numbers correspond to add-up panel height.

Application Notes

Straight connector clips over adjacent non-stackable add-up panels.

Add-up fillers join between add-up panels over a service wall connection or a T-end to extend enclosure from bottom of crown to top of add-up. Fillers require retrofitting add-up panels with new trim.

Retrofit kits are no-charge items that are specified separately.

Stackable add-up panels
glazed, translucent fiberglass, perforated, and marker surface
first up panels

Currents

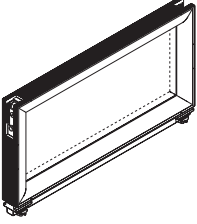
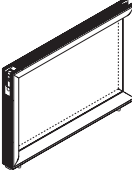
description	w	d	h	pattern no.	acrylic W (C,S)	acrylic W (T)	fiberglass (TC)	perforated (H)	marker (M)
First up panel on service wall crown 	24"	2"	12"	AY1 1224C()	\$521.	\$568.	\$607.	\$798.	\$544.
	36"	2"	12"	AY1 1236C()	605.	660.	717.	982.	632.
	48"	2"	12"	AY1 1248C()	691.	755.	846.	1,184.	750.
	60"	2"	12"	AY1 1260C()	738.	810.	967.	1,406.	n/a
	24"	2"	21"	AY1 2124C()	567.	616.	650.	887.	613.
	36"	2"	21"	AY1 2136C()	659.	723.	778.	1,102.	714.
	48"	2"	21"	AY1 2148C()	753.	829.	918.	1,346.	854.
	60"	2"	21"	AY1 2160C()	860.	946.	1,055.	1,603.	n/a
	24"	2"	28"	AY1 2824C()	785.	863.	772.	1,063.	655.
	36"	2"	28"	AY1 2836C()	931.	1,024.	918.	1,332.	770.
	48"	2"	28"	AY1 2848C()	1,076.	1,188.	1,102.	1,636.	917.
	60"	2"	28"	AY1 2860C()	1,168.	1,284.	1,271.	1,955.	n/a
	First up panel on linkable screen or Morrison panel 	18"	2"	16"	AY1 1618M()	491.	534.	n/a	n/a
24"		2"	16"	AY1 1624M()	534.	579.	810.	1,143.	571.
30"		2"	16"	AY1 1630M()	577.	630.	n/a	n/a	614.
36"		2"	16"	AY1 1636M()	623.	681.	982.	1,454.	665.
42"		2"	16"	AY1 1642M()	664.	726.	n/a	n/a	720.
48"		2"	16"	AY1 1648M()	708.	776.	1,176.	1,818.	790.
60"		2"	16"	AY1 1660M()	770.	838.	1,359.	2,150.	n/a
18"		2"	25"	AY1 2518M()	625.	683.	n/a	n/a	n/a
24"		2"	25"	AY1 2524M()	683.	747.	846.	1,212.	635.
30"		2"	25"	AY1 2530M()	743.	814.	n/a	n/a	690.
36"		2"	25"	AY1 2536M()	803.	884.	1,021.	1,549.	745.
42"		2"	25"	AY1 2542M()	862.	948.	n/a	n/a	816.
48"		2"	25"	AY1 2548M()	925.	1,017.	1,230.	1,941.	889.
60"		2"	25"	AY1 2560M()	984.	1,081.	1,428.	2,297.	n/a

Order Code

Example:	AY1 1636M WC 117
AY1	Stackable add-up
16	Height
36	Width
M	Mounting kit
W	Surface type
C	Acrylic finish
117	Frame finish

Specification Information

Top and edge trim are trim grey.

Specify surface type.

W	Glazed
TC	Translucent fiberglass
H	perforated (light metallic grey only)
M	Marker surface (both sides)

For glazed panels specify acrylic:

C	Clear tempered glass
S	Smoked acrylic
T	Translucent acrylic

For glazed panels also specify frame finish.

Application Notes

Stackable add-up panels provide adaptable privacy on service walls, linkable screens or Morrison panels. First up panels include top and edge trims and bayonet supports that bolt on to Currents service wall frame or top of screen or panel. All stackable add-up panels may be removed without tools.

Specify trim caps and connectors separately.

Stackable add-up panels
glazed, translucent fiberglass, perforated, and marker surface
next up panels

description	w	d	h	pattern no.	acrylic W (C,S)	acrylic W (T)	fiberglass (TC)	perforated (H)	marker (M)
Next up panel on stackable add-up panels	18"	2"	16"	AY1 1618S()	\$486.	\$528.	n/a	n/a	n/a
	24"	2"	16"	AY1 1624S()	528.	574.	802.	1,132.	565.
	30"	2"	16"	AY1 1630S()	572.	624.	n/a	n/a	608.
	36"	2"	16"	AY1 1636S()	617.	675.	972.	1,440.	658.
	42"	2"	16"	AY1 1642S()	657.	719.	n/a	n/a	713.
	48"	2"	16"	AY1 1648S()	701.	768.	1,165.	1,800.	783.
	60"	2"	16"	AY1 1660S()	762.	830.	1,346.	2,129.	n/a

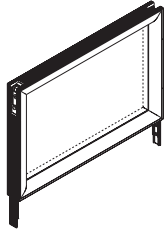

Screens and add-up panels

Order Code

Example:	AY1 1636S WC 117
AY1	Stackable add-up
16	Height
36	Width
S	Mounting kit
W	Surface type
C	Acrylic finish
117	Frame finish

Specification Information

Top and edge trim are trim grey.		<i>For glazed panels specify acrylic:</i>	
<i>Specify surface type.</i>		C	Clear tempered glass
W	Glazed	S	Smoked acrylic
TC	Translucent fiberglass	T	Translucent acrylic
H	perforated (light grey only)	<i>For glazed panels also specify frame finish.</i>	
M	Marker surface (both sides)		

Application Notes

Stackable add-up panels provide adaptable privacy on service walls, linkable screens or Morrison panels. Next up panels include intermediate masts that engage into sides of corresponding width first up or next-up panels. All stackable add-up panels may be removed without tools.

Specify trim caps and connectors separately.

Stackable add-up panels
upholstered
first up panels

description	w	d	h	pattern no.	10	15	20	30	35	40	45	50	55
 First up panel on service wall crown	24"	2 1/4"	12"	AY1 1224C A()	\$408.	\$440.	\$448.	\$493.	\$516.	\$548.	\$579.	\$602.	\$632.
	36"	2 1/4"	12"	AY1 1236C A()	474.	517.	527.	582.	610.	653.	693.	722.	759.
	48"	2 1/4"	12"	AY1 1248C A()	550.	605.	622.	688.	721.	773.	825.	858.	905.
	60"	2 1/4"	12"	AY1 1260C A()	619.	680.	695.	775.	811.	872.	932.	971.	1,025.
	24"	2 1/4"	21"	AY1 2124C A()	445.	485.	494.	544.	571.	606.	646.	669.	706.
	36"	2 1/4"	21"	AY1 2136C A()	523.	572.	583.	649.	680.	726.	775.	805.	850.
	48"	2 1/4"	21"	AY1 2148C A()	613.	673.	690.	771.	805.	864.	921.	962.	1,016.
	60"	2 1/4"	21"	AY1 2160C A()	687.	755.	776.	866.	911.	980.	1,046.	1,093.	1,154.

description	w	d	h	pattern no.	10	15	20	30	35	40	45	50	55
 First up panel on linkable screen or Morrison Panel	18"	2 1/4"	16"	AY1 1618M A()	398.	434.	441.	487.	506.	540.	572.	594.	624.
	24"	2 1/4"	16"	AY1 1624M A()	420.	457.	462.	512.	535.	571.	603.	627.	658.
	30"	2 1/4"	16"	AY1 1630M A()	457.	497.	508.	562.	586.	627.	664.	690.	726.
	36"	2 1/4"	16"	AY1 1636M A()	490.	536.	546.	605.	635.	681.	723.	751.	794.
	42"	2 1/4"	16"	AY1 1642M A()	539.	590.	603.	672.	704.	752.	804.	836.	885.
	48"	2 1/4"	16"	AY1 1648M A()	574.	630.	646.	717.	750.	806.	859.	894.	945.
	60"	2 1/4"	16"	AY1 1660M A()	643.	707.	725.	807.	849.	912.	973.	1,015.	1,072.
	18"	2 1/4"	25"	AY1 2518M A()	437.	475.	486.	536.	561.	598.	632.	657.	692.
	24"	2 1/4"	25"	AY1 2524M A()	461.	502.	514.	567.	592.	631.	670.	696.	735.
	30"	2 1/4"	25"	AY1 2530M A()	502.	548.	562.	622.	651.	695.	740.	772.	811.
	36"	2 1/4"	25"	AY1 2536M A()	541.	594.	605.	673.	706.	755.	806.	838.	887.
	42"	2 1/4"	25"	AY1 2542M A()	597.	655.	670.	748.	783.	844.	900.	938.	991.
	48"	2 1/4"	25"	AY1 2548M A()	636.	699.	719.	802.	838.	902.	962.	1,005.	1,063.
	60"	2 1/4"	25"	AY1 2560M A()	714.	787.	808.	905.	950.	1,022.	1,094.	1,139.	1,205.

Order Code

Example:	AY1 1660M A20
AY1	Stackable panel
16	Height
60	Width
M	Mounting kit
A	Surface type
20	Fabric group

Specification Information

Top and trim edge are trim grey.

Surface type:
A Tackable upholstered

Specify fabric group:

10	Fabric group 10
15	Fabric group 15
20	Fabric group 20
30	Fabric group 30
35	Fabric group 35
40	Fabric group 40
45	Fabric group 45
50	Fabric group 50
55	Fabric group 55

Application Notes

Stackable add-up panels provide adaptable privacy on service walls, linkable screens or Morrison panels. First up panels include top and edge trims and bayonet supports that bolt on to Currents service wall frame or top of screen or panel. All stackable add-up panels may be removed without tools.

Stackable add-up panels
upholstered
next up panels

description	w	d	h	pattern no.	10	15	20	30	35	40	45	50	55
Next up panel on stackable add-up panels	18"	2 1/4"	16"	AY1 1618S A()	\$394.	\$430.	\$437.	\$482.	\$502.	\$535.	\$567.	\$588.	\$618.
	24"	2 1/4"	16"	AY1 1624S A()	416.	452.	460.	507.	529.	565.	597.	621.	652.
	30"	2 1/4"	16"	AY1 1630S A()	452.	492.	503.	556.	580.	621.	657.	683.	719.
	36"	2 1/4"	16"	AY1 1636S A()	485.	530.	541.	599.	629.	675.	716.	744.	786.
	42"	2 1/4"	16"	AY1 1642S A()	534.	584.	597.	665.	697.	745.	796.	828.	877.
	48"	2 1/4"	16"	AY1 1648S A()	569.	624.	640.	710.	743.	798.	851.	886.	936.
	60"	2 1/4"	16"	AY1 1660S A()	637.	700.	718.	799.	840.	903.	964.	1,005.	1,062.



Order Code	Specification Information	Application Notes
Example: AY1 1660S A20	Top and trim edge are trim grey.	Stackable add-up panels provide adaptable privacy on service walls, linkable screens or Morrison panels. Next up panels include intermediate masts that engage into sides of corresponding width first up or next-up panels. All stackable add-up panels may be removed without tools.
AY1 Stackable panel	<i>Surface type:</i>	
16 Height	A Tackable upholstered	
60 Width	<i>Specify fabric group:</i>	
S Mounting kit	10 Fabric group 10	
A Surface type	15 Fabric group 15	
20 Fabric group	20 Fabric group 20	
	30 Fabric group 30	
	35 Fabric group 35	
	40 Fabric group 40	
	45 Fabric group 45	
	50 Fabric group 50	
	55 Fabric group 55	

Stackable add-up connectors and fillers
*stackable add-up panels or
Morrison panels perpendicular to service wall*

description	type	w	d	h	pattern no.	list price
Crown fillers for stackable add-up panels perpendicular to service wall 	First up	2"	2"	16"	AY1 PC16	\$199.
	First up	2"	2"	25"	AY1 PC25	211.
	First up	2"	2"	32"	AY1 PC32	222.
	Next up	2"	2"	16"	AY1 SPC16	186.

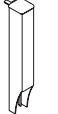
Crown fillers for Morrison perpendicular to service wall 		2 1/4"	2 1/4"	16"	AU1 PC12()	124.
		2 1/4"	2 1/4"	25"	AU1 PC21()	156.
		2 1/4"	2 1/4"	32"	AU1 PC28()	186.

Order Code

Example: AU1 PC12 613
AU1 Add-up panel
PC Crown filler
12 Height
613 Finish

Specification Information

Specify finish for vertical cover and top cap.

Application Notes

Crown fillers extend from stackable add-up panel or Morrison panel or add-on panel connector to surface of crown-mounted add-up panels.





Specify connector separately.

Crown filler includes top cap.

Stackable add-up connectors and fillers

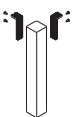
crown and linkable screen applications

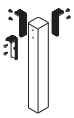
Currents

description	type	w	d	h	pattern no.	price
Trim caps 	End cap				AY1 CE	\$5.
	Straight cap	2"	2"	–	AY1 CS	5.
Corner first up stackable connectors over linkable screens 		2"	2"	16"	AY1 LL16	186.
		2"	2"	25"	AY1 LL25	211.
		2"	2"	32"	AY1 LL32	236.
Corner next up stackable connectors over linkable screens 		2"	2"	16"	AY1 SL16	222.
T first up stackable connectors over linkable screens 		2"	2"	16"	AY1 LT16	236.
		2"	2"	25"	AY1 LT25	261.
		2"	2"	32"	AY1 LT32	285.
T next up stackable connectors over linkable screens 		2"	2"	16"	AY1 ST16	273.





Screens and add-up panels

Order Code	Specification Information	Application Notes
Example: AY1 LL16	Connector caps and connector trims are integral color trim grey.	Trim caps are specified by application to fill top corners of stackable add-up panels. Straight cap aligns adjacent add-up panels. End cap finishes the end of a run of add-up panels.
AY1 Stackable add-up		
L Screen application		
L Configuration		
16 Height		
		Stackable connectors join stackable add-up panels over a linkable screen connector. Next up connectors correspond to next up panels.

Stackable add-up connectors and fillers

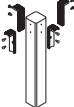
crown and linkable screen applications

Currents

description	type	w	d	h	pattern no.	price
 X first up stackable connectors over linkable screens		2"	2"	16"	AY1 LX16	\$273.
		2"	2"	25"	AY1 LX25	311.
		2"	2"	32"	AY1 LX32	336.
 X next up stackable connectors over linkable screens - X next up		2"	2"	16"	AY1 SX16	311.
 First up straight post		2"	2"	16"	AY1 LP16	211.
		2"	2"	25"	AY1 LP25	236.
		2"	2"	32"	AY1 LP32	261.
 Next up straight post		2"	2"	16"	AY1 SP16	248.

Order Code	Specification Information	Application Notes
Example: AY1 LL16	Connector caps and connector trims are integral color trim grey.	Trim caps are specified by application to fill top corners of stackable add-up panels. Straight cap aligns adjacent add-up panels. End cap finishes the end of a run of add-up panels.
AY1 Stackable add-up		
L Screen application		
L Configuration		
16 Height		
		Stackable connectors join stackable add-up panels over a linkable screen connector. Next up connectors correspond to next up panels.

Stackable add-up connectors and fillers

service wall, T-end and linkable screen applications

Currents

Screens and add-up panels

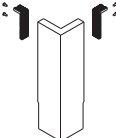
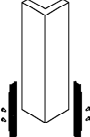
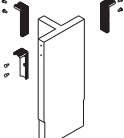
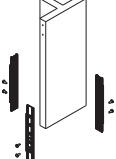
description	type	w	d	h	pattern no.	list price
 Stackable accessories	Crown-mount masts (replacement)				AY1 CMK	\$50.
	High-low adapter kit				AY1 HLA	62.
	Linkable screen masts (replacement)				AY1 MMK	50.
	Stacking hardware kit (replacement)				AY1 SMK	36.
 90° 2-way L first up corner fillers		6"	6"	16"	AY1 CL12	372.
		6"	6"	25"	AY1 CL21	435.
		6"	6"	32"	AY1 CL28	496.
 90° 2-way L next up corner fillers		6"	6"	16"	AY1 SCL16	410.
 90° 3-way T corner fillers		7"	6"	16"	AY1 CT12	435.
		7"	6"	25"	AY1 CT21	496.
		7"	6"	32"	AY1 CT28	559.
 90° 3-way T next up corner fillers		7"	6"	16"	AY1 SCT16	472.

Order Code

Example: AY1 CL28
AY1 Stackable add-up
CL Connector type
28 Height

Specification Information

Stackable add-up fillers and trim are trim grey finish.

Application Notes

Hi-low adapter kit includes an end cap and a bayonet with attachment holes to join stackable add-up panels in a straight high/low configuration. The adapter also adapts a corner, T, or X post for high/low corner configurations.

Corner fillers join stackable add-ups and fill the space above a Currents service wall L or T connection.

T-end extension fillers fill the 1 1/8" or 3 1/2" space above the extending area of a T-end connection at the end of a service wall with stackable add-up panels.





T-end stackable fillers fill the 7"-wide space above a T-end when attached linkable screens or Morrison panels have stackable add-ups.

All fillers engage into the top corners of corresponding height stackable add-up panels.

Stackable add-up connectors and fillers

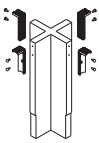
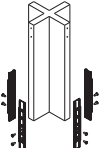
service wall, T-end and linkable screen applications

Currents

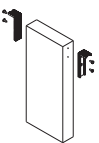
description	type	w	d	h	pattern no.	list price
 90° 4-way X corner fillers		7"	7"	16"	AY1 CX12	\$496.
		7"	7"	25"	AY1 CX21	559.
		7"	7"	32"	AY1 CX28	620.
 90° 4-way next up corner fillers		7"	7"	16"	AY1 SCX16	534.
 First up, T-end extension fillers	1" extension	1"	2"	16"	AY1 X112	173.
	1" extension	1"	2"	25"	AY1 X121	186.
	1" extension	1"	2"	32"	AY1 X128	199.
	3 1/2" extension	3 1/2"	2"	16"	AY1 X312	186.
	3 1/2" extension	3 1/2"	2"	25"	AY1 X321	199.
	3 1/2" extension	3 1/2"	2"	32"	AY1 X328	211.
 Next up 1" fillers		1"	2"	16"	AY1 SX116	186.
 Next up 3 1/2" fillers		3 1/2"	2"	16"	AY1 SX316	199.
 T-end stackable fillers	First up	7"	2"	16"	AY1 AXT16	261.
	First up	7"	2"	25"	AY1 AXT25	285.
	First up	7"	2"	32"	AY1 AXT32	311.
	Next up	7"	2"	16"	AY1 AXST16	261.

Order Code

Example: AY1 CL28	
AY1	Stackable add-up
CL	Connector type
28	Height

Specification Information

Stackable add-up fillers and trim are trim grey finish.

Application Notes

Hi-low adapter kit includes an end cap and a bayonet with attachment holes to join stackable add-up panels in a straight high/low configuration. The adapter also adapts a corner, T, or X post for high/low corner configurations.

Corner fillers join stackable add-ups and fill the space above a Currents service wall L or T connection.

T-end extension fillers fill the 1 1/8" or 3 1/2" space above the extending area of a T-end connection at the end of a service wall with stackable add-up panels.

T-end stackable fillers fill the 7"-wide space above a T-end when attached linkable screens or Morrison panels have stackable add-ups.

All fillers engage into the top corners of corresponding height stackable add-up panels.

Worksurfaces, universal
straight, curved and flat front
1 3/4" wire drop

Currents

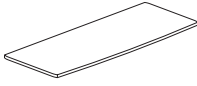
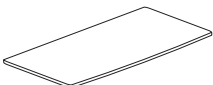
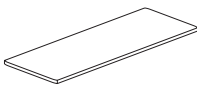
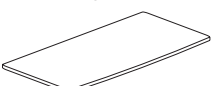
description	w	d	h	pattern no.	lam.	V2	V3
24"D straight worksurface, curved front 	24"	22 1/4"	1"	AW1 S2424 ()	\$250.	\$375.	\$502.
	30"	22 1/4"	1"	AW1 S3024 ()	276.	413.	552.
	36"	22 1/4"	1"	AW1 S3624 ()	300.	452.	602.
	42"	22 1/4"	1"	AW1 S4224 ()	327.	489.	652.
	48"	22 1/4"	1"	AW1 S4824 ()	351.	526.	701.
	60"	22 1/4"	1"	AW1 S6024 ()	401.	602.	803.
	66"	22 1/4"	1"	AW1 S6624 ()	426.	639.	852.
	72"	22 1/4"	1"	AW1 S7224 ()	452.	676.	902.
	84"	22 1/4"	1"	AW1 S8424 ()	502.	752.	1,002.
30"D straight worksurface, curved front 	36"	28 1/4"	1"	AW1 S3630 ()	339.	508.	676.
	48"	28 1/4"	1"	AW1 S4830 ()	387.	583.	778.
	60"	28 1/4"	1"	AW1 S6030 ()	452.	676.	902.
	72"	28 1/4"	1"	AW1 S7230 ()	526.	788.	1,053.
	84"	28 1/4"	1"	AW1 S8430 ()	604.	903.	1,205.
24"D Straight worksurface, flat front 	24"	22 1/4"	1"	AW1 F2424 ()	250.	375.	502.
	30"	22 1/4"	1"	AW1 F3024 ()	276.	413.	552.
	36"	22 1/4"	1"	AW1 F3624 ()	300.	452.	602.
	42"	22 1/4"	1"	AW1 F4224 ()	327.	489.	652.
	48"	22 1/4"	1"	AW1 F4824 ()	351.	526.	701.
	60"	22 1/4"	1"	AW1 F6024 ()	401.	602.	803.
	66"	22 1/4"	1"	AW1 F6624 ()	426.	639.	852.
	72"	22 1/4"	1"	AW1 F7224 ()	452.	676.	902.
	84"	22 1/4"	1"	AW1 F8424 ()	502.	752.	1,002.
30"D straight worksurface, flat front 	36"	28 1/4"	1"	AW1 F3630 ()	339.	508.	676.
	48"	28 1/4"	1"	AW1 F4830 ()	387.	583.	778.
	60"	28 1/4"	1"	AW1 F6030 ()	452.	676.	902.
	72"	28 1/4"	1"	AW1 F7230 ()	526.	788.	1,053.
	84"	28 1/4"	1"	AW1 F8430 ()	604.	903.	1,205.

Worksurfaces

Order Code	Specification Information	Application Notes
Example: AW1 S4830 117	Worksurface edges are trim grey.	Worksurfaces may be end-supported, cantilevered from Currents service wall, or supported by C-leg or pedestal at each end. Universal worksurfaces are interchangeable with Currents desks. Specify supports separately.
AW1 Worksurface	<i>Specify top finish</i>	24"D straight worksurfaces may be cantilevered with two cantilever brackets.
S Straight		24" and 30"D straight worksurfaces may be end supported with two Currents end support brackets.
48 Width		Universal straight worksurfaces 36" wide and greater include a steel stiffener that doubles as a horizontal cable manager.
30 Depth		
117 Top finish		

Worksurfaces, universal

Currents

corner

1 3/4" wire drop

description	w	d	h	pattern no.	lam.	V2	V3
24"D both sides corner worksurfaces 	42"	42"	1"	AW1 C4242 S ()	\$559.	\$837.	\$1,118.
	48"	48"	1"	AW1 C4848 S ()	620.	931.	1,241.
	60"	60"	1"	AW1 C6060 S ()	868.	n/a	n/a
30"D both sides corner worksurfaces	42"	42"	1"	AW1 C4242 D ()	559.	837.	1,118.
	48"	48"	1"	AW1 C4848 D ()	620.	931.	1,241.
	60"	60"	1"	AW1 C6060 D ()	868.	n/a	n/a
30"D left/24"D right corner worksurfaces	42"	42"	1"	AW1 C4242 L ()	559.	837.	1,118.
	48"	48"	1"	AW1 C4848 L ()	620.	931.	1,241.
	60"	60"	1"	AW1 C6060 L ()	868.	n/a	n/a
24"D left/30"D right corner worksurfaces	42"	42"	1"	AW1 C4242 R ()	559.	837.	1,118.
	48"	48"	1"	AW1 C4848 R ()	620.	931.	1,241.
	60"	60"	1"	AW1 C6060 R ()	868.	n/a	n/a

Order Code

Example: AW1 C4848S 117
AW1 Worksurface
C Corner
48 Width left
48 Width right
S Depth left and right
117 Top finish

Specification Information

Dimensions shown in "w" column are nominal width of left back edge. Dimensions shown in "d" column are nominal width of right back edge.

Worksurface depths:

S	24"D both sides
L	30"D left/24"D right
R	24"D left/30"D right
D	30"D both sides

Specify top finish.

Worksurface edges are trim grey. Clear maple laminate is not available on 60w x 60d corner tops.

Application Notes



Universal worksurfaces are interchangeable with Currents desks. Specify worksurface supports separately.

Corner worksurfaces may be supported by two cantilever brackets on one back edges in combination with C-leg or pedestal support on other end.

Universal corner worksurfaces include a steel stiffener on both back edges that doubles as a horizontal cable manager.

Worksurfaces, universal
extended corner
1 3/4" wire drop
extended left

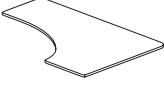
Currents



description	w	d	h	pattern no.	lam.	V2	V3
24"D both sides corner worksurfaces, extended left 	60"	36"	1"	AW1 C6036 S ()	\$620.	\$931.	\$1,241.
	60"	42"	1"	AW1 C6042 S ()	684.	1,023.	1,364.
	60"	48"	1"	AW1 C6048 S ()	746.	1,118.	1,488.
	72"	36"	1"	AW1 C7236 S ()	746.	1,118.	1,488.
	72"	42"	1"	AW1 C7242 S ()	806.	1,209.	1,613.
	72"	48"	1"	AW1 C7248 S ()	868.	1,304.	1,738.
	84"	36"	1"	AW1 C8436 S ()	868.	1,304.	1,738.
	84"	42"	1"	AW1 C8442 S ()	931.	1,396.	1,862.
30"D both sides corner worksurfaces, extended left 	60"	48"	1"	AW1 C6048 D ()	808.	1,209.	1,614.
	72"	48"	1"	AW1 C7248 D ()	931.	1,396.	1,862.
	84"	48"	1"	AW1 C8448 D ()	1,055.	1,584.	2,112.
30"D left/24"D right corner worksurfaces, extended left 	60"	42"	1"	AW1 C6042 L ()	746.	1,118.	1,488.
	60"	48"	1"	AW1 C6048 L ()	808.	1,209.	1,614.
	72"	42"	1"	AW1 C7242 L ()	868.	1,303.	1,738.
	72"	48"	1"	AW1 C7248 L ()	931.	1,396.	1,862.
	84"	42"	1"	AW1 C8442 L ()	993.	1,488.	1,986.
	84"	48"	1"	AW1 C8448 L ()	1,055.	1,584.	2,112.
24"D left/30"D right corner worksurfaces, extended left	60"	42"	1"	AW1 C6042 R ()	746.	1,118.	1,488.
	60"	48"	1"	AW1 C6048 R ()	808.	1,209.	1,614.
	72"	42"	1"	AW1 C7242 R ()	868.	1,303.	1,738.
	72"	48"	1"	AW1 C7248 R ()	931.	1,396.	1,862.
	84"	42"	1"	AW1 C8442 R ()	993.	1,488.	1,986.
	84"	48"	1"	AW1 C8448 R ()	1,055.	1,584.	2,112.

Worksurfaces

Order Code	Specification Information	Application Notes
Example: AW1 C6036S 117		
AW1 Worksurface	Dimensions shown in "w" column are nominal width of left back edge.	Worksurface edges are trim grey.
C Corner	Dimensions shown in "d" column are nominal width of right back edge.	
60 Width left		Universal worksurfaces are interchangeable with Currents desks. Specify worksurface supports separately.
36 Width right	<i>Worksurface depths:</i>	Corner worksurfaces may be supported by two cantilever brackets on one back edge in combination with C-leg or pedestal support on other end.
S Depth left and right	S 24"D both sides	Universal extended corner worksurfaces include a steel stiffener on both back edges that doubles as a horizontal cable manager.
117 Top finish	L 30"D left/24"D right	
	R 24"D left/30"D right	
	D 30"D both sides	
	Specify top finish.	

Worksurfaces, universal
extended corner
1 3/4" wire drop
extended right

Currents

description	w	d	h	pattern no.	lam.	V2	V3
24"D both sides corner worksurfaces, extended right 	36"	60"	1"	AW1 C3660 S ()	\$620.	\$931.	\$1,241.
	36"	72"	1"	AW1 C3672 S ()	746.	1,118.	1,488.
	36"	84"	1"	AW1 C3684 S ()	868.	1,304.	1,738.
	42"	60"	1"	AW1 C4260 S ()	684.	1,023.	1,364.
	42"	72"	1"	AW1 C4272 S ()	806.	1,209.	1,613.
	42"	84"	1"	AW1 C4284 S ()	931.	1,396.	1,862.
	48"	60"	1"	AW1 C4860 S ()	746.	1,118.	1,488.
	48"	72"	1"	AW1 C4872 S ()	868.	1,304.	1,738.
30"D both sides corner worksurfaces, extended right	48"	84"	1"	AW1 C4884 S ()	993.	1,488.	1,986.
	48"	60"	1"	AW1 C4860 D ()	808.	1,209.	1,614.
	48"	72"	1"	AW1 C4872 D ()	931.	1,396.	1,862.
30"D left/24"D right corner worksurfaces, extended right 	48"	84"	1"	AW1 C4884 D ()	1,055.	1,584.	2,112.
	42"	60"	1"	AW1 C4260 R ()	746.	1,118.	1,488.
	42"	72"	1"	AW1 C4272 R ()	868.	1,303.	1,738.
	42"	84"	1"	AW1 C4284 R ()	993.	1,488.	1,986.
	48"	60"	1"	AW1 C4860 R ()	808.	1,209.	1,614.
	48"	72"	1"	AW1 C4872 R ()	931.	1,396.	1,862.
30"D left/24"D right corner worksurfaces, extended right	48"	84"	1"	AW1 C4884 R ()	1,055.	1,584.	2,112.
	42"	60"	1"	AW1 C4260 L ()	746.	1,118.	1,488.
	42"	72"	1"	AW1 C4272 L ()	868.	1,303.	1,738.
	42"	84"	1"	AW1 C4284 L ()	993.	1,488.	1,986.
	48"	60"	1"	AW1 C4860 L ()	808.	1,209.	1,614.
	48"	72"	1"	AW1 C4872 L ()	931.	1,396.	1,862.
48"	84"	1"	AW1 C4884 L ()	1,055.	1,584.	2,112.	

Order Code

Example: AW1 C3660S 117
AW1 Worksurface
C Corner
36 Width left
60 Width right
S Depth left and right
117 Top finish

Specification Information

Dimensions shown in "w" column are nominal width of left back edge. Dimensions shown in "d" column are nominal width of right back edge.

Worksurface depths:

S	24"D both sides
L	30"D left/24"D right
R	24"D left/30"D right
D	30"D both sides

Specify top finish.

Worksurface edges are trim grey.

Application Notes

Universal worksurfaces are interchangeable with Currents desks. Specify worksurface supports separately.



Corner worksurfaces may be supported by two cantilever brackets on one back edge in combination with C-leg or pedestal support on other end.

Universal extended corner worksurfaces include a steel stiffener on both back edges that doubles as a horizontal cable manager.

Worksurfaces, universal

Currents

P-shape *1 3/4" wire drop*

description	w	d	h	pattern no.	lam.	V2	V3
P-shape surfaces, extended left 	75"	48"	1"	AW1 P7548 S ()	\$993.	\$1,488.	\$1,986.
	87"	48"	1"	AW1 P8748 S ()	1,118.	1,677.	2,233.
P-shape surfaces, extended right 	48"	75"	1"	AW1 P4875 S ()	993.	1,488.	1,986.
	48"	87"	1"	AW1 P4887 S ()	1,118.	1,677.	2,233.

Worksurfaces

Order Code

Example: AW1 P7548S 117
AW1 Worksurface
P P-shape
75 Width left
48 Width right
S Depth of return
117 Top finish

Specification Information

Dimensions shown in "w" column are nominal width of left back edge. Dimensions shown in "d" column are nominal width of right back edge.

Worksurface edges are trim grey.

Specify top finish.

Application Notes

P-shape worksurfaces may be cantilevered from service wall along 48" edge, and supported by 24"D C-leg at conference end. Specify two cantilever brackets and C-leg separately.

All P-shape worksurfaces correspond to a 24"D adjacent straight or corner worksurface.

Universal P-shape worksurfaces include a steel stiffener on both back edges that doubles as a horizontal cable manager.

Worksurfaces, universal
shared and arc-shape
1 3/4" wire drop

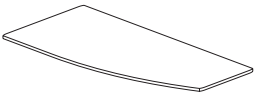
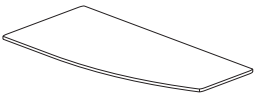
description	w	d	h	pattern no.	lam.	V2	V3
36"D shared worksurface 	36"	72"	1"	AW1 R7236 ()	\$819.	\$1,229.	\$1,639.
36"D left, 24"D right arc shape surface 	60"	34 1/4"	1"	AW1 A60L ()	685.	1,024.	1,365.
	72"	34 1/4"	1"	AW1 A72L ()	819.	1,229.	1,639.
36"D right, 24"D left arc shape surface 	60"	34 1/4"	1"	AW1 A60R ()	685.	1,024.	1,365.
	72"	34 1/4"	1"	AW1 A72R ()	819.	1,229.	1,639.

Order Code	Specification Information	Application Notes
Example: AW1 P7548S 117	Specify top finish.	Worksurface edges are trim grey.
AW1 Worksurface		36"D shared worksurface requires two straight legs and two end support brackets, or four straight legs.
P P-shape		Arc shape worksurfaces require 18"D floorstanding pedestal or 24"D C-leg at 24"D end and two end support brackets or straight legs at 36"D end.
75 Width left		
48 Width right		
S Depth of return		
117 Top finish		Universal shared and arc-shape worksurfaces include a steel stiffener that doubles as a horizontal cable manager.

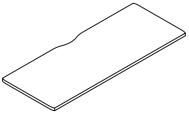
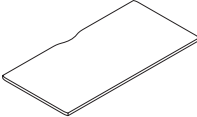

Currents worksurfaces for Morrison panels and linkable screens
straight, flat front
3/8" wire drop and grommet

description	w	d	h	pattern no.	lam.	V2	V3
24"D straight worksurface, flat front 	24"	23 3/8"	1"	AWM2 F2424 () ()	\$250.	\$375.	\$502.
	30"	23 3/8"	1"	AWM2 F3024 () ()	276.	413.	552.
	36"	23 3/8"	1"	AWM2 F3624 () ()	300.	452.	602.
	42"	23 3/8"	1"	AWM2 F4224 () ()	327.	489.	652.
	48"	23 3/8"	1"	AWM2 F4824 () ()	351.	526.	701.
	54"	23 3/8"	1"	AWM2 F5424 () ()	375.	565.	752.
	60"	23 3/8"	1"	AWM2 F6024 () ()	401.	602.	803.
	66"	23 3/8"	1"	AWM2 F6624 () ()	426.	639.	852.
	72"	23 3/8"	1"	AWM2 F7224 () ()	452.	676.	902.
	78"	23 3/8"	1"	AWM2 F7824 () ()	476.	716.	953.
	84"	23 3/8"	1"	AWM2 F8424 () ()	502.	752.	1,002.
90"	23 3/8"	1"	AWM2 F9024 () ()	525.	787.	1,052.	
96"	23 3/8"	1"	AWM2 F9624 () ()	552.	827.	1,103.	
30"D straight worksurface, flat front 	30"	29 3/8"	1"	AWM2 F3030 () ()	313.	470.	625.
	36"	29 3/8"	1"	AWM2 F3630 () ()	339.	508.	676.
	42"	29 3/8"	1"	AWM2 F4230 () ()	365.	545.	727.
	48"	29 3/8"	1"	AWM2 F4830 () ()	387.	583.	778.
	54"	29 3/8"	1"	AWM2 F5430 () ()	419.	630.	839.
	60"	29 3/8"	1"	AWM2 F6030 () ()	452.	676.	902.
	66"	29 3/8"	1"	AWM2 F6630 () ()	489.	732.	979.
	72"	29 3/8"	1"	AWM2 F7230 () ()	526.	788.	1,053.
	78"	29 3/8"	1"	AWM2 F7830 () ()	563.	845.	1,126.
	90"	29 3/8"	1"	AWM2 F9030 () ()	639.	958.	1,278.
	96"	29 3/8"	1"	AWM2 F9630 () ()	676.	1,015.	1,354.

Worksurfaces



Order Code	Specification Information	Application Notes
Example: AWM2 F4830 117 111 AWM2 Worksurface F Flat 48 Width 30 Depth 117 Top finish 111 Trim finish	Specify top finish first, followed by trim finish.	<p>Worksurfaces are sized for Morrison panel-based applications and may be supported by Morrison panel planning brackets or end-supported from Currents wall. 24"D straight tops may also be cantilevered from Currents service wall. Underside of worksurfaces is drilled to accept all Morrison panel-planning brackets, Morrison and Currents pedestals, and worksurface stiffeners. 24"D straight tops are also drilled to accept Currents wall cantilever brackets.</p> <p>Currents worksurfaces for Morrison require stiffener when the span between structural supports exceeds 36". Specify worksurface stiffeners and supports separately.</p> <p>Currents worksurfaces for Morrison cannot be used in conjunction with Morrison Network desk supports.</p>
		<p>Actual worksurface depth is 3/8" less than nominal 24" and 30" for cable clearance.</p> <p>All worksurfaces include one edge grommet, centered at rear of worksurface, with maximum clearance of 1 3/8".</p> <p>Currents for Morrison worksurfaces feature crisp 90° corners eliminating the corner kick detail typical of Currents universal and desk tops. Eliminating the corner kick will facilitate the use of brackets, pedestals and end panels at the side edge of worksurfaces and will eliminate undesired gaps at worksurface joints.</p> <p>24"D straight Currents worksurfaces for Morrison up to 84" wide may be cantilevered from the service wall with two cantilever brackets and applicable width worksurface stiffener.</p> <p>24"D straight Currents worksurfaces for Morrison wider than 84" require three cantilever brackets and applicable width worksurface stiffeners.</p>

Currents worksurfaces for Morrison panels and linkable screens
extended corner
3/8" wire drop and grommet
extended left

description	w	d	h	pattern no.	lam.	V2	V3
24"D both sides corner worksurfaces, extended left 	60"	36"	1"	AWM2 C6036 S () ()	\$620.	\$931.	\$1,241.
	60"	42"	1"	AWM2 C6042 S () ()	684.	1,023.	1,364.
	60"	48"	1"	AWM2 C6048 S () ()	746.	1,118.	1,488.
	72"	36"	1"	AWM2 C7236 S () ()	746.	1,118.	1,488.
	72"	42"	1"	AWM2 C7242 S () ()	806.	1,209.	1,613.
	72"	48"	1"	AWM2 C7248 S () ()	868.	1,304.	1,738.
	84"	48"	1"	AWM2 C8448 S () ()	993.	1,488.	1,986.
30"D both sides corner worksurfaces, extended left	60"	48"	1"	AWM2 C6048 D () ()	808.	1,209.	1,614.
	72"	48"	1"	AWM2 C7248 D () ()	931.	1,396.	1,862.
	84"	48"	1"	AWM2 C8448 D () ()	1,055.	1,584.	2,112.
30"D left/24"D right corner worksurfaces, extended left 	60"	42"	1"	AWM2 C6042 L () ()	746.	1,118.	1,488.
	60"	48"	1"	AWM2 C6048 L () ()	808.	1,209.	1,614.
	72"	42"	1"	AWM2 C7242 L () ()	868.	1,303.	1,738.
	72"	48"	1"	AWM2 C7248 L () ()	931.	1,396.	1,862.
	84"	48"	1"	AWM2 C8448 L () ()	1,055.	1,584.	2,112.
24"D left/30"D right corner worksurfaces, extended left	60"	42"	1"	AWM2 C6042 R () ()	746.	1,118.	1,488.
	60"	48"	1"	AWM2 C6048 R () ()	808.	1,209.	1,614.
	72"	42"	1"	AWM2 C7242 R () ()	868.	1,303.	1,738.
	72"	48"	1"	AWM2 C7248 R () ()	931.	1,396.	1,862.
	84"	48"	1"	AWM2 C8448 R () ()	1,055.	1,584.	2,112.

Order Code	Specification Information	Application Notes
Example: AWM2 C6036S 117 111 AWM2 Worksurface C Corner 60 Width left 36 Width right S Depth left and right 117 Top finish 111 Trim finish	Dimensions shown in "w" column are nominal width of left back edge. Dimensions shown in "d" column are nominal width of right back edge. <i>Worksurface depths:</i> S 24"D both sides L 30"D left/24"D right R 24"D left/30"D right D 30"D both sides Specify top finish first, followed by trim finish.	Currents for Morrison worksurfaces feature crisp 90° corners eliminating the corner kick detail typical of Currents universal and desk tops. Eliminating the corner kick will facilitate the use of brackets, pedestals and end panels at the side edge of worksurfaces and will eliminate undesired gaps at worksurface joints. Worksurfaces are sized for Morrison panel-based applications and may be supported by Morrison panel-planning brackets or end-supported and cantilevered from Currents wall. Extended side may also be supported with Currents C-legs. Underside of worksurface is drilled to accept all Morrison panel-planning brackets, Morrison and Currents pedestals, worksurface stiffeners and Currents C-leg on the extended side. Currents worksurfaces for Morrison require stiffener when the span between structural supports exceeds 36". Specify worksurface stiffeners and supports separately. Currents worksurfaces for Morrison cannot be used in conjunction with Morrison Network desk supports. Actual worksurface is 3/8" less than nominal 24" and 30" for cable clearance. All worksurfaces include two edge grommets, centered on back edges of worksurface, with maximum clearance of 1 3/8".

Currents worksurfaces for Morrison panels and linkable screens
extended corner
3/8" wire drop and grommet
extended right



description	w	d	h	pattern no.	lam.	V2	V3
24"D both sides corner worksurfaces extended right 	36"	60"	1"	AWM2 C3660 S () ()	\$620.	\$931.	\$1,241.
	36"	72"	1"	AWM2 C3672 S () ()	746.	1,118.	1,488.
	42"	60"	1"	AWM2 C4260 S () ()	684.	1,023.	1,364.
	42"	72"	1"	AWM2 C4272 S () ()	806.	1,209.	1,613.
	48"	60"	1"	AWM2 C4860 S () ()	746.	1,118.	1,488.
	48"	72"	1"	AWM2 C4872 S () ()	868.	1,304.	1,738.
	48"	84"	1"	AWM2 C4884 S () ()	993.	1,488.	1,986.
30"D both sides corner worksurfaces, extended right	48"	60"	1"	AWM2 C4860 D () ()	808.	1,209.	1,614.
	48"	72"	1"	AWM2 C4872 D () ()	931.	1,396.	1,862.
	48"	84"	1"	AWM2 C4884 D () ()	1,055.	1,584.	2,112.
24"D left/30"D right corner worksurfaces, extended right 	42"	60"	1"	AWM2 C4260 R () ()	746.	1,118.	1,488.
	42"	72"	1"	AWM2 C4272 R () ()	868.	1,303.	1,738.
	48"	60"	1"	AWM2 C4860 R () ()	808.	1,209.	1,614.
	48"	72"	1"	AWM2 C4872 R () ()	931.	1,396.	1,862.
	48"	84"	1"	AWM2 C4884 R () ()	1,055.	1,584.	2,112.
30"D left/24"D right corner worksurfaces, extended right	42"	60"	1"	AWM2 C4260 L () ()	746.	1,118.	1,488.
	42"	72"	1"	AWM2 C4272 L () ()	868.	1,303.	1,738.
	48"	60"	1"	AWM2 C4860 L () ()	808.	1,209.	1,614.
	48"	72"	1"	AWM2 C4872 L () ()	931.	1,396.	1,862.
	48"	84"	1"	AWM2 C4884 L () ()	1,055.	1,584.	2,112.

Worksurfaces

Order Code	Specification Information	Application Notes
Example: AWM2 C3660S 117 111	Dimensions shown in "w" column are nominal width of left back edge. Dimensions shown in "d" column are nominal width of right back edge.	Worksurfaces are sized for Morrison panel-based applications and may be supported by Morrison panel-planning brackets or end-supported and cantilevered from Currents wall. Extended side may also be supported with Currents C-legs. Underside of work surface is drilled to accept all Morrison panel-planning brackets, Morrison and Currents pedestals, work surface stiffeners and Currents C-leg on the extended side.
AWM2 Worksurface		Currents worksurfaces for Morrison require stiffener when the span between structural supports exceeds 36". Specify work surface stiffeners and supports separately.
C Corner		Currents worksurfaces for Morrison cannot be used in conjunction with Morrison Network desk supports.
36 Width left		Actual work surface is 3/8" less than nominal 24" and 30" for cable clearance.
60 Width right		All worksurfaces include two edge grommets, centered on back edges of work surface, with maximum clearance of 1 3/8".
S Depth left and right	<i>Worksurface depths:</i> S 24"D both sides L 30"D left/24"D right R 24"D left/30"D right D 30"D both sides	
117 Top finish	Specify top finish first, followed by trim finish.	
111 Trim finish		

Currents worksurfaces for Morrison panels and linkable screens

corner 3/8" wire drop and grommet

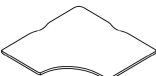

description	w	d	h	pattern no.	lam.	V2	V3
24"D both sides corner worksurfaces 	42"	42"	1"	AWM2 C4242 S () ()	\$559.	\$837.	\$1,118.
	48"	48"	1"	AWM2 C4848 S () ()	620.	931.	1,241.
	60"	60"	1"	AWM2 C6060 S () ()	868.	n/a	n/a
30"D both sides corner worksurfaces 	42"	42"	1"	AWM2 C4242 D () ()	559.	837.	1,118.
	48"	48"	1"	AWM2 C4848 D () ()	620.	931.	1,241.
	60"	60"	1"	AWM2 C6060 D () ()	868.	n/a	n/a
30"D left/24"D right corner worksurfaces 	42"	42"	1"	AWM2 C4242 L () ()	559.	837.	1,118.
	48"	48"	1"	AWM2 C4848 L () ()	620.	931.	1,241.
	60"	60"	1"	AWM2 C6060 L () ()	868.	n/a	n/a
24"D left/30"D right corner worksurfaces 	42"	42"	1"	AWM2 C4242 R () ()	559.	837.	1,118.
	48"	48"	1"	AWM2 C4848 R () ()	620.	931.	1,241.
	60"	60"	1"	AWM2 C6060 R () ()	868.	n/a	n/a

Order Code	Specification Information	Application Notes
Example: AWM2 C4848S 117 111 AWM2 Worksurface C Corner 48 Width left 48 Width right S Depth left and right 117 Top finish 111 Trim finish	Dimensions shown in "w" column are nominal width of left back edge. Dimensions shown in "d" column are nominal width of right back edge. Worksurface depths: S 24"D both sides L 30"D left/24"D right R 24"D left/30"D right D 30"D both sides Specify top finish first, followed by trim finish.	Currents for Morrison worksurfaces feature crisp 90° corners eliminating the corner kick detail typical of Currents universal and desk tops. Eliminating the corner kick will facilitate the use of brackets, pedestals and end panels at the side edge of worksurfaces and will eliminate undesired gaps at worksurface joints. Clear Maple is not available on 60"W x 60"D corner worksurfaces. Worksurfaces are sized for Morrison panel-based applications and may be supported by Morrison panel-planning brackets or end-supported and cantilevered from Currents wall. Underside of worksurfaces is drilled to accept all Morrison panel-planning brackets, Morrison and Currents pedestals, and worksurface stiffeners. 24"D worksurfaces are also drilled to accept Currents wall cantilever brackets. Currents worksurfaces for Morrison require stiffener when the span between structural supports exceeds 36". Specify worksurface stiffeners and supports separately. All P-shaped worksurfaces correspond to a 24"D adjacent straight or corner worksurface. Currents worksurfaces for Morrison cannot be used in conjunction with Morrison Network desk supports. Actual worksurface depth is 3/8" less than nominal 24" and 30" for cable clearance. All worksurfaces include two edge grommets, centered on back edges of worksurface, with maximum clearance of 1 5/8".

Currents worksurfaces for Morrison panels and linkable screens

P-shapes

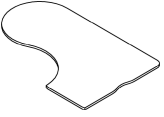
3/8" wire drop and grommet

description	w	d	h	pattern no.	lam.	V2	V3
P-shape surfaces, extended right 	48"	75"	1"	AWM2 P4875 S () ()	\$993.	\$1,488.	\$1,986.
	48"	87"	1"	AWM2 P4887 S () ()	1,118.	1,677.	2,233.
P-shape surfaces, extended left 	75"	48"	1"	AWM2 P7548 S () ()	993.	1,488.	1,986.
	87"	48"	1"	AWM2 P8748 S () ()	1,118.	1,677.	2,233.

Worksurfaces

Order Code	Specification Information	Application Notes
<p>Example: AWM2 C4848S 117 111</p> <p>AWM2 Worksurface</p> <p>C Corner</p> <p>48 Width left</p> <p>48 Width right</p> <p>S Depth left and right</p> <p>117 Top finish</p> <p>111 Trim finish</p>	<p>Dimensions shown in "w" column are nominal width of left back edge.</p> <p>Dimensions shown in "d" column are nominal width of right back edge.</p> <p><i>Worksurface depths:</i></p> <p>S 24"D both sides L 30"D left/24"D right R 24"D left/30"D right D 30"D both sides</p> <p>Specify top finish first, followed by trim finish.</p>	<p>Currents for Morrison worksurfaces feature crisp 90° corners eliminating the corner kick detail typical of Currents universal and desk tops. Eliminating the corner kick will facilitate the use of brackets, pedestals and end panels at the side edge of worksurfaces and will eliminate undesired gaps at worksurface joints.</p> <p>Clear Maple is not available on 60"W x 60"D corner worksurfaces.</p> <p>Currents worksurfaces for Morrison require stiffener when the span between structural supports exceeds 36". Specify worksurface stiffeners and supports separately.</p> <p>All P-shaped worksurfaces correspond to a 24"D adjacent straight or corner worksurface.</p> <p>Currents worksurfaces for Morrison cannot be used in conjunction with Morrison Network desk supports.</p> <p>Actual worksurface depth is 3/8" less than nominal 24" and 30" for cable clearance.</p> <p>All worksurfaces include two edge grommets, centered on back edges of worksurface, with maximum clearance of 1 5/8".</p>

Currents worksurfaces for Morrison panels and linkable
screens
stiffeners

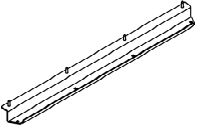
description	type	w	d	h	pattern no.	price
Stiffener for worksurfaces 	36"	20"	1 1/2"	1"	AWM1 S36	\$49.
	42"	26"	1 1/2"	1"	AWM1 S42	51.
	48"	32"	1 1/2"	1"	AWM1 S48	53.
	60"	44"	1 1/2"	1"	AWM1 S60	55.
	66"	50"	1 1/2"	1"	AWM1 S66	57.
	72"	56"	1 1/2"	1"	AWM1 S72	59.
	78"	62"	1 1/2"	1"	AWM1 S78	62.
	84"	68"	1 1/2"	1"	AWM1 S84	64.

Order Code

Example: AWM1 S36
AWM1 Stiffener
S Straight
36 Application

Specification Information

Stiffeners are black painted finish.

Application Notes

Currents worksurfaces for Morrison require stiffeners when the span between structural supports (end supports, cantilevers, pedestals, or C-legs) exceeds 36". Stiffener also serves as horizontal cable manager.

Stiffener corresponds in width to straight or corner worksurface back edge.

For 90" application span, use AWM1-S84 stiffener.

Stiffener mounts 18" from front edge of worksurface and will interfere with mobile or floorstanding pedestals greater than 18" deep.

To accommodate a floorstanding pedestal greater than 18" deep at one end of worksurface, specify stiffener for 12" narrower worksurface. To accommodate two floorstanding pedestals or double-wide at one end of worksurface, specify stiffener for 24" narrower worksurface.

Cascade edge worksurfaces

Rectangular

Currents

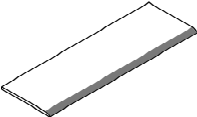
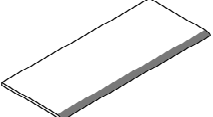
description	w	d	h	pattern no.	Solid	Woodgrain
24"D Rectangular 	24"	24"	1 1/8"	ACE1R2424N	\$178.	\$205.
	30"	24"	1 1/8"	ACE1R3024N	205.	236.
	36"	24"	1 1/8"	ACE1R3624N	227.	261.
	42"	24"	1 1/8"	ACE1R4224N	261.	301.
	48"	24"	1 1/8"	ACE1R4824N	293.	337.
	54"	24"	1 1/8"	ACE1R5424N	315.	362.
	60"	24"	1 1/8"	ACE1R6024N	342.	393.
	66"	24"	1 1/8"	ACE1R6624N	369.	424.
	72"	24"	1 1/8"	ACE1R7224N	386.	444.
	78"	24"	1 1/8"	ACE1R7824N	414.	476.
	84"	24"	1 1/8"	ACE1R8424N	438.	503.
90"	24"	1 1/8"	ACE1R9024N	494.	568.	
96"	24"	1 1/8"	ACE1R9624N	539.	620.	
30"D Rectangular 	24"	30"	1 1/8"	ACE1R2430N	228.	262.
	30"	30"	1 1/8"	ACE1R3030N	255.	293.
	36"	30"	1 1/8"	ACE1R3630N	283.	326.
	42"	30"	1 1/8"	ACE1R4230N	308.	354.
	48"	30"	1 1/8"	ACE1R4830N	342.	393.
	54"	30"	1 1/8"	ACE1R5430N	387.	445.
	60"	30"	1 1/8"	ACE1R6030N	425.	489.
	66"	30"	1 1/8"	ACE1R6630N	474.	545.
	72"	30"	1 1/8"	ACE1R7230N	494.	568.
	78"	30"	1 1/8"	ACE1R7830N	527.	606.
	84"	30"	1 1/8"	ACE1R8430N	560.	644.
90"	30"	1 1/8"	ACE1R9030N	602.	693.	
96"	30"	1 1/8"	ACE1R9630N	644.	740.	

Worksurfaces

Order Code	Specification Information	Application Notes
Example: ACE1 R4824N 118 ACE1 Cascade edge worksurface R Rectangular 48 Width 24 Depth N No grommet 118 Top finish	<p><i>Specify:</i> Grommet / No grommet. Replace the "N" suffix from the pattern number with "G". Add \$20.</p> <p>Available finishes:</p> <p>Solid:</p> <p>114 Folkstone Grey 117 Soft Grey 118 Bright White 119 Pumice</p> <p>Woodgrain:</p> <p>124 Medium Cherry 125 Natural Maple 126 Natural Cherry 127 Walnut</p>	<p>Cascade Edge worksurfaces are wrapped with a vinyl sheet heated and pressed around an MDF substrate. They are more susceptible to denting, impact, tearing and marring than conventional high-pressure laminate and should be handled with care. Do not drag worksurfaces across any flooring surface during installation. Treat Cascade Edge worksurfaces like veneer worksurfaces and they will perform well under normal conditions. Cascade Edge worksurfaces have a 5 year warranty on defects in workmanship and materials. This warranty does not cover damage occurring during or after installation.</p> <p>Cascade Edge worksurfaces are not drilled for stiffeners, pedestals or brackets.</p> <p>Cascade Edge worksurfaces are sized for panel-based applications and may be supported by linkable screen in conjunction with Morrison panel planning brackets, or end support from the Currents wall. 24" D straight tops may also be cantilevered from the Currents service wall.</p>
		<p>Cascade Edge worksurfaces are not interchangeable with Currents desks surfaces and should not be used to create freestanding Currents desks.</p> <p>Worksurfaces are 1/16" less than nominal width and 3/8" less than nominal depth for rear wire clearance.</p> <p>Edge grommets are centered at rear edges of worksurface for maximum clearance of 1 3/8".</p> <p>Worksurfaces require support every 48" in width. All supporting hardware is ordered separately. Use Morrison brackets with wood screws for Currents Linkable screen applications.</p> <p>Worksurfaces may be supported at each end by pedestals or end support "EC" brackets and cantilever brackets matching the worksurface depth. 24"D rectangular worksurfaces may also be cantilevered from the Currents service wall.</p> <p>Panel supported worksurfaces over 48" must be mid-span supported by cantilever brackets, specified separately.</p>

Cascade edge worksurfaces

Curvilinear corner

Currents

description	A	B	C	h	pattern no.	Solid	Woodgrain
	36"	24"	24"	1 1/8"	ACE1L3636SSN	\$447.	\$515.
	42"	24"	24"	1 1/8"	ACE1L4242SSN	539.	620.
	42"	24"	30"	1 1/8"	ACE1L4242SDN	641.	736.
	42"	30"	24"	1 1/8"	ACE1L4242DSN	641.	736.
	48"	24"	24"	1 1/8"	ACE1L4848SSN	606.	697.
	48"	24"	30"	1 1/8"	ACE1L4848SDN	725.	834.
	48"	30"	24"	1 1/8"	ACE1L4848DSN	725.	834.
	48"	30"	30"	1 1/8"	ACE1L4848DDN	651.	749.

Order Code

Example: ACE1 L4848SSG 114
ACE1 Cascade edge worksurface
L Curvilinear "L" top
48 Width left
48 Width right
S 24" depth left side
S 24" depth right side
G Grommets
114 Top finish

Specification Information

Specify:
Grommet / No grommet.
Replace the "N" suffix from the pattern number with "G". Add \$40.

Available finishes:

Solid:	114 Folkstone Grey
	117 Soft Grey
	118 Bright White
	119 Pumice

Woodgrain:

124 Medium Cherry
125 Natural Maple
126 Natural Cherry
127 Walnut

Note: When wood grain or brushed finishes are specified on Cascade corner worksurfaces with two "A" sides of equal length that do not exceed 42" you must select one of three grain direction options. Insert the desired grain direction "L"= Left hand, "R"= Right hand or "D"= Diagonal after the worksurface finish code to indicate the appropriate grain direction. When the "D" option is selected please add \$25.00 to the worksurface list price. 48" Cascade corners are not available with a diagonal grain option.

Application Notes

Cascade Edge worksurfaces are wrapped with a vinyl sheet heated and pressed around an MDF substrate. They are more susceptible to denting, impact, tearing and marring than conventional high-pressure laminate and should be handled with care. Do not drag worksurfaces across any flooring surface during installation. Treat Cascade Edge worksurfaces like veneer worksurfaces and they will perform well under normal conditions. Cascade Edge worksurfaces have a 5 year warranty on defects in workmanship and materials. This warranty does not cover damage occurring during or after installation.

Cascade Edge worksurfaces are not drilled for stiffeners, pedestals or brackets.

Cascade Edge worksurfaces are sized for panel-based applications and may be supported by linkable screen in conjunction with Morrison panel planning brackets, or end support from the Currents wall. 24" D straight tops may also be cantilevered from the Currents service wall.

Cascade Edge worksurfaces are not interchangeable with Currents desks surfaces and should not be used to create freestanding Currents desks.

Worksurfaces are 1/16" less than nominal width and 3/8" less than nominal depth for rear wire clearance.

Edge grommets are centered at rear edges of worksurface for maximum clearance of 1 3/8".

Worksurfaces require support every 48" in width. All supporting hardware is ordered separately. Use Morrison brackets with wood screws for Currents Linkable screen applications.

Worksurfaces may be supported by left or right hand 18" cantilever bracket at the rear corner, and cantilever bridging brackets on each side edge. Worksurfaces may also be end supported or cantilever-bracket supported from Currents wall. Extended side of blended L may also be supported with Currents C-legs.

Panel supported worksurfaces over 48" must be mid-span supported by cantilever brackets, specified separately.

Cascade edge worksurfaces

Blended "D"

Currents

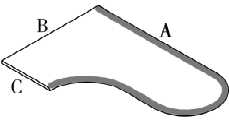
description	A	B	C	h	pattern no.	Solid	Woodgrain
 <p>right hand shown</p>	66"	48"	24"	1 1/8"	ACE1BD6648S(L/R)	\$723.	\$831.
	66"	48"	30"	1 1/8"	ACE1BD6648D(L/R)	760.	875.
	72"	48"	24"	1 1/8"	ACE1BD7248S(L/R)	739.	851.
	72"	48"	30"	1 1/8"	ACE1BD7248D(L/R)	788.	907.
	78"	48"	24"	1 1/8"	ACE1BD7848S(L/R)	854.	982.
	78"	48"	30"	1 1/8"	ACE1BD7848D(L/R)	882.	1,014.
	84"	48"	24"	1 1/8"	ACE1BD8448S(L/R)	877.	1,008.
	84"	48"	30"	1 1/8"	ACE1BD8448D(L/R)	932.	1,071.

Worksurfaces

Order Code	Specification Information	Application Notes
Example: ACE1BD6648SL 118	Available finishes:	<p>Cascade Edge worksurfaces are wrapped with a vinyl sheet heated and pressed around an MDF substrate. They are more susceptible to denting, impact, tearing and marring than conventional high-pressure laminate and should be handled with care. Do not drag worksurfaces across any flooring surface during installation. Treat Cascade Edge worksurfaces like veneer worksurfaces and they will perform well under normal conditions. Cascade Edge worksurfaces have a 5 year warranty on defects in workmanship and materials. This warranty does not cover damage occurring during or after installation.</p> <p>Cascade Edge worksurfaces are not drilled for stiffeners, pedestals or brackets.</p> <p>Cascade Edge worksurfaces are sized for panel-based applications and may be supported by linkable screen in conjunction with Morrison panel planning brackets, or end support from the Currents wall. 24" D straight tops may also be cantilevered from the Currents service wall.</p>
ACE1 Cascade edge worksurface	Solid:	
BD Blended "D"	114 Folkstone Grey	
66 Width	117 Soft Grey	
48 Depth	118 Bright White	
S 24"d return	119 Pumice	
L Extended left	Woodgrain:	
118 Top finish	124 Medium Cherry	
	125 Natural Maple	
	126 Natural Cherry	
	127 Walnut	
	<p>Cascade Edge worksurfaces are not interchangeable with Currents desks surfaces and should not be used to create freestanding Currents desks.</p> <p>Worksurfaces are 1/16" less than nominal width and 3/8" less than nominal depth for rear wire clearance.</p> <p>Edge grommets are centered at rear edges of worksurface for maximum clearance of 1 3/8".</p> <p>Worksurfaces require support every 48" in width. All supporting hardware is ordered separately. Use Morrison brackets with wood screws for Currents Linkable screen applications.</p> <p>Blended D worksurfaces are supported by a 48" VDT support bracket kit for cantilevering from the Currents wall in conjunction with Currents C-leg. Use flat bracket or bridging bracket to join to adjacent worksurface.</p>	

Cascade edge worksurfaces

Blended "L"

Currents

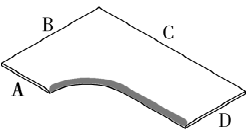
description	B	C	A	D	h	pattern no.	Solid	Woodgrain
	42"	60"	24"	24"	1 1/8"	ACE1L4260SSN	\$740.	\$852.
	42"	66"	24"	24"	1 1/8"	ACE1L4266SSN	760.	875.
	42"	72"	24"	24"	1 1/8"	ACE1L4272SSN	789.	908.
	42"	78"	24"	24"	1 1/8"	ACE1L4278SSN	798.	917.
	48"	60"	24"	24"	1 1/8"	ACE1L4860SSN	750.	862.
	48"	60"	24"	30"	1 1/8"	ACE1L4860SDN	736.	847.
	48"	60"	30"	24"	1 1/8"	ACE1L4860DSN	736.	847.
	48"	66"	24"	24"	1 1/8"	ACE1L4866SSN	777.	893.
	48"	66"	24"	30"	1 1/8"	ACE1L4866SDN	774.	890.
	48"	66"	30"	24"	1 1/8"	ACE1L4866DSN	774.	890.
	48"	72"	24"	24"	1 1/8"	ACE1L4872SSN	805.	926.
	48"	72"	24"	30"	1 1/8"	ACE1L4872SDN	810.	932.
	48"	72"	30"	24"	1 1/8"	ACE1L4872DSN	810.	932.
	48"	78"	24"	24"	1 1/8"	ACE1L4878SSN	888.	1,021.
	48"	84"	24"	24"	1 1/8"	ACE1L4884SSN	998.	1,148.
	60"	42"	24"	24"	1 1/8"	ACE1L6042SSN	740.	852.
	60"	48"	24"	24"	1 1/8"	ACE1L6048SSN	750.	862.
	60"	48"	24"	30"	1 1/8"	ACE1L6048SDN	736.	847.
	60"	48"	30"	24"	1 1/8"	ACE1L6048DSN	736.	847.
	66"	42"	24"	24"	1 1/8"	ACE1L6642SSN	760.	875.
	66"	48"	24"	24"	1 1/8"	ACE1L6648SSN	777.	893.
	66"	48"	24"	30"	1 1/8"	ACE1L6648SDN	774.	890.
	66"	48"	30"	24"	1 1/8"	ACE1L6648DSN	774.	890.
	72"	42"	24"	24"	1 1/8"	ACE1L7242SSN	789.	908.
	72"	48"	24"	24"	1 1/8"	ACE1L7248SSN	805.	926.
	72"	48"	24"	30"	1 1/8"	ACE1L7248SDN	810.	932.
	72"	48"	30"	24"	1 1/8"	ACE1L7248DSN	810.	932.

Order Code	Specification Information	Application Notes	
<p>Example: ACE1 L4260SSN 114</p> <p>ACE1 Cascade edge worksurface</p> <p>L Blended "L" top</p> <p>42 Width</p> <p>60 Depth</p> <p>S 24"d, left side</p> <p>S 24"d, right side</p> <p>N No Grommet</p> <p>114 Top finish</p>	<p><i>Specify:</i></p> <p>Grommet / No grommet. Replace the "N" suffix from the pattern number with "G". Add \$40.</p> <p>Available finishes:</p> <p>Solid:</p> <p>114 Folkstone Grey 117 Soft Grey 118 Bright White 119 Pumice</p> <p>Woodgrain:</p> <p>124 Medium Cherry 125 Natural Maple 126 Natural Cherry 127 Walnut</p>	<p>Cascade Edge worksurfaces are wrapped with a vinyl sheet heated and pressed around an MDF substrate. They are more susceptible to denting, impact, tearing and marring than conventional high-pressure laminate and should be handled with care. Do not drag worksurfaces across any flooring surface during installation. Treat Cascade Edge worksurfaces like veneer worksurfaces and they will perform well under normal conditions.</p> <p>Cascade Edge worksurfaces have a 5 year warranty on defects in workmanship and materials. This warranty does not cover damage occurring during or after installation.</p> <p>Cascade Edge worksurfaces are not drilled for stiffeners, pedestals or brackets.</p> <p>Cascade Edge worksurfaces are sized for panel-based applications and may be supported by linkable screen in conjunction with Morrison panel planning brackets, or end support from the Currents wall. 24" D straight tops may also be cantilevered from the Currents service wall.</p>	<p>Cascade Edge worksurfaces are not interchangeable with Currents desks surfaces and should not be used to create freestanding Currents desks.</p> <p>Worksurfaces are 1/16" less than nominal width and 3/8" less than nominal depth for rear wire clearance.</p> <p>Edge grommets are centered at rear edges of worksurface for maximum clearance of 1 3/8".</p> <p>Worksurfaces require support every 48" in width. All supporting hardware is ordered separately. Use Morrison brackets with wood screws for Currents Linkable screen applications.</p> <p>Worksurfaces may be supported by left or right hand 18" cantilever bracket at the rear corner, and cantilever bridging brackets on each side edge. Worksurfaces may also be end supported or cantilever-bracket supported from Currents wall. Extended side of blended L may also be supported with Currents C-legs.</p> <p>Panel supported worksurfaces over 48" must be mid-span supported by cantilever brackets, specified separately.</p>

Cascade edge worksurfaces

Blended "L"

description	B	C	A	D	h	pattern no.	Solid	Woodgrain
Blended "L"	78"	42"	24"	24"	1 1/8"	ACE1L7842SSN	\$798.	\$917.
	78"	48"	24"	24"	1 1/8"	ACE1L7848SSN	888.	1,021.
	84"	48"	24"	24"	1 1/8"	ACE1L8448SSN	998.	1,148.

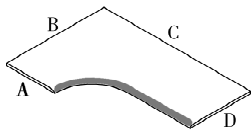





Order Code	Specification Information	Application Notes
Example: ACE1 L4260SSN 114		
ACE1 Cascade edge worksurface	<i>Specify:</i> Grommet / No grommet. Replace the "N" suffix from the pattern number with "G". Add \$40.	Cascade Edge worksurfaces are wrapped with a vinyl sheet heated and pressed around an MDF substrate. They are more susceptible to denting, impact, tearing and marring than conventional high-pressure laminate and should be handled with care. Do not drag worksurfaces across any flooring surface during installation. Treat Cascade Edge worksurfaces like veneer worksurfaces and they will perform well under normal conditions.
L Blended "L" top	Available finishes:	Cascade Edge worksurfaces are not interchangeable with Currents desks surfaces and should not be used to create freestanding Currents desks.
42 Width	Solid:	Worksurfaces are 1/16" less than nominal width and 3/8" less than nominal depth for rear wire clearance.
60 Depth	114 Folkstone Grey	Edge grommets are centered at rear edges of worksurface for maximum clearance of 1 3/8".
S 24"d, left side	117 Soft Grey	Worksurfaces require support every 48" in width. All supporting hardware is ordered separately. Use Morrison brackets with wood screws for Currents Linkable screen applications.
S 24"d, right side	118 Bright White	
N No Grommet	119 Pumice	
114 Top finish	Woodgrain:	
	124 Medium Cherry	Cascade Edge worksurfaces have a 5 year warranty on defects in workmanship and materials. This warranty does not cover damage occurring during or after installation.
	125 Natural Maple	Cascade Edge worksurfaces are not drilled for stiffeners, pedestals or brackets.
	126 Natural Cherry	Cascade Edge worksurfaces are sized for panel-based applications and may be supported by linkable screen in conjunction with Morrison panel planning brackets, or end support from the Currents wall. 24" D straight tops may also be cantilevered from the Currents service wall.
	127 Walnut	
		Worksurfaces may be supported by left or right hand 18" cantilever bracket at the rear corner, and cantilever bridging brackets on each side edge. Worksurfaces may also be end supported or cantilever-bracket supported from Currents wall. Extended side of blended L may also be supported with Currents C-legs.
		Panel supported worksurfaces over 48" must be mid-span supported by cantilever brackets, specified separately.

Cascade edge worksurfaces

Half round and corner round

Currents

description	w	d	h	pattern no.	Solid	Woodgrain
 Half Round	48"	18"	1 1/8"	ACE1H4818	\$386.	\$444.
	49 1/2"	18"	1 1/8"	ACE1H4818P	386.	444.
	60"	24"	1 1/8"	ACE1H6024	531.	612.
	61 1/2"	24"	1 1/8"	ACE1H6024P	531.	612.
 LH Corner Round	24"	24"	1 1/8"	AWF1CR24L	205.	236.
 RH Corner Round	24"	24"	1 1/8"	AWF1CR24R	205.	236.
 Notched Corner Round	24"	24"	1 1/8"	AWF1CR24N	205.	236.
 Sample	12"	12"	1 1/8"	ACE1R1212G	111.	128.

Order Code

Example:	ACE1 H4818P 117
ACE1	Cascade edge worksurface
H	Half round
48	Width
18	Depth
P	Notched for panel
117	Top finish

Specification Information

Available finishes:	
Solid:	
114	Folkstone Grey
117	Soft Grey
118	Bright White
119	Pumice
Woodgrain:	
124	Medium Cherry
125	Natural Maple
126	Natural Cherry
127	Walnut

Application Information

Cascade Edge worksurfaces are wrapped with a vinyl sheet heated and pressed around an MDF substrate. They are more susceptible to denting, impact, tearing and marring than conventional high-pressure laminate and should be handled with care. Do not drag worksurfaces across any flooring surface during installation. Treat Cascade Edge worksurfaces like veneer worksurfaces and they will perform well under normal conditions. Cascade Edge worksurfaces have a 5 year warranty on defects in workmanship and materials. This warranty does not cover damage occurring during or after installation.

Cascade Edge worksurfaces are not drilled for stiffeners, pedestals or brackets.

Cascade Edge worksurfaces are sized for panel-based applications and may be supported by linkable screen in conjunction with Morrison panel planning brackets, or end support from the Currents wall. 24" D straight tops may also be cantilevered from the Currents service wall. Cascade Edge worksurfaces are not interchangeable with Currents desks surfaces and should not be used to create freestanding Currents desks.

Worksurfaces are 1/16" less than nominal width and 3/8" less than nominal depth for rear wire clearance.

Edge grommets are centered at rear edges of worksurface for maximum clearance of 1 3/8".

Worksurfaces require support every 48" in width. All supporting hardware is ordered separately. Use Morrison brackets with wood screws for Currents Linkable screen applications.

Half round

Half round worksurfaces may be supported by cantilever bridging brackets in conjunction with a rounded end support column.

Corner round

Notched corner round worksurfaces are supported by cantilever bridging brackets on both side edges. End run Left- and Right-hand corner round worksurfaces are supported by a combination of an "EC" end bracket along the panel edge and a cantilever bridging bracket to the adjacent worksurface side edge.

Cascade edge worksurfaces

Wave end

Currents

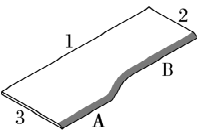
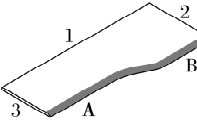
description	1	2	3	A	B	h	pattern no.	Solid	Woodgrain
Wave End, LH 	36"	24"	30"	15"	3"	1 1/8"	ACE1W363024N	\$480.	\$552.
	42"	24"	30"	15"	9"	1 1/8"	ACE1W423024N	504.	580.
	48"	24"	30"	15"	15"	1 1/8"	ACE1W483024N	540.	621.
	72"	24"	30"	23 1/2"	30 1/2"	1 1/8"	ACE1W723024N	687.	790.
Wave End, RH 	36"	30"	24"	3"	15"	1 1/8"	ACE1W362430N	480.	552.
	42"	30"	24"	9"	15"	1 1/8"	ACE1W422430N	504.	580.
	48"	30"	24"	15"	15"	1 1/8"	ACE1W482430N	540.	621.
	72"	30"	24"	23 1/2"	30 1/2"	1 1/8"	ACE1W722430N	687.	790.

Worksurfaces

Order Code

Example:	ACE1W483024N 118
ACE1	Cascade edge worksurface
W	Wave end
48	Width
30	Depth, right side
24	Depth, left side
N	No grommet
118	Top finish

Specification Information

Specify:
Grommet / No grommet.
Replace the "N" suffix from the pattern number with "G". Add \$20.

Available finishes:

Solid:

114	Folkstone Grey
117	Soft Grey
118	Bright White
119	Pumice

Woodgrain:

124	Medium Cherry
125	Natural Maple
126	Natural Cherry
127	Walnut

Application Notes

Cascade Edge worksurfaces are wrapped with a vinyl sheet heated and pressed around an MDF substrate. They are more susceptible to denting, impact, tearing and marring than conventional high-pressure laminate and should be handled with care. Do not drag worksurfaces across any flooring surface during installation. Treat Cascade Edge worksurfaces like veneer worksurfaces and they will perform well under normal conditions. Cascade Edge worksurfaces have a 5 year warranty on defects in workmanship and materials. This warranty does not cover damage occurring during or after installation.

Cascade Edge worksurfaces are not drilled for stiffeners, pedestals or brackets.

Cascade Edge worksurfaces are sized for panel-based applications and may be supported by linkable screen in conjunction with Morrison panel planning brackets, or end support from the Currents wall. 24" D straight tops may also be cantilevered from the Currents service wall.

Cascade Edge worksurfaces are not interchangeable with Currents desks surfaces and should not be used to create freestanding Currents desks.

Worksurfaces are 1/16" less than nominal width and 3/8" less than nominal depth for rear wire clearance.

Edge grommets are centered at rear edge of worksurface for maximum clearance of 1 3/8".

Worksurfaces require support every 48" in width. All supporting hardware is ordered separately. Use Morrison brackets with wood screws for Currents Linkable screen applications.





Worksurfaces may be supported at each end by pedestals or end support "EC" brackets and cantilever brackets matching the worksurface depth. Use cantilever bridging bracket to join to adjacent worksurface.

Panel supported worksurfaces over 48" must be mid-span supported by cantilever brackets, specified separately.

Worksurface supports

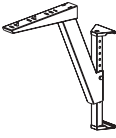
wall-mounted

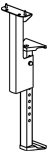
Currents

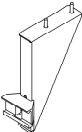
description	type	w	d	h	pattern no.	paint
Adjustable cantilever bracket (up to 24"D)		3"	20"	23-33"	AB1 AC24 ()	\$176.
						
Adjustable cantilever bridging bracket		3"	20"	23-33"	AB1-ABC24()	228.
Fixed end support bracket		3"	6"	27"	AB1 FE ()	112.
						
Adjustable end support bracket		3"	6"	23-33"	AB2 AE ()	139.
						
Compact fixed end support bracket	for 28"h worksurface		6"	27"	AB2 FE27 ()	119.
	for 29 ⁵ / ₈ " h worksurface		6"	28"	AB2 FE28 ()	119.
						
Fence end bracket kit					AB1 FAE ()	161.
						

Order Code

Example: AB1 AC24 117	
AB1	Bracket
AC	Type
24	Depth
117	Finish

Specification Information

Specify painted finishes for support column, C-leg, and brackets.

Fence end bracket kit includes a left and a right handed bracket.

Specify paint finish for end bracket.

Application Notes

Specify worksurface cantilever and end support brackets to attach worksurfaces to Currents service walls.

Specify two cantilever brackets to support any 24"D Currents, Morrison, Reff, Equity, Dividends, or Cascade worksurface up to 84" wide, or one back edge of corner worksurface. Specify three cantilever brackets to support any 24"D Currents, Morrison, Reff, Equity, Dividends or Cascade worksurface greater than 84" wide. Specify two end support brackets to support one end of straight, conference, or arc-shape surface.

Adjustable height cantilever and bridging cantilever brackets support underside of worksurface in 1" increments from 23" to 33"H (24" to 34" top height).

Adjustable bridging cantilever supports adjacent 48"W straight or corner worksurfaces.





End support brackets adjust 23"-33"H (24" to 34" top height). Fixed height brackets support worksurface at 28"H and 29⁵/₈" H.

Fence end brackets attach to the Currents fence to support one end of rectilinear or one back edge of a corner worksurface when the other ends are properly supported by legs, storage or panel brackets. Refer to the specific worksurface Application Notes for support requirements.

Fence end brackets support the underside of the worksurface in 1" increments from 26" to 28" (27" to 29" top height).

Worksurface supports freestanding

Currents

description	type	application	w	d	h	pattern no.	paint
 Straight leg	Adjustable		2"	4"	23-29"	AB1 I27A(G/C) ()	\$340.
	Fixed		2"	4"	27"	AB1 I27F(G/C) ()	174.
	Low		2"	4"	25"	AB1 I25(G/C) ()	174.
 C-leg, adjustable	24"D	Left	2"	21"	23-29"	AB1 CL24L ()()	376.
		Right	2"	21"	23-29"	AB1 CL24R ()()	376.
	30"D	Left	2"	27"	23-29"	AB1 CL30L ()()	414.
		Right	2"	27"	23-29"	AB1 CL30R ()()	414.
 C-leg, fixed height	24"D	Left	2"	21"	27"	AB1 CLF24L ()()	315.
		Right	2"	21"	27"	AB1 CLF24R ()()	315.
	30"D	Left	2"	27"	27"	AB1 CLF30L ()()	345.
		Right	2"	27"	27"	AB1 CLF30R ()()	345.
 Corner leg	Corner worksurfaces		4"	4"	23-29"	AB1 VL ()()	315.

Worksurfaces

Order Code

Example:	AB1 CL24L 612 G
AB1	Support
CL	C-leg
24	Depth
L	Left
612	Finish
G	Glides

Specification Information

Specify painted finishes for support column, C-leg, and brackets.

C-Leg casters/glides:

C	Rear casters/front glides
G	All glides

Casters/glides combination has no levelling. All-glides version provides 1 3/4" levelling range.

Application Notes

Specify two straight legs under shared worksurface. Straight legs are fixed at 27"H (28" top height) or adjustable 23"-29" (24"-30" top height).

C-legs support one end of any corresponding depth Currents worksurface. Corner legs support only the back corner of a Currents corner worksurface. Specify C-legs for side edges of Currents corner and extended corner worksurfaces.

Adjustable C-legs and corner legs are adjustable in height to support underside of worksurface at 1" increments from 23" to 29" (24" to 30" Currents top height). Fixed height C-legs support desk at 28"H. Fixed height C-legs do not accept service beams.

Straight legs may not be used with Currents universal worksurfaces or Currents worksurfaces for Morrison to create freestanding tables.

Pedestals *mobile*

Currents

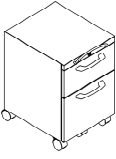
description	type	w	d	h	pattern no.	P1 / P2	P3	V2 front	V3 front
	2 file	15"	17"	26 1/2"	AS1 SFF M () ()	\$1,000.	\$1,050.	\$1,128.	\$1,269.
	Data/file	15"	17"	22"	AS1 SDF M () ()	947.	995.	1,072.	1,213.
	Personal/data/file	15"	17"	26 1/2"	AS1 SPDF M () ()	1,104.	1,160.	1,252.	1,412.

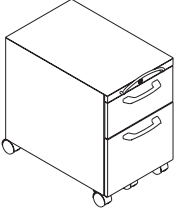
	2 file	15"	23"	26 1/2"	AS1 DFF M () ()	1,125.	1,181.	1,253.	1,396.
	Data/file	15"	23"	22"	AS1 DDF M () ()	1,073.	1,127.	1,197.	1,340.
	Personal/data/file	15"	23"	26 1/2"	AS1 DPDF M () ()	1,229.	1,292.	1,377.	1,540.

Standard mobile pedestal open top, with pull	Data/file	15"	17"	22"	AS1 SDFO () ()	884.	929.	1,008.	1,151.
--	-----------	-----	-----	-----	-------------------------	------	------	--------	--------

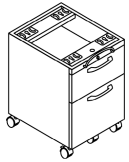

Deep mobile pedestal open top, with pull	Data/file	15"	23"	22"	AS1 DDFO () ()	985.	1,035.	1,109.	1,250.
--	-----------	-----	-----	-----	-------------------------	------	--------	--------	--------

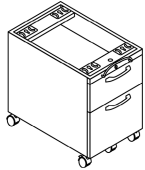

Order Code

Example: **AS1 SDFM 612 612**

AS1	Pedestal
S	Depth
DF	Configuration
M	Mobile
612	Finish for case
612	Finish for fronts

Specification Information

Specify painted finish for case, painted or veneer finish for fronts.

All pedestals include front lock with KnollKey lock system. Personal drawer is 4"H. Data drawer is 7"H. File drawers are 11"H. Deep file drawers include file support for letter (width) or legal (depth) suspended file folders. All drawers have full extension, ball bearing drawer slides.

Application Notes

Mobile pedestals are independent storage components with locking casters and pull. Standard mobile pedestals roll under Currents worksurfaces set at 28" or higher. Deep mobile pedestals with two files or personal/data/file will not fit under stiffener of universal worksurface or Currents desk set at 29" or lower. Specify data/file mobile pedestal under worksurfaces adjusted lower than 28"H.

Pedestals floorstanding

Currents

description	type	w	d	h	pattern no.	P1 / P2	P3	V2 front	V3 front
18"D Floorstanding pedestal	2 file	15"	17"	27"	AS1 SFF G () ()	\$725.	\$760.	\$851.	\$994.
	personal/data/file	15"	17"	27"	AS1 SPDFG () ()	829.	872.	976.	1,137.

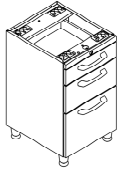

24"D Floorstanding pedestal	2 file	15"	23"	27"	AS1 DFF G () ()	824.	866.	953.	1,093.
	personal/data/file	15"	23"	27"	AS1 DPDFG () ()	930.	976.	1,076.	1,239.

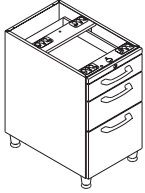

18"D Floorstanding pedestal Double wide	2 file	30"	17"	27"	AS1FF30G () ()	1,269.	1,330.	1,489.	1,740.
		36"	17"	27"	AS1FF36G () ()	1,548.	1,622.	1,817.	2,123.

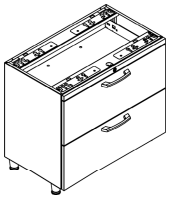

2 door		30"	17"	27"	AS1DD30G () ()	1,269.	1,330.	1,489.	1,740.
		36"	17"	27"	AS1DD36G () ()	1,548.	1,622.	1,817.	2,123.

data/file		30"	17"	23"	AS1DF30G () ()	1,205.	1,264.	1,414.	1,653.
		36"	17"	23"	AS1DF36G () ()	1,471.	1,542.	1,725.	2,017.

personal/data/file		30"	17"	27"	AS1PDF30G () ()	1,451.	1,526.	1,708.	1,990.
		36"	17"	27"	AS1PDF36G () ()	1,770.	1,862.	2,083.	2,427.

Floorstanding storage

Order Code

Example: **AS1 SPDFG 612 612**

AS1	Pedestal
S	Depth
PDF	Configuration
G	Floorstanding
612	Finish for case
612	Finish for fronts

Specification Information

Specify painted finish for case, painted or veneer finish for fronts.

All pedestals include front lock with KnollKey lock system. Personal drawer is 4"H. Data drawer is 7"H. File drawers are 11"H. Deep file drawers include file support for letter (width) or legal (depth) suspended file folders. All drawers have full extension, ball bearing drawer slides.

Application Notes

Floorstanding pedestals include levelling glides and open top to support one end of a worksurface at 28"H. 18"D pedestals fit under any Currents worksurface with standard stiffener. Deep floorstanding pedestals fit under Currents worksurfaces for Morrison with properly sized replacement worksurface stiffener.

Pedestals may not be used in freestanding applications.

Pedestal accessories

Currents

pencil tray, drawer divider, file support rail, bumper kits

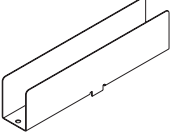
description	type	w	d	h	pattern no.	price
Pencil tray 	Personal or data drawer				AS1 PT	\$34.
Drawer divider 	Personal or data drawer				MD6-BD	29.
File support rail	File drawer, set of 2				MD6-FS	11.
Bumper kits for mobile pedestal	21"H pedestal			21"	AS1 BKL	40.
	26"H pedestal			26"	AS1 BKH	48.

Order Code

Example: **AS1 PT**

AS1 Pedestal

PT Pencil tray

Specification Information

Pencil tray is black molded plastic.
Drawer divider is black painted steel.

Replacement worksurface stiffeners are black painted steel.

Bumper kit is trim grey plastic.

Application Notes

Pencil tray sets in top of personal or data drawer. Moveable dividers organize pencils, pens, and paper clips in separate compartments.

Drawer divider mounts in slots in bottom of personal or data drawer. U-shaped divider supports two rows of four CDs with titles visible in data drawer.

File support spans width of file drawer to support side-to-side letter or legal width suspended files.

Bumper kit protects back corners of mobile pedestals and adjacent furniture. Bumper kit includes two corner-bead shape extrusions with self-adhesive backer.

cushion

fabric

Description	type	w	d	pattern no.	A	B	C	D	E	F	G	H	I
Cushion	Deep	15"	23"	AS1 DPAD ()	\$201.	\$225.	\$263.	\$276.	\$301.	\$327.	\$363.	\$401.	\$414.
	Standard	15"	17"	AS1 SPAD ()	163.	188.	213.	225.	238.	263.	288.	327.	339.

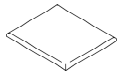

Order Code

Example: **AS1 SPAD**

AS1 Pedestal

S Depth

PAD Cushion

Specification Information

There is a \$71 upcharge on CAL133 backing on the cushion.

Consult the Knoll seating price list for fabric information and grades.

Application Notes

Pedestal cushions are for use on Currents open top mobile pedestals as well as on open top mobile pedestals in other Knoll systems lines.

Pedestal accessories

Currents

cushion

leather

Description	type	w	d	pattern no.	U	V	W	X	Y
Cushion	Deep	15"	23"	AS1 DPAD ()	\$401.	\$476.	\$589.	\$615.	\$651.
	Standard	15"	17"	AS1 SPAD ()	314.	375.	463.	476.	501.

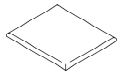

Order Code

Example: **AS1 SPAD**

AS1 Pedestal

S Depth

PAD Cushion

Specification Information

There is a \$71 upcharge on CAL133 backing on the cushion.

Consult the Knoll seating price list for leather information and grades.

Application Notes

Pedestal cushions are for use on Currents open top mobile pedestals as well as on open top mobile pedestals in other Knoll systems lines.

Vertical storage cabinets

Reuter rotating door cabinets

Currents

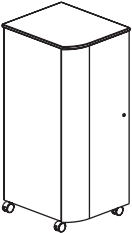
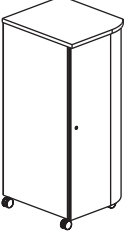
description	type	w	d	h	pattern no.	laminate	paint	V2 front
	painted top	21"	24"	48"	A2 R48 LP () () ()		\$2,885.	\$3,385.
		21"	24"	64"	A2 R64 LP () () ()		3,259.	3,887.
	worksurface top, plastic laminate	21"	24"	48"	A2 R48 LL () () ()	3,134.	n/a	n/a
	worksurface top, veneer	21"	24"	48"	A2 R48 LV () () ()		3,259.	3,887.
	painted top	21"	24"	48"	A2 R48 RP () () ()		2,885.	3,385.
		21"	24"	64"	A2 R64 RP () () ()		3,259.	3,887.
	worksurface top, plastic laminate	21"	24"	48"	A2 R48 RL () () ()	3,134.	n/a	n/a
	worksurface top, veneer	21"	24"	48"	A2 R48 RV () () ()		3,259.	3,887.
Accessories	shelf insert				A1 R1 SI		125.	
Replacement top	left				A1 RTOPL () ()	309.	245.	461.
	right				A1 RTOPR () ()	309.	245.	461.

Order Code	Specification Information	Application Notes
Example: A2R 64 LP 117 117 117 G	<i>For cabinets, specify:</i>	<p>Rotating door cabinets are portable enclosed freestanding storage. Cabinets feature full-height door, two file drawer frames, and a protected 4½"W wardrobe area. 48"H includes one adjustable shelf, 64"H includes two shelves.</p> <p>Cabinet top is painted finish. 48"H cabinet is also available with plastic laminate or veneer worksurface top. Cabinets with veneer front are available with painted or veneer top only.</p> <p>Additional shelves may be specified separately.</p> <p>Painted front cabinets may be changed from left-hand to right-hand in field but replacement top is required.</p> <p>Cabinet width is designed to enable open door in 24"W footprint.</p>
A2R Reuter vertical storage	Top finish	
64 Height	Case finish	
L Left door	Front finish	
P Painted top	<i>Casters/glides:</i>	
117 Top finish	C Casters	
117 Case finish	G Glides	
117 Front finish	<i>For replacement tops, specify:</i>	
G Glides	<i>Top type</i>	
	P Painted	
	L Plastic laminate	
	V Techgrain® veneer	
	Worksurface top edges are trim grey T-mold.	

Vertical storage cabinets

Reuter options rotating door cabinets

Currents

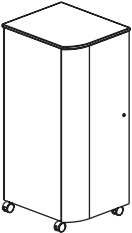
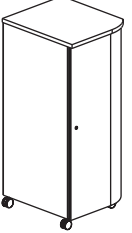
description	type	w	d	h	pattern no.	laminate	paint	V2 front
	painted top	21"	24"	48"	A2L 48 LP () () ()		\$2,481.	\$2,968.
		21"	24"	64"	A2L 64 LP () () ()		2,847.	3,458.
	worksurface top, plastic laminate	21"	24"	48"	A2L 48 LL () () ()	2,725.	n/a	n/a
	worksurface top, veneer	21"	24"	48"	A2L 48 LV () () ()		2,847.	3,458.
	painted top	21"	24"	48"	A2L 48 RP () () ()		2,481.	2,968.
		21"	24"	64"	A2L 64 RP () () ()		2,847.	3,458.
	worksurface top, plastic laminate	21"	24"	48"	A2L 48 RL () () ()	2,725.	n/a	n/a
	worksurface top, veneer	21"	24"	48"	A2L 48 RV () () ()		2,847.	3,458.
Accessories	shelf insert				A1 R1 SI		125.	
Replacement top	left				A1 RTOPL () ()	309.	245.	461.
	right				A1 RTOPR () ()	309.	245.	461.

Order Code	Specification Information	Application Notes
Example: A2L 64 LP 117 117 117 G	<i>For cabinets, specify:</i>	<p>Rotating door cabinets are portable enclosed freestanding storage. Cabinets feature full-height door, two file drawer frames, and a protected 4½"W wardrobe area. 48"H includes one adjustable shelf, 64"H includes two shelves.</p> <p>Cabinet top is painted finish. 48"H cabinet is also available with plastic laminate or veneer worksurface top. Cabinets with veneer front are available with painted or veneer top only.</p> <p>Additional shelves may be specified separately.</p> <p>Painted front cabinets may be changed from left-hand to right-hand in field but replacement top is required.</p> <p>Cabinet width is designed to enable open door in 24"W footprint.</p>
A2L Reuter vertical storage	Top finish	
64 Height	Case finish	
L Left door	Front finish	
P Painted top	<i>Casters/glides:</i>	
117 Top finish	C Casters	
117 Case finish	G Glides	
117 Front finish	<i>For replacement tops, specify:</i>	
G Glides	<i>Top type</i>	
	P Painted	
	L Plastic laminate	
	V Techgrain® veneer	
	Worksurface top edges are trim grey T-mold.	

Reuter overhead cabinet
desk, wall, or other Knoll system mounted
Designed by Robert Reuter

description	type	w	d	h	pattern no.	P1	P2	P3	V2
Enclosed cabinet, with lock (no mounting hardware) - One door 		24"	14 1/4"	14 3/4"	RO3-N24()L	\$615.	\$615.	\$645.	\$927.
		30"	14 1/4"	14 3/4"	RO3-N30()L	685.	685.	722.	1,000.
		36"	14 1/4"	14 3/4"	RO3-N36()L	792.	792.	833.	1,121.
		42"	14 1/4"	14 3/4"	RO3-N42()L	919.	919.	966.	1,247.
		48"	14 1/4"	14 3/4"	RO3-N48()L	1,028.	1,028.	1,077.	1,369.

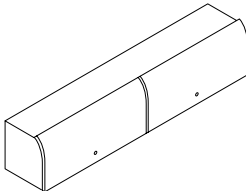
Enclosed cabinet, with lock (no mounting hardware) - Two doors 		60"	14 1/4"	14 3/4"	RO3-N60()L	1,300.	1,300.	1,367.	1,886.
		66"	14 1/4"	14 3/4"	RO3-N66()L	1,423.	1,423.	1,491.	2,020.
		72"	14 1/4"	14 3/4"	RO3-N72()L	1,519.	1,519.	1,595.	2,133.

Enclosed cabinet, no lock (no mounting hardware) - One door 		24"	14 1/4"	14 3/4"	RO3-N24()N	552.	552.	580.	n/a
		30"	14 1/4"	14 3/4"	RO3-N30()N	626.	626.	658.	n/a
		36"	14 1/4"	14 3/4"	RO3-N36()N	733.	733.	769.	n/a
		42"	14 1/4"	14 3/4"	RO3-N42()N	860.	860.	903.	n/a
		48"	14 1/4"	14 3/4"	RO3-N48()N	965.	965.	1,013.	n/a

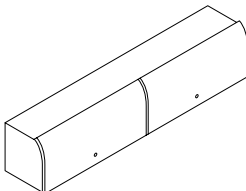
Enclosed cabinet, no lock (no mounting hardware) - Two doors 		60"	14 1/4"	14 3/4"	RO3-N60()N	1,179.	1,179.	1,238.	n/a
		66"	14 1/4"	14 3/4"	RO3-N66()N	1,299.	1,299.	1,364.	n/a
		72"	14 1/4"	14 3/4"	RO3-N72()N	1,401.	1,401.	1,470.	n/a

Order Code

Example:	RO3-N48-P-L-613-P-613
RO3	Reuter overhead cabinet
N	No brackets
48	Width
P	With pull
L	With lock
613	Case finish
P	Front finish type
613	Front finish

Specification Information

Specify finish for case and door.

Application Notes

Reuter storage is a universal product applicable on Knoll systems.

Cabinet door rotates above cabinet on side pivots, counterbalanced by two pneumatic cylinders. Two-door cabinets have center divider and four pneumatic cylinders. Vertical interior partitions may be positioned on 1 1/2" increments of width anywhere across shelf, 1 1/2" in from each side. Vertical partitions contain cutouts for mounting up to five horizontal partitions at 2" increments on either or both sides.



Horizontals are suspended between two verticals, and may be positioned end-to-end in any combination up to 3" less than cabinet width. Available in sets of 10; 6", 9", 12", 15" widths.

Order locks for overheads with a KnollKey order form. Please note that Reuter overhead cabinets 60"W or wider require two lock cores.

Reuter overhead doors without locks include black, Knoll-logo insert, in the same position. Insert may be removed to retrofit a lock later.

Reuter open overhead

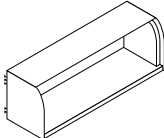
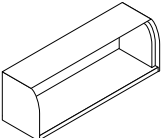

Designed by Robert Reuter

description	type	w	d	h	pattern no.	black	P1	P2	P3	V2
	Open overhead Morrison panel brackets	30"	13"	14 ³ / ₄ "	RO3-OM30()		\$452.	\$452.	\$476.	
		36"	13"	14 ³ / ₄ "	RO3-OM36()		518.	518.	544.	
		42"	13"	14 ³ / ₄ "	RO3-OM42()		586.	586.	615.	
		48"	13"	14 ³ / ₄ "	RO3-OM48()		651.	651.	684.	
		60"	13"	14 ³ / ₄ "	RO3-OM60()		758.	758.	795.	
		72"	13"	14 ³ / ₄ "	RO3-OM72()		890.	890.	936.	
	Open overhead no mounting hardware	30"	13"	14 ³ / ₄ "	RO3-ON30()		439.	439.	461.	
		36"	13"	14 ³ / ₄ "	RO3-ON36()		505.	505.	530.	
		42"	13"	14 ³ / ₄ "	RO3-ON42()		572.	572.	601.	
		48"	13"	14 ³ / ₄ "	RO3-ON48()		639.	639.	670.	
		60"	13"	14 ³ / ₄ "	RO3-ON60()		743.	743.	783.	
		72"	13"	14 ³ / ₄ "	RO3-ON72()		877.	877.	920.	
	Vertical, set of 5	–	11"	12"	RO3-VP	78.				
		Horizontal, set of 10	6"	11"	–	RO1-HP6	120.			
	9"		11"	–	RO1-HP9	152.				
	12"		11"	–	RO1-HP12	180.				
	15"		11"	–	RO1-HP15	210.				
Door retrofit kit, with lock	For open overhead	30"			RO3-RD30()L		308.	308.	324.	594.
		36"			RO3-RD36()L		333.	333.	350.	645.
		42"			RO3-RD42()L		388.	388.	407.	700.
		48"			RO3-RD48()L		425.	425.	445.	751.
		60"			RO3-RD60()L		650.	650.	682.	1,207.
		72"			RO3-RD72()L		730.	730.	765.	1,314.
Door retrofit kit, no lock	For open overhead	30"			RO3-RD30()N		235.	235.	246.	n/a
		36"			RO3-RD36()N		272.	272.	286.	n/a
		42"			RO3-RD42()N		329.	329.	345.	n/a
		48"			RO3-RD48()N		363.	363.	383.	n/a
		60"			RO3-RD60()N		529.	529.	556.	n/a
		72"			RO3-RD72()N		610.	610.	641.	n/a

Order Code	Specification Information	Application Notes
Example: RO3-ON30-612	<i>Specify finish for case and door.</i>	<p>Interior partitions are black painted steel finish.</p> <p>Door retrofit kits convert an open overhead to an enclosed cabinet and include Reuter overhead door, left and right arm mechanisms, and lock or lock plug.</p> <p>Reuter storage is a universal product applicable on Morrison or other Knoll systems. Open overheads may be mounted on any combination of vertical panels the same width or up to 12" less than shelf width.</p> <p>Reuter open overheads may be desk-mounted, mounted on other Knoll systems, cantilevered above panels, or wall-mounted. Specify open overhead with no mounting hardware and brackets separately.</p> <p>Vertical interior partitions may be positioned on 1 1/2" increments of width anywhere across shelf, 1 1/2" in from each side. Vertical partitions contain cutouts for mounting three horizontal partitions at 2" increments on either or both sides. Horizontals are suspended between two verticals, and may be positioned end-to-end in any combination up to 3" less than shelf width. Available in sets of 10; 6", 9", 12", 15" widths.</p>
RO1-O Reuter open overhead		
N No mounting hardware		
30 Width		
612 Finish		

Reuter open shelf

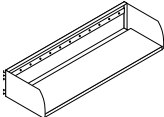
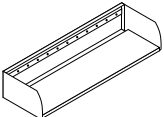
Designed by Robert Reuter

description	type	w	d	h	pattern no.	black	P1	P2	P3
 Open shelf Morrison panel brackets		24"	13"	8"	RS1-M24()		\$279.	\$279.	\$292.
		30"	13"	8"	RS1-M30()		305.	305.	321.
		36"	13"	8"	RS1-M36()		345.	345.	362.
		42"	13"	8"	RS1-M42()		372.	372.	390.
		48"	13"	8"	RS1-M48()		399.	399.	418.
		60"	13"	8"	RS1-M60()		466.	466.	489.
 Open shelf no mounting hardware		24"	13"	8"	RS1-N24()		265.	265.	279.
		30"	13"	8"	RS1-N30()		293.	293.	308.
		36"	13"	8"	RS1-N36()		333.	333.	350.
		42"	13"	8"	RS1-N42()		359.	359.	376.
		48"	13"	8"	RS1-N48()		386.	386.	405.
		60"	13"	8"	RS1-N60()		452.	452.	476.
 Interior partitions	Vertical, set of 5	–	12"	6"	RS1-VP	73.			
	Horizontal, set of 10	6"	12"	–	RO1-HP6	120.			
		9"	12"	–	RO1-HP9	152.			
		12"	12"	–	RO1-HP12	180.			
		15"	12"	–	RO1-HP15	210.			

Order Code

Example:	RS1-N48-612
RS1	Reuter shelf
N	No mounting hardware
48	Width
612	Finish

Specification Information

Specify paint finishes for shelf.

Application Notes

Interior partitions are black painted steel finish.

Reuter storage is a universal product applicable on Morrison or other Knoll systems.

Open shelves may be mounted on any combination of vertical panels the same width. Reuter open shelves may be Morrison Network desk-mounted, mounted on other Knoll systems, cantilevered above panels, or wall-mounted. Specify Reuter shelves with no mounting hardware, and brackets separately.

Vertical interior partitions may be positioned on 1 1/2" increments of width anywhere across shelf, 1 1/2" in from each side. Vertical partitions contain cutouts for mounting three horizontal partitions at 2" increments on either or both sides. Horizontals are suspended between two verticals, and may be positioned end-to-end in any combination up to 3" less than shelf width. Available in sets of 10; 6", 9", 12", 15" widths.

Reuter ganging bracket
wall-mounting options and ADA pull
Designed by Robert Reuter

description	type	w	d	h	pattern no.	black
Ganging bracket					RO1-GB	\$12.
ADA pull					RO1-PULL	44.

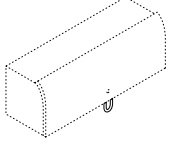

Order Code	Specification Information	Application Notes
Example: RO1-GB	Wall mount frames are painted black finish.	Wall mount frames secure Reuter overhead cabinet or shelf to wall (frame/wall mounting hardware is not included). Frame is concealed behind storage. Use two RO1-WMF2 to wall-mount 66"- and 72"-wide Reuter overheads.
RO1 Reuter overhead	ADA pull is stainless steel.	Reuter open shelves 66" and 72"W are for stanchion support only.
GB Ganging bracket		Wall mount wire manager is two-part wire concealment kit, 22"H (medium grey only).
		Ganging bracket joins adjacent Reuter overheads or shelves for additional stiffness and alignment when storage is planned on only one side of a panel run.
		ADA pull mounts to Reuter painted front overhead door to allow seated users to close door easily. Specify one for each cabinet 24" - 48", two for cabinets 60" - 72".
		ADA pull cannot be mounted on wood front Reuter doors.

description	type	w	d	h	pattern no.	black	paint
Morrison Options and Series 2 Morrison overhead downmount brackets and back panel (64"H wall only)		24"			AA1LO24DN()		\$225.
		30"			AA1LO30DN()		233.
		36"			AA1LO36DN()		238.
		42"			AA1LO42DN()		244.
		48"			AA1LO48DN()		251.
Morrison shelf downmount brackets (64"H wall only)					AA1RSXDN ()		162.
Equity overhead brackets	Downmount bracket				AA1EDWS		72.
	Upmount bracket (pair) (64")				AA1ECUP64		225.
	Upmount bracket (pair) (65")				AA1ECUP65		225.
Reuter overhead brackets	Downmount brackets (pair) (64"H wall only)				AA1RODN()	194.	
	Extended upmount brackets (pair) (39"H wall)				AA1ROXUP()	387.	
	Upmount brackets (pair)				AA1ROUP()	194.	
Reuter shelf brackets	Extended downmount brackets (pair) (64"H wall only)				AA1RSXDN()		162.
	Reuter shelf adapter brackets				RS1 MPB		33.
	Shelf downmount brackets (pair) (39"H or 48"H wall only)				AA1RSDN()		194.
	Shelf extended upmount brackets (pair) (39"H wall)				AA1RSXUP()		387.
	Shelf upmount brackets (pair)				AA1RSUP()		194.

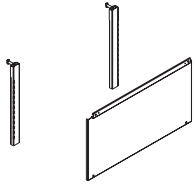

Order Code

Example:	AA1 LO48 DN 612
AA1	Currents accessory
LO	Options overhead
48	Size
DN	Configuration
612	Finish

Specification Information

Specify painted finish for shelf downmount brackets and overhead downmount kit.

Application Notes

Morrison downmount brackets support Morrison or Options shelves and brackets on 64"H service wall.

Overhead downmount bracket kits include back panel and brackets to suspend Options overhead cabinets from 64"H service wall crown.

Equity downmount bracket attaches an Equity overhead to a 64"H Currents wall. Specify two brackets - one for each end of overhead unit. Upmount brackets are used with 48"H Currents wall and can be specified to align the top of the overhead at 64" or 65" of total height. A back must always be specified for the Equity overhead when mounting on the Currents wall (see Equity price list).

Reuter upmount brackets attach overhead cabinet or shelf anywhere along panel crown, lifting 1" above nominal wall height. Extended upmount brackets lift self to 10" above nominal wall height.

Downmount brackets attach overheads within the upper 16" of 64"H walls and open shelves within the upper 9" of 48" or 39"H walls.

Specify an extra bracket (one-half pair) for center support of overhead cabinets wider than 60" and shelves wider than 54".

Upmount or downmount brackets may be inset to permit overhead to extend 1" or 3" and shelf to extend 3" beyond the end of the spine at T-ends.

Extended downmount brackets enable the Reuter open shelf to be mounted from 49"-56"H on 64" service all. Specify shelf adapter brackets separately.

For brackets for use with **Dividends** and Series 2 for Dividends overheads, please consult the Dividends price list.

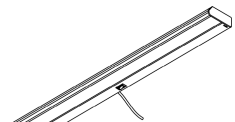
description	type	w	d	h	pattern no.	Standard List	Advanced List
Task Light 	Use with 24" and wider overhead	19"	4"	1 1/2"	RTAT5E19 ()	\$202.	n/a
	Use with 30" and wider overhead	25"	4"	1 1/2"	RTAT5E25 ()	217.	374.
	Use with 42" and wider overhead	37"	4"	1 1/2"	RTAT5E37 ()	234.	394.
	Use with 60" and wider overhead	49"	4"	1 1/2"	RTAT5E49 ()	254.	410.
	Use with 66" and wider overhead	61"	4"	1 1/2"	RTAT5E61 ()	270.	426.

Order Code	Specification Information	Application Notes
Example: RTAT5E19S <hr/> RTA Task Light <hr/> T5 T5 lamp <hr/> E Electronic ballast <hr/> 19 Width <hr/> S Standard	<p><i>Specify:</i></p> <p>Width - Task Lights mount in cabinets and shelves at least 5" wider than light width.</p> <p>Type:</p> <p>S Standard A Advanced</p> <p>Specify suffix -CH and add \$45 list for City of Chicago installations. Example: RTAT5E19S-CH</p> <p>All housings are black.</p>	<p>Task lights mount into the recess in the underside of overhead cabinets and shelves at least 5" wider than task light width.</p> <p>Task lights include T5 cool white (4100K) fluorescent lamp, electronic ballast, 9' grounded cordset, prismatic lens, rocker switch, one cord exit management clip and mounting hardware.</p> <p>Task light cordset is center exit. On smaller units cort exit is off-center, but still not handed.</p> <p>Task lights are TCLP compliant and meet requirements of California Title 24.</p> <p>Advanced task lights are fitted with ballast and lamp compliant with LEED requirements.</p>

Portable shelf and counter surface
portable shelf and counter surface

Currents

description	w	d	h	pattern no.	lam.	V2	V3	paint
Portable shelf	24"	13"	15"	AA1PS24()				\$502.

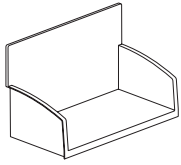

Counter surface	36"	12"	1"	AW1 CS3612 ()	226.	337.	452.
	48"	12"	1"	AW1 CS4812 ()	250.	376.	502.
	60"	12"	1"	AW1 CS6012 ()	276.	414.	552.
	72"	12"	1"	AW1 CS7212 ()	301.	452.	600.

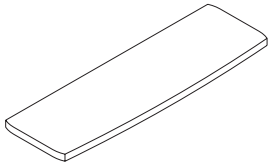

Counter surface bracket kit				AB1 CS ()				226.
-----------------------------	--	--	--	-------------------	--	--	--	------

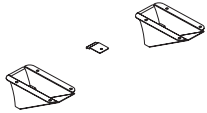

Order Code

Example:	AA1 PS24 612
AA1	Currents accessory
PS	Personal shelf
24	Width
612	Finish

Specification Information

Specify painted finish for shelf or surface finish for counter.



Application Notes

Portable shelf upmounts anywhere along standard height service wall crown. High back provides 13"H x 22"W surround to 12" above crown, with integral handles and simple mounting clamps.

Counter surface with curved front is designed to mount on either side of 39"H wall crown with counter surface brackets. Kit includes two brackets and center support.

Ambient lighting and awning canopy, uplights and awning

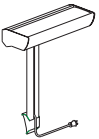
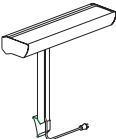
Currents

description	type	w	d	h	watts	pattern no.	light grey	list price
 Canopy uplight	39" H wall	24"	24"	40"	32	AL1 C39	\$1,380.	
	48" H wall	24"	24"	31"	32	AL1 C48	1,380.	
	64" H wall	24"	24"	15"	32	AL1 C64	1,380.	
 Linear uplight, 18"W	39" H wall	18"	8"	30"	72	AL1 A3918	1,380.	
	48" H wall	18"	8"	21"	72	AL1 A4818	1,380.	
	64" H wall	18"	8"	5"	72	AL1 A6418	1,380.	
 Linear uplight, 24"W	39" H wall	24"	8"	30"	100	AL1 A3924	1,881.	
	48" H wall	24"	8"	21"	100	AL1 A4824	1,881.	
	64" H wall	24"	8"	5"	100	AL1 A6424	1,881.	
 Awning uplight	48" or 64"H wall	9"	8"	5"	32	AL1 AA	1,003.	
 Translucent awning		36"	24"	27"		AA1C36T		626.

Order Code	Specification Information	Application Notes
Example: AL1 C48 AL1 Lighting C Canopy 48 Mounting height	<p>Canopy is white perforated aluminum. Light fixtures and posts are light grey finish.</p> <p>Canopy and uplights utilize electronic ballasts, and 9' cordset.</p> <p>Canopy and awning uplight have a single 32 watt tri-biaxial compact fluorescent lamp.</p> <p>18" linear uplight has two 36 watt biaxial compact fluorescent lamps.</p> <p>24" linear uplight has two 50 watt biaxial compact fluorescent lamps.</p> <p>For City of Chicago applications, specify fused cordset (suffix -CH), and add \$82 list.</p> <p><i>Finish for awning brackets:</i> Awning brackets are integral color trim grey finish.</p>	<p>Canopy, linear, and awning uplights attach to standard height service wall crown, on either side at any point. Lights mounted back-to-back allow space between for add-up panels.</p> <p>Canopy and linear uplight include rectangular post to position top of light fixture at 73"H. Awning uplight mounts at 2" above crown for use under awning.</p> <p>Canopy light is designed for interiors with high ceilings.</p> <p>Integral white reflector of canopy is supported at 80"H.</p> <p>Linear ambient uplights are designed for interiors with ceilings from 8' to 10' high.</p> <p>All lights include vertical cord manager from crown to fixture.</p> <p>Consult your Knoll representative for photometric information on Currents ambient lighting.</p>

Desks

*pin-set adjustable
extended left*

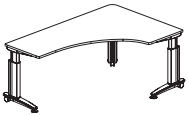
description	w (l)	w (r)	h	pattern no.	lam.	V2	V3
 24"D both sides corner desk, extended left	60"	36"	24-30"	AD C53 SF () ()	\$1,726.	\$2,045.	\$2,366.
	60"	48"	24-30"	AD C54 SF () ()	1,855.	2,237.	2,620.
	72"	36"	24-30"	AD C63 SF () ()	1,855.	2,237.	2,620.
	72"	48"	24-30"	AD C64 SF () ()	1,982.	2,430.	2,877.
	84"	48"	24-30"	AD C74 SF () ()	2,110.	2,634.	3,163.
30"D left/24"D right corner desk, extended left	60"	48"	24-30"	AD C54 LF () ()	1,956.	2,372.	2,785.
	72"	48"	24-30"	AD C64 LF () ()	2,084.	2,563.	3,043.
	84"	48"	24-30"	AD C74 LF () ()	2,210.	2,768.	3,215.
30"D both sides corner desk, extended left	60"	48"	24-30"	AD C54 DF () ()	2,058.	2,574.	3,074.
	72"	48"	24-30"	AD C64 DF () ()	2,186.	2,730.	3,278.
	84"	48"	24-30"	AD C74 DF () ()	2,313.	2,895.	3,471.

Order Code	Specification Information	Application Notes
Example: AD C64 LF 117 117 G		
AD Desk	<i>Specify desk shape:</i> C Corner	<i>Specify glides/casters:</i> C Rear casters G Glides
C Shape		
6 Width left	<i>Width left/width right:</i> 3 36" 4 48" 5 60" 6 72" 7 84"	Desks incorporate universal worksurface and adjustable C legs. Pin-set desk surface can be set at installation from 24" - 30" high, in 1" increments.
4 Width right		Worksurface edges are trim grey.
L Depth (30"D left)		Integral cable tray under worksurface and channels in legs provide basic lay-in wire management.
F Base type		Extended corner desks provide computer corner and adjacent work area in one unit. Nominal worksurface depths include 1 3/4" cable/connector space along back edges. Clearance under worksurfaces (for pedestals, Backpack or other accessories) is 18".
117 Desktop finish	<i>Worksurface depth:</i> S 24"D both sides L 30"D left, 24"D right R 30"D right, 24"D left D 30"D both sides	
117 Desk base finish	<i>Base type:</i> F Manually adjustable	
G Glides	<i>Specify desk top and base finish.</i>	Desks may be specified with fixed front glides and rear casters or 1 3/4" levelling glides. Casters and glides are interchangeable in the field.
		Desks accept clamp-on workshelves and service beams which support privacy screens, distribute power and data, and are linkable.

Desks
pin-set adjustable
extended right

Currents

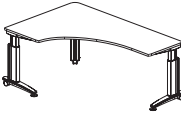
description	w(l)	w(r)	h	pattern no.	lam.	V2	V3
 24"D both sides corner desk, extended right	36"	60"	24-30"	AD C35 SF () ()	\$1,726.	\$2,045.	\$2,366.
	36"	72"	24-30"	AD C36 SF () ()	1,855.	2,237.	2,620.
	48"	60"	24-30"	AD C45 SF () ()	1,855.	2,237.	2,620.
	48"	72"	24-30"	AD C46 SF () ()	1,982.	2,430.	2,877.
	48"	84"	24-30"	AD C47 SF () ()	2,110.	2,634.	3,163.
30"D right/24"D left corner desk, extended right	48"	60"	24-30"	AD C45 RF () ()	1,956.	2,372.	2,785.
	48"	72"	24-30"	AD C46 RF () ()	2,084.	2,563.	3,043.
	48"	84"	24-30"	AD C47 RF () ()	2,210.	2,768.	3,215.
30"D both sides	48"	60"	24-30"	AD C45 DF () ()	2,058.	2,574.	3,074.
	48"	72"	24-30"	AD C46 DF () ()	2,186.	2,730.	3,278.
	48"	84"	24-30"	AD C47 DF () ()	2,313.	2,895.	3,471.

Order Code	Specification Information	Application Notes
Example: AD C46 SF 117 117 G		
AD Desk	<i>Specify desk shape:</i> C Corner	Desks incorporate universal worksurface and adjustable C legs. Pin-set desk surface can be set at installation from 24" - 30" high, in 1" increments.
C Shape		
4 Width left	<i>Width left/width right:</i> 3 36" 4 48"	Integral cable tray under worksurface and channels in legs provide basic lay-in wire management.
6 Width right	5 60"	
S Depth (24" both sides)	6 72"	Extended corner desks provide computer corner and adjacent work area in one unit. Nominal worksurface depths include 1 3/4" cable/connector space along back edges. Clearance under worksurfaces (for pedestals, BackPack or other accessories) is 18".
F Base type	7 84"	
117 Desktop finish	<i>Worksurface depth:</i> S 24"D both sides L 30"D left, 24"D right R 30"D right, 24"D left D 30"D both sides	Desks may be specified with fixed front glides and rear casters or 1 3/4" levelling glides. Casters and glides are interchangeable in the field.
117 Desk base finish		
G Glides	<i>Base type:</i> F Manually adjustable	Desks accept clamp-on workshelves and service beams which support privacy screens, distribute power and data, and are linkable.
	<i>Specify desk top and base finish.</i>	

Desks
pin-set adjustable
corner desk

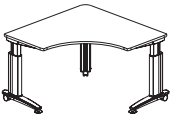
description	w(l)	w(r)	h	pattern number	lam.	V2	V3
 24"D both sides corner desk	42"	42"	24-30"	AD C4242 SF () ()	\$1,662.	\$1,950.	\$2,237.
	48"	48"	24-30"	AD C44 SF () ()	1,726.	2,045.	2,366.
	60"	60"	24-30"	AD C55 SF () ()	1,918.	n/a	n/a
30"D left/24"D right corner desk	42"	42"	24-30"	AD C4242 LF () ()	1,702.	1,988.	2,277.
	48"	48"	24-30"	AD C44 LF () ()	1,764.	2,084.	2,403.
	60"	60"	24-30"	AD C55 LF () ()	1,956.	n/a	n/a
24"D left/30"D right corner desk	42"	42"	24-30"	AD C4242 RF () ()	1,702.	1,988.	2,277.
	48"	48"	24-30"	AD C44 RF () ()	1,764.	2,084.	2,403.
	60"	60"	24-30"	AD C55 RF () ()	1,956.	n/a	n/a
30"D both sides corner desk	42"	42"	24-30"	AD C4242 DF () ()	1,740.	2,027.	2,314.
	48"	48"	24-30"	AD C44 DF () ()	1,803.	2,121.	2,441.
	60"	60"	24-30"	AD C55 DF () ()	1,994.	n/a	n/a

Order Code	Specification Information	Application Notes
Example: AD C44 LF 117 117 G		
AD Desk	<i>Specify desk shape:</i> C Corner	<i>Specify glides/casters:</i> C Rear casters G Glides
C Shape	<i>Width left/width right:</i> 4 48" 5 60"	
4 Width left		Worksurface edges are trim grey. Clear Maple not available on 60"W x 60"D corner desks.
4 Width right		
L Depth (30"D left)		<i>Worksurface depth:</i> S 24"D both sides L 30"D left, 24"D right R 30"D right, 24"D left D 30"D both sides
F Base type		
117 Desktop finish		<i>Base type:</i> F Manually adjustable
117 Desk base finish		
G Glides	<i>Specify desk top and base finish.</i>	

Desks incorporate universal worksurface and adjustable C legs. Pin-set desk surface can be set at installation from 24" - 30" high, in 1" increments.

Corner desks provide up to 45" diagonal depth for large monitors, keyboard and mouse. Nominal worksurface depths include 1 3/4" cable/connector space along back edge. Clearance under worksurfaces (for pedestals, Backpack or other accessories) is 18".

Desks may be specified with fixed front glides and rear casters or 1 3/4" levelling glides. Casters and glides are interchangeable in the field.

Desks accept clamp-on workshelves and service beams which support privacy screens, distribute power and data, and are linkable.

Desks
*pin-set adjustable
 straight desk*

description	w(l)	w(r)	h	pattern number	lam.	V2	V3
 24"D straight desk, curved front	36"	24"	24-30"	AD S36 SF () ()	\$1,074.	\$1,228.	\$1,381.
	42"	24"	24-30"	AD S42 SF () ()	1,101.	1,266.	1,432.
	48"	24"	24-30"	AD S48 SF () ()	1,124.	1,305.	1,482.
	60"	24"	24-30"	AD S60 SF () ()	1,176.	1,381.	1,585.
	72"	24"	24-30"	AD S72 SF () ()	1,228.	1,455.	1,688.
	84"	24"	24-30"	AD S84 SF () ()	1,278.	1,534.	1,789.
30"D straight desk, curved front	36"	30"	24-30"	AD S36 DF () ()	1,189.	1,362.	1,534.
	42"	30"	24-30"	AD S42 DF () ()	1,214.	1,324.	1,585.
	48"	30"	24-30"	AD S48 DF () ()	1,240.	1,440.	1,636.
	60"	30"	24-30"	AD S60 DF () ()	1,305.	1,534.	1,764.
	72"	30"	24-30"	AD S72 DF () ()	1,381.	1,650.	1,918.

Order Code	Specification Information	Application Notes
Example: AD S48 DF 117 117 G	<i>Specify desk shape:</i>	<i>Specify glides/casters:</i>
AD Desk	S Straight	C Rear casters
S Shape		G Glides
48 Width	<i>Worksurface depth:</i>	
D Depth	S 24"D both sides	Worksurface edges are trim grey.
F Base type	D 30"D both sides	
117 Desktop finish	<i>Base type:</i>	
117 Desk base finish	F Manually adjustable	
G Glides	<i>Specify desk top and base finish.</i>	

Desks incorporate universal worksurface and adjustable C legs. Pin-set desk surface can be set at installation from 24" - 30" high, in 1" increments.

Straight desks have slightly curved front edges, to a maximum of 1" extra depth at the center. Nominal worksurface depths include 1 3/4" cable/connector space along back edge. Clearance under worksurfaces (for pedestals, BackPack or other accessories) is 18".

Desks may be specified with fixed front glides and rear casters or 1 3/4" levelling glides. Casters and glides are interchangeable in the field.

Desks accept clamp-on workshelves and service beams which support privacy screens, distribute power and data, and are linkable.

Desks

*handcrank adjustable
extended left*

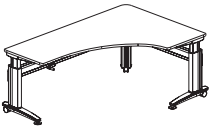
description	w(l)	w(r)	h	pattern no.	lam.	V2	V3
 24"D both sides corner desk, extended left	60"	36"	24-34"	AD C53 SH () ()	\$2,620.	\$2,942.	\$3,261.
	60"	48"	24-34"	AD C54 SH () ()	2,749.	3,132.	3,515.
	72"	36"	24-34"	AD C63 SH () ()	2,749.	3,132.	3,515.
	72"	48"	24-34"	AD C64 SH () ()	2,877.	3,323.	3,771.
	84"	48"	24-34"	AD C74 SH () ()	3,006.	3,515.	4,027.
30"D left/24"D right corner desk, extended left	60"	48"	24-34"	AD C54 LH () ()	2,850.	3,266.	3,680.
	72"	48"	24-34"	AD C64 LH () ()	2,979.	3,458.	3,937.
	84"	48"	24-34"	AD C74 LH () ()	3,106.	3,649.	4,194.
30"D both sides corner desk, extended left	60"	48"	24-34"	AD C54 DH () ()	2,850.	3,266.	3,680.
	72"	48"	24-34"	AD C64 DH () ()	2,979.	3,458.	3,937.
	84"	48"	24-34"	AD C74 DH () ()	3,106.	3,649.	4,194.

Order Code	Specification Information	Application Notes
Example: AD C53 SH 117 117 G	<i>Specify desk shape:</i>	<p>Handcrank desks incorporate synchronized, adjustable C legs and corner legs. Handcrank mechanism enables user to adjust worksurface from 24" - 34" high (continuous) with collapsible crank under front edge. Handcrank is located on the extended side of desks.</p> <p>Integral cable tray under worksurface and channels in legs provide basic lay-in wire management. Crossbeam stiffens legs through upper height range. Crossbeam is 4"H, 14" above floor.</p> <p>Desks may be specified with fixed front glides and rear casters or 1 3/4" levelling glides. Casters and glides are interchangeable in the field.</p> <p>Extended corner desks provide computer corner and adjacent work area in one unit. Nominal worksurface depths include 1 3/4" cable/connector clearance along back edge.</p> <p>Handcrank mechanism is rated at 300 lbs. maximum weight.</p> <p>Desks accept clamp-on workshelves and service beams which support privacy screens, distribute power and data, and are linkable.</p>
AD Desk	C Corner	
C Shape	<i>Width left, width right:</i>	
5 Width left	3 36"	
3 Width right	4 48"	
S Depth	5 60"	
H Base type	6 72"	
117 Desktop finish	7 84"	
117 Base finish	<i>Worksurface depth:</i>	
G Glides	S 24"D both sides L 30"D left, 24"D right R 30"D right, 24"D left D 30"D both sides	
	<i>Base type:</i>	
	H Handcrank adjustable	
	<i>Specify desk top and base finish.</i>	

Desks
handcrank adjustable
extended right

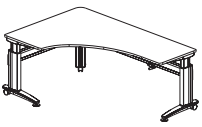
description	w(l)	w(r)	h	pattern no.	lam.	V2	V3
 24"D both sides corner desk, extended right	36"	60"	24-34"	AD C35 SH () ()	\$2,620.	\$2,942.	\$3,261.
	36"	72"	24-34"	AD C36 SH () ()	2,749.	3,132.	3,515.
	48"	60"	24-34"	AD C45 SH () ()	2,749.	3,132.	3,515.
	48"	72"	24-34"	AD C46 SH () ()	2,877.	3,323.	3,771.
	48"	84"	24-34"	AD C47 SH () ()	3,006.	3,515.	4,027.
30"D right/24"D left corner desk, extended left	48"	60"	24-34"	AD C45 RH () ()	2,850.	3,266.	3,680.
	48"	72"	24-34"	AD C46 RH () ()	2,979.	3,458.	3,937.
	48"	84"	24-34"	AD C47 RH () ()	3,106.	3,649.	4,194.
30"D both sides corner desk, extended left	48"	60"	24-34"	AD C45 DH () ()	2,850.	3,266.	3,680.
	48"	72"	24-34"	AD C46 DH () ()	2,979.	3,458.	3,937.
	48"	84"	24-34"	AD C47 DH () ()	3,106.	3,649.	4,194.

Order Code	Specification Information	Application Notes
Example: AD C35 SH 117 117 G	<i>Specify desk shape:</i>	<p>Handcrank desks incorporate synchronized, adjustable C legs and corner legs. Handcrank mechanism enables user to adjust worksurface from 24" - 34" high (continuous) with collapsible crank under front edge. Handcrank is located on the extended side of desks.</p> <p>Integral cable tray under worksurface and channels in legs provide basic lay-in wire management. Crossbeam stiffens legs through upper height range. Crossbeam is 4"H, 14" above floor.</p> <p>Desks may be specified with fixed front glides and rear casters or 1 3/4" levelling glides. Casters and glides are interchangeable in the field.</p> <p>Extended corner desks provide computer corner and adjacent work area in one unit. Nominal worksurface depths include 1 3/4" cable/connector clearance along back edge.</p> <p>Handcrank mechanism is rated at 300 lbs. maximum weight.</p> <p>Desks accept clamp-on workshelves and service beams which support privacy screens, distribute power and data, and are linkable.</p>
AD Desk	C Corner	
C Shape	<i>Width left, width right:</i>	
3 Width left	3 36"	
5 Width right	4 48"	
S Depth	5 60"	
H Base type	6 72"	
117 Desktop finish	7 84"	
117 Base finish	<i>Worksurface depth:</i>	
G Glides	S 24"D both sides L 30"D left, 24"D right R 30"D right, 24"D left D 30"D both sides	
	<i>Base type:</i>	
	H Handcrank adjustable	
	<i>Specify desk top and base finish.</i>	

Desks

handcrank adjustable corner desk

Currents

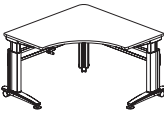
description	w(l)	w(r)	h	pattern no.	lam.	V2	V3
 24"D both sides corner desk	42"	42"	24-34"	AD C4242 SH () ()	\$2,509.	\$2,793.	\$3,083.
	48"	48"	24-34"	AD C44 SH () ()	2,620.	2,942.	3,261.
	60"	60"	24-34"	AD C55 SH () ()	2,812.	n/a	n/a
30"D left/24"D right corner desk	42"	42"	24-34"	AD C4242 LH () ()	2,546.	2,833.	3,157.
	48"	48"	24-34"	AD C44 LH () ()	2,657.	2,979.	3,297.
	60"	60"	24-34"	AD C55 LH () ()	2,850.	n/a	n/a
24"D left/30"D right corner desk	42"	42"	24-34"	AD C4242 RH () ()	2,546.	2,833.	3,157.
	48"	48"	24-34"	AD C44 RH () ()	2,657.	2,979.	3,297.
	60"	60"	24-34"	AD C55 RH () ()	2,850.	n/a	n/a
30"D both sides corner desk	48"	48"	24-34"	AD C44 DH () ()	2,698.	3,017.	3,337.
	60"	60"	24-34"	AD C55 DH () ()	2,890.	n/a	n/a

Order Code

Example:	AD C44 SH 117 117 G
AD	Desk
C	Shape
4	Width left
4	Width right
S	Depth
H	Base type
117	Desktop finish
117	Base finish
G	Glides

Specification Information

<i>Specify desk shape:</i>		<i>Specify:</i>
C	Corner	C Rear casters
		G Glides
<i>Width left, width right:</i>		Worksurface edges are trim grey. Clear Maple is not available on 60"W x 60"D corner desks.
4	48"	
5	60"	
<i>Worksurface depth:</i>		
S	24"D both sides	
L	30"D left, 24"D right	
R	30"D right, 24"D left	
D	30"D both sides	
<i>Base type:</i>		
H	Handcrank adjustable	
<i>Specify desk top and base finish.</i>		

Application Notes

Handcrank desks incorporate synchronized, adjustable C legs and corner legs. Handcrank mechanism enables user to adjust worksurface from 24" - 34" high (continuous) with collapsible crank under front edge.

Desks may be specified with fixed front glides and rear casters or 1 3/4" levelling glides. Casters and glides are interchangeable in the field. Integral cable tray under worksurface and channels in legs provide basic lay-in wire management.

Corner desks provide up to 45" diagonal depth for large monitors, keyboard and mouse. Nominal worksurface depths include 1 3/4" cable/connector clearance along back edge.

Handcrank mechanism is rated at 300 lbs. maximum weight.

Desks accept clamp-on workshelves and service beams which support privacy screens, distribute power and data, and are linkable.

Desk, credenzas and worktables

Desks
handcrank adjustable
straight desk

description	w(l)	w(r)	h	pattern no.	lam.	V2	V3
 24"D straight desk, curved front	36"	24"	24-34"	AD S36 SH () ()	\$1,712.	\$1,866.	\$2,020.
	42"	24"	24-34"	AD S42 SH () ()	1,739.	1,904.	2,071.
	48"	24"	24-34"	AD S48 SH () ()	1,764.	1,945.	2,121.
	60"	24"	24-34"	AD S60 SH () ()	1,816.	2,020.	2,225.
	72"	24"	24-34"	AD S72 SH () ()	1,866.	2,096.	2,327.
	84"	24"	24-34"	AD S84 SH () ()	1,918.	2,173.	2,430.
30"D straight desk, curved front	36"	30"	24-34"	AD S36 DH () ()	1,828.	2,000.	2,173.
	42"	30"	24-34"	AD S42 DH () ()	1,855.	2,038.	2,225.
	48"	30"	24-34"	AD S48 DH () ()	1,878.	2,079.	2,276.
	60"	30"	24-34"	AD S60 DH () ()	1,945.	2,173.	2,403.
	72"	30"	24-34"	AD S72 DH () ()	2,020.	2,288.	2,556.

Order Code	Specification Information	Application Notes
Example: AD S48 DH 117 117 G	<i>Specify desk shape:</i>	<p>Handcrank desks incorporate synchronized, adjustable C legs and corner legs. Handcrank mechanism enables user to adjust worksurface from 24" - 34" high (continuous) with collapsible crank under front edge. Hand crank may be installed on the left or right side of any straight or symmetrical corner desk.</p> <p>Desks may be specified with fixed front glides and rear casters or levelling glides with 1 3/4" travel. Integral cable tray under worksurface and channels in legs provide basic lay-in wire management.</p> <p>Straight desks have slightly curved front edges, to a maximum of 1" extra depth at the center. Nominal worksurface depths include 1 3/4" cable/connector clearance along back edge.</p> <p>Handcrank mechanism is rated at 300 lbs. maximum weight.</p> <p>Desks accept clamp-on workshelves and service beams which support privacy screens, distribute power and data, and are linkable.</p>
AD Desk	S Straight	
S Shape	<i>For straight desks specify:</i>	
48 Width	<i>Width:</i>	
D Depth	36 36"	
H Base type	42 42"	
117 Desktop finish	48 48"	
117 Base finish	60 60"	
G Glides	72 72"	
	84 84"	
	<i>Worksurface depth:</i>	
	S 24"D	
	D 30"D	
	<i>Base type:</i>	
	H Handcrank adjustable	
	<i>Specify desk top and base finish.</i>	
	<i>Specify:</i>	
	C Rear casters	
	G Glides	
	Worksurface edges are trim grey.	

Desks with service beam
pin-set adjustable
extended left

Currents

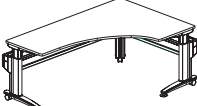
description	w(l)	w(r)	h	pattern no.	lam.	V2	V3
24"D both sides corner desk, with beam extended left 	60"	36"	24-30"	AD C53 SB () ()	\$2,468.	\$2,785.	\$3,106.
	60"	48"	24-30"	AD C54 SB () ()	2,634.	3,017.	3,400.
	72"	36"	24-30"	AD C63 SB () ()	2,634.	3,017.	3,400.
	72"	48"	24-30"	AD C64 SB () ()	2,802.	3,247.	3,696.
	84"	48"	24-30"	AD C74 SB () ()	3,119.	3,643.	4,174.
30"D left/24"D right corner desk, with beam extended left	60"	48"	24-30"	AD C54 LB () ()	2,735.	3,152.	3,566.
	72"	48"	24-30"	AD C64 LB () ()	2,900.	3,380.	3,860.
	84"	48"	24-30"	AD C74 LB () ()	3,221.	3,777.	4,224.
30"D both sides corner desk, with beam extended left	60"	48"	24-30"	AD C54 DB () ()	3,067.	3,585.	4,085.
	72"	48"	24-30"	AD C64 DB () ()	3,194.	3,738.	4,288.
	84"	48"	24-30"	AD C74 DB () ()	3,322.	3,905.	4,479.

Order Code	Specification Information	Application Notes
Example: AD C64 SB 117 117 G	<i>Specify desk shape:</i>	Desks with service beam have power distribution capability, separate lay-in wire management, and sockets for privacy screens. Pin-set worksurface can be installed at 24" - 30" high, in 1" increments. Beam provides privacy screen support, modular power distribution, lay-in cable distribution, and modesty to 14" above floor level. Service beams can be linked for continuous power/data distribution through adjacent desks and credenzas with service beams. Extended corner desks provide computer corner plus adjacent work area in one unit. Nominal worksurface depths include 1 3/4" cable/connector space along back edges. Desks may be specified with fixed front glides and rear casters or levelling glides with 1 3/4" travel. Corner desk beams have four openings for Knoll PDC modules. Specify power distribution components separately. Desks accept clamp-on workshelves.
AD Desk	C Corner	
C Shape	<i>Width left, width right:</i>	
6 Width left	3 36"	
4 Width right	4 48"	
S Depth	5 60"	
B Base type	6 72"	
117 Desktop finish	7 84"	
117 Desk base finish	<i>Worksurface depth:</i>	
G Glides	S 24"D both sides L 30"D left, 24"D right R 30"D right, 24"D left D 30"D both sides	
	<i>Base type:</i>	
	B Adjustable with beam	
	<i>Specify desk top and base finish.</i>	

Desk, credenzas and worktables

Desks with service beam
pin-set adjustable
extended right

Currents

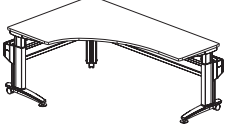
description	w(l)	w(r)	h	pattern no.	lam.	V2	V3
24"D both sides corner desk, with beam extended right 	36"	60"	24-30"	AD C35 SB () ()	\$2,468.	\$2,785.	\$3,106.
	36"	72"	24-30"	AD C36 SB () ()	2,634.	3,017.	3,400.
	48"	60"	24-30"	AD C45 SB () ()	2,634.	3,017.	3,400.
	48"	72"	24-30"	AD C46 SB () ()	2,802.	3,247.	3,696.
	48"	84"	24-30"	AD C47 SB () ()	3,119.	3,643.	4,174.
30"D right/24"D left corner desk, with beam extended right	48"	60"	24-30"	AD C45 RB () ()	2,735.	3,152.	3,566.
	48"	72"	24-30"	AD C46 RB () ()	2,900.	3,380.	3,860.
	48"	84"	24-30"	AD C47 RB () ()	3,221.	3,777.	4,224.
30"D both sides corner desk, with beam extended right	48"	60"	24-30"	AD C45 DB () ()	3,067.	3,585.	4,085.
	48"	72"	24-30"	AD C46 DB () ()	3,194.	3,738.	4,288.
	48"	84"	24-30"	AD C47 DB () ()	3,322.	3,905.	4,479.

Order Code	Specification Information	Application Notes
Example: AD C46 SB 117 117 G	<i>Specify desk shape:</i>	Desks with service beam have power distribution capability, separate lay-in wire management, and sockets for privacy screens. Pin-set worksurface can be installed at 24"- 30" high, in 1" increments. Beam provides privacy screen support, modular power distribution, lay-in cable distribution, and modesty to 14" above floor level. Service beams can be linked for continuous power/data distribution through adjacent desks and credenzas with service beams. Extended corner desks provide computer corner plus adjacent work area in one unit. Nominal worksurface depths include 1 3/4" cable/connector space along back edges. Desks may be specified with fixed front glides and rear casters or levelling glides with 1 3/4" travel. Corner desk beams have four openings for Knoll PDC modules. Specify power distribution components separately. Desks accept clamp-on workshelves.
AD Desk	C Corner	
C Shape	<i>Width left, width right:</i>	
4 Width left	3 36"	
6 Width right	4 48"	
S Depth	5 60"	
B Base type	6 72"	
117 Desktop finish	7 84"	
117 Desk base finish	<i>Worksurface depth:</i>	
G Glides	S 24"D both sides L 30"D left, 24"D right R 30"D right, 24"D left D 30"D both sides	
	<i>Base type:</i>	
	B Adjustable with beam	
	<i>Specify desk top and base finish.</i>	
	<i>Specify:</i>	
	C Rear casters	
	G Glides	
	Worksurface edges are trim grey.	

Desks with service beam
pin-set adjustable
corner desk

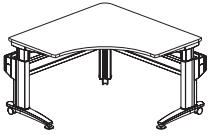
description	w(l)	w(r)	h	pattern no.	lam.	V2	V3
24"D both sides corner desk with beam 	42"	42"	24-30"	AD C4242 SB () ()	\$2,458.	\$2,744.	\$3,032.
	48"	48"	24-30"	AD C44 SB () ()	2,468.	2,785.	3,106.
	60"	60"	24-30"	AD C55 SB () ()	2,698.	n/a	n/a
30"D left/24"D right corner desk with beam	42"	42"	24-30"	AD C4242 LB () ()	2,496.	2,782.	3,070.
	48"	48"	24-30"	AD C44 LB () ()	2,507.	2,824.	3,145.
	60"	60"	24-30"	AD C55 LB () ()	2,735.	n/a	n/a
24"D left/30"D right corner desk with beam	42"	42"	24-30"	AD C4242 RB () ()	2,496.	2,782.	3,070.
	48"	48"	24-30"	AD C44 RB () ()	2,507.	2,824.	3,145.
	60"	60"	24-30"	AD C55 RB () ()	2,735.	n/a	n/a
30"D both sides corner desk with beam	42"	42"	24-30"	AD C4242 DB () ()	2,534.	2,820.	3,109.
	48"	48"	24-30"	AD C44 DB () ()	2,670.	2,863.	3,184.
	60"	60"	24-30"	AD C55 DB () ()	2,775.	n/a	n/a

Order Code	Specification Information	Application Notes
Example: AD C44 SB 117 117 G	<i>Specify desk shape:</i>	<i>Specify:</i>
AD Desk	C Corner	C Rear casters
C Shape	<i>Width left, width right:</i>	G Glides
4 Width left	4 48"	Worksurface edges are trim grey.
4 Width right	5 60"	Clear Maple is not available on 60"W x 60"D corner desks.
S Depth	<i>Worksurface depth:</i>	Desks with service beam have power distribution capability, separate lay-in wire management, and sockets for privacy screens. Pin-set worksurface can be installed at 24"- 30" high, in 1" increments.
B Base type	S 24"D both sides	Beam provides excess cord storage, continuous power and lay-in cable distribution, privacy screen support, and modesty to 14" above floor level. Service beams can be linked for continuous power/data distribution through adjacent desks and credenzas with service beams.
117 Desktop finish	L 30"D left, 24"D right	Nominal worksurface depths include 1 3/4" cable/connector space at back edge.
117 Desk base finish	R 30"D right, 24"D left	Desks may be specified with fixed front glides and rear casters or levelling glides with 1 3/4" travel.
G Glides	D 30"D both sides	Corner desk beams have four openings for Knoll PDC modules. Specify power distribution components separately.
	<i>Base type:</i>	Desks accept clamp-on workshelves.
	B Adjustable with beam	
	<i>Specify desk top and base finish.</i>	

Desks with service beam
pin-set adjustable
straight desk

Currents

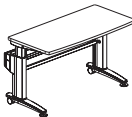
description	w(l)	w(r)	h	pattern no.	lam.	V2	V3
 24"D straight desk, curved front	36"	24"	24-30"	AD S36 SB () ()	\$1,394.	\$1,545.	\$1,700.
	42"	24"	24-30"	AD S42 SB () ()	1,440.	1,605.	1,772.
	48"	24"	24-30"	AD S48 SB () ()	1,482.	1,661.	1,841.
	60"	24"	24-30"	AD S60 SB () ()	1,572.	1,777.	1,982.
	72"	24"	24-30"	AD S72 SB () ()	1,661.	1,892.	2,121.
	84"	24"	24-30"	AD S84 SB () ()	1,849.	2,106.	2,360.
30"D straight desk, curved front	36"	30"	24-30"	AD S36 DB () ()	1,507.	1,681.	1,855.
	42"	30"	24-30"	AD S42 DB () ()	1,554.	1,739.	1,924.
	48"	30"	24-30"	AD S48 DB () ()	1,599.	1,795.	1,994.
	60"	30"	24-30"	AD S60 DB () ()	1,700.	1,930.	2,162.
	72"	30"	24-30"	AD S72 DB () ()	1,816.	2,084.	2,351.

Order Code	Specification Information	Application Notes
Example: AD S72 DB 117 117 G	<i>Specify desk shape:</i>	Desks with service beam have power distribution capability, separate lay-in wire management, and sockets for privacy screens. Pin-set worksurface can be installed at 24" - 30" high, in 1" increments. Beam provides excess cord storage, continuous power and lay-in cable distribution, privacy screen support, and modesty to 14" above floor level. Service beams can be linked for continuous power/data distribution through adjacent desks and credenzas with service beams. Straight desks have slightly curved front edge, to a minimum of 1" extra depth at center. Nominal worksurface depths include 1 3/4" cable/connector space at back edge. Desks may be specified with fixed front glides and rear casters or levelling glides with 1 3/4" travel. Straight desk beams have two openings for Knoll PDC modules. Specify power distribution components separately. Desks accept clamp-on workshelves.
AD Desk	S Straight	
S Shape	<i>For straight desks specify:</i>	
72 Width	<i>Width:</i>	
D Depth	36 36"	
B Base type	42 42"	
117 Desktop finish	48 48"	
117 Desk base finish	60 60"	
G Glides	72 72"	
	84 84"	
	<i>Worksurface depth:</i>	
	S 24"D	
	D 30"D	
	<i>Base type:</i>	
	B Adjustable with beam	
	<i>Specify desk top and base finish.</i>	
	<i>Specify:</i>	
	C Rear casters	
	G Glides	
	Worksurface edges are trim grey.	

Desks with service beam
handcrank-adjustable
extended left

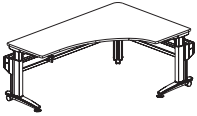
description	w(l)	w(r)	h	pattern no.	lam.	V2	V3
 24"D both sides corner desk, extended left	60"	36"	24-34"	AD C53 SA () ()	\$3,363.	\$3,680.	\$4,002.
	60"	48"	24-34"	AD C54 SA () ()	3,529.	3,912.	4,295.
	72"	36"	24-34"	AD C63 SA () ()	3,529.	3,912.	4,295.
	72"	48"	24-34"	AD C64 SA () ()	3,696.	4,142.	4,589.
	84"	48"	24-34"	AD C74 SA () ()	4,014.	4,524.	5,037.
30"D left/24"D right corner desk, extended left	60"	48"	24-34"	AD C54 LA () ()	3,631.	4,046.	4,462.
	72"	48"	24-34"	AD C64 LA () ()	3,797.	4,277.	4,757.
	84"	48"	24-34"	AD C74 LA () ()	4,116.	4,660.	5,204.
30"D both sides corner desk, extended left	60"	48"	24-34"	AD C54 DA () ()	3,745.	4,161.	4,574.
	72"	48"	24-34"	AD C64 DA () ()	3,924.	4,402.	4,882.
	84"	48"	24-34"	AD C74 DA () ()	4,116.	4,660.	5,204.

Order Code	Specification Information	Application Notes
Example: AD C64 SA 117 117 C	<i>Specify desk shape:</i>	<i>Specify:</i>
AD Desk	C Corner	C Rear casters
C Shape	<i>Width left, width right:</i>	G Glides
6 Width left	3 36"	Worksurface edges are trim grey.
4 Width right	4 48"	
S Depth	5 60"	Handcrank adjustable desk adjusts continuously from 24-34"H with collapsible crank under front edge. Handcrank is located on the extended side of extended corner desks.
A Base type	6 72"	
117 Desktop finish	7 84"	
117 Base finish	<i>Worksurface depth:</i>	Beam provides privacy screen support, modular power distribution, lay-in cable power distribution, and modesty to 14" above floor level. Service beams can be linked for continuous power/data distribution through adjacent desks and credenzas with service beams.
C Casters	S 24"D both sides	
	D 30"D both sides	Extended corner desks provide computer corner plus adjacent work area in one unit. Nominal worksurface depths include 1 3/4" cable/connector space along back edges.
	L 30"D left, 24"D right	Desks may be specified on fixed front glides and rear casters or 2 1/4" adjustable levelling glides with 1 3/4" travel.
	R 30"D right, 24"D left	Corner desk beams have four openings for Knoll PDC modules.
	<i>Base type:</i>	Handcrank mechanism is rated at 300 lbs. maximum weight.
	A Handcrank adjustable with beam	
	<i>Specify desk top and base finish.</i>	

Desks with service beam
handcrank-adjustable
extended right

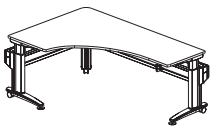
description	w(l)	w(r)	h	pattern no.	lam.	V2	V3
 24"D both sides corner desk, extended right	36"	60"	24-34"	AD C35 SA () ()	\$3,363.	\$3,680.	\$4,002.
	36"	72"	24-34"	AD C36 SA () ()	3,529.	3,912.	4,295.
	48"	60"	24-34"	AD C45 SA () ()	3,529.	3,912.	4,295.
	48"	72"	24-34"	AD C46 SA () ()	3,696.	4,142.	4,589.
	48"	84"	24-34"	AD C47 SA () ()	4,014.	4,524.	5,037.
30"D right/24"D left corner desk, extended right	48"	60"	24-34"	AD C45 RA () ()	3,631.	4,046.	4,462.
	48"	72"	24-34"	AD C46 RA () ()	3,797.	4,277.	4,757.
	48"	84"	24-34"	AD C47 RA () ()	4,116.	4,660.	5,204.
30"D both sides corner desk, extended right	48"	60"	24-34"	AD C45 DA () ()	3,745.	4,161.	4,574.
	48"	72"	24-34"	AD C46 DA () ()	3,924.	4,402.	4,882.
	48"	84"	24-34"	AD C47 DA () ()	4,116.	4,660.	5,204.

Order Code	Specification Information	Application Notes
Example: AD C46 SA 117 117 C	<i>Specify desk shape:</i>	<i>Specify:</i>
AD Desk	C Corner	
C Shape	<i>Width left, width right:</i>	G Glides
4 Width left	3 36"	Worksurface edges are trim grey.
6 Width right	4 48"	
S Depth	5 60"	Handcrank adjustable desk adjusts continuously from 24-34"H with collapsible crank under front edge. Handcrank is located on the extended side of extended corner desks.
A Base type	6 72"	
117 Desktop finish	7 84"	
117 Base finish	<i>Worksurface depth:</i>	Handcrank desks with service beam are mobile, adjustable desks with integral wire management, power distribution capability, and privacy screen inserts.
C Casters	S 24"D both sides	
	D 30"D both sides	
	L 30"D left, 24"D right	
	R 30"D right, 24"D left	Handcrank adjustable desk adjusts continuously from 24-34"H with collapsible crank under front edge. Handcrank is located on the extended side of extended corner desks.
	<i>Base type:</i>	
	A Handcrank adjustable with beam	Beam provides privacy screen support, modular power distribution, lay-in cable power distribution, and modesty to 14" above floor level. Service beams can be linked for continuous power/data distribution through adjacent desks and credenzas with service beams.
	<i>Specify desk top and base finish.</i>	
		Extended corner desks provide computer corner plus adjacent work area in one unit. Nominal worksurface depths include 1 3/4" cable/connector space along back edges.
		Desks may be specified on fixed front glides and rear casters or 2 1/4" adjustable levelling glides with 1 3/4" travel.
		Corner desk beams have four openings for Knoll PDC modules.
		Handcrank mechanism is rated at 300 lbs. maximum weight.

Desks with service beam
handcrank-adjustable
corner desk

description	w(l)	w(r)	h	pattern no.	lam.	V2	V3
 24"D both sides corner desk	42"	42"	24-34"	AD C4242 SA () ()	\$3,352.	\$3,614.	\$3,927.
	48"	48"	24-34"	AD C44 SA () ()	3,363.	3,680.	4,002.
	60"	60"	24-34"	AD C55 SA () ()	3,592.	n/a	n/a
30"D left/24"D right corner desk	42"	42"	24-34"	AD C4242 LA () ()	3,392.	3,677.	3,966.
	48"	48"	24-34"	AD C44 LA () ()	3,400.	3,719.	4,040.
	60"	60"	24-34"	AD C55 LA () ()	3,631.	n/a	n/a
24"D left/30"D right corner desk	42"	42"	24-34"	AD C4242 RA () ()	3,392.	3,677.	3,966.
	48"	48"	24-34"	AD C44 RA () ()	3,400.	3,719.	4,040.
	60"	60"	24-34"	AD C55 RA () ()	3,631.	n/a	n/a
30"D both side corner desk	48"	48"	24-34"	AD C44 DA () ()	3,438.	3,758.	4,078.
	60"	60"	24-34"	AD C55 DA () ()	3,670.	n/a	n/a

Order Code	Specification Information	Application Notes
Example: AD C44 SA 117 117 C AD Desk C Shape 4 Width left 4 Width right S Depth A Base type 117 Desktop finish 117 Base finish C Casters	<i>Specify desk shape:</i> C Corner <i>Width left, width right:</i> 4 48" 5 60" <i>Worksurface depth:</i> S 24"D both sides D 30"D both sides L 30"D left, 24"D right R 30"D right, 24"D left <i>Base type:</i> A Handcrank adjustable with beam <i>Specify handcrank left or right side of desk:</i> L left R right <i>Specify desk top and base finish.</i>	<i>Casters/no casters:</i> C Rear casters G Glides Worksurface edges are trim grey. Clear Maple is not available on 60"W x 60"D corner desks. Handcrank desks with service beam are mobile, adjustable desks with integral wire management, power distribution capability, and privacy screen inserts. Handcrank adjustable base adjusts continuously from 24-34"H with collapsible crank under front edge. Beam provides excess cord storage, continuous power and lay-in cable distribution, privacy screen support, and modesty to 14" above floor level. Service beams can be linked for continuous power/data distribution through adjacent desks and credenzas with service beams. Nominal worksurface depths include 1 3/4" cable/connector space at back edge. Desks may be specified on fixed front glides and rear casters or 2 1/4" adjustable levelling glides with 1 3/4" travel. Corner desk beams have four openings for Knoll PDC modules. Handcrank mechanism is rated at 300 lbs. maximum weight.

Desks with service beam
handcrank-adjustable
straight desk

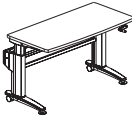
description	w(l)	w(r)	h	pattern no.	lam.	V2	V3
 24"D straight desk, curved front	36"	24"	24-34"	AD S36 SA () ()	\$2,032.	\$2,186.	\$2,340.
	42"	24"	24-34"	AD S42 SA () ()	2,079.	2,243.	2,410.
	48"	24"	24-34"	AD S48 SA () ()	2,121.	2,301.	2,480.
	60"	24"	24-34"	AD S60 SA () ()	2,210.	2,415.	2,620.
	72"	24"	24-34"	AD S72 SA () ()	2,301.	2,480.	2,761.
	84"	24"	24-34"	AD S84 SA () ()	2,488.	2,744.	3,001.
30"D straight desk, curved front	36"	30"	24-34"	AD S36 DA () ()	2,147.	2,320.	2,494.
	42"	30"	24-34"	AD S42 DA () ()	2,193.	2,377.	2,563.
	48"	30"	24-34"	AD S48 DA () ()	2,237.	2,435.	2,634.
	60"	30"	24-34"	AD S60 DA () ()	2,340.	2,569.	2,802.
	72"	30"	24-34"	AD S72 DA () ()	2,454.	2,723.	2,990.

Order Code

Example:	AD S60 SA 117 117 C
AD	Desk
S	Shape
60	Width
S	Depth
A	Base type
117	Desktop finish
117	Base finish
C	Casters

Specification Information

Specify desk shape:
S Straight

For straight desks specify:
Width:
36 36"
42 42"
48 48"
60 60"
72 72"
84 84"

Worksurface depth:
S 24"D
D 30"D

Base type:
A Handcrank adjustable with beam

Specify desk top and base finish.

Application Notes

Casters/no casters:
C Rear casters
G Glides
Worksurface edges are trim grey.

Handcrank desks with service beam are mobile, adjustable desks with integral wire management, power distribution capability, and privacy screen inserts.

Handcrank adjustable base adjusts continuously from 24-34"H with collapsible crank under front edge. Handcrank may be installed on the left or right side of any straight or symmetrical corner desk.

Beam provides excess cord storage, continuous power and lay-in cable distribution, privacy screen support, and modesty to 14" above floor level. Service beams can be linked for continuous power/data distribution through adjacent desks and credenzas with service beams.

Straight desks have slightly curved front edge, to a minimum of 1" extra depth at center. Nominal worksurface depths include 1 3/4" cable/connector space at back edge.

Desks may be specified on fixed front glides and rear casters or 2 1/4" adjustable levelling glides with 1 3/4" travel.

Straight desk beams have two openings for Knoll PDC modules.

Handcrank mechanism is rated at 300 lbs. maximum weight.

Basic credenzas *lamine top*

description	type	w	d	h	pattern no.	lam./P1/P2	lam./P3
Basic credenza with laminate top two file drawers	casters	24"	24"	28"	AC 24 C 2 C () ()	\$1,880.	\$1,975.
	casters	30"	24"	28"	AC 30 C 2 C () ()	2,077.	2,181.
	glides	24"	24"	28"	AC 24 C 2 G () ()	1,818.	1,910.
	glides	30"	24"	28"	AC 30 C 2 G () ()	2,016.	2,117.

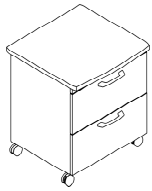

Order Code

Example: **AC 30 C2C 117 117 117**

AC	Currents credenza
30	Width
C	Basic credenza
2	2 drawer
C	Caster
117	Top finish
117	Case finish
117	Front finish

Specification Information

Specify finish for top, case and front.

Application Notes

Basic credenzas are freestanding storage assemblies with or without top, 24" or 30" wide.

They may be specified on casters or glides.

All units accept clamp-on workshelf.

Grommeted openings on back and at the bottom allow cable feeds.

Basic credenzas

veneer top

Currents

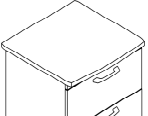
description	type	w	d	h	pattern no.	P1/P2 front	P3 front	V2 front	V3 front
	casters	24"	24"	28"	AC 24 C 2 C () ()	\$2,004.	\$2,104.	\$2,311.	n/a
		30"	24"	28"	AC 30 C 2 C () ()	2,202.	2,311.	2,532.	n/a
	glides	24"	24"	28"	AC 24 C 2 G () ()	1,942.	2,038.	2,237.	n/a
		30"	24"	28"	AC 30 C 2 G () ()	2,139.	2,244.	2,471.	n/a

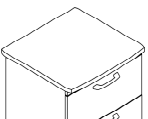
	casters	24"	24"	28"	AC 24 C 2 C () ()	2,126.	2,233.	n/a	2,667.
		30"	24"	28"	AC 30 C 2 C () ()	2,323.	2,439.	n/a	2,914.
	glides	24"	24"	28"	AC 24 C 2 G () ()	2,064.	2,169.	n/a	2,582.
		30"	24"	28"	AC 30 C 2 G () ()	2,262.	2,375.	n/a	2,828.

Order Code

Example:	AC 30 C2C 4 117 117
AC	Currents credenza
30	Width
C	Basic credenza
2	2 file drawers
C	Casters
4	Top finish
117	Case finish
117	Fronts finish

Specification Information

Specify Credenza top, case and front finish.

Application Notes

Basic credenzas are freestanding storage assemblies, 24" or 30" wide.

They may be specified on casters or glides.

All units accept clamp-on workshelf.

Grommeted opening on back and at the bottom allow cable feeds.

Basic credenzas

open top

Currents

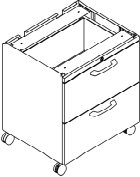
description	type	w	d	h	pattern no.	P1/P2 front	P3 front	V2 front	V3 front
	casters	24"	24"	28"	AC 24 C 2 C N () ()	\$1,758.	\$1,846.	\$2,064.	\$2,667.
		30"	24"	28"	AC 30 C 2 C N () ()	1,955.	2,053.	2,287.	2,914.
	glides	24"	24"	28"	AC 24 C 2 G N () ()	1,695.	1,782.	1,992.	2,582.
		30"	24"	28"	AC 30 C 2 G N () ()	1,893.	1,987.	2,226.	2,828.

Order Code

Example:	AC 30 C2C N 117 117
AC	Currents credenza
30	Width
C	Basic credenza
2	2 file drawers
C	Casters
N	Open top
117	Case finish
117	Fronts finish

Specification Information

Specify Credenza case and front finish.

Application Notes

Basic credenzas are freestanding storage assemblies, 24" or 30" wide.

They may be specified on casters or glides.

All units accept clamp-on workshelf.

Grommeted opening on back and at the bottom allow cable feeds.

Credenzas

laminated top

description	width	depth	height	pattern number	L-P1/P2
Box/data/file/two file combination	36"	24"	28"	AC 3B 32 () () () ()	\$3,245.
	48"	24"	28"	AC 4B 32 () () () ()	3,649.



Two files/box/data/file combination	36"	24"	28"	AC 3B 23 () () () ()	3,245.
	48"	24"	28"	AC 4B 23 () () () ()	3,649.

All file drawers	36"	24"	28"	AC 3B 22 () () () ()	2,975.
	48"	24"	28"	AC 4B 22 () () () ()	3,381.



Enclosed shelves	36"	24"	28"	AC 3B 11 () () () ()	2,297.
	48"	24"	28"	AC 4B 11 () () () ()	2,569.

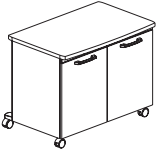

Order Code	Specification Information	Application Notes
Example: AC 3B 23 S 117 117 117 C	<i>Credenza configuration left, right:</i>	<i>Casters/no casters:</i>
AC Credenza	0 Open shelf 18"W	C Casters
3 Width	1 Door cabinet 18"W/24"W	G Glides
B Basic	2 2 file pedestal 18"/24"W	
23 Configuration	3 personal/data/file 18"W	
S Stanchions	<i>Specify:</i>	
117 Credenza top finish	S Stanchions for Reuter overhead storage	
117 Credenza case finish	N No stanchions	
117 Fronts finish	<i>Specify laminate top, case and front finish.</i>	
C Casters		

Credenzas are freestanding storage assemblies with top and overhead storage capability.

36" and 48" wide credenzas are available with four file drawers, 18" or 24" wide; with enclosed shelves, 18" or 24" wide; or with combination box/data/file and two file drawers, 18" wide box/data/file drawers and 18" wide or 30" wide file drawers. Combination box/data/file and two file drawers may be reversed left/right.

Credenza top slides forward to access 4"D cable feed/storage area inside case at rear. Grommeted openings on back and at the bottom allow power and cable feeds. Cable coil kit fits in cable storage area.

Top may be specified "S" for corner cutouts to accept stanchions for Reuter overhead storage (specified separately). All credenzas support workshelf.



Credenzas also accept service beams which support privacy screens, distribute power and data, and are linkable.

Credenzas may be specified on locking casters or glides with 1 3/4" travel.

Credenzas

veneer top

Currents

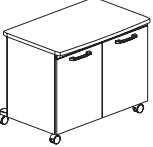
description	width	depth	height	pattern number	V2-P1/P2	V3-P1/P2	V2/V2	V3/V3
 Box/data/file/two file combination	36"	24"	28"	AC 3B 32 () () () ()	\$3,387.	\$3,529.	\$3,980.	\$4,420.
	48"	24"	28"	AC 4B 32 () () () ()	3,819.	3,989.	4,468.	4,962.
Two files/box/data/file combination	36"	24"	28"	AC 3B 23 () () () ()	3,387.	3,529.	3,980.	4,420.
	48"	24"	28"	AC 4B 23 () () () ()	3,819.	3,989.	4,468.	4,962.
 All file drawers	36"	24"	28"	AC 3B 22 () () () ()	3,116.	3,257.	3,685.	4,109.
	48"	24"	28"	AC 4B 22 () () () ()	3,550.	3,719.	4,090.	4,651.
 Enclosed shelves	36"	24"	28"	AC 3B 11 () () () ()	2,440.	2,583.	2,900.	3,273.
	48"	24"	28"	AC 4B 11 () () () ()	2,738.	2,907.	3,251.	3,676.

Order Code	Specification Information	Application Notes
Example: AC 3B 23 S 8 117 C C	<i>Credenza configuration left, right:</i>	<i>Casters/no casters:</i>
AC Credenza	0 Open shelf 18"W	
3 Width	1 Door cabinet 18"W/24"W	G Glides
B Basic	2 2 file pedestal 18"/24"W	
23 Configuration	3 personal/data/file 18"W	
S Stanchions	S Stanchions for Reuter overhead storage	
8 Credenza top finish	N No stanchions	
117 Credenza case finish	<i>Specify top, case and front finish.</i>	
C Fronts finish		
C Casters		

Credenzas are freestanding storage assemblies with top and overhead storage capability.

36" and 48" wide credenzas are available with four file drawers, 18" or 24" wide; with enclosed shelves, 18" or 24" wide; or with combination box/data/file and two file drawers, 18" wide box/data/file drawers and 18" wide or 30" wide file drawers. Combination box/data/file and two file drawers may be reversed left/right.

Credenza top slides forward to access 4"D cable feed/storage area inside case at rear. Grommeted openings on back and at the bottom allow power and cable feeds. Cable coil kit fits in cable storage area.

Top may be specified "S" for corner cutouts to accept stanchions for Reuter overhead storage (specified separately). All credenzas support workshelf.

Credenzas also accept service beams which support privacy screens, distribute power and data, and are linkable.

Credenzas may be specified on locking casters or glides with 1 3/4" travel.

Desk, credenzas and worktables

Credenzas with service beam laminated top

Currents

description	width	depth	height	pattern number	L-P1/P2
Box/data/file/2 files combination	36"	24"	28"	AC 3A 32 () () () ()	\$3,543.
	48"	24"	28"	AC 4A 32 () () () ()	4,002.
Two files/box/data/file combination	36"	24"	28"	AC 3A 23 () () () ()	3,543.
	48"	24"	28"	AC 4A 23 () () () ()	4,002.

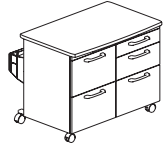

description	width	depth	height	pattern number	L-P1/P2
All file drawers	36"	24"	28"	AC 3A 22 () () () ()	3,273.
	48"	24"	28"	AC 4A 22 () () () ()	3,730.

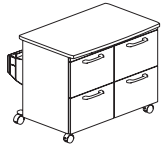

description	width	depth	height	pattern number	L-P1/P2
Enclosed shelves	36"	24"	28"	AC 3A 11 () () () ()	2,597.
	48"	24"	28"	AC 4A 11 () () () ()	2,921.

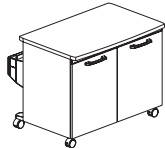

Order Code	Specification Information	Application Notes
Example: AC 3A 32N 117 117 117	<i>Credenza configuration left, right:</i>	<p>Credenzas with service beam are freestanding storage assemblies with top, integral wire management, privacy screen inserts and overhead storage capability.</p> <p>36" and 48" wide credenzas are available with four file drawers, 18" or 24" wide; with enclosed shelves, 18" or 24" wide; or with combination box/data/file and two file drawers, 18" wide box/data/file drawers and 18" wide or 30" wide file drawers. Combination box/data/file and two file drawers may be reversed left/right.</p> <p>Credenza top slides forward to access 4"D cable feed/storage area inside case at rear. Grommeted openings on back and at the bottom allow power and cable feeds. Cable coil kit fits in cable storage area.</p> <p>Credenza wireway beam may be linked to adjacent desk or credenza beams for continuous lay-in cable.</p> <p>All credenzas accept clamp-on workshelf.</p> <p>Top may be specified "S" for corner cutouts to accept stanchions for Reuter overhead storage (specified separately). All credenzas support workshelf.</p> <p>Credenzas may be specified on locking casters or glides with 1 3/4" travel.</p>
G	<i>Casters/no casters:</i>	
AC	0 Open shelf 18"W	
3	1 Door cabinet 18"W/24"W	
A	2 2 file pedestal 18"/24"W	
3	3 personal/data/file 18"W	
A	S Stanchions for Reuter overhead storage	
3	N No stanchions	
2	<i>Specify top, case and front finish.</i>	
N		
117		
117		
117		
G		

Credenzas with service beam veneer top

Currents

description	type	width	depth	height	pattern number	V2-P1/P2	V3-P1/P2	V2/V2	V3/V3
Box/data/file/2 files combination		36"	24"	28"	AC 3A 32 () () () ()	\$3,685.	\$3,826.	\$4,279.	\$4,720.
		48"	24"	28"	AC 4A 32 () () () ()	4,171.	4,339.	4,820.	5,313.
Two files/box/data/file combination		36"	24"	28"	AC 3A 23 () () () ()	3,685.	3,826.	4,279.	4,720.
		48"	24"	28"	AC 4A 23 () () () ()	4,171.	4,339.	4,820.	5,313.

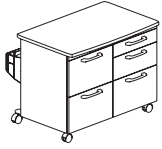

description	type	width	depth	height	pattern number	V2-P1/P2	V3-P1/P2	V2/V2	V3/V3
All file drawers		36"	24"	28"	AC 3A 22 () () () ()	3,413.	3,556.	3,980.	4,409.
		48"	24"	28"	AC 4A 22 () () () ()	3,901.	4,070.	4,442.	5,001.

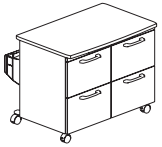

description	type	width	depth	height	pattern number	V2-P1/P2	V3-P1/P2	V2/V2	V3/V3
Enclosed shelves		36"	24"	28"	AC 3A 11 () () () ()	2,738.	2,879.	3,197.	3,568.
		48"	24"	28"	AC 4A 11 () () () ()	3,090.	3,257.	3,605.	4,028.

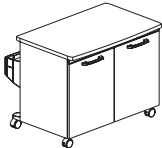

Order Code	Specification Information	Application Notes
Example: AC 3A 32N 8 117 C G	<i>Credenza configuration left, right:</i>	<p>Credenzas with service beam are freestanding storage assemblies with top, integral wire management, privacy screen inserts and overhead storage capability.</p> <p>36" and 48" wide credenzas are available with four file drawers, 18" or 24" wide; with enclosed shelves, 18" or 24" wide; or with combination box/data/file and two file drawers, 18" wide box/data/file drawers and 18" wide or 30" wide file drawers. Combination box/data/file and two file drawers may be reversed left/right.</p> <p>Credenza top slides forward to access 4"D cable feed/storage area inside case at rear. Grommeted openings on back and at the bottom allow power and cable feeds. Cable coil kit fits in cable storage area.</p> <p>Credenza wireway beam may be linked to adjacent desk or credenza beams for continuous lay-in cable.</p> <p>All credenzas accept clamp-on workshelf.</p> <p>Top may be specified "S" for corner cutouts to accept stanchions for Reuter overhead storage (specified separately). All credenzas support workshelf.</p> <p>Credenzas may be specified on locking casters or glides with 1 3/4" travel.</p>
AC Credenza	0 Open shelf 18"W	
3 Width	1 Door cabinet 18"W/24"W	
A Service beam	2 2 file pedestal 18"/24"W	
3 Configuration left	3 personal/data/file 18"W	
2 Configuration right	S Stanchions for Reuter overhead storage	
N No stanchions	N No stanchions	
8 Credenza top finish	<i>Specify top, case and front finish.</i>	
117 Credenza case finish		
C Fronts finish		
G Glides		
	<i>Casters/no casters:</i>	
	C Casters	
	G Glides	

Desk, credenzas and worktables

description	w	d	h	pattern no.	paint
Service beam, straight desk	36"	–	9"	AA1RW36()	\$351.
	42"	–	9"	AA1RW42()	376.
	48"	–	9"	AA1RW48()	403.
	60"	–	9"	AA1RW60()	452.
	72"	–	9"	AA1RW72()	502.
	84"	–	9"	AA1RW84()	561.
Service beam set for corner desk	36"	60"	9"	AA1RWC35()	827.
	36"	72"	9"	AA1RWC36()	879.
	42"	42"	9"	AA1RWC4242()	778.
	48"	48"	9"	AA1RWC44()	827.
	48"	60"	9"	AA1RWC45()	879.
	48"	72"	9"	AA1RWC46()	928.
	48"	84"	9"	AA1RWC47()	989.
	60"	36"	9"	AA1RWC53()	827.
	60"	48"	9"	AA1RWC54()	879.
	60"	60"	9"	AA1RWC55()	928.
	72"	36"	9"	AA1RWC63()	879.
	72"	48"	9"	AA1RWC64()	928.
	84"	48"	9"	AA1RWC74()	989.
Service beam, one side of corner desk (left)	36"	–	9"	AA1RWL36()	376.
	42"	–	9"	AA1RWL42()	403.
	48"	–	9"	AA1RWL48()	426.
	60"	–	9"	AA1RWL60()	476.
	72"	–	9"	AA1RWL72()	527.
	84"	–	9"	AA1RWL84()	578.
Service beam, one side of corner desk (right)	36"	–	9"	AA1RWR36()	376.
	42"	–	9"	AA1RWR42()	403.
	48"	–	9"	AA1RWR48()	426.
	60"	–	9"	AA1RWR60()	476.
	72"	–	9"	AA1RWR72()	527.
	84"	–	9"	AA1RWR84()	578.

Order Code

Example: AA1 RW48 117
AA1 Desk accessory
R Replacement
W Wireway
48 Width
117 Finish

Specification Information

For corner service beam sets “w” column indicates width of left side, “d” column indicates width of right side of desk.
Specify paint finish for service beams.

Application Notes

Service beams fit on to desks or credenzas to provide lay-in wire management, power and data network distribution, and modesty to 14" above floor. Service beams do not attach to fixed height C-legs.

Straight service beams are applicable on corresponding width straight C-leg desks.

Service beam corner sets include corner connector for continuous wireway under corner desks.

Service beams for one side of corner desk may be specified when other side is planned along service wall.

Retracting doors in end caps and corners allow lay-in cabling and power jumpers from desk-to-desk. Each beam has two openings for Knoll PDC modules; corner desk sets have four openings.

Ballast plate is required when adding service beam to 60" x 24" or 72" x 24" handcrank desk. Ballast plate attaches under worksurface.

description	w	d	h	pattern no.	paint
Replacement service beam corner	4"	4"	9"	AA1RWC()	\$126.
Credenza service beam	36"	3"	9"	AA1RW3C()	279.
	48"	3"	9"	AA1RW4C()	329.
Ballast plate for handcrank desks				AA1BP6	44.

Order Code

Example: AA1 RW48 117
AA1 Desk accessory
R Replacement
W Wireway
48 Width
117 Finish

Specification Information

For corner service beam sets “w” column indicates width of left side, “d” column indicates width of right side of desk.

Specify paint finish for service beams.

Application Notes

Service beams fit on to desks or credenzas to provide lay-in wire management, power and data network distribution, and modesty to 14" above floor. Service beams do not attach to fixed height C-legs.

Straight service beams are applicable on corresponding width straight C-leg desks.

Service beam corner sets include corner connector for continuous wireway under corner desks.

Service beams for one side of corner desk may be specified when other side is planned along service wall.

Retracting doors in end caps and corners allow lay-in cabling and power jumpers from desk-to-desk. Each beam has two openings for Knoll PDC modules; corner desk sets have four openings.

Ballast plate is required when adding service beam to 60" x 24" or 72" x 24" handcrank desk. Ballast plate attaches under worksurface.

Power, data and communications components for desks and credenzas

Currents

2 + 2 Raceway

outlet module, linking bracket, jumper cable

description	type	w	pattern no.	paint
Outlet module for desk service beam	2 outlets	12"	AR1 DEM2 ()	\$244.
	4 outlets	24"	AR1 DEM4 ()	327.
Desk-to-desk/credenza linking bracket			AA1DD()	47.
Desk to wall linking bracket			AA1DW()	164.
Jumper cable	12" wall/36" desk	37"	AR1 EJ1	82.
	24" wall/48" desk	49"	AR1 EJ2	108.
	36" wall/60" desk	61"	AR1 EJ3	123.
	48" wall/84" desk	73"	AR1 EJ4	135.
	60" wall/84" desk	85"	AR1 EJ5	150.
	72" wall/96" desk	97"	AR1 EJ6	164.
	108" desk	109"	AR1 EJ7	177.
	96" wall/120" desk	121"	AR1 EJ8	190.
	120" wall/144" desk	145"	AR1 EJ10	217.

Order Code

Example: AR1 EJ5
AR1 Raceway
E 2+2, eight wire
J Jumpers
5 Width

Specification Information

Raceway components distribute four 20-amp circuits in desk and credenza service beams: two convenience circuits and two protected circuits with heavy grounds and heavy-duty #10 neutrals.

For outlet module specify paint finish.

Application Notes

Knoll 2+2, four circuit power components mount in desk beams and in credenza stanchions. Powered desks and credenzas must be specified with glides (not casters) and linking brackets.

Desk outlet module mounts in center of beam, in lower tray. Module accepts two or four duplex outlets plus two jumper cables at each end. Duplex outlets snap into outlet modules. Four outlet module fits nominal beam lengths of 60" or larger.

Desk-to-desk linking bracket links any beam ends or corners, universal for all joint conditions. Desk-to-wall linking bracket connects between wall attachment zone and beam end or corner.

Jumper cables connect power from outlet module to outlet module. Specify actual length between outlet modules.

Power, data and communications components for desks and credenzas

2 + 2 Raceway outlets, infeeds, cord tray

description	type	w	d	h	pattern no.	black	orange (-0) or orange triangle (-T)	black/orange	paint
Duplex outlet	Circuit A				AR1 DA	\$34.			
	Circuit B				AR1 DB	34.			
	Circuit X				AR1 DX	34.	39.		
	Circuit Y				AR1 DY	34.	39.		
Power infeeds	Hardwire infeed				AR1 DEHI()				273.
	Modular infeed				AR1 DEPI				205.
Credenza stanchion outlet (includes outlets)					AR1 OHS ()	205.		218.	
Auxiliary cord tray		20"	2"	6"	AR1 CB				114.

Order Code	Specification Information	Application Notes
Example: AR1 DEPI	Raceway components distribute four 20-amp circuits in desk and credenza service beams: two convenience circuits and two protected circuits with heavy grounds and heavy-duty #10 neutrals. <i>For outlet module specify paint finish.</i> <i>For stanchion outlet specify:</i> N All black outlet faces NO Black A/B and orange X/Y	Modular infeed is 7' liquidtight flexible conduit with pigtails on one end and modular jumper plug on other end. Hardwire infeed is field-wirable junction box which fastens to beam and has modular jumper and plug. Credenza stanchion outlet includes two duplex outlets, with one outlet accessing each of circuits A, B, X, and Y. Outlet housings have flexible conduit leadout, terminated by a dual modular connector which accepts jumpers. Auxiliary cord tray attaches beneath stiffener under desk or panel-mounted worksurface to accommodate transformers or a bundle of cables. U.L. does not permit outlet strip in auxiliary cord tray.
AR1 Raceway		
DEPI Infeed type		

Power, data and communications components for desks and credenzas

*3 + 3 Raceway
outlet, linking bracket, jumper cable*

description	type	w	d	h	pattern no.	no finish/paint
Outlet module for desk service beam	36", 42", 48" beam	12"			AR1 DTM2 ()	\$286.
	60", 72", 84" beam	24"			AR1 DTM4 ()	375.
Desk to wall linking bracket					AA1DW()	164.
Jumper cable	12" wall/36" desk	37"			AR1 TJ1	95.
	24" wall/48" desk	49"			AR1 TJ2	123.
	36" wall/60" desk	61"			AR1 TJ3	150.
	48" wall/72" desk	73"			AR1 TJ4	164.
	60" wall/84" desk	85"			AR1 TJ5	177.
	72" wall/96" desk	97"			AR1 TJ6	190.
	108" desk	109"			AR1 TJ7	217.
	96" wall/120" desk	121"			AR1 TJ8	217.
	120" wall/144" desk	145"			AR1 TJ10	244.
	Desk-to-desk/credenza linking bracket				AA1DD()	47.

Order Code	Specification Information	Application Notes
Example: AR1 DTM4 117		
AR1 Raceway	Raceway components distribute four 20-amp circuits in desk and credenza service beams: three convenience circuits and three protected circuits with heavy grounds and heavy-duty #10 neutrals. <i>For outlet module specify paint finish.</i> <i>For stanchion outlet specify:</i> N Black outlet faces NO Black A/B and orange X/Y	Knoll 3+3, six circuit power components mount in desk beams and in credenza stanchions. Powered desks and credenzas must be specified with glides (not casters) and linking brackets. Desk outlet module mounts in center of beam, in lower tray. Module accepts two or four duplex outlets plus two jumper cables at each end. Duplex outlets snap into outlet module. Four outlet module fits nominal beam lengths of 60" or larger. Jumper cables connect power from outlet module to outlet module. Specify actual length between outlet modules.
DT 3+3, desk		
M Outlet module		
4 Four outlets		
117 Finish		

Power, data and communications components for desks and credenzas

3 + 3 Raceway outlets, infeeds, cord tray

description	type	w	d	h	pattern no.	black	orange (-0) or orange triangle (-T)	black/ orange	no finish/ paint
Duplex outlet	Circuit A				AR1 DA	\$34.			
	Circuit B				AR1 DB	34.			
	Circuit C				AR1 DC	34.			
	Circuit X				AR1 DX	34.	39.		
	Circuit Y				AR1 DY	34.	39.		
	Circuit Z				AR1 DZ	34.	39.		
	Power infeeds	Hardwire base infeed				AR1 DTH()			
Modular infeed					AR1 DTPI				232.
Credenza stanchion outlet (includes outlets)					AR1 OHS ()	205.		218.	
Auxiliary cord tray		20"	2"	6"	AR1 CB				114.

Order Code

Example:	AR1 DTPI
AR1	Raceway
DTPI	Infeed type

Specification Information

Raceway components distribute four 20-amp circuits in desk and credenza service beams: three convenience circuits and three protected circuits with heavy grounds and heavy-duty #10 neutrals.

For outlet module specify paint finish.

For stanchion outlet specify:

- N Black outlet faces
- NO Black A/B and orange X/Y

Application Notes

Modular infeed is 7' liquidtight flexible conduit with pigtails on one end and modular jumper plug on other end. Hardwire infeed is field-wirable junction box which fastens to beam and has modular jumper end.

Credenza stanchion outlet includes two duplex outlets, with one outlet accessing each of circuits A, B, X, and Y. Outlet housings have flexible conduit leadout, terminated by a dual modular connector which accepts jumpers. Auxiliary cord tray attaches beneath stiffener under desk or panel-mounted worksurface to accommodate transformers or a bundle of cables. U.L. does not permit outlet strip in auxiliary cord tray.

Above-desk storage and lighting for desks and credenzas *workshelf and T5 task light*

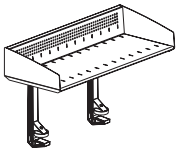
description	type	w	d	h	pattern no.	paint	Standard	Advanced
		21"	13"	6"	AA1WS24()	\$479.		
		27"	13"	6"	AA1WS30()	504.		
		33"	13"	6"	AA1WS36()	531.		
		45"	13"	6"	AA1WS48()	570.		
Workshelf dividers (set of 5)					AA1WSD()	132.		
Task Light	Used with 24" and wider workshelf	19"	4"	1 1/2"	AA2T5E19()		150.	n/a
	Used with 30" and wider workshelf	25"	4"	1 1/2"	AA2T5E25()		190.	371.
	Used with 48" and wider workshelf	37"	4"	1 1/2"	AA2T5E37()		212.	406.

Order Code	Specification Information	Application Notes								
<p>Example: AA1 WS24 117</p> <table style="width: 100%; border-collapse: collapse;"> <tr> <td style="border-bottom: 1px solid black;">AA1</td> <td style="border-bottom: 1px solid black;">Accessory</td> </tr> <tr> <td style="border-bottom: 1px solid black;">WS</td> <td style="border-bottom: 1px solid black;">Workshelf</td> </tr> <tr> <td style="border-bottom: 1px solid black;">24</td> <td style="border-bottom: 1px solid black;">Width</td> </tr> <tr> <td style="border-bottom: 1px solid black;">117</td> <td style="border-bottom: 1px solid black;">Finish</td> </tr> </table>	AA1	Accessory	WS	Workshelf	24	Width	117	Finish	<p><i>Specify painted finishes for workshelf and dividers.</i></p> <p><i>Specify:</i></p> <p>Width - Task Lights mount in cabinets and shelves at least 6" wider than light width.</p> <p>Type:</p> <p>S Standard A Advanced</p> <p>Specify suffix -CH and add \$45 list for City of Chicago installations. Example: AA2T5E19S-CH</p> <p>All housings are black.</p>	<p>Workshelf mounts anywhere along back of desk or credenza, independent of privacy screens. Workshelf includes uprights and clamps for Currents, Equity, or Morrison 1 1/4" worksurfaces.</p> <p>Task lights mount into the recess in the underside of overhead cabinets and shelves at least 6" wider than task light width.</p> <p>Task lights include T5 cool white (4100K) fluorescent lamp, electronic ballast, 9' grounded corset, prismatic lens, rocker switch, one cord exit management clip and mounting hardware.</p> <p>Task light cordset is center exit. On smaller units cord exit is off-center, but still not handed.</p> <p>Task lights are TCLP compliant and meet requirements of California Title 24.</p> <p>Advanced task lights are fitted with ballast and lamp compliant with LEED requirements.</p>
AA1	Accessory									
WS	Workshelf									
24	Width									
117	Finish									

Privacy screens for desks and credenzas

perforated steel

Currents

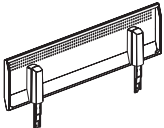
description	w	d	h	pattern no.	perforated
	36"	1"	9"	AZ1 0936H ()	\$301.
	42"	1"	9"	AZ1 0942H ()	315.
	48"	1"	9"	AZ1 0948H ()	325.
	60"	1"	9"	AZ1 0960H ()	351.
	72"	1"	9"	AZ1 0972H ()	376.

Order Code	Specification Information	Application Notes
Example: AZ1 0936 H 117	<i>Privacy screen surface types:</i>	Privacy screens plug into corresponding width service beam at back edge of desks and credenzas.
AZ1 Privacy screen	H Perforated (9" only)	
09 Height	Specify painted finish for perforated screens and screen brackets.	Screens to 30"H are painted finish, perforated steel, to conceal cable clutter from desktop equipment to service beam. Higher screens are tackable/acoustical upholstered surface on both sides.
36 Width		Screens include brackets to mount to desk or credenza with service beams of corresponding width. Two 36"W screens may be specified for 72"W desks.
H Surface		One 48"W screen can also be planned at either end of 72" straight or corner beam.
117 Bracket finish		Screens may be shared between desks in back-to-back configurations.

Desk, credenzas and worktables

Privacy screens for desks and credenzas upholstered

Currents



description	w	d	h	pattern no.	10	15	20	30	35	40	45	50	55
	36"	1 3/8"	18"	AZ1 1836F () ()	\$436.	\$452.	\$466.	\$495.	\$512.	\$527.	\$541.	\$572.	\$608.
	42"	1 3/8"	18"	AZ1 1842F () ()	459.	476.	493.	529.	545.	565.	581.	613.	649.
	48"	1 3/8"	18"	AZ1 1848F () ()	482.	502.	521.	562.	581.	600.	622.	652.	689.
	60"	1 3/8"	18"	AZ1 1860F () ()	577.	600.	626.	678.	702.	728.	752.	793.	844.
	72"	1 3/8"	18"	AZ1 1872F () ()	n/a	682.	n/a	n/a	n/a	n/a	n/a	n/a	n/a

description	w	d	h	pattern no.	10	15	20	30	35	40	45	50	55
	36"	1 3/8"	27"	AZ1 2736F () ()	544.	565.	583.	621.	640.	658.	678.	720.	759.
	42"	1 3/8"	27"	AZ1 2742F () ()	577.	595.	624.	661.	683.	706.	728.	768.	801.
	48"	1 3/8"	27"	AZ1 2748F () ()	600.	626.	652.	702.	728.	752.	777.	817.	847.
	60"	1 3/8"	27"	AZ1 2760F () ()	720.	752.	785.	847.	879.	908.	940.	991.	1,054.
	72"	1 3/8"	27"	AZ1 2772F () ()	n/a	852.	n/a	n/a	n/a	n/a	n/a	n/a	n/a

Order Code	Specification Information	Application Notes
Example: AZ1 1848 F15 117	<i>Privacy screen surface types:</i>	Edges of privacy screens are trim grey.
AZ1 Privacy screen	H Perforated (9" only)	
18 Height	<i>Specify finish:</i>	Screens to 30"H are painted finish, perforated steel, to conceal cable clutter from desktop equipment to service beam. Higher screens are tackable/acoustical upholstered surface on both sides.
48 Width	F Tackable fabric (18" or 27"H)	
F Surface	<i>Specify fabric group:</i>	Screens include brackets to mount to desk or credenza with service beams of corresponding width. Two 36"W screens may be specified for 72"W desks.
15 Fabric group	10 Fabric group 10	
117 Bracket finish	15 Fabric group 15	
	20 Fabric group 20	
	30 Fabric group 30	
	35 Fabric group 35	
	40 Fabric group 40	
	45 Fabric group 45	
	50 Fabric group 50	One 48"W screen can also be planned at either end of 72" straight or corner beam.
	55 Fabric group 55	
		Screens may be shared between desks in back-to-back configurations.

Privacy screens for desks and credenzas *windows and connectors*

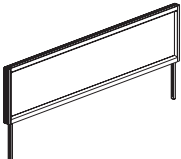
Currents

description	width	depth	height	pattern number	list price
 Windows	36"	1"	9"	AZ1 U0936T ()	\$301.
	42"	1"	9"	AZ1 U0942T ()	332.
	48"	1"	9"	AZ1 U0948T ()	364.
	60"	1"	9"	AZ1 U0960T ()	439.
Straight privacy screen connectors	–	–	–	AZ1 CS	27.
 Corner privacy screen connectors	1"	–	18"	AZ1 CL18 ()	50.
	1"	–	27"	AZ1 CL27 ()	63.
	1"	–	36"	AZ1 CL36 ()	76.

Order Code

Example:	AZ1 U0948T 117
AZ1	Privacy screen
U	Window
09	Height
48	Width
T	Surface finish
117	Frame finish

Specification Information

Specify painted finish for window frame and corner connectors.

Windows are translucent acrylic.
Ends of windows are trim grey.

Application Notes

Windows attach to top of any same-width upholstered privacy screen to add enclosure to a desk or credenza.

Windows on 18"H screens align with 27"H screens, 48" above floor. Windows on 27"H screens add-up to 57" above floor.

Screen connectors align adjacent screens (or screens with windows) in clusters of desks and credenzas. Corner connectors include vertical trim to fill corner.

Specify two corner connectors for a three-way T-connection.

Specify three corner connectors for a four-way X-connection

Desk and credenza accessories

stanchions, file supports and data tray cover



Currents

description	type	w	d	h	pattern no.	black	paint
Credenza stanchions	outlets cover for stanchions to 39"				AA1RSOC11()		\$63.
	outlets cover for stanchions to 48"				AA1RSOC20()		63.
	stanchions to 39"H	4"	9"	11"	AA1RS11()		557.
	stanchions to 48"H	4"	9"	20"	AA1RS20()		632.
Data tray cover set, desk or credenza		36"			AA1DT36()		83.
		42"			AA1DT42()		88.
		48"			AA1DT48()		95.
		60"			AA1DT60()		100.
		72"			AA1DT72()		107.
		84"			AA1DT84()		116.
File supports		18"	-	-	AC1 FS18	40.	
		24"	-	-	AC1 FS24	40.	
		30"	-	-	AC1 FS30	40.	
Outlet fillers (Set of 10)				AR OF	30.		

Order Code	Specification Information	Application Notes
Example: AA1 DT36 117	<i>Specify painted finish for data tray cover set, desk, or credenza.</i>	Credenza stanchions mount Reuter shelf or overhead to credenza of the same width. Specify credenza with stanchion cutouts, and storage. Stanchion cutouts allow credenza top to be pulled forward for access to cable storage in beam.
AA1 Accessory		
DT Data tray cover set		
36 Width		
117 Finish		
	Top of Reuter overhead on stanchions to 48"H is at 63". Top of overhead on stanchions to 39"H is at 54".	Metal data tray covers set into top of service beam to protect data network cables.
	Outlets cover for stanchions has openings for two duplex power outlets and two PDC modules. Specify outlets filler for unused openings.	Data tray cover sets fit straight desk beam or one side of corresponding width corner desk.
		Basic credenzas are compact, freestanding storage assemblies components with top and overhead storage capability. Basic credenzas include two full width file drawers.

Worktables

personal, tripod, wiper

description	type	w	d	h	pattern no.	lam.	V2	V3
 Personal worktable	Adjustable	36"	28"	24-30"	AT1 P36A () ()	\$1,254.	\$1,468.	\$1,679.
	Fixed height	36"	28"	28"	AT1 P36F () ()	1,066.	1,279.	1,494.
 Tripod worktable	Adjustable	36"	36"	24-30"	AT1 TA () ()	1,536.	1,749.	1,961.
	Fixed height (low)	36"	36"	26"	AT1 TL () () ()	1,066.	1,279.	1,494.
 Small wiper	Adjustable	47"	30"	24-30"	AT1 W24A () () ()	1,693.	1,907.	2,120.
	Fixed height	47"	30"	28"	AT1 W24F () () ()	1,066.	1,279.	1,494.

Order Code	Specification Information	Application Notes
Example: AT1 W24F 117 117 C	F Fixed height	Worktables are independent, mobile tables designed for use with desks, credenzas and panel-mounted worksurfaces.
AT1 Table	A Adjustable height	
W Shape	<i>Specify top and base finish.</i>	Personal worktable is rounded rectangle shape, sized to fit within small workstations. Personal worktable has center column, four-star base for clear knee space support.
24 Depth		
F Base type		Tripod is rounded triangle shape designed to roll under Currents 48" corner desks set at 28"H.
117 Desktop finish		
117 Base finish		Small wiper and half wiper are conference extensions for 24"D worksurfaces. Medium wiper corresponds to 30"D worksurfaces.
C Casters		

Specify:

- C Casters
- G Glides

Fixed height tables are 28"H except Tripod, 26"H. Adjustable height worktables adjust 24"-30"H in one-inch increments. Glides adjust 1 3/4". All casters are lockable. Worktable top edge is trim grey.

Worktables

personal, tripod, wiper

description	type	w	d	h	pattern no.	lam.	V2	V3
Medium wiper	Adjustable	54"	30"	24-30"	AT1 W30A () ()	\$1,754.	\$1,982.	\$2,207.
	Fixed height	54"	30"	28"	AT1 W30F () ()	1,128.	1,354.	1,580.



Half wiper end table	Left, adjustable	33"	36"	24-30"	AT1 E24LA () ()	1,693.	1,907.	2,120.
	Left, fixed height	33"	36"	28"	AT1 E24LF () ()	1,066.	1,279.	1,494.
	Right, adjustable	33"	36"	24-30"	AT1 E24RA () ()	1,693.	1,907.	2,120.
	Right, fixed height	33"	36"	28"	AT1 E24RF () ()	1,066.	1,279.	1,494.



right

Order Code	Specification Information	Application Notes
Example: AT1 W24F 117 117 C	F Fixed height	Worktables are independent, mobile tables designed for use with desks, credenzas and panel-mounted worksurfaces.
AT1 Table	A Adjustable height	
W Shape	<i>Specify top and base finish.</i>	Personal worktable is rounded rectangle shape, sized to fit within small workstations. Personal worktable has center column, four-star base for clear knee space support.
24 Depth		
F Base type		Tripod is rounded triangle shape designed to roll under Currents 48" corner desks set at 28"H.
117 Desktop finish		
117 Base finish		Small wiper and half wiper are conference extensions for 24"D worksurfaces. Medium wiper corresponds to 30"D worksurfaces.
C Casters		

Specify:





- C Casters
- G Glides

Fixed height tables are 28"H except Tripod, 26"H. Adjustable height worktables adjust 24"-30"H in one-inch increments. Glides adjust 1 3/4". All casters are lockable. Worktable top edge is trim grey.

Wiper and half wiper tables have four legs with integral wire-manager channels.

Worktables

half-round, large wiper, round

description	type	w	d	h	pattern no.	lam.	V2	V3
Half round worktable 	Adjustable	50"	28"	24-30"	AT1 D50A () ()	\$1,443.	\$1,693.	\$1,944.
	Fixed height	50"	28"	28"	AT1 D50F () ()	1,254.	1,505.	1,754.
Large half round worktable 	Adjustable	62"	30"	24-30"	AT1 D62A () ()	1,881.	2,132.	2,382.
	Fixed height	62"	30"	28"	AT1 D62F () ()	1,254.	1,505.	1,754.
Large wiper end table 	Adjustable	72"	32"	24-30"	AT1 W50A () ()	1,881.	2,132.	2,382.
	Fixed height	72"	32"	28"	AT1 W50F () ()	1,254.	1,505.	1,754.
Round worktable 	Adjustable	42"		24-30"	AT1 R42A () ()	1,754.	1,982.	2,207.
	Adjustable	48"		24-30"	AT1 R48A () ()	1,820.	2,056.	2,296.
	Fixed height	42"		28"	AT1 R42F () ()	1,128.	1,354.	1,580.
	Fixed height	48"		28"	AT1 R48F () ()	1,192.	1,428.	1,668.

Order Code	Specification Information	Application Notes
Example: AT1 D50F 117 117 C	F Fixed height	<i>Specify:</i> C Casters G Glides
AT1 Table	A Adjustable height	
D Shape	<i>Specify top and base finish.</i>	Worktables are independent, mobile tables designed for use with desks, credenzas and panel-mounted worksurfaces. Half round worktable aligns with back-to-back 24"D Currents desks or worksurfaces plus a Currents screen or Knoll systems panel between. Large half round table aligns with back-to-back 30"D desks or worksurfaces. Large wiper is shared conference extension for back-to-back 24"D desks. All tables have center edge offset to clear panel end trim. Large half-round, round, and wiper tables have four legs with integral wire-manager channels. Half round worktable has center column, three-star base for clear knee space support.
50 Depth		
F Base type		
117 Desktop finish		
117 Base finish		
C Casters		

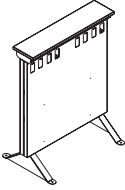
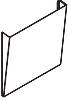
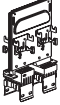
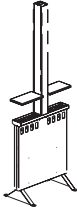
description	type	w	d	h	pattern no.	black	no finish	paint
Power monument		28"	5"	36"	AA1PM()			\$1,505.
								
Cable container (one side)		24"	2"	16"	AA1PMCC()			250.
								
Power module, 2+2	2+2				AR1 EPM		142.	
	3+3				AR1 TPM		164.	
Outlet fillers (Set of 10)					AR OF	30.		
Hinged outlet flap (each)					APC OCF		25.	
Ceiling infeed top					AA1PMCIA()			125.
								

Order Code

Example: AA1 PM 117	
AA1	Accessory
PM	Power monument
117	Finish

Specification Information

Specify painted finish for power monument, cable containers or ceiling infeed top.

Application Notes

Power monument is floorstanding monument providing power and data/telecommunications outlets above worksurface height (36").

Power monument may be planned at the center of a group of worktables or C-leg desks in an active meeting area.

Power monument cable containers attach to each face of power monument for excess cable bundling below worksurface height (21"). Each face of power monument accepts one cable container.

Power monument provides four pairs of outlet openings on each side which may be duplex outlets, PDC modules or black fillers.

Power modules support one pair of duplex outlets each side. Specify up to four modules (eight duplexes each side).

For 2+2 power specify duplexes, **AR1 EPC1** power connectors between modules and **AR1 EPI5** infeed for floor feed, or **AR1 EPIC** for ceiling infeed (see page 52). For 3+3 power specify duplexes, **AR1 TPC1** connectors, **AR1 TPI5** or **AR1 TPIC**.

Hinged outlet flap covers two outlet openings; four flaps on each side of power monument cover all openings.

Ceiling infeed top replaces standard top for use with Currents ceiling infeed and infeed panel.

Upstart Tables

primary worksurfaces
table desks

Currents

type	application	w	d	h	pattern no.	list price
Y-shape table desk, curved end (left hand shown)	left	72"	28-36"	25-30"	AUP Y72DCL4 () () ()	\$827.
	right	72"	28-36"	25-30"	AUP Y72DCR4 () () ()	827.



M-shape table desk, curved ends		72"	30-36"	25-30"	AUP M72DC4 () () ()	827.
---------------------------------	--	-----	--------	--------	-------------------------------	------

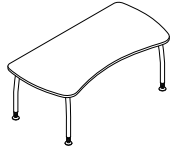

Y-shape table desk, flat ends	left	72"	28-36"	25-30"	AUP Y72DFL4 () () ()	827.
	right	72"	28-36"	25-30"	AUP Y72DFR4 () () ()	827.

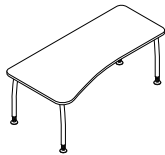

M-shape table desk, flat ends		72"	31-36"	25-30"	AUP M72DF4 () () ()	827.
-------------------------------	--	-----	--------	--------	-------------------------------	------

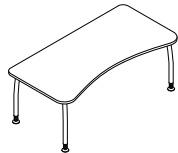

Order Code	Specification Information	Application Notes
Example: AUP Y72DCL4 117 117 117 G	Specify top, edge and leg finishes.	Upstart Y and M shape tables include a worksurface stiffener that doubles as a horizontal cable manager.
A Currents	<i>Casters/glides</i>	Upstart Y and M shape tables combine computer support and adjacent work area in a basic table desk.
UP Upstart	C Casters	Curved end tops facilitate conferencing in open planning. Flat ends plan close to system panels. Overall width is the same for curved and flat end tops.
Y Table shape	G Glides	Upstart tops have plastic laminate surface with continuous T-mold edge.
72 Width		Upstart tables have four legs with 5" adjustable leveler glides or 4" adjustable casters. Adjustment range is 25-30" for glides and 27-31" for casters.
D Depth		Adjustment range enables Upstart tables to overlap or slide under adjacent tables and worksurfaces.
C Curved end		
L Left hand		
4 Leg quantity		
117 Top finish		
117 Edge finish		
117 Leg finish		
G Glides		

Upstart Tables
primary worksurfaces
corner table desks

Currents

type	w	d	h	pattern no.	list price
Extended corner table desk, 90° extended left	72"	48"	25-30"	AUP C7248S5 () () ()	\$946.

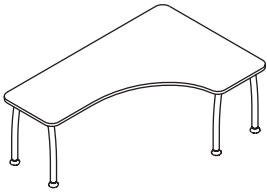

Extended corner table desk, 90° extended right	48"	72"	25-30"	AUP C4872S5 () () ()	946.
--	-----	-----	--------	--------------------------------	------

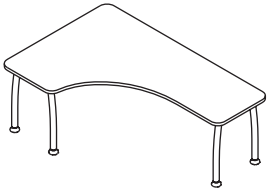

Corner table desk, 120°	48", 48"	22"	25-30"	AUP V48S5 () () ()	886.
-------------------------	----------	-----	--------	------------------------------	------



Order Code	Specification Information	Application Notes
Example: AUP C7248S5 117 117 117 C	Specify top, edge and leg finishes.	Upstart extended corner and corner shape tables include worksurface stiffeners that double as horizontal cable managers.
A Currents	<i>Casters/glides</i>	Upstart extended corner and corner shape tables combine computer support and adjacent work area in a basic table desk.
UP Upstart	C Casters	Upstart tops have plastic laminate surface with continuous T-mold edge.
C Table shape	G Glides	Upstart tables have four or five legs with 5" adjustable leveler glides or 4" adjustable casters. Adjustment range is 25-30" for glides and 27-31" for casters.
72 Width, extended left		Adjustment range enables Upstart tables to overlap or slide under adjacent worksurfaces.
48 Width		Extended corner table desks and 120° corner table desk are 22" deep on each side edge. Each back edge of 120° corner desk corresponds to 48" wide Currents linkable screens connected at a 120° angle.
S Depth		
4 Leg quantity		
117 Top finish		
117 Edge finish		
117 Leg finish		
C Casters		

Upstart Tables

secondary workspaces

Currents

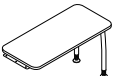
type	w	d	h	pattern no.	list price
 Rectangular table desk, four legs	48"	22"	25-30"	AUP S48S4 () () ()	\$531.
	48"	28"	25-30"	AUP S48D4 () () ()	591.
	60"	28"	25-30"	AUP S60D4 () () ()	650.
	72"	28"	25-30"	AUP S72D4 () () ()	680.
	72"	36"	25-30"	AUP S72E4 () () ()	710.
 Rectangular return, two legs	48"	22"	25-30"	AUP S48S2 () () G	414.





Order Code	Specification Information	Application Notes
Example: AUP S72E4 117 117 117 C	Specify top, edge and leg finishes.	Upstart rectangular and rectangular return include a worksurface stiffener that doubles as a horizontal cable manager.
A Currents	<i>Casters/glides</i>	Upstart tops have plastic laminate surface with continuous T-mold edge.
UP Upstart	C Casters	Upstart tables have four or five legs with 5" adjustable leveler glides or 4" adjustable casters. Adjustment range is 25-30" for glides and 27-31" for casters.
S Table shape	G Glides	Adjustment range enables Upstart tables to overlap or slide under adjacent workspaces.
72 Width		Rectangular return with two legs includes flat bracket for attachment to primary worksurface at right angle.
E Depth		
4 Leg quantity		
117 Top finish		
117 Edge finish		
117 Leg finish		
C Casters		

Upstart table desks and storage

Upstart Tables

conference worksurfaces

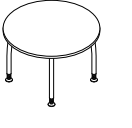
Currents



type	w	d	h	pattern no.	list price
Wiper table desk 	61"	32½"	25-30"	AUP W60D4 () () ()	\$650.
Oval table desk, four legs 	66"	36"	25-30"	AUP O664 () () ()	827.
Round table desk, four legs 	42"		25-30"	AUP R424 () () ()	616.
Half round table desk, four legs 	62"	30"	25-30"	AUP D624 () () ()	650.
Tripod table, three legs 	36"	36"	25-30"	AUP T363 () () ()	531.

Order Code	Specification Information	Application Notes
Example: AUP O664 117 117 117 G	Specify top, edge and leg finishes.	Upstart wiper, oval and half round tables include a worksurface stiffener that doubles as a horizontal cable manager.
A Currents	<i>Casters/glides</i>	Upstart conference table desks are designed to support conference work in combination with other worktables or systems furniture.
UP Upstart	C Casters	Upstart tops have plastic laminate surface with continuous T-mold edge.
O Table shape	G Glides	Upstart tables have four legs with 5" adjustable leveler glides or 4" adjustable casters. Adjustment range is 25-30" for glides and 27-31" for casters.
66 Size		Tops adjust in height to permit conference tops to overlap or roll under adjacent tables.
4 Leg quantity		Half round corresponds to back-to-back Y-shape tables or 30" deep straight tables.
117 Top finish		
117 Edge finish		
117 Leg finish		
G Glides		

Upstart Tables

curved leg only

Currents

description	h	pattern no.	Paint
Curved leg with glide 	23 ⁷ / ₈ " - 28 ⁷ / ₈ "	AUPCGV ()	\$82.
Curved leg with caster 	25 ⁷ / ₈ " - 29 ⁷ / ₈ "	AUPCCV ()	82.

Order Code	Specification Information	Application Notes
Example: AUPCC 114	Specify:	Each curved Upstart leg comes with four (4) metal inserts and four (4) screws.
A Currents	<i>Casters/glides</i>	Curved Upstart legs must be positioned in accordance with BIFMA guidelines.
UP Upstart	C Casters	
C Curved leg	G Glides	Upstart tables have four or five curved legs with 5" adjustable leveler glides or 4" adjustable casters. Adjustment range is 27" - 31" for casters and 25" - 30" for glides.
C Casters		
114 Leg finish	<i>Leg finishes, paint</i> See Color Program Page	

Upstart table desks and storage

Plannable Upstart Tables

Rectangular Table Desk

Currents

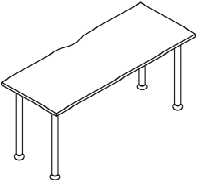
description	w	d	h	pattern no.	lam.	V2
	30"	23 5/8"	27 3/4" - 32 3/4"	AUPM S30S4 () G () () ()	\$424.	\$636.
	36"	23 5/8"	27 3/4" - 32 3/4"	AUPM S36S4 () G () () ()	447.	670.
	42"	23 5/8"	27 3/4" - 32 3/4"	AUPM S42S4 () G () () ()	473.	708.
	48"	23 5/8"	27 3/4" - 32 3/4"	AUPM S48S4 () G () () ()	496.	744.
	54"	23 5/8"	27 3/4" - 32 3/4"	AUPM S54S4 () G () () ()	519.	779.
	60"	23 5/8"	27 3/4" - 32 3/4"	AUPM S60S4 () G () () ()	544.	815.
	66"	23 5/8"	27 3/4" - 32 3/4"	AUPM S66S4 () G () () ()	569.	853.
	72"	23 5/8"	27 3/4" - 32 3/4"	AUPM S72S4 () G () () ()	593.	889.
84"	23 5/8"	27 3/4" - 32 3/4"	AUPM S84S4 () G () () ()	641.	960.	

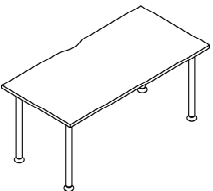
	30"	29 5/8"	27 3/4" - 32 3/4"	AUPM S30D4 () G () () ()	479.	718.
	36"	29 5/8"	27 3/4" - 32 3/4"	AUPM S36D4 () G () () ()	504.	755.
	42"	29 5/8"	27 3/4" - 32 3/4"	AUPM S42D4 () G () () ()	528.	792.
	48"	29 5/8"	27 3/4" - 32 3/4"	AUPM S48D4 () () () ()	551.	826.
	54"	29 5/8"	27 3/4" - 32 3/4"	AUPM S54D4 () () () ()	581.	871.
	60"	29 5/8"	27 3/4" - 32 3/4"	AUPM S60D4 () () () ()	606.	908.
	66"	29 5/8"	27 3/4" - 32 3/4"	AUPM S66D4 () () () ()	619.	929.
	72"	29 5/8"	27 3/4" - 32 3/4"	AUPM S72D4 () () () ()	633.	949.
84"	29 5/8"	27 3/4" - 32 3/4"	AUPM S84D4 () () () ()	705.	1,057.	

Order Code	Specification Information	Application Notes
Example: AUPM S72S4 AG 118 114 114	Specify:	<i>Edge finishes, T-mold</i> See Color Program Page
A Currents	<i>Grommet/No grommet</i>	<i>Leg finishes, paint</i> See Color Program Page
UP Upstart	A Grommet	24" deep rectangular table desks can only be ordered with glides. 30" deep rectangular table desks in 30", 36" and 42" width can only be ordered with glides.
M Plannable	B No grommet	
S Table Shape	<i>Casters/glides</i>	Plannable Upstart tables have four or five straight legs with 5" adjustable leveler glides or 4" adjustable casters. Adjustment range is 27 3/4" - 31 3/4" for casters and 27 3/4" - 32 3/4" for glides.
72 Width	C Casters	
S Depth	G Glides	Rectangular return with two legs includes flat bracket for attachment to primary worksurfaces at right angle.
4 Leg quantity	<i>Top finish, plastic laminates</i> See Color Program Page	For Veneer Group 2, only black or trim grey edgebands can be specified.
A Grommet	<i>Veneer Goup 2</i> See Color Program Page	
G Glides	Veneer Group 2 worksurfaces are quartered Techgrain.	Plannable Upstart rectangular and rectangular return include a worksurface stiffener that doubles as a horizontal cable manager.
118 Top finish		Translucent orange, Translucent blue and Frosty white edgebands are not available on Plannable Upstart tables.
114 Edge finish		
114 Leg finish		

Plannable Upstart Tables

Rectangular Return

Currents

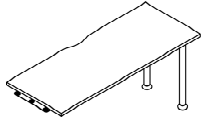
description	w	d	h	pattern no.	lam.	V2
	36"	23 ⁵ / ₈ "	27 ³ / ₄ " - 32 ³ / ₄ "	AUPM S36S2 () () () ()	\$337.	\$505.
	42"	23 ⁵ / ₈ "	27 ³ / ₄ " - 32 ³ / ₄ "	AUPM S42S2 () () () ()	363.	543.
	48"	23 ⁵ / ₈ "	27 ³ / ₄ " - 32 ³ / ₄ "	AUPM S48S2 () () () ()	385.	579.
	60"	23 ⁵ / ₈ "	27 ³ / ₄ " - 32 ³ / ₄ "	AUPM S60S2 () () () ()	466.	699.

Order Code	Specification Information	Application Notes
Example: AUPM S36S2 AC 118 114 114	Specify:	<i>Edge finishes, T-mold</i> See Color Program Page
A Currents	<i>Grommet/No grommet</i>	<i>Leg finishes, paint</i> See Color Program Page
UP Upstart	A Grommet	For Veneer Group 2, only black or trim grey edgebands can be specified.
M Plannable	B No grommet	
S Table Shape	<i>Casters/glides</i>	Translucent orange, Translucent blue and Frosty white edgebands are not available on Plannable Upstart tables.
36 Width	C Casters	
S Depth	G Glides	Plannable Upstart tops have flat fronts allowing 2 tables to meet at right angles.
2 Leg quantity	<i>Top finish, plastic laminates</i> See Color Program Page	
A Grommet	<i>Veneer Goup 2</i> See Color Program Page	Plannable Upstart tables have four or five straight legs with 5" adjustable leveler glides or 4" adjustable casters. Adjustment range is 27 ³ / ₄ " - 31 ³ / ₄ " for casters and 27 ³ / ₄ " - 32 ³ / ₄ " for glides.
C Casters	Veneer Group 2 worksurfaces are quartered Techgrain.	
118 Top finish		Rectangular return with two legs includes flat bracket for attachment to primary worksurfaces at right angle.
114 Edge finish		Plannable Upstart rectangular and rectangular return include a worksurface stiffener that doubles as a horizontal cable manager.
114 Leg finish		

Upstart table desks and storage

Plannable Upstart Tables

corner

Currents

description	w	d	h	pattern no.	lam.	V2
24" D both sides corner worksurfaces	42"	42"	27 ³ / ₄ " - 32 ³ / ₄ "	AUPM C4242S5 () () () ()	\$725.	\$1,088.
	48"	48"	27 ³ / ₄ " - 32 ³ / ₄ "	AUPM C4848S5 () () () ()	784.	1,176.
	60"	60"	27 ³ / ₄ " - 32 ³ / ₄ "	AUPM C6060S5 () C () () ()	1,023.	n/a

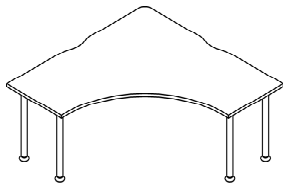

30" D both sides corner worksurfaces	42"	42"	27 ³ / ₄ " - 32 ³ / ₄ "	AUPM C4242D5 () () () ()	766.	1,149.
	48"	48"	27 ³ / ₄ " - 32 ³ / ₄ "	AUPM C4848D5 () () () ()	825.	1,238.
	60"	60"	27 ³ / ₄ " - 32 ³ / ₄ "	AUPM C6060D5 () C () () ()	1,064.	n/a

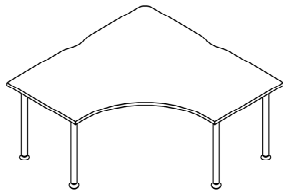

Order Code	Specification Information	Application Notes
Example: AUPM C4242S5 AC 118 114 114	Specify:	<i>Edge finishes, T-mold</i> See Color Program Page
A Currents	<i>Grommet/No grommet</i>	Plannable Upstart tops have flat fronts allowing 2 tables to meet at right angles.
UP Upstart	A Grommet	Plannable Upstart tables have four or five straight legs with 5" adjustable leveler glides or 4" adjustable casters. Adjustment range is 27 ³ / ₄ " - 31 ³ / ₄ " for casters and 27 ³ / ₄ " - 32 ³ / ₄ " for glides.
M Plannable	B No grommet	
C Table Shape	<i>Casters/glides</i>	Rectangular return with two legs includes flat bracket for attachment to primary worksurfaces at right angle.
4242 Width	C Casters	
S Depth	G Glides	Plannable Upstart corner and extended corner include worksurface stiffeners that double as horizontal cable managers.
5 Leg quantity	<i>Top finish, plastic laminates</i> See Color Program Page	
A Grommet	<i>Veneer Goup 2</i> See Color Program Page	
C Casters	Veneer Group 2 worksurfaces are quartered Techgrain.	
118 Top finish		
114 Edge finish		
114 Leg finish		

Plannable Upstart Tables

Currents

extended corner

extended left

description	w	d	h	pattern no.	lam.	V2
24" D both sides corner worksurface, extended left	60"	36"	27 ³ / ₄ " - 32 ³ / ₄ "	AUPM C6036S5 () () () ()	\$642.	\$962.
	60"	42"	27 ³ / ₄ " - 32 ³ / ₄ "	AUPM C6042S5 () () () ()	701.	1,052.
	60"	48"	27 ³ / ₄ " - 32 ³ / ₄ "	AUPM C6048S5 () C () () ()	761.	1,142.
	72"	36"	27 ³ / ₄ " - 32 ³ / ₄ "	AUPM C7236S5 () () () ()	761.	1,142.
	72"	42"	27 ³ / ₄ " - 32 ³ / ₄ "	AUPM C7242S5 () C () () ()	821.	1,231.
	72"	48"	27 ³ / ₄ " - 32 ³ / ₄ "	AUPM C7248S5 () C () () ()	881.	1,320.
	84"	48"	27 ³ / ₄ " - 32 ³ / ₄ "	AUPM C8448S5 () C () () ()	999.	1,499.

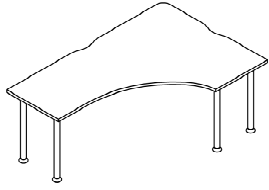

30" D both sides corner worksurface, extended left	60"	48"	27 ³ / ₄ " - 32 ³ / ₄ "	AUPM C6048D5 () C () () ()	822.	1,232.
	72"	48"	27 ³ / ₄ " - 32 ³ / ₄ "	AUPM C7248D5 () C () () ()	940.	1,411.
	84"	48"	27 ³ / ₄ " - 32 ³ / ₄ "	AUPM C8448D5 () C () () ()	1,060.	1,588.

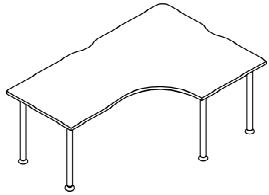

30" D left/24" D right corner worksurface, extended left	60"	42"	27 ³ / ₄ " - 32 ³ / ₄ "	AUPM C6042L5 () C () () ()	761.	1,142.
	60"	48"	27 ³ / ₄ " - 32 ³ / ₄ "	AUPM C6048L5 () C () () ()	822.	1,232.
	72"	42"	27 ³ / ₄ " - 32 ³ / ₄ "	AUPM C7242L5 () C () () ()	881.	1,320.
	72"	48"	27 ³ / ₄ " - 32 ³ / ₄ "	AUPM C7248L5 () C () () ()	940.	1,411.
	84"	48"	27 ³ / ₄ " - 32 ³ / ₄ "	AUPM C8448L5 () C () () ()	1,060.	1,588.

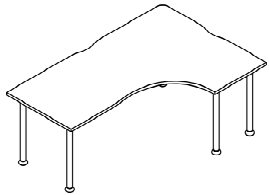

Order Code	Specification Information	Application Notes
Example: AUPM C7236S5 AC 118 114 114	Specify:	<i>Edge finishes, T-mold</i> See Color Program Page
A Currents	<i>Grommet/No grommet</i>	Plannable Upstart tops have flat fronts allowing 2 tables to meet at right angles.
UP Upstart	A Grommet	Plannable Upstart tables have four or five straight legs with 5" adjustable leveler glides or 4" adjustable casters. Adjustment range is 27 ³ / ₄ " - 31 ³ / ₄ " for casters and 27 ³ / ₄ " - 32 ³ / ₄ " for glides.
M Plannable	B No grommet	
C Table Shape	<i>Casters/glides</i>	Rectangular return with two legs includes flat bracket for attachment to primary worksurfaces at right angle.
7236 Width	C Casters	
S Depth	G Glides	Plannable Upstart corner and extended corner include worksurface stiffeners that double as horizontal cable managers.
5 Leg quantity	<i>Top finish, plastic laminates</i> See Color Program Page	
A Grommet	<i>Veneer Goup 2</i> See Color Program Page	
C Casters	Veneer Group 2 worksurfaces are quartered Techgrain.	
118 Top finish		
114 Edge finish		
114 Leg finish		

Upstart table desks and storage

Plannable Upstart Tables

extended corner

extended left

description	w	d	h	pattern no.	lam.	V2
24" D left/30" D right corner worksurface, extended left	60"	42"	27 ³ / ₄ " - 32 ³ / ₄ "	AUPM C6042R5 () C () ()	\$761.	\$1,142.
	60"	48"	27 ³ / ₄ " - 32 ³ / ₄ "	AUPM C6048R5 () C () ()	822.	1,232.
	72"	42"	27 ³ / ₄ " - 32 ³ / ₄ "	AUPM C7242R5 () C () ()	881.	1,320.
	72"	48"	27 ³ / ₄ " - 32 ³ / ₄ "	AUPM C7248R5 () C () ()	940.	1,411.
	84"	48"	27 ³ / ₄ " - 32 ³ / ₄ "	AUPM C8448R5 () C () ()	1,060.	1,588.

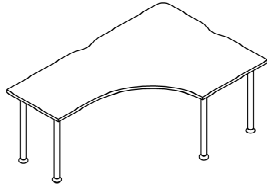

Order Code	Specification Information	Application Notes
Example: AUPM C7236S5 AC 118 114 114	Specify:	<i>Edge finishes, T-mold</i> See Color Program Page
A Currents	<i>Grommet/No grommet</i>	Plannable Upstart tops have flat fronts allowing 2 tables to meet at right angles.
UP Upstart	A Grommet	Plannable Upstart tables have four or five straight legs with 5" adjustable leveler glides or 4" adjustable casters. Adjustment range is 27 ³ / ₄ " - 31 ³ / ₄ " for casters and 27 ³ / ₄ " - 32 ³ / ₄ " for glides.
M Plannable	B No grommet	
C Table Shape	<i>Casters/glides</i>	Rectangular return with two legs includes flat bracket for attachment to primary worksurfaces at right angle.
7236 Width	C Casters	
S Depth	G Glides	Plannable Upstart corner and extended corner include worksurface stiffeners that double as horizontal cable managers.
5 Leg quantity	<i>Top finish, plastic laminates</i> See Color Program Page	
A Grommet	<i>Veneer Goup 2</i> See Color Program Page	
C Casters	Veneer Group 2 worksurfaces are quartered Techgrain.	
118 Top finish		
114 Edge finish		
114 Leg finish		

Plannable Upstart Tables

Currents

extended corner

extended right

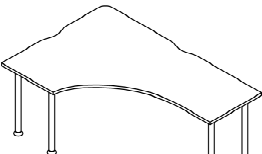
description	w	d	h	pattern no.	lam.	V2
24" D both sides corner worksurface, extended right 	36"	60"	27 ³ / ₄ " - 32 ³ / ₄ "	AUPM C3660S5 () () () ()	\$642.	\$962.
	36"	72"	27 ³ / ₄ " - 32 ³ / ₄ "	AUPM C3672S5 () () () ()	761.	1,142.
	42"	60"	27 ³ / ₄ " - 32 ³ / ₄ "	AUPM C4260S5 () () () ()	701.	1,052.
	42"	72"	27 ³ / ₄ " - 32 ³ / ₄ "	AUPM C4272S5 () C () () ()	821.	1,231.
	48"	60"	27 ³ / ₄ " - 32 ³ / ₄ "	AUPM C4860S5 () C () () ()	761.	1,142.
	48"	72"	27 ³ / ₄ " - 32 ³ / ₄ "	AUPM C4872S5 () C () () ()	881.	1,320.
	48"	84"	27 ³ / ₄ " - 32 ³ / ₄ "	AUPM C4884S5 () C () () ()	999.	1,499.

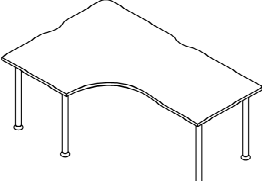
30" D both sides corner worksurface, extended right 	48"	60"	27 ³ / ₄ " - 32 ³ / ₄ "	AUPM C4860D5 () C () () ()	822.	1,232.
	48"	72"	27 ³ / ₄ " - 32 ³ / ₄ "	AUPM C4872D5 () C () () ()	940.	1,411.
	48"	84"	27 ³ / ₄ " - 32 ³ / ₄ "	AUPM C4884D5 () C () () ()	1,060.	1,588.

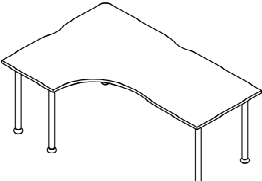
24" D left/30" D right corner worksurface, extended right 	42"	60"	27 ³ / ₄ " - 32 ³ / ₄ "	AUPM C4260R5 () C () () ()	761.	1,142.
	42"	72"	27 ³ / ₄ " - 32 ³ / ₄ "	AUPM C4272R5 () C () () ()	881.	1,320.
	48"	60"	27 ³ / ₄ " - 32 ³ / ₄ "	AUPM C4860R5 () C () () ()	822.	1,232.
	48"	72"	27 ³ / ₄ " - 32 ³ / ₄ "	AUPM C4872R5 () C () () ()	940.	1,411.
	48"	84"	27 ³ / ₄ " - 32 ³ / ₄ "	AUPM C4884R5 () C () () ()	1,060.	1,588.

Order Code	Specification Information
Example: AUPM C4872S5 AC 118 114 114	Specify:
A Currents	<i>Grommet/No grommet</i>
UP Upstart	A Grommet
M Plannable	B No grommet
C Table Shape	<i>Casters/glides</i>
4872 Width	C Casters
S Depth	G Glides
5 Leg quantity	<i>Top finish, plastic laminates</i>
A Grommet	See Color Program Page
C Casters	<i>Veneer Goup 2</i>
118 Top finish	See Color Program Page
114 Edge finish	Veneer Group 2 worksurfaces are quartered Techgrain.
114 Leg finish	

Order Code	Specification Information
Example: AUPM C4872S5 AC 118 114 114	Specify:
A Currents	<i>Grommet/No grommet</i>
UP Upstart	A Grommet
M Plannable	B No grommet
C Table Shape	<i>Casters/glides</i>
4872 Width	C Casters
S Depth	G Glides
5 Leg quantity	<i>Top finish, plastic laminates</i>
A Grommet	See Color Program Page
C Casters	<i>Veneer Goup 2</i>
118 Top finish	See Color Program Page
114 Edge finish	Veneer Group 2 worksurfaces are quartered Techgrain.
114 Leg finish	

Edge finishes, T-mold
See Color Program Page

Leg finishes, paint
See Color Program Page

For Veneer Group 2, only black or trim grey edgebands can be specified.

Translucent orange, Translucent blue and Frosty white edgebands are not available on Plannable Upstart tables.

Application Notes

Plannable Upstart tops have flat fronts allowing 2 tables to meet at right angles.

Plannable Upstart tables have four or five straight legs with 5" adjustable leveler glides or 4" adjustable casters. Adjustment range is 27³/₄" - 31³/₄" for casters and 27³/₄" - 32³/₄" for glides.

Rectangular return with two legs includes flat bracket for attachment to primary worksurfaces at right angle.

Plannable Upstart corner and extended corner include worksurface stiffeners that double as horizontal cable managers.

Upstart table desks and storage

Plannable Upstart Tables

extended corner

extended right

description	w	d	h	pattern no.	lam.	V2
30" D left/24" D right corner worksurface, extended right	42"	60"	27 ³ / ₄ " - 32 ³ / ₄ "	AUPM C4260L5 () C () () ()	\$761.	\$1,142.
	42"	72"	27 ³ / ₄ " - 32 ³ / ₄ "	AUPM C4272L5 () C () () ()	881.	1,320.
	48"	60"	27 ³ / ₄ " - 32 ³ / ₄ "	AUPM C4860L5 () C () () ()	822.	1,232.
	48"	72"	27 ³ / ₄ " - 32 ³ / ₄ "	AUPM C4872L5 () C () () ()	940.	1,411.
	48"	84"	27 ³ / ₄ " - 32 ³ / ₄ "	AUPM C4884L5 () C () () ()	1,060.	1,588.

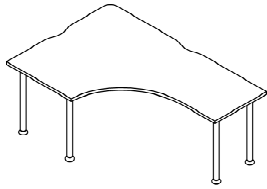

Order Code	Specification Information	Application Notes
Example: AUPM C4872S5 AC 118 114 114	Specify:	<i>Edge finishes, T-mold</i> See Color Program Page
A Currents	<i>Grommet/No grommet</i>	Plannable Upstart tops have flat fronts allowing 2 tables to meet at right angles.
UP Upstart	A Grommet	Plannable Upstart tables have four or five straight legs with 5" adjustable leveler glides or 4" adjustable casters. Adjustment range is 27 ³ / ₄ " - 31 ³ / ₄ " for casters and 27 ³ / ₄ " - 32 ³ / ₄ " for glides.
M Plannable	B No grommet	
C Table Shape	<i>Casters/glides</i>	Translucent orange, Translucent blue and Frosty white edgebands are not available on Plannable Upstart tables.
4872 Width	C Casters	
S Depth	G Glides	Rectangular return with two legs includes flat bracket for attachment to primary worksurfaces at right angle.
5 Leg quantity	<i>Top finish, plastic laminates</i> See Color Program Page	
A Grommet	<i>Veneer Goup 2</i> See Color Program Page	Plannable Upstart corner and extended corner include worksurface stiffeners that double as horizontal cable managers.
C Casters	Veneer Group 2 worksurfaces are quartered Techgrain.	
118 Top finish		
114 Edge finish		
114 Leg finish		

Plannable Upstart Tables half round and P-shapes

Currents

description	w	d	h	pattern no.	lam.	V2
Half round table desk, four legs	59"	30"	27 ³ / ₄ " - 32 ³ / ₄ "	AUPM D594 () G () ()	\$606.	\$908.
	60"	30"	27 ³ / ₄ " - 32 ³ / ₄ "	AUPM D604 () G () ()	606.	908.

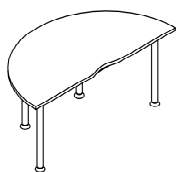

P-shape surface, extended right	48"	75"	27 ³ / ₄ " - 32 ³ / ₄ "	AUPM P4875S5 () C () ()	1,012.	1,519.
---------------------------------	-----	-----	---	-----------------------------------	--------	--------

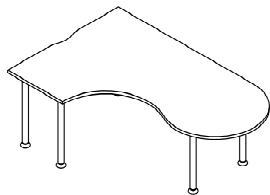

P-shape surface, extended left	75"	48"	27 ³ / ₄ " - 32 ³ / ₄ "	AUPM P7548S5 () C () ()	1,012.	1,519.
--------------------------------	-----	-----	---	-----------------------------------	--------	--------

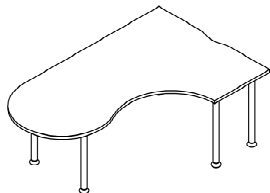

Order Code

Example:	AUPM P4875S5 AC 118 114 114
A	Currents
UP	Upstart
M	Plannable
P	Table Shape
4875	Width
S	Depth
5	Leg quantity
A	Grommet
C	Casters
118	Top finish
114	Edge finish
114	Leg finish

Specification Information

Specify:	
<i>Grommet/No grommet</i>	A Grommet B No grommet
<i>Casters/glides</i>	C Casters G Glides
<i>Top finish, plastic laminates</i>	See Color Program Page
<i>Veneer Goup 2</i>	See Color Program Page
Veneer Group 2 worksurfaces are quartered Techgrain.	

Edge finishes, T-mold
See Color Program Page

Leg finishes, paint
See Color Program Page

For Veneer Group 2, only black or trim grey edgebands can be specified.

Translucent orange, Translucent blue and Frosty white edgebands are not available on Plannable Upstart tables.

Application Notes

Plannable Upstart tops have flat fronts allowing 2 tables to meet at right angles.

Plannable Upstart tables have four or five straight legs with 5" adjustable leveler glides or 4" adjustable casters. Adjustment range is 27³/₄" - 31³/₄" for casters and 27³/₄" - 32³/₄" for glides.

Rectangular return with two legs includes flat bracket for attachment to primary worksurfaces at right angle.

Plannable Upstart half round and P-shape tables include worksurface stiffeners that double as horizontal cable managers.



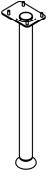
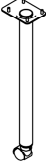

Upstart table desks and storage

Plannable Upstart Tables

straight leg only

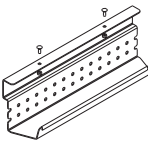
description	h	pattern no.	Paint
Straight leg with glide 	26 ⁵ / ₈ " - 31 ⁵ / ₈ "	AUPM SGV ()	\$82.
Straight leg with caster 	26 ⁵ / ₈ " - 30 ⁵ / ₈ "	AUPM SCV ()	82.

Order Code	Specification Information	Application Notes
Example: AUPM SC 114 A Currents UP Upstart M Plannable S Straight leg C Casters 114 Leg finish	Specify: <i>Casters/glides</i> C Casters G Glides <i>Leg finishes, paint</i> See Color Program Page	<p>Plannable Upstart straight leg may not be used with Original Upstart tables due to stability issues.</p> <p>Each straight Plannable Upstart leg comes with four (4) metal inserts and four (4) screws.</p> <p>Straight Plannable Upstart legs must be positioned in accordance with BIFMA guidelines.</p> <p>Plannable Upstart tables have four or five straight legs with 5" adjustable leveler glides or 4" adjustable casters. Adjustment range is 27³/₄" - 31³/₄" for casters and 27³/₄" - 32³/₄" for glides.</p>

type	w	d	h	pattern no.	list price
Flat bracket 	3 1/2"	14"		AB1 F24	\$30.
Cable tray 	20"	2"	6"	AR1 CB	114.
Carpet grips (set of 10) 				MM2-CG	18.
Non skid grips (set of 10) 				AA1NSK	31.
Pencil drawer 	12"	15 1/8"	3"	AUP PDU	107.

Order Code	Specification Information	Application Notes
Example: AA1-NSK		
A Currents	Flat bracket and cable tray are black, painted steel.	Flat bracket attaches return worksurface to primary worksurface at right angle.
A1 Accessory	Pencil drawer is integral color, light grey.	Cable tray attaches beneath stiffener under table surface to accommodate transformers or a bundle of cable.
NSK Non skid grips		Carpet grips snap into underside of Upstart leveling glides for traction on carpeted floors. Non-skid grips snap into leveling glides for traction on hard-surface floors. Pencil drawer attaches to the underside of a worksurface at any location.

Upstart Privacy Screens for Upstart tables

Currents

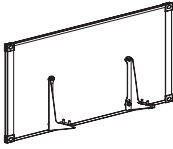
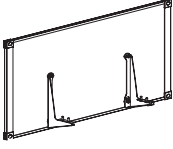
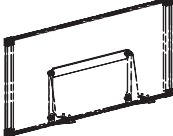
type	application	w	d	h	pattern no.	list price	
	Polycarbonate screen, back of table	36"	3/4"	24"	AUP B3624RC ()	\$402.	
		48"	3/4"	24"	AUP B4824RC ()	458.	
		60"	3/4"	24"	AUP B6024RC ()	528.	
		72"	3/4"	24"	AUP B7224RC ()	576.	
	Marker surface screen, back of table	36"	3/4"	24"	AUP B3624M ()	402.	
		48"	3/4"	24"	AUP B4824M ()	458.	
		60"	3/4"	24"	AUP B6024M ()	528.	
		72"	3/4"	24"	AUP B7224M ()	576.	
	Magnet rail	36" screen	18"	1/4"	2"	AUP MR36 ()	46.
		48" screen	30"	1/4"	2"	AUP MR48 ()	53.
		60" screen	36"	1/4"	2"	AUP MR60 ()	58.
		72" screen	48"	1/4"	2"	AUP MR72 ()	62.

Order Code

Example:	AUP B7224 RC 117
A	Currents
UP	Upstart
B	Back of worksurface
72	Width
24	Height
RC	Polycarbonate
117	Paint finish

Specification Information

Specify surface type and painted finish for screen frame, brackets and magnet rail.

Surface type:

RC Ribbed polycarbonate
M Marker Surface

Application Notes

Upstart screens mount on the back of Upstart tables to provide partial enclosure above and below worksurface height.

Screens have a translucent, ribbed polycarbonate or marker surface core. Perimeter frame is painted steel with trim grey molded corner blocks.

Screens include brackets that mount to matching holes under Upstart tables of the same width. Bracket holes are also provided for mounting two 36" wide screens on a 72" wide Upstart table.

Screen mounts in two positions, creating enclosure to a height of 39" or 48" when the table top is adjusted to 28".

Screens may be shared between desks in back to back configurations.

Magnet rails span between screen mounting brackets to hang paper documents.

Magnet rails correspond in width to privacy screens.

Please refer to Introduction page for table and screen dimensions.

Plannable Upstart Privacy Screens

back screens

Currents

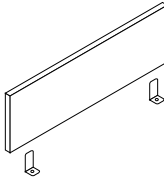
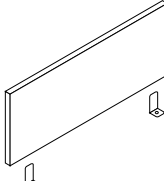
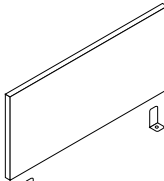
description	type	w	d	h	pattern no.	10	15	20	30	35	40	45
 Back of worksurface screens to 42"H		30"	3/4"	15"	MZ1-B3015-()	\$182.	\$206.	\$211.	\$231.	\$244.	\$260.	\$288.
		36"	3/4"	15"	MZ1-B3615-()	219.	237.	244.	268.	281.	295.	318.
		42"	3/4"	15"	MZ1-B4215-()	268.	281.	290.	319.	338.	347.	371.
		48"	3/4"	15"	MZ1-B4815-()	301.	313.	322.	354.	373.	396.	423.
		54"	3/4"	15"	MZ1-B5415-()	351.	363.	372.	411.	432.	449.	477.
		60"	3/4"	15"	MZ1-B6015-()	387.	394.	408.	447.	471.	500.	530.
		66"	3/4"	15"	MZ1-B6615-()	422.	425.	n/a	n/a	509.	n/a	n/a
		72"	3/4"	15"	MZ1-B7215-()	454.	471.	n/a	n/a	560.	n/a	n/a
	78"	3/4"	15"	MZ1-B7815-()	501.	517.	n/a	n/a	615.	n/a	n/a	
 Back of worksurface screens to overhead support height, 46"H		30"	3/4"	19"	MZ1-B3019-()	232.	251.	260.	284.	299.	311.	339.
		36"	3/4"	19"	MZ1-B3619-()	286.	300.	308.	340.	354.	364.	386.
		42"	3/4"	19"	MZ1-B4219-()	338.	346.	353.	392.	411.	432.	457.
		48"	3/4"	19"	MZ1-B4819-()	385.	393.	403.	444.	469.	513.	522.
		54"	3/4"	19"	MZ1-B5419-()	437.	440.	455.	501.	526.	537.	570.
		60"	3/4"	19"	MZ1-B6019-()	471.	485.	500.	551.	580.	586.	624.
		66"	3/4"	19"	MZ1-B6619-()	519.	531.	n/a	n/a	633.	n/a	n/a
		72"	3/4"	19"	MZ1-B7219-()	570.	581.	n/a	n/a	690.	n/a	n/a
	78"	3/4"	19"	MZ1-B7819-()	622.	630.	n/a	n/a	749.	n/a	n/a	
 Back of worksurface screens, to Reuter overhead support height, 49"H		30"	3/4"	22"	MZ1-B3022-()	284.	298.	306.	339.	353.	364.	387.
		36"	3/4"	22"	MZ1-B3622-()	350.	363.	372.	410.	431.	439.	455.
		42"	3/4"	22"	MZ1-B4222-()	403.	410.	423.	466.	488.	517.	542.
		48"	3/4"	22"	MZ1-B4822-()	471.	472.	487.	538.	565.	575.	625.
		54"	3/4"	22"	MZ1-B5422-()	518.	519.	538.	596.	625.	634.	668.
		60"	3/4"	22"	MZ1-B6022-()	551.	578.	596.	657.	690.	696.	721.
		66"	3/4"	22"	MZ1-B6622-()	617.	642.	n/a	n/a	761.	n/a	n/a
		72"	3/4"	22"	MZ1-B7222-()	688.	689.	n/a	n/a	818.	n/a	n/a
	78"	3/4"	22"	MZ1-B7822-()	739.	742.	n/a	n/a	882.	n/a	n/a	

Order Code	Specification Information	Application Notes
Example: MZ1-B6619-15-W210/2 MZ1 Morrison Network privacy screen B Back of worksurface 66 Width 19 Height 15 Surface type and group no. W210/2 Upholstery	<i>Surface type:</i> 10- Fabric group 10 15- Fabric group 15 20- Fabric group 20 30- Fabric group 30 35- Fabric group 35 40- Fabric group 40 45- Fabric group 45 * Morrison Network screens may be used with Plannable Upstart tables. Refer to front of Upstart price book for planning information.	Back of worksurface screens provide visual barrier and tackable surface from underside of worksurface to a height of 42", 46" or 49". Screen widths should correspond to straight worksurface width, or sum of VDT corner and return widths. Use back of worksurface screen for VDT applications where one side is backed by a vertical panel. VDT worksurfaces will accept back screens on only one back edge. Back screens may not be used at the end of a straight worksurface; use end screens in this application. Privacy screens are not available in a combination of fabrics. Back of worksurface screens are full dimension: two smaller screens may be substituted for a larger one. For example, if using fabric grades 20-70, specify two 36" screens for a 72" surface.
		Between back-to-back straight or VDT worksurfaces specify a single 3/4" back screen. This allows back-to-back 23 5/8"D or 29 5/8"D worksurfaces to plan on a precise 6" module. 15" high screens are used for a 42" horizon. 19"H screens are used to fill in space between worksurface and Morrison overhead. 22"H screens fill the space between worksurface and Reuter overhead. All but shared end screens start at the bottom of the worksurface. Privacy screens are supported by brackets fastened at worksurface inserts. Privacy screens include mounting brackets, insert kit, and stiffener clip. For replacement screen stiffeners see Accessories page. Privacy screens may be specified to achieve ASTM E-84 Class "A" flamespread rating.

Upstart table desks and storage

Plannable Upstart Privacy Screens

VDT screens

Currents

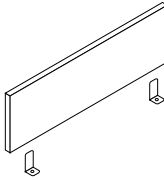
description	type	w	d	h	pattern no.	10	15	20	30	35	40	45
Back of VDT screens 	To 42"H	35 ⁵ / ₈ "	3/4"	15"	MZ1-V3615-()	\$219.	\$237.	\$244.	\$260.	\$268.	\$288.	\$318.
		41 ⁵ / ₈ "	3/4"	15"	MZ1-V4215-()	268.	281.	290.	311.	318.	339.	371.
		47 ⁵ / ₈ "	3/4"	15"	MZ1-V4815-()	301.	313.	322.	347.	363.	386.	423.
		59 ⁵ / ₈ "	3/4"	15"	MZ1-V6015-()	383.	396.	410.	438.	455.	484.	525.
		71 ⁵ / ₈ "	3/4"	15"	MZ1-V7215-()	463.	478.	n/a	n/a	548.	n/a	n/a
	To 46"H	35 ⁵ / ₈ "	3/4"	19"	MZ1-V3619-()	289.	299.	308.	328.	338.	352.	386.
		41 ⁵ / ₈ "	3/4"	19"	MZ1-V4219-()	338.	346.	353.	378.	394.	423.	457.
		47 ⁵ / ₈ "	3/4"	19"	MZ1-V4819-()	385.	394.	408.	434.	440.	472.	522.
		59 ⁵ / ₈ "	3/4"	19"	MZ1-V6019-()	481.	499.	516.	560.	583.	620.	672.
		71 ⁵ / ₈ "	3/4"	19"	MZ1-V7219-()	578.	602.	n/a	n/a	701.	n/a	n/a
	To 49"H	35 ⁵ / ₈ "	3/4"	22"	MZ1-V3622-()	350.	363.	372.	398.	402.	423.	455.
		41 ⁵ / ₈ "	3/4"	22"	MZ1-V4222-()	403.	410.	423.	444.	470.	507.	542.
		47 ⁵ / ₈ "	3/4"	22"	MZ1-V4822-()	471.	474.	489.	519.	520.	522.	625.
		59 ⁵ / ₈ "	3/4"	22"	MZ1-V6022-()	559.	580.	598.	650.	678.	719.	780.
		71 ⁵ / ₈ "	3/4"	22"	MZ1-V7222-()	668.	696.	n/a	n/a	815.	n/a	n/a

Order Code	Specification Information	Application Notes
Example: MZ1-V4822-15-W210/2	<i>Surface type:</i>	Privacy screens are supported by brackets fastened at worksurface inserts. Privacy screens include mounting brackets, insert kit and stiffener clip. 15" high screens are used for a 42" horizon. 19"H screens are used to fill in space between worksurface and desk mounted Morrison Network overheads. 22"H screens fill the space between worksurface and desk mounted Reuter overheads. Privacy screens may be specified to achieve ASTM E-84 Class "A" flamespread rating.
MZ1 Morrison Network privacy screen	10- Fabric group 10	
V VDT	15- Fabric group 15	
48 Width	20- Fabric group 20	
22 Height	30- Fabric group 30	
15 Surface type and group no.	35- Fabric group 35	
W210/2 Upholstery	40- Fabric group 40	
	45- Fabric group 45	
	VDT worksurfaces will not accept back screens on both back edges. Use VDT screens on at least one back edge.	
	VDT screens are not in pairs; specify one for each back edge or one VDT screen and one back screen.	

Upstart Storage cart

Currents

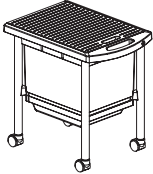
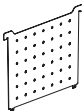
type	application	w	d	h	pattern no.	list price
	locking	16 1/4"	22 1/2"	23"	AUP C L ()	\$473.
	non locking	16 1/4"	22 1/2"	23"	AUP C ()	437.
	locking	16 1/4"	22 1/2"	23"	AUP C DL ()	520.
	non locking	16 1/4"	22 1/2"	23"	AUP C D ()	484.
Vertical divider					AUP VP3	77.
						

Order Code	Specification Information	Application Notes
Example: AUP CDLU		
A Currents		
UP Upstart		
C Cart		
D Drawer		
L Lock		
U Light grey		
	<p>Cart includes integral color file tub and top frame, with translucent polycarbonate receding top. Legs are natural anodized aluminum with non-locking casters. Personal drawer is integral color light grey with a concealed slide lock inside the tub.</p> <p>Divider is light grey, perforated painted steel.</p> <p><i>Integral color finish for file tub and top frame:</i></p> <p>U Light grey G1 Glider grey</p>	<p>Upstart cart combines filing and personal storage in an accessible, mobile unit designed to roll under Upstart tables. The cart is not intended to be a mobile seat.</p> <p>Cart includes letter width/legal depth file tub with translucent, receding top.</p> <p>File carts with drawer include 3" high personal storage drawer under files.</p> <p>File cart may be specified with lock.</p>

Upstart Storage tower

Currents

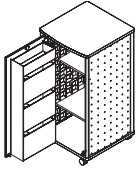
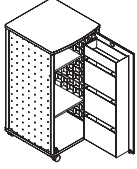
type	application	description	w	d	h	pattern no.	P1/P2	P3	P1/P2-V2	P3/V2	P1/P2-V3	P3/V3
 Tower, left opening door	active door, 1 file tub, 4 CD tubs	casters	24"	25"	48"	AUP T48E LCT () ()	\$2,095.	\$2,384.	\$2,311.	\$2,456.	\$2,528.	\$2,672.
		glides	24"	25"	48"	AUP T48E LGT () ()	2,238.	2,528.	2,456.	2,600.	2,672.	2,816.
	active door, 3 file tubs, 1 CD tub	casters	24"	25"	48"	AUP T48A LCT () ()	2,095.	2,384.	2,311.	2,456.	2,528.	2,672.
		glides	24"	25"	48"	AUP T48A LGT () ()	2,238.	2,528.	2,456.	2,600.	2,672.	2,816.
 Tower, right opening door	active door, 1 file tub, 4 CD tubs	casters	24"	25"	48"	AUP T48E RCT () ()	2,095.	2,384.	2,311.	2,456.	2,528.	2,672.
		glides	24"	25"	48"	AUP T48E RGT () ()	2,238.	2,528.	2,456.	2,600.	2,672.	2,816.
	active door, 3 file tubs, 1 CD tub	casters	24"	25"	48"	AUP T48A RCT () ()	2,095.	2,384.	2,311.	2,456.	2,528.	2,672.
		glides	24"	25"	48"	AUP T48A RGT () ()	2,238.	2,528.	2,456.	2,600.	2,672.	2,816.
Shelf Insert			20 1/2"	14 1/2"	3/4"	AUPTS						123.

Order Code	Specification Information	Application Notes
Example: AUP T48A LCT 117 117	Specify:	Bright White (118) and Silver (613) are P3 paint finishes.
A Currents		
UP Upstart		
T Tower		
48 Height		
A Door configuration	<i>Door configuration:</i>	
L Left	A Active door, 3 files, 1 CD	Towers include painted finish top and bottom, two shelves, molded translucent side and back panels, clear satin anodized aluminum posts, and hinged door with lock. Doors may be specified with painted or veneer finish.
C Casters	E Active door, 1 file, 4 CD	
T Side panels	<i>Specify:</i>	Side panels support adjustable shelves on a 3" grid.
117 Top and base finish	L Left hinge	
117 door finish	R Right hinge	Active door includes tilting bins for 5" deep, letter or legal files and CDs or personal items.
	C Casters	Upstart towers are designed for rapid assembly on site.
	G Glides	
	<i>Specify top and base finish and door finish.</i>	

Alpha-Numeric Index

<i>pattern no.</i>	<i>page</i>	<i>pattern no.</i>	<i>page</i>	<i>pattern no.</i>	<i>page</i>	<i>pattern no.</i>	<i>page</i>
A1 R1 SI	109, 110	AA1FMPS64	47	AA1RWC4242	142	AB1 CS	117
A1 RTOPL	109, 110	AA1FUPS39	47	AA1RWC44	142	AB1 F24	171
A1 RTOPR	109, 110	AA1LO24DN	115	AA1RWC45	142	AB1 FAE	102
A2 R48 LL	109	AA1LO30DN	115	AA1RWC46	142	AB1 FE	102
A2 R48 LP	109	AA1LO36DN	115	AA1RWC47	142	AB1 I25(G/C)	103
A2 R48 LV	109	AA1LO42DN	115	AA1RWC53	142	AB1 I27A(G/C)	103
A2 R48 RL	109	AA1LO48DN	115	AA1RWC54	142	AB1 I27F(G/C)	103
A2 R48 RP	109	AA1MET30	41	AA1RWC55	142	AB1 VL	103
A2 R48 RV	109	AA1MET39	41	AA1RWC63	142	AB1-ABC24	102
A2 R64 LP	109	AA1MET42	41	AA1RWC64	142	AB2 AE	102
A2 R64 RP	109	AA1MET48	41	AA1RWC74	142	AB2 FE27	102
A2L 48 LL	110	AA1MET56	41	AA1RWL36	142	AB2 FE28	102
A2L 48 LP	110	AA1MET64	41	AA1RWL42	142	AC 24 C 2 C	135, 136
A2L 48 LV	110	AA1MET74	41	AA1RWL48	142	AC 24 C 2 C N	137
A2L 48 RL	110	AA1MET80	41	AA1RWL60	142	AC 24 C 2 G	135, 136
A2L 48 RP	110	AA1MPS30	41	AA1RWL72	142	AC 24 C 2 G N	137
A2L 48 RV	110	AA1MPS39	41	AA1RWL84	142	AC 30 C 2 C	135, 136
A2L 64 LP	110	AA1MPS42	41	AA1RWR36	142	AC 30 C 2 C N	137
A2L 64 RP	110	AA1MPS48	41	AA1RWR42	142	AC 30 C 2 G	135, 136
AA139E	63	AA1MPS56	41	AA1RWR48	142	AC 30 C 2 G N	137
AA148E	63	AA1MPS64	41	AA1RWR60	142	AC 3A 11	140, 141
AA164E	63	AA1MPS74	41	AA1RWR72	142	AC 3A 22	140, 141
AA1B	66	AA1MPS80	41	AA1RWR84	142	AC 3A 23	140, 141
AA1BP6	143	AA1MRS	41	AA1T06	63	AC 3A 32	140, 141
AA1C36T	118	AA1NSK	34, 63, 171	AA1T18	63	AC 3B 11	138, 139
AA1CET39	41	AA1OR	28	AA1T24	63	AC 3B 22	138, 139
AA1CET48	41	AA1ORD	28	AA1T30	63	AC 3B 23	138, 139
AA1CET64	41	AA1PM	156	AA1T36	63	AC 3B 32	138, 139
AA1CG	34	AA1PMCC	156	AA1T42	63	AC 4A 11	140, 141
AA1DD	144, 146	AA1PMCIA	156	AA1T48	63	AC 4A 22	140, 141
AA1DPS	49	AA1PS24	117	AA1T60	63	AC 4A 23	140, 141
AA1DT36	152	AA1RE	63	AA1UA39	46	AC 4A 32	140, 141
AA1DT42	152	AA1RODN	115	AA1UA48	46	AC 4B 11	138, 139
AA1DT48	152	AA1ROUP	115	AA1UA64	46	AC 4B 22	138, 139
AA1DT60	152	AA1ROXUP	115	AA1UPS39	46	AC 4B 23	138, 139
AA1DT72	152	AA1RPS34	44	AA1UPS48	46	AC 4B 32	138, 139
AA1DT84	152	AA1RPS42	44	AA1UPS64	46	AC1 39E1	64
AA1DTC	49	AA1RPS49	44	AA1WS24	148	AC1 39L2	64
AA1DW	144, 146	AA1RPS64	44	AA1WS30	148	AC1 39T3	64
AA1ECUP64	115	AA1RPS79	44	AA1WS36	148	AC1 39V2	65
AA1ECUP65	115	AA1RS11	152	AA1WS48	148	AC1 39X4	64
AA1EDWS	115	AA1RS20	152	AA1WSD	148	AC1 39Y3	65
AA1EPS40	43	AA1RSDN	115	AA2 MTC	41, 47	AC1 48E1	64
AA1EPS48	43	AA1RSOC11	152	AA2 UTC	46, 47	AC1 48L2	64
AA1EPS53	43	AA1RSOC20	152	AA2T5E19	148	AC1 48T3	64
AA1EPS60	43	AA1RSUP	115	AA2T5E25	148	AC1 48V2	65
AA1EPS65	43	AA1RSXDN	115	AA2T5E37	148	AC1 48X4	64
AA1FCET39	48	AA1RSXDN	115	AA3EPS41	43	AC1 48Y3	65
AA1FCET48	48	AA1RSXUP	115	AA3EPS49	43	AC1 64E1	64
AA1FCET64	48	AA1RTC	44	AA3EPS54	43	AC1 64L2	64
AA1FMET30	48	AA1RW36	142	AA3EPS61	43	AC1 64T3	64
AA1FMET39	48	AA1RW3C	143	AA3EPS64	43	AC1 64V2	65
AA1FMET42	48	AA1RW42	142	AB1 AC24	102	AC1 64X4	64
AA1FMET48	48	AA1RW48	142	AB1 CL24L	103	AC1 64Y3	65
AA1FMET56	48	AA1RW4C	143	AB1 CL24R	103	AC1 FS18	152
AA1FMET64	48	AA1RW60	142	AB1 CL30L	103	AC1 FS24	152
AA1FMPS30	47	AA1RW72	142	AB1 CL30R	103	AC1 FS30	152
AA1FMPS39	47	AA1RW84	142	AB1 CLF24L	103	ACE1BD6648D(L/R)	97
AA1FMPS42	47	AA1RWC	143	AB1 CLF24R	103	ACE1BD6648S(L/R)	97
AA1FMPS48	47	AA1RWC35	142	AB1 CLF30L	103	ACE1BD7248D(L/R)	97
AA1FMPS56	47	AA1RWC36	142	AB1 CLF30R	103	ACE1BD7248S(L/R)	97

<i>pattern no.</i>	<i>page</i>	<i>pattern no.</i>	<i>page</i>	<i>pattern no.</i>	<i>page</i>	<i>pattern no.</i>	<i>page</i>
ACE1BD7848D(L/R)	97	ACE1R7824N	95	AD C45 SH	124	AD C64 LA	131
ACE1BD7848S(L/R)	97	ACE1R7830N	95	AD C46 DA	132	AD C64 LB	127
ACE1BD8448D(L/R)	97	ACE1R8424N	95	AD C46 DB	128	AD C64 LF	119
ACE1BD8448S(L/R)	97	ACE1R8430N	95	AD C46 DF	120	AD C64 LH	123
ACE1H4818	100	ACE1R9024N	95	AD C46 DH	124	AD C64 SA	131
ACE1H4818P	100	ACE1R9030N	95	AD C46 RA	132	AD C64 SB	127
ACE1H6024	100	ACE1R9624N	95	AD C46 RB	128	AD C64 SF	119
ACE1H6024P	100	ACE1R9630N	95	AD C46 RF	120	AD C64 SH	123
ACE1L3636SSN	96	ACE1W362430N	101	AD C46 RH	124	AD C74 DA	131
ACE1L4242DSN	96	ACE1W363024N	101	AD C46 SA	132	AD C74 DB	127
ACE1L4242SDN	96	ACE1W422430N	101	AD C46 SB	128	AD C74 DF	119
ACE1L4242SSN	96	ACE1W423024N	101	AD C46 SF	120	AD C74 DH	123
ACE1L4260SSN	98	ACE1W482430N	101	AD C46 SH	124	AD C74 LA	131
ACE1L4266SSN	98	ACE1W483024N	101	AD C47 DA	132	AD C74 LB	127
ACE1L4272SSN	98	ACE1W722430N	101	AD C47 DB	128	AD C74 LF	119
ACE1L4278SSN	98	ACE1W723024N	101	AD C47 DF	120	AD C74 LH	123
ACE1L4848DDN	96	AD C35 SA	132	AD C47 DH	124	AD C74 SA	131
ACE1L4848DSN	96	AD C35 SB	128	AD C47 RA	132	AD C74 SB	127
ACE1L4848SDN	96	AD C35 SF	120	AD C47 RB	128	AD C74 SF	119
ACE1L4848SSN	96	AD C35 SH	124	AD C47 RF	120	AD C74 SH	123
ACE1L4860DSN	98	AD C36 SA	132	AD C47 RH	124	AD S36 DA	134
ACE1L4860SDN	98	AD C36 SB	128	AD C47 SA	132	AD S36 DB	130
ACE1L4860SSN	98	AD C36 SF	120	AD C47 SB	128	AD S36 DF	122
ACE1L4866DSN	98	AD C36 SH	124	AD C47 SF	120	AD S36 DH	126
ACE1L4866SDN	98	AD C4242 DB	129	AD C47 SH	124	AD S36 SA	134
ACE1L4866SSN	98	AD C4242 DF	121	AD C53 SA	131	AD S36 SB	130
ACE1L4872DSN	98	AD C4242 LA	133	AD C53 SB	127	AD S36 SF	122
ACE1L4872SDN	98	AD C4242 LB	129	AD C53 SF	119	AD S36 SH	126
ACE1L4872SSN	98	AD C4242 LF	121	AD C53 SH	123	AD S42 DA	134
ACE1L4878SSN	98	AD C4242 LH	125	AD C54 DA	131	AD S42 DB	130
ACE1L4884SSN	98	AD C4242 RA	133	AD C54 DB	127	AD S42 DF	122
ACE1L6042SSN	98	AD C4242 RB	129	AD C54 DF	119	AD S42 DH	126
ACE1L6048DSN	98	AD C4242 RF	121	AD C54 DH	123	AD S42 SA	134
ACE1L6048SDN	98	AD C4242 RH	125	AD C54 LA	131	AD S42 SB	130
ACE1L6048SSN	98	AD C4242 SA	133	AD C54 LB	127	AD S42 SF	122
ACE1L6642SSN	98	AD C4242 SB	129	AD C54 LF	119	AD S42 SH	126
ACE1L6648DSN	98	AD C4242 SF	121	AD C54 LH	123	AD S48 DA	134
ACE1L6648SDN	98	AD C4242 SH	125	AD C54 SA	131	AD S48 DB	130
ACE1L6648SSN	98	AD C44 DA	133	AD C54 SB	127	AD S48 DF	122
ACE1L7242SSN	98	AD C44 DB	129	AD C54 SF	119	AD S48 DH	126
ACE1L7248DSN	98	AD C44 DF	121	AD C54 SH	123	AD S48 SA	134
ACE1L7248SDN	98	AD C44 DH	125	AD C55 DA	133	AD S48 SB	130
ACE1L7248SSN	98	AD C44 LA	133	AD C55 DB	129	AD S48 SF	122
ACE1L7842SSN	99	AD C44 LB	129	AD C55 DF	121	AD S48 SH	126
ACE1L7848SSN	99	AD C44 LF	121	AD C55 DH	125	AD S60 DA	134
ACE1L8448SSN	99	AD C44 LH	125	AD C55 LA	133	AD S60 DB	130
ACE1R1212G	100	AD C44 RA	133	AD C55 LB	129	AD S60 DF	122
ACE1R2424N	95	AD C44 RB	129	AD C55 LF	121	AD S60 DH	126
ACE1R2430N	95	AD C44 RF	121	AD C55 LH	125	AD S60 SA	134
ACE1R3024N	95	AD C44 RH	125	AD C55 RA	133	AD S60 SB	130
ACE1R3030N	95	AD C44 SA	133	AD C55 RB	129	AD S60 SF	122
ACE1R3624N	95	AD C44 SB	129	AD C55 RF	121	AD S60 SH	126
ACE1R3630N	95	AD C44 SF	121	AD C55 RH	125	AD S72 DA	134
ACE1R4224N	95	AD C44 SH	125	AD C55 SA	133	AD S72 DB	130
ACE1R4230N	95	AD C45 DA	132	AD C55 SB	129	AD S72 DF	122
ACE1R4824N	95	AD C45 DB	128	AD C55 SF	121	AD S72 DH	126
ACE1R4830N	95	AD C45 DF	120	AD C55 SH	125	AD S72 SA	134
ACE1R5424N	95	AD C45 DH	124	AD C63 SA	131	AD S72 SB	130
ACE1R5430N	95	AD C45 RA	132	AD C63 SB	127	AD S72 SF	122
ACE1R6024N	95	AD C45 RB	128	AD C63 SF	119	AD S72 SH	126
ACE1R6030N	95	AD C45 RF	120	AD C63 SH	123	AD S84 SA	134
ACE1R6624N	95	AD C45 RH	124	AD C64 DA	131	AD S84 SB	130
ACE1R6630N	95	AD C45 SA	132	AD C64 DB	127	AD S84 SF	122
ACE1R7224N	95	AD C45 SB	128	AD C64 DF	119	AD S84 SH	126
ACE1R7230N	95	AD C45 SF	120	AD C64 DH	123	AF 3924 TCP	66

<i>pattern no.</i>	<i>page</i>	<i>pattern no.</i>	<i>page</i>	<i>pattern no.</i>	<i>page</i>	<i>pattern no.</i>	<i>page</i>
AF 3936 TCP	66	API 4830	59	APC 0960 A	25	APFA1 4872	15
AF 3948 TCP	66	API 4830 N	60	APC 0960 C	21	APFA1 6448	15
AF 3960 TCP	66	API 4830M	61, 62	APC 0960 F	24	APFA1 6460	15
AF 3972 TCP	66	API 4836	59	APC 0960 M	22	APFA1 6472	15
AF 4824 TCP	66	API 4836 N	60	APC 0960 P	22	APR 48	17
AF 4836 TCP	66	API 4836M	61, 62	APC 0960 PT	22	APR 480	17
AF 4848 AM	67	API 4842	59	APC 0960 S	21	APR 60	17
AF 4848 TCM	67	API 4842 N	60	APC 0972 A	25	APR 600	17
AF 4848 TCP	66	API 4842M	61, 62	APC 0972 C	21	APR 72	17
AF 4860 AM	67	API 4848	59	APC 0972 F	24	APR 720	17
AF 4860 TCM	67	API 4848 N	60	APC 0972 M	22	APT	29, 43
AF 4860 TCP	66	API 4848M	61, 62	APC 0972 P	22	APT 48	17
AF 4872 TCM	67	API 4860	59	APC 0972 PT	23	APT 60	17
AF 4872 TCP	66	API 4860 N	60	APC 0972 S	21	APT 72	17
AF 6424 TCP	66	API 6418	59	APC 1636 A	25	APT C24	17
AF 6436 TCP	66	API 6418 A	60	APC 1636 F	24	APT C36	17
AF 6448 AM	67	API 6424	59	APC 1648 A	25	APT C48	17
AF 6448 TCM	67	API 6424 A	60	APC 1648 F	24	APT C60	17
AF 6448 TCP	66	API 6424M	61, 62	APC 1648 M	22	APT C72	17
AF 6460 AM	67	API 6430	59	APC 1648 P	23	APT1 C24	17
AF 6460 TCM	67	API 6430 A	60	APC 1648 PT	23	APT1 C36	17
AF 6460 TCP	66	API 6430M	61, 62	APC 1660 A	25	APT1 C48	17
AFWB	66	API 6436	59	APC 1660 F	24	APT1 C60	17
AL1 A3918	118	API 6436 A	60	APC 1660 M	22	APT1 C72	17
AL1 A3924	118	API 6436M	61, 62	APC 1660 P	23	APTA 48	17
AL1 A4818	118	API 6442	59	APC 1660 PT	23	APTA 60	17
AL1 A4824	118	API 6442 A	60	APC 1672 A	25	APTA 72	17
AL1 A6418	118	API 6442M	61, 62	APC 1672 F	24	APTA CC	29
AL1 A6424	118	API 6448	59	APC 1672 M	22	APTA CC1	29
AL1 AA	118	API 6448 A	60	APC 1672 P	23	APX CIP4	57
AL1 C39	118	API 6448M	61, 62	APC 1672 PT	23	APX CIP6	57
AL1 C48	118	API 6460	59	APC 1836 A	25	APX CIP8	57
AL1 C64	118	API 6460 A	60	APC 1848 A	25	AR OF	20, 58, 152, 156
AMB CP12-AMP	58	API LF	63	APC 1860 A	25	AR1 CB	145, 147, 171
AMB CP24 LUC	58	APA 39	33	APC 1872 A	25	AR1 DA	51, 54, 145, 147
AMC B10	58	APA 48	33	APC 2736 A	26	AR1 DB	51, 54, 145, 147
AMC FP2 (L or N)	58	APA 64	33	APC 2748 A	26	AR1 DC	54, 147
AMC FP3 (L or N)	58	APC 0912 A	25	APC 2760 A	26	AR1 DEHI	145
AMC O3	58	APC 0912 C	21	APC 2772 A	26	AR1 DEM2	144
AMC O5E	58	APC 0912 CX	21	APC AZ48	18	AR1 DEM4	144
AMC O6	58	APC 0912 F	24	APC AZ48 F	19	AR1 DEPI	145
AMC OF500	58	APC 0912 P	22	APC AZ60	18	AR1 DTHI	147
AMC OF625	58	APC 0912 PT	22	APC AZ60 F	19	AR1 DTM2	146
AMC PDC 5E4N	58	APC 0912 S	21	APC AZ72	18	AR1 DTM4	146
AMC5 CP12	58	APC 0924 A	25	APC AZ72 F	19	AR1 DTP1	147
AMC5 OC20(A or B)	58	APC 0924 C	21	APC HOC	20	AR1 DX	51, 54, 145, 147
AMC5 OC30(A or B)	58	APC 0924 F	24	APC OC	20	AR1 DY	51, 54, 145, 147
AMC5 OC40(A or B)	58	APC 0924 M	22	APC OCF	20, 156	AR1 DZ	54, 147
AMC5 OC50(A or B)	58	APC 0924 P	22	APF 1848	16	AR1 E2	53
API 3918 N	60	APC 0924 PT	22	APF 1860	16	AR1 E3	53
API 3924	59	APC 0924 S	21	APF 1872	16	AR1 EJ1	52, 144
API 3924 N	60	APC 0936 A	25	APF1 3948	15	AR1 EJ10	52, 144
API 3930 N	60	APC 0936 C	21	APF1 3960	15	AR1 EJ12	52
API 3936	59	APC 0936 F	24	APF1 3972	15	AR1 EJ2	52, 144
API 3936 N	60	APC 0936 M	22	APF1 4848	15	AR1 EJ3	52, 144
API 3942 N	60	APC 0936 P	22	APF1 4860	15	AR1 EJ4	52, 144
API 3948	59	APC 0936 PT	22	APF1 4872	15	AR1 EJ5	52, 144
API 3948 N	60	APC 0936 S	21	APF1 6448	15	AR1 EJ6	52, 144
API 3960	59	APC 0948 A	25	APF1 6460	15	AR1 EJ7	144
API 3960 N	60	APC 0948 C	21	APF1 6472	15	AR1 EJ8	52, 144
API 4818	59	APC 0948 F	24	APFA1 3948	15	AR1 EOM	51
API 4818 N	60	APC 0948 M	22	APFA1 3960	15	AR1 EPC1	53
API 4824	59	APC 0948 P	22	APFA1 3972	15	AR1 EPC2	53
API 4824 N	60	APC 0948 PT	22	APFA1 4848	15	AR1 EPH1	52
API 4824M	61, 62	APC 0948 S	21	APFA1 4860	15	AR1 EPH2	52

<i>pattern no.</i>	<i>page</i>	<i>pattern no.</i>	<i>page</i>	<i>pattern no.</i>	<i>page</i>	<i>pattern no.</i>	<i>page</i>
AR1 EPHF	34	AS1 DFF M	104	AU 2148 TC	68	AUP B6024M	172
AR1 EPI2	52	AS1 DPAD	107, 108	AU 2160 A	70	AUP B6024RC	172
AR1 EPI5	52	AS1 DPDF M	104	AU 2160 H	68	AUP B7224M	172
AR1 EPIC	52	AS1 DPDFG	105	AU 2160 TC	68	AUP B7224RC	172
AR1 EPM	156	AS1 PT	106	AU 2172 H	68	AUP C	175
AR1 ET1	52	AS1 SDF M	104	AU 2172 TC	68	AUP C D	175
AR1 ET3	52	AS1 SDFO	104	AU 2824 A	70	AUP C DL	175
AR1 ET5	52	AS1 SFF G	105	AU 2824 TC	68	AUP C L	175
AR1 ET8	52	AS1 SFF M	104	AU 2836 A	70	AUP C4872S5	158
AR1 HCC H10	57	AS1 SPAD	107, 108	AU 2836 TC	68	AUP C7248S5	158
AR1 HOB	20	AS1 SPDF M	104	AU 2848 A	70	AUP D624	160
AR1 HOB2	20	AS1 SPDFG	105	AU 2848 TC	68	AUP M72DC4	157
AR1 OHS	145, 147	AS1DD30G	105	AU 2860 A	70	AUP M72DF4	157
AR1 PCC 100	57	AS1DD36G	105	AU 2860 TC	68	AUP MR36	172
AR1 RCM 10	57	AS1DF30G	105	AU 2872 TC	68	AUP MR48	172
AR1 T2	55	AS1DF36G	105	AU1 CL12	73	AUP MR60	172
AR1 T3	55	AS1FF30G	105	AU1 CL21	73	AUP MR72	172
AR1 TJ1	55, 146	AS1FF36G	105	AU1 CL28	73	AUP O664	160
AR1 TJ10	55, 146	AS1PDF30G	105	AU1 CS	73	AUP PDU	171
AR1 TJ12	55	AS1PDF36G	105	AU1 CT12	73	AUP R424	160
AR1 TJ2	55, 146	AT1 D50A	155	AU1 CT21	73	AUP S48D4	159
AR1 TJ3	55, 146	AT1 D50F	155	AU1 CT28	73	AUP S48S2	159
AR1 TJ4	55, 146	AT1 D62A	155	AU1 PC12	78	AUP S48S4	159
AR1 TJ5	55, 146	AT1 D62F	155	AU1 PC21	78	AUP S60D4	159
AR1 TJ6	55, 146	AT1 E24LA	154	AU1 PC28	78	AUP S72D4	159
AR1 TJ7	146	AT1 E24LF	154	AU1 X112	73	AUP S72E4	159
AR1 TJ8	55, 146	AT1 E24RA	154	AU1 X121	73	AUP T363	160
AR1 TOM	54	AT1 E24RF	154	AU1 X128	73	AUP T48A LCT	176
AR1 TPC1	55	AT1 P36A	153	AU1 X312	73	AUP T48A LGT	176
AR1 TPC2	55	AT1 P36F	153	AU1 X321	73	AUP T48A RCT	176
AR1 TPH1	55	AT1 R42A	155	AU1 X328	73	AUP T48A RGT	176
AR1 TPH2	55	AT1 R42F	155	AUA1 0824 G	71	AUP T48E LCT	176
AR1 TPHF	34	AT1 R48A	155	AUA1 0836 G	71	AUP T48E LGT	176
AR1 TPI2	55	AT1 R48F	155	AUA1 0848 G	71	AUP T48E RCT	176
AR1 TPI5	55	AT1 TA	153	AUA1 0860 G	71	AUP T48E RGT	176
AR1 TPIC	55	AT1 TL	153	AUA1 0872 G	71	AUP V48S5	158
AR1 TPM	156	AT1 W24A	153	AUA1 1224 G	71	AUP VP3	175
AR1 TT1	55	AT1 W24F	153	AUA1 1236 G	71	AUP W60D4	160
AR1 TT3	55	AT1 W30A	154	AUA1 1248 G	71	AUP Y72DCL4	157
AR1 TT5	55	AT1 W30F	154	AUA1 1260 G	71	AUP Y72DCR4	157
AR1 TT8	55	AT1 W50A	155	AUA1 1272 G	71	AUP Y72DFL4	157
AR1 VCM	34	AT1 W50F	155	AUA1 1524 G	71	AUP Y72DFR4	157
AR1-ELS-B	51, 54	AU 1212 T 4	69	AUA1 1536 G	71	AUPCCV	161
ARE1 DA	56	AU 1224 A	70	AUA1 1548 G	71	AUPCGV	161
ARE1 DB	56	AU 1224 H	68	AUA1 1560 G	71	AUPM C3660S5	167
ARE1 DC	56	AU 1224 TC	68	AUA1 1572 G	71	AUPM C3672S5	167
ARE1 DX	56	AU 1236 A	70	AUA1224	72	AUPM C4242D5	164
ARE1 DX (O or T)	56	AU 1236 H	68	AUA1236	72	AUPM C4242S5	164
ARE1 DY	56	AU 1236 TC	68	AUA1248	72	AUPM C4260L5	168
ARE1 DY (O or T)	56	AU 1248 A	70	AUA1260	72	AUPM C4260R5	167
ARE1 DZ	56	AU 1248 H	68	AUA1272	72	AUPM C4260S5	167
ARE1 DZ (O or T)	56	AU 1248 TC	68	AUA2124	72	AUPM C4272L5	168
ARE1 EP1	56	AU 1260 A	70	AUA2136	72	AUPM C4272R5	167
ARE1 ET1	56	AU 1260 H	68	AUA2148	72	AUPM C4272S5	167
ARE1 ET3	56	AU 1260 TC	68	AUA2160	72	AUPM C4848D5	164
ARE1 ET5	56	AU 1272 H	68	AUA2172	72	AUPM C4848S5	164
ARE1 TP1	56	AU 1272 TC	68	AUA2824	72	AUPM C4860D5	167
ARE1 TT1	56	AU 2124 A	70	AUA2836	72	AUPM C4860L5	168
ARE1 TT3	56	AU 2124 H	68	AUA2848	72	AUPM C4860R5	167
ARE1 TT5	56	AU 2124 TC	68	AUA2860	72	AUPM C4860S5	167
AS1 BKH	106	AU 2136 A	70	AUA2872	72	AUPM C4872D5	167
AS1 BKL	106	AU 2136 H	68	AUP B3624M	172	AUPM C4872L5	168
AS1 DDF M	104	AU 2136 TC	68	AUP B3624RC	172	AUPM C4872R5	167
AS1 DDFO	104	AU 2148 A	70	AUP B4824M	172	AUPM C4872S5	167
AS1 DFF G	105	AU 2148 H	68	AUP B4824RC	172	AUPM C4884D5	167

<i>pattern no.</i>	<i>page</i>	<i>pattern no.</i>	<i>page</i>	<i>pattern no.</i>	<i>page</i>	<i>pattern no.</i>	<i>page</i>
AUPM C4884L5	168	AW1 C4260 L	86	AW1 F6030	83	AWM2 C6042 L	90
AUPM C4884R5	167	AW1 C4260 R	86	AW1 F6624	83	AWM2 C6042 R	90
AUPM C4884S5	167	AW1 C4260 S	86	AW1 F7224	83	AWM2 C6042 S	90
AUPM C6036S5	165	AW1 C4272 L	86	AW1 F7230	83	AWM2 C6048 D	90
AUPM C6042L5	165	AW1 C4272 R	86	AW1 F8424	83	AWM2 C6048 L	90
AUPM C6042R5	166	AW1 C4272 S	86	AW1 F8430	83	AWM2 C6048 R	90
AUPM C6042S5	165	AW1 C4284 L	86	AW1 P4875 S	87	AWM2 C6048 S	90
AUPM C6048D5	165	AW1 C4284 R	86	AW1 P4887 S	87	AWM2 C6060 D	92
AUPM C6048L5	165	AW1 C4284 S	86	AW1 P7548 S	87	AWM2 C6060 L	92
AUPM C6048R5	166	AW1 C4848 D	84	AW1 P8748 S	87	AWM2 C6060 R	92
AUPM C6048S5	165	AW1 C4848 L	84	AW1 R7236	88	AWM2 C6060 S	92
AUPM C6060D5	164	AW1 C4848 R	84	AW1 S2424	83	AWM2 C7236 S	90
AUPM C6060S5	164	AW1 C4848 S	84	AW1 S3024	83	AWM2 C7242 L	90
AUPM C7236S5	165	AW1 C4860 D	86	AW1 S3624	83	AWM2 C7242 R	90
AUPM C7242L5	165	AW1 C4860 L	86	AW1 S3630	83	AWM2 C7242 S	90
AUPM C7242R5	166	AW1 C4860 R	86	AW1 S4224	83	AWM2 C7248 D	90
AUPM C7242S5	165	AW1 C4860 S	86	AW1 S4824	83	AWM2 C7248 L	90
AUPM C7248D5	165	AW1 C4872 D	86	AW1 S4830	83	AWM2 C7248 R	90
AUPM C7248L5	165	AW1 C4872 L	86	AW1 S6024	83	AWM2 C7248 S	90
AUPM C7248R5	166	AW1 C4872 R	86	AW1 S6030	83	AWM2 C8448 D	90
AUPM C7248S5	165	AW1 C4872 S	86	AW1 S6624	83	AWM2 C8448 L	90
AUPM C8448D5	165	AW1 C4884 D	86	AW1 S7224	83	AWM2 C8448 R	90
AUPM C8448L5	165	AW1 C4884 L	86	AW1 S7230	83	AWM2 C8448 S	90
AUPM C8448R5	166	AW1 C4884 R	86	AW1 S8424	83	AWM2 F2424	89
AUPM C8448S5	165	AW1 C4884 S	86	AW1 S8430	83	AWM2 F3024	89
AUPM D594	169	AW1 C6036 S	85	AWF1CR24L	100	AWM2 F3030	89
AUPM D604	169	AW1 C6042 L	85	AWF1CR24N	100	AWM2 F3624	89
AUPM P4875S5	169	AW1 C6042 R	85	AWF1CR24R	100	AWM2 F3630	89
AUPM P7548S5	169	AW1 C6042 S	85	AWM1 S36	94	AWM2 F4224	89
AUPM S30D4	162	AW1 C6048 D	85	AWM1 S42	94	AWM2 F4230	89
AUPM S30S4	162	AW1 C6048 L	85	AWM1 S48	94	AWM2 F4824	89
AUPM S36D4	162	AW1 C6048 R	85	AWM1 S60	94	AWM2 F4830	89
AUPM S36S2	163	AW1 C6048 S	85	AWM1 S66	94	AWM2 F5424	89
AUPM S36S4	162	AW1 C6060 D	84	AWM1 S72	94	AWM2 F5430	89
AUPM S42D4	162	AW1 C6060 L	84	AWM1 S78	94	AWM2 F6024	89
AUPM S42S2	163	AW1 C6060 R	84	AWM1 S84	94	AWM2 F6030	89
AUPM S42S4	162	AW1 C6060 S	84	AWM2 C3660 S	91	AWM2 F6624	89
AUPM S48D4	162	AW1 C7236 S	85	AWM2 C3672 S	91	AWM2 F6630	89
AUPM S48S2	163	AW1 C7242 L	85	AWM2 C4242 D	92	AWM2 F7224	89
AUPM S48S4	162	AW1 C7242 R	85	AWM2 C4242 L	92	AWM2 F7230	89
AUPM S54D4	162	AW1 C7242 S	85	AWM2 C4242 R	92	AWM2 F7824	89
AUPM S54S4	162	AW1 C7248 D	85	AWM2 C4242 S	92	AWM2 F7830	89
AUPM S60D4	162	AW1 C7248 L	85	AWM2 C4260 L	91	AWM2 F8424	89
AUPM S60S2	163	AW1 C7248 R	85	AWM2 C4260 R	91	AWM2 F9024	89
AUPM S60S4	162	AW1 C7248 S	85	AWM2 C4260 S	91	AWM2 F9030	89
AUPM S66D4	162	AW1 C8436 S	85	AWM2 C4272 L	91	AWM2 F9624	89
AUPM S66S4	162	AW1 C8442 L	85	AWM2 C4272 R	91	AWM2 F9630	89
AUPM S72D4	162	AW1 C8442 R	85	AWM2 C4272 S	91	AWM2 P4875 S	93
AUPM S72S4	162	AW1 C8442 S	85	AWM2 C4848 D	92	AWM2 P4887 S	93
AUPM S84D4	162	AW1 C8448 D	85	AWM2 C4848 L	92	AWM2 P7548 S	93
AUPM S84S4	162	AW1 C8448 L	85	AWM2 C4848 R	92	AWM2 P8748 S	93
AUPM SCV	170	AW1 C8448 R	85	AWM2 C4848 S	92	AX1 AK1	32
AUPM SGV	170	AW1 C8448 S	85	AWM2 C4860 D	91	AX1 AK3	32
AUPTS	176	AW1 CS3612	117	AWM2 C4860 L	91	AX1 E40	43
AW1 A60L	88	AW1 CS4812	117	AWM2 C4860 R	91	AX1 E48	43
AW1 A60R	88	AW1 CS6012	117	AWM2 C4860 S	91	AX1 E53	43
AW1 A72L	88	AW1 CS7212	117	AWM2 C4872 D	91	AX1 E60	43
AW1 A72R	88	AW1 F2424	83	AWM2 C4872 L	91	AX1 E65	43
AW1 C3660 S	86	AW1 F3024	83	AWM2 C4872 R	91	AX1 EET39(T,R,L)	43
AW1 C3672 S	86	AW1 F3624	83	AWM2 C4872 S	91	AX1 EET48(T,R,L)	43
AW1 C3684 S	86	AW1 F3630	83	AWM2 C4884 D	91	AX1 EET64(T,R,L)	43
AW1 C4242 D	84	AW1 F4224	83	AWM2 C4884 L	91	AX1 ECF11	43
AW1 C4242 L	84	AW1 F4824	83	AWM2 C4884 R	91	AX1 ECF16	43
AW1 C4242 R	84	AW1 F4830	83	AWM2 C4884 S	91	AX1 ECF24	43
AW1 C4242 S	84	AW1 F6024	83	AWM2 C6036 S	90	AX1 ECF4	43

<i>pattern no.</i>	<i>page</i>	<i>pattern no.</i>	<i>page</i>	<i>pattern no.</i>	<i>page</i>	<i>pattern no.</i>	<i>page</i>
AX1 F18	31	AX1DES42	40	AX1SX64 (A/C)(L/C/P)	38	AY1 2542M A	76
AX1 F39	29	AX1DES50	40	AX2 C3939	42	AY1 2548M	74
AX1 F48	29	AX1DES57	40	AX2 C4839	42	AY1 2548M A	76
AX1 F64	29	AX1DES64	40	AX2 C4848	42	AY1 2560M	74
AX1 FF	16	AX1DES78	40	AX2 C6439	42	AY1 2560M A	76
AX1 FHLS4818	32	AX1DET36	50	AX2 C6448	42	AY1 2824C	74
AX1 FWS 39	32	AX1DET42	50	AX2 C6464	42	AY1 2836C	74
AX1 FWS 48	32	AX1DET50	50	AX3E41	43	AY1 2848C	74
AX1 FWS 64	32	AX1DET5039	50	AX3E49	43	AY1 2860C	74
AX1 HLS4839	28	AX1DET5048	50	AX3E54	43	AY1 AXST16	82
AX1 HLS6439	28	AX1DET57	50	AX3E61	43	AY1 AXT16	82
AX1 HLS6448	28	AX1DET5739	50	AX3E64	43	AY1 AXT25	82
AX1 L18	30	AX1DET5748	50	AY1 1224C	74	AY1 AXT32	82
AX1 L39	27	AX1DET64	50	AY1 1224C A	76	AY1 CE	79
AX1 L48	27	AX1DET6439	50	AY1 1236C	74	AY1 CL12	81
AX1 L64	27	AX1DET6448	50	AY1 1236C A	76	AY1 CL21	81
AX1 LEG	16	AX1DET6464	50	AY1 1248C	74	AY1 CL28	81
AX1 M3939	42	AX1DET7848	50	AY1 1248C A	76	AY1 CMK	81
AX1 M4239	42	AX1DET7864	50	AY1 1260C	74	AY1 CS	79
AX1 M4839	42	AX1LES E	39	AY1 1260C A	76	AY1 CT12	81
AX1 M4848	42	AX1LES30	39	AY1 1618M	74	AY1 CT21	81
AX1 M5639	42	AX1LES39	39	AY1 1618M A	76	AY1 CT28	81
AX1 M5648	42	AX1LES48	39	AY1 1618S	75	AY1 CX12	82
AX1 M6439	42	AX1LES64	39	AY1 1618S A	77	AY1 CX21	82
AX1 M6448	42	AX1MES30	39	AY1 1624M	74	AY1 CX28	82
AX1 M6464	42	AX1MES39	39	AY1 1624M A	76	AY1 HLA	81
AX1 M8039	42	AX1MES42	39	AY1 1624S	75	AY1 LL16	79
AX1 M8048	42	AX1MES48	39	AY1 1624S A	77	AY1 LL25	79
AX1 M8064	42	AX1MES56	39	AY1 1630M	74	AY1 LL32	79
AX1 R34239	44	AX1MES64	39	AY1 1630M A	76	AY1 LP16	80
AX1 R34939	44	AX1MES80	39	AY1 1630S	75	AY1 LP25	80
AX1 R34948	44	AX1SEC3939	35	AY1 1630S A	77	AY1 LP32	80
AX1 R36439	44	AX1SEC4039 L	35	AY1 1636M	74	AY1 LT16	79
AX1 R36448	44	AX1SEC4239	36	AY1 1636M A	76	AY1 LT25	79
AX1 R36464	44	AX1SEC4339 C	35	AY1 1636S	75	AY1 LT32	79
AX1 R37939	44	AX1SEC4839	36	AY1 1636S A	77	AY1 LX16	80
AX1 R37948	44	AX1SEC4848	35	AY1 1642M	74	AY1 LX25	80
AX1 R37964	44	AX1SEC4948 L	35	AY1 1642M A	76	AY1 LX32	80
AX1 S	28	AX1SEC5248 C	35	AY1 1642S	75	AY1 MMK	81
AX1 STC39 3	28	AX1SEC5639	36	AY1 1642S A	77	AY1 PC16	78
AX1 STC39 L3	28	AX1SEC5648	36	AY1 1648M	74	AY1 PC25	78
AX1 STC48 3	28	AX1SEC6439	36	AY1 1648M A	76	AY1 PC32	78
AX1 STC48 L3	28	AX1SEC6448	36	AY1 1648S	75	AY1 SCL16	81
AX1 STC64 3	28	AX1SEC6464	35	AY1 1648S A	77	AY1 SCT16	81
AX1 STC64 L3	28	AX1SEC6564 L	35	AY1 1660M	74	AY1 SCX16	82
AX1 SWS39	28	AX1SEC6864 C	35	AY1 1660M A	76	AY1 SL16	79
AX1 SWS48	28	AX1SEC8048	36	AY1 1660S	75	AY1 SMK	81
AX1 SWS64	28	AX1SEC8064	36	AY1 1660S A	77	AY1 SP16	80
AX1 T18	30	AX1SECBT	35, 36, 37	AY1 2124C	74	AY1 SPC16	78
AX1 T39	27	AX1SED3939	37	AY1 2124C A	76	AY1 ST16	79
AX1 T48	27	AX1SED4239	37	AY1 2136C	74	AY1 SX116	82
AX1 T64	27	AX1SED4339C	37	AY1 2136C A	76	AY1 SX16	80
AX1 V18	30	AX1SED4848	37	AY1 2148C	74	AY1 SX316	82
AX1 V39	27	AX1SED5039	37	AY1 2148C A	76	AY1 X112	82
AX1 V48	27	AX1SED5048	37	AY1 2160C	74	AY1 X121	82
AX1 V64	27	AX1SED5248C	37	AY1 2160C A	76	AY1 X128	82
AX1 X18	30	AX1SED5739	37	AY1 2518M	74	AY1 X312	82
AX1 X39	27	AX1SED5748	37	AY1 2518M A	76	AY1 X321	82
AX1 X48	27	AX1SED6439	37	AY1 2524M	74	AY1 X328	82
AX1 X64	27	AX1SED6448	37	AY1 2524M A	76	AZ1 0936H	149
AX1 Y18	30	AX1SED6464	37	AY1 2530M	74	AZ1 0942H	149
AX1 Y39	27	AX1SED7848	37	AY1 2530M A	76	AZ1 0948H	149
AX1 Y48	27	AX1SED7864	37	AY1 2536M	74	AZ1 0960H	149
AX1 Y64	27	AX1SX39 (A/C)(L/C/P)	38	AY1 2536M A	76	AZ1 0972H	149
AX1DES36	40	AX1SX48 (A/C)(L/C/P)	38	AY1 2542M	74	AZ1 1836F	150

<i>pattern no.</i>	<i>page</i>	<i>pattern no.</i>	<i>page</i>	<i>pattern no.</i>	<i>page</i>
AZ1 1842F	150	MZ1-V7222	174	RTAT5E25	116
AZ1 1848F	150	R3B0POF4207	45	RTAT5E37	116
AZ1 1860F	150	R3B0POF4907	45	RTAT5E49	116
AZ1 1872F	150	R3B0POF6407	45	RTAT5E61	116
AZ1 2736F	150	R3B0POF7907	45		
AZ1 2742F	150	R3B0POH4207	45		
AZ1 2748F	150	R3B0POH4907	45		
AZ1 2760F	150	R3B0POH6407	45		
AZ1 2772F	150	R3B0POH7907	45		
AZ1 CL18	151	R3B0TOF4207	45		
AZ1 CL27	151	R3B0TOF4907	45		
AZ1 CL36	151	R3B0TOF6407	45		
AZ1 CS	151	R3B0TOF7907	45		
AZ1 U0936T	151	R3B0TOH4207	45		
AZ1 U0942T	151	R3B0TOH4907	45		
AZ1 U0948T	151	R3B0TOH6407	45		
AZ1 U0960T	151	R3B0TOH7907	45		
MC1-39S1	64	RO1-CB	114		
MC1-48S1	64	RO1-HP12	112, 113		
MC1-64S1	64	RO1-HP15	112, 113		
MD6-BD	106	RO1-HP6	112, 113		
MD6-FS	106	RO1-HP9	112, 113		
MM2-CG	63, 171	RO1-PULL	114		
MR3 PDCX	58	RO3-N24	111		
MZ1-B3015	173	RO3-N30	111		
MZ1-B3019	173	RO3-N36	111		
MZ1-B3022	173	RO3-N42	111		
MZ1-B3615	173	RO3-N48	111		
MZ1-B3619	173	RO3-N60	111		
MZ1-B3622	173	RO3-N66	111		
MZ1-B4215	173	RO3-N72	111		
MZ1-B4219	173	RO3-OM30	112		
MZ1-B4222	173	RO3-OM36	112		
MZ1-B4815	173	RO3-OM42	112		
MZ1-B4819	173	RO3-OM48	112		
MZ1-B4822	173	RO3-OM60	112		
MZ1-B5415	173	RO3-OM72	112		
MZ1-B5419	173	RO3-ON30	112		
MZ1-B5422	173	RO3-ON36	112		
MZ1-B6015	173	RO3-ON42	112		
MZ1-B6019	173	RO3-ON48	112		
MZ1-B6022	173	RO3-ON60	112		
MZ1-B6615	173	RO3-ON72	112		
MZ1-B6619	173	RO3-RD30	112		
MZ1-B6622	173	RO3-RD36	112		
MZ1-B7215	173	RO3-RD42	112		
MZ1-B7219	173	RO3-RD48	112		
MZ1-B7222	173	RO3-RD60	112		
MZ1-B7815	173	RO3-RD72	112		
MZ1-B7819	173	RO3-VP	112		
MZ1-B7822	173	RS1 MPB	115		
MZ1-V3615	174	RS1-M24	113		
MZ1-V3619	174	RS1-M30	113		
MZ1-V3622	174	RS1-M36	113		
MZ1-V4215	174	RS1-M42	113		
MZ1-V4219	174	RS1-M48	113		
MZ1-V4222	174	RS1-M60	113		
MZ1-V4815	174	RS1-N24	113		
MZ1-V4819	174	RS1-N30	113		
MZ1-V4822	174	RS1-N36	113		
MZ1-V6015	174	RS1-N42	113		
MZ1-V6019	174	RS1-N48	113		
MZ1-V6022	174	RS1-N60	113		
MZ1-V7215	174	RS1-VP	113		
MZ1-V7219	174	RTAT5E19	116		

Selling Policy

	<p>This Selling Policy supercedes all previous selling policies. Prices, discounts and product offerings are subject to change without notice.</p>
Terms & Conditions of Sales	<p>Sales by Knoll, Inc. or Knoll North America Corp. ("Seller") of Knoll Product Lines (hereinafter "Products") within the United States and Canada are made only on the terms which are contained in this Selling Policy. Seller hereby gives notice of its objection to any different or additional terms and conditions. This sale is expressly conditional upon Purchaser's assent to the terms and conditions set forth below. Additional terms and conditions may apply to KnollStudio and KnollTextiles orders. These terms and conditions may be modified or supplemented only by a written document signed by an authorized representative of Seller. These terms and conditions supercede any prior and/or contemporaneous agreements or correspondence between Purchaser and Seller. Written quotations expire thirty (30) days from the date of issuance and can be withdrawn by written notice anytime during that period. Where Purchaser and Seller have entered into the Knoll Electronic Terms and Conditions, all orders, acknowledgements, invoices and other business communications placed or transmitted in accordance with the Knoll Electronic Terms and Conditions shall be deemed to be in writing and signed and shall be valid for all purposes as if they were originated and maintained in documentary form.</p>
Ordering Information	<p>All orders must be in writing. The product pattern number(s) contained on Seller's order acknowledgement shall be the final expression of the order.</p>
Order Confirmation	<p>A purchase order is not binding on Seller until Purchaser has received Seller's order confirmation or acknowledgment.</p>
Pricing Policies	<p>List prices are subject to change without notice.</p> <p>List prices shall be those prices in effect on the date of receipt of a complete purchase order unless shipment is requested more than ninety (90) days after order entry in which case prices in effect on the date of shipment apply. List prices include specified freight costs. Unless specified in writing by Seller, no other charges are included in Seller's list prices.</p>
Taxes	<p>All sales, use, excise and other taxes applicable to the sale of the Products shall be paid by Purchaser. If Purchaser claims an exemption from any tax, Purchaser shall submit to Seller the appropriate exemption certificates.</p>
Terms of Payment	<p>Payment for one hundred percent (100%) of the net order amount is due within thirty (30) days of the date of invoice, which is issued upon shipment. In case of any discrepancies, such as shortages, and Seller is notified in writing within ten (10) days of receipt of Product, only that portion may be deducted and the balance paid. For orders greater than \$100,000 net, a one-third (1/3) deposit is due at the time of order placement, with the remainder due within thirty (30) days of the date of invoice.</p> <p>KnollStudio orders less than \$2,000 require payment for one hundred percent (100%) of the net order amount (including any applicable sales tax and charges for inside delivery, special packaging, etc.), due at time of order placement. For KnollStudio orders greater than \$2,000, a one-half (50%) deposit is due at time of order placement with the remainder (including any applicable sales tax and charges for inside delivery, special packaging, etc.) due prior to shipment.</p> <p>If, in the judgment of Seller, Purchaser's financial condition does not justify the terms of the payment, Seller may require full or partial payment in advance.</p> <p>Past due accounts shall be charged one and one-half percent (1.5%) per month, or the highest rate permitted by law, whichever is less, and will be added to the outstanding balance. In the event Purchaser defaults on payment, Purchaser shall be liable for all collection costs, including reasonable attorney's fees and costs.</p>
Changes and Cancellation	<p>Purchase orders may not be changed or cancelled, in whole or in part, without prior written consent of Seller. Changes may effect delivery dates. Expenses incurred because of changes shall be charged to Purchaser. In the event of cancellations, Purchaser will be liable for reasonable cancellation charges established by Seller. Orders for special Product, orders including "COM" (hereinafter defined) material and orders pursuant to expedited delivery programs, may not be canceled.</p>
Freight Prepaid	<p>Freight is prepaid and included in the price of all Products, except KnollTextiles, within the 48 contiguous United States for orders placed with Knoll, Inc. and within Canada, excluding the Yukon, Northwest Territories, Nunavut and Newfoundland for orders placed with Knoll North America Corp. Packing is tested for rigorous motion and transportation but is not guaranteed to protect furniture from conditions over which the Seller has no control. If special packaging is required for any reason, please consult with your sales representative or dealer. Seller shall select the method of shipment and routing. All shipments shall be tailgate deliveries. Freight for all KnollTextiles orders is prepaid and added to the invoice.</p>
Delivery/Freight Charges	<p>Shipments outside the contiguous 48 United States and Canada shall be shipped F.O.B. Origin.</p> <p>For shipments outside the contiguous United States and Canada, Purchaser is responsible for the cost of freight from point of embarkation, including any handling and transportation charges incidental to loading at the point of departure and unloading at the final destination.</p> <p>Conditions beyond the control of Seller, including weather, available facilities and traffic conditions, may affect exact time of delivery. Seller shall not be responsible for specific carrier delivery date or time unless it has made a specific delivery commitment, in writing.</p> <p>Nonstandard methods of shipment and/or additional services are available upon request. Purchaser will be billed for the differential cost of any special services in excess of standard surface carrier freight costs. Premium charges, at Purchaser's request, will be added for airfreight, exclusive use of vehicle and extra, export or special packaging. Accessorial charges will be added for inside delivery, extra labor, reassignment and redelivery.</p> <p>Partial shipments may be made and invoiced by Seller.</p>
Claims	<p>All shipments for all Knoll Products within the contiguous United States and Canada are F.O.B. Origin. Risk of loss passes to Purchaser at time of delivery to carrier. Purchaser shall inspect all Products upon receipt and notify Seller within ten (10) working days after receipt of any damage or defects which are, or should be, apparent from an inspection of the Product and its packaging. Failure of Purchaser to make a claim against carrier or notify Seller during the ten (10) working day period shall constitute acceptance of the Products and waiver of any apparent defects, errors or shortages. Seller will agree to repair or replace Product damaged in shipment if Purchaser has notified Seller of freight damage within ten (10) working days after receipt and assigns its rights against the carrier.</p>
Seller's Security Interest	<p>Until Seller receives the full payment for the Product, Seller shall have a security interest in the Product. Purchaser agrees to perform all acts, including but not limited to the execution and filing of documentation, which may be necessary to perfect and assure the security interest of Seller.</p>
Returns	<p>The return of Products without a written authorization by Seller shall not be accepted. To receive authorization for Product return, please call Customer Service. All Products that are returned pursuant to a valid authorization shall be subject to a twenty-five percent (25%) of list restocking charge. Products not currently offered for sale by Seller (including COM) shall not be authorized for return. All returned Products must be unused, in original condition and in the original Seller packing cartons. No refund or credit shall be given for damaged Products.</p>
Held Orders/Storage	<p>If Purchaser requests that an order be held or delayed, prices and terms and conditions in effect at the time of shipment shall apply. If Purchaser requests a delay after the time when Seller can defer production, Purchaser will be invoiced for the Product, payable in accordance with standard terms, when the order is ready for shipment. Seller may transfer the Product to storage, in which case all expenses incurred in connection with storage, including demurrage, preparation for storage, storage charges and handling shall be payable by Purchaser upon submission of invoices by Seller. Risk of loss to the Product shall pass to the Purchaser upon delivery of the Product into storage.</p>

Selling Policy

Customer's Own Material	A Purchaser who requests a fabric or other surface material not standard to Seller's line of Products ("COM") must submit samples of the requested material to Seller prior to entry of a purchaser order. Seller shall determine if the material is suitable to its manufacturing processes and meets any requirements of Underwriters Laboratories. If the COM is acceptable, Seller will then establish a price for using the COM or the Product in question. For a description of the procedures for submitting samples and testing, contact customer resources or your sales representative. Seller shall have no responsibility for the appearance, condition, performance, durability, colorfastness or any other physical attribute of the COM. Purchaser shall indemnify and hold Seller harmless for any damages, injuries or losses arising out of or related to use of the COM on the Product.
Warranty	<p>Seller warrants to the original Purchaser only that the Products Seller manufactures and sells to Purchaser are free of defects in workmanship and materials, during the applicable warranty period set forth below.</p> <p>Warranty period set forth below for <i>Bulldog, Chadwick, Essentials Work Chairs, Life, Open Up, RPM, Sapper</i> and <i>SoHo</i> seating is for 24-hour, 7 days a week, multi shift use.</p> <p>Should any failure to conform with this limited warranty appear to a Product listed below during the applicable warranty period from the date of shipment, Seller shall, upon prompt written notice, repair or replace, at its option and costs, the affected part or parts.</p> <p><i>Product and Period of Warranty</i></p> <p><i>Lifetime: AutoStrada, Calibre, Crinion Open Table, Currents, Dividends Horizon, Equity, Morrison, Reff</i> laminate, <i>Series 2 Storage</i> and other non-wood components (except cascade edge worksurfaces, operational parts, controls, electrical, <i>Series 2 Veneer Front Storage</i>, special or custom products or other materials specifically called out below, see below)</p> <p><i>10 Years: AutoStrada, Crinion Open Table, Reff</i> wood components, <i>Series 2 Veneer Front Storage, Wood Casegoods (Magnusson, The Graham Collection), Interaction</i> tables (except height adjustment mechanisms for <i>Counterforce</i>, crank-adjustable, and split-top tables and worksurfaces, see below), <i>Reuter</i> overheads, <i>Reuter</i> vertical storage, <i>Bulldog, Chadwick, Essentials Work Chairs, Life, RPM</i> and <i>Sapper</i> seating structural and operational parts, controls, casters, pneumatic cylinders, seat and back mesh (except seating upholstery, finishes and labor, wood casegoods upholstered surfaces, see below)</p> <p><i>5 Years: Operational parts, controls, electrical (except light ballasts and bulbs, see below), cascade edge worksurfaces, special or custom product, wood veneer products, A3, Currents</i> handcrank, <i>Interaction Counterforce, Interaction</i> crank-adjustable, and split-top mechanisms, <i>KnollStudio, KnollExtra</i> adjustable keyboard supports, VDT carousel, monitor platform, equipment storage drawers and all universal storage drawers, <i>Open Up and SoHo</i> seating structural and operational parts, controls, pneumatic cylinders (except seating upholstery, finishes and labor, see below)</p> <p><i>3 Years: Upholstery, finishes and labor to repair the following chairs: Bulldog, Chadwick, Essentials Work Chairs, Life, Open Up, RPM, Sapper</i> and <i>SoHo.</i></p> <p><i>2 Years: All other KnollExtra</i> product</p> <p><i>1 Year: Light ballasts and bulbs, seating upholstered armpads and soft armpads, wood casegoods upholstered surfaces.</i></p> <p>This warranty does not apply to:</p> <ul style="list-style-type: none">• Damage caused by a carrier other than the Seller.• Normal wear and tear or acts or omissions of parties other than Seller (including user modification).• COM or other third party materials applied to Products.• Products not installed by or under the auspices of a certified dealer of Seller.• Dramatic temperature variations or exposure to unusual conditions.• Except as specifically noted above, textiles and upholstery supplied by <i>KnollTextiles</i> (consult current <i>KnollTextiles</i> price list for applicable warranty). <p>Natural variations occurring in wood, marble, and leather shall not be considered defects, and the Seller does not guarantee the colorfastness or matching of the colors, grains or textures, or surface hardness of such materials. The Seller also does not guarantee the colorfastness of fiberglass panel surfaces.</p> <p>THE EXPRESS WARRANTIES CONTAINED HEREIN ARE IN LIEU OF ALL OTHER WARRANTIES, EXPRESS OR IMPLIED, INCLUDING ANY WARRANTIES OF MERCHANTABILITY AND FITNESS FOR PARTICULAR PURPOSE AND ALL OTHER WARRANTIES ARISING FROM COURSE OF DEALING OR USAGE OF TRADE.</p> <p>The remedies provided above are the Purchaser's sole remedies for any failure of Seller to comply with its obligations regarding the workmanship of its Products. Correction of any nonconformity in the manner and for the period of time provided shall constitute complete fulfillment of all liabilities of Seller, with respect to or arising out of the Product furnished hereunder.</p>
Delay/Force Majeure	Seller shall not be liable for failure to perform or for delay in performance due to fire, flood, strike or other labor difficulty, act of God, act of any governmental authority or of the Purchaser, riot, embargo, fuel or energy shortage, wrecks or delay in transportation, inability to obtain necessary labor, materials or manufacturing facilities from usual sources or failure of suppliers to meet their contractual obligations, or due to any cause beyond its reasonable control. If any such event occurs, Seller may extend delivery dates by a period of time necessary to overcome the effect of such delay, allocate available Product or cancel any purchase order.
Compliance with Law	PURCHASER IS SOLELY RESPONSIBLE FOR COMPLIANCE WITH ALL APPLICABLE FEDERAL, STATE AND LOCAL LAWS, ORDINANCES, REGULATIONS, RULES AND STANDARDS RELATING TO THE INSTALLATION, MAINTENANCE, USE AND OPERATION OF THE PRODUCTS.
Patents	<p>Subject to the following provisions, Seller shall, at its own expense, defend or, at its option, settle any claim, suit or proceeding brought against the Purchaser, and/or its vendees, mediate and immediate, so far as based on an allegation that any Product or any part thereof furnished hereunder constitutes a direct or a contributory infringement of any claim of any patent of the United States or Canada. This obligation shall be effective only if Purchaser shall have made all payments then due hereunder and if Seller is notified promptly in writing and given authority, information and assistance for the defense of said claim, suit or proceeding. Seller shall pay all damages and costs awarded in such suit or proceedings so defended.</p> <p>The foregoing indemnity does not apply to the following:</p> <ul style="list-style-type: none">• Products supplied according to a design other than that of Seller, and which is required by the Purchaser.• Combination of the Product with another product not furnished hereunder unless Seller is a contributory infringer.• Any settlements of a suit or proceeding made without Seller's written consent.
Limitations of Liability	<p>SELLER, ITS CONTRACTORS, AUTHORIZED DEALERS AND SUBCONTRACTORS OR SUPPLIERS OF ANY TIER SHALL NOT BE LIABLE TO PURCHASER FOR ANY SPECIAL, INDIRECT, INCIDENTAL OR CONSEQUENTIAL DAMAGES ARISING FROM A BREACH OF THIS AGREEMENT.</p> <p>Purchaser's remedies set forth herein are exclusive and the liability of Seller with respect to the breach of this agreement or any contract entered into between the parties pursuant hereto shall not exceed the price of the Product or part on which such liability is based.</p>

KnollKey Lock Program

KnollKey Lock Program General Information

Following is the KnollKey lock policy, applicable to all products.

Key-alike

For the convenience of the user, furniture may be keyed alike at no charge. Write "Key-alike" in the description of your purchase order for any pedestal, overhead, file or other item you wish to have keyed alike.

Using the key-alike instructions, order cores and keys as line items on your purchase order. Do NOT submit a key-alike form. The Knoll East Greenville Lock Center will select key numbers from the standard range of K 001 - K 250. Key numbers will not be repeated unless over 250 sets are ordered. Lock cores keyed-alike will ship separately from the product, ready for field installation.

There is no charge for key-alike orders if placed with the furniture order.

IF THE KEY-ALIKE ORDER IS NOT PLACED AT LEAST TWO WEEKS PRIOR TO THE FURNITURE SHIP DATE, A \$50 HANDLING CHARGE AND AIR FREIGHT CHARGES WILL APPLY.

If product is ordered and shipped random-keyed, additional lock cores for key-alike are billable.

Random-Keying

To specify product keyed-random, write "key-random" in the product description. Random-keyed product is shipped with the lock core factory installed. A shrouded key is included. Random means no effort has been made to match key numbers, or to make them different.

Keys

A Knoll shrouded key is shipped with every lock core. 250 Key numbers are available. For numbers above 250, contact Custom Product Development. Additional keys and key blanks are available. See service parts for more information.

Master Keying

Knoll locks can be controlled by means of a master key. There is no additional per-lock charge for master keying. A letter of approval from the client must accompany orders for master keys.

Installing Lock Cores

Lock cores can be installed or removed in the field by using a change key. Cores must be in the unlocked position to be removed. See service parts for change key pattern number and pricing.

Lock Distribution

All orders for key-alike lock cores/keys are packaged and shipped from the East Greenville Lock Center, regardless of where the pedestals, overhead, or other units are produced. Random keyed product will have cores factory-installed.

How to Specify Key-Alike

Following is an example of how to specify key-alike for a cluster of 10 workstations.

Step 1 - Using the project floorplan, count the number of locks in each workstation.

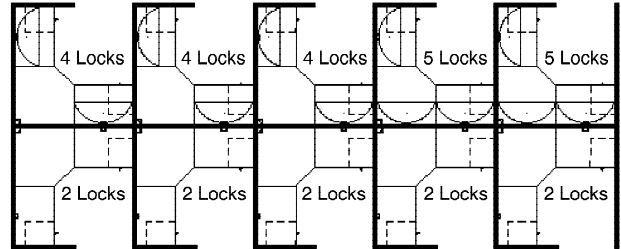

Step 2 - Count the number of workstations with the same quantity of locks. Group together the workstations with a like number of locks.

5 workstations with 2 locks per station
3 workstations with 4 locks per station
2 workstations with 5 locks per station

Step 3 - For the first group (5 sets of 2 locks), enter the number of workstations in the quantity column.

Qty	Pattern #	Description	Unit List	Ext. List
5				

Step 4 - Then enter the pattern number "KSPEC_ _" and add a suffix for the number of locks for that group (i.e., for 2 locks per station, add the suffix "2"). Up to 30 lock cores are available in a set (i.e., KSPEC 30).

Qty	Pattern #	Description	Unit List	Ext. List
5	KSPEC 2	Set of 2 cores/keys	N / C	N / C

Step 5 - Repeat for other groups.

Qty	Pattern #	Description	Unit List	Ext. List
5	KSPEC 2	Set of 2 cores/keys	N / C	N / C
3	KSPEC 4	Set of 4 cores/keys	N / C	N / C
2	KSPEC 5	Set of 5 cores/keys	N / C	N / C

Your Key instructions are complete.

Knoll will select key numbers for each set from 250 available numbers. Additional key numbers are available through Custom Product Development. **For additions to existing installations, specify desired key numbers in the description.**

Service Parts

Pattern #	Description	List Price
KKEY_ _ _	Shrouded Key Specify key number desired	\$5
KBLANK	Shrouded Key Blank	\$5
KSPECB_ _ _	Retrofit Universal Core/Key Specify key number desired	\$18
KCHANGE	Change Key	\$5
KMASTER*	Master Key	\$5

*Note: A letter of approval on company letterhead from the client must accompany all orders for master keys.

General Ordering Information

The Products

This guide encompasses all standard products for this product group.

Sizes

Dimensions listed in this guide are indicated as:

H = height

W = width

D = depth

Dia. = diameter

Rad. = radius

Pricing

All prices shown are list.

How to Order

Select pattern numbers and quantities required for your complete installation. Product questions can be addressed in the specific sections of this guide or by contacting your sales representative or customer resource representative at 1-800-343-5665.

Next, select options (if required), along with colors and finishes appropriate to each product. Reference the Finishes and Fabrics pages for color designations.

On large installations, an item's "designated area" can be specified to assist in product organization and handling.

To expedite complete / correct entry of your order, be certain all pattern numbers, quantities, colors and area identifications are completely specified. Also, include complete purchase order numbers, bill-to and ship-to addresses, a contact name and specific factory shipping dates required.

Mail all orders to:

Knoll, Inc.

1235 Water Street

P.O. Box 157

East Greenville, PA 18041

Attention: Order Entry

Once your order is entered at Knoll, an acknowledgment will be mailed to you. You will be advised of your scheduled shipping date within five days of the original acknowledgment. If it is necessary to revise your order, please contact your customer resource representative.

Sustainability Statement

Sustainable design is a key component of Knoll's environmental focus. Our commitment to social responsibility and a healthy environment has prompted us to further articulate our longstanding environmental programs and, with encouragement and support from our colleagues in the industry, we have re-energized our focus on such "green" initiatives as life cycle analysis and LEED™ certification. Knoll is proud to have contributed to projects that have received LEED certification from the U.S. Green Building Council.

For the latest information on Knoll products that help our customers achieve LEED certification, log on to knoll.com, click on "About Knoll" and then "Environmental Focus."