

| | | |
|--------------------------|--|-----|
| Introduction | Knoll and Sustainable Design | 3 |
| Dividends Horizon System | Dividends Color Program Finishes | 5 |
| | Dividends Legacy Finishes | 6 |
| | Dividends Worksurfaces | 7 |
| | Dividends Table Supports | 19 |
| | Dividends Accessories | 20 |
| | Dividends Electrical | 21 |
| | Dividends T5 Task Lights | 26 |
| Equity System | Equity Finishes | 27 |
| | Equity Generation 1 | 28 |
| | Equity Generation 3 | 30 |
| | Equity service wall accessories | 32 |
| | Equity EW1 Worksurfaces | 33 |
| | Equity EW3 Worksurfaces | 37 |
| | Equity / Dividends style File tops | 39 |
| | Equity Task Light | 40 |
| Morrison System | Morrison System Finishes | 41 |
| | Knoll Color Program | 42 |
| | Morrison System Legacy Finishes | 43 |
| | Morrison Window Panel | 44 |
| | Morrison Connectors, post assemblies | 45 |
| | Morrison miscellaneous | 49 |
| | Trim Cover | 50 |
| | Morrison Rolling Doors | 52 |
| | Morrison Worksurfaces, 1 3/4" | 54 |
| | Morrison Worksurfaces, 1 1/4" | 62 |
| | Morrison Options Worksurfaces, 1 1/4" | 76 |
| | Currents System worksurfaces | 90 |
| | VDT corner and transitional end panels | 91 |
| | Kneehole filler and transitional filler panels | 92 |
| | Return filler panels | 93 |
| | Intermediate shelves | 94 |
| | Morrison shelves and flush counter surface, 1 3/4" | 95 |
| | Morrison shelves and flush counter surface, 1 1/4" | 96 |
| | Morrison Overhead cabinets | 97 |
| | Morrison Network privacy screen | 98 |
| | Morrison vertical storage | 99 |
| | Morrison Network T5 Task Light | 100 |
| | Morrison Options T5 Task Light | 101 |
| Reff System | Reff Finish Options | 102 |
| | Reff Panels | 104 |
| | Reff Worksurfaces | 112 |
| | Reff support components | 133 |
| | Reff Cabinetry | 136 |
| | Reff Overhead storage | 157 |
| | Reff accessories | 179 |
| AutoStrada System | AutoStrada Finishes | 180 |
| | AutoStrada Worksurfaces | 181 |
| | AutoStrada Cabinets | 182 |
| | AutoStrada Lower Storage | 183 |
| | AutoStrada T5 Task Light | 184 |
| Reuter | T5 Task Light for Reuter Overhead Storage | 185 |
| The Graham Collection | The Graham Collection T5 Task Light | 186 |

| | |
|------------------------------|-----|
| Alpha-Numeric Index | 187 |
| Selling Policy | 197 |
| KnollKey Lock Program | 199 |
| General Ordering Information | 200 |

Knoll and Sustainable Design

Each year Knoll sets key initiatives in our journey to sustainability. We are members of a global consortium on energy, have adopted a scientific, metrics-based approach to sustainable product design, and maintain a leadership position in establishing universal, verifiable, sustainability standards for our industry.

Knoll promotes independent third-party certification because it provides the most impartial and trustworthy foundation for industry-wide environmental compliance. Certification by established and respected third parties ensures that all manufacturers are held to the same high standards and that customers can trust a company's declaration about the environmental benefits of its products. Knoll third-party partners include: the International Standards Organization (ISO); Forest Stewardship Council (FSC®); Rainforest Alliance; GREENGUARD® Environmental Institute; and Chicago Climate Exchange (CCX®).

In addition, Knoll is aligned with the U.S. Green Building Council and can help companies, healthcare organizations and educational institutions achieve Leadership in Energy and Environmental Design (LEED®) workplace certification.

1. Global Climate Change

- Knoll is a sponsor of the Clinton Global Initiative, which brings together a community of global leaders to devise and implement solutions to some of the world's most pressing challenges, including environmental change.
- Knoll is a member of the Chicago Climate Exchange, which promotes greenhouse gas reduction through the trading of credits earned for reducing emissions.
- Knoll has a comprehensive Energy Management Program to increase energy efficiency in products and processes.

2. Life Cycle Assessment (LCA) Tool

- Life Cycle Assessment is a science-based measurement of a product's environmental impacts throughout its life cycle, from raw materials sourcing through manufacture, shipping, use and re-use or end-of-life. LCA enables cradle-to-cradle implementation of sustainable practices.
- Knoll has partnered with The Green Standard.org to develop an affordable, universal ISO-compliant computer-based LCA tool that can be used by the entire contract furniture industry and is partnering on the development of an Environmental Product Declaration System (EPDs) for Knoll products. EPDs are verified documents containing LCA results and additional environmental performance information about a product.

3. Setting Industry Standards

- Knoll partners with MTS (The Institute for Market Transformation to Sustainability) to develop the SMaRT® Consensus Sustainable Products Standards, a set of consensus-based sustainable product standards based on the LEED® model, for all building products, fabric, apparel, flooring and carpet. MTS, the developer of SMaRT®, is an accredited American National Standards Institute (ANSI) standard developer.
- Knoll has established FSC® (Forest Stewardship Council) certified wood as the standard for general office open plan office systems, casegoods and tables.
- Knoll also participates in an ongoing BIFMA (Business and Institutional Furniture Manufacturers Association) initiative to establish level™ sustainability standards for the contract furniture industry.
- Our goal is to encourage all manufacturers in the contract furniture industry and related industries to adopt standards that will lead to sustainable products and practices.

For more information about Knoll and sustainable design, visit knoll.com/environment.

All dimensions in this price list are nominal and follow standard size convention of its respective product line.

Core Paint and Laminate Finishes

Specify Core finishes for all new customers

| Order Code | Color Name | Old Order Code | Paint Grade | Paint Finishes | Plastic Panel Trim Finishes | DS1 Pedestal and Overhead Plastic Finishes | Laminate Finishes | 2mm Edgeband Finishes | Techwood Finishes | Cascade Worksurface Finishes |
|------------|---|----------------|-------------|----------------|-----------------------------|--|-------------------|-----------------------|-------------------|------------------------------|
| 611 | Beige Mist Metallic | | P2 | • | | | | | | |
| 118 | Bright White | LH | P3 | • | | • | • | • | | • |
| 112 | Brown | | P1 | • | | • | | | | |
| 123 | Brushed Grey | | | | | | • | | | |
| 122 | Brushed Sand | | | | | | • | | | |
| 113 | Dark Grey | Y3 | P1 | • | • | • | | • | | |
| 128 | Fog | G | | | | | • | • | | |
| 114 | Folkstone Grey | | P1 | • | | • | • | • | | • |
| 111 | Jet Black | 27 | P1 | • | | • | • | • | | |
| 124 | Medium Cherry | | | | | | • | • | | • |
| 115 | Medium Grey | Y2 | P1 | • | • | • | | • | | |
| 612 | Medium Metallic Grey | J | P2 | • | | | | | | |
| 121 | Micro Grey | | | | | | • | | | |
| 129 | Micro Sand | | | | | | • | | | |
| 126 | Natural Cherry | | | | | | • | • | | • |
| 125 | Natural Maple | | | | | | • | • | | • |
| 119 | Pumice | LB, F | | | | | • | • | | • |
| 116 | Sandstone | | P1 | • | | • | | | | |
| 613 | Silver | 3 | P3 | • | | | | | | |
| 117 | Soft Grey | E, M42 | P1 | • | • | • | • | • | | • |
| 127 | Walnut | | | | | | • | • | | • |
| Y811 | Natural Techwood | | | | | | | | • | |
| Y821 | Blonde Maple Techwood (formerly known as Maple Techwood) | | | | | | | | • | |
| Y831 | Light Cherry Techwood (formerly known as Cherry Techwood) | | | | | | | | • | |

Note: All Dividends Horizon products except DS1 and DS2 pedestals and doublewide pedestals are painted with a textured finish excluding 613 Silver which is available as a smooth finish only.

X and Y base tables and the freestanding screen kits are always painted with a textured finish, including 613 Silver.

Note: Laminates and other finishes may vary in color due to different dye lots. Slight variations are to be expected.

| | | | | | | |
|---------------------------|------------------------|-----------------------------|------------------------|------------------------|-----------------------------|---------------------------|
| Panel base raceway covers | Plastic panel trim | DS1 pedestal drawer plugs | 2mm Edge Work-surfaces | 2mm Edge Work-surfaces | Techwood edge work-surfaces | Cascade edge work-surface |
| Steel tile inserts | PVC post assemblies | DS1 pedestal handles | 15" deep counters | 15" deep counters | 15" deep counters | |
| D1 style tile supports | Beltway raceway covers | DS1 Overhead door end plugs | Overhead doors | Overhead doors | Overhead doors | |
| Overhead cabinets | Power pole covers | | Credenza top and doors | Credenza tops | Credenza doors | |
| Pedestal case and fronts | | | Overdesk doors | Overdesk doors | Overdesk doors | |
| | | | | | Series 2 overhead door | |

Most products introduced after 2004 are not available in Legacy finishes. See individual pricing pages for availability. Specify Legacy finishes to match existing product only. Legacy finishes are not available for new customers.

Trim Finishes

- Panel top caps
- Panel post trim
- Pedestal drawer top caps
- Overhead drawer top caps
- Pedestal drawer pulls
 - Y1 Pewter

Paint Finishes

- Panel base raceway covers
- Panel tiled insert supports
- Solid Steel panel inserts
- Perforated steel panel inserts
- Embossed steel panel inserts
- Overhead storage components
- Pedestals
- Desk components
- Metal panel topcaps and trim

P1 Finishes

- Y1 Pewter

P2 Finishes

- H Beige Metallic
- W Light Tan Metallic

All other Knoll paint finishes and custom finishes (Series 2 components only)

Laminates

Worksurfaces

An upcharge applies where specifying Legacy laminates. Add an amount equal to 10% of the solid PVC edgeband list price to the price of any product specified with a Legacy laminate.

- MC Caramel Maple
- CM Clear Maple
- M1 Light Grey
- PA Pearwood
- SD Sand
- B Snow
- WM Warm Cherry
- MR6 Winter Grey Matrix

Note: Laminates and other finishes may vary in color due to different dye lots. Slight variations are to be expected.

Worksurface Edges

2mm edgeband

- MC Caramel Maple
- CM Clear Maple
- Y3 Dark Grey
- Y2 Medium Grey
- MT Metal
- Y1 Pewter
- SD Sand
- B Snow
- WM Warm Cherry

Dividends Worksurfaces
Rectangular 18" Deep
Rectangular 18" Deep + Post

Standard Specials Systems

| description | w | d | t | pattern no. | PVC edge | woodgrain PVC edge | metal edge | techgrain w/ techgrain edge |
|---|-----|-----|--------|------------------|----------|--------------------|------------|-----------------------------|
| 18" Deep Rectangular, No Grommet  | 18" | 18" | 1 1/4" | D1R1818NQ | \$173. | \$190. | \$208. | \$421. |
| 18" Deep Rectangular, No Grommet Post Condition | 21" | 18" | 1 1/4" | D1R2118NQ | 177. | 195. | 212. | 430. |
| | 27" | 18" | 1 1/4" | D1R2718NQ | 184. | 202. | 221. | 452. |
| | 33" | 18" | 1 1/4" | D1R3318NQ | 207. | 228. | 248. | 474. |
| | 39" | 18" | 1 1/4" | D1R3918NQ | 240. | 264. | 288. | 497. |
| | 45" | 18" | 1 1/4" | D1R4518NQ | 266. | 293. | 319. | 518. |
| | 51" | 18" | 1 1/4" | D1R5118NQ | 283. | 312. | 340. | 537. |
| | 57" | 18" | 1 1/4" | D1R5718NQ | 308. | 339. | 370. | 557. |
| | 63" | 18" | 1 1/4" | D1R6318NQ | 332. | 365. | 398. | 578. |
| | 69" | 18" | 1 1/4" | D1R6918NQ | 350. | 386. | 421. | 598. |
| | 75" | 18" | 1 1/4" | D1R7518NQ | 375. | 413. | 450. | 623. |
| | 81" | 18" | 1 1/4" | D1R8118NQ | 395. | 435. | 474. | 647. |
| | 87" | 18" | 1 1/4" | D1R8718NQ | 440. | 484. | 528. | 671. |
| | 93" | 18" | 1 1/4" | D1R9318NQ | 487. | 536. | 585. | 696. |
| | 99" | 18" | 1 1/4" | D1R9918NQ | 546. | 601. | 655. | 755. |

| Order Code | Ordering Information | Included with: | Options |
|--|------------------------|---------------------|---|
| "D" Worksurface | "D" Worksurface | Worksurfaces | Worksurfaces |
| <i>Example:</i> D1R 1818N Q, 114, 114 | 1. Pattern Number | | • Center-Located Edge Grommet |
| D1R Pattern Number | 2. Laminate Finish | | To specify, replace the "N" suffix from the pattern number with "G" . |
| 1818G Q | 3. Edge Band Finish | | Add \$18. |
| 114 Folkstone Grey Laminate | | | • Woodgrain PVC edge |
| 114 Folkstone grey Edge Band | | | • Metal edge |

Dividends Worksurfaces
Rectangular 24" Deep
Rectangular 24" Deep + Post

| description | w | d | t | pattern no. | PVC edge | woodgrain PVC edge | metal edge | techgrain w/ techgrain edge |
|---|------|-----|--------|-------------------|----------|--------------------|------------|-----------------------------|
| 24" Deep Rectangular, No Grommet  | 102" | 24" | 1 1/4" | D1R10224NQ | \$676. | \$744. | \$811. | \$879. |
| | 108" | 24" | 1 1/4" | D1R10824NQ | 735. | 809. | 882. | 956. |
| | 120" | 24" | 1 1/4" | D1R12024NQ | 853. | 938. | 1,024. | 1,109. |
| 24" Deep Rectangular, No Grommet Post Condition | 21" | 24" | 1 1/4" | D1R2124NQ | 185. | 204. | 222. | 444. |
| | 27" | 24" | 1 1/4" | D1R2724NQ | 214. | 235. | 256. | 470. |
| | 33" | 24" | 1 1/4" | D1R3324NQ | 237. | 261. | 285. | 494. |
| | 39" | 24" | 1 1/4" | D1R3924NQ | 271. | 299. | 326. | 520. |
| | 45" | 24" | 1 1/4" | D1R4524NQ | 303. | 334. | 364. | 545. |
| | 51" | 24" | 1 1/4" | D1R5124NQ | 329. | 362. | 395. | 575. |
| | 57" | 24" | 1 1/4" | D1R5724NQ | 355. | 391. | 426. | 602. |
| | 63" | 24" | 1 1/4" | D1R6324NQ | 384. | 422. | 460. | 629. |
| | 69" | 24" | 1 1/4" | D1R6924NQ | 400. | 440. | 480. | 656. |
| | 75" | 24" | 1 1/4" | D1R7524NQ | 430. | 472. | 515. | 687. |
| | 81" | 24" | 1 1/4" | D1R8124NQ | 454. | 500. | 545. | 717. |
| | 87" | 24" | 1 1/4" | D1R8724NQ | 513. | 565. | 616. | 747. |
| | 93" | 24" | 1 1/4" | D1R9324NQ | 558. | 614. | 670. | 776. |
| | 99" | 24" | 1 1/4" | D1R9924NQ | 617. | 679. | 740. | 835. |

Ordering Information

Worksurfaces

1. Pattern Number
2. Laminate Finish
3. Edge Band Finish

Order Code

Worksurfaces

Example: **D1R 4524NQ, 114, 114**

D1R Pattern Number

4524N Q

114 Folkstone Grey Laminate

114 Folkstone Grey Edge Band

Included with:

Worksurfaces

Options

Worksurfaces

- Center-Located Edge Grommet
To specify, replace the "N" suffix from the pattern number with "G".
Add \$18.
- Woodgrain PVC edge
- Metal edge

Dividends Worksurfaces
Rectangular 30" Deep
Rectangular 30" Deep + Post

| description | w | d | t | pattern no. | PVC edge | woodgrain PVC edge | metal edge | techgrain w/ techgrain edge |
|---|------|-----|--------|-------------------|----------|--------------------|------------|-----------------------------|
| 30" Deep Rectangular, No Grommet | 102" | 30" | 1 1/4" | D1R10230NQ | \$788. | \$867. | \$946. | \$1,024. |
| | 108" | 30" | 1 1/4" | D1R10830NQ | 847. | 932. | 1,016. | 1,101. |
| | 114" | 30" | 1 1/4" | D1R11430NQ | 906. | 997. | 1,087. | 1,178. |
| | 120" | 30" | 1 1/4" | D1R12030NQ | 964. | 1,060. | 1,157. | 1,253. |
| 30" Deep Rectangular, No Grommet Post Condition | 27" | 33" | 1 1/4" | D1R2730NQ | 266. | 292. | 319. | 496. |
| | 33" | 30" | 1 1/4" | D1R3330NQ | 294. | 323. | 353. | 530. |
| | 39" | 30" | 1 1/4" | D1R3930NQ | 321. | 353. | 385. | 565. |
| | 45" | 30" | 1 1/4" | D1R4530NQ | 355. | 391. | 426. | 601. |
| | 51" | 30" | 1 1/4" | D1R5130NQ | 402. | 443. | 483. | 627. |
| | 57" | 30" | 1 1/4" | D1R5730NQ | 444. | 488. | 532. | 653. |
| | 63" | 30" | 1 1/4" | D1R6330NQ | 493. | 543. | 592. | 679. |
| | 69" | 30" | 1 1/4" | D1R6930NQ | 513. | 565. | 616. | 703. |
| | 75" | 30" | 1 1/4" | D1R7530NQ | 548. | 602. | 657. | 736. |
| | 81" | 30" | 1 1/4" | D1R8130NQ | 582. | 640. | 698. | 768. |
| | 87" | 30" | 1 1/4" | D1R8730NQ | 625. | 688. | 750. | 800. |
| | 93" | 30" | 1 1/4" | D1R9330NQ | 670. | 737. | 804. | 832. |
| | 99" | 30" | 1 1/4" | D1R9930NQ | 729. | 802. | 875. | 948. |

Ordering Information

Worksurfaces

1. Pattern Number
2. Laminate Finish
3. Edge Band Finish

Order Code

Worksurfaces

Example: **D1R 6330N Q, 114, 114**

D1R Pattern Number
6330N Q

114 Folkstone Grey Laminate

114 Folkstone Grey Edge Band

Included with:

Worksurfaces

Options:

Worksurfaces

- Center-Located Edge Grommet
To specify, replace the "N" suffix from the pattern number with "G".
Add \$18.
- Woodgrain PVC edge
- Metal edge

Dividends Worksurfaces
Rectangular 36" Deep
Rectangular 36" Deep + Post

Standard Specials Systems

| description | w | d | thickness | pattern no. | PVC edge | woodgrain PVC edge | metal edge | techgrain w/ techgrain edge |
|--|------|--------|-------------------|-------------------|----------|--------------------|------------|-----------------------------|
| 36" Deep Rectangular, No Grommet | 30" | 36" | 1 1/4" | D1R3036NQ | \$529. | \$582. | \$635. | \$688. |
| | 36" | 36" | 1 1/4" | D1R3636NQ | 553. | 608. | 664. | 719. |
| | 42" | 36" | 1 1/4" | D1R4236NQ | 556. | 612. | 667. | 723. |
| | 48" | 36" | 1 1/4" | D1R4836NQ | 562. | 618. | 674. | 731. |
| | 54" | 36" | 1 1/4" | D1R5436NQ | 569. | 626. | 683. | 775. |
| | 78" | 36" | 1 1/4" | D1R7836NQ | 751. | 826. | 901. | 976. |
| | 84" | 36" | 1 1/4" | D1R8436NQ | 810. | 891. | 972. | 1,053. |
| | 90" | 36" | 1 1/4" | D1R9036NQ | 869. | 956. | 1,043. | 1,130. |
| | 96" | 36" | 1 1/4" | D1R9636NQ | 928. | 1,021. | 1,114. | 1,206. |
| | 102" | 36" | 1 1/4" | D1R10236NQ | 987. | 1,086. | 1,184. | 1,283. |
| | 108" | 36" | 1 1/4" | D1R10836NQ | 1,046. | 1,151. | 1,255. | 1,360. |
| | 114" | 36" | 1 1/4" | D1R11436NQ | 1,105. | 1,216. | 1,326. | 1,437. |
| 120" | 36" | 1 1/4" | D1R12036NQ | 1,164. | 1,280. | 1,397. | 1,513. | |
| 36" Deep Rectangular, No Grommet Post Condition | 30" | 36" | 1 1/4" | D1R3336NQ | 529. | 582. | 635. | 688. |
| | 39" | 36" | 1 1/4" | D1R3936NQ | 553. | 608. | 664. | 719. |
| | 45" | 36" | 1 1/4" | D1R4536NQ | 556. | 612. | 667. | 723. |
| | 51" | 36" | 1 1/4" | D1R5136NQ | 562. | 618. | 674. | 731. |
| | 57" | 36" | 1 1/4" | D1R5736NQ | 569. | 626. | 683. | 775. |
| | 63" | 36" | 1 1/4" | D1R6336NQ | 628. | 691. | 753. | 816. |
| | 69" | 36" | 1 1/4" | D1R6936NQ | 691. | 761. | 830. | 899. |
| | 75" | 36" | 1 1/4" | D1R7536NQ | 751. | 826. | 901. | 976. |
| | 81" | 36" | 1 1/4" | D1R8136NQ | 810. | 891. | 972. | 1,053. |
| | 87" | 36" | 1 1/4" | D1R8736NQ | 869. | 956. | 1,043. | 1,130. |
| | 93" | 36" | 1 1/4" | D1R9336NQ | 910. | 1,001. | 1,092. | 1,183. |
| | 99" | 36" | 1 1/4" | D1R9936NQ | 947. | 1,042. | 1,136. | 1,231. |

Ordering Information

Worksurfaces

1. Pattern Number
2. Laminate Finish
3. Edge Band Finish

Order Code

Worksurfaces

Example: **D1R 3036N Q, 114, 114**

D1R Pattern Number
3036N Q

114 Folkstone Grey
Laminate

114 Folkstone Grey Edge
Band

Included with:

Worksurfaces

Options

Worksurfaces

- Center-Located Edge Grommet
To specify, replace the "N" suffix from the pattern number with "G".
Add \$18.
- Woodgrain PVC edge
- Metal edge

Dividends Worksurfaces

Curvilinear Wave End

Left

| description | 1 | 2 | 3 | A | B | t | pattern no. | PVC edge | woodgrain PVC edge | metal edge | techgrain w/ techgrain edge |
|---|-----------|---------|-----------|-----------|-----------|--------|--------------------|----------|--------------------|------------|-----------------------------|
| Curvilinear Wave End Left No Grommet | 29 1/2" | 23 1/2" | 29 1/2" | 14 15/16" | 2 15/16" | 1 1/4" | D1W303024NQ | \$500. | \$550. | \$600. | \$650. |
|  | 35 13/16" | 17 1/2" | 23 1/2" | 14 15/16" | 2 15/16" | 1 1/4" | D1W362418NQ | 559. | 615. | 671. | 727. |
| | 47 13/16" | 23 1/2" | 35 13/16" | 14 15/16" | 14 15/16" | 1 1/4" | D1W483624NQ | 642. | 706. | 770. | 835. |
| | 53 13/16" | 23 1/2" | 29 1/2" | 14 15/16" | 14 15/16" | 1 1/4" | D1W543024NQ | 649. | 714. | 779. | 844. |
| | 59 13/16" | 17 1/2" | 29 1/2" | 23 7/16" | 14 15/16" | 1 1/4" | D1W603018NQ | 661. | 727. | 793. | 859. |
| | 59 13/16" | 23 1/2" | 29 1/2" | 23 7/16" | 18 7/16" | 1 1/4" | D1W603024NQ | 661. | 727. | 793. | 859. |
| | 59 13/16" | 23 1/2" | 35 1/2" | 17 1/2" | 14 15/16" | 1 1/4" | D1W603624NQ | 739. | 813. | 887. | 961. |
| | 65 13/16" | 23 1/2" | 29 1/2" | 23 7/16" | 15 15/16" | 1 1/4" | D1W663024NQ | 694. | 763. | 833. | 902. |
| | 65 13/16" | 23 1/2" | 35 1/2" | 23 7/16" | 14 15/16" | 1 1/4" | D1W663624NQ | 777. | 855. | 932. | 1,010. |
| | 71 13/16" | 29 1/2" | 35 1/2" | 23 7/16" | 14 15/16" | 1 1/4" | D1W723630NQ | 806. | 887. | 967. | 1,048. |
| | 77 13/16" | 23 1/2" | 29 1/2" | 23 7/16" | 30 7/16" | 1 1/4" | D1W783024NQ | 781. | 859. | 937. | 1,015. |
| | 77 13/16" | 23 1/2" | 35 1/2" | 23 7/16" | 14 15/16" | 1 1/4" | D1W783624NQ | 869. | 956. | 1,043. | 1,130. |
| | 83 13/16" | 23 1/2" | 35 1/2" | 23 7/16" | 14 15/16" | 1 1/4" | D1W843624NQ | 896. | 986. | 1,075. | 1,165. |
| | 89 13/16" | 23 1/2" | 29 1/2" | 23 7/16" | 30 7/16" | 1 1/4" | D1W903024NQ | 886. | 975. | 1,063. | 1,152. |
| | 95 13/16" | 23 1/2" | 29 1/2" | 23 7/16" | 39" | 1 1/4" | D1W963024NQ | 945. | 1,040. | 1,134. | 1,229. |
| | 95 13/16" | 23 1/2" | 35 1/2" | 23 7/16" | 14 15/16" | 1 1/4" | D1W963624NQ | 969. | 1,066. | 1,163. | 1,260. |
| | 95 13/16" | 29 1/2" | 35 1/2" | 23 7/16" | 30 7/16" | 1 1/4" | D1W963630NQ | 969. | 1,066. | 1,163. | 1,260. |

| Order Code | Ordering Information | Included with: | Options |
|--|----------------------|---------------------|--|
| Worksurfaces | Worksurfaces | Worksurfaces | Worksurfaces |
| <i>Example:</i> D1R 303024N Q, 114, 114 | 1. Pattern Number | | • Center-Located Edge Grommet |
| D1R Pattern Number | 2. Laminate Finish | | To specify, replace the "N" suffix from the pattern number with "G". |
| 303024N | 3. Edge Band Finish | | Add \$18. |
| 114 Folkstone Grey Laminate | | | • Woodgrain PVC edge |
| 114 Folkstone Grey Edge Band | | | • Metal edge |

Dividends Worksurfaces

Curvilinear Wave End

Right

Standard Specials Systems

| description | 1 | 2 | 3 | A | B | t | pattern no. | PVC edge | woodgrain PVC edge | metal edge | techgrain w/ techgrain edge |
|---------------------------------------|-----------|-----------|---------|-----------|-----------|--------|--------------------|----------|--------------------|------------|-----------------------------|
| Curvilinear Wave End Right No Grommet | 29 1/2" | 29 1/2" | 23 1/2" | 2 15/16" | 14 15/16" | 1 1/4" | D1W302430NQ | \$500. | \$550. | \$600. | \$650. |
| | 35 13/16" | 23 1/2" | 17 1/2" | 2 15/16" | 14 15/16" | 1 1/4" | D1W361824NQ | 559. | 615. | 671. | 727. |
| | 47 13/16" | 35 15/16" | 23 1/2" | 14 15/16" | 14 15/16" | 1 1/4" | D1W482436NQ | 642. | 706. | 770. | 835. |
| | 53 13/16" | 29 1/2" | 23 1/2" | 14 15/16" | 14 15/16" | 1 1/4" | D1W542430NQ | 649. | 714. | 779. | 844. |
| | 59 13/16" | 29 1/2" | 17 1/2" | 14 15/16" | 23 7/16" | 1 1/4" | D1W601830NQ | 661. | 727. | 793. | 859. |
| | 59 13/16" | 29 1/2" | 23 1/2" | 18 7/16" | 23 7/16" | 1 1/4" | D1W602430NQ | 661. | 727. | 793. | 859. |
| | 59 13/16" | 35 1/2" | 23 1/2" | 14 15/16" | 17 1/2" | 1 1/4" | D1W602436NQ | 739. | 813. | 887. | 961. |
| | 65 13/16" | 29 1/2" | 23 1/2" | 15 15/16" | 23 7/16" | 1 1/4" | D1W662430NQ | 694. | 763. | 833. | 902. |
| | 65 13/16" | 35 1/2" | 23 1/2" | 14 15/16" | 23 7/16" | 1 1/4" | D1W662436NQ | 777. | 855. | 932. | 1,010. |
| | 71 13/16" | 35 1/2" | 29 1/2" | 30 7/16" | 23 7/16" | 1 1/4" | D1W723036NQ | 806. | 887. | 967. | 1,048. |
| | 77 13/16" | 29 1/2" | 23 1/2" | 30 7/16" | 23 7/16" | 1 1/4" | D1W782430NQ | 781. | 859. | 937. | 1,015. |
| | 77 13/16" | 35 1/2" | 23 1/2" | 14 15/16" | 23 7/16" | 1 1/4" | D1W782436NQ | 869. | 956. | 1,043. | 1,130. |
| | 83 13/16" | 35 1/2" | 23 1/2" | 14 15/16" | 23 7/16" | 1 1/4" | D1W842436NQ | 896. | 986. | 1,075. | 1,165. |
| | 89 13/16" | 29 1/2" | 23 1/2" | 30 7/16" | 23 7/16" | 1 1/4" | D1W902430NQ | 886. | 975. | 1,063. | 1,152. |
| | 95 13/16" | 29 1/2" | 23 1/2" | 39" | 23 7/16" | 1 1/4" | D1W962430NQ | 945. | 1,040. | 1,134. | 1,229. |
| | 95 13/16" | 35 1/2" | 23 1/2" | 14 15/16" | 23 7/16" | 1 1/4" | D1W962436NQ | 969. | 1,066. | 1,163. | 1,260. |
| | 95 13/16" | 35 1/2" | 23 1/2" | 30 7/16" | 23 7/16" | 1 1/4" | D1W963036NQ | 969. | 1,066. | 1,163. | 1,260. |

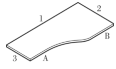

Ordering Information

Worksurfaces

1. Pattern Number
2. Laminate Finish
3. Edge Band Finish

Order Code

Worksurfaces

Example: **D1R 302430N Q, 114, 114**

D1R Pattern Number
302430N

Q14 Folkstone
Grey Laminate

114 Folkstone Grey Edge
Band

Included with:

Worksurfaces

Options

Worksurfaces

- Center-Located Edge Grommet
To specify, replace the "N" suffix from the pattern number with "G".
Add \$18.
- Woodgrain PVC edge
- Metal edge

Dividends Worksurfaces

Rectilinear Corner, Split Top Corner

Standard Specials Systems

| description | 1 | 2 | 3 | 4 | t | pattern no. | PVC edge | woodgrain PVC edge | metal edge | techgrain w/ techgrain edge |
|--|-----|-----|-----|-----|--------|-------------------|----------|--------------------|------------|-----------------------------|
| Rectilinear Corner Worksurface. 30" Deep Return Left 30" Deep Return Right With Grommets | 42" | 42" | 30" | 30" | 1 1/4" | D1C4230GQ | \$612. | \$673. | \$734. | \$1,132. |
| Rectilinear Corner Worksurface. 30" Deep Return Left 30" Deep Return Right No Grommets | 42" | 42" | 30" | 30" | 1 1/4" | D1C4230NQ | 579. | 637. | 695. | 1,102. |
| Rectilinear Corner Worksurface. 36" Deep Return Left 36" Deep Return Right With Grommets | 48" | 48" | 36" | 36" | 1 1/4" | D1C4836GQ | 695. | 765. | 834. | 1,269. |
| Rectilinear Corner Worksurface. 36" Deep Return Left 36" Deep Return Right No Grommets | 48" | 48" | 36" | 36" | 1 1/4" | D1C4836NQ | 662. | 728. | 794. | 1,239. |
| Split Top Corner Worksurface With Grommets | 36" | 36" | 24" | 24" | 1 1/4" | D1CS3624GQ | 1,777. | 1,955. | 2,132. | 3,082. |
| Split Top Corner Worksurface No Grommets | 36" | 36" | 24" | 24" | 1 1/4" | D1CS3624NQ | 1,744. | 1,918. | 2,093. | 3,052. |

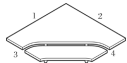

Ordering Information

Worksurfaces

1. Pattern Number
2. Laminate Finish
3. Edge Band Finish

Split Top Corner Worksurfaces

1. Pattern Number
2. Laminate Finish
3. Edge Band Finish

Order Code

Worksurfaces

Example: **D1C 4230G Q 117, 115**

D1C Pattern Number
4230G Q

117 Soft Grey Laminate

115 Medium Grey Edge Band

Split Top Corner Worksurfaces

Example: **D1CS 3624G Q 117, 117**

D1CS Pattern Number
3624G Q

117 Soft Grey Laminate

117 Soft Grey Edge Band

Included with:

Worksurfaces

- Worksurface
- Panel-to-Worksurface Bracket
- Split Top Corner Worksurfaces

Split Top Corner Worksurfaces

- Front Worksurface
- Back Worksurface
- Split Top Mechanism
- Flat Brackets
- Panel-to-Worksurface Bracket

Options

Worksurfaces

- 2 Center-Located Edge Grommets
- Woodgrain PVC edge
- Metal edge

Worksurfaces

- 2 Center-Located Edge Grommets
- Woodgrain PVC edge
- Metal edge

Dividends Worksurfaces
Curvilinear Corner
“L” Shape-24” Depths

| description | 1 | 2 | 3 | 4 | t | pattern no. | PVC edge | woodgrain PVC edge | metal edge | techgrain w/ techgrain edge |
|--|-----|-----|-----|-----|--------|--------------------|----------|--------------------|------------|-----------------------------|
| Curvilinear Corner “L” Shape Worksurface 24” | 36” | 48” | 24” | 24” | 1 1/4” | D1L3648SSNQ | \$622. | \$684. | \$746. | \$1,120. |
| Deep Returns Left and Right No Grommet | 36” | 54” | 24” | 24” | 1 1/4” | D1L3654SSNQ | 700. | 770. | 840. | 1,260. |
| | 36” | 60” | 24” | 24” | 1 1/4” | D1L3660SSNQ | 771. | 848. | 925. | 1,388. |
| | 36” | 72” | 24” | 24” | 1 1/4” | D1L3672SSNQ | 821. | 903. | 985. | 1,478. |
| | 36” | 78” | 24” | 24” | 1 1/4” | D1L3678SSNQ | 830. | 913. | 996. | 1,494. |
| | 42” | 48” | 24” | 24” | 1 1/4” | D1L4248SSNQ | 629. | 692. | 755. | 1,132. |
| | 42” | 54” | 24” | 24” | 1 1/4” | D1L4254SSNQ | 771. | 848. | 925. | 1,388. |
| | 42” | 84” | 24” | 24” | 1 1/4” | D1L4284SSNQ | 1,036. | 1,140. | 1,243. | 1,865. |
| | 48” | 36” | 24” | 24” | 1 1/4” | D1L4836SSNQ | 622. | 684. | 746. | 1,120. |
| | 48” | 42” | 24” | 24” | 1 1/4” | D1L4842SSNQ | 629. | 692. | 755. | 1,132. |
| | 48” | 54” | 24” | 24” | 1 1/4” | D1L4854SSNQ | 779. | 857. | 935. | 1,402. |
| | 48” | 78” | 24” | 24” | 1 1/4” | D1L4878SSNQ | 923. | 1,015. | 1,108. | 1,661. |
| | 48” | 96” | 24” | 24” | 1 1/4” | D1L4896SSNQ | 1,154. | 1,269. | 1,385. | 2,077. |
| | 54” | 36” | 24” | 24” | 1 1/4” | D1L5436SSNQ | 700. | 770. | 840. | 1,260. |
| | 54” | 42” | 24” | 24” | 1 1/4” | D1L5442SSNQ | 771. | 848. | 925. | 1,388. |
| | 54” | 48” | 24” | 24” | 1 1/4” | D1L5448SSNQ | 779. | 857. | 935. | 1,402. |
| | 60” | 36” | 24” | 24” | 1 1/4” | D1L6036SSNQ | 771. | 848. | 925. | 1,388. |
| | 72” | 36” | 24” | 24” | 1 1/4” | D1L7236SSNQ | 821. | 903. | 985. | 1,478. |
| | 78” | 36” | 24” | 24” | 1 1/4” | D1L7836SSNQ | 830. | 913. | 996. | 1,494. |
| | 84” | 42” | 24” | 24” | 1 1/4” | D1L8442SSNQ | 1,036. | 1,140. | 1,243. | 1,865. |
| | 96” | 48” | 24” | 24” | 1 1/4” | D1L9648SSNQ | 1,154. | 1,269. | 1,385. | 2,077. |

Ordering Information

1. **Worksurfaces**
2. Pattern Number
3. Laminate Finish
4. Edge Band Finish

Order Code

| Worksurfaces | |
|---|--------------------|
| <i>Example:</i> D1L 3648SSN Q M42, E | |
| D1L | Pattern Number |
| 3648SSN | |
| M42 | Soft grey laminate |
| E | Edge Band |

Included With:

Worksurfaces
 Worksurface
 Panel-to-Worksurface Bracket

Options

- Worksurfaces**
- 2 center-located edge grommets
 To specify, replace the “N” suffix from the pattern number with “G”
Add \$28
 - Woodgrain PVC edge
 - Metal edge

Dividends Worksurfaces

Curvilinear Corner

"L" Shape-30" Depths

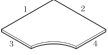
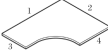
| description | 1 | 2 | 3 | 4 | t | pattern no. | PVC edge | woodgrain PVC edge | metal edge | techgrain w/ techgrain edge |
|---|-----|-----|-----|-----|--------|--------------------|----------|--------------------|------------|-----------------------------|
| Curvilinear Corner "L" Shape Worksurface 30" | 42" | 42" | 30" | 30" | 1 1/4" | D1L4242DDNQ | \$679. | \$747. | \$815. | \$1,222. |
| Deep Returns Left and Right No Grommet | 42" | 60" | 30" | 30" | 1 1/4" | D1L4260DDNQ | 791. | 870. | 949. | 1,424. |
|  | 42" | 66" | 30" | 30" | 1 1/4" | D1L4266DDNQ | 829. | 912. | 995. | 1,492. |
| | 42" | 72" | 30" | 30" | 1 1/4" | D1L4272DDNQ | 868. | 955. | 1,042. | 1,562. |
| | 48" | 60" | 30" | 30" | 1 1/4" | D1L4860DDNQ | 829. | 912. | 995. | 1,492. |
| | 48" | 66" | 30" | 30" | 1 1/4" | D1L4866DDNQ | 867. | 954. | 1,040. | 1,561. |
| | 48" | 72" | 30" | 30" | 1 1/4" | D1L4872DDNQ | 906. | 997. | 1,087. | 1,631. |
| | 48" | 84" | 30" | 30" | 1 1/4" | D1L4884DDNQ | 1,024. | 1,126. | 1,229. | 1,843. |
|  | 48" | 96" | 30" | 30" | 1 1/4" | D1L4896DDNQ | 1,142. | 1,256. | 1,370. | 2,056. |
| | 60" | 42" | 30" | 30" | 1 1/4" | D1L6042DDNQ | 791. | 870. | 949. | 1,424. |
| | 60" | 48" | 30" | 30" | 1 1/4" | D1L6048DDNQ | 829. | 912. | 995. | 1,492. |
| | 66" | 42" | 30" | 30" | 1 1/4" | D1L6642DDNQ | 829. | 912. | 995. | 1,492. |
| | 66" | 48" | 30" | 30" | 1 1/4" | D1L6648DDNQ | 867. | 954. | 1,040. | 1,561. |
| | 72" | 42" | 30" | 30" | 1 1/4" | D1L7242DDNQ | 868. | 955. | 1,042. | 1,562. |
| | 72" | 48" | 30" | 30" | 1 1/4" | D1L7248DDNQ | 906. | 997. | 1,087. | 1,631. |
| | 84" | 48" | 30" | 30" | 1 1/4" | D1L8448DDNQ | 1,024. | 1,126. | 1,229. | 1,843. |
| | 96" | 48" | 30" | 30" | 1 1/4" | D1L9648DDNQ | 1,142. | 1,256. | 1,370. | 2,056. |

Ordering Information

1. Worksurfaces
2. Pattern Number
3. Laminate Finish
4. Edge Band Finish

Order Code

| Worksurfaces | |
|-----------------|--------------------------------|
| <i>Example:</i> | D1L 4272DDN Q, 117, 117 |
| D1L | Pattern Number |
| 4272DDN | |
| Q17 | Soft Grey laminate |
| 117 | Soft Grey Edge Band |

Included with:

Worksurfaces
 Worksurface
 Panel-to-Worksurface Bracket

Options

- Worksurfaces**
- 2 center-located edge grommets
 To specify, replace the "N" suffix from the pattern number with "G"
Add \$28
 - Woodgrain PVC edge
 - Metal edge

Dividends Worksurfaces

Curvilinear Corner

"L" Shape-Mixed Depths

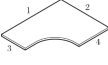
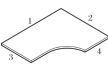
| description | 1 | 2 | 3 | 4 | t | pattern no. | PVC edge | woodgrain PVC edge | metal edge | techgrain w/ techgrain edge |
|---|---|-----|-----|-----|--------|--------------------|--------------------|--------------------|------------|-----------------------------|
| Curvilinear Corner "L" Shape Worksurface 24" Deep Return Left and 30" Deep Return Right | 36" | 48" | 24" | 30" | 1 1/4" | D1L3648SDNQ | \$656. | \$722. | \$787. | \$1,181. |
|  | 36" | 54" | 24" | 30" | 1 1/4" | D1L3654SDNQ | 730. | 803. | 876. | 1,314. |
| | 42" | 42" | 24" | 30" | 1 1/4" | D1L4242SDNQ | 663. | 729. | 796. | 1,193. |
| | 42" | 48" | 24" | 30" | 1 1/4" | D1L4248SDNQ | 670. | 737. | 804. | 1,206. |
| | 42" | 66" | 24" | 30" | 1 1/4" | D1L4266SDNQ | 804. | 884. | 965. | 1,447. |
| | 42" | 72" | 24" | 30" | 1 1/4" | D1L4272SDNQ | 843. | 927. | 1,012. | 1,517. |
| | 48" | 42" | 24" | 30" | 1 1/4" | D1L4842SDNQ | 670. | 737. | 804. | 1,206. |
| | 48" | 78" | 24" | 30" | 1 1/4" | D1L4878SDNQ | 902. | 992. | 1,082. | 1,624. |
| | 48" | 84" | 24" | 30" | 1 1/4" | D1L4884SDNQ | 961. | 1,057. | 1,153. | 1,730. |
| | 54" | 36" | 24" | 30" | 1 1/4" | D1L5436SDNQ | 730. | 803. | 876. | 1,314. |
| | 66" | 42" | 24" | 30" | 1 1/4" | D1L6642SDNQ | 804. | 884. | 965. | 1,447. |
| | 84" | 48" | 24" | 30" | 1 1/4" | D1L8448SDNQ | 961. | 1,057. | 1,153. | 1,730. |
| | Curvilinear Corner "L" Shape Worksurface 30" Deep Return Left and 24" Deep Return Right | 36" | 48" | 30" | 24" | 1 1/4" | D1L3648DSNQ | 656. | 722. | 787. |
|  | 42" | 42" | 30" | 24" | 1 1/4" | D1L4242DSNQ | 663. | 729. | 796. | 1,193. |
| | 42" | 48" | 30" | 24" | 1 1/4" | D1L4248DSNQ | 670. | 737. | 804. | 1,206. |
| | 42" | 66" | 30" | 24" | 1 1/4" | D1L4266DSNQ | 804. | 884. | 965. | 1,447. |
| | 42" | 72" | 30" | 24" | 1 1/4" | D1L4272DSNQ | 843. | 927. | 1,012. | 1,517. |
| | 48" | 78" | 30" | 24" | 1 1/4" | D1L4878DSNQ | 902. | 992. | 1,082. | 1,624. |
| | 48" | 84" | 30" | 24" | 1 1/4" | D1L4884DSNQ | 961. | 1,057. | 1,153. | 1,730. |
| | 48" | 96" | 30" | 24" | 1 1/4" | D1L4896DSNQ | 1,079. | 1,187. | 1,295. | 1,942. |
| | 54" | 36" | 30" | 24" | 1 1/4" | D1L5436DSNQ | 730. | 803. | 876. | 1,314. |
| | 66" | 42" | 30" | 24" | 1 1/4" | D1L6642DSNQ | 804. | 884. | 965. | 1,447. |
| | 84" | 48" | 30" | 24" | 1 1/4" | D1L8448DSNQ | 961. | 1,057. | 1,153. | 1,730. |

Ordering Information

- Worksurfaces**
1. Pattern Number
 2. Laminate Finish
 3. Edge Band Finish

Note: "S" = 24"D
"D" = 30"D

Order Code

Worksurfaces

Example: **D1L 4272SDN Q, CH, Y1**

| | |
|----------------|------------------|
| D1L | Pattern Number |
| 4272SDN | |
| QH | Chiffon Laminate |
| Y1 | Pewter edge band |

Included with:

- Worksurfaces**
- Worksurface
 - Panel-to-worksurface bracket



Options

- Worksurfaces**
- 2 center-located edge grommets
To specify, replace the "N" suffix from the pattern number with "G"
Add \$28
 - Woodgrain PVC edge
 - Metal edge

Dividends Worksurfaces

“D”, “P” and “9” Peninsula, And Corner Round Worksurface

Standard Specials Systems

| description | w | d | pattern no. | PVC edge | woodgrain PVC edge | metal edge | techgrain w/ techgrain edge |
|--|----|------------------|--------------------|----------|--------------------|------------|-----------------------------|
| “D” Peninsula Worksurface  | 30 | 24 | D1D3024NQ | \$440. | \$484. | \$528. | \$792. |
| | 30 | 30 | D1D3030NQ | 487. | 536. | 584. | 877. |
| | 36 | 24 | D1D3624NQ | 460. | 506. | 552. | 828. |
| | 36 | 30 | D1D3630NQ | 507. | 558. | 608. | 913. |
| | 54 | 24 | D1D5424NQ | 519. | 571. | 623. | 934. |
| | 54 | 30 | D1D5430NQ | 647. | 712. | 776. | 1,165. |
| | 54 | 36 | D1D5436NQ | 769. | 846. | 923. | 1,384. |
| | 60 | 24 | D1D6024NQ | 578. | 636. | 694. | 1,040. |
| | 60 | 36 | D1D6036NQ | 793. | 872. | 952. | 1,427. |
| | 66 | 24 | D1D6624NQ | 637. | 701. | 764. | 1,147. |
| | 66 | 36 | D1D6636NQ | 813. | 894. | 976. | 1,463. |
| | 72 | 24 | D1D7224NQ | 696. | 766. | 835. | 1,253. |
| | 78 | 24 | D1D7824NQ | 755. | 831. | 906. | 1,359. |
| | 78 | 30 | D1D7830NQ | 803. | 883. | 964. | 1,445. |
| | 78 | 36 | D1D7836NQ | 872. | 959. | 1,046. | 1,570. |
| | 84 | 24 | D1D8424NQ | 814. | 895. | 977. | 1,465. |
| | 84 | 30 | D1D8430NQ | 862. | 948. | 1,034. | 1,552. |
| | 84 | 36 | D1D8436NQ | 931. | 1,024. | 1,117. | 1,676. |
| | 96 | 24 | D1D9624NQ | 930. | 1,023. | 1,116. | 1,674. |
| | 96 | 30 | D1D9630NQ | 955. | 1,051. | 1,146. | 1,719. |
| 96 | 36 | D1D9636NQ | 1,049. | 1,154. | 1,259. | 1,888. | |
| Conferencing worksurface (left hand shown)  | 60 | 48 | DB1BD48DLQ | 1,118. | 1,230. | 1,342. | 2,846. |
| | 60 | 48 | DB1BD48DRQ | 1,118. | 1,230. | 1,342. | 2,846. |
| Blended “D” Peninsula Worksurface (left hand shown)  | 54 | 48 | D1BD5448DLQ | 766. | 843. | 919. | 3,092. |
| | | 48 | D1BD5448DRQ | 766. | 843. | 919. | 3,092. |
| | | 48 | D1BD5448SLQ | 738. | 812. | 886. | 3,042. |
| | | 48 | D1BD5448SRQ | 738. | 812. | 886. | 3,042. |
| | 60 | 48 | D1BD6048DLQ | 791. | 870. | 949. | 3,197. |
| | | 48 | D1BD6048DRQ | 791. | 870. | 949. | 3,197. |

Ordering Information

- “D” Worksurface**
1. Pattern Number
 2. Laminate Finish
 3. Edge Band Finish

Order Code

“D” Worksurface
Example: **D1BD 5448DL Q, 114, 114**

D1BD Pattern Number
5448 DL Q

114 Folkstone Grey Laminate

114 Folkstone grey Edge Band

Included with:



- “D” Worksurface**
- Worksurface
- Note: Support column and panel-to-worksurface brackets must be ordered separately.

Options

- “D” Worksurfaces**
- Woodgrain PVC edge
 - Metal edge

Dividends Worksurfaces
 “D”, “P” and “9” Peninsula,
 And Corner Round Worksurface

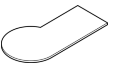
Standard Specials Systems

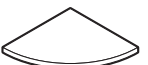
| description | w | d | pattern no. | PVC edge | woodgrain PVC edge | metal edge | techgrain w/ techgrain edge | |
|--|--|----|--------------------|------------------|--------------------|------------|-----------------------------|--------|
| Blended “D” Peninsula Worksurface (left hand shown)  | 60 | 48 | D1BD6048SLQ | \$752. | \$827. | \$902. | \$3,038. | |
| | | 48 | D1BD6048SRQ | 752. | 827. | 902. | 3,038. | |
| | 72 | 42 | D1BD7242DLQ | 820. | 902. | 984. | 3,313. | |
| | | 42 | D1BD7242DRQ | 820. | 902. | 984. | 3,313. | |
| | | 42 | D1BD7242SLQ | 768. | 845. | 922. | 3,263. | |
| | | 42 | D1BD7242SRQ | 768. | 845. | 922. | 3,263. | |
| | 78 | 48 | D1BD7848DLQ | 879. | 967. | 1,055. | 3,734. | |
| | | 48 | D1BD7848DRQ | 879. | 967. | 1,055. | 3,734. | |
| | | 48 | D1BD7848SLQ | 827. | 910. | 992. | 3,684. | |
| | | 48 | D1BD7848SRQ | 827. | 910. | 992. | 3,684. | |
| | 84 | 48 | D1BD8448DLQ | 938. | 1,032. | 1,126. | 4,048. | |
| | | 48 | D1BD8448DRQ | 938. | 1,032. | 1,126. | 4,048. | |
| | | 48 | D1BD8448SLQ | 886. | 975. | 1,063. | 3,821. | |
| | | 48 | D1BD8448SRQ | 886. | 975. | 1,063. | 3,821. | |
| | Peninsula Worksurface, P-shaped  | 54 | 30 | D1P5430NQ | 727. | 800. | 872. | 1,999. |
| | | 60 | 30 | D1P6030NQ | 739. | 813. | 887. | 2,032. |
| 78 | | 36 | D1P7836NQ | 927. | 1,020. | 1,112. | 2,549. | |
| 84 | | 30 | D1P8430NQ | 904. | 994. | 1,085. | 2,486. | |
| 90 | | 30 | D1P9030NQ | 963. | 1,059. | 1,156. | 2,648. | |
| Peninsula Worksurface, 9-shaped  | 54 | 30 | D195430NQ | 727. | 800. | 872. | 1,999. | |
| | 60 | 30 | D196030NQ | 739. | 813. | 887. | 2,032. | |
| | 78 | 36 | D197836NQ | 927. | 1,020. | 1,112. | 2,549. | |
| | 84 | 30 | D198430NQ | 904. | 994. | 1,085. | 2,486. | |
| | 90 | 30 | D199030NQ | 963. | 1,059. | 1,156. | 2,648. | |
| Corner Round Worksurface  | 30 | 30 | D1CRR30Q | 296. | 326. | 355. | 1,302. | |

Ordering Information

- “D” Worksurface**
 1. Pattern Number
 2. Laminate Finish
 3. Edge Band Finish

Order Code

“D” Worksurface
Example: **D1BD 5448DL Q, 114, 114**

D1BD Pattern Number
5448 DL Q

114 Folkstone Grey Laminate

114 Folkstone grey Edge Band

Included with:

- “D” Worksurface**
 • Worksurface
 Note: Support column and panel-to-worksurface brackets must be ordered separately.

Options

- “D” Worksurfaces**
 • Woodgrain PVC edge
 • Metal edge

Dividends Table Supports

Double Y Leg Base

Standard Specials Systems

Dividends Horizon System

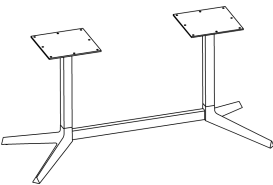
| description | type | pattern no. | P1/P2/P3 |
|--|---|----------------------|----------|
|  <p>Y-Base, Double with stretcher</p> | For use with 60" Wide x 24" or 30" Deep | DT1BYD602430Q | \$965. |
| | For use with 60" Wide x 36" Deep | DT1BYD6036Q | 970. |
| | For use with 66" Wide x 24" or 30" Deep | DT1BYD662430Q | 975. |
| | For use with 66" Wide x 36" Deep | DT1BYD6636Q | 980. |
| | For use with 72" Wide x 24" or 30" Deep | DT1BYD722430Q | 985. |
| | For use with 72" Wide x 36" Deep | DT1BYD7236Q | 990. |
| | For use with 72" Wide x 42" Deep | DT1BYD7242Q | 990. |
| | For use with 78" Wide x 24" or 30" Deep | DT1BYD782430Q | 995. |
| | For use with 78" Wide x 36" Deep | DT1BYD7836Q | 1,000. |
| | For use with 78" Wide x 42" Deep | DT1BYD7842Q | 1,000. |
| | For use with 84" Wide x 24" or 30" Deep | DT1BYD842430Q | 1,005. |
| | For use with 84" Wide x 36" Deep | DT1BYD8436Q | 1,010. |
| | For use with 84" Wide x 42" Deep | DT1BYD8442Q | 1,010. |
| | For use with 90" Wide x 24" or 30" Deep | DT1BYD902430Q | 1,015. |
| | For use with 90" Wide x 36" Deep | DT1BYD9036Q | 1,020. |
| | For use with 90" Wide x 42" Deep | DT1BYD9042Q | 1,020. |
| | For use with 96" Wide x 24" or 30" Deep | DT1BYD962430Q | 1,025. |
| | For use with 96" Wide x 36" Deep | DT1BYD9636Q | 1,030. |
| | For use with 96" Wide x 42" Deep | DT1BYD9642Q | 1,030. |

Ordering Information

Table Supports:

1. Pattern number
2. Paint Finish

Order Code

Double Y Leg Base:

Example: **DT1BYD,114**

DT1 Dividends Horizon
Table

B Base

YD Double Y

114 Paint Finish

Included with:

Note: Table supports are only available in Knoll core finishes.

| description | width | height | pattern no. | list | P1 | P2 | P3 |
|--|-------|--------|--------------------|--------|------|------|------|
| Coat hook, 4 per pkg. For Flat top cap | | | DP5CHQ | \$226. | | | |
| Wall mounted bracket with cover For 14"h panel mounted sliding door overheads | 30" | 14" | DS3WMC1430Q | | 181. | 197. | 213. |
| | 33" | 14" | DS3WMC1433Q | | 185. | 201. | 217. |
| | 36" | 14" | DS3WMC1436Q | | 185. | 201. | 217. |
| | 42" | 14" | DS3WMC1442Q | | 188. | 205. | 221. |
| | 48" | 14" | DS3WMC1448Q | | 194. | 212. | 229. |
| Wall mounted bracket with cover For 21"h panel mounted sliding door overheads | 30" | 21" | DS3WMC2130Q | | 225. | 246. | 266. |
| | 33" | 21" | DS3WMC2133Q | | 230. | 251. | 271. |
| | 36" | 21" | DS3WMC2136Q | | 230. | 251. | 271. |
| | 42" | 21" | DS3WMC2142Q | | 248. | 271. | 293. |
| | 48" | 21" | DS3WMC2148Q | | 262. | 286. | 309. |

Ordering Information

Coat hook

1. Pattern Number
2. Paint Finish

Wall mounted bracket with cover

1. Pattern Number
2. Paint Finish

Application Notes

Wall mounted bracket with cover

For 60" wide overhead, use (2x) 30" brackets
 For 66" wide overhead, use (2x) 33" brackets
 For 72" wide overhead, use (2x) 36" brackets

Cover is required for aesthetics purpose

Dividends Electrical
Alternative Electrical Specification
 8-wire (2+1) and 10-wire (2+2) Electrical Systems

Dividends Horizon Electrical Specifications

Wiring Diagram

8-wire / 3-circuit (2+1)

INDEPENDENT
 NEUTRAL

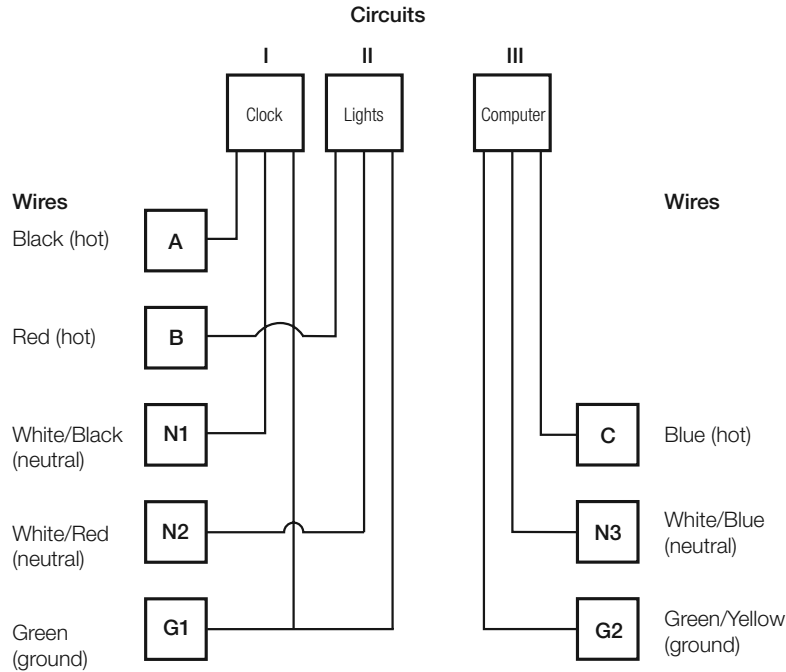

Wiring Diagram

10-wire / 4-circuit (2+2)

INDEPENDENT
 NEUTRAL

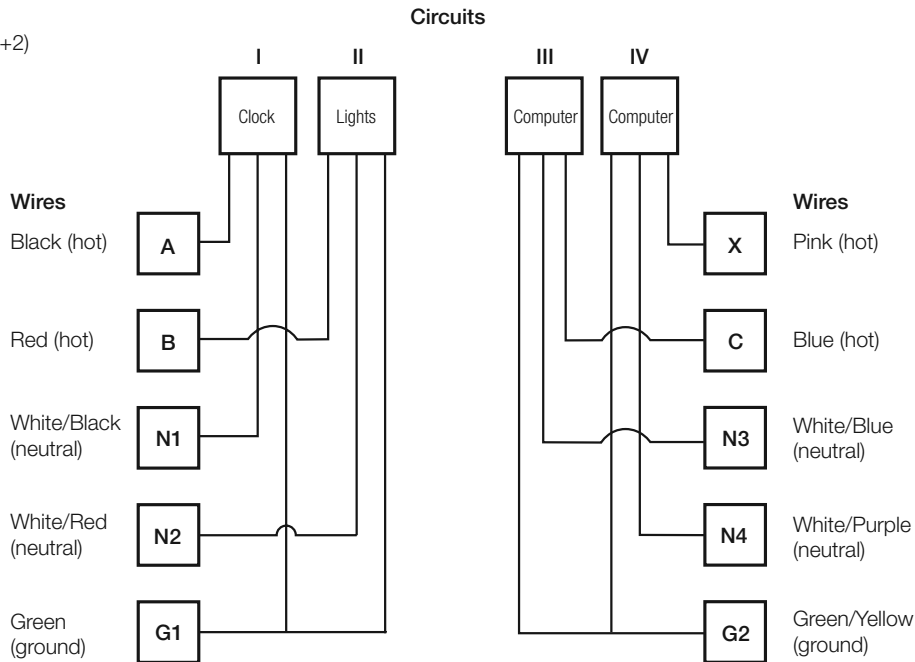







Please note that electrical components (i.e. power module, power jumpers and receptacles) from the 8 and 10-wire electrical systems with independent neutrals **cannot** be used with the 8-wire (3+1 and 2+2) and 10-wire (3+3) electrical systems that have shared neutrals.

Base Raceway

Power Modules, Connectors and Jumpers

8-wire (2+1) and 10-wire (2+2)

| description | type | pattern no. | list | OE | OT |
|---|--------------------|-------------------------|------|--------|--------|
| Power Module - Double sided for raceway on both sides  | 24"W Panel | DE(0E/0T)PM24Q | | \$113. | \$117. |
| | 30"W Panel | DE(0E/0T)PM30Q | | 120. | 121. |
| | 36"W Panel | DE(0E/0T)PM36Q | | 134. | 129. |
| | 42"W Panel | DE(0E/0T)PM42Q | | 134. | 136. |
| | 48"W Panel | DE(0E/0T)PM48Q | | 141. | 144. |
| Power Connector (power module-to-power module)  | 12" no post | DE(0E/0T)PCNPQ | | 73. | 87. |
| | 15" with post | DE(0E/0T)PCWPQ | | 79. | 93. |
| Power Jumper  | 18" W Panel | DE(0E/0T)PJ18NPQ | | 92. | 115. |
| | 24" W Panel | DE(0E/0T)PJ24NPQ | | 96. | 121. |
| | 30" W Panel | DE(0E/0T)PJ30NPQ | | 100. | 126. |
| | 36" W Panel | DE(0E/0T)PJ36NPQ | | 105. | 131. |
| | 42" W Panel | DE(0E/0T)PJ42NPQ | | 111. | 137. |
| | 48" W Panel | DE(0E/0T)PJ48NPQ | | 118. | 142. |
| Power Jumper (with post)  | 18" W Panel + Post | DE(0E/0T)PJ18WPQ | | 93. | 119. |
| | 24" W Panel + Post | DE(0E/0T)PJ24WPQ | | 98. | 122. |
| | 30" W Panel + Post | DE(0E/0T)PJ30WPQ | | 101. | 128. |
| | 36" W Panel + Post | DE(0E/0T)PJ36WPQ | | 109. | 134. |
| | 42" W Panel + Post | DE(0E/0T)PJ42WPQ | | 116. | 140. |
| | 48" W Panel + Post | DE(0E/0T)PJ48WPQ | | 125. | 142. |
| Multiple Panel Power Jumper (with or without post)  | 54"W Panel Run | DE(0E/0T)PJ54WPQ | | 132. | 152. |
| | 60"W Panel Run | DE(0E/0T)PJ60WPQ | | 138. | 159. |
| | 66"W Panel Run | DE(0E/0T)PJ66WPQ | | 138. | 159. |
| | 72"W Panel Run | DE(0E/0T)PJ72WPQ | | 147. | 165. |
| | 78"W Panel Run | DE(0E/0T)PJ78WPQ | | 148. | 181. |
| | 84"W Panel Run | DE(0E/0T)PJ84WPQ | | 164. | 185. |
| | 96"W Panel Run | DE(0E/0T)PJ96WPQ | | 168. | 191. |
| Receptacles  | Duplex circuit 1 | DE0DRAQ | 38. | | |
| | Duplex circuit 2 | DE0DRBQ | 38. | | |
| | Duplex circuit 3 | DE0DRCQ | 38. | | |
| | Duplex circuit 4 | DE0DRXQ | 38. | | |

Ordering Information

Order Code

Included with:

Options

Power Jumper

1. Pattern Number

Power Jumper

Example: **DE0EPJ18NPQ**

DE0E Pattern Number

PJ42NPQ

Power Jumper

Note: Double-sided power module will not fit in a panel base raceway with tile to the floor on one side.





Power Jumper

Options

(OE) = 8 wire 2+1
(OT) = 10 wire 2+2

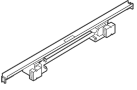
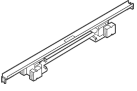
Beltway

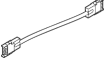
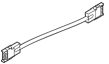
Power Modules, Power Connectors and Power Jumpers

| description | type | pattern no. | OE | OT |
|--|---------------|--------------------|--------|--------|
| Beltway Power Module 1-Side  | 30" | DE(0E/0T)BPM301Q | \$217. | \$232. |
| | 36" | DE(0E/0T)BPM361Q | 225. | 240. |
| | 42" | DE(0E/0T)BPM421Q | 238. | 247. |
| | 48" | DE(0E/0T)BPM481Q | 242. | 257. |
| Beltway Power Module 2-Side  | 30" | DE(0E/0T)BPM302Q | 210. | 242. |
| | 36" | DE(0E/0T)BPM362Q | 218. | 250. |
| | 42" | DE(0E/0T)BPM422Q | 235. | 258. |
| | 48" | DE(0E/0T)BPM482Q | 236. | 266. |
| Beltway Power Connector  | 17" no post | DES(0E/0T)BPCNPQ | 79. | 107. |
| | 20" with post | DES(0E/0T)BPCWPQ | 87. | 109. |
| Beltway Power Jumper (no post)  | 18" | DES(0E/0T)BPJ18NPQ | 104. | 118. |
| | 24" | DES(0E/0T)BPJ24NPQ | 108. | 123. |
| | 30" | DES(0E/0T)BPJ30NPQ | 113. | 130. |
| | 36" | DES(0E/0T)BPJ36NPQ | 118. | 134. |
| | 42" | DES(0E/0T)BPJ42NPQ | 123. | 140. |
| | 48" | DES(0E/0T)BPJ48NPQ | 128. | 145. |
| Beltway Power Jumper (with post)  | 18" | DES(0E/0T)BPJ18WPQ | 107. | 121. |
| | 24" | DES(0E/0T)BPJ24WPQ | 111. | 126. |
| | 30" | DES(0E/0T)BPJ30WPQ | 116. | 130. |
| | 36" | DES(0E/0T)BPJ36WPQ | 120. | 134. |
| | 42" | DES(0E/0T)BPJ42WPQ | 129. | 144. |
| | 48" | DES(0E/0T)BPJ48WPQ | 133. | 148. |
| Multiple Panel Power Jumper (with or without post)  | 54" | DES(0E/0T)BPJ54WPQ | 138. | 152. |
| | 60" | DES(0E/0T)BPJ60WPQ | 142. | 160. |
| | 66" | DES(0E/0T)BPJ66WPQ | 147. | 165. |
| | 72" | DES(0E/0T)BPJ72WPQ | 152. | 168. |
| | 78" | DES(0E/0T)BPJ78WPQ | 156. | 172. |
| | 84" | DES(0E/0T)BPJ84WPQ | 166. | 175. |
| | 96" | DES(0E/0T)BPJ96WPQ | 178. | 192. |

Ordering Information

Beltway Power Jumper
1. Pattern Number

Order Code

Beltway Power Jumper
Example: **DES0EBPJ18NPQ**
DES0EBP Pattern Number
J18NPQ

Included with:



Beltway Power Jumper

Options

Beltway Power Jumper
Options
(0E) = 8 wire 2+1
(0T) = 10 wire 2+2

Beltway

Power Modules, Power Connectors and Power Jumpers

| description | type | pattern no. | OE | OT |
|---|-----------------------|--------------------------|--------|--------|
| 90° Beltway Power Jumper  | 30" beltway panel | DE(0E/0T)PJ120WPQ | \$208. | \$238. |
| | 36" beltway panel | DE(0E/0T)PJ126WPQ | 215. | 246. |
| | 42" beltway panel | DE(0E/0T)PJ138WPQ | 225. | 258. |
| | 48" beltway panel | DE(0E/0T)PJ144WPQ | 234. | 264. |
| Vertical Power Jumper (within same panel)  | | DE(0E/0T)VPJQ | 178. | 184. |
| Vertical Power Jumper (from adjacent panel)  | 30" beltway panel | DE(0E/0T)PJ48WPQ | 125. | 142. |
| | 36"&42" beltway panel | DE(0E/0T)PJ54WPQ | 132. | 152. |
| | 48" beltway panel | DE(0E/0T)PJ60WPQ | 138. | 159. |

Ordering Information

Order Code

Included with:

Options

Beltway Power Jumper

Beltway Power Jumper

Beltway Power Jumper

Beltway Power Jumper

1. Pattern Number



Example: **DES0EBPJ18NPQ**

DES0EBP Pattern Number
J18NPQ

Options

(0E) = 8 wire 2+1
(0T) = 10 wire 2+2

Dividends Electrical
Infeeds
Base Power and Raceway-to-Ceiling Infeeds

| description | length | pattern no. | OE | OT |
|---|---------|---------------------|--------|--------|
| Base Power Infeed (specify left or right)  | 56" | DE(OE/OT)BI56(L/R)Q | \$188. | \$254. |
| Base Power Infeed (reversible)  | 56" | DE(OE/OT)RBI56Q | 250. | 302. |
| Raceway-to-Ceiling Infeed  | 19 1/2' | DE(OE/OT)CI144Q | 285. | 342. |

Ordering Information

Base Power Infeed (L/R)

1. Pattern Number

Order Code

Base Power Infeed (L/R)

Example: **DE18 BI56(L)**

DE18 Pattern Number (left
BI56(L) entry)

Included with:

Base Power Infeed (L/R)

Options

Base Power Infeed

Options

(OE) = 8 wire 2+1
(OT) = 10 wire 2+2

Base Power infeed (L/R):
To Specify direction of entry, add
either and "L" or "R" suffix to the
pattern number.

Dividends T5 Task Lights

Daisy Chain

| description | type | w | d | h | pattern no. | Standard | Advanced |
|---|---------------------------------|-----|----|--------|---------------------------|----------|----------|
| Task Light, starter 9 ft. cord, fused male plug 1 ft. cord, female plug | Use with 24" and wider overhead | 19" | 4" | 1 1/2" | DL3T5E19()DCS()Q | \$308. | n/a |
| | Use with 30" and wider overhead | 25" | 4" | 1 1/2" | DL3T5E25()DCS()Q | 321. | 568. |
| | Use with 42" and wider overhead | 37" | 4" | 1 1/2" | DL3T5E37()DCS()Q | 325. | 591. |
| | Use with 60" and wider overhead | 49" | 4" | 1 1/2" | DL3T5E49()DCS()Q | 351. | 608. |

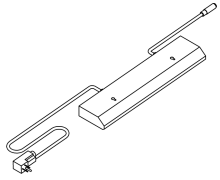

left hand shown

| | | | | | | | |
|---|---------------------------------|-----|----|--------|---------------------------|------|------|
| Task Light, adder 2 ft. cord, male plug 1 ft. cord, female plug | Use with 24" and wider overhead | 19" | 4" | 1 1/2" | DL3T5E19()DCA()Q | 340. | n/a |
| | Use with 30" and wider overhead | 25" | 4" | 1 1/2" | DL3T5E25()DCA()Q | 353. | 600. |
| | Use with 42" and wider overhead | 37" | 4" | 1 1/2" | DL3T5E37()DCA()Q | 357. | 623. |
| | Use with 60" and wider overhead | 49" | 4" | 1 1/2" | DL3T5E49()DCA()Q | 383. | 640. |

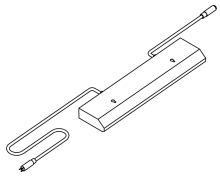

left hand shown

| | | | | | | | |
|--|---------------------------------|-----|----|--------|---------------------------|------|------|
| Task Light, ender 2 ft. cord, male plug | Use with 24" and wider overhead | 19" | 4" | 1 1/2" | DL3T5E19()DCE()Q | 227. | n/a |
| | Use with 30" and wider overhead | 25" | 4" | 1 1/2" | DL3T5E25()DCE()Q | 240. | 487. |
| | Use with 42" and wider overhead | 37" | 4" | 1 1/2" | DL3T5E37()DCE()Q | 244. | 510. |
| | Use with 60" and wider overhead | 49" | 4" | 1 1/2" | DL3T5E49()DCE()Q | 270. | 527. |

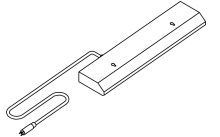

left hand shown

| Order Code | Specification Information | Application Notes |
|---------------------------------|--|---|
| Example: DL3T5E19SDCSLQ | <i>Specify:</i> | Task lights mount into the recess in the underside of overhead cabinets and shelves at least 5" wider than task light width. |
| DL3 Dividends Task Light | Width - Task Lights mount in cabinets and shelves at least 5" wider than light width. | Task lights include T5 cool white (4100K) fluorescent lamp, electronic ballast, prismatic lens, rocker switch, one cord exit management clip and mounting hardware. |
| T5 T5 lamp | 1. Type: (S) Standard (A) Advanced | Cord management clips must be ordered separately. |
| E Electronic ballast | 2. Handedness L= Left handed (male plug on user's left side) R=Right handed (male plug on user's right side) | Task lights are TCLP compliant and meet requirements of California Title 24. |
| 19 Width | All housings are black. | Advanced task lights are fitted with ballast and lamp compliant with LEED requirements. |
| S Standard | | |
| DC Daisy chain | | |
| S Starter | | |
| L Left handed | | |
| Q Special | | |

Core finishes**Laminates**

| | |
|-----|----------------------------|
| 111 | Jet Black |
| 114 | Folkstone Grey (was LA) |
| 117 | Soft Grey (was M42) |
| 118 | Bright White |
| 119 | Pumice (was LF) |
| 121 | Micro Grey |
| 122 | Brushed Sand |
| 123 | Brushed Grey |
| 124 | Medium Cherry |
| 125 | Natural Maple |
| 126 | Natural Cherry |
| 127 | Walnut |
| 128 | Fog |
| 129 | Micro Sand |

Worksurface Edge

| | |
|-----|----------------------------|
| 111 | Jet Black |
| 113 | Dark Grey (was Y3) |
| 114 | Folkstone Grey (was LA) |
| 115 | Medium Grey (was Y2) |
| 117 | Soft Grey (was E) |
| 118 | Bright White |
| 119 | Pumice (was LF) |
| 124 | Medium Cherry |
| 125 | Natural Maple |
| 126 | Natural Cherry |
| 127 | Walnut |
| 128 | Fog |

Knoll Color Program Painted Trim**EP3 Panels***all other painted components***P1 Finishes**

| | |
|-----|----------------------------|
| 111 | Jet Black |
| 112 | Brown |
| 113 | Dark Grey (was Y3) |
| 114 | Folkstone Grey (was LA) |
| 115 | Med. Grey (was Y2) |
| 116 | Sandstone |
| 117 | Soft Grey (was E) |

P2 Finishes

| | |
|-----|----------------------|
| 611 | Beige Mist Metallic |
| 612 | Medium Metallic Grey |

P3 Finishes

| | |
|-----|----------------|
| 118 | Bright White |
| 613 | Silver (was 3) |

Insert Options*for insert panels, stack-on panels and
add-on screens.***Plexiglass**

| | |
|----|-------------|
| CL | Clear |
| IC | Ice |
| SM | Smoked |
| TR | Translucent |

**Lumasite (stack-on panels and
add-on screens only)**

| | |
|----|-------|
| LF | Frost |
|----|-------|

Equity Generation 1

Door Panels and shrouds

Standard Specials Systems

| description | type | w | h | pattern no. | list | add for P2 | add for P3 |
|----------------|------------------|-----|-----|------------------|----------|------------|------------|
| 36" Door panel | LH laminate door | 36" | 80" | EP1DL36LQ | \$2,077. | n/a | \$50. |
| | RH laminate door | 36" | 80" | EP1DL36RQ | 2,077. | n/a | 50. |

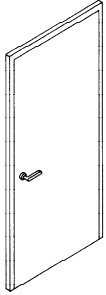

| | | | | | | | |
|--------------------|------------------|-----|-----|------------------|--------|-----|-----|
| 42" ADA Door panel | LH laminate door | 42" | 80" | EP1DL42LQ | 2,433. | n/a | 50. |
| | RH laminate door | 42" | 80" | EP1DL42RQ | 2,433. | n/a | 50. |

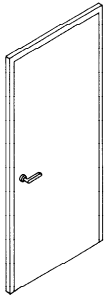

Order Code

Example: **EP1DL42LQ, 117, 117, 117**

| | |
|--------------|-----------------------------|
| EP1DL | Steel door panel |
| 42 | Width |
| LQ | Left handed |
| 117 | Soft Grey front/back finish |
| 117 | Soft Grey edgeband |
| 117 | Soft Grey trim |

Specification Information

Specify one surface and/or trim color, as appropriate.

The direction the door pivots away from you determines the "hand."

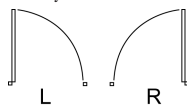

Post and post connectors must be ordered separately.

The door frame requires perpendicular support on the hinged side when the door is in an open position.

Application Notes

Two doors may not be placed back to back while sharing a single post connection. Doors in this application will not be properly supported and therefore no shroud exists to cover a back-to-back base opening.

All 42" and 48" wide doors provide a minimum opening clearance of 32" and are compliant with the Americans with Disabilities Act. The 36" door opening is less than 32" and is not ADA compliant.

All doors come with locking lever handset. Handset is ADA compliant.

An adaptor cup is included to connect the door to adjoining panels. Door shrouds give a finished look to door frames.

NOTE: EP1 & EP2 Panels and components are available in legacy colors only.

Equity Generation 1

Door Panels and shrouds

| description | type | w | h | pattern no. | list | add for P2 | add for P3 |
|--------------------|------------------|-----|-----|------------------|----------|------------|------------|
| 48" ADA Door panel | LH laminate door | 48" | 80" | EP1DL48LQ | \$3,331. | n/a | \$50. |
| | RH laminate door | 48" | 80" | EP1DL48RQ | 3,331. | n/a | 50. |

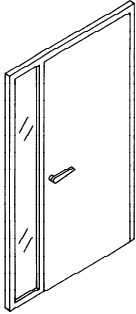

| Door shrouds | | | |
|--------------|-------------------------|-----------------|-----|
| | LH corner door shroud | EP1SDOLQ | 13. |
| | LH straight door shroud | EP1SDSLQ | 13. |
| | RH corner door shroud | EP1SDORQ | 13. |
| | RH straight door shroud | EP1SDSRQ | 13. |

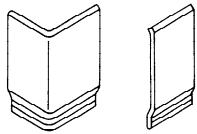

Order Code

Example: **EP1DL42LQ, 117, 117, 117**

| | |
|--------------|-----------------------------|
| EP1DL | Steel door panel |
| 42 | Width |
| LQ | Left handed |
| 117 | Soft Grey front/back finish |
| 117 | Soft Grey edgeband |
| 117 | Soft Grey trim |

Specification Information

Specify one surface and/or trim color, as appropriate.

The direction the door pivots away from you determines the "hand."

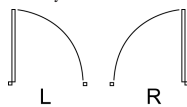

Post and post connectors must be ordered separately.

The door frame requires perpendicular support on the hinged side when the door is in an open position.

Application Notes

Two doors may not be placed back to back while sharing a single post connection. Doors in this application will not be properly supported and therefore no shroud exists to cover a back-to-back base opening.

All 42" and 48" wide doors provide a minimum opening clearance of 32" and are compliant with the Americans with Disabilities Act. The 36" door opening is less than 32" and is not ADA compliant.

All doors come with locking lever handset. Handset is ADA compliant.

An adaptor cup is included to connect the door to adjoining panels. Door shrouds give a finished look to door frames.

NOTE: EP1 & EP2 Panels and components are available in legacy colors only.

Equity Generation 3

Door Panels and shrouds

Standard Specials Systems

| description | type | w | h | pattern no. | list | add for P2 | add for P3 |
|----------------|------------------|-----|-----|------------------|----------|------------|------------|
| 36" Door panel | LH laminate door | 36" | 81" | EP3DL36LQ | \$2,077. | \$25. | \$50. |
| | RH laminate door | 36" | 81" | EP3DL36RQ | 2,077. | 25. | 50. |

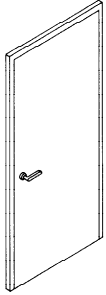

| | | | | | | | |
|--------------------|------------------|-----|-----|------------------|--------|-----|-----|
| 42" ADA Door panel | LH laminate door | 42" | 81" | EP3DL42LQ | 2,433. | 25. | 50. |
| | RH laminate door | 42" | 81" | EP3DL42RQ | 2,433. | 25. | 50. |

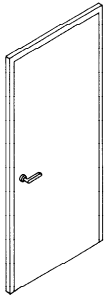

Order Code

Example: **EP3DL42LQ, 117, 117, 117**

| | |
|--------------|-----------------------------|
| EP3DL | Steel door panel |
| 42 | Width |
| LQ | Left handed |
| 117 | Soft Grey front/back finish |
| 117 | Soft Grey edgeband |
| 117 | Soft Grey trim |

Specification Information

Specify one surface and/or trim color, as appropriate.

The direction the door pivots away from you determines the "hand."

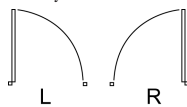

Post and post connectors must be ordered separately.

The door frame requires perpendicular support on the hinged side when the door is in an open position.

Application Notes

Two doors may not be placed back to back while sharing a single post connection. Doors in this application will not be properly supported and therefore no shroud exists to cover a back-to-back base opening.

All 42" and 48" wide doors provide a minimum opening clearance of 32" and are compliant with the Americans with Disabilities Act. The 36" door opening is less than 32" and is not ADA compliant.

All doors come with locking lever handset. Handset is ADA compliant.

An adaptor cup is included to connect the door to adjoining panels. Door shrouds give a finished look to door frames.

Equity Generation 3

Door Panels and shrouds

| description | type | w | h | pattern no. | list | add for P2 | add for P3 |
|--------------------|------------------|-----|-----|------------------|----------|------------|------------|
| 48" ADA Door panel | LH laminate door | 48" | 81" | EP3DL48LQ | \$3,331. | \$25. | \$50. |
| | RH laminate door | 48" | 81" | EP3DL48RQ | 3,331. | 25. | 50. |

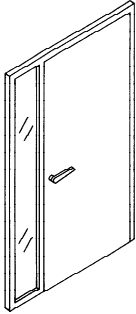

| | | | | | | | |
|--------------|-------------------------|--|--|-----------------|-----|--|--|
| Door shrouds | LH corner door shroud | | | EP3SDOLQ | 13. | | |
| | LH straight door shroud | | | EP3SDSLQ | 13. | | |
| | RH corner door shroud | | | EP3SDORQ | 13. | | |
| | RH straight door shroud | | | EP3SDSRQ | 13. | | |

Order Code

Example: **EP3DL42LQ, 117, 117, 117**

| | |
|--------------|-----------------------------|
| EP3DL | Steel door panel |
| 42 | Width |
| LQ | Left handed |
| 117 | Soft Grey front/back finish |
| 117 | Soft Grey edgeband |
| 117 | Soft Grey trim |

Specification Information

Specify one surface and/or trim color, as appropriate.

The direction the door pivots away from you determines the "hand."

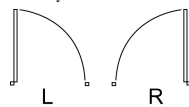

Post and post connectors must be ordered separately.

The door frame requires perpendicular support on the hinged side when the door is in an open position.

Application Notes

An adaptor cup is included to connect the door to adjoining panels. Door shrouds give a finished look to door frames.

Two doors may not be placed back to back while sharing a single post connection. Doors in this application will not be properly supported and therefore no shroud exists to cover a back-to-back base opening.

All 42" and 48" wide doors provide a minimum opening clearance of 32" and are compliant with the Americans with Disabilities Act. The 36" door opening is less than 32" and is not ADA compliant.

All doors come with locking lever handset. Handset is ADA compliant.

Equity service wall accessories

panel starter and end starter

Standard Specials Systems

| description | nominal height | pattern no. | list |
|----------------------|----------------|------------------|--------|
| Equity panel starter | 80 | AA1EPS80Q | \$409. |



| | | | |
|--------------------|----|----------------|------|
| Equity end starter | 28 | AX1E28Q | 292. |
| | 80 | AX1E80Q | 409. |



Order Code

| | |
|------------|-------------------------|
| Example: | AA1EPS80 Q, 613 |
| AA1 | Accessory |
| EPS | Equity panel starter |
| 80 | Height |
| Q | Equity standard special |
| 613 | Silver trim |

Specification Information

Specify legacy paint finish for Equity end and panel starters, trim kits and crown end cap:

Note:
For more specific application information, please refer to pages 48-49 of the 1999 Equity Planning Guide. Additional finishes are available for crown end caps.

*For pricing and discounting refer to the Currents price list.

Leadtimes will be consistent with Currents published lead-times.

Application Notes

Equity panel starters attach perpendicular panels to Currents wall structural base covers. Equity panel starter includes clamp bracket and adapter. Both end and panel starters include top clip for added stiffness. No connector post is required for either starter.

Equity end starter supports perpendicular panel run on the centerline of the end of the wall. Perpendicular panels should be at the same height or higher than the service wall.

The Equity end trim kit encloses and flushes out the end of the Currents service wall with attached, end started Equity panels.

Specify trim kit suffix "T" for panels on both sides, "L" or "R" for attached panels only on left or right side of end of the Currents wall (as seen from outside of "T" end). Also specify crown end cap for all end conditions.

Gap fillers fill the gap when attaching a lower height Equity panel at the end of a 64"H Currents service wall.

Equity EW1 Worksurfaces

Rectangular

Standard Specials Systems

| description | w | d | pattern no. | 2mm edge | woodgrain edge | metal edge |
|----------------------|-----|-----|------------------|----------|----------------|------------|
| 15" Deep Rectangular | 66" | 15" | EW16615Q | \$417. | \$459. | \$500. |
| 18" Deep Rectangular | 24" | 18" | EW12418Q | 217. | 239. | 260. |
| grommet | 24" | 18" | EW12418GQ | 237. | 261. | 284. |
| 36" Deep Rectangular | 42" | 36" | EW14236Q | 655. | 721. | 786. |
| grommet | 42" | 36" | EW14236GQ | 675. | 743. | 810. |

Equity System

Order Code

| | |
|------------|---------------------------|
| Example: | EW17220G, 117, 117 |
| EW1 | Equity top only |
| 72 | Width in inches |
| 20 | Depth in inches |
| G | w/grommet |
| 117 | Soft Grey lamination |
| 117 | Soft Grey edge |

Specification Information

Specify surface and edge color.

Note:
If an edge grommet is not desired remove the "G" and deduct \$20. Worksurface cable baskets may be ordered separately from the standard Equity price list.

Extended worksurfaces not available with support hardware included.

Application Notes

Pattern numbers listed above are for worksurface only. See page 0 for Worksurface Loading and Support Application Information.

For cantilevered worksurfaces, please add a "C" to the end of the pattern number and add \$50 to the list price. Worksurfaces up to 48 inches wide will include one left hand and one right hand cantilever. Worksurfaces greater than 48 inches wide will include two left hand cantilevers and one right hand cantilever. The additional left hand cantilever is required for additional center support on tops spanning a distance greater than 48 inches.

A center support must be used with a 54" wide or larger worksurface.

Note:
Extended one end add "E" and \$20. Extended both ends add "EE" and \$40. ("EE" not available on 120".)

Extended tops are not available with support hardware included.

Equity EW1 Worksurfaces

Blended corner

Standard Specials Systems

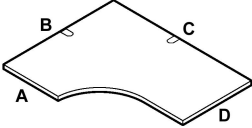
| description | A | B | C | D | pattern no. | 2mm edge | woodgrain edge | metal edge |
|---|-----|-----|-----|-----|--------------------------|----------|----------------|------------|
|  | 24" | 36" | 72" | 30" | EW1BS3672D () GQ | \$851. | \$936. | \$1,021. |
| | 24" | 36" | 78" | 24" | EW1BS3678S () GQ | 874. | 961. | 1,049. |
| | 24" | 42" | 72" | 24" | EW1BS4272S () GQ | 917. | 1,009. | 1,100. |
| | 24" | 60" | 60" | 24" | EW1BS6060S () GQ | 959. | 1,055. | 1,151. |
| | 24" | 72" | 36" | 30" | EW1BS7236D () GQ | 851. | 936. | 1,021. |
| | 24" | 72" | 42" | 24" | EW1BS7242S () GQ | 917. | 1,009. | 1,100. |
| | 24" | 78" | 36" | 24" | EW1BS7836S () GQ | 874. | 961. | 1,049. |
| | 30" | 36" | 72" | 24" | EW1BD3672S () GQ | 851. | 936. | 1,021. |
| | 30" | 48" | 60" | 30" | EW1BD4860D () GQ | 884. | 972. | 1,061. |
| | 30" | 48" | 72" | 30" | EW1BD4872D () GQ | 964. | 1,060. | 1,157. |
| | 30" | 60" | 36" | 24" | EW1BD6036S () GQ | 802. | 882. | 962. |
| | 30" | 60" | 48" | 30" | EW1BD6048D () GQ | 884. | 972. | 1,061. |

Order Code

Example: **EW1BS3672SLG, 117, 117, 117**

| | |
|-------------|------------------------|
| EW1B | Blended worksurface |
| S | 24" left depth |
| 36 | 48 left width |
| 72 | 72" right width |
| S | 24" right width |
| L | Left side post covered |
| G | Grommet |
| 117 | Soft Grey laminate |
| 117 | Soft Grey edge |
| 117 | Soft Grey trim |

Specification Information

Specify laminate, vinyl trim, and grommet colors when applicable.

All support bracketry must be ordered separately.

Note:
If and edge grommet is not desired remove the "G" and deduct \$20.

Application Notes

Blended worksurfaces are designed to take the place of two adjacent worksurfaces by blending them into one top. The front of the worksurface is curved to provide a smooth transition to the next attached worksurface.

Blended worksurfaces are handed and may or may not cover a post on either or both sides. Hand is determined from the seated position. Option suffixes for Blended corners are as follows:
 X=No posts covered
 L=Left side post covered
 R=Right side post covered
 B=Both sides posts covered

Blended peninsulas are handed and always cover one post. Hand is determined from seated position. Rounded end is 30" deep.



Depth options are as follows:
 S=24" deep
 D=30" deep

Center support must be used for all surfaces which exceed 48" in length.

Equity EW1 Worksurfaces

Counter caps, corner

Standard Specials Systems

| description | A | B | C | pattern no. | PVC edge | woodgrain PVC edge | metal edge |
|---|-----|-----|-----|----------------------|----------|--------------------|------------|
| Counter cap,corner  | 42" | 15" | 15" | EW1CC4215Q | \$758. | \$834. | \$910. |
| Counter cap,corner grommet | 48" | 24" | 30" | EW1CC482430GQ | 1,010. | 1,111. | 1,212. |
| | 48" | 30" | 24" | EW1CC483024GQ | 1,010. | 1,111. | 1,212. |
| | 48" | 30" | 30" | EW1CC483030GQ | 1,010. | 1,111. | 1,212. |
| Counter cap,corner Extended one end  | 42" | 42" | 15" | EW1CC4215EQ | 781. | 859. | 937. |
| Counter cap,corner Extended both ends  | 42" | 42" | 15" | EW1CC4215EEQ | 805. | 886. | 966. |

Equity System

| Order Code | Specification Information | Application Notes |
|--|--|--|
| Example: EW1CC3015, 117, 117, 117 | Specify surface, trim and cantilever trim color. | Counter caps are designed for mounting on top of panels. |
| EW1 Worksurface | EW1 counter caps work with all existing counter caps and are for use with Generation 1 or Generation 2 panels. Plastic cantilevers are supplied. | Corner counter caps-(E) extended one end, mount on top of 24", 30" or 36" panels at 90° to each other. They are non-handed and screw holes for the mounting brackets must be field-drilled. |
| CC Curved corner | | |
| 30 Width | EW2 counter caps are for use with Generation 3 panels only. | Steel mounting brackets are supplied. |
| 15 Depth | | |
| 117 Soft Grey laminate | | A counter cap extension (E) covers one post. |
| 117 Soft Grey edge | | A counter cap extension (EE) covers 2 posts. |
| 117 Soft Grey cantilever trim | | <i>Wood Grain and Metal edge bands:</i> When specifying a top with a wood grain edge band add \$25 to the standard list price. When specifying a top with a metal edge band add \$50 to the standard list price. |

Equity EW1 Worksurfaces

P+9 tops

Standard Specials Systems

| description | width | depth | pattern no. | PVC edge | woodgrain PVC edge | metal edge |
|-------------|-------|-------|----------------------|----------|--------------------|------------|
| P + 9 Top | 60" | 30" | EW1(9/P)6030Q | \$709. | \$780. | \$851. |
| | 96" | 36" | EW1(9/P)9636Q | 1,213. | 1,334. | 1,456. |

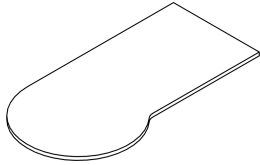

"9" top shown

| Order Code | Specification Information | Application Notes |
|--|---|---|
| Example: EW1P7230C, 117, 117, 117 | Specify surface and trim color. Specify hardware color for bases and stretcher rails. | Designed for use as primary worksurfaces and for conferencing in small groups. |
| EW1 Gen 1 worksurface | | |
| P P top | | |
| 72 Width | | |
| 30 Depth | | |
| C Supports included | | |
| 117 Soft Grey laminate | | |
| 117 Soft Grey edge | | |
| 117 Soft Grey trim | | |
| | <p><i>Note:</i> "P" and "D" worksurfaces cannot be panel wrapped.</p> <p>Column bases and stretcher rails must be ordered separately.</p> | <p>To specify an EW1 "D", "P" or "9" top with support hardware (fixed-height column and stretcher rail) included add a "C" to the end of the pattern number and add \$200 to the list price.</p> <p>84" wide "D", "P" and "9" worksurfaces include a "V" support bar mounted on the underside for additional stability.</p> |

Equity EW3 Worksurfaces

Blended and Curved corner tops

Standard Specials Systems

| description | A | B | C | D | pattern no. | list |
|----------------|-----|-----|-----|-----|--------------------------|----------|
| Blended corner | 24" | 36" | 78" | 24" | EW3BS3678S () GQ | \$1,120. |
| | 24" | 78" | 36" | 24" | EW3BS7836S () GQ | 1,120. |

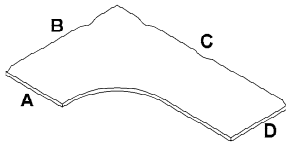

Note: EW3 Worksurfaces not available with Woodgrain or Metal edge.

| | | | | | | |
|---------------|-----|-----|-----|--|----------------------|--------|
| Curved corner | 48" | 30" | 24" | | EW3CC483024GQ | 1,290. |
|---------------|-----|-----|-----|--|----------------------|--------|

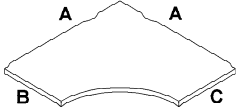

Note: EW3 Worksurfaces not available with Woodgrain or Metal edge.

Equity System

Order Code

Example: **EW3BS3672SLG, 117, 117**

| | |
|-------------|------------------------|
| EW3B | Blended worksurface |
| S | 24" left depth |
| 36 | 48" left width |
| 72 | 72" right width |
| S | 24" right depth |
| L | Left side post covered |
| G | Grommet |
| 117 | Soft Grey laminate |
| 117 | Soft Grey edge |

Specification Information

Specify laminate, vinyl trim, and grommet colors when applicable.

All support bracketry must be ordered separately.

Note:
If an edge grommet is not desired, remove the "G" and deduct \$20.

Application Notes

Blended worksurfaces are designed to take the place of two adjacent worksurfaces by blending them into one top. The front of the worksurface is curved to provide a smooth transition to the next attached worksurface.

Blended worksurfaces are handed and may or may not cover a post on either or both sides. Hand is determined from the seated position. Option suffixes for Blended corners are as follows:
X=No posts covered
L=Left side post covered
R=Right side post covered
B=Both sides posts covered

Blended peninsulas are handed and always cover one post. Hand is determined from seated position. Rounded end is 30" deep.

Blended peninsulas do not come with grommets. Due to this, the worksurface meeting the "c" side will have a one-half grommet where the return meets the peninsula.

Depth options are as follows:
S=24" deep
D=30" deep

Center support must be used for all surfaces which exceed 48" in length.

Equity EW3 Worksurfaces

D,P+9 tops

Standard Specials Systems

| description | w | d | pattern no. | list |
|-------------|-----|-----|----------------------|--------|
| P + 9 Top | 66" | 30" | EW3(9/P)6630Q | \$909. |

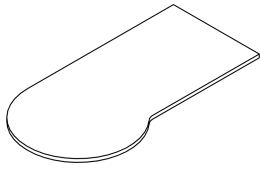

Note: EW3 Worksurfaces not available with Woodgrain or Metal edge.

| | | | | |
|---------|-----|-----|------------------|------|
| "D" Top | 72" | 30" | EW3D7230Q | 800. |
|---------|-----|-----|------------------|------|

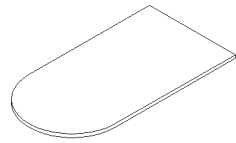

Note: EW3 Worksurfaces not available with Woodgrain or Metal edge.

| Order Code | Specification Information | Application Notes |
|--|---|---|
| Example: EW1P7230C, 117, 117, 117 | Specify surface and trim color. Specify hardware color for bases and stretcher rails. | Designed for use as primary worksurfaces and for conferencing in small groups. |
| EW1 Gen 1 worksurface | | |
| P P top | | |
| 72 Width | | |
| 30 Depth | | |
| C Supports included | | |
| 117 Soft Grey laminate | | |
| 117 Soft Grey edge | | |
| 117 Soft Grey trim | | |
| | <p><i>Note:</i> "P" and "D" worksurfaces cannot be panel wrapped.</p> <p>Column bases and stretcher rails must be ordered separately.</p> | <p>To specify an EW1 "D", "P" or "9" top with support hardware (fixed-height column and stretcher rail) included add a "C" to the end of the pattern number and add \$200 to the list price.</p> <p>84" wide "D", "P" and "9" worksurfaces include a "V" support bar mounted on the underside for additional stability.</p> |

| description | w | d | pattern no. | PVC edge | woodgrain PVC edge | metal edge |
|-----------------------|------|-----|-----------------|----------|--------------------|------------|
| Calibre file top 18"d | 66" | 18" | CE6618Q | \$345. | \$380. | \$414. |
| | 78" | 18" | CE7818Q | 385. | 424. | 462. |
| | 96" | 18" | CE9618Q | 497. | 547. | 596. |
| | 114" | 18" | CE11418Q | 562. | 618. | 674. |



Note: File tops are designed for use with Calibre Lateral Files with Calibre Fronts. For Morriuson Fronts and Series 2 Fronts contact CPD.

| | | | | | | |
|-----------------------|------|-----|-----------------|------|--------|--------|
| Calibre file top 36"d | 48" | 36" | CE4836Q | 413. | 454. | 496. |
| | 54" | 36" | CE5436Q | 474. | 521. | 569. |
| | 66" | 36" | CE6636Q | 684. | 752. | 821. |
| | 78" | 36" | CE7836Q | 595. | 655. | 714. |
| | 96" | 36" | CE9636Q | 726. | 799. | 871. |
| | 102" | 36" | CE10236Q | 770. | 847. | 924. |
| | 114" | 36" | CE11436Q | 905. | 996. | 1,086. |
| | 120" | 36" | CE12036Q | 972. | 1,069. | 1,166. |

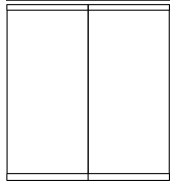

Note: File tops are designed for use with Calibre Lateral Files with Calibre Fronts. For Morriuson Fronts and Series 2 Fronts contact CPD.

Order Code

30X18 Equity/Dividends Style File Tops (Calibre Files)

Example: **CE3018**

| | |
|-----------|----------------------|
| CE | Equity/Dividend Edge |
| 30 | 30" Wide |
| 18 | 18" Deep |

Specification Information

CE prefixed lateral file tops are designed to be attached to standard 18" deep (nominal) Calibre lateral files and cabinets. Please note that Calibre bookcases are 15" deep nominal and will not accept a Calibre lateral file laminate tops.

Calibre desking surfaces are not designed to serve as lateral file worksurface tops.

Applicaton Notes

Designed for use with standard 18" deep nominal Calibre lateral files and cabinets only.

Actual dimensions are listed in inches

Equity Task Light Daisy Chain

| description | type | w | d | h | pattern no. | Standard | Advanced |
|---|---------------------------------|-----|----|--------|---------------------------|----------|----------|
| Task Light, starter 9 ft. cord, fused male plug 1 ft. cord, female plug | Use with 24" and wider overhead | 19" | 4" | 1 1/2" | EL4T5E19()DCS()Q | \$360. | n/a |
| | Use with 30" and wider overhead | 25" | 4" | 1 1/2" | EL4T5E25()DCS()Q | 367. | 570. |
| | Use with 42" and wider overhead | 37" | 4" | 1 1/2" | EL4T5E37()DCS()Q | 373. | 589. |
| | Use with 60" and wider overhead | 49" | 4" | 1 1/2" | EL4T5E49()DCS()Q | 387. | 613. |

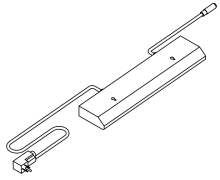

left hand shown

| | | | | | | | |
|---|---------------------------------|-----|----|--------|---------------------------|------|------|
| Task Light, adder 2 ft. cord, male plug 1 ft. cord, female plug | Use with 24" and wider overhead | 19" | 4" | 1 1/2" | EL4T5E19()DCA()Q | 392. | n/a |
| | Use with 30" and wider overhead | 25" | 4" | 1 1/2" | EL4T5E25()DCA()Q | 399. | 600. |
| | Use with 42" and wider overhead | 37" | 4" | 1 1/2" | EL4T5E37()DCA()Q | 405. | 623. |
| | Use with 60" and wider overhead | 49" | 4" | 1 1/2" | EL4T5E49()DCA()Q | 419. | 640. |

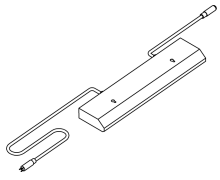

left hand shown

| | | | | | | | |
|--|---------------------------------|-----|----|--------|---------------------------|------|------|
| Task Light, ender 2 ft. cord, male plug | Use with 24" and wider overhead | 19" | 4" | 1 1/2" | EL4T5E19()DCE()Q | 279. | n/a |
| | Use with 30" and wider overhead | 25" | 4" | 1 1/2" | EL4T5E25()DCE()Q | 286. | 487. |
| | Use with 42" and wider overhead | 37" | 4" | 1 1/2" | EL4T5E37()DCE()Q | 292. | 510. |
| | Use with 60" and wider overhead | 49" | 4" | 1 1/2" | EL4T5E49()DCE()Q | 306. | 527. |

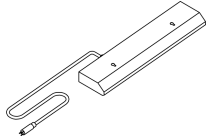

left hand shown

| Order Code | Specification Information | Application Notes |
|--------------------------------|---|---|
| Example: EL4T5E19SDCSLQ | <i>Specify:</i> | Task lights mount into the recess in the underside of overhead cabinets and shelves at least 5" wider than task light width. |
| EL4 Equity Task Light | Width - Task Lights mount in cabinets and shelves at least 5" wider than light width. | For extra deep (EDP) shelves, order the EDP light bracket for proper installation. |
| T5 T5 lamp | 1. Type: | Task lights include T5 cool white (4100K) fluorescent lamp, electronic ballast, prismatic lens, rocker switch, one cord exit management clip and mounting hardware. |
| E Electronic ballast | (S) Standard | Task lights are TCLP compliant and meet requirements of California Title 24. |
| 19 Width | (A) Advanced | |
| S Standard | 2. Handedness | Advanced task lights are fitted with ballast and lamp compliant with LEED requirements. |
| DC Daisy chain | L= Left handed (male plug on user's left side) | |
| S Starter | R=Right handed (male plug on user's right side) | |
| L Left handed | All housings are black. | |
| Q Special | | |

KNOLLTEXTILES

Approved for vertical panels and privacy screens.

Fabric Group 10

Bailey II (W359)
Broadcloth (W288)
Element (W1077)
Foundation (W351)
Growth Spurt (W692)
Newbury (W812)
Solid Crepe (W257)
Symbolic Details (W693)
Tailor Made (W133)
Versatility (W432)

Fabric Group 15

Regency/Fairfield (W210/B)

Fabric Group 20

Archaea (W1254)
Banyan (W443)
Bauhaus Block (W296)
Circle Line (W1146)
Clarity (W281)
Criss Cross (W305)
Devon (W809)
Melbourne (W228)
Nematic (W1292)
panel and trim only
Outback (W229)
Photon (W1293)
Reflect (W884)
Resolution (W280)
Walkabout (W230)
Weave Three (W298)

Fabric Group 30

Basket Draft (W249)
Flow (W565)
Harmony (W232)
Interknit (W1090)
Match Point (W1145)
Micro (W465)
Progression (W403)
Progression Striae (W463)
Raku Cloth (W566)
Relay (W1020)

Fabric Group 40

Amplify (W1215)
Analogy (K614)
Bandwidth (W1219)
Clarkson (W1218)
panel and trim only
Foil Rap (W535)
Hard Rock (W1007)
Metaphor (K612)
Ornament (W1078)
Palladium (W1030)

Fabric Group 45

Backdrop (W302) *
Dristi (K872) with backing only
Fast Forward (W301)*

***Not available for upholstered connector trim covers**

Fabric Group 50

Knoll Hopsack (K1206)
panel and trim only
Presto (K1000)
Ricochet (K498)

Fabric Group 55

Transition (W816)

Ported panels can only be upholstered with textiles approved for application on Reff panels.

Customer's Own Material is subject to an application testing fee of per fabric and a fee for UL testing. Fabric requirements - application test, 10 yards; UL test, 15 yards. COM is also subject to extended leadtimes. COM panels are priced at Group 10 plus cost of fabric.

Knoll Color Program

Morrison System Finishes

Core paint and laminate finishes

Specify Core finishes for all new customers

| Core | Legacy | Top caps and trim, Panels (veneer only) | Glazed panel, window, door frames (textured) | Desk panels, storage fronts Hinged doors | Desk supports, stanchion, storage, brackets, raceway covers | Work-surfaces and shelves (all) | Work-surfaces and shelves (post-formed) | Cascade Edge work-surfaces | Pedestals | Reuter Over-head |
|------|----------------------|---|--|--|---|---------------------------------|---|----------------------------|-----------|------------------|
| 611 | Beige Mist Metallic | • | • | • | • | | | | P2 | P2 |
| 118 | Bright White | • | • | • | • | • | • | • | P3 | P3 |
| 112 | Brown | • | • | • | • | | | | P1 | P1 |
| 113 | Dark Grey | Y3 | • | • | • | | | | P1 | P1 |
| 114 | Folkstone Grey | LA | • | • | • | • | • | • | P1 | P1 |
| 111 | Jet Black | | • | • | • | • | • | | P1 | P1 |
| 115 | Medium Grey | Y2 | • | • | • | | | | P1 | P1 |
| 612 | Medium Metallic Grey | J | • | • | • | | | | P2 | P2 |
| 119 | Pumice | F | | | | • | • | • | | |
| 116 | Sandstone | | • | • | • | | | | P1 | P1 |
| 613 | Silver | 3 | • | • | • | | | | P3 | P3 |
| 117 | Soft Grey | E/M42 | • | • | • | • | • | • | P1 | P1 |
| 128 | Fog | G | | | | • | • | | | |
| 129 | Micro Sand | | | | | | • | | | |
| 121 | Micro Grey | | | | | | • | | | |
| 122 | Brushed Sand | | | | | | • | | | |
| 123 | Brushed Grey | | | | | | • | | | |
| 124 | Medium Cherry | | | | | | • | • | | |
| 125 | Natural Maple | | | | | | • | • | | |
| 126 | Natural Cherry | | | | | | • | • | | |
| 127 | Walnut | | | | | | • | • | | |

This price list contains pricing for Core finishes. For detailed pricing of Legacy finishes, please refer to the latest release of CAP worksheet or contact your customer service representative.

The new, Core P1 finishes in Morrison have the same list prices as P2. Additionally, Pedestals and Reuter overhead storage have a separate P3 price point for Silver and Bright White.

The new Core finish 113 Dark Grey is not a match to the Morrison Legacy finish NV. It is a match to the Dividends Legacy finish Y3.

The new Core finish 115 Medium Grey is not a match to the Morrison Legacy finish NJ. It is a match to the Dividends Legacy finish Y2.

Patterned laminates (Micro, Brushed and Wood grain laminates) are available on Morrison postformed worksurfaces and shelves (straight, trapezoidal, VDT).

Wood grain laminates are also available on Cascade Edge worksurfaces.



| | | Work-surfaces | Panels | Desk Panels | Shelves | Top caps/ Trim covers | Glazed Panel/ Window/ Door Frames* | Storage fronts | Storage Cases | Desk Supports, Stanchions, Steel shelves, brackets, raceway covers |
|----------------------|---|---------------|--------|-------------|---------|--------------------------|--|----------------|---------------|--|
| Plastic Laminates | Light Grey | L | | | L | | | | | |
| | Medium Grey | G | | | G | | | | | |
| | Sand | D | | | D | | | | | |
| | Pumice | F | | | F | | | | | |
| | Snow | B | | | B | | | | | |
| Wood Grain Laminates | Clear Maple (Currents for Morrison worksurfaces only) | CM | | | | | | | | |
| Veneer Group 1 | Maple Techgrain® | 4/Y821 | 4/Y821 | M/C6J2 | 4/Y821 | 4/Y821 | | M/C6J2 | | |
| | Cherry Techgrain® | 6/Y831 | 6/Y831 | R/C6J3 | 6/Y831 | 6/Y831 | | R/C6J3 | | |
| | Medium brown mahogany Techgrain® | 7/C6F3 | 7/C6F3 | I/C6J4 | 7/C6F3 | 7/C6F3 | | I/C6J4 | | |
| | Medium red mahogany Techgrain® | 8/C6F4 | 8/C6F4 | C/C6J5 | 8/C6F4 | 8/C6F4 | | C/C6J5 | | |
| | American cherry Techgrain® | 9/C6F5 | 9/C6F5 | P/C6J6 | 9/C6F5 | 9/C6F5 | | P/C6J6 | | |
| Veneer Group 2 | American cherry | X/C6F6 | X/C6F6 | X/C6F6 | X/C6F6 | X/C6F6 | | X/C6F6 | | |
| | Medium red mahogany | Z/C6F7 | Z/C6F7 | Z/C6F7 | Z/C6F7 | Z/C6F7 | | Z/C6F7 | | |
| Paint Group 2 | Metallic Flint | | | 2 | | 2 | 2 | 2 | 2 | 2 |
| | Light metallic grey | | | U | | U | U | U | U | U |
| | Medium metallic grey | | | J | | J | J | J | J | J |
| | Dark metallic grey | | | V | | V | V | V | V | V |
| | Light metallic tan | | | W | | W | W | W | W | W |
| | Metallic beige | | | H | | H | H | H | H | H |
| Paint Group 3 | Silver | | | 3 | | 3 | 3 | 3 | 3 | 3 |
| | White | | | B | | B | B | B | B | B |

* Paint finishes for glazed panels, window and door frames are textured only. Specify legacy finishes to match existing product only. Legacy finishes are not available for new customers.

This price list contains pricing for Core finishes. For detailed pricing of Legacy finishes, please refer to the latest release of CAP worksheet or contact your customer service representative.

In September 2008 all existing Morrison veneer finishes were transferred to our Toronto plant. All existing finishes were changed to closed pore finishing and assigned new finish codes. The older, semi-open pore finishes are no longer available and legacy finishes must be ordered with the newer finish codes beginning with "C".

As of February 2009 Legacy laminates will be priced 10% higher than Core laminates.

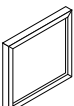
| description | w | d | h | pattern no. | C/S | T |
|--|-----|--------|-----|------------------------------|--------|--------|
| Windows, 8"H  | 18" | 2 1/4" | 8" | MP3-W0818-C/S/T-Q-() | \$469. | \$525. |
| | 24" | 2 1/4" | 8" | MP3-W0824-C/S/T-Q-() | 525. | 593. |
| | 30" | 2 1/4" | 8" | MP3-W0830-C/S/T-Q-() | 593. | 663. |
| | 36" | 2 1/4" | 8" | MP3-W0836-C/S/T-Q-() | 649. | 733. |
| | 42" | 2 1/4" | 8" | MP3-W0842-C/S/T-Q-() | 705. | 788. |
| | 48" | 2 1/4" | 8" | MP3-W0848-C/S/T-Q-() | 772. | 870. |
| | 60" | 2 1/4" | 8" | MP3-W0860-C/S/T-Q-() | 994. | 1,119. |
| Windows, 14"H  | 18" | 2 1/4" | 14" | MP3-W1418-C/S/T-Q-() | 469. | 525. |
| | 24" | 2 1/4" | 14" | MP3-W1424-C/S/T-Q-() | 525. | 593. |
| | 30" | 2 1/4" | 14" | MP3-W1430-C/S/T-Q-() | 593. | 663. |
| | 36" | 2 1/4" | 14" | MP3-W1436-C/S/T-Q-() | 649. | 733. |
| | 42" | 2 1/4" | 14" | MP3-W1442-C/S/T-Q-() | 705. | 788. |
| | 48" | 2 1/4" | 14" | MP3-W1448-C/S/T-Q-() | 772. | 870. |
| | 60" | 2 1/4" | 14" | MP3-W1460-C/S/T-Q-() | 994. | 1,119. |
| Windows, 26"H  | 18" | 2 1/4" | 26" | MP3-W2618-C/S/T-Q-() | 469. | 525. |
| | 24" | 2 1/4" | 26" | MP3-W2624-C/S/T-Q-() | 525. | 593. |
| | 30" | 2 1/4" | 26" | MP3-W2630-C/S/T-Q-() | 593. | 663. |
| | 36" | 2 1/4" | 26" | MP3-W2636-C/S/T-Q-() | 649. | 733. |
| | 42" | 2 1/4" | 26" | MP3-W2642-C/S/T-Q-() | 705. | 788. |
| | 48" | 2 1/4" | 26" | MP3-W2648-C/S/T-Q-() | 772. | 870. |
| | 60" | 2 1/4" | 26" | MP3-W2660-C/S/T-Q-() | 994. | 1,119. |

Order Code

| | |
|------------|--------------------------|
| Example: | MP3-W2230-C-Q-613 |
| MP3 | Panel |
| W | Window |
| 22 | Height |
| 30 | Width |
| C | Window finish |
| Q | Standard Special |
| 613 | Frame finish |

Specification Information

Specify glazing for windows:
 C- Clear tempered glass
 S- Smoked acrylic
 T- Translucent acrylic

Frame finish

Application Notes

Windows mount on any height Morrison vertical panel of the same width with add-on connectors or full height connectors.

All windows are 1/4" less than nominal height to allow for a 1/4" horizontal reveal with light seal.

9"H windows may be mounted on 30"H and 39"H vertical panels and connected, respectively, with standard 39"H and 48"H connector tracks and post assemblies.

16"H windows may be mounted on 48"H and 64"H vertical panels and connected, respectively, with standard 64"H and 80"H connector tracks and post assemblies.

18"H windows may be mounted on 30"H and 56"H vertical panels and connected, respectively, with standard 48"H and 74"H standard connector tracks and post assemblies.

22"H windows may be mounted on 42"H vertical panels and connected with standard 64"H connector tracks and post assemblies.

32"H windows may be mounted on 48"H vertical panels and connected with standard 80"H connector tracks and post assemblies.

Full height 48" and 64" connectors permit cantilevered shelves and overhead cabinets.

Two 16"H windows may be mounted on a 48"H upholstered panel only when using 80"H full height connector tracks and post assemblies.

Morrison Connectors, post assemblies *straight upholstered*

Standard Specials Systems

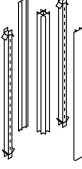
| description | w | d | h | pattern no. | 10 | 15 | 20 | 30 | 35 | 40 | 45 |
|---|--------|--------|-----|-----------------------|--------|--------|--------|--------|--------|--------|--------|
|  Connector track upholstered | 2 1/4" | 2 1/4" | 30" | MC1-30S2-()-Q | \$178. | \$178. | \$178. | \$178. | \$192. | \$192. | \$207. |
| | 2 1/4" | 2 1/4" | 39" | MC1-39S2-()-Q | 183. | 183. | 183. | 183. | 196. | 196. | 211. |
| | 2 1/4" | 2 1/4" | 42" | MC1-42S2-()-Q | 185. | 185. | 185. | 185. | 199. | 199. | 213. |
| | 2 1/4" | 2 1/4" | 48" | MC1-48S2-()-Q | 192. | 192. | 192. | 192. | 205. | 205. | 221. |
| | 2 1/4" | 2 1/4" | 56" | MC1-56S2-()-Q | 199. | 199. | 199. | 199. | 213. | 213. | 228. |
| | 2 1/4" | 2 1/4" | 64" | MC1-64S2-()-Q | 213. | 213. | 213. | 213. | 228. | 228. | 242. |
| | 2 1/4" | 2 1/4" | 74" | MC1-74S2-()-Q | 228. | 228. | 228. | 228. | 242. | 242. | 256. |
| | 2 1/4" | 2 1/4" | 80" | MC1-80S2-()-Q | 242. | 242. | 242. | 242. | 256. | 256. | 270. |

Morrison System

| Order Code | Specification Information | Application Notes |
|---------------------------------------|---------------------------|--|
| Example: MC1-42S2-15-W210/20-Q | Surface type: | Post assembly pricing includes connector tracks, posts and trim covers when required. Top caps and raceway covers are specified as separate kits and bulk shipped to facilitate installation |
| MC1 Connector | 10- Fabric group 10 | |
| 42 Height | 15- Fabric group 15 | |
| S2 2 way "L" | 20- Fabric group 20 | |
| 15 Surface type and group no. | 25- Fabric group 25 | |
| W210/20 Upholstery | 30- Fabric group 30 | |
| Q Standard Special | 35- Fabric group 35 | |
| | 40- Fabric group 40 | |
| | 45- Fabric group 45 | |

Morrison Connectors, post assemblies
straight non-upholstered

Standard Specials Systems

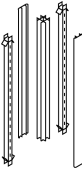
| description | type | w | d | h | pattern no | Paint | V1 |
|---|---------|--------|------------------------|-----|------------------------|--------|------|
|  | painted | 2 1/4" | 2 1/4" | 30" | MC1-30S2-()-Q | \$135. | |
| | | 2 1/4" | 2 1/4" | 39" | MC1-39S2-()-Q | 139. | |
| | | 2 1/4" | 2 1/4" | 42" | MC1-42S2-()-Q | 142. | |
| | | 2 1/4" | 2 1/4" | 48" | MC1-48S2-()-Q | 156. | |
| | | 2 1/4" | 2 1/4" | 56" | MC1-56S2-()-Q | 171. | |
| | | 2 1/4" | 2 1/4" | 64" | MC1-64S2-()-Q | 185. | |
| | | 2 1/4" | 2 1/4" | 74" | MC1-74S2-()-Q | 199. | |
| | | 2 1/4" | 2 1/4" | 80" | MC1-80S2-()-Q | 212. | |
| | veneer | 2 1/4" | 2 1/4" | 30" | MC1-30S2V-()-Q | | 207. |
| | | 2 1/4" | 2 1/4" | 39" | MC1-39S2V-()-Q | | 211. |
| | | 2 1/4" | 2 1/4" | 42" | MC1-42S2V-()-Q | | 213. |
| | | 2 1/4" | 2 1/4" | 48" | MC1-48S2V-()-Q | | 228. |
| | | 2 1/4" | 2 1/4" | 56" | MC1-56S2V-()-Q | | 242. |
| | | 2 1/4" | 2 1/4" | 64" | MC1-64S2V-()-Q | | 256. |
| | | 2 1/4" | 2 1/4" | 74" | MC1-74S2V-()-Q | | 284. |
| 2 1/4" | 2 1/4" | 80" | MC1-80S2V-()-Q | | 298. | | |

Order Code

| | |
|------------|-----------------------|
| Example: | MC1-42S2-V-4-Q |
| MC1 | Connector |
| 42 | Height |
| S2 | 2 way "L" |
| V | Surface type |
| 4 | Veneer |
| Q | Standard Special |

Specification Information

Application Notes

Post assembly pricing includes connector tracks, posts and trim covers when required. Top caps and raceway covers are specified as separate kits and bulk shipped to facilitate installation.

Veneer Group 1 trim covers are quartered Techgrain®.

Veneer Group 2 trim covers are rift cut Techgrain®.

Morrison Connectors, post assemblies *variable angle upholstered*

Standard Specials Systems

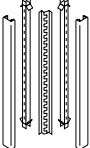
| description | w | d | h | pattern no. | 10 | 15 | 20 | 30 | 35 | 40 | 45 |
|---|--------|--------|-----|----------------------|--------|--------|--------|--------|--------|--------|--------|
|  Connector track upholstered | 2 1/4" | 2 1/4" | 30" | MC1-30H1(-)-Q | \$623. | \$632. | \$632. | \$632. | \$678. | \$678. | \$684. |
| | 2 1/4" | 2 1/4" | 39" | MC1-39H1(-)-Q | 634. | 644. | 644. | 644. | 678. | 678. | 694. |
| | 2 1/4" | 2 1/4" | 42" | MC1-42H1(-)-Q | 642. | 654. | 654. | 654. | 678. | 678. | 705. |
| | 2 1/4" | 2 1/4" | 48" | MC1-48H1(-)-Q | 659. | 669. | 669. | 669. | 692. | 692. | 721. |
| | 2 1/4" | 2 1/4" | 56" | MC1-56H1(-)-Q | 669. | 681. | 681. | 681. | 705. | 705. | 734. |
| | 2 1/4" | 2 1/4" | 74" | MC1-74H1(-)-Q | 694. | 707. | 707. | 707. | 733. | 733. | 763. |
| | 2 1/4" | 2 1/4" | 80" | MC1-80H1(-)-Q | 712. | 721. | 721. | 721. | 746. | 746. | 780. |

Morrison System

Order Code

| | |
|----------------|------------------------------|
| Example: | MC1-64H1-15-W210/20-Q |
| MC1 | Morrison accessory |
| 64 | Height |
| H1 | Variable angle |
| 15 | Surface type and group no. |
| W210/20 | Upholstery |
| Q | Standard Special |

Specification Information

Finishes for variable angle:
Upholstered:

| | |
|-----|-----------------|
| 10- | Fabric group 10 |
| 15- | Fabric group 15 |
| 20- | Fabric group 20 |
| 30- | Fabric group 30 |
| 35- | Fabric group 35 |
| 40- | Fabric group 40 |
| 45- | Fabric group 45 |

Application Notes

Variable angle connector includes connector tracks, continuous hinge, and trim covers. Specify top cap and raceway cover kit separately.

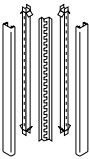

Morrison Connectors, post assemblies
variable angle non-upholstered

Standard Specials Systems

| description | type | w | d | h | pattern no. | P | V1 |
|---|---------|--------|--------|-----|------------------------|--------|------|
| Variable angle  | painted | 2 1/4" | 2 1/4" | 30" | MC1-30H1-()-Q | \$593. | |
| | | 2 1/4" | 2 1/4" | 39" | MC1-39H1-()-Q | 606. | |
| | | 2 1/4" | 2 1/4" | 42" | MC1-42H1-()-Q | 613. | |
| | | 2 1/4" | 2 1/4" | 48" | MC1-48H1-()-Q | 630. | |
| | | 2 1/4" | 2 1/4" | 56" | MC1-56H1-()-Q | 639. | |
| | | 2 1/4" | 2 1/4" | 74" | MC1-74H1-()-Q | 665. | |
| | | 2 1/4" | 2 1/4" | 80" | MC1-80H1-()-Q | 681. | |
| | veneer | 2 1/4" | 2 1/4" | 30" | MC1-30H1V-()-Q | | 715. |
| | | 2 1/4" | 2 1/4" | 39" | MC1-39H1V-()-Q | | 729. |
| | | 2 1/4" | 2 1/4" | 42" | MC1-42H1V-()-Q | | 736. |
| | | 2 1/4" | 2 1/4" | 48" | MC1-48H1V-()-Q | | 754. |
| | | 2 1/4" | 2 1/4" | 56" | MC1-56H1V-()-Q | | 766. |
| | | 2 1/4" | 2 1/4" | 74" | MC174H1V-()-Q | | 796. |
| | | 2 1/4" | 2 1/4" | 80" | MC1-80H1V-()-Q | | 812. |

| Order Code | Specification Information | Application Notes |
|---------------------------------------|----------------------------|--|
| Example: MC1-64H1-15-W210/20-Q | | Variable angle connector includes connector tracks, continuous hinge, and trim covers. Specify top cap and raceway cover kit separately. |
| MC1 | Morrison accessory | |
| 64 | Height | |
| H1 | Variable angle | |
| 15 | Surface type and group no. | |
| W210/20 | Upholstery | |
| Q | Standard Special | |

Morrison miscellaneous
Topcap and Raceway kit
Mid panel connector
Ceiling power components

| description | h | pattern no. | list | P | V1/P1 | V2/P1 |
|--|-----|----------------------|--------|-----|-------|-------|
| Mid panel connector  | 30" | MC1-C30Q | \$305. | | | |
| | 39" | MC1-C39Q | 305. | | | |
| | 42" | MC1-C42Q | 305. | | | |
| | 48" | MC1-C48Q | 318. | | | |
| | 56" | MC1-C56Q | 318. | | | |
| | 64" | MC1-C64Q | 318. | | | |
| | 74" | MC1-C74Q | 332. | | | |
| | 80" | MC1-C80Q | 332. | | | |
| Topcap&Raceway kit  | | MT5-CS2-()-Q | | 44. | 56. | 85. |
| Ceiling power pole | | MP2-CPP-()-Q | 606. | | | |

| Order Code | Specification Information | Application Notes |
|---------------------------|---------------------------|-------------------|
| Example: MC1-C30-Q | | |
| MC1 | Connector | |
| C | Mid panel | |
| 30 | Height | |
| Q | Standard Special | |

Trim Cover
upholstered

| description | h | pattern no. | 10 | 15 | 20 | 30 | 35 | 40 | 45 |
|---|-----|-----------------------|--------|--------|--------|--------|--------|--------|--------|
| Straight spacer upholstered  | 30" | MT1-30S2-()-Q | \$107. | \$107. | \$107. | \$107. | \$122. | \$122. | \$122. |
| | 39" | MT1-39S2-()-Q | 110. | 110. | 110. | 110. | 126. | 126. | 126. |
| | 42" | MT1-42S2-()-Q | 113. | 113. | 113. | 113. | 129. | 129. | 129. |
| | 48" | MT1-48S2-()-Q | 122. | 122. | 122. | 122. | 135. | 135. | 135. |
| | 56" | MT1-56S2-()-Q | 129. | 129. | 129. | 129. | 142. | 142. | 142. |
| | 64" | MT1-64S2-()-Q | 142. | 142. | 142. | 142. | 156. | 156. | 156. |
| | 74" | MT1-74S2-()-Q | 156. | 156. | 156. | 156. | 171. | 171. | 171. |
| | 80" | MT1-80S2-()-Q | 170. | 170. | 170. | 170. | 185. | 185. | 185. |

Example: **MT1-42S2-15-W210/20-Q**

| | |
|----------------|----------------------------|
| MT1 | Connector |
| 42 | Height |
| S2 | 2 way "L" |
| 15 | Surface type and group no. |
| W210/20 | Upholstery |
| Q | Standard Special |

Surface type:

| | |
|-----|-----------------|
| 10- | Fabric group 10 |
| 15- | Fabric group 15 |
| 20- | Fabric group 20 |
| 30- | Fabric group 30 |
| 35- | Fabric group 35 |
| 40- | Fabric group 40 |
| 45- | Fabric group 45 |

Trim Cover

non-upholstered

| description | type | h | pattern no. | Paint | VI | |
|---|-----------------|-----|-----------------|--------|----|------|
|  Straight spacer | painted | 30" | MT1-30S2-()-Q | \$100. | | |
| | | 39" | MT1-39S2-()-Q | 104. | | |
| | | 42" | MT1-42S2-()-Q | 107. | | |
| | | 48" | MT1-48S2-()-Q | 113. | | |
| | | 56" | MT1-56S2-()-Q | 122. | | |
| | | 64" | MT1-64S2-()-Q | 129. | | |
| | | 74" | MT1-74S2-()-Q | 135. | | |
| | | 80" | MT1-80S2-()-Q | 149. | | |
| | veneer | 30" | MT1-30S2V-()-Q | | | 149. |
| | | 39" | MT1-39S2V-()-Q | | | 154. |
| | | 42" | MT1-42S2V-()-Q | | | 156. |
| | | 48" | MT1-48S2V-()-Q | | | 163. |
| | | 56" | MT1-56S2V-()-Q | | | 171. |
| | | 64" | MT1-64S2V-()-Q | | | 185. |
| | | 74" | MT1-74S2V-()-Q | | | 199. |
| 80" | MT1-80S2V-()-Q | | | 212. | | |

Order Code

Specification Information

Application Notes

Example: **MT1-42S2-V-4-Q**

| | |
|------------|------------------|
| MT1 | Connector |
| 42 | Height |
| S2 | 2 way "L" |
| V | Surface type |
| 4 | Veneer |
| Q | Standard Special |

Veneer Group I trim covers are quartered Techgrain®.

Morrison Rolling Doors for Dividends Horizon

Standard Specials Systems

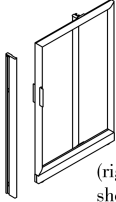
| description | type | width | pattern number | RC | RC | C | C | T | T | |
|---|----------------------------|-------|-------------------------------|----------|----------|----------|----------|----------|----------|--|
| | | | | 1-19 | 20+ | 1-19 | 20+ | 1-19 | 20+ | |
| Rolling door | 64"H with lock | 36" | QDMRD6436(L/R)()(-L-) | \$3,916. | \$3,404. | \$4,121. | \$3,582. | \$4,198. | \$3,650. | |
|  (right hand shown) | 64"H with lock | 42" | QDMRD6442(L/R)()(-L-) | 3,916. | 3,404. | 4,121. | 3,582. | 4,198. | 3,650. | |
| | 64"H with lock | 48" | QDMRD6448(L/R)()(-L-) | 3,946. | 3,431. | 4,150. | 3,608. | 4,229. | 3,677. | |
| | 64"H without lock | 36" | QDMRD6436(L/R)()(-N-) | 3,780. | 3,287. | 3,905. | 3,395. | 3,996. | 3,474. | |
| | 64"H without lock | 42" | QDMRD6442(L/R)()(-N-) | 3,780. | 3,287. | 3,905. | 3,395. | 3,996. | 3,474. | |
| | 64"H without lock | 48" | QDMRD6448(L/R)()(-N-) | 3,811. | 3,313. | 3,936. | 3,422. | 4,026. | 3,501. | |
| | 78"H with lock | 36" | QDMRD7836(L/R)()(-L-) | 4,081. | 3,549. | 4,285. | 3,726. | 4,365. | 3,794. | |
| | 78"H with lock | 42" | QDMRD7842(L/R)()(-L-) | 4,081. | 3,549. | 4,285. | 3,726. | 4,365. | 3,794. | |
| | 78"H with lock | 48" | QDMRD7848(L/R)()(-L-) | 4,112. | 3,575. | 4,317. | 3,753. | 4,395. | 3,821. | |
| | 78"H without lock | 36" | QDMRD7836(L/R)()(-N-) | 3,946. | 3,431. | 4,071. | 3,539. | 4,161. | 3,618. | |
| | 78"H without lock | 42" | QDMRD7842(L/R)()(-N-) | 3,946. | 3,431. | 4,071. | 3,539. | 4,161. | 3,618. | |
| | 78"H without lock | 48" | QDMRD7848(L/R)()(-N-) | 3,976. | 3,457. | 4,102. | 3,566. | 4,193. | 3,644. | |
| | Threshold for Rolling door | 36" | QDMRDFT36 | | | | | | 467. | |
| | | 42" | QDMRDFT42 | | | | | | 479. | |
| | | 48" | QDMRDFT48 | | | | | | 484. | |

* Order standard trim components separately to fit your door application. See following Trim page for pattern numbers.

| Order Code | Specification Information | Application Notes | Discount Notes |
|---------------------------------------|---|--|---|
| Example: QDMRD-7842-L-RC-117-L | <i>Specify:</i> | 64"H rolling door kit includes door panel, post with mounting bracket, and door jamb. See Door Trim page for trim options to be specified separately at time of order entry. | Above products are Morrison product and Morrison discount will be applied. |
| QDM Morrison for Dividends | <i>Left / Right Hand</i> | 78"H rolling door kit includes door panel, post with mounting bracket, door jamb, header and top cap for header. See Door Trim page for trim options to be specified at time of order entry. | |
| RD Rolling door | <i>Glazing for rolling door:</i> | 36" wide doors are not ADA compliant. | |
| 78 Height | C- Clear acrylic | | |
| 42 Width | T- Translucent acrylic | | |
| L Left | RC- Ribbed polycarbonate | | |
| RC Door finish | <i>Frame finish</i> | | |
| 117 Frame finish | <i>Lock / No Lock</i> | | |
| N No lock | Rolling doors mount to the outside of Dividends workstations. <i>Trim option:</i> | | |
| F Trim option | <i>code upch. Desc.</i> | | |
| | S- n/c Smooth plastic | | |
| | F- \$42 Flat metal | | |
| | R- \$42 Radius metal | | |

64" High Door without Header

Jamb Side Trim

Top View

Universal Post DP2APO64
 Universal Post DP7 DP7PO64
 Post Top Cap – One Way DP()PT1
 Post Cover – Corner -DP()PC64L



Universal Post -DP2APO64
 Universal Post DP7 -DP7PO64
 Post Top Cap – One Way -DP()PT1
 Post Cover – Straight -DP()PC64S

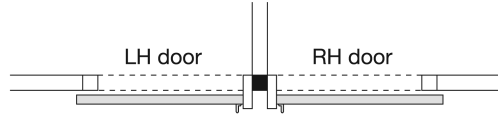

Universal Post -DP2APO64
 Universal Post DP7 -DP7PO64
 Post Top Cap – Two Way -DP()PT2
 Post Cover – Straight -DP()PC64S

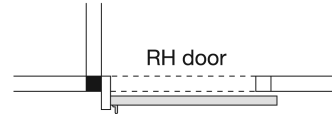

End Top Cap -DP1 -KR7713C40V01
 -DP2A -KRQCPDD2547~
 -DPV1 -NONE
 -DP4 -KRQCPDD2547~
 -DP5 -KRQCPDD2548~
 -KRQCPDD2907
 DP7 Windows
 Top Brkts for Jambs

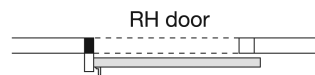

78" High Door w/Header

Jamb Side Trim

Top View

Universal Post -DP2APO78
 Universal Post DP7 -DP7PO78
 Post Top Cap – Two Way -DP()PT2
 Post Cover – Corner -DP()PC78L

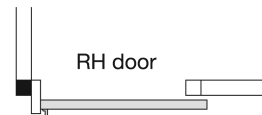

Universal Post -DP2APO78
 Universal Post DP7 -DP7PO78
 Post Top Cap – Three Way -DP()PT3
 Post Cover – Straight -DP()PC78S

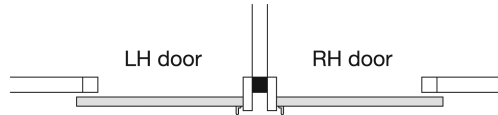

Universal Post -DP2APO78
 Universal Post DP7 -DP7PO78
 Post Top Cap – Three Way -DP()PT3
 Post Cover – Straight -DP()PC78S



End Top Cap -DP()TCT
 DP7 Windows -KRQCPDD2907
 Top Brkts for Jambs

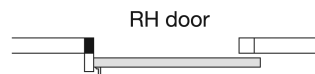

*See Dividends Horizon price list for component pricing.

Morrison Worksurfaces, 1 3/4" 18" D

Standard Specials Systems

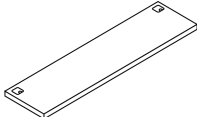
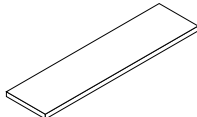
| description | type | w | d | h | pattern no. | lam. | V1 | V2 |
|--|---|---------|--------------------------|--------------------------|-------------------------|--------|--------|--------|
| Straight, 18"D | Grommets  | 18" | 17 5/8" | 1 3/4" | MW2-S1818-A-Q-() | \$418. | \$609. | \$819. |
| | | 24" | 17 5/8" | 1 3/4" | MW2-S2418-A-Q-() | 418. | 609. | 819. |
| | | 30" | 17 5/8" | 1 3/4" | MW2-S3018-A-Q-() | 461. | 649. | 879. |
| | | 36" | 17 5/8" | 1 3/4" | MW2-S3618-A-Q-() | 505. | 689. | 939. |
| | | 42" | 17 5/8" | 1 3/4" | MW2-S4218-A-Q-() | 549. | 747. | 1,037. |
| | | 48" | 17 5/8" | 1 3/4" | MW2-S4818-A-Q-() | 605. | 801. | 1,116. |
| | | 54" | 17 5/8" | 1 3/4" | MW2-S5418-A-Q-() | 642. | 864. | 1,195. |
| | | 60" | 17 5/8" | 1 3/4" | MW2-S6018-A-Q-() | 662. | 899. | 1,276. |
| | | 66" | 17 5/8" | 1 3/4" | MW2-S6618-A-Q-() | 722. | 999. | 1,412. |
| | | 72" | 17 5/8" | 1 3/4" | MW2-S7218-A-Q-() | 780. | 1,100. | 1,534. |
| | | 78" | 17 5/8" | 1 3/4" | MW2-S7818-A-Q-() | 839. | 1,200. | 1,656. |
| | | 84" | 17 5/8" | 1 3/4" | MW2-S8418-A-Q-() | 898. | 1,300. | 1,777. |
| | | 90" | 17 5/8" | 1 3/4" | MW2-S9018-A-Q-() | 957. | 1,401. | 1,899. |
| | | 96" | 17 5/8" | 1 3/4" | MW2-S9618-A-Q-() | 1,016. | 1,501. | 2,020. |
| 102" | 17 5/8" | 1 3/4" | MW2-S10218-A-Q-() | 1,075. | 1,601. | 2,142. | | |
| 108" | 17 5/8" | 1 3/4" | MW2-S10818-A-Q-() | 1,134. | 1,702. | 2,263. | | |
| 114" | 17 5/8" | 1 3/4" | MW2-S11418-A-Q-() | 1,193. | 1,802. | 2,385. | | |
| 120" | 17 5/8" | 1 3/4" | MW2-S12018-A-Q-() | 1,252. | 1,902. | 2,506. | | |
| No Grommets  | 18" | 17 5/8" | 1 3/4" | MW2-S1818-B-Q-() | 349. | 526. | 736. | |
| | 24" | 17 5/8" | 1 3/4" | MW2-S2418-B-Q-() | 349. | 526. | 736. | |
| | 78" | 17 5/8" | 1 3/4" | MW2-S7818-B-Q-() | 815. | 1,117. | 1,573. | |
| | 84" | 17 5/8" | 1 3/4" | MW2-S8418-B-Q-() | 874. | 1,218. | 1,694. | |
| | 90" | 17 5/8" | 1 3/4" | MW2-S9018-B-Q-() | 933. | 1,318. | 1,816. | |
| | 96" | 17 5/8" | 1 3/4" | MW2-S9618-B-Q-() | 992. | 1,418. | 1,938. | |
| | 102" | 17 5/8" | 1 3/4" | MW2-S10218-B-Q-() | 1,051. | 1,519. | 2,059. | |
| | 108" | 17 5/8" | 1 3/4" | MW2-S10818-B-Q-() | 1,110. | 1,619. | 2,181. | |
| | 114" | 17 5/8" | 1 3/4" | MW2-S11418-B-Q-() | 1,169. | 1,719. | 2,302. | |
| | 120" | 17 5/8" | 1 3/4" | MW2-S12018-B-Q-() | 1,228. | 1,820. | 2,424. | |

| Order Code | Specification Information | Application Notes |
|-------------------------------------|---|--|
| Example: MW2-S3618-A-Q-117 | <i>Grommets/no grommets:</i> | 18"D worksurfaces are used interchangeably in desk and panel system applications as shallow main surfaces, extensions, or credenza tops. They must be supported at each end by a pedestal, end panel, end support cantilever or cantilever bridging bracket with a maximum span of 60" between supports. |
| MW2 Worksurface 1 3/4" thick | A- Worksurfaces include 3" grommet in each back corner leading into desk support or wire manager. | All worksurfaces have threaded metal inserts at all end panel, desk support and bracket locations and pilot holes at pedestal locations. |
| S Worksurface type | B- Worksurface does not include grommets. | |
| 36 Width | Specify surface finish | Panel supported worksurfaces over 60" must be mid-span supported by MB2-C18 bracket, specified separately. |
| 18 Depth | All worksurfaces are U.L.-listed. | 18"D worksurfaces with desk supports or filler panels do not accept pedestals. |
| A Grommets | | All worksurfaces are 3/8" less than nominal depth for rear wire clearance or privacy screens. |
| Q Standare Special | | |
| 117 Surface finish | | |

Morrison Worksurfaces, 1 3/4" 24" D

Standard Specials Systems

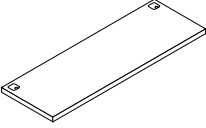
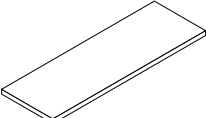
| description | type | w | d | h | pattern no. | lam. | V1 | V2 |
|----------------|---|------|---------|--------|---------------------------|--------|--------|--------|
| Straight, 24"D |  | 18" | 23 5/8" | 1 3/4" | MW2-S1824-A-Q-() | \$469. | \$706. | \$955. |
| | | 102" | 23 5/8" | 1 3/4" | MW2-S10224-A-Q-() | 1,304. | 1,835. | 2,546. |
| | | 108" | 23 5/8" | 1 3/4" | MW2-S10824-A-Q-() | 1,422. | 1,989. | 2,746. |
| | | 114" | 23 5/8" | 1 3/4" | MW2-S11424-A-Q-() | 1,540. | 2,144. | 2,945. |
| | | 120" | 23 5/8" | 1 3/4" | MW2-S12024-A-Q-() | 1,658. | 2,299. | 3,145. |
| No Grommets |  | 18" | 23 5/8" | 1 3/4" | MW2-S1824-B-Q-() | 386. | 623. | 874. |
| | | 102" | 23 5/8" | 1 3/4" | MW2-S10224-B-Q-() | 1,221. | 1,755. | 2,466. |
| | | 108" | 23 5/8" | 1 3/4" | MW2-S10824-B-Q-() | 1,339. | 1,909. | 2,666. |
| | | 114" | 23 5/8" | 1 3/4" | MW2-S11424-B-Q-() | 1,457. | 2,064. | 2,865. |
| | | 120" | 23 5/8" | 1 3/4" | MW2-S12024-B-Q-() | 1,575. | 2,218. | 3,064. |

Morrison System

Order Code

| | |
|------------|---------------------------|
| Example: | MW2-S1824-A-Q-117 |
| MW2 | Worksurface, 1 3/4" thick |
| S | Straight worksurface |
| 18 | Width |
| 24 | Depth |
| A | Grommets |
| Q | Standard Special |
| 117 | Surface finish |

Specification Information

Grommets/no grommets:
 A- Worksurfaces include 3" grommet in each back corner leading into desk support or wire manager.
 B- Worksurface does not include grommets.
 Specify surface finish
 All worksurfaces are U.L.-listed.

Application Notes

24"D worksurfaces are used interchangeably as shallow main surfaces, extensions or credenza tops. They must be supported at each end by a pedestal, end panel, end support cantilever or cantilever bridging bracket with a maximum span of 60" between supports.

All worksurfaces have threaded metal inserts at all end panel, desk support and bracket locations and pilot holes at pedestal locations.

Use 18"D pedestals with 24"D worksurfaces for full wire management capability in desk or panel applications.

All straight worksurfaces are 3/8" less than nominal depth for rear wire clearance or privacy screens.

Plastic laminate worksurfaces are post-formed top and bottom, front and back.

Worksurfaces with grommets are bored to accept and are shipped with wire manager clips.

Panel supported worksurfaces over 60" must be mid-span supported by MB2-C18 bracket, specified separately.

Morrison Worksurfaces, 1 3/4" 30" D

Standard Specials Systems

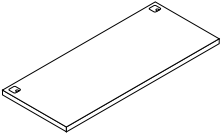
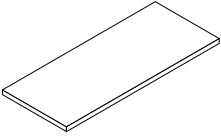
| description | type | w | d | h | pattern no. | lam. | V1 | V2 |
|----------------|--|------|---------|--------|---------------------------|--------|--------|----------|
| Straight, 30"D | Grommets  | 18" | 29 5/8" | 1 3/4" | MW2-S1830-A-Q-() | \$521. | \$726. | \$1,016. |
| | | 24" | 29 5/8" | 1 3/4" | MW2-S2430-A-Q-() | 521. | 726. | 1,016. |
| | | 102" | 29 5/8" | 1 3/4" | MW2-S10230-A-Q-() | 1,436. | 2,012. | 2,879. |
| | | 108" | 29 5/8" | 1 3/4" | MW2-S10830-A-Q-() | 1,554. | 2,169. | 3,115. |
| | | 114" | 29 5/8" | 1 3/4" | MW2-S11430-A-Q-() | 1,672. | 2,326. | 3,351. |
| | | 120" | 29 5/8" | 1 3/4" | MW2-S12030-A-Q-() | 1,790. | 2,483. | 3,587. |
| | No Grommets  | 18" | 29 5/8" | 1 3/4" | MW2-S1830-B-Q-() | 441. | 647. | 939. |
| | | 24" | 29 5/8" | 1 3/4" | MW2-S2430-B-Q-() | 441. | 647. | 939. |
| | | 102" | 29 5/8" | 1 3/4" | MW2-S10230-B-Q-() | 1,352. | 1,927. | 2,801. |
| | | 108" | 29 5/8" | 1 3/4" | MW2-S10830-B-Q-() | 1,470. | 2,084. | 3,037. |
| | | 114" | 29 5/8" | 1 3/4" | MW2-S11430-B-Q-() | 1,588. | 2,241. | 3,273. |
| | | 120" | 29 5/8" | 1 3/4" | MW2-S12030-B-Q-() | 1,706. | 2,398. | 3,509. |

| Order Code | Specification Information | Application Notes |
|--------------------------------------|---|---|
| Example: MW2-S4230A-Q-117 | <i>Grommets/no grommets:</i> | 30"D worksurfaces are used interchangeably in desk and panel system applications as main surfaces, extensions or credenza tops. They must be supported at each end by a pedestal, end panel, end support cantilever or cantilever bridging bracket with a maximum span of 60" between supports. |
| MW2 Worksurface, 1 3/4" thick | A- worksurface includes 3" grommet in each back corner leading into desk support or wire manager clips. | All straight worksurfaces are 3/8" less than nominal depth for rear wire clearance or privacy screens. Panel supported worksurfaces over 60" must be mid-span supported by MB2-C18 bracket, specified separately. |
| S Straight worksurface | B- worksurface does not include grommets | |
| 42 Width | Specify surface finish. | Plastic laminate worksurfaces are post-formed top and bottom, front and back. |
| 30 Depth | All worksurfaces are U.L.-listed. | |
| A Grommets | | |
| Q Standard Special | | |
| 117 Surface finish | | |

Morrison Worksurfaces, 1 3/4" 36" D

Standard Specials Systems

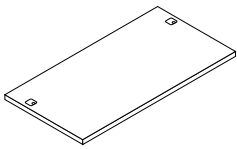
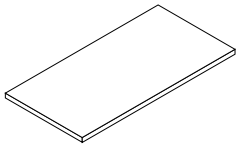
| description | type | w | d | h | pattern no. | lam. | V1 | V2 |
|--|--|------|---------|--------|---------------------------|--------|--------|----------|
| Straight, 36"D | Recessed Grommets  | 36" | 35 3/8" | 1 3/4" | MW2-S3636-R-Q-() | \$873. | \$930. | \$1,387. |
| | | 42" | 35 3/8" | 1 3/4" | MW2-S4236-R-Q-() | 917. | 1,049. | 1,522. |
| | | 48" | 35 3/8" | 1 3/4" | MW2-S4836-R-Q-() | 961. | 1,168. | 1,658. |
| | | 54" | 35 3/8" | 1 3/4" | MW2-S5436-R-Q-() | 1,004. | 1,287. | 1,794. |
| | | 60" | 35 3/8" | 1 3/4" | MW2-S6036-R-Q-() | 1,048. | 1,407. | 1,929. |
| | | 84" | 35 3/8" | 1 3/4" | MW2-S8436-R-Q-() | 1,305. | 1,797. | 2,420. |
| | | 90" | 35 3/8" | 1 3/4" | MW2-S9036-R-Q-() | 1,405. | 1,933. | 2,556. |
| | | 96" | 35 3/8" | 1 3/4" | MW2-S9636-R-Q-() | 1,506. | 2,069. | 2,692. |
| | | 102" | 35 3/8" | 1 3/4" | MW2-S10236-R-Q-() | 1,606. | 2,204. | 2,827. |
| | | 108" | 35 3/8" | 1 3/4" | MW2-S10836-R-Q-() | 1,706. | 2,340. | 2,963. |
| | | 114" | 35 3/8" | 1 3/4" | MW2-S11436-R-Q-() | 1,807. | 2,476. | 3,099. |
| | | 120" | 35 3/8" | 1 3/4" | MW2-S12036-R-Q-() | 1,907. | 2,611. | 3,234. |
| No Grommets  | No Grommets | 36" | 35 3/8" | 1 3/4" | MW2-S3636-B-Q-() | 720. | 848. | 1,375. |
| | | 42" | 35 3/8" | 1 3/4" | MW2-S4236-B-Q-() | 781. | 968. | 1,494. |
| | | 48" | 35 3/8" | 1 3/4" | MW2-S4836-B-Q-() | 843. | 1,087. | 1,613. |
| | | 54" | 35 3/8" | 1 3/4" | MW2-S5436-B-Q-() | 904. | 1,206. | 1,732. |
| | | 60" | 35 3/8" | 1 3/4" | MW2-S6036-B-Q-() | 965. | 1,325. | 1,851. |
| | | 84" | 35 3/8" | 1 3/4" | MW2-S8436-B-Q-() | 1,222. | 1,717. | 2,342. |
| | | 90" | 35 3/8" | 1 3/4" | MW2-S9036-B-Q-() | 1,323. | 1,853. | 2,478. |
| | | 96" | 35 3/8" | 1 3/4" | MW2-S9636-B-Q-() | 1,423. | 1,988. | 2,614. |
| | | 102" | 35 3/8" | 1 3/4" | MW2-S10236-B-Q-() | 1,523. | 2,124. | 2,749. |
| | | 108" | 35 3/8" | 1 3/4" | MW2-S10836-B-Q-() | 1,624. | 2,260. | 2,885. |
| | | 114" | 35 3/8" | 1 3/4" | MW2-S11436-B-Q-() | 1,724. | 2,395. | 3,021. |
| | | 120" | 35 3/8" | 1 3/4" | MW2-S12036-B-Q-() | 1,824. | 2,531. | 3,157. |

Morrison System

Order Code

| | |
|------------|---------------------------|
| Example: | MW2-S6036R-Q-117 |
| MW2 | Worksurface, 1 3/4" thick |
| S | Straight worksurface |
| 60 | Width |
| 36 | Depth |
| R | Grommets |
| Q | Standare Special |
| 117 | Surface finish |

Specification Information

Grommets/no grommets:
B- worksurface does not include grommets
R- worksurface includes 3" grommets recessed for use with 6" recessed desk support.
 Specify surface finish.
 All worksurfaces are U.L.-listed.

Application Notes

36"D desks may be planned with 6" recessed desk support and 24"D pedestals or end panels, or 29" or 35"W universal end panels with knee-hole filler. 36"D worksurfaces do not accept privacy screens.

Plastic laminate worksurfaces are post-formed top and bottom, front and back.

All straight worksurfaces are 3/8" less than nominal depth for rear wire clearance or privacy screens.

Panel supported worksurfaces over 60" must be mid-span supported by MB2-C18 bracket, specified separately.

Morrison Worksurfaces, 1 3/4" 18" D + Post

Standard Specials Systems

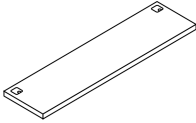
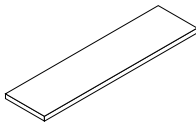
| description | type | w | d | h | pattern no. | lam. | V1 | V2 |
|--|---|--------|---------------------------|--------|---------------------------|--------|--------|--------|
| Straight, 18"D + Post | Grommets  | 20" | 17 3/8" | 1 3/4" | MW2-S2018-A-Q-() | \$418. | \$609. | \$819. |
| | | 26" | 17 3/8" | 1 3/4" | MW2-S2618-A-Q-() | 461. | 649. | 879. |
| | | 32" | 17 3/8" | 1 3/4" | MW2-S3218-A-Q-() | 505. | 689. | 939. |
| | | 38" | 17 3/8" | 1 3/4" | MW2-S3818-A-Q-() | 549. | 747. | 1,037. |
| | | 44" | 17 3/8" | 1 3/4" | MW2-S4418-A-Q-() | 605. | 801. | 1,116. |
| | | 50" | 17 3/8" | 1 3/4" | MW2-S5018-A-Q-() | 642. | 864. | 1,195. |
| | | 56" | 17 3/8" | 1 3/4" | MW2-S5618-A-Q-() | 662. | 899. | 1,276. |
| | | 62" | 17 3/8" | 1 3/4" | MW2-S6218-A-Q-() | 722. | 999. | 1,412. |
| | | 68" | 17 3/8" | 1 3/4" | MW2-S6818-A-Q-() | 780. | 1,100. | 1,534. |
| | | 74" | 17 3/8" | 1 3/4" | MW2-S7418-A-Q-() | 839. | 1,200. | 1,656. |
| | | 80" | 17 3/8" | 1 3/4" | MW2-S8018-A-Q-() | 898. | 1,300. | 1,777. |
| | | 86" | 17 3/8" | 1 3/4" | MW2-S8618-A-Q-() | 957. | 1,401. | 1,899. |
| | | 92" | 17 3/8" | 1 3/4" | MW2-S9218-A-Q-() | 1,016. | 1,501. | 2,020. |
| | | 98" | 17 3/8" | 1 3/4" | MW2-S9818-A-Q-() | 1,075. | 1,601. | 2,142. |
| | | 104" | 17 3/8" | 1 3/4" | MW2-S10418-A-Q-() | 1,134. | 1,702. | 2,263. |
| | | 110" | 17 3/8" | 1 3/4" | MW2-S11018-A-Q-() | 1,193. | 1,802. | 2,385. |
| 116" | 17 3/8" | 1 3/4" | MW2-S11618-A-Q-() | 1,252. | 1,902. | 2,506. | | |
| No Grommets  | No Grommets | 20" | 17 3/8" | 1 3/4" | MW2-S2018-B-Q-() | 349. | 526. | 736. |
| | | 26" | 17 3/8" | 1 3/4" | MW2-S2618-B-Q-() | 386. | 566. | 797. |
| | | 32" | 17 3/8" | 1 3/4" | MW2-S3218-B-Q-() | 422. | 607. | 857. |
| | | 38" | 17 3/8" | 1 3/4" | MW2-S3818-B-Q-() | 466. | 664. | 955. |
| | | 44" | 17 3/8" | 1 3/4" | MW2-S4418-B-Q-() | 523. | 719. | 1,034. |
| | | 50" | 17 3/8" | 1 3/4" | MW2-S5018-B-Q-() | 559. | 781. | 1,113. |
| | | 56" | 17 3/8" | 1 3/4" | MW2-S5618-B-Q-() | 579. | 817. | 1,193. |
| | | 62" | 17 3/8" | 1 3/4" | MW2-S6218-B-Q-() | 640. | 917. | 1,330. |
| | | 68" | 17 3/8" | 1 3/4" | MW2-S6818-B-Q-() | 756. | 1,017. | 1,451. |
| | | 74" | 17 3/8" | 1 3/4" | MW2-S7418-B-Q-() | 815. | 1,117. | 1,573. |
| | | 80" | 17 3/8" | 1 3/4" | MW2-S8018-B-Q-() | 874. | 1,218. | 1,694. |
| | | 86" | 17 3/8" | 1 3/4" | MW2-S8618-B-Q-() | 933. | 1,318. | 1,816. |
| | | 92" | 17 3/8" | 1 3/4" | MW2-S9218-B-Q-() | 992. | 1,418. | 1,938. |
| | | 98" | 17 3/8" | 1 3/4" | MW2-S9818-B-Q-() | 1,051. | 1,519. | 2,059. |
| | | 104" | 17 3/8" | 1 3/4" | MW2-S10418-B-Q-() | 1,110. | 1,619. | 2,181. |
| | | 110" | 17 3/8" | 1 3/4" | MW2-S11018-B-Q-() | 1,169. | 1,719. | 2,302. |
| 116" | 17 3/8" | 1 3/4" | MW2-S11618-B-Q-() | 1,228. | 1,820. | 2,424. | | |

| Order Code | Specification Information | Application Notes |
|-------------------------------------|---|--|
| Example: MW2-S3818-B-Q-117 | <i>Grommets/no grommets:</i> | 18"D worksurfaces are used interchangeably in desk and panel system applications as shallow main surfaces, extensions, or credenza tops. They must be supported at each end by a pedestal, end panel, end support cantilever or cantilever bridging bracket with a maximum span of 60" between supports. |
| MW2 Worksurface 1 3/4" thick | A- Worksurfaces include 3" grommet in each back corner leading into desk support or wire manager. | |
| S Worksurface type | B- Worksurface does not include grommets. | 18"D worksurfaces with desk supports or filler panels do not accept pedestals. All worksurfaces are 3/8" less than nominal depth for rear wire clearance or privacy screens. |
| 38 Width | Specify surface finish | |
| 18 Depth | All worksurfaces are U.L.-listed. | All worksurfaces have threaded metal inserts at all end panel, desk support and bracket locations and pilot holes at pedestal locations. Panel supported worksurfaces over 60" must be mid-span supported by MB2-C18 bracket, specified separately. |
| B No grommets | | |
| Q Standard Special | | |
| 117 Surface finish | | |

Morrison Worksurfaces, 1 3/4" 24" D + Post

Standard Specials Systems

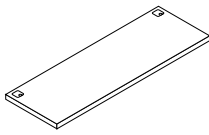
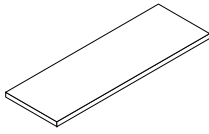
| description | type | w | d | h | pattern no. | lam. | V1 | V2 |
|-----------------------|---|--------|--------------------|--------|--------------------|--------|--------|--------|
| Straight, 24"D + Post | Grommets  | 20" | 23 5/8" | 1 3/4" | MW2-S2024-A-Q-() | \$469. | \$706. | \$955. |
| | | 26" | 23 5/8" | 1 3/4" | MW2-S2624-A-Q-() | 506. | 725. | 994. |
| | | 32" | 23 5/8" | 1 3/4" | MW2-S3224-A-Q-() | 548. | 766. | 1,036. |
| | | 38" | 23 5/8" | 1 3/4" | MW2-S3824-A-Q-() | 605. | 802. | 1,115. |
| | | 44" | 23 5/8" | 1 3/4" | MW2-S4424-A-Q-() | 642. | 880. | 1,237. |
| | | 50" | 23 5/8" | 1 3/4" | MW2-S5024-A-Q-() | 682. | 958. | 1,335. |
| | | 56" | 23 5/8" | 1 3/4" | MW2-S5624-A-Q-() | 739. | 1,021. | 1,412. |
| | | 62" | 23 5/8" | 1 3/4" | MW2-S6224-A-Q-() | 798. | 1,115. | 1,553. |
| | | 68" | 23 5/8" | 1 3/4" | MW2-S6824-A-Q-() | 876. | 1,211. | 1,713. |
| | | 74" | 23 5/8" | 1 3/4" | MW2-S7424-A-Q-() | 952. | 1,310. | 1,829. |
| | | 80" | 23 5/8" | 1 3/4" | MW2-S8024-A-Q-() | 1,010. | 1,407. | 1,968. |
| | | 86" | 23 5/8" | 1 3/4" | MW2-S8624-A-Q-() | 1,087. | 1,526. | 2,149. |
| | | 92" | 23 5/8" | 1 3/4" | MW2-S9224-A-Q-() | 1,186. | 1,680. | 2,347. |
| | | 98" | 23 5/8" | 1 3/4" | MW2-S9824-A-Q-() | 1,304. | 1,835. | 2,546. |
| | | 104" | 23 5/8" | 1 3/4" | MW2-S10424-A-Q-() | 1,422. | 1,989. | 2,746. |
| | | 110" | 23 5/8" | 1 3/4" | MW2-S11024-A-Q-() | 1,540. | 2,144. | 2,945. |
| 116" | 23 5/8" | 1 3/4" | MW2-S11624-A-Q-() | 1,658. | 2,299. | 3,145. | | |
| No Grommets |  | 20" | 23 5/8" | 1 3/4" | MW2-S2024-B-Q-() | 386. | 623. | 874. |
| | | 26" | 23 5/8" | 1 3/4" | MW2-S2624-B-Q-() | 422. | 643. | 916. |
| | | 32" | 23 5/8" | 1 3/4" | MW2-S3224-B-Q-() | 466. | 683. | 955. |
| | | 38" | 23 5/8" | 1 3/4" | MW2-S3824-B-Q-() | 523. | 719. | 1,034. |
| | | 44" | 23 5/8" | 1 3/4" | MW2-S4424-B-Q-() | 559. | 800. | 1,154. |
| | | 50" | 23 5/8" | 1 3/4" | MW2-S5024-B-Q-() | 602. | 877. | 1,253. |
| | | 56" | 23 5/8" | 1 3/4" | MW2-S5624-B-Q-() | 655. | 940. | 1,330. |
| | | 62" | 23 5/8" | 1 3/4" | MW2-S6224-B-Q-() | 715. | 1,034. | 1,471. |
| | | 68" | 23 5/8" | 1 3/4" | MW2-S6824-B-Q-() | 791. | 1,132. | 1,632. |
| | | 74" | 23 5/8" | 1 3/4" | MW2-S7424-B-Q-() | 870. | 1,228. | 1,752. |
| | | 80" | 23 5/8" | 1 3/4" | MW2-S8024-B-Q-() | 930. | 1,325. | 1,889. |
| | | 86" | 23 5/8" | 1 3/4" | MW2-S8624-B-Q-() | 1,003. | 1,446. | 2,067. |
| | | 92" | 23 5/8" | 1 3/4" | MW2-S9224-B-Q-() | 1,103. | 1,600. | 2,267. |
| | | 98" | 23 5/8" | 1 3/4" | MW2-S9824-B-Q-() | 1,221. | 1,755. | 2,466. |
| | | 104" | 23 5/8" | 1 3/4" | MW2-S10424-B-Q-() | 1,339. | 1,909. | 2,666. |
| | | 110" | 23 5/8" | 1 3/4" | MW2-S11024-B-Q-() | 1,457. | 2,064. | 2,865. |
| 116" | 23 5/8" | 1 3/4" | MW2-S11624-B-Q-() | 1,575. | 2,218. | 3,064. | | |

Morrison System

| Order Code | Specification Information | Application Notes |
|--------------------------------------|---|---|
| Example: MW2-S7424-A-Q-117 | <i>Grommets/no grommets:</i> | 24"D worksurfaces are used interchangeably as shallow main surfaces, extensions or credenza tops. They must be supported at each end by a pedestal, end panel, end support cantilever or cantilever bridging bracket with a maximum span of 60" between supports. |
| MW2 Worksurface, 1 3/4" thick | A- Worksurfaces include 3" grommet in each back corner leading into desk support or wire manager. | |
| S Straight worksurface | B- Worksurface does not include grommets. | All worksurfaces have threaded metal inserts at all end panel, desk support and bracket locations and pilot holes at pedestal locations. |
| 74 Width | Specify surface finish | |
| 24 Depth | All worksurfaces are U.L.-listed. | Use 18"D pedestals with 24"D worksurfaces for full wire management capability in desk or panel applications. |
| A Grommets | | |
| Q Standard Special | | All straight worksurfaces are 3/8" less than nominal depth for rear wire clearance or privacy screens. |
| 117 Surface finish | | |

Plastic laminate worksurfaces are post-formed top and bottom, front and back.

Worksurfaces with grommets are bored to accept and are shipped with wire manager clips.

Panel supported worksurfaces over 60" must be mid-span supported by MB2-C18 bracket, specified separately.

Morrison Worksurfaces, 1 3/4"

30" D + Post

Standard Specials Systems

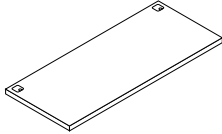
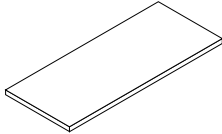
| description | type | w | d | h | pattern no. | lam. | V1 | V2 |
|-----------------------|---|--------|--------------------------|--------|--------------------------|--------|--------|----------|
| Straight, 30"D + Post |  | 20" | 29 5/8" | 1 3/4" | MW2-S2030-A-Q(-) | \$521. | \$726. | \$1,016. |
| | | 26" | 29 5/8" | 1 3/4" | MW2-S2630-A-Q(-) | 564. | 784. | 1,096. |
| | | 32" | 29 5/8" | 1 3/4" | MW2-S3230-A-Q(-) | 624. | 841. | 1,176. |
| | | 38" | 29 5/8" | 1 3/4" | MW2-S3830-A-Q(-) | 661. | 900. | 1,253. |
| | | 44" | 29 5/8" | 1 3/4" | MW2-S4430-A-Q(-) | 719. | 977. | 1,352. |
| | | 50" | 29 5/8" | 1 3/4" | MW2-S5030-A-Q(-) | 755. | 1,056. | 1,429. |
| | | 56" | 29 5/8" | 1 3/4" | MW2-S5630-A-Q(-) | 798. | 1,115. | 1,553. |
| | | 62" | 29 5/8" | 1 3/4" | MW2-S6230-A-Q(-) | 858. | 1,194. | 1,691. |
| | | 68" | 29 5/8" | 1 3/4" | MW2-S6830-A-Q(-) | 952. | 1,310. | 1,829. |
| | | 74" | 29 5/8" | 1 3/4" | MW2-S7430-A-Q(-) | 1,030. | 1,429. | 1,988. |
| | | 80" | 29 5/8" | 1 3/4" | MW2-S8030-A-Q(-) | 1,107. | 1,545. | 2,169. |
| | | 86" | 29 5/8" | 1 3/4" | MW2-S8630-A-Q(-) | 1,205. | 1,698. | 2,407. |
| | | 92" | 29 5/8" | 1 3/4" | MW2-S9230-A-Q(-) | 1,318. | 1,855. | 2,643. |
| | | 98" | 29 5/8" | 1 3/4" | MW2-S9830-A-Q(-) | 1,436. | 2,012. | 2,879. |
| | | 104" | 29 5/8" | 1 3/4" | MW2-S10430-A-Q(-) | 1,554. | 2,169. | 3,115. |
| | | 110" | 29 5/8" | 1 3/4" | MW2-S11030-A-Q(-) | 1,672. | 2,326. | 3,351. |
| 116" | 29 5/8" | 1 3/4" | MW2-S11630-A-Q(-) | 1,790. | 2,483. | 3,587. | | |
| No Grommets |  | 20" | 29 5/8" | 1 3/4" | MW2-S2030-B-Q(-) | 441. | 647. | 939. |
| | | 26" | 29 5/8" | 1 3/4" | MW2-S2630-B-Q(-) | 485. | 704. | 1,017. |
| | | 32" | 29 5/8" | 1 3/4" | MW2-S3230-B-Q(-) | 543. | 762. | 1,095. |
| | | 38" | 29 5/8" | 1 3/4" | MW2-S3830-B-Q(-) | 579. | 817. | 1,175. |
| | | 44" | 29 5/8" | 1 3/4" | MW2-S4430-B-Q(-) | 637. | 894. | 1,273. |
| | | 50" | 29 5/8" | 1 3/4" | MW2-S5030-B-Q(-) | 676. | 976. | 1,349. |
| | | 56" | 29 5/8" | 1 3/4" | MW2-S5630-B-Q(-) | 715. | 1,034. | 1,471. |
| | | 62" | 29 5/8" | 1 3/4" | MW2-S6230-B-Q(-) | 778. | 1,113. | 1,611. |
| | | 68" | 29 5/8" | 1 3/4" | MW2-S6830-B-Q(-) | 870. | 1,228. | 1,752. |
| | | 74" | 29 5/8" | 1 3/4" | MW2-S7430-B-Q(-) | 949. | 1,349. | 1,907. |
| | | 80" | 29 5/8" | 1 3/4" | MW2-S8030-B-Q(-) | 1,027. | 1,463. | 2,086. |
| | | 86" | 29 5/8" | 1 3/4" | MW2-S8630-B-Q(-) | 1,122. | 1,617. | 2,328. |
| | | 92" | 29 5/8" | 1 3/4" | MW2-S9230-B-Q(-) | 1,234. | 1,770. | 2,565. |
| | | 98" | 29 5/8" | 1 3/4" | MW2-S9830-B-Q(-) | 1,352. | 1,927. | 2,801. |
| | | 104" | 29 5/8" | 1 3/4" | MW2-S10430-B-Q(-) | 1,470. | 2,084. | 3,037. |
| | | 110" | 29 5/8" | 1 3/4" | MW2-S11030-B-Q(-) | 1,588. | 2,241. | 3,273. |
| 116" | 29 5/8" | 1 3/4" | MW2-S11630-B-Q(-) | 1,706. | 2,398. | 3,509. | | |

| Order Code | Specification Information | Application Notes |
|--------------------------------------|---|---|
| Example: MW2-S4430A-Q-117 | <i>Grommets/no grommets:</i> | 30"D worksurfaces are used interchangeably in desk and panel system applications as main surfaces, extensions or credenza tops. They must be supported at each end by a pedestal, end panel, end support cantilever or cantilever bridging bracket with a maximum span of 60" between supports. |
| MW2 Worksurface, 1 3/4" thick | A- worksurface includes 3" grommet in each back corner leading into desk support or wire manager clips. | |
| S Straight worksurface | B- worksurface does not include grommets | All straight worksurfaces are 3/8" less than nominal depth for rear wire clearance or privacy screens. |
| 44 Width | Specify surface finish. | |
| 30 Depth | All worksurfaces are U.L.-listed. | Panel supported worksurfaces over 60" must be mid-span supported by MB2-C18 bracket, specified separately. |
| A Grommets | | |
| Q Standard Special | | |
| 117 Surface finish | | |

Morrison Worksurfaces, 1 3/4" 36" D + Post

Standard Specials Systems

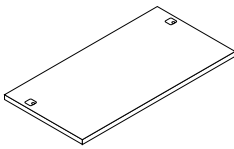
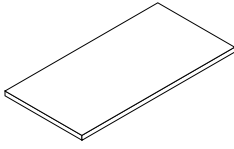
| description | type | w | d | h | pattern no. | lam. | V1 | V2 |
|--|--|------|---------|--------|---------------------------|--------|----------|----------|
| Straight, 36"D + Post | Recessed Grommets  | 38" | 35 3/8" | 1 3/4" | MW2-S3836-R-Q-() | \$917. | \$1,049. | \$1,522. |
| | | 44" | 35 3/8" | 1 3/4" | MW2-S4436-R-Q-() | 961. | 1,168. | 1,658. |
| | | 50" | 35 3/8" | 1 3/4" | MW2-S5036-R-Q-() | 1,004. | 1,287. | 1,794. |
| | | 56" | 35 3/8" | 1 3/4" | MW2-S5636-R-Q-() | 1,048. | 1,407. | 1,929. |
| | | 62" | 35 3/8" | 1 3/4" | MW2-S6236-R-Q-() | 1,077. | 1,467. | 2,039. |
| | | 68" | 35 3/8" | 1 3/4" | MW2-S6836-R-Q-() | 1,107. | 1,526. | 2,149. |
| | | 74" | 35 3/8" | 1 3/4" | MW2-S7436-R-Q-() | 1,205. | 1,661. | 2,284. |
| | | 80" | 35 3/8" | 1 3/4" | MW2-S8036-R-Q-() | 1,305. | 1,797. | 2,420. |
| | | 86" | 35 3/8" | 1 3/4" | MW2-S8636-R-Q-() | 1,405. | 1,933. | 2,556. |
| | | 92" | 35 3/8" | 1 3/4" | MW2-S9236-R-Q-() | 1,506. | 2,069. | 2,692. |
| | | 98" | 35 3/8" | 1 3/4" | MW2-S9836-R-Q-() | 1,606. | 2,204. | 2,827. |
| | | 104" | 35 3/8" | 1 3/4" | MW2-S10436-R-Q-() | 1,706. | 2,340. | 2,963. |
| | | 110" | 35 3/8" | 1 3/4" | MW2-S11036-R-Q-() | 1,807. | 2,476. | 3,099. |
| | | 116" | 35 3/8" | 1 3/4" | MW2-S11636-R-Q-() | 1,907. | 2,611. | 3,234. |
| No Grommets  | No Grommets | 38" | 35 3/8" | 1 3/4" | MW2-S3836-B-Q-() | 781. | 968. | 1,494. |
| | | 44" | 35 3/8" | 1 3/4" | MW2-S4436-B-Q-() | 843. | 1,087. | 1,613. |
| | | 50" | 35 3/8" | 1 3/4" | MW2-S5036-B-Q-() | 904. | 1,206. | 1,732. |
| | | 56" | 35 3/8" | 1 3/4" | MW2-S5636-B-Q-() | 965. | 1,325. | 1,851. |
| | | 62" | 35 3/8" | 1 3/4" | MW2-S6236-B-Q-() | 996. | 1,385. | 1,960. |
| | | 68" | 35 3/8" | 1 3/4" | MW2-S6836-B-Q-() | 1,027. | 1,446. | 2,067. |
| | | 74" | 35 3/8" | 1 3/4" | MW2-S7436-B-Q-() | 1,122. | 1,581. | 2,207. |
| | | 80" | 35 3/8" | 1 3/4" | MW2-S8036-B-Q-() | 1,222. | 1,717. | 2,342. |
| | | 86" | 35 3/8" | 1 3/4" | MW2-S8636-B-Q-() | 1,323. | 1,853. | 2,478. |
| | | 92" | 35 3/8" | 1 3/4" | MW2-S9236-B-Q-() | 1,423. | 1,988. | 2,614. |
| | | 98" | 35 3/8" | 1 3/4" | MW2-S9836-B-Q-() | 1,523. | 2,124. | 2,749. |
| | | 104" | 35 3/8" | 1 3/4" | MW2-S10436-B-Q-() | 1,624. | 2,260. | 2,885. |
| | | 110" | 35 3/8" | 1 3/4" | MW2-S11036-B-Q-() | 1,724. | 2,395. | 3,021. |
| | | 116" | 35 3/8" | 1 3/4" | MW2-S11636-B-Q-() | 1,824. | 2,531. | 3,157. |

Morrison System

Order Code

| | |
|------------|---------------------------|
| Example: | MW2-S6836R-Q-117 |
| MW2 | Worksurface, 1 3/4" thick |
| S | Straight worksurface |
| 68 | Width |
| 36 | Depth |
| R | Grommets |
| Q | Standard Special |
| 117 | Surface finish |

Specificatin Information

Grommets/no grommets:
 B- worksurface does not include grommets
 R- worksurface includes 3" grommets recessed for use with 6" recessed desk support.
 Specify surface finish.
 All worksurfaces are U.L.-listed.

Application Notes

36"D desks may be planned with 6" recessed desk support and 24"D pedestals or end panels, or 29" or 35"W universal end panels with kneehole filler. 36"D worksurfaces do not accept privacy screens.
 Plastic laminate worksurfaces are post-formed top and bottom, front and back.
 All straight worksurfaces are 3/8" less than nominal depth for rear wire clearance or privacy screens.

Panel supported worksurfaces over 60" must be mid-span supported by MB2-C18 bracket, specified separately.

Morrison Worksurfaces, 1 1/4" 18" D

Standard Specials Systems

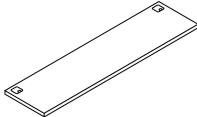
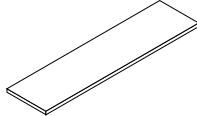
| description | type | w | d | h | pattern no. | lam. | V1 | V2 |
|----------------|---|--------|---------------------------|--------|---------------------------|--------|--------|--------|
| Straight, 18"D |  | 18" | 17 5/8" | 1 1/4" | MU1-S1818-A-Q-() | \$350. | \$511. | \$704. |
| | | 24" | 17 5/8" | 1 1/4" | MU1-S2418-A-Q-() | 350. | 511. | 704. |
| | | 30" | 17 5/8" | 1 1/4" | MU1-S3018-A-Q-() | 381. | 546. | 759. |
| | | 36" | 17 5/8" | 1 1/4" | MU1-S3618-A-Q-() | 413. | 582. | 813. |
| | | 42" | 17 5/8" | 1 1/4" | MU1-S4218-A-Q-() | 430. | 623. | 887. |
| | | 48" | 17 5/8" | 1 1/4" | MU1-S4818-A-Q-() | 487. | 677. | 964. |
| | | 54" | 17 5/8" | 1 1/4" | MU1-S5418-A-Q-() | 505. | 714. | 1,021. |
| | | 60" | 17 5/8" | 1 1/4" | MU1-S6018-A-Q-() | 526. | 752. | 1,099. |
| | | 66" | 17 5/8" | 1 1/4" | MU1-S6618-A-Q-() | 562. | 827. | 1,207. |
| | | 72" | 17 5/8" | 1 1/4" | MU1-S7218-A-Q-() | 617. | 917. | 1,324. |
| | | 78" | 17 5/8" | 1 1/4" | MU1-S7818-A-Q-() | 676. | 1,007. | 1,442. |
| | | 84" | 17 5/8" | 1 1/4" | MU1-S8418-A-Q-() | 735. | 1,096. | 1,560. |
| | | 90" | 17 5/8" | 1 1/4" | MU1-S9018-A-Q-() | 794. | 1,186. | 1,678. |
| | | 96" | 17 5/8" | 1 1/4" | MU1-S9618-A-Q-() | 853. | 1,276. | 1,796. |
| | | 102" | 17 5/8" | 1 1/4" | MU1-S10218-A-Q-() | 912. | 1,365. | 1,914. |
| | | 108" | 17 5/8" | 1 1/4" | MU1-S10818-A-Q-() | 971. | 1,455. | 2,032. |
| 114" | 17 5/8" | 1 1/4" | MU1-S11418-A-Q-() | 1,030. | 1,545. | 2,150. | | |
| 120" | 17 5/8" | 1 1/4" | MU1-S12018-A-Q-() | 1,089. | 1,634. | 2,268. | | |
| No Grommets |  | 18" | 17 5/8" | 1 1/4" | MU1-S1818-B-Q-() | 267. | 428. | 622. |
| | | 78" | 17 5/8" | 1 1/4" | MU1-S7818-B-Q-() | 653. | 924. | 1,359. |
| | | 84" | 17 5/8" | 1 1/4" | MU1-S8418-B-Q-() | 712. | 1,014. | 1,477. |
| | | 90" | 17 5/8" | 1 1/4" | MU1-S9018-B-Q-() | 771. | 1,103. | 1,595. |
| | | 96" | 17 5/8" | 1 1/4" | MU1-S9618-B-Q-() | 830. | 1,193. | 1,713. |
| | | 102" | 17 5/8" | 1 1/4" | MU1-S10218-B-Q-() | 889. | 1,283. | 1,831. |
| | | 108" | 17 5/8" | 1 1/4" | MU1-S10818-B-Q-() | 948. | 1,372. | 1,949. |
| | | 114" | 17 5/8" | 1 1/4" | MU1-S11418-B-Q-() | 1,007. | 1,462. | 2,067. |
| 120" | 17 5/8" | 1 1/4" | MU1-S12018-B-Q-() | 1,066. | 1,552. | 2,185. | | |

Order Code

| | |
|------------|--------------------------|
| Example: | MU1-S4818-A-Q-117 |
| MU1 | Worksurface 1 1/4" thick |
| S | Worksurface type |
| 48 | Width |
| 18 | Depth |
| A | Grommets |
| Q | Standard Special |
| 117 | Surface finish |
| Q | Standard Special |

Specification Information

Grommets/no grommets:

A- Worksurfaces include 3" grommet in each back corner leading into desk support or wire manager.

B- Worksurface does not include grommets.

Specify surface finish.
1 1/4" worksurfaces are 3-ply, solid core construction with threaded metal inserts at all end panel, desk support and bracket locations and pilot holes at pedestal locations.

Worksurfaces with grommets are bored to accept and are shipped with wire manager clips.

All worksurfaces are U.L.-listed.

Application Notes

18"D worksurfaces are used interchangeably in desk and panel system applications as shallow main surfaces, extensions, or credenza tops. They may be supported at each end by an 18" end support bracket, 18" cantilever bracket, 18"W conference end panel, 18"D pedestal, or 12"W end panel (MN2-E12) in conjunction with a desk support.

18"D worksurfaces with desk supports do not accept pedestals.

All worksurfaces are 3/8" less than nominal depth for rear wire clearance or privacy screens.

Panel-supported 1 1/4" worksurfaces over 48" must be mid-span supported by MB2-C18 bracket, specified separately.

Suspended pedestals may not be used with 1 1/4" worksurfaces

Morrison Worksurfaces, 1 1/4" 24" D

Standard Specials Systems

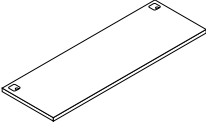
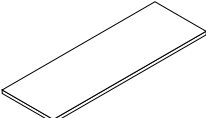
| description | type | w | d | h | pattern no. | lam. | V1 | V2 |
|----------------|---|------|---------|--------|---------------------------|--------|--------|--------|
| Straight, 24"D |  | 18" | 23 5/8" | 1 1/4" | MU1-S1824-A-Q-() | \$376. | \$602. | \$830. |
| | | 102" | 23 5/8" | 1 1/4" | MU1-S10224-A-Q-() | 1,002. | 1,483. | 2,139. |
| | | 108" | 23 5/8" | 1 1/4" | MU1-S10824-A-Q-() | 1,079. | 1,601. | 2,310. |
| | | 114" | 23 5/8" | 1 1/4" | MU1-S11424-A-Q-() | 1,155. | 1,719. | 2,482. |
| | | 120" | 23 5/8" | 1 1/4" | MU1-S12024-A-Q-() | 1,232. | 1,837. | 2,653. |
| No Grommets |  | 18" | 23 5/8" | 1 1/4" | MU1-S1824-B-Q-() | 299. | 523. | 752. |
| | | 102" | 23 5/8" | 1 1/4" | MU1-S10224-B-Q-() | 919. | 1,402. | 2,060. |
| | | 108" | 23 5/8" | 1 1/4" | MU1-S10824-B-Q-() | 996. | 1,520. | 2,231. |
| | | 114" | 23 5/8" | 1 1/4" | MU1-S11424-B-Q-() | 1,073. | 1,638. | 2,402. |
| | | 120" | 23 5/8" | 1 1/4" | MU1-S12024-B-Q-() | 1,149. | 1,756. | 2,574. |

Morrison System

| Order Code | Specification Information | Application Notes |
|--------------------------------------|--|--|
| Example: MU1-S10224-B-Q-117 | <i>Grommets/no grommets:</i> | 24"D worksurfaces are used interchangeably as shallow main surfaces, extensions or credenza tops. They can be supported at each end by 24" end support bracket, 24" cantilever bracket, 24"W end panel, 18"D pedestal or end panel in conjunction with desk support. |
| MU1 Worksurface, 1 1/4" thick | A- Worksurfaces include 3" grommet in each back corner leading into desk support or wire manager. | |
| S Straight worksurface | B- Worksurface does not include grommets. | Suspended pedestals may not be used with 1 1/4" worksurfaces |
| 102 Width | Specify surface finish. | |
| 24 Depth | 1 1/4" worksurfaces are 3-ply, solid core construction with threaded metal inserts at all end panel, desk support and bracket locations and pilot holes at pedestal locations. | Use 18"D pedestals with 24"D worksurfaces for full wire management capability in desk or panel applications. |
| B No grommets | Worksurfaces with grommets are bored to accept and are shipped with wire manager clips. | |
| Q Standard Special | All worksurfaces are U.L.-listed. | All straight worksurfaces are 3/8" less than nominal depth for rear wire clearance or privacy screens. |
| 117 Surface finish | | Panel-supported 1 1/4" worksurfaces over 48" must be mid-span supported by MB2-C18 bracket, specified separately. |

Morrison Worksurfaces, 1 1/4" 30" D

Standard Specials Systems

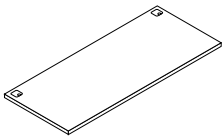
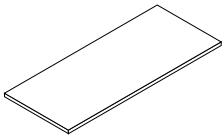
| description | type | w | d | h | pattern no. | lam, | V1 | V2 |
|----------------|---|------|---------|--------|---------------------------|--------|--------|--------|
| Straight, 30"D | Grommets  | 18" | 29 5/8" | 1 1/4" | MU1-S1830-A-Q-() | \$414. | \$614. | \$885. |
| | | 24" | 29 5/8" | 1 1/4" | MU1-S2430-A-Q-() | 414. | 614. | 885. |
| | | 102" | 29 5/8" | 1 1/4" | MU1-S10230-A-Q-() | 1,075. | 1,580. | 2,326. |
| | | 108" | 29 5/8" | 1 1/4" | MU1-S10830-A-Q-() | 1,158. | 1,698. | 2,499. |
| | | 114" | 29 5/8" | 1 1/4" | MU1-S11430-A-Q-() | 1,240. | 1,816. | 2,673. |
| | | 120" | 29 5/8" | 1 1/4" | MU1-S12030-A-Q-() | 1,323. | 1,934. | 2,846. |
| No Grommets |  | 18" | 29 5/8" | 1 1/4" | MU1-S1830-B-Q-() | 336. | 536. | 807. |
| | | 24" | 29 5/8" | 1 1/4" | MU1-S2430-B-Q-() | 336. | 536. | 807. |
| | | 102" | 29 5/8" | 1 1/4" | MU1-S10230-B-Q-() | 994. | 1,500. | 2,247. |
| | | 108" | 29 5/8" | 1 1/4" | MU1-S10830-B-Q-() | 1,076. | 1,618. | 2,420. |
| | | 114" | 29 5/8" | 1 1/4" | MU1-S11430-B-Q-() | 1,159. | 1,736. | 2,594. |
| | | 120" | 29 5/8" | 1 1/4" | MU1-S12030-B-Q-() | 1,241. | 1,854. | 2,767. |

Order Code

| | |
|------------|---------------------------|
| Example: | MU1-S2430B-Q-117 |
| MU1 | Worksurface, 1 1/4" thick |
| S | Straight worksurface |
| 24 | Width |
| 30 | Depth |
| B | No grommets |
| Q | Standard Specials |
| 117 | Surface finish |

Specification Information

Grommets/no grommets:

- A- worksurface includes 3" grommet in each back corner leading into desk support or wire manager clips.
 - B- worksurface does not include grommets
- Specify surface finish.

1 1/4" worksurfaces are 3-ply, solid core construction with threaded metal inserts at all end panel, desk support and bracket locations and pilot holes at pedestal locations.

All worksurfaces are U.L.-listed. Plastic laminate worksurfaces are post-formed top and bottom, front and back.

Application Notes

30"D worksurfaces are used interchangeably in desk and panel system applications as main surfaces, extensions or credenza tops. They can be supported at each end by 30" end support bracket, 30" cantilever bracket, 30" flat bracket, 30"W end panel, 24"D pedestal or end panel in conjunction with desk support, or 30"D pedestal.

All straight worksurfaces are 3/8" less than nominal depth for rear wire clearance or privacy screens.

Panel-supported 1 1/4" worksurfaces over 48" must be mid-span supported by MB2-C18 bracket, specified separately.

Worksurfaces with grommets are bored to accept and are shipped with wire manager clips.

Suspended pedestals may not be used with 1 1/4" worksurfaces.

Morrison Worksurfaces, 1 1/4" 36" D

Standard Specials Systems

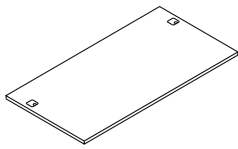
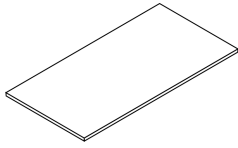
| description | type | w | d | h | pattern no. | lam. | V1 | V2 |
|----------------|---|-------------|---|--------|---------------------------|--------|--------------------------|----------|
| Straight, 36"D |  | 36" | 35 5/8" | 1 1/4" | MU1-S3636-R-Q-() | \$568. | \$792. | \$1,185. |
| | | 42" | 35 5/8" | 1 1/4" | MU1-S4236-R-Q-() | 607. | 847. | 1,258. |
| | | 48" | 35 5/8" | 1 1/4" | MU1-S4836-R-Q-() | 641. | 900. | 1,335. |
| | | 54" | 35 5/8" | 1 1/4" | MU1-S5436-R-Q-() | 677. | 974. | 1,428. |
| | | 60" | 35 5/8" | 1 1/4" | MU1-S6036-R-Q-() | 714. | 1,034. | 1,520. |
| | | 66" | 35 5/8" | 1 1/4" | MU1-S6636-R-Q-() | 750. | 1,088. | 1,633. |
| | | 72" | 35 5/8" | 1 1/4" | MU1-S7236-R-Q-() | 824. | 1,181. | 1,745. |
| | | 78" | 35 5/8" | 1 1/4" | MU1-S7836-R-Q-() | 884. | 1,272. | 1,905. |
| | | 84" | 35 5/8" | 1 1/4" | MU1-S8436-R-Q-() | 946. | 1,363. | 2,043. |
| | | 90" | 35 5/8" | 1 1/4" | MU1-S9036-R-Q-() | 996. | 1,442. | 2,163. |
| | | 96" | 35 5/8" | 1 1/4" | MU1-S9636-R-Q-() | 1,075. | 1,560. | 2,336. |
| | | 102" | 35 5/8" | 1 1/4" | MU1-S10236-R-Q-() | 1,158. | 1,678. | 2,510. |
| | | 108" | 35 5/8" | 1 1/4" | MU1-S10836-R-Q-() | 1,240. | 1,796. | 2,683. |
| | | 114" | 35 5/8" | 1 1/4" | MU1-S11436-R-Q-() | 1,323. | 1,914. | 2,857. |
| | | 120" | 35 5/8" | 1 1/4" | MU1-S12036-R-Q-() | 1,405. | 2,032. | 3,030. |
| | | No Grommets |  | 36" | 35 5/8" | 1 1/4" | MU1-S3636-B-Q-() | 487. |
| 42" | 35 5/8" | | | 1 1/4" | MU1-S4236-B-Q-() | 526. | 767. | 1,180. |
| 48" | 35 5/8" | | | 1 1/4" | MU1-S4836-B-Q-() | 562. | 824. | 1,256. |
| 54" | 35 5/8" | | | 1 1/4" | MU1-S5436-B-Q-() | 597. | 896. | 1,350. |
| 60" | 35 5/8" | | | 1 1/4" | MU1-S6036-B-Q-() | 635. | 956. | 1,443. |
| 66" | 35 5/8" | | | 1 1/4" | MU1-S6636-B-Q-() | 671. | 1,005. | 1,554. |
| 72" | 35 5/8" | | | 1 1/4" | MU1-S7236-B-Q-() | 743. | 1,102. | 1,666. |
| 78" | 35 5/8" | | | 1 1/4" | MU1-S7836-B-Q-() | 801. | 1,192. | 1,823. |
| 84" | 35 5/8" | | | 1 1/4" | MU1-S8436-B-Q-() | 864. | 1,283. | 1,959. |
| 90" | 35 5/8" | | | 1 1/4" | MU1-S9036-B-Q-() | 918. | 1,365. | 2,084. |
| 96" | 35 5/8" | | | 1 1/4" | MU1-S9636-B-Q-() | 994. | 1,480. | 2,257. |
| 102" | 35 5/8" | | | 1 1/4" | MU1-S10236-B-Q-() | 1,076. | 1,598. | 2,431. |
| 108" | 35 5/8" | | | 1 1/4" | MU1-S10836-B-Q-() | 1,159. | 1,716. | 2,604. |
| 114" | 35 5/8" | | | 1 1/4" | MU1-S11436-B-Q-() | 1,241. | 1,834. | 2,778. |
| 120" | 35 5/8" | | | 1 1/4" | MU1-S12036-B-Q-() | 1,324. | 1,952. | 2,951. |

Morrison System

Order Code

| | |
|------------|---------------------------|
| Example: | MU1-S3636B-Q-117 |
| MU1 | Worksurface, 1 1/4" thick |
| S | Straight worksurface |
| 36 | Width |
| 36 | Depth |
| B | No grommets |
| Q | Standard Specials |
| 117 | Surface finish |

Specification Information

Grommets/no grommets:

- A- worksurface includes 3" grommet in each back corner leading into desk support or wire manager clips.
 - B- worksurface does not include grommets
- Specify surface finish.

1 1/4" worksurfaces are 3-ply, solid core construction with threaded metal inserts at all end panel, desk support and bracket locations and pilot holes at pedestal locations.

All worksurfaces are U.L.-listed. Plastic laminate worksurfaces are post-formed top and bottom, front and back.

Application Notes

36"D worksurfaces are used interchangeably in desk and panel system applications as main surfaces, extensions or credenza tops. They can be supported at each end by 30" end support bracket, 30" cantilever bracket, 36" flat bracket, 30"W end panel, 24"D pedestal or end panel in conjunction with desk support, or 30"D pedestal.

All straight worksurfaces are 3/8" less than nominal depth for rear wire clearance or privacy screens.

Panel-supported 1 1/4" worksurfaces over 48" must be mid-span supported by MB2-C18 bracket, specified separately.

Worksurfaces with grommets are bored to accept and are shipped with wire manager clips.

Suspended pedestals may not be used with 1 1/4" worksurfaces.

Morrison Worksurfaces, 1 1/4" 18" D + Post

Standard Specials Systems

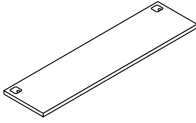
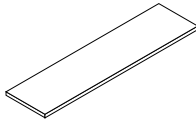
| description | type | w | d | h | pattern no. | lam. | V1 | V2 |
|--|---|--------|--------------------------|--------|--------------------------|--------|--------|--------|
| Straight, 18"D + Post | Grommets  | 20" | 17 5/8" | 1 1/4" | MU1-S2018-A-Q-() | \$350. | \$511. | \$704. |
| | | 26" | 17 5/8" | 1 1/4" | MU1-S2618-A-Q-() | 381. | 546. | 759. |
| | | 32" | 17 5/8" | 1 1/4" | MU1-S3218-A-Q-() | 413. | 582. | 813. |
| | | 38" | 17 5/8" | 1 1/4" | MU1-S3818-A-Q-() | 430. | 623. | 887. |
| | | 44" | 17 5/8" | 1 1/4" | MU1-S4418-A-Q-() | 487. | 677. | 964. |
| | | 50" | 17 5/8" | 1 1/4" | MU1-S5018-A-Q-() | 505. | 714. | 1,021. |
| | | 56" | 17 5/8" | 1 1/4" | MU1-S5618-A-Q-() | 526. | 752. | 1,099. |
| | | 62" | 17 5/8" | 1 1/4" | MU1-S6218-A-Q-() | 562. | 827. | 1,207. |
| | | 68" | 17 5/8" | 1 1/4" | MU1-S6818-A-Q-() | 617. | 917. | 1,324. |
| | | 74" | 17 5/8" | 1 1/4" | MU1-S7418-A-Q-() | 676. | 1,007. | 1,442. |
| | | 80" | 17 5/8" | 1 1/4" | MU1-S8018-A-Q-() | 735. | 1,096. | 1,560. |
| | | 86" | 17 5/8" | 1 1/4" | MU1-S8618-A-Q-() | 794. | 1,186. | 1,678. |
| | | 92" | 17 5/8" | 1 1/4" | MU1-S9218-A-Q-() | 853. | 1,276. | 1,796. |
| | | 98" | 17 5/8" | 1 1/4" | MU1-S9818-A-Q-() | 912. | 1,365. | 1,914. |
| | | 104" | 17 5/8" | 1 1/4" | MU1-S10418-A-Q-() | 971. | 1,455. | 2,032. |
| | | 110" | 17 5/8" | 1 1/4" | MU1-S11018-A-Q-() | 1,030. | 1,545. | 2,150. |
| 116" | 17 5/8" | 1 1/4" | MU1-S11618-A-Q-() | 1,089. | 1,634. | 2,268. | | |
| No Grommets  | No Grommets | 20" | 17 5/8" | 1 1/4" | MU1-S2018-B-Q-() | 267. | 428. | 622. |
| | | 26" | 17 5/8" | 1 1/4" | MU1-S2618-B-Q-() | 299. | 464. | 676. |
| | | 32" | 17 5/8" | 1 1/4" | MU1-S3218-B-Q-() | 330. | 499. | 730. |
| | | 38" | 17 5/8" | 1 1/4" | MU1-S3818-B-Q-() | 347. | 540. | 805. |
| | | 44" | 17 5/8" | 1 1/4" | MU1-S4418-B-Q-() | 405. | 595. | 881. |
| | | 50" | 17 5/8" | 1 1/4" | MU1-S5018-B-Q-() | 422. | 631. | 938. |
| | | 56" | 17 5/8" | 1 1/4" | MU1-S5618-B-Q-() | 444. | 669. | 1,016. |
| | | 62" | 17 5/8" | 1 1/4" | MU1-S6218-B-Q-() | 479. | 745. | 1,125. |
| | | 68" | 17 5/8" | 1 1/4" | MU1-S6818-B-Q-() | 594. | 834. | 1,241. |
| | | 74" | 17 5/8" | 1 1/4" | MU1-S7418-B-Q-() | 653. | 924. | 1,359. |
| | | 80" | 17 5/8" | 1 1/4" | MU1-S8018-B-Q-() | 712. | 1,014. | 1,477. |
| | | 86" | 17 5/8" | 1 1/4" | MU1-S8618-B-Q-() | 771. | 1,103. | 1,595. |
| | | 92" | 17 5/8" | 1 1/4" | MU1-S9218-B-Q-() | 830. | 1,193. | 1,713. |
| | | 98" | 17 5/8" | 1 1/4" | MU1-S9818-B-Q-() | 889. | 1,283. | 1,831. |
| | | 104" | 17 5/8" | 1 1/4" | MU1-S10418-B-Q-() | 948. | 1,372. | 1,949. |
| | | 110" | 17 5/8" | 1 1/4" | MU1-S11018-B-Q-() | 1,007. | 1,462. | 2,067. |
| 116" | 17 5/8" | 1 1/4" | MU1-S11618-B-Q-() | 1,066. | 1,552. | 2,185. | | |

Order Code

| | |
|------------|--------------------------|
| Example: | MU1-S4418-B-Q-117 |
| MU1 | Worksurface 1 1/4" thick |
| S | Worksurface type |
| 44 | Width |
| 18 | Depth |
| B | No grommets |
| Q | Standard Specials |
| 117 | Surface finish |

Specification Information

B: Worksurface does not include grommets.

Specify surface finish.

1 1/4" worksurfaces are 3-ply, solid core construction with threaded metal inserts at all end panel, desk support and bracket locations and pilot holes at pedestal locations.

All worksurfaces are U.L.-listed.

Application Notes

18"D worksurfaces are used interchangeably in desk and panel system applications as shallow main surfaces, extensions, or credenza tops. They may be supported at each end by an 18" end support bracket, 18" cantilever bracket, 18"W conference end panel, 18"D pedestal, or 12"W end panel (MN2-E12) in conjunction with a desk support.

18"D worksurfaces with desk supports do not accept pedestals.

All worksurfaces are 3/8" less than nominal depth for rear wire clearance or privacy screens.

Panel-supported 1 1/4" worksurfaces over 48" must be mid-span supported by MB2-C18 bracket, specified separately.

Suspended pedestals may not be used with 1 1/4" worksurfaces

Morrison Worksurfaces, 1 1/4" 24" D + Post

Standard Specials Systems

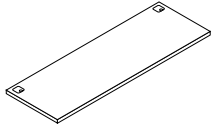
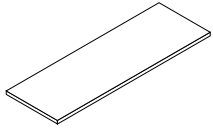
| description | type | w | d | h | pattern no. | lam. | V1 | V2 |
|-----------------------|---|--------|---------------------------|--------|---------------------------|--------|--------|--------|
| Straight, 24"D + Post |  | 20" | 23 5/8" | 1 1/4" | MU1-S2024-A-Q-() | \$376. | \$602. | \$830. |
| | | 26" | 23 5/8" | 1 1/4" | MU1-S2624-A-Q-() | 409. | 620. | 867. |
| | | 32" | 23 5/8" | 1 1/4" | MU1-S3224-A-Q-() | 428. | 636. | 886. |
| | | 38" | 23 5/8" | 1 1/4" | MU1-S3824-A-Q-() | 485. | 675. | 959. |
| | | 44" | 23 5/8" | 1 1/4" | MU1-S4424-A-Q-() | 502. | 729. | 1,074. |
| | | 50" | 23 5/8" | 1 1/4" | MU1-S5024-A-Q-() | 543. | 802. | 1,151. |
| | | 56" | 23 5/8" | 1 1/4" | MU1-S5624-A-Q-() | 578. | 840. | 1,205. |
| | | 62" | 23 5/8" | 1 1/4" | MU1-S6224-A-Q-() | 631. | 936. | 1,336. |
| | | 68" | 23 5/8" | 1 1/4" | MU1-S6824-A-Q-() | 689. | 1,009. | 1,470. |
| | | 74" | 23 5/8" | 1 1/4" | MU1-S7424-A-Q-() | 747. | 1,095. | 1,569. |
| | | 80" | 23 5/8" | 1 1/4" | MU1-S8024-A-Q-() | 799. | 1,174. | 1,686. |
| | | 86" | 23 5/8" | 1 1/4" | MU1-S8624-A-Q-() | 847. | 1,250. | 1,797. |
| | | 92" | 23 5/8" | 1 1/4" | MU1-S9224-A-Q-() | 925. | 1,365. | 1,968. |
| | | 98" | 23 5/8" | 1 1/4" | MU1-S9824-A-Q-() | 1,002. | 1,483. | 2,139. |
| | | 104" | 23 5/8" | 1 1/4" | MU1-S10424-A-Q-() | 1,079. | 1,601. | 2,310. |
| | | 110" | 23 5/8" | 1 1/4" | MU1-S11024-A-Q-() | 1,155. | 1,719. | 2,482. |
| 116" | 23 5/8" | 1 1/4" | MU1-S11624-A-Q-() | 1,232. | 1,837. | 2,653. | | |
| No Grommets |  | 20" | 23 5/8" | 1 1/4" | MU1-S2024-B-Q-() | 299. | 523. | 752. |
| | | 26" | 23 5/8" | 1 1/4" | MU1-S2624-B-Q-() | 330. | 540. | 789. |
| | | 32" | 23 5/8" | 1 1/4" | MU1-S3224-B-Q-() | 347. | 559. | 805. |
| | | 38" | 23 5/8" | 1 1/4" | MU1-S3824-B-Q-() | 405. | 595. | 881. |
| | | 44" | 23 5/8" | 1 1/4" | MU1-S4424-B-Q-() | 422. | 650. | 996. |
| | | 50" | 23 5/8" | 1 1/4" | MU1-S5024-B-Q-() | 461. | 726. | 1,071. |
| | | 56" | 23 5/8" | 1 1/4" | MU1-S5624-B-Q-() | 498. | 762. | 1,125. |
| | | 62" | 23 5/8" | 1 1/4" | MU1-S6224-B-Q-() | 552. | 858. | 1,259. |
| | | 68" | 23 5/8" | 1 1/4" | MU1-S6824-B-Q-() | 609. | 931. | 1,390. |
| | | 74" | 23 5/8" | 1 1/4" | MU1-S7424-B-Q-() | 663. | 1,016. | 1,489. |
| | | 80" | 23 5/8" | 1 1/4" | MU1-S8024-B-Q-() | 716. | 1,094. | 1,608. |
| | | 86" | 23 5/8" | 1 1/4" | MU1-S8624-B-Q-() | 768. | 1,171. | 1,719. |
| | | 92" | 23 5/8" | 1 1/4" | MU1-S9224-B-Q-() | 843. | 1,284. | 1,889. |
| | | 98" | 23 5/8" | 1 1/4" | MU1-S9824-B-Q-() | 919. | 1,402. | 2,060. |
| | | 104" | 23 5/8" | 1 1/4" | MU1-S10424-B-Q-() | 996. | 1,520. | 2,231. |
| | | 110" | 23 5/8" | 1 1/4" | MU1-S11024-B-Q-() | 1,073. | 1,638. | 2,402. |
| 116" | 23 5/8" | 1 1/4" | MU1-S11624-B-Q-() | 1,149. | 1,756. | 2,574. | | |

Morrison System

| Order Code | Specification Information | Application Notes |
|--------------------------------------|--|--|
| Example: MU1-S3824-B-Q-117 | <i>Grommets/no grommets:</i> | 24"D worksurfaces are used interchangeably as shallow main surfaces, extensions or credenza tops. They can be supported at each end by 24" end support bracket, 24" cantilever bracket, 24"W end panel, 18"D pedestal or end panel in conjunction with desk support. |
| MU1 Worksurface, 1 1/4" thick | A- Worksurfaces include 3" grommet in each back corner leading into desk support or wire manager. | |
| S Straight worksurface | B- Worksurface does not include grommets. | Suspended pedestals may not be used with 1 1/4" worksurfaces. |
| 38 Width | Specify surface finish. | |
| 24 Depth | 1 1/4" worksurfaces are 3-ply, solid core construction with threaded metal inserts at all end panel, desk support and bracket locations and pilot holes at pedestal locations. | Use 18"D pedestals with 24"D worksurfaces for full wire management capability in desk or panel applications. |
| B No grommets | Worksurfaces with grommets are bored to accept and are shipped with wire manager clips. | |
| Q Standard Specials | All worksurfaces are U.L.-listed. | All straight worksurfaces are 3/8" less than nominal depth for rear wire clearance or privacy screens. |
| 117 Surface finish | | Panel-supported 1 1/4" worksurfaces over 48" must be mid-span supported by MB2-C18 bracket, specified separately. |

Morrison Worksurfaces, 1 1/4" 30" D + Post

Standard Specials Systems

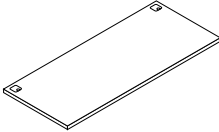
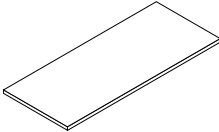
| description | type | w | d | h | pattern no. | lam. | V1 | V2 |
|-----------------------|---|------|---------|--------|---------------------------|--------|--------|--------|
| Straight, 30"D + Post |  | 20" | 29 5/8" | 1 1/4" | MU1-S2030-A-Q-() | \$414. | \$614. | \$885. |
| | | 26" | 29 5/8" | 1 1/4" | MU1-S2630-A-Q-() | 450. | 654. | 943. |
| | | 32" | 29 5/8" | 1 1/4" | MU1-S3230-A-Q-() | 485. | 694. | 1,001. |
| | | 38" | 29 5/8" | 1 1/4" | MU1-S3830-A-Q-() | 524. | 749. | 1,074. |
| | | 44" | 29 5/8" | 1 1/4" | MU1-S4430-A-Q-() | 558. | 802. | 1,151. |
| | | 50" | 29 5/8" | 1 1/4" | MU1-S5030-A-Q-() | 595. | 876. | 1,244. |
| | | 56" | 29 5/8" | 1 1/4" | MU1-S5630-A-Q-() | 631. | 936. | 1,336. |
| | | 62" | 29 5/8" | 1 1/4" | MU1-S6230-A-Q-() | 668. | 990. | 1,449. |
| | | 68" | 29 5/8" | 1 1/4" | MU1-S6830-A-Q-() | 741. | 1,083. | 1,561. |
| | | 74" | 29 5/8" | 1 1/4" | MU1-S7430-A-Q-() | 801. | 1,174. | 1,720. |
| | | 80" | 29 5/8" | 1 1/4" | MU1-S8030-A-Q-() | 864. | 1,265. | 1,859. |
| | | 86" | 29 5/8" | 1 1/4" | MU1-S8630-A-Q-() | 913. | 1,344. | 1,979. |
| | | 92" | 29 5/8" | 1 1/4" | MU1-S9230-A-Q-() | 992. | 1,462. | 2,152. |
| | | 98" | 29 5/8" | 1 1/4" | MU1-S9830-A-Q-() | 1,075. | 1,580. | 2,326. |
| | | 104" | 29 5/8" | 1 1/4" | MU1-S10430-A-Q-() | 1,158. | 1,698. | 2,499. |
| | | 110" | 29 5/8" | 1 1/4" | MU1-S11030-A-Q-() | 1,240. | 1,816. | 2,673. |
| | | 116" | 29 5/8" | 1 1/4" | MU1-S11630-A-Q-() | 1,323. | 1,934. | 2,846. |
| No Grommets |  | 20" | 29 5/8" | 1 1/4" | MU1-S2030-B-Q-() | 336. | 536. | 807. |
| | | 26" | 29 5/8" | 1 1/4" | MU1-S2630-B-Q-() | 371. | 575. | 865. |
| | | 32" | 29 5/8" | 1 1/4" | MU1-S3230-B-Q-() | 405. | 614. | 923. |
| | | 38" | 29 5/8" | 1 1/4" | MU1-S3830-B-Q-() | 444. | 669. | 996. |
| | | 44" | 29 5/8" | 1 1/4" | MU1-S4430-B-Q-() | 479. | 726. | 1,071. |
| | | 50" | 29 5/8" | 1 1/4" | MU1-S5030-B-Q-() | 514. | 798. | 1,166. |
| | | 56" | 29 5/8" | 1 1/4" | MU1-S5630-B-Q-() | 552. | 858. | 1,259. |
| | | 62" | 29 5/8" | 1 1/4" | MU1-S6230-B-Q-() | 589. | 907. | 1,370. |
| | | 68" | 29 5/8" | 1 1/4" | MU1-S6830-B-Q-() | 661. | 1,004. | 1,482. |
| | | 74" | 29 5/8" | 1 1/4" | MU1-S7430-B-Q-() | 719. | 1,094. | 1,639. |
| | | 80" | 29 5/8" | 1 1/4" | MU1-S8030-B-Q-() | 781. | 1,185. | 1,775. |
| | | 86" | 29 5/8" | 1 1/4" | MU1-S8630-B-Q-() | 835. | 1,267. | 1,900. |
| | | 92" | 29 5/8" | 1 1/4" | MU1-S9230-B-Q-() | 911. | 1,382. | 2,073. |
| | | 98" | 29 5/8" | 1 1/4" | MU1-S9830-B-Q-() | 994. | 1,500. | 2,247. |
| | | 104" | 29 5/8" | 1 1/4" | MU1-S10430-B-Q-() | 1,076. | 1,618. | 2,420. |
| | | 110" | 29 5/8" | 1 1/4" | MU1-S11030-B-Q-() | 1,159. | 1,736. | 2,594. |
| | | 116" | 29 5/8" | 1 1/4" | MU1-S11630-B-Q-() | 1,241. | 1,854. | 2,767. |

Order Code

| | |
|------------|---------------------------|
| Example: | MU1-S3830B-Q-117 |
| MU1 | Worksurface, 1 1/4" thick |
| S | Straight worksurface |
| 38 | Width |
| 30 | Depth |
| B | No grommets |
| Q | Standard Specials |
| 117 | Surface finish |

Specification Information

Grommets/no grommets:
 A- worksurface includes 3" grommet in each back corner leading into desk support or wire manager clips.
 B- worksurface does not include grommets
 Specify surface finish.

1 1/4" worksurfaces are 3-ply, solid core construction with threaded metal inserts at all end panel, desk support and bracket locations and pilot holes at pedestal locations.

All worksurfaces are U.L.-listed.

Plastic laminate worksurfaces are post-formed top and bottom, front and back.

Application Notes

30"D worksurfaces are used interchangeably in desk and panel system applications as main surfaces, extensions or credenza tops. They can be supported at each end by 30" end support bracket, 30" cantilever bracket, 30" flat bracket, 30"W end panel, 24"D pedestal or end panel in conjunction with desk support, or 30"D pedestal.

All straight worksurfaces are 3/8" less than nominal depth for rear wire clearance or privacy screens.

Panel-supported 1 1/4" worksurfaces over 48" must be mid-span supported by MB2-C18 bracket, specified separately.

Worksurfaces with grommets are bored to accept and are shipped with wire manager clips.

Suspended pedestals may not be used with 1 1/4" worksurfaces.

Morrison Worksurfaces, 1 1/4"

36" D + Post

Standard Specials Systems

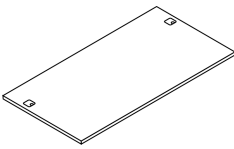
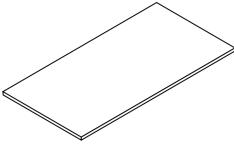
| description | type | w | d | h | pattern no. | lam. | V1 | V2 |
|-----------------------|---|------|---------|--------|---------------------------|--------|--------|----------|
| Straight, 36"D + Post |  | 38" | 35 5/8" | 1 1/4" | MU1-S3836-R-Q-() | \$607. | \$847. | \$1,258. |
| | | 44" | 35 5/8" | 1 1/4" | MU1-S4436-R-Q-() | 641. | 900. | 1,335. |
| | | 50" | 35 5/8" | 1 1/4" | MU1-S5036-R-Q-() | 677. | 974. | 1,428. |
| | | 56" | 35 5/8" | 1 1/4" | MU1-S5636-R-Q-() | 714. | 1,034. | 1,520. |
| | | 62" | 35 5/8" | 1 1/4" | MU1-S6236-R-Q-() | 750. | 1,088. | 1,633. |
| | | 68" | 35 5/8" | 1 1/4" | MU1-S6836-R-Q-() | 824. | 1,181. | 1,745. |
| | | 74" | 35 5/8" | 1 1/4" | MU1-S7436-R-Q-() | 884. | 1,272. | 1,905. |
| | | 80" | 35 5/8" | 1 1/4" | MU1-S8036-R-Q-() | 946. | 1,363. | 2,043. |
| | | 86" | 35 5/8" | 1 1/4" | MU1-S8636-R-Q-() | 996. | 1,442. | 2,163. |
| | | 92" | 35 5/8" | 1 1/4" | MU1-S9236-R-Q-() | 1,075. | 1,560. | 2,336. |
| | | 98" | 35 5/8" | 1 1/4" | MU1-S9836-R-Q-() | 1,158. | 1,678. | 2,510. |
| | | 104" | 35 5/8" | 1 1/4" | MU1-S10436-R-Q-() | 1,240. | 1,796. | 2,683. |
| | | 110" | 35 5/8" | 1 1/4" | MU1-S11036-R-Q-() | 1,323. | 1,914. | 2,857. |
| | | 116" | 35 5/8" | 1 1/4" | MU1-S11636-R-Q-() | 1,405. | 2,032. | 3,030. |
| No Grommets |  | 38" | 35 5/8" | 1 1/4" | MU1-S3836-B-Q-() | 526. | 767. | 1,180. |
| | | 44" | 35 5/8" | 1 1/4" | MU1-S4436-B-Q-() | 562. | 824. | 1,256. |
| | | 50" | 35 5/8" | 1 1/4" | MU1-S5036-B-Q-() | 597. | 896. | 1,350. |
| | | 56" | 35 5/8" | 1 1/4" | MU1-S5636-B-Q-() | 635. | 956. | 1,443. |
| | | 62" | 35 5/8" | 1 1/4" | MU1-S6236-B-Q-() | 671. | 1,005. | 1,554. |
| | | 68" | 35 5/8" | 1 1/4" | MU1-S6836-B-Q-() | 743. | 1,102. | 1,666. |
| | | 74" | 35 5/8" | 1 1/4" | MU1-S7436-B-Q-() | 801. | 1,192. | 1,823. |
| | | 80" | 35 5/8" | 1 1/4" | MU1-S8036-B-Q-() | 864. | 1,283. | 1,959. |
| | | 86" | 35 5/8" | 1 1/4" | MU1-S8636-B-Q-() | 918. | 1,365. | 2,084. |
| | | 92" | 35 5/8" | 1 1/4" | MU1-S9236-B-Q-() | 994. | 1,480. | 2,257. |
| | | 98" | 35 5/8" | 1 1/4" | MU1-S9836-B-Q-() | 1,076. | 1,598. | 2,431. |
| | | 104" | 35 5/8" | 1 1/4" | MU1-S10436-B-Q-() | 1,159. | 1,716. | 2,604. |
| | | 110" | 35 5/8" | 1 1/4" | MU1-S11036-B-Q-() | 1,241. | 1,834. | 2,778. |
| | | 116" | 35 5/8" | 1 1/4" | MU1-S11636-B-Q-() | 1,324. | 1,952. | 2,951. |

Morrison System

Order Code

| | |
|------------|---------------------------|
| Example: | MU1-S3836B-Q-117 |
| MU1 | Worksurface, 1 1/4" thick |
| S | Straight worksurface |
| 38 | Width |
| 36 | Depth |
| B | No grommets |
| Q | Standard Specials |
| 117 | Surface finish |

Specification Information

Grommets/no grommets:

A- worksurface includes 3" grommet in each back corner leading into desk support or wire manager clips.

B- worksurface does not include grommets

Specify surface finish.

1 1/4" worksurfaces are 3-ply, solid core construction with threaded metal inserts at all end panel, desk support and bracket locations and pilot holes at pedestal locations.

All worksurfaces are U.L.-listed.

Plastic laminate worksurfaces are post-formed top and bottom, front and back.

Application Notes

30"D worksurfaces are used interchangeably in desk and panel system applications as main surfaces, extensions or credenza tops. They can be supported at each end by 30" end support bracket, 30" cantilever bracket, 30" flat bracket, 30"W end panel, 24"D pedestal or end panel in conjunction with desk support, or 30"D pedestal.

All straight worksurfaces are 3/8" less than nominal depth for rear wire clearance or privacy screens.

Panel-supported 1 1/4" worksurfaces over 48" must be mid-span supported by MB2-C18 bracket, specified separately.

Worksurfaces with grommets are bored to accept and are shipped with wire manager clips.

Suspended pedestals may not be used with 1 1/4" worksurfaces.

Morrison Worksurfaces, 1 1/4"

rounded end worksurfaces 30" D + 36" D

Standard Specials Systems

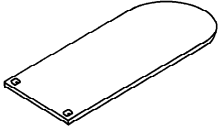
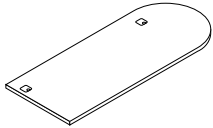
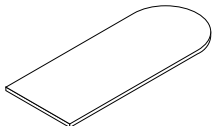
| description | type | w | d | h | pattern no. | lam. | V1 | V2 |
|-------------------|---|-----|-----|--------|--------------------------------|----------|----------|----------|
| Rounded end | End Grommets  | 66" | 36" | 1 1/4" | MU1-R6636-E-Q-() | \$1,317. | \$1,801. | \$2,584. |
| | | 78" | 36" | 1 1/4" | MU1-R7836-E-Q-() | 1,376. | 1,860. | 2,643. |
| | | 87" | 30" | 1 1/4" | MU1-R8730-E-Q-() | 1,352. | 1,836. | 2,620. |
| | | 90" | 36" | 1 1/4" | MU1-R9036-E-Q-() | 1,494. | 1,978. | 2,761. |
| Recessed Grommets |  | 66" | 36" | 1 1/4" | MU1-R6636-R-Q-() (L/R) | 1,317. | 1,801. | 2,584. |
| | | 78" | 36" | 1 1/4" | MU1-R7836-R-Q-() (L/R) | 1,376. | 1,860. | 2,643. |
| | | 87" | 30" | 1 1/4" | MU1-R8730-R-Q-() (L/R) | 1,352. | 1,836. | 2,620. |
| | | 90" | 36" | 1 1/4" | MU1-R9036-R-Q-() (L/R) | 1,494. | 1,978. | 2,761. |
| No Grommets |  | 66" | 36" | 1 1/4" | MU1-R6636-B-Q-() (L/R) | 1,235. | 1,717. | 2,503. |
| | | 78" | 36" | 1 1/4" | MU1-R7836-B-Q-() (L/R) | 1,294. | 1,776. | 2,562. |
| | | 87" | 30" | 1 1/4" | MU1-R8730-B-Q-() (L/R) | 1,271. | 1,752. | 2,538. |
| | | 90" | 36" | 1 1/4" | MU1-R9036-B-Q-() (L/R) | 1,412. | 1,894. | 2,680. |

Order Code

| | |
|------------|---------------------------|
| Example: | MU1-R6636E-Q-117 |
| MU1 | Worksurface, 1 1/4" thick |
| R | Rounded end |
| 66 | Width |
| 36 | Depth |
| E | End grommets |
| Q | Standard Specials |
| 117 | Surface finish |

Specification Information

| | |
|------------------------------|--|
| <i>Grommets/no grommets:</i> | |
| E- | rounded end worksurface includes 3" grommet in each straight end corner. |
| R- | rounded end worksurface includes 3" grommets recessed for use with 6" recessed desk support. |
| B- | rounded end worksurface does not include grommets |

Specify surface finish.
Rounded end worksurfaces with recessed or no grommets are specified left or right to determine position of grommets and pedestal drilling. Rounded end when seated at desk defines L/R hand (Right hand shown above).

1 1/4" worksurfaces are 3-ply, solid core construction with threaded metal inserts at all end panel, desk support and bracket locations and pilot holes at pedestal locations.

MU1- worksurfaces are supported by brackets with machine screws.

All worksurfaces are U.L.-listed.

End grommets have inserts to accept desk support at straight end and no pedestal inserts. Plastic laminate worksurfaces have radiused T mold edge and a flat self-edge in the straight edge.

Application Notes

Rounded end worksurfaces are used interchangeably in desk and panel system applications as main surfaces or extensions. They may be supported by 30" end support brackets, 30" cantilever bracket, 30" flat bracket or 30" conference end panel, and by a support column at the rounded end.

Use 18"D pedestal or end panel with desk support under rounded end worksurfaces with recessed grommets. Use 48"D desk support with 63" rounded end and 60"W desk support with 75" rounded end.

Worksurfaces with end grommets may not be supported by conference end panel.

Suspended pedestals may not be used with 1 1/4" worksurfaces.

Rounded end worksurfaces have threaded metal inserts for desk support, end panel each end, and at all bracket locations. End grommet worksurfaces have no pedestal inserts.

Morrison Worksurfaces, 1 1/4"
P-shape curvilinear

Standard Specials Systems

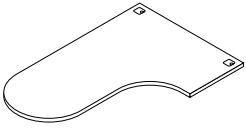
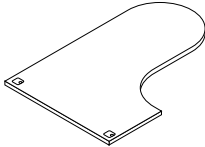
| description | type | w | d | h | pattern no. | lam. | V1 | V2 |
|---|--------------|-----|-----|--------|--------------------------|----------|----------|----------|
|  | 24" D return | 48" | 66" | 1 1/4" | MU1-P66SA-L-Q-() | \$2,079. | \$2,669. | \$3,741. |
| | 24" D return | 48" | 78" | 1 1/4" | MU1-P78SA-L-Q-() | 2,138. | 2,746. | 3,848. |
| | 30" D return | 48" | 66" | 1 1/4" | MU1-P66DA-L-Q-() | 2,106. | 2,709. | 3,793. |
| | 30" D return | 48" | 72" | 1 1/4" | MU1-P72DA-L-Q-() | 2,165. | 2,786. | 3,900. |
|  | 24" D return | 48" | 66" | 1 1/4" | MU1-P66SA-R-Q-() | 2,079. | 2,669. | 3,741. |
| | 24" D return | 48" | 78" | 1 1/4" | MU1-P78SA-R-Q-() | 2,138. | 2,746. | 3,848. |
| | 30" D return | 48" | 66" | 1 1/4" | MU1-P66DA-R-Q-() | 2,106. | 2,709. | 3,793. |
| | 30" D return | 48" | 72" | 1 1/4" | MU1-P72DA-R-Q-() | 2,165. | 2,786. | 3,900. |

Morrison System

| Order Code | Specification Information | Application Notes |
|-----------------------------------|--|---|
| Example: MU1-P66SA-L-Q-117 | S- 24"D side edge | P-shape curvilinear worksurfaces may be used interchangeably in desk and panel system applications. They may be supported by a 48" VDT support bracket kit, or 48" desk support and 6" end panel, in conjunction with rounded end support column. Use flat bracket or bridging bracket to join to adjacent 1 1/4" worksurface. P-shape laminate surfaces have continuous T-mold edge in profile to match adjacent 1 1/4" worksurfaces. |
| MU1 Worksurface, 1 1/4" | D- 30"D side edge | |
| P P-shape curvilinear | Specify surface finish. | |
| 66 Overall length | 1 1/4" curvilinear surfaces are solid core construction with threaded metal inserts at desk support and all bracket locations. | |
| S Depth of return | All worksurfaces are U.L.-listed. | |
| A Grommets | All P-shape worksurfaces have 2 grommets at 48" end for use with 48" desk and overhead supports. | |
| L Rounded end left | | |
| Q Standard Special | | |
| 117 Surface finish | | |

Morrison Worksurfaces, 1 1/4"

L-shape curvilinear

Standard Specials Systems

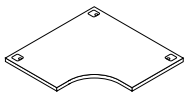
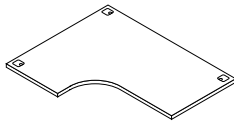
| description | type | w | d | h | pattern no. | lam. | V1 | V2 |
|---|------------|--------|-------------------------|--------|-------------------------|----------|----------|----------|
| 24"D returns left and right  | 3 Grommets | 42" | 48" | 1 1/4" | MU1-C4248SS-Q(-) | \$1,037. | \$1,336. | \$1,866. |
| | | 42" | 60" | 1 1/4" | MU1-C4260SS-Q(-) | 1,179. | 1,515. | 2,122. |
| | | 42" | 66" | 1 1/4" | MU1-C4266SS-Q(-) | 1,266. | 1,628. | 2,283. |
| | | 42" | 72" | 1 1/4" | MU1-C4272SS-Q(-) | 1,352. | 1,742. | 2,444. |
| | | 48" | 42" | 1 1/4" | MU1-C4842SS-Q(-) | 1,037. | 1,336. | 1,866. |
| | | 48" | 66" | 1 1/4" | MU1-C4866SS-Q(-) | 1,352. | 1,742. | 2,444. |
| | | 60" | 42" | 1 1/4" | MU1-C6042SS-Q(-) | 1,179. | 1,515. | 2,122. |
| | | 66" | 42" | 1 1/4" | MU1-C6642SS-Q(-) | 1,266. | 1,628. | 2,283. |
| | | 66" | 48" | 1 1/4" | MU1-C6648SS-Q(-) | 1,352. | 1,742. | 2,444. |
| | | 72" | 42" | 1 1/4" | MU1-C7242SS-Q(-) | 1,352. | 1,742. | 2,444. |
| 24"D return left, 30"D right  | 3 Grommets | 42" | 42" | 1 1/4" | MU1-C4242SD-Q(-) | 966. | 1,246. | 1,738. |
| | | 42" | 48" | 1 1/4" | MU1-C4248SD-Q(-) | 1,037. | 1,336. | 1,866. |
| | | 42" | 60" | 1 1/4" | MU1-C4260SD-Q(-) | 1,179. | 1,515. | 2,122. |
| | | 42" | 66" | 1 1/4" | MU1-C4266SD-Q(-) | 1,266. | 1,628. | 2,283. |
| | | 42" | 72" | 1 1/4" | MU1-C4272SD-Q(-) | 1,352. | 1,742. | 2,444. |
| | | 48" | 42" | 1 1/4" | MU1-C4842SD-Q(-) | 1,037. | 1,336. | 1,866. |
| | | 48" | 66" | 1 1/4" | MU1-C4866SD-Q(-) | 1,352. | 1,742. | 2,444. |
| | | 60" | 42" | 1 1/4" | MU1-C6042SD-Q(-) | 1,179. | 1,515. | 2,122. |
| | | 66" | 42" | 1 1/4" | MU1-C6642SD-Q(-) | 1,266. | 1,628. | 2,283. |
| | | 66" | 48" | 1 1/4" | MU1-C6648SD-Q(-) | 1,352. | 1,742. | 2,444. |
| 72" | 42" | 1 1/4" | MU1-C7242SD-Q(-) | 1,352. | 1,742. | 2,444. | | |

Order Code

| | |
|------------|--------------------------|
| Example: | MU1-C4248SD-Q-117 |
| MU1 | Worksurface, 1 1/4" |
| C | L-shape curvilinear |
| 42 | Width left |
| 48 | Width right |
| S | Depth of left return |
| D | Depth of right return |
| Q | Standard Specials |
| 117 | Surface finish |

Specification Information

Width dimension (W) refers to width of left-side back edge; depth dimension (D) indicates width of right-side back edge.

S- 24"D side edge
D- 30"D side edge

Specify surface finish.

1 1/4" curvilinear surfaces are solid core construction with threaded metal inserts at desk support and all bracket locations.

All worksurfaces are U.L.-listed.

All L-shape curvilinear worksurfaces have three grommets.

Application Notes

L-shape curvilinear worksurfaces may be used interchangeably in desk and panel system applications. They may be supported by corner desk supports or by VDT end support bracket kit. Use cantilever bridging brackets or flat brackets to join to adjacent worksurfaces.

L-shape surfaces may also be supported by MN1- end panel in conjunction with desk support, or cantilever bracket in panel planning.

L-shape surfaces are veneer or post-formed plastic laminate on both back edges, matching profile T-mold on curvilinear front, and self-edge on sides.

Curvilinear worksurfaces are available only in 1 1/4" thickness.

L-shape surfaces are 3/8" less than nominal depth for rear wire clearance or privacy screens.

If specifying privacy screens on both back edges, one or both must be 48" back-of-VDT type.

Morrison Worksurfaces, 1 1/4"

L-shape curvilinear

Standard Specials Systems

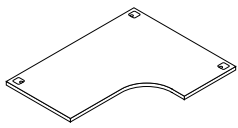
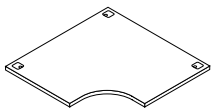
| description | type | w | d | h | pattern no. | lam. | V1 | V2 |
|---|------------|--------|-------------------------|--------|-------------------------|--------|----------|----------|
| 30"D return left, 24"D right  | 3 Grommets | 42" | 42" | 1 1/4" | MU1-C4242DS-Q(-) | \$966. | \$1,246. | \$1,738. |
| | | 42" | 48" | 1 1/4" | MU1-C4248DS-Q(-) | 1,037. | 1,336. | 1,866. |
| | | 42" | 60" | 1 1/4" | MU1-C4260DS-Q(-) | 1,179. | 1,515. | 2,122. |
| | | 42" | 66" | 1 1/4" | MU1-C4266DS-Q(-) | 1,266. | 1,628. | 2,283. |
| | | 42" | 72" | 1 1/4" | MU1-C4272DS-Q(-) | 1,352. | 1,742. | 2,444. |
| | | 48" | 42" | 1 1/4" | MU1-C4842DS-Q(-) | 1,037. | 1,336. | 1,866. |
| | | 48" | 66" | 1 1/4" | MU1-C4866DS-Q(-) | 1,352. | 1,742. | 2,444. |
| | | 60" | 42" | 1 1/4" | MU1-C6042DS-Q(-) | 1,179. | 1,515. | 2,122. |
| | | 66" | 42" | 1 1/4" | MU1-C6642DS-Q(-) | 1,266. | 1,628. | 2,283. |
| | | 66" | 48" | 1 1/4" | MU1-C6648DS-Q(-) | 1,352. | 1,742. | 2,444. |
| 72" | 42" | 1 1/4" | MU1-C7242DS-Q(-) | 1,352. | 1,742. | 2,444. | | |
| 30"D return left and right  | 3 Grommets | 42" | 42" | 1 1/4" | MU1-C4242DD-Q(-) | 966. | 1,246. | 1,738. |
| | | 42" | 48" | 1 1/4" | MU1-C4248DD-Q(-) | 1,037. | 1,336. | 1,866. |
| | | 42" | 60" | 1 1/4" | MU1-C4260DD-Q(-) | 1,179. | 1,515. | 2,122. |
| | | 42" | 66" | 1 1/4" | MU1-C4266DD-Q(-) | 1,266. | 1,628. | 2,283. |
| | | 42" | 72" | 1 1/4" | MU1-C4272DD-Q(-) | 1,352. | 1,742. | 2,444. |
| | | 48" | 42" | 1 1/4" | MU1-C4842DD-Q(-) | 1,037. | 1,336. | 1,866. |
| | | 48" | 60" | 1 1/4" | MU1-C4860DD-Q(-) | 1,250. | 1,606. | 2,249. |
| | | 48" | 66" | 1 1/4" | MU1-C4866DD-Q(-) | 1,352. | 1,742. | 2,444. |
| | | 48" | 72" | 1 1/4" | MU1-C4872DD-Q(-) | 1,423. | 1,833. | 2,571. |
| | | 60" | 42" | 1 1/4" | MU1-C6042DD-Q(-) | 1,179. | 1,515. | 2,122. |
| | | 60" | 48" | 1 1/4" | MU1-C6048DD-Q(-) | 1,250. | 1,606. | 2,249. |
| | | 66" | 42" | 1 1/4" | MU1-C6642DD-Q(-) | 1,266. | 1,628. | 2,283. |
| | | 66" | 48" | 1 1/4" | MU1-C6648DD-Q(-) | 1,352. | 1,742. | 2,444. |
| | | 72" | 42" | 1 1/4" | MU1-C7242DD-Q(-) | 1,352. | 1,742. | 2,444. |
| 72" | 48" | 1 1/4" | MU1-C7248DD-Q(-) | 1,423. | 1,833. | 2,571. | | |

Morrison System

| Order Code | Specification Information | Application Notes |
|--|---|--|
| Example: MU1-C4248SD-Q-117 MU1 Worksurface, 1 1/4" C L-shape curvilinear 42 Width left 48 Width right S Depth of left return D Depth of right return Q Standard Specials 117 Surface finish | Width dimension (W) refers to width of left-side back edge; depth dimension (D) indicates width of right-side back edge. S- 24"D side edge D- 30"D side edge Specify surface finish. 1 1/4" curvilinear surfaces are solid core construction with threaded metal inserts at desk support and all bracket locations. All worksurfaces are U.L.-listed. All L-shape curvilinear worksurfaces have three grommets. | L-shape curvilinear worksurfaces may be used interchangeably in desk and panel system applications. They may be supported by corner desk supports or by VDT end support bracket kit. Use cantilever bridging brackets or flat brackets to join to adjacent worksurfaces. L-shape surfaces may also be supported by MN1- end panel in conjunction with desk support, or cantilever bracket in panel planning. L-shape surfaces are veneer or post-formed plastic laminate on both back edges, matching profile T-mold on curvilinear front, and self-edge on sides. Curvilinear worksurfaces are available only in 1 1/4" thickness. L-shape surfaces are 3/8" less than nominal depth for rear wire clearance or privacy screens. If specifying privacy screens on both back edges, one or both must be 48" back-of-VDT type. |

Morrison Worksurfaces, 1 1/4"

J-shape surfaces

Standard Specials Systems

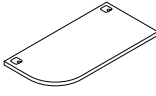
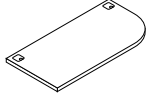
| description | w | d | h | pattern no. | lam. | V1 | V2 |
|--|---------|---------|------------------------|------------------------|--------|--------|----------|
| J-shape - Rounded left  | 24" | 23 5/8" | 1 1/4" | MU1-J24A-L-Q(-) | \$742. | \$905. | \$1,222. |
| | 30" | 23 5/8" | 1 1/4" | MU1-J30A-L-Q(-) | n/a | 975. | 1,316. |
| | 36" | 23 5/8" | 1 1/4" | MU1-J36A-L-Q(-) | n/a | 1,035. | 1,397. |
| | 42" | 23 5/8" | 1 1/4" | MU1-J42A-L-Q(-) | n/a | 1,099. | 1,483. |
| | 48" | 23 5/8" | 1 1/4" | MU1-J48A-L-Q(-) | n/a | 1,171. | 1,581. |
| | 54" | 23 5/8" | 1 1/4" | MU1-J54A-L-Q(-) | 959. | 1,243. | 1,679. |
| | 60" | 23 5/8" | 1 1/4" | MU1-J60A-L-Q(-) | 1,018. | 1,315. | 1,777. |
| | 66" | 23 5/8" | 1 1/4" | MU1-J66A-L-Q(-) | 1,077. | 1,387. | 1,875. |
| | 72" | 23 5/8" | 1 1/4" | MU1-J72A-L-Q(-) | 1,136. | 1,458. | 1,973. |
| | 78" | 23 5/8" | 1 1/4" | MU1-J78A-L-Q(-) | 1,195. | 1,530. | 2,071. |
| | 84" | 23 5/8" | 1 1/4" | MU1-J84A-L-Q(-) | 1,254. | 1,602. | 2,169. |
| | 90" | 23 5/8" | 1 1/4" | MU1-J90A-L-Q(-) | 1,313. | 1,674. | 2,267. |
| 96" | 23 5/8" | 1 1/4" | MU1-J96A-L-Q(-) | 1,372. | 1,746. | 2,365. | |
| J-shape - Rounded right  | 24" | 23 5/8" | 1 1/4" | MU1-J24A-R-Q(-) | 742. | 905. | 1,222. |
| | 30" | 23 5/8" | 1 1/4" | MU1-J30A-R-Q(-) | n/a | 975. | 1,316. |
| | 36" | 23 5/8" | 1 1/4" | MU1-J36A-R-Q(-) | n/a | 1,035. | 1,397. |
| | 42" | 23 5/8" | 1 1/4" | MU1-J42A-R-Q(-) | n/a | 1,099. | 1,483. |
| | 48" | 23 5/8" | 1 1/4" | MU1-J48A-R-Q(-) | n/a | 1,171. | 1,581. |
| | 54" | 23 5/8" | 1 1/4" | MU1-J54A-R-Q(-) | 959. | 1,243. | 1,679. |
| | 60" | 23 5/8" | 1 1/4" | MU1-J60A-R-Q(-) | 1,018. | 1,315. | 1,777. |
| | 66" | 23 5/8" | 1 1/4" | MU1-J66A-R-Q(-) | 1,077. | 1,387. | 1,875. |
| | 72" | 23 5/8" | 1 1/4" | MU1-J72A-R-Q(-) | 1,136. | 1,458. | 1,973. |
| | 78" | 23 5/8" | 1 1/4" | MU1-J78A-R-Q(-) | 1,195. | 1,530. | 2,071. |
| | 84" | 23 5/8" | 1 1/4" | MU1-J84A-R-Q(-) | 1,254. | 1,602. | 2,169. |
| | 90" | 23 5/8" | 1 1/4" | MU1-J90A-R-Q(-) | 1,313. | 1,674. | 2,267. |
| 96" | 23 5/8" | 1 1/4" | MU1-J96A-R-Q(-) | 1,372. | 1,746. | 2,365. | |

| Order Code | Specification Information | Application Notes |
|---|--|---|
| Example: MU1-J30A-L-Q-117 MU1 Worksurface, 1 1/4" J J-shape 30 Width A With grommets L Left Q Standard Specials 117 Surface finish | 1 1/4" curvilinear surfaces are solid core construction with threaded metal inserts at desk support and all bracket locations and pilot holes at pedestal locations. Specify surface finish. All worksurfaces are U.L.-listed. J-shape worksurfaces have 2 grommets for use with freestanding desk and overhead supports. | J-shape curvilinear worksurfaces may be used interchangeably in desk and panel system applications. They may be supported by straight desk support or cantilever brackets. J-shapes also require 9" Network end panel in desk or panel planning. Use flat bracket or bridging bracket to join to adjacent 1 1/4" worksurface. Also specify VDT end support bracket kit for optimal stability of vertical panel behind J-shape worksurface. J-shape surfaces are post-formed on back edge, matching profile T-mold on curvilinear front, and self-edge on sides. J-shapes are available only in plastic laminate, 1 1/4" thickness. J-shape surfaces are 3/8" less than nominal depth for wire clearance or privacy screens. |

Morrison Worksurfaces, 1 1/4"

Wave-end surfaces

Standard Specials Systems

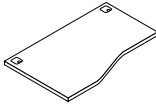
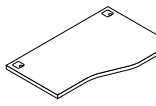
| description | w | d | h | pattern no. | lam. |
|---|-----|---------|--------|------------------|--------|
| Left wave-end  | 30" | 29 5/8" | 1 1/4" | MU1-W30A-L-Q-() | \$900. |
| | 54" | 29 5/8" | 1 1/4" | MU1-W54A-L-Q-() | 1,066. |
| | 60" | 29 5/8" | 1 1/4" | MU1-W60A-L-Q-() | 1,125. |
| | 66" | 29 5/8" | 1 1/4" | MU1-W66A-L-Q-() | 1,184. |
| | 72" | 29 5/8" | 1 1/4" | MU1-W72A-L-Q-() | 1,243. |
| | 78" | 29 5/8" | 1 1/4" | MU1-W78A-L-Q-() | 1,302. |
| | 84" | 29 5/8" | 1 1/4" | MU1-W84A-L-Q-() | 1,361. |
| | 90" | 29 5/8" | 1 1/4" | MU1-W90A-L-Q-() | 1,420. |
| | 96" | 29 5/8" | 1 1/4" | MU1-W96A-L-Q-() | 1,479. |
| Right wave-end  | 30" | 29 5/8" | 1 1/4" | MU1-W30A-R-Q-() | 900. |
| | 54" | 29 5/8" | 1 1/4" | MU1-W54A-R-Q-() | 1,066. |
| | 60" | 29 5/8" | 1 1/4" | MU1-W60A-R-Q-() | 1,125. |
| | 66" | 29 5/8" | 1 1/4" | MU1-W66A-R-Q-() | 1,184. |
| | 72" | 29 5/8" | 1 1/4" | MU1-W72A-R-Q-() | 1,243. |
| | 78" | 29 5/8" | 1 1/4" | MU1-W78A-R-Q-() | 1,302. |
| | 84" | 29 5/8" | 1 1/4" | MU1-W84A-R-Q-() | 1,361. |
| | 90" | 29 5/8" | 1 1/4" | MU1-W90A-R-Q-() | 1,420. |
| | 96" | 29 5/8" | 1 1/4" | MU1-W96A-R-Q-() | 1,479. |

Morrison System

Order Code

| | |
|------------|-------------------------|
| Example: | MU1-W48A-L-Q-117 |
| MU1 | Worksurface, 1 1/4" |
| W | Wave-end curvilinear |
| 48 | Width |
| A | With grommets |
| L | Left |
| Q | Standard Special |
| 117 | Surface finish |

Specification Information

1 1/4" curvilinear surfaces are solid core construction with threaded metal inserts at desk support, and all bracket locations and pilot holes at pedestal locations.

Specify surface finish.

All worksurfaces are U.L.-listed.

Wave-end worksurfaces have 2 grommets for use with freestanding desk and overhead supports.

Application Notes

Wave-end curvilinear worksurfaces may be used interchangeably in desk and panel system applications. They may be supported by straight desk support or cantilever brackets.

Use flat bracket or bridging bracket to join to adjacent 1 1/4" worksurface.

Wave-end surfaces are post-formed on back edge, matching profile T-mold on curvilinear front, and self-edge on sides.



Wave-end surfaces are available only in plastic laminate, 1 1/4" thickness.

Wave-end surfaces are nominal 30"D at left or right, and align with 24"D surface at the other end. Inserts for 24"D pedestal are standard at the wave end.

Wave-end surfaces are 3/8" less than nominal depth for wire clearance or privacy screens.

Morrison Options Worksurfaces, 1 1/4" 18" D

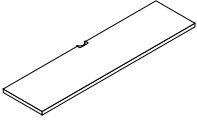
Standard Specials Systems

| description | type | w | d | h | pattern no. | lam. | V1 | V2 |
|----------------|--|------|---------|--------|---------------------------|--------|--------|--------|
| Straight, 18"D | Grommets  | 18" | 17 3/8" | 1 1/4" | LU1-S1818-A-Q-() | \$231. | \$388. | \$572. |
| | | 24" | 17 3/8" | 1 1/4" | LU1-S2418-A-Q-() | 231. | 388. | 572. |
| | | 102" | 17 3/8" | 1 1/4" | LU1-S10218-A-Q-() | 610. | 968. | 1,484. |
| | | 114" | 17 3/8" | 1 1/4" | LU1-S11418-A-Q-() | 640. | 1,020. | 1,567. |
| | No Grommets  | 18" | 17 3/8" | 1 1/4" | LU1-S1818-B-Q-() | 195. | 359. | 542. |
| | | 24" | 17 3/8" | 1 1/4" | LU1-S2418-B-Q-() | 195. | 359. | 542. |
| | | 102" | 17 3/8" | 1 1/4" | LU1-S10218-B-Q-() | 581. | 938. | 1,453. |
| | | 114" | 17 3/8" | 1 1/4" | LU1-S11418-B-Q-() | 610. | 992. | 1,538. |

| Order Code | Specification Information | Application Notes |
|--------------------------------------|--|---|
| Example: LU1-S2418-B-Q-117 | | |
| LU1 Worksurface, 1 1/4" thick | A- worksurface includes one edge grommet | 18"D worksurfaces are used in panel system applications as shallow main surfaces, extensions or credenza tops. They may be supported at each end by an 18" end support bracket, 18" cantilever bracket, 18"W desk end panel or 18"D pedestal. |
| S Straight worksurface | B- worksurface does not include grommet | |
| 24 Width | | Options worksurfaces cannot be used in conjunction with Network desk supports. |
| 18 Depth | Specify surface finish. | |
| B No grommet | 1 1/4" Options worksurfaces are 3-ply, solid core construction with pilot holes at all pedestal, end panel, and bracket locations. | All straight worksurfaces are 3/8" less than nominal depth for rear wire clearance. |
| Q Standard Specials | Edge grommets are centered at rear of worksurface. | |
| 117 Surface finish | | Panel-supported 1 1/4" worksurfaces over 48" must be mid-span supported by MB2-C18 bracket, specified separately. |
| | | Panel-supported 1 1/4" worksurfaces over 96" must be pedestal or MB2-C24 cantilever bracket supported every 48". |
| | | Suspended pedestals may not be used with 1 1/4" worksurfaces. |

Morrison Options Worksurfaces, 1 1/4" 24" D

Standard Specials Systems

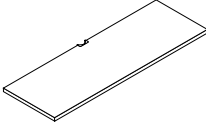
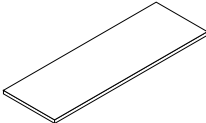
| description | type | w | d | h | pattern no. | lam. | V1 | V2 |
|----------------|--|------|---------|--------|---------------------------|--------|--------|--------|
| Straight, 24"D | Grommets  | 18" | 23 5/8" | 1 1/4" | LU1-S1824-A-Q-() | \$273. | \$489. | \$706. |
| | | 102" | 23 5/8" | 1 1/4" | LU1-S10224-A-Q-() | 668. | 1,063. | 1,628. |
| | | 114" | 23 5/8" | 1 1/4" | LU1-S11424-A-Q-() | 712. | 1,129. | 1,720. |
| | No Grommets  | 24" | 23 5/8" | 1 1/4" | LU1-S1824-B-Q-() | 244. | 457. | 680. |
| | | 102" | 23 5/8" | 1 1/4" | LU1-S10224-B-Q-() | 640. | 1,033. | 1,599. |
| | | 114" | 23 5/8" | 1 1/4" | LU1-S11424-B-Q-() | 680. | 1,099. | 1,691. |

Morrison System

| Order Code | Specification Information | Application Notes |
|--------------------------------------|--|---|
| Example: LU1-S1824-B-Q-117 | | |
| LU1 Worksurface, 1 1/4" thick | A- worksurface includes one edge grommet | Options worksurfaces cannot be used in conjunction with Network desk supports. |
| S Straight worksurface | B- worksurface does not include grommet | |
| 18 Width | | All straight worksurfaces are 5/8" less than nominal depth for rear wire clearance. |
| 24 Depth | Specify surface finish. | |
| B No grommet | 1 1/4" Options worksurfaces are 3-ply, solid core construction with pilot holes at all pedestal, end panel, and bracket locations. | Panel-supported 1 1/4" worksurfaces over 48" must be mid-span supported by MB2-C18 bracket, specified separately. |
| Q Standard Specials | | |
| 117 Surface finish | Edge grommets are centered at rear of worksurface. | Panel-supported 1 1/4" worksurfaces over 96" must be pedestal or MB2-C24 cantilever bracket supported every 48". |
| | | Suspended pedestals may not be used with 1 1/4" worksurfaces. |

Morrison Options Worksurfaces, 1 1/4" 30" D

Standard Specials Systems

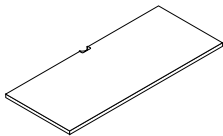
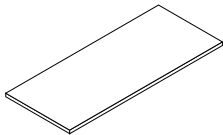
| description | type | w | d | h | pattern no. | lam. | V1 | V2 |
|--|---|------|---------|--------|---------------------------|--------|--------|--------|
| Straight, 30"D | Grommets  | 18" | 29 3/8" | 1 1/4" | LU1-S1830-A-Q-() | \$290. | \$476. | \$742. |
| | | 24" | 29 3/8" | 1 1/4" | LU1-S2430-A-Q-() | 290. | 476. | 742. |
| | | 102" | 29 3/8" | 1 1/4" | LU1-S10230-A-Q-() | 727. | 1,122. | 1,698. |
| | | 108" | 29 3/8" | 1 1/4" | LU1-S10830-A-Q-() | 786. | 1,181. | 1,781. |
| | | 114" | 29 3/8" | 1 1/4" | LU1-S11430-A-Q-() | 845. | 1,240. | 1,863. |
| | | 120" | 29 3/8" | 1 1/4" | LU1-S12030-A-Q-() | 904. | 1,299. | 1,946. |
| No Grommets  | No Grommets | 18" | 29 3/8" | 1 1/4" | LU1-S1830-B-Q-() | 261. | 454. | 712. |
| | | 24" | 29 3/8" | 1 1/4" | LU1-S2430-B-Q-() | 261. | 454. | 712. |
| | | 102" | 29 3/8" | 1 1/4" | LU1-S10230-B-Q-() | 699. | 1,092. | 1,669. |
| | | 108" | 29 3/8" | 1 1/4" | LU1-S10830-B-Q-() | 758. | 1,151. | 1,751. |
| | | 114" | 29 3/8" | 1 1/4" | LU1-S11430-B-Q-() | 817. | 1,210. | 1,834. |
| | | 120" | 29 3/8" | 1 1/4" | LU1-S12030-B-Q-() | 876. | 1,269. | 1,916. |

| Order Code | Specification Information | Application Notes |
|--------------------------------------|--|--|
| Example: LU1-S1830B-Q-117 | <i>Grommets/no grommets:</i> | 30"D worksurfaces are used in panel system applications as main surfaces, extensions or credenza tops. They can be supported at each end by 30" end support bracket, 30" cantilever bracket or 30"W end panel. |
| LU1 Worksurface, 1 1/4" thick | A- worksurface includes one edge grommet | Options worksurfaces cannot be used in conjunction with Network desk supports. |
| S Straight worksurface | B- worksurface does not include grommets | All straight worksurfaces are 3/8" less than nominal depth for rear wire clearance. |
| 18 Width | Specify surface finish. | Panel-supported 1 1/4" worksurfaces over 48" must be mid-span supported by MB2-C24 bracket, specified separately. |
| 30 Depth | 1 1/4" Options worksurfaces are 3-ply, solid core construction with pilot holes at all pedestal, end panel, and bracket locations. | Suspended pedestals may not be used with 1 1/4" worksurfaces. |
| B No grommets | Edge grommets are centered at rear of worksurface. | |
| Q Standard Specials | | |
| 117 Surface finish | | |

Morrison Options Worksurfaces, 1 1/4" 36" D

Standard Specials Systems

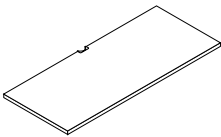
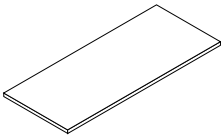
| description | type | w | d | h | pattern no. | lam. | V1 | V2 |
|----------------|--|--------|--------------------|--------|--------------------|--------|--------|--------|
| Straight, 36"D |  Grommets | 36" | 35 3/8" | 1 1/4" | LU1-S3636-A-Q-() | \$432. | \$649. | \$992. |
| | | 42" | 35 3/8" | 1 1/4" | LU1-S4236-A-Q-() | 464. | 700. | 1,058. |
| | | 48" | 35 3/8" | 1 1/4" | LU1-S4836-A-Q-() | 492. | 746. | 1,127. |
| | | 54" | 35 3/8" | 1 1/4" | LU1-S5436-A-Q-() | 524. | 811. | 1,212. |
| | | 60" | 35 3/8" | 1 1/4" | LU1-S6036-A-Q-() | 553. | 863. | 1,296. |
| | | 66" | 35 3/8" | 1 1/4" | LU1-S6636-A-Q-() | 584. | 906. | 1,401. |
| | | 72" | 35 3/8" | 1 1/4" | LU1-S7236-A-Q-() | 631. | 972. | 1,481. |
| | | 78" | 35 3/8" | 1 1/4" | LU1-S7836-A-Q-() | 662. | 1,012. | 1,548. |
| | | 84" | 35 3/8" | 1 1/4" | LU1-S8436-A-Q-() | 693. | 1,062. | 1,625. |
| | | 90" | 35 3/8" | 1 1/4" | LU1-S9036-A-Q-() | 722. | 1,113. | 1,687. |
| | | 96" | 35 3/8" | 1 1/4" | LU1-S9636-A-Q-() | 750. | 1,163. | 1,769. |
| | | 102" | 35 3/8" | 1 1/4" | LU1-S10236-A-Q-() | 809. | 1,222. | 1,851. |
| | | 108" | 35 3/8" | 1 1/4" | LU1-S10836-A-Q-() | 868. | 1,281. | 1,934. |
| | | 114" | 35 3/8" | 1 1/4" | LU1-S11436-A-Q-() | 927. | 1,340. | 2,017. |
| 120" | 35 3/8" | 1 1/4" | LU1-S12036-A-Q-() | 986. | 1,399. | 2,099. | | |
| No Grommets |  No Grommets | 36" | 35 3/8" | 1 1/4" | LU1-S3636-B-Q-() | 402. | 621. | 964. |
| | | 42" | 35 3/8" | 1 1/4" | LU1-S4236-B-Q-() | 433. | 669. | 1,029. |
| | | 48" | 35 3/8" | 1 1/4" | LU1-S4836-B-Q-() | 464. | 716. | 1,097. |
| | | 54" | 35 3/8" | 1 1/4" | LU1-S5436-B-Q-() | 492. | 785. | 1,184. |
| | | 60" | 35 3/8" | 1 1/4" | LU1-S6036-B-Q-() | 525. | 833. | 1,269. |
| | | 66" | 35 3/8" | 1 1/4" | LU1-S6636-B-Q-() | 553. | 879. | 1,370. |
| | | 72" | 35 3/8" | 1 1/4" | LU1-S7236-B-Q-() | 599. | 942. | 1,451. |
| | | 78" | 35 3/8" | 1 1/4" | LU1-S7836-B-Q-() | 631. | 985. | 1,521. |
| | | 84" | 35 3/8" | 1 1/4" | LU1-S8436-B-Q-() | 663. | 1,034. | 1,595. |
| | | 90" | 35 3/8" | 1 1/4" | LU1-S9036-B-Q-() | 693. | 1,083. | 1,661. |
| | | 96" | 35 3/8" | 1 1/4" | LU1-S9636-B-Q-() | 722. | 1,133. | 1,739. |
| | | 102" | 35 3/8" | 1 1/4" | LU1-S10236-B-Q-() | 781. | 1,192. | 1,822. |
| | | 108" | 35 3/8" | 1 1/4" | LU1-S10836-B-Q-() | 840. | 1,251. | 1,905. |
| | | 114" | 35 3/8" | 1 1/4" | LU1-S11436-B-Q-() | 899. | 1,310. | 1,987. |
| 120" | 35 3/8" | 1 1/4" | LU1-S12036-B-Q-() | 958. | 1,369. | 2,070. | | |

Morrison System

| Order Code | Specification Information | Application Notes |
|--------------------------------------|--|--|
| Example: LU1-S3636B-Q-117 | <i>Grommets/no grommets:</i> | 30"D worksurfaces are used in panel system applications as main surfaces, extensions or credenza tops. They can be supported at each end by 30" end support bracket, 30" cantilever bracket or 30"W end panel. |
| LU1 Worksurface, 1 1/4" thick | A- worksurface includes one edge grommet | |
| S Straight worksurface | B- worksurface does not include grommets | Options worksurfaces cannot be used in conjunction with Network desk supports. |
| 36 Width | Specify surface finish. | |
| 36 Depth | 1 1/4" Options worksurfaces are 3-ply, solid core construction with pilot holes at all pedestal, end panel, and bracket locations. | All straight worksurfaces are 3/8" less than nominal depth for rear wire clearance. |
| B No grommets | Edge grommets are centered at rear of worksurface. | |
| Q Standard Specials | | Panel-supported 1 1/4" worksurfaces over 48" must be mid-span supported by MB2-C24 bracket, specified separately. |
| 117 Surface finish | | |
| | | Suspended pedestals may not be used with 1 1/4" worksurfaces. |

Morrison Options Worksurfaces, 1 1/4" 18" D + Post

Standard Specials Systems

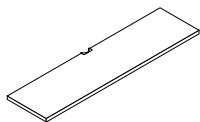
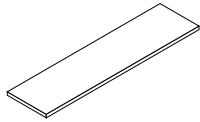
| description | type | w | d | h | pattern no. | lam. | V1 | V2 |
|-----------------------|---|------|---------|--------|---------------------------|--------|--------|--------|
| Straight, 18"D + Post |  | 20" | 17 5/8" | 1 1/4" | LU1-S2018-A-Q-() | \$231. | \$388. | \$572. |
| | | 26" | 17 5/8" | 1 1/4" | LU1-S2618-A-Q-() | 244. | 405. | 607. |
| | | 32" | 17 5/8" | 1 1/4" | LU1-S3218-A-Q-() | 257. | 421. | 641. |
| | | 38" | 17 5/8" | 1 1/4" | LU1-S3818-A-Q-() | 289. | 472. | 727. |
| | | 44" | 17 5/8" | 1 1/4" | LU1-S4418-A-Q-() | 320. | 499. | 774. |
| | | 50" | 17 5/8" | 1 1/4" | LU1-S5018-A-Q-() | 349. | 550. | 840. |
| | | 56" | 17 5/8" | 1 1/4" | LU1-S5618-A-Q-() | 381. | 599. | 929. |
| | | 62" | 17 5/8" | 1 1/4" | LU1-S6218-A-Q-() | 409. | 662. | 1,028. |
| | | 68" | 17 5/8" | 1 1/4" | LU1-S6818-A-Q-() | 441. | 729. | 1,114. |
| | | 74" | 17 5/8" | 1 1/4" | LU1-S7418-A-Q-() | 471. | 767. | 1,173. |
| | | 80" | 17 5/8" | 1 1/4" | LU1-S8018-A-Q-() | 502. | 804. | 1,232. |
| | | 86" | 17 5/8" | 1 1/4" | LU1-S8618-A-Q-() | 533. | 858. | 1,312. |
| | | 92" | 17 5/8" | 1 1/4" | LU1-S9218-A-Q-() | 564. | 904. | 1,387. |
| | | 98" | 17 5/8" | 1 1/4" | LU1-S9818-A-Q-() | 610. | 968. | 1,484. |
| | | 104" | 17 5/8" | 1 1/4" | LU1-S10418-A-Q-() | 625. | 994. | 1,526. |
| | | 110" | 17 5/8" | 1 1/4" | LU1-S11018-A-Q-() | 640. | 1,020. | 1,567. |
| | | 116" | 17 5/8" | 1 1/4" | LU1-S11618-A-Q-() | 668. | 1,044. | 1,608. |
| No Grommets |  | 20" | 17 5/8" | 1 1/4" | LU1-S2018-B-Q-() | 195. | 359. | 542. |
| | | 26" | 17 5/8" | 1 1/4" | LU1-S2618-B-Q-() | 212. | 375. | 576. |
| | | 32" | 17 5/8" | 1 1/4" | LU1-S3218-B-Q-() | 230. | 392. | 610. |
| | | 38" | 17 5/8" | 1 1/4" | LU1-S3818-B-Q-() | 257. | 441. | 695. |
| | | 44" | 17 5/8" | 1 1/4" | LU1-S4418-B-Q-() | 290. | 472. | 745. |
| | | 50" | 17 5/8" | 1 1/4" | LU1-S5018-B-Q-() | 320. | 523. | 813. |
| | | 56" | 17 5/8" | 1 1/4" | LU1-S5618-B-Q-() | 350. | 569. | 897. |
| | | 62" | 17 5/8" | 1 1/4" | LU1-S6218-B-Q-() | 381. | 632. | 997. |
| | | 68" | 17 5/8" | 1 1/4" | LU1-S6818-B-Q-() | 409. | 697. | 1,083. |
| | | 74" | 17 5/8" | 1 1/4" | LU1-S7418-B-Q-() | 443. | 738. | 1,140. |
| | | 80" | 17 5/8" | 1 1/4" | LU1-S8018-B-Q-() | 471. | 775. | 1,201. |
| | | 86" | 17 5/8" | 1 1/4" | LU1-S8618-B-Q-() | 503. | 827. | 1,281. |
| | | 92" | 17 5/8" | 1 1/4" | LU1-S9218-B-Q-() | 533. | 874. | 1,358. |
| | | 98" | 17 5/8" | 1 1/4" | LU1-S9818-B-Q-() | 581. | 938. | 1,453. |
| | | 104" | 17 5/8" | 1 1/4" | LU1-S10418-B-Q-() | 596. | 965. | 1,495. |
| | | 110" | 17 5/8" | 1 1/4" | LU1-S11018-B-Q-() | 610. | 992. | 1,538. |
| | | 116" | 17 5/8" | 1 1/4" | LU1-S11618-B-Q-() | 640. | 1,017. | 1,579. |

Order Code

| | |
|------------|---------------------------|
| Example: | LU1-S4418-B-Q-117 |
| LU1 | Worksurface, 1 1/4" thick |
| S | Straight worksurface |
| 44 | Width |
| 18 | Depth |
| B | No grommet |
| Q | Standard Specials |
| 117 | Surface finish |

Specification Information

Grommet/no grommet:
A- worksurface includes one edge grommet
B- worksurface does not include grommet

Specify surface finish.

1 1/4" Options worksurfaces are 3-ply, solid core construction with pilot holes at all pedestal, end panel, and bracket locations.

Edge grommets are centered at rear of worksurface.

Application Notes

18"D worksurfaces are used in panel system applications as shallow main surfaces, extensions or credenza tops. They may be supported at each end by an 18" end support bracket, 18" cantilever bracket, 18"W desk end panel or 18"D pedestal.

Options worksurfaces cannot be used in conjunction with Network desk supports.

All straight worksurfaces are 3/8" less than nominal depth for rear wire clearance.

Panel-supported 1 1/4" worksurfaces over 48" must be mid-span supported by MB2-C18 bracket, specified separately.

Panel-supported 1 1/4" worksurfaces over 96" must be pedestal or MB2-C24 cantilever bracket supported every 48".

Suspended pedestals may not be used with 1 1/4" worksurfaces.

Morrison Options Worksurfaces, 1 1/4" 24" D + Post

Standard Specials Systems

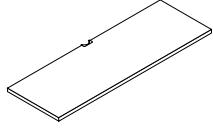
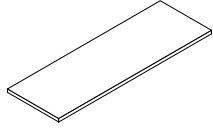
| description | type | w | d | h | pattern no. | lam. | V1 | V2 |
|-----------------------|---|--------|--------------------|--------|--------------------|--------|--------|--------|
| Straight, 24"D + Post |  | 20" | 23 5/8" | 1 1/4" | LU1-S2024-A-Q-() | \$273. | \$489. | \$706. |
| | | 26" | 23 5/8" | 1 1/4" | LU1-S2624-A-Q-() | 289. | 504. | 726. |
| | | 32" | 23 5/8" | 1 1/4" | LU1-S3224-A-Q-() | 306. | 525. | 740. |
| | | 38" | 23 5/8" | 1 1/4" | LU1-S3824-A-Q-() | 335. | 542. | 789. |
| | | 44" | 23 5/8" | 1 1/4" | LU1-S4424-A-Q-() | 365. | 582. | 894. |
| | | 50" | 23 5/8" | 1 1/4" | LU1-S5024-A-Q-() | 396. | 647. | 976. |
| | | 56" | 23 5/8" | 1 1/4" | LU1-S5624-A-Q-() | 427. | 680. | 1,025. |
| | | 62" | 23 5/8" | 1 1/4" | LU1-S6224-A-Q-() | 458. | 748. | 1,128. |
| | | 68" | 23 5/8" | 1 1/4" | LU1-S6824-A-Q-() | 489. | 794. | 1,233. |
| | | 74" | 23 5/8" | 1 1/4" | LU1-S7424-A-Q-() | 516. | 819. | 1,285. |
| | | 80" | 23 5/8" | 1 1/4" | LU1-S8024-A-Q-() | 549. | 890. | 1,355. |
| | | 86" | 23 5/8" | 1 1/4" | LU1-S8624-A-Q-() | 579. | 948. | 1,440. |
| | | 92" | 23 5/8" | 1 1/4" | LU1-S9224-A-Q-() | 610. | 1,002. | 1,522. |
| | | 98" | 23 5/8" | 1 1/4" | LU1-S9824-A-Q-() | 668. | 1,063. | 1,628. |
| | | 104" | 23 5/8" | 1 1/4" | LU1-S10424-A-Q-() | 689. | 1,096. | 1,674. |
| | | 110" | 23 5/8" | 1 1/4" | LU1-S11024-A-Q-() | 712. | 1,129. | 1,720. |
| 116" | 23 5/8" | 1 1/4" | LU1-S11624-A-Q-() | 733. | 1,161. | 1,765. | | |
| No Grommets |  | 20" | 23 5/8" | 1 1/4" | LU1-S2024-B-Q-() | 244. | 457. | 680. |
| | | 26" | 23 5/8" | 1 1/4" | LU1-S2624-B-Q-() | 257. | 477. | 694. |
| | | 32" | 23 5/8" | 1 1/4" | LU1-S3224-B-Q-() | 275. | 494. | 709. |
| | | 38" | 23 5/8" | 1 1/4" | LU1-S3824-B-Q-() | 306. | 510. | 758. |
| | | 44" | 23 5/8" | 1 1/4" | LU1-S4424-B-Q-() | 335. | 551. | 865. |
| | | 50" | 23 5/8" | 1 1/4" | LU1-S5024-B-Q-() | 366. | 618. | 945. |
| | | 56" | 23 5/8" | 1 1/4" | LU1-S5624-B-Q-() | 396. | 649. | 995. |
| | | 62" | 23 5/8" | 1 1/4" | LU1-S6224-B-Q-() | 428. | 717. | 1,100. |
| | | 68" | 23 5/8" | 1 1/4" | LU1-S6824-B-Q-() | 458. | 766. | 1,204. |
| | | 74" | 23 5/8" | 1 1/4" | LU1-S7424-B-Q-() | 489. | 788. | 1,257. |
| | | 80" | 23 5/8" | 1 1/4" | LU1-S8024-B-Q-() | 517. | 860. | 1,325. |
| | | 86" | 23 5/8" | 1 1/4" | LU1-S8624-B-Q-() | 549. | 922. | 1,410. |
| | | 92" | 23 5/8" | 1 1/4" | LU1-S9224-B-Q-() | 581. | 971. | 1,494. |
| | | 98" | 23 5/8" | 1 1/4" | LU1-S9824-B-Q-() | 640. | 1,033. | 1,599. |
| | | 104" | 23 5/8" | 1 1/4" | LU1-S10424-B-Q-() | 660. | 1,066. | 1,645. |
| | | 110" | 23 5/8" | 1 1/4" | LU1-S11024-B-Q-() | 680. | 1,099. | 1,691. |
| 116" | 23 5/8" | 1 1/4" | LU1-S11624-B-Q-() | 700. | 1,129. | 1,735. | | |

Morrison System

| Order Code | Specification Information | Application Notes |
|--------------------------------------|--|---|
| Example: LU1-S3224-B-Q-117 | <i>Grommet/no grommet:</i> | Options worksurfaces cannot be used in conjunction with Network desk supports. |
| LU1 Worksurface, 1 1/4" thick | A- worksurface includes one edge grommet | All straight worksurfaces are 3/8" less than nominal depth for rear wire clearance. |
| S Straight worksurface | B- worksurface does not include grommet | |
| 32 Width | Specify surface finish. | Panel-supported 1 1/4" worksurfaces over 48" must be mid-span supported by MB2-C18 bracket, specified separately. |
| 24 Depth | | |
| B No grommet | 1 1/4" Options worksurfaces are 3-ply, solid core construction with pilot holes at all pedestal, end panel, and bracket locations. | Panel-supported 1 1/4" worksurfaces over 96" must be pedestal or MB2-C24 cantilever bracket supported every 48". |
| Q Standard Specials | | |
| 117 Surface finish | | |
| | Edge grommets are centered at rear of worksurface. | Suspended pedestals may not be used with 1 1/4" worksurfaces |

Morrison Options Worksurfaces, 1 1/4" 30" D + Post

Standard Specials Systems

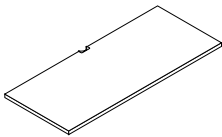
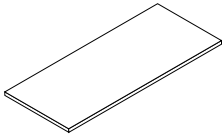
| description | type | w | d | h | pattern no. | lam. | V1 | V2 |
|-----------------------|--|--------|-------------------|--------|-------------------|--------|--------|--------|
| Straight, 30"D + Post | Grommets  | 20" | 29 5/8" | 1 1/4" | LU1-S2030-A-Q-() | \$290. | \$476. | \$742. |
| | | 26" | 29 5/8" | 1 1/4" | LU1-S2630-A-Q-() | 320. | 512. | 791. |
| | | 32" | 29 5/8" | 1 1/4" | LU1-S3230-A-Q-() | 349. | 549. | 839. |
| | | 38" | 29 5/8" | 1 1/4" | LU1-S3830-A-Q-() | 381. | 599. | 905. |
| | | 44" | 29 5/8" | 1 1/4" | LU1-S4430-A-Q-() | 409. | 645. | 974. |
| | | 50" | 29 5/8" | 1 1/4" | LU1-S5030-A-Q-() | 441. | 710. | 1,058. |
| | | 56" | 29 5/8" | 1 1/4" | LU1-S5630-A-Q-() | 471. | 762. | 1,142. |
| | | 62" | 29 5/8" | 1 1/4" | LU1-S6230-A-Q-() | 502. | 806. | 1,247. |
| | | 68" | 29 5/8" | 1 1/4" | LU1-S6830-A-Q-() | 549. | 872. | 1,328. |
| | | 74" | 29 5/8" | 1 1/4" | LU1-S7430-A-Q-() | 579. | 912. | 1,395. |
| | | 80" | 29 5/8" | 1 1/4" | LU1-S8030-A-Q-() | 610. | 962. | 1,471. |
| | | 86" | 29 5/8" | 1 1/4" | LU1-S8630-A-Q-() | 640. | 1,012. | 1,534. |
| | | 92" | 29 5/8" | 1 1/4" | LU1-S9230-A-Q-() | 668. | 1,063. | 1,615. |
| | | 98" | 29 5/8" | 1 1/4" | LU1-S9830-A-Q-() | 727. | 1,122. | 1,698. |
| | | 104" | 29 5/8" | 1 1/4" | LU1-S10430-A-Q-() | 786. | 1,181. | 1,781. |
| | | 110" | 29 5/8" | 1 1/4" | LU1-S11030-A-Q-() | 845. | 1,240. | 1,863. |
| 116" | 29 5/8" | 1 1/4" | LU1-S11630-A-Q-() | 904. | 1,299. | 1,946. | | |
| No Grommets | No Grommets  | 20" | 29 5/8" | 1 1/4" | LU1-S2030-B-Q-() | 261. | 454. | 712. |
| | | 26" | 29 5/8" | 1 1/4" | LU1-S2630-B-Q-() | 290. | 487. | 760. |
| | | 32" | 29 5/8" | 1 1/4" | LU1-S3230-B-Q-() | 320. | 520. | 811. |
| | | 38" | 29 5/8" | 1 1/4" | LU1-S3830-B-Q-() | 350. | 569. | 876. |
| | | 44" | 29 5/8" | 1 1/4" | LU1-S4430-B-Q-() | 381. | 616. | 944. |
| | | 50" | 29 5/8" | 1 1/4" | LU1-S5030-B-Q-() | 409. | 684. | 1,030. |
| | | 56" | 29 5/8" | 1 1/4" | LU1-S5630-B-Q-() | 443. | 733. | 1,115. |
| | | 62" | 29 5/8" | 1 1/4" | LU1-S6230-B-Q-() | 471. | 779. | 1,217. |
| | | 68" | 29 5/8" | 1 1/4" | LU1-S6830-B-Q-() | 517. | 841. | 1,298. |
| | | 74" | 29 5/8" | 1 1/4" | LU1-S7430-B-Q-() | 549. | 885. | 1,368. |
| | | 80" | 29 5/8" | 1 1/4" | LU1-S8030-B-Q-() | 581. | 933. | 1,442. |
| | | 86" | 29 5/8" | 1 1/4" | LU1-S8630-B-Q-() | 610. | 983. | 1,508. |
| | | 92" | 29 5/8" | 1 1/4" | LU1-S9230-B-Q-() | 640. | 1,033. | 1,586. |
| | | 98" | 29 5/8" | 1 1/4" | LU1-S9830-B-Q-() | 699. | 1,092. | 1,669. |
| | | 104" | 29 5/8" | 1 1/4" | LU1-S10430-B-Q-() | 758. | 1,151. | 1,751. |
| | | 110" | 29 5/8" | 1 1/4" | LU1-S11030-B-Q-() | 817. | 1,210. | 1,834. |
| 116" | 29 5/8" | 1 1/4" | LU1-S11630-B-Q-() | 876. | 1,269. | 1,916. | | |

| Order Code | Specification Information | Application Notes |
|--------------------------------------|--|--|
| Example: LU1-S3230B-Q-117 | <i>Grommets/no grommets:</i> | 30"D worksurfaces are used in panel system applications as main surfaces, extensions or credenza tops. They can be supported at each end by 30" end support bracket, 30" cantilever bracket or 30"W end panel. |
| LU1 Worksurface, 1 1/4" thick | A- worksurface includes one edge grommet | Options worksurfaces cannot be used in conjunction with Network desk supports. |
| S Straight worksurface | B- worksurface does not include grommets | |
| 32 Width | Specify surface finish. | All straight worksurfaces are 3/8" less than nominal depth for rear wire clearance. |
| 30 Depth | | |
| B No grommets | 1 1/4" Options worksurfaces are 3-ply, solid core construction with pilot holes at all pedestal, end panel, and bracket locations. | Panel-supported 1 1/4" worksurfaces over 48" must be mid-span supported by MB2-C24 bracket, specified separately. |
| Q Standard Specials | | |
| 117 Surface finish | | |

Morrison Options Worksurfaces, 1 1/4" 36" D + Post

Standard Specials Systems

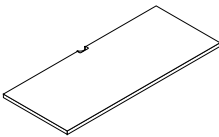
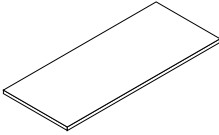
| description | type | w | d | h | pattern no. | lam. | V1 | V2 |
|-----------------------|--|------|---------|--------|--------------------|--------|--------|----------|
| Straight, 36"D + Post |  Grommets | 38" | 35 3/8" | 1 1/4" | LU1-S3836-A-Q-() | \$464. | \$700. | \$1,058. |
| | | 44" | 35 3/8" | 1 1/4" | LU1-S4436-A-Q-() | 492. | 746. | 1,127. |
| | | 50" | 35 3/8" | 1 1/4" | LU1-S5036-A-Q-() | 524. | 811. | 1,212. |
| | | 56" | 35 3/8" | 1 1/4" | LU1-S5636-A-Q-() | 553. | 863. | 1,296. |
| | | 62" | 35 3/8" | 1 1/4" | LU1-S6236-A-Q-() | 584. | 906. | 1,401. |
| | | 68" | 35 3/8" | 1 1/4" | LU1-S6836-A-Q-() | 631. | 972. | 1,481. |
| | | 74" | 35 3/8" | 1 1/4" | LU1-S7436-A-Q-() | 662. | 1,012. | 1,548. |
| | | 80" | 35 3/8" | 1 1/4" | LU1-S8036-A-Q-() | 693. | 1,062. | 1,625. |
| | | 86" | 35 3/8" | 1 1/4" | LU1-S8636-A-Q-() | 722. | 1,113. | 1,687. |
| | | 92" | 35 3/8" | 1 1/4" | LU1-S9236-A-Q-() | 750. | 1,163. | 1,769. |
| | | 98" | 35 3/8" | 1 1/4" | LU1-S9836-A-Q-() | 809. | 1,222. | 1,851. |
| | | 104" | 35 3/8" | 1 1/4" | LU1-S10436-A-Q-() | 868. | 1,281. | 1,934. |
| | | 110" | 35 3/8" | 1 1/4" | LU1-S11036-A-Q-() | 927. | 1,340. | 2,017. |
| | | 116" | 35 3/8" | 1 1/4" | LU1-S11636-A-Q-() | 986. | 1,399. | 2,099. |
| No Grommets |  No Grommets | 38" | 35 3/8" | 1 1/4" | LU1-S3836-B-Q-() | 433. | 669. | 1,029. |
| | | 44" | 35 3/8" | 1 1/4" | LU1-S4436-B-Q-() | 464. | 716. | 1,097. |
| | | 50" | 35 3/8" | 1 1/4" | LU1-S5036-B-Q-() | 492. | 785. | 1,184. |
| | | 56" | 35 3/8" | 1 1/4" | LU1-S5636-B-Q-() | 525. | 833. | 1,269. |
| | | 62" | 35 3/8" | 1 1/4" | LU1-S6236-B-Q-() | 553. | 879. | 1,370. |
| | | 68" | 35 3/8" | 1 1/4" | LU1-S6836-B-Q-() | 599. | 942. | 1,451. |
| | | 74" | 35 3/8" | 1 1/4" | LU1-S7436-B-Q-() | 631. | 985. | 1,521. |
| | | 80" | 35 3/8" | 1 1/4" | LU1-S8036-B-Q-() | 663. | 1,034. | 1,595. |
| | | 86" | 35 3/8" | 1 1/4" | LU1-S8636-B-Q-() | 693. | 1,083. | 1,661. |
| | | 92" | 35 3/8" | 1 1/4" | LU1-S9236-B-Q-() | 722. | 1,133. | 1,739. |
| | | 98" | 35 3/8" | 1 1/4" | LU1-S9836-B-Q-() | 781. | 1,192. | 1,822. |
| | | 104" | 35 3/8" | 1 1/4" | LU1-S10436-B-Q-() | 840. | 1,251. | 1,905. |
| | | 110" | 35 3/8" | 1 1/4" | LU1-S11036-B-Q-() | 899. | 1,310. | 1,987. |
| | | 116" | 35 3/8" | 1 1/4" | LU1-S11636-B-Q-() | 958. | 1,369. | 2,070. |

Morrison System

| Order Code | Specification Information | Application Notes |
|--------------------------------------|--|--|
| Example: LU1-S3836B-Q-117 | <i>Grommets/no grommets:</i> | 30"D worksurfaces are used in panel system applications as main surfaces, extensions or credenza tops. They can be supported at each end by 30" end support bracket, 30" cantilever bracket or 30"W end panel. |
| LU1 Worksurface, 1 1/4" thick | A- worksurface includes one edge grommet | |
| S Straight worksurface | B- worksurface does not include grommets | Options worksurfaces cannot be used in conjunction with Network desk supports. |
| 38 Width | Specify surface finish. | |
| 36 Depth | 1 1/4" Options worksurfaces are 3-ply, solid core construction with pilot holes at all pedestal, end panel, and bracket locations. | All straight worksurfaces are 3/8" less than nominal depth for rear wire clearance. |
| B No grommets | Edge grommets are centered at rear of worksurface. | |
| Q Standard Specials | | Panel-supported 1 1/4" worksurfaces over 48" must be mid-span supported by MB2-C24 bracket, specified separately. |
| 117 Surface finish | | |
| | | Suspended pedestals may not be used with 1 1/4" worksurfaces. |

Morrison Options Worksurfaces, 1 1/4"
Rounded end 30" and 36"D

Standard Specials Systems

| description | type | w | d | h | pattern no. | lam. | V1 | V2 |
|------------------|-------------|-----|-----|--------|------------------------------|--------|----------|----------|
| 30"D rounded end | No Grommets | 87" | 30" | 1 1/4" | LU1-R8730B-(L/R)-Q-() | \$996. | \$1,457. | \$2,276. |
| 36"D rounded end | No Grommets | 66" | 36" | 1 1/4" | LU1-R6636B-(L/R)-Q-() | 961. | 1,422. | 2,217. |
| | No Grommets | 78" | 36" | 1 1/4" | LU1-R7836B-(L/R)-Q-() | 1,020. | 1,481. | 2,312. |
| | No Grommets | 90" | 36" | 1 1/4" | LU1-R9036B-(L/R)-Q-() | 1,138. | 1,599. | 2,500. |

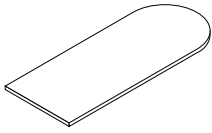

| Order Code | Specification Information | Application Notes |
|--|--|--|
| Example: LU1-R8730B-L-Q-117 | B- worksurface does not include grommets. | Rounded end worksurfaces may be supported by 30" end support brackets, 30" flat bracket or 30" conference end panel, and by a support column at the rounded end. Suspended pedestals may not be used with 1 1/4" worksurfaces. Conference worksurfaces must be supported by support column and flat bracket or bridging bracket to adjacent desk. |
| LU1 Options worksurface, 1 1/4" thick | Specify surface finish. | |
| R Rounded end | | |
| 87 Width | 1 1/4" worksurfaces are 3-ply, solid core construction. Plastic laminate worksurfaces have radiused T mold edge. | |
| 30 Depth | Rounded end worksurfaces have a flat self-edge in the straight end. | |
| B No grommets | | |
| L Left hand | | |
| Q Standard Special | | |
| 117 Surface finish | | |

Morrison Options Worksurfaces, 1 1/4"

P-shape curvilinear

Standard Specials Systems

| description | type | w | d | h | pattern no. | lam. | V1 | V2 |
|------------------|-------------|-----|-----|--------|--------------------------|----------|----------|----------|
| Rounded end left | 24"D return | 48" | 72" | 1 1/4" | LU1-P72SA-L-Q-() | \$1,434. | \$1,841. | \$2,580. |
| | 30"D return | 48" | 78" | 1 1/4" | LU1-P78DA-L-Q-() | 1,494. | 1,922. | 2,690. |

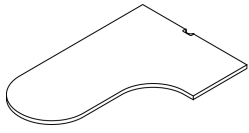

| | | | | | | | | |
|-------------------|-------------|-----|-----|--------|--------------------------|--------|--------|--------|
| Rounded end right | 24"D return | 48" | 72" | 1 1/4" | LU1-P72SA-R-Q-() | 1,434. | 1,841. | 2,580. |
| | 30"D return | 48" | 78" | 1 1/4" | LU1-P78DA-R-Q-() | 1,494. | 1,922. | 2,690. |

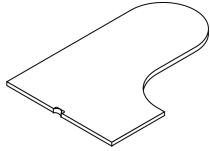

Order Code

| | |
|------------|--------------------------|
| Example: | LU1-P72SA-L-Q-117 |
| LU1 | Worksurface, 1 1/4" |
| P | P-shape curvilinear |
| 72 | Overall length |
| S | Depth of return |
| A | Grommets |
| L | Rounded end left |
| Q | Standard Special |
| 117 | Surface finish |

Specification Information

| | |
|----|--|
| S- | 24"D side edge |
| D- | 30"D side edge |
| | Specify surface finish. |
| | 1 1/4" curvilinear surfaces are solid core construction with threaded metal inserts at desk support and all bracket locations. |
| | All worksurfaces are U.L.-listed. |

Application Notes

P-shape curvilinear worksurfaces may be used interchangeably in desk and panel system applications. They may be supported by a 48" VDT support bracket kit, or 48" desk support and 6" end panel, in conjunction with rounded end support column. Use flat bracket or bridging bracket to join to adjacent 1 1/4" worksurface.

P-shape laminate surfaces have continuous T-mold edge in profile to match adjacent 1 1/4" worksurfaces.

Morrison Options Worksurfaces, 1 1/4"

L-shape curvilinear

Standard Specials Systems

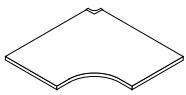
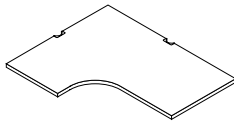
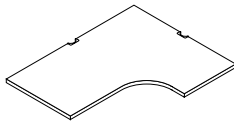
| description | type | w | d | h | pattern no. | lam. | V1 | V2 |
|---|------------|--------|-------------------------|--------|-------------------------|--------|----------|----------|
| 24"D returns left and right  | 2 Grommets | 42" | 48" | 1 1/4" | LU1-C4248SS-Q(-) | \$791. | \$1,076. | \$1,581. |
| | | 42" | 60" | 1 1/4" | LU1-C4260SS-Q(-) | 897. | 1,219. | 1,797. |
| | | 42" | 66" | 1 1/4" | LU1-C4266SS-Q(-) | 964. | 1,311. | 1,933. |
| | | 42" | 72" | 1 1/4" | LU1-C4272SS-Q(-) | 1,031. | 1,403. | 2,069. |
| | | 48" | 42" | 1 1/4" | LU1-C4842SS-Q(-) | 791. | 1,076. | 1,581. |
| | | 48" | 66" | 1 1/4" | LU1-C4866SS-Q(-) | 1,031. | 1,403. | 2,069. |
| | | 60" | 42" | 1 1/4" | LU1-C6042SS-Q(-) | 897. | 1,219. | 1,797. |
| | | 66" | 42" | 1 1/4" | LU1-C6642SS-Q(-) | 964. | 1,311. | 1,933. |
| | | 66" | 48" | 1 1/4" | LU1-C6648SS-Q(-) | 1,031. | 1,403. | 2,069. |
| | | 72" | 42" | 1 1/4" | LU1-C7242SS-Q(-) | 1,031. | 1,403. | 2,069. |
| 24"D returns left, 30"D right  | 2 Grommets | 42" | 42" | 1 1/4" | LU1-C4242SD-Q(-) | 738. | 1,005. | 1,474. |
| | | 42" | 48" | 1 1/4" | LU1-C4248SD-Q(-) | 791. | 1,076. | 1,581. |
| | | 42" | 60" | 1 1/4" | LU1-C4260SD-Q(-) | 897. | 1,219. | 1,797. |
| | | 42" | 66" | 1 1/4" | LU1-C4266SD-Q(-) | 964. | 1,311. | 1,933. |
| | | 42" | 72" | 1 1/4" | LU1-C4272SD-Q(-) | 1,031. | 1,403. | 2,069. |
| | | 48" | 42" | 1 1/4" | LU1-C4842SD-Q(-) | 791. | 1,076. | 1,581. |
| | | 48" | 66" | 1 1/4" | LU1-C4866SD-Q(-) | 1,031. | 1,403. | 2,069. |
| | | 60" | 42" | 1 1/4" | LU1-C6042SD-Q(-) | 897. | 1,219. | 1,797. |
| | | 66" | 42" | 1 1/4" | LU1-C6642SD-Q(-) | 964. | 1,311. | 1,933. |
| | | 66" | 48" | 1 1/4" | LU1-C6648SD-Q(-) | 1,031. | 1,403. | 2,069. |
| 72" | 42" | 1 1/4" | LU1-C7242SD-Q(-) | 1,031. | 1,403. | 2,069. | | |
| 30"D returns left, 24"D right  | 2 Grommets | 42" | 42" | 1 1/4" | LU1-C4242DS-Q(-) | 738. | 1,005. | 1,474. |
| | | 42" | 48" | 1 1/4" | LU1-C4248DS-Q(-) | 791. | 1,076. | 1,581. |
| | | 42" | 60" | 1 1/4" | LU1-C4260DS-Q(-) | 897. | 1,219. | 1,797. |
| | | 42" | 66" | 1 1/4" | LU1-C4266DS-Q(-) | 964. | 1,311. | 1,933. |
| | | 42" | 72" | 1 1/4" | LU1-C4272DS-Q(-) | 1,031. | 1,403. | 2,069. |
| | | 48" | 42" | 1 1/4" | LU1-C4842DS-Q(-) | 791. | 1,076. | 1,581. |
| | | 48" | 66" | 1 1/4" | LU1-C4866DS-Q(-) | 1,031. | 1,403. | 2,069. |
| | | 60" | 42" | 1 1/4" | LU1-C6042DS-Q(-) | 897. | 1,219. | 1,797. |
| | | 66" | 42" | 1 1/4" | LU1-C6642DS-Q(-) | 964. | 1,311. | 1,933. |
| | | 66" | 48" | 1 1/4" | LU1-C6648DS-Q(-) | 1,031. | 1,403. | 2,069. |
| 72" | 42" | 1 1/4" | LU1-C7242DS-Q(-) | 1,031. | 1,403. | 2,069. | | |

Order Code

| | |
|------------|-----------------------------|
| Example: | LU1-C4866SD-Q-117 |
| LU1 | Options worksurface, 1 1/4" |
| C | L-shape curvilinear |
| 48 | Width left |
| 66 | Width right |
| S | Depth of left return |
| D | Depth of right return |
| Q | Standard Special |
| 117 | Surface finish |

Specification Information

Width dimension (W) refers to width of left-side back edge; depth dimension (D) indicates width of right-side back edge.

S- 24"D side edge
D- 30"D side edge

Specify surface finish.

1 1/4" curvilinear surfaces are solid core construction with pilot holes at all bracket locations.

Application Notes

Options L-shaped curvilinear worksurfaces may be supported by left- or right-hand cantilever brackets at the rear corner and cantilever bridging bracket on each side edge. Use mid-span support whenever Options worksurfaces span more than 48".

L-shape surfaces are veneer or post-formed plastic laminate on both back edges, matching profile T-mold on curvilinear front, and self-edge on sides.

Curvilinear worksurfaces are available only in 1 1/4" thickness.

L-shape surfaces are 3/8" less than nominal depth for rear wire clearance or privacy screens.

Morrison Options Worksurfaces, 1 1/4"

L-shape curvilinear

Standard Specials Systems

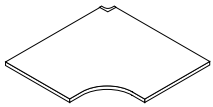
| description | type | w | d | h | pattern no. | lam. | V1 | V2 |
|--|-----------------|-----|-----|--------|--------------------------|--------|----------|----------|
| 30"D returns left and right  | Corner Grommets | 42" | 42" | 1 1/4" | LU1-C4242DD-Q-() | \$738. | \$1,005. | \$1,474. |
| | 2 Grommets | 42" | 48" | 1 1/4" | LU1-C4248DD-Q-() | 791. | 1,076. | 1,581. |
| | | 42" | 60" | 1 1/4" | LU1-C4260DD-Q-() | 897. | 1,219. | 1,797. |
| | | 42" | 66" | 1 1/4" | LU1-C4266DD-Q-() | 964. | 1,311. | 1,933. |
| | | 42" | 72" | 1 1/4" | LU1-C4272DD-Q-() | 1,031. | 1,403. | 2,069. |
| | | 48" | 42" | 1 1/4" | LU1-C4842DD-Q-() | 791. | 1,076. | 1,581. |
| | | 48" | 60" | 1 1/4" | LU1-C4860DD-Q-() | 964. | 1,311. | 1,933. |
| | | 48" | 66" | 1 1/4" | LU1-C4866DD-Q-() | 1,031. | 1,403. | 2,069. |
| | | 48" | 72" | 1 1/4" | LU1-C4872DD-Q-() | 1,099. | 1,495. | 2,204. |
| | | 60" | 42" | 1 1/4" | LU1-C6042DD-Q-() | 897. | 1,219. | 1,797. |
| | | 60" | 48" | 1 1/4" | LU1-C6048DD-Q-() | 964. | 1,311. | 1,933. |
| | | 66" | 42" | 1 1/4" | LU1-C6642DD-Q-() | 964. | 1,311. | 1,933. |
| | | 66" | 48" | 1 1/4" | LU1-C6648DD-Q-() | 1,031. | 1,403. | 2,069. |
| | | 72" | 42" | 1 1/4" | LU1-C7242DD-Q-() | 1,031. | 1,403. | 2,069. |
| | | 72" | 48" | 1 1/4" | LU1-C7248DD-Q-() | 1,099. | 1,495. | 2,204. |

Morrison System

| Order Code | Specification Information | Application Notes |
|--|--|--|
| Example: LU1-C4866SD-Q-117 | Width dimension (W) refers to width of left-side back edge; depth dimension (D) indicates width of right-side back edge. | Options L-shaped curvilinear worksurfaces may be supported by left- or right-hand cantilever brackets at the rear corner and cantilever bridging bracket on each side edge. Use mid-span support whenever Options worksurfaces span more than 48". |
| LU1 Options worksurface, 1 1/4" | | |
| C L-shape curvilinear | S- 24"D side edge | L-shape surfaces are veneer or post-formed plastic laminate on both back edges, matching profile T-mold on curvilinear front, and self-edge on sides. |
| 48 Width left | D- 30"D side edge | |
| 66 Width right | Specify surface finish. | |
| S Depth of left return | 1 1/4" curvilinear surfaces are solid core construction with pilot holes at all bracket locations. | |
| D Depth of right return | | |
| Q Standard Special | | |
| 117 Surface finish | | |

Curvilinear worksurfaces are available only in 1 1/4" thickness.

L-shape surfaces are 3/8" less than nominal depth for rear wire clearance or privacy screens.

Morrison Options Worksurfaces, 1 1/4"

J-shape surfaces

Standard Specials Systems

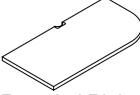

| description | w | d | h | pattern no. | lam. | V1 | V2 |
|--|-----|---------|--------|-----------------------------|--------|--------|--------|
| J-shape - Rounded left/right | 24" | 23 3/8" | 1 1/4" | LU1-J24A-(L/R)-Q-() | \$489. | \$597. | \$806. |
|  Rounded Left | 30" | 23 3/8" | 1 1/4" | LU1-J30A-(L/R)-Q-() | 530. | 647. | 873. |
| | 36" | 23 3/8" | 1 1/4" | LU1-J36A-(L/R)-Q-() | 571. | 696. | 940. |
| | 42" | 23 3/8" | 1 1/4" | LU1-J42A-(L/R)-Q-() | 607. | 740. | 998. |
| | 48" | 23 3/8" | 1 1/4" | LU1-J48A-(L/R)-Q-() | 643. | 785. | 1,060. |
|  Rounded Right | 54" | 23 3/8" | 1 1/4" | LU1-J54A-(L/R)-Q-() | 702. | 867. | 1,178. |
| | 60" | 23 3/8" | 1 1/4" | LU1-J60A-(L/R)-Q-() | 761. | 950. | 1,296. |
| | 66" | 23 3/8" | 1 1/4" | LU1-J66A-(L/R)-Q-() | 820. | 1,033. | 1,414. |
| | 72" | 23 3/8" | 1 1/4" | LU1-J72A-(L/R)-Q-() | 879. | 1,115. | 1,532. |
| | 78" | 23 3/8" | 1 1/4" | LU1-J78A-(L/R)-Q-() | 938. | 1,198. | 1,650. |
| | 84" | 23 3/8" | 1 1/4" | LU1-J84A-(L/R)-Q-() | 997. | 1,280. | 1,768. |
| | 90" | 23 3/8" | 1 1/4" | LU1-J90A-(L/R)-Q-() | 1,056. | 1,363. | 1,886. |
| | 96" | 23 3/8" | 1 1/4" | LU1-J96A-(L/R)-Q-() | 1,115. | 1,446. | 2,004. |

| Order Code | Specification Information | Application Notes |
|----------------------------------|---|--|
| Example: LU1-J36A-L-Q-117 | 1 1/4" curvilinear surfaces are solid core construction with pilot holes at bracket and pedestal locations. | J-shape curvilinear worksurfaces may be used interchangeably in desk and panel system applications. They may be supported by straight desk support or cantilever brackets. J-shapes also require 9" Network end panel in desk or panel planning. |
| LU1 Worksurface, 1 1/4" | | |
| J J-shape | | |
| 36 Width | | |
| A With grommets | A- Worksurface includes one edge grommet | |
| L Left | | |
| Q Standard Special | Specify surface finish. | Use flat bracket or bridging bracket to join to adjacent 1 1/4" worksurface. Also specify VDT end support bracket kit for optimal stability of vertical panel behind J-shape worksurface. |
| 117 Surface finish | Edge grommet is centered at rear of worksurface. | J-shape surfaces are post-formed on back edge, matching profile T-mold on curvilinear front, and self-edge on sides. |
| | | J-shapes are available only in plastic laminate, 1 1/4" thickness. |
| | | J-shape surfaces are 3/8" less than nominal depth for wire clearance or privacy screens. |

Morrison Options Worksurfaces, 1 1/4"

Wave-end surfaces

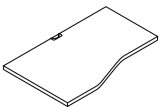
Standard Specials Systems

| description | width | depth | height | pattern number | lam. |
|---|-------|---------|--------|----------------------|--------|
| Wave-end left/right | 30" | 29 5/8" | 1 1/4" | LU1-W30A-(L/R)-Q-() | \$607. |
|  Wave-end Left | 36" | 29 5/8" | 1 1/4" | LU1-W36A-(L/R)-Q-() | 643. |
| | 42" | 29 5/8" | 1 1/4" | LU1-W42A-(L/R)-Q-() | 680. |
| | 48" | 29 5/8" | 1 1/4" | LU1-W48A-(L/R)-Q-() | 719. |
| | 54" | 29 5/8" | 1 1/4" | LU1-W54A-(L/R)-Q-() | 778. |
|  Wave-end Right | 60" | 29 5/8" | 1 1/4" | LU1-W60A-(L/R)-Q-() | 837. |
| | 66" | 29 5/8" | 1 1/4" | LU1-W66A-(L/R)-Q-() | 896. |
| | 72" | 29 5/8" | 1 1/4" | LU1-W72A-(L/R)-Q-() | 955. |
| | 78" | 29 5/8" | 1 1/4" | LU1-W78A-(L/R)-Q-() | 1,014. |
| | 84" | 29 5/8" | 1 1/4" | LU1-W84A-(L/R)-Q-() | 1,073. |
| | 90" | 29 5/8" | 1 1/4" | LU1-W90A-(L/R)-Q-() | 1,132. |
| | 96" | 29 5/8" | 1 1/4" | LU1-W96A-(L/R)-Q-() | 1,191. |

Morrison System

| Order Code | Specification Information | Application Notes |
|--|---|---|
| Example: LU1-W42AL-Q-117 | 1 1/4" curvilinear surfaces are solid core construction with pilot holes at bracket and pedestal locations. | Options wave-end curvilinear worksurfaces are for panel planning only and cannot be used in conjunction with Network desk supports. |
| LU1 Options worksurface, 1 1/4" | | |
| W Wave-end curvilinear | <i>Grommets/no grommets:</i> | |
| 42 Width | A- Worksurface includes one edge grommet | Use cantilever bridging bracket to join to adjacent 1 1/4" worksurface. |
| A With grommets | | Wave-end surfaces are post-formed on back edge, matching profile T-mold on curvilinear front, and self-edge on sides. |
| L Left | Specify surface finish. | |
| Q Standard Special | Edge grommet is centered at rear of worksurface. | Wave-end surfaces are available only in plastic laminate, 1 1/4" thickness. |
| 117 Surface finish | | Wave-end surfaces are nominal 30"D at left or right, and align with 24"D surface at the other end. |

Currents System worksurfaces
curved, flat front and counter surface
1 3/4" wire drop

Standard Specials Systems

| description | width | depth | pattern number | lam. | V1 | V2 |
|---|-------|-------|-----------------------|--------|--------|--------|
| 30"D straight worksurface, curved front | 24" | 30" | AW1-S2430Q() | \$359. | \$581. | \$771. |
| | 30" | 30" | AW1-S3030Q() | 418. | 627. | 833. |
| | 42" | 30" | AW1-S4230Q() | 478. | 719. | 959. |
| | 54" | 30" | AW1-S5430Q() | 558. | 833. | 1,113. |
| | 66" | 30" | AW1-S6630Q() | 649. | 972. | 1,299. |
| | 78" | 30" | AW1-S7830Q() | 745. | 1,114. | 1,487. |
| 24"D straight worksurface, curved front | 54" | 24" | AW1-S5424Q() | 494. | 742. | 990. |
| | 78" | 24" | AW1-S7824Q() | 620. | 929. | 1,235. |
| 30"D straight worksurface, flat front | 24" | 30" | AW1-F2430Q() | 359. | 581. | 771. |
| | 30" | 30" | AW1-F3030Q() | 418. | 627. | 833. |
| | 42" | 30" | AW1-F4230Q() | 478. | 719. | 959. |
| | 54" | 30" | AW1-F5430Q() | 558. | 833. | 1,113. |
| | 66" | 30" | AW1-F6630Q() | 649. | 972. | 1,299. |
| | 78" | 30" | AW1-F7830Q() | 745. | 1,114. | 1,487. |
| Counter surface | 24" | 12" | AW1-CS2412Q() | 248. | 392. | 527. |
| | 30" | 12" | AW1-CS3012Q() | 278. | 415. | 558. |
| | 42" | 12" | AW1-CS4212Q() | 309. | 464. | 620. |
| | 54" | 12" | AW1-CS5412Q() | 340. | 510. | 682. |
| | 66" | 12" | AW1-CS6612Q() | 372. | 558. | 740. |

| Order Code | Specification Information | Application Notes |
|---------------------------------|----------------------------------|---|
| Example: AW1 S2430-Q-119 | Worksurface edges are trim grey. | Worksurfaces may be end-supported, cantilevered from Currents service wall, or supported by C-leg or pedestal at each end. Universal worksurfaces are interchangeable with Currents desks. Specify supports separately. |
| AW1 Worksurface | <i>Specify top finish</i> | 24"D straight worksurfaces may be cantilevered with two cantilever brackets. |
| S Straight | | 24" and 30"D straight worksurfaces may be end supported with two Currents end support brackets. |
| 24 Width | | Universal straight worksurfaces 36" wide and greater include a steel stiffener that doubles as a horizontal cable manager. |
| 30 Depth | | Counter surface with curved front is designed to mount on either side of 39"H wall crown with counter surface brackets. |
| Q Standard Special | | |
| 119 Top finish | | |

| description | type | width | depth | height | pattern number | P1 | V1 | V2 |
|-------------------|-------------|-------|--------|--------|----------------------------|----------|----------|----------|
| VDT corner panels | Desk height | 48" | 1 1/4" | 24" | MK4-V2448-P/V-Q-() | \$1,160. | \$1,493. | \$2,115. |
| | Desk height | 48" | 1 1/4" | 26" | MK4-V2648-P/V-Q-() | 1,298. | 1,670. | 2,359. |

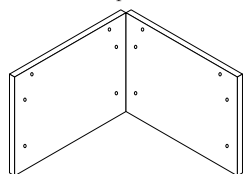

| | | | | | | | | |
|----------------------------|-------------|-----|--------|-----|----------------------------|------|------|--------|
| VDT transitional end panel | Desk height | 48" | 1 1/8" | 24" | MK4-X2448-P/V-Q-() | 598. | 754. | 1,038. |
| | Desk height | 48" | 1 1/8" | 26" | MK4-X2648-P/V-Q-() | 616. | 837. | 1,153. |

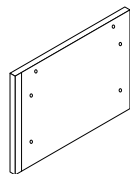

Morrison System

| Order Code | Specification Information | Application Notes |
|-----------------------------------|---------------------------|---|
| Example: MK4-V2648-P-Q-612 | <i>Surface type:</i> | VDT corner panels are wood desk panels ordered and shipped in pairs: one left and one right. |
| MK4 Desk panel | P- Painted | |
| V Desk panel type | V- Veneer | VDT corner end panels include 2 MB1-T brackets, VDT corner end panels/worksurface and bracket MB1-L1, filler/desk end panel. |
| 26 Height | | |
| 48 Width | | VDT transitional end panels are used when one back edge of a VDT surface is supported by a vertical panel. |
| P Surface type | | |
| Q Standard Special | | |
| 612 Finish | | |

A VDT transitional end panel includes bracket MB1-T, desk end panel/ worksurface. Specify bracket MB1-W 18 or 20(L or R) separately.

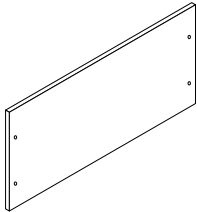
| description | type | width | depth | height | pattern number | P1 | V1 | V2 |
|--|-------------|-------|--------|--------|-----------------------------|--------|--------|--------|
| Kneehole filler  | Desk height | 18" | 1 1/8" | 26" | MK4-K1826-P/V-Q-() | \$157. | \$372. | \$576. |
| | | 24" | 1 1/8" | 26" | MK4-K2426-P/V-Q-() | 216. | 435. | 658. |
| | | 30" | 1 1/8" | 26" | MK4-K3026-P/V-Q-() | 275. | 499. | 741. |
| | | 36" | 1 1/8" | 26" | MK4-K3626-P/V-Q-() | 334. | 563. | 824. |
| | | 42" | 1 1/8" | 26" | MK4-K4226-P/V-Q-() | 393. | 627. | 906. |
| | | 48" | 1 1/8" | 26" | MK4-K4826-P/V-Q-() | 452. | 690. | 989. |
| | | 54" | 1 1/8" | 26" | MK4-K5426-P/V-Q-() | 511. | 754. | 1,071. |
| | | 84" | 1 1/8" | 26" | MK4-K8426-P/V-Q-() | 807. | 1,047. | 1,497. |
| | | 90" | 1 1/8" | 26" | MK4-K9026-P/V-Q-() | 892. | 1,156. | 1,654. |
| | | 96" | 1 1/8" | 26" | MK4-K9626-P/V-Q-() | 977. | 1,266. | 1,811. |
| | | 102" | 1 1/8" | 26" | MK4-K10226-P/V-Q-() | 1,062. | 1,376. | 1,968. |
| | | 108" | 1 1/8" | 26" | MK4-K10826-P/V-Q-() | 1,147. | 1,486. | 2,125. |
| | | 114" | 1 1/8" | 26" | MK4-K11426-P/V-Q-() | 1,232. | 1,595. | 2,282. |
| | | 120" | 1 1/8" | 26" | MK4-K12026-P/V-Q-() | 1,317. | 1,705. | 2,439. |

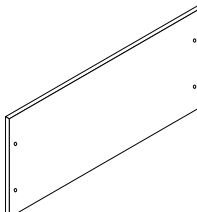
| description | type | width | depth | height | pattern number | P1 | V1 | V2 |
|--|-------------|-------|--------|--------|-----------------------------|--------|--------|--------|
| Transitional filler  | Desk height | 18" | 1 1/8" | 26" | MK4-T1826-P/V-Q-() | 157. | 372. | 576. |
| | | 24" | 1 1/8" | 26" | MK4-T2426-P/V-Q-() | 216. | 435. | 658. |
| | | 30" | 1 1/8" | 26" | MK4-T3026-P/V-Q-() | 275. | 499. | 741. |
| | | 36" | 1 1/8" | 26" | MK4-T3626-P/V-Q-() | 334. | 563. | 824. |
| | | 42" | 1 1/8" | 26" | MK4-T4226-P/V-Q-() | 393. | 627. | 906. |
| | | 48" | 1 1/8" | 26" | MK4-T4826-P/V-Q-() | 452. | 690. | 989. |
| | | 54" | 1 1/8" | 26" | MK4-T5426-P/V-Q-() | 511. | 754. | 1,071. |
| | | 84" | 1 1/8" | 26" | MK4-T8426-P/V-Q-() | 807. | 1,047. | 1,497. |
| | | 90" | 1 1/8" | 26" | MK4-T9026-P/V-Q-() | 892. | 1,156. | 1,654. |
| | | 96" | 1 1/8" | 26" | MK4-T9626-P/V-Q-() | 977. | 1,266. | 1,811. |
| | | 102" | 1 1/8" | 26" | MK4-T10226-P/V-Q-() | 1,062. | 1,376. | 1,968. |
| | | 108" | 1 1/8" | 26" | MK4-T10826-P/V-Q-() | 1,147. | 1,486. | 2,125. |
| | | 114" | 1 1/8" | 26" | MK4-T11426-P/V-Q-() | 1,232. | 1,595. | 2,282. |
| | | 120" | 1 1/8" | 26" | MK4-T12026-P/V-Q-() | 1,317. | 1,705. | 2,439. |

| Order Code | Specification Information |
|-----------------------------------|---------------------------|
| Example: MK4-T5426-P-Q-612 | P- Painted |
| MK4 Desk panel | V- Veneer |
| T Desk panel type | |
| 54 Width | |
| 26 Height | |
| P Surface type | |
| Q Standard Special | |
| 612 Finish | |

Specification Information

P- Painted
V- Veneer

Application Notes

Kneehole filler panels span use between two universal desk end panels to construct a freestanding wood desk.

A kneehole panel includes 2 brackets MB1-L1, filler panel/desk end panel.

All 69", 75" and 84" w kneehole filler panels are shipped with a center stabilizing bracket, MB1-AUX-D.

Transitional filler panels are used between a universal desk end panel and a vertical panel.

A transitional filler panel includes bracket MB1-L1, filler panel/desk end panel. Specify bracket MB1-W 18 or 20(L or R) separately.

A transitional filler panel over 84" w is shipped with a center stabilizing bracket, MB1-AUX-D.

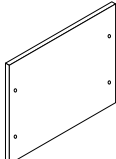
| description | type | width | depth | height | pattern number | P1 | V1 | V2 |
|--|-------------|-------|--------|--------|---------------------------------|--------|--------|--------|
| Return filler  | Desk height | 18" | 1 1/8" | 26" | MK4-R1826-P/V-L/R-Q-() | \$389. | \$506. | \$720. |
| | | 24" | 1 1/8" | 26" | MK4-R2426-P/V-L/R-Q-() | 406. | 550. | 784. |
| | | 54" | 1 1/8" | 26" | MK4-R5426-P/V-L/R-Q-() | 552. | 841. | 1,154. |
| | | 78" | 1 1/8" | 26" | MK4-R7826-P/V-L/R-Q-() | 787. | 1,080. | 1,530. |
| | | 84" | 1 1/8" | 26" | MK4-R8426-P/V-L/R-Q-() | 872. | 1,198. | 1,698. |
| | | 90" | 1 1/8" | 26" | MK4-R9026-P/V-L/R-Q-() | 957. | 1,316. | 1,866. |
| | | 96" | 1 1/8" | 26" | MK4-R9626-P/V-L/R-Q-() | 1,042. | 1,434. | 2,033. |
| | | 102" | 1 1/8" | 26" | MK4-R10226-P/V-L/R-Q-() | 1,127. | 1,552. | 2,201. |
| | | 108" | 1 1/8" | 26" | MK4-R10826-P/V-L/R-Q-() | 1,212. | 1,670. | 2,368. |
| | | 114" | 1 1/8" | 26" | MK4-R11426-P/V-L/R-Q-() | 1,297. | 1,788. | 2,536. |
| | | 120" | 1 1/8" | 26" | MK4-R12026-P/V-L/R-Q-() | 1,382. | 1,906. | 2,703. |

| Order Code | Specification Information | Application Notes |
|-------------------------------------|------------------------------------|--|
| Example: MK4-R2426-P-L-Q-612 | | |
| MK4 Desk panel | <i>Return filler panel widths:</i> | Return filler panels provide enclosure between a universal desk end panel and the end panel of a return. Return filler panels may also be connected to a vertical panel to provide enclosure for a desk or machine height return off a panel supported workstation. Specify MB1-FV brackets separately. All 69", 75" and 78"W return filler panels are shipped with a center stabilizing bracket, MB1-AUX-D. A return filler panel includes bracket MB1-L1, filler panel/desk end panel and all connecting hardware. |
| R Desk panel type | 32 3/4" | |
| 24 Width | 30" | |
| 26 Height | 36" | |
| P Surface type | 38 3/4" | |
| L Left | 44 3/4" | |
| Q Standard Special | 50 3/4" | |
| 612 Paint | 48" | |
| | 62 3/4" | |
| | 60" | |
| | 68 3/4" | |
| | 66" | |
| | 74 3/4" | |
| | 72" | |
| | <i>Bridge filler panel widths:</i> | |
| | 38 1/2" | |
| | 30" | |
| | 44 1/2" | |
| | 36" | |
| | 50 1/2" | |
| | 42" | |
| | 56 1/2" | |
| | 48" | |
| | 68 1/2" | |
| | 60" | |
| | 74 1/2" | |
| | 66" | |
| | 80 1/2" | |
| | 72" | |
| | <i>Surface type:</i> | |
| | P- Painted | |
| | V- Veneer | |

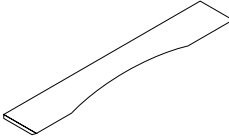
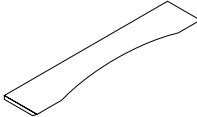
| description | type | width | depth | height | pattern no. | P2 |
|---|------|-------|-------|--------|------------------------|--------|
| Full width  | 42" | 42" | 10" | 3/4" | MM3-IS42F-Q-() | \$293. |
| | 48" | 48" | 10" | 3/4" | MM3-IS48F-Q-() | 345. |
| | 54" | 54" | 10" | 3/4" | MM3-IS54F-Q-() | 396. |
| | 84" | 84" | 10" | 3/4" | MM3-IS84F-Q-() | 647. |
| | 90" | 90" | 10" | 3/4" | MM3-IS90F-Q-() | 721. |
| | 96" | 96" | 10" | 3/4" | MM3-IS96F-Q-() | 795. |
| Returns  | 54" | 54" | 10" | 3/4" | MM3-IS54R-Q-() | 349. |
| | 84" | 84" | 10" | 3/4" | MM3-IS84R-Q-() | 548. |
| | 90" | 90" | 10" | 3/4" | MM3-IS90R-Q-() | 597. |
| | 96" | 96" | 10" | 3/4" | MM3-IS96R-Q-() | 647. |

| Order Code | |
|---------------------------------|----------------------|
| Example: MM3-IS54R-612-Q | |
| MM3 | Accessory |
| IS | Intermediate shelves |
| 54 | Width |
| R | Return |
| 612 | Paint finish |
| Q | Standard Special |

Specification Information

Specify paint finish.

Specify return shelves by number that corresponds to total return dimension (depth of desk and width of return).

Application Notes

Intermediate shelves provide an additional level of storage between the worksurface and standard overhead storage.

Intermediate shelves include brackets for cantilever support from vertical panel connector tracks.

Intermediate shelves may be mounted on 1" increments of height up to 1" from top of panel. Recommended position is 6" - 7" above the worksurface.

Use full width shelves with back panels of the same total width. Add returns to form a continuous "L". Half-round endpiece joins back-to-back shelves over a half-round conference worksurface. Quarter round terminates an intermediate shelf at a straight panel connection.

Intermediate shelves cannot be mounted to freestanding desks or overhead supports.

Use full width intermediate shelves that correspond with actual workstation width.

Morrison shelves and flush counter surface, 1 3/4" panel or wall mounted lam. and ven. shelves

Standard Specials Systems

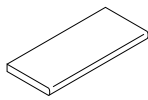
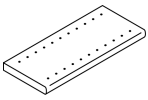
| description | type | w | d | h | pattern no. | lam. | V1 | V2 |
|--|--|------|-----|--------|---------------------------|--------|--------|----------|
| Panel mounted shelves and flush counter surfaces | without holes  | 54" | 13" | 1 3/4" | MS2-W5413-Q-() | \$471. | \$840. | \$1,204. |
| | | 96" | 13" | 1 3/4" | MS2-W9613-Q-() | 741. | 1,331. | 1,886. |
| | | 102" | 13" | 1 3/4" | MS2-W10213-Q-() | 800. | 1,416. | 1,998. |
| | | 108" | 13" | 1 3/4" | MS2-W10813-Q-() | 859. | 1,501. | 2,110. |
| | | 114" | 13" | 1 3/4" | MS2-W11413-Q-() | 918. | 1,586. | 2,222. |
| | | 120" | 13" | 1 3/4" | MS2-W12013-Q-() | 977. | 1,671. | 2,334. |
| | with holes  | 54" | 13" | 1 3/4" | MS2-W5413-H-Q-() | 486. | 856. | 1,219. |
| | | 96" | 13" | 1 3/4" | MS2-W9613-H-Q-() | 758. | 1,348. | 1,897. |
| | | 102" | 13" | 1 3/4" | MS2-W10213-H-Q-() | 817. | 1,433. | 2,010. |
| | | 108" | 13" | 1 3/4" | MS2-W10813-H-Q-() | 876. | 1,517. | 2,122. |
| | | 114" | 13" | 1 3/4" | MS2-W11413-H-Q-() | 935. | 1,602. | 2,234. |
| | | 120" | 13" | 1 3/4" | MS2-W12013-H-Q-() | 994. | 1,687. | 2,346. |

Morrison System

| Order Code | Specification Information | Application Notes |
|-----------------------------------|---|---|
| Example: MS2-W5413-H-Q-612 | <i>Specify paint finish for brackets and steel shelves.</i> | 13"D shelves hold binders, books and other reference material. Order brackets and shelf organizers, if applicable, separately. |
| MS2W Shelf | | |
| 54 Width | | |
| 13 Depth | | |
| H With holes | | |
| Q Standard Special | | |
| 612 Surface finish | | Standard 13" deep shelves double as flush counter surfaces. Specify undershelf or transaction shelf brackets for this application. Each set supports a maximum span of 48". Shelves over 60"W require MB1-AUX-S auxiliary support brackets. |

All shelf brackets accept task light fixtures with the exception of the transaction shelf brackets MB2-TS-(). Adjacent bookend-style shelf brackets require MB1-TC tie clip to secure full-width task light.

Desk mounted counter surfaces do not accept task lights.

Morrison shelves and flush counter surface, 1 1/4"
panel or wall mounted lam. and ven. shelves

Standard Specials Systems

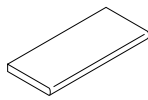
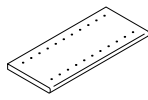
| description | type | w | d | h | pattern no. | lam. | V1 | V2 |
|---|--|------|-----|--------|---------------------------|--------|--------|----------|
| Panel mounted shelves and flush counter surfaces | without holes  | 54" | 13" | 1 1/4" | MS2-U5413-Q-() | \$395. | \$700. | \$1,024. |
| | | 96" | 13" | 1 1/4" | MS2-U9613-Q-() | 608. | 1,033. | 1,501. |
| | | 102" | 13" | 1 1/4" | MS2-U10213-Q-() | 667. | 1,092. | 1,584. |
| | | 108" | 13" | 1 1/4" | MS2-U10813-Q-() | 726. | 1,151. | 1,666. |
| | | 114" | 13" | 1 1/4" | MS2-U11413-Q-() | 785. | 1,210. | 1,749. |
| | | 120" | 13" | 1 1/4" | MS2-U12013-Q-() | 844. | 1,269. | 1,831. |
| | with holes  | 54" | 13" | 1 1/4" | MS2-U5413-H-Q-() | 412. | 716. | 1,040. |
| | | 96" | 13" | 1 1/4" | MS2-U9613-H-Q-() | 624. | 1,045. | 1,519. |
| | | 102" | 13" | 1 1/4" | MS2-U10213-H-Q-() | 683. | 1,104. | 1,601. |
| | | 108" | 13" | 1 1/4" | MS2-U10813-H-Q-() | 742. | 1,163. | 1,684. |
| | | 114" | 13" | 1 1/4" | MS2-U11413-H-Q-() | 801. | 1,222. | 1,766. |
| | | 120" | 13" | 1 1/4" | MS2-U12013-H-Q-() | 860. | 1,281. | 1,849. |

Order Code

| | |
|------------|---------------------------|
| Example: | MS2-U-5413-H-Q-612 |
| MS2 | Shelf |
| U | 1 1/4" thick |
| 54 | Width |
| 13 | Depth |
| H | With holes |
| Q | Standard Special |
| 612 | Surface finish |

Specification Information

Specify finish.
Specify suffix H for shelf holes that accept shelf organizers.

Application Notes

Panel mounted shelves are canti-levered from vertical panel connector tracks with bookend or undershelf brackets. 1 1/4" shelves must be midspan supported every 48".
13"D shelves hold binders, books and other reference material. Order brackets and shelf organizers, if applicable, separately.
Bookend-style brackets keep material upright when vertical panels are not used at the ends of shelves (brackets are shipped in pairs.)

Standard 13" deep shelves double as flush counter surfaces. Specify undershelf brackets or desk-mount stanchions for this application.
All shelves accept task lights. Adjacent bookend-style shelves require MB1-TC tie clip to secure full width task light.
Transaction shelf brackets support panel-mounted shelves without holes. Each set supports a maximum span of 48".

Morrison Overhead cabinets

panel and desk mounted

Standard Specials Systems

| description | locks | w | d | h | pattern no. | P1 | V1 | V2 |
|--|-------|-----|-----|----------------------------------|-----------------------------|--------|----------|----------|
| Painted or veneer front, panel mounted | | 24" | 14" | 17 ³ / ₄ " | MO8-24-()-()-N-L-Q | \$870. | \$1,030. | \$1,155. |
| | | 24" | 14" | 17 ³ / ₄ " | MO8-24-()-()-N-N-Q | 789. | 955. | 1,079. |

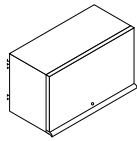

shown with lock

| | | | | | | | | |
|--|--|-----|-----|----------------------------------|------------------------------|------|--------|--------|
| Painted or veneer front, stanchion mounted | | 24" | 14" | 17 ³ / ₄ " | MO8-N24-()-()-N-L-Q | 870. | 1,030. | 1,155. |
| | | 24" | 14" | 17 ³ / ₄ " | MO8-N24-()-()-N-N-Q | 789. | 955. | 1,079. |

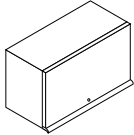

shown with lock

Morrison System

Order Code

Example: **MO8-N24-612-612-N-N-Q**

| | |
|------------|-------------------------|
| MO8 | Overhead cabinet |
| N | Network mounted |
| 24 | Width |
| 612 | Paint finish for case |
| 612 | Surface finish for door |
| N | Black pulls |
| N | No lock |
| Q | Standard Special |

Specification Information

Specify finish for case and front.

Order overhead cabinet locks with a KnollKey order form.

Interior shelves have slots for vertical dividers. Order vertical dividers separately.

Desk mounted MO8 overheads align with 64"H panel and vertical storage.

Overhead cabinet door pulls are matte black.

Overhead cabinets are hung from vertical panels with removable brackets. Cabinet door recedes within cabinet to allow use of top of overhead for storage or lighting.

Application Notes

Stanchion mounted overhead cabinets attach to overhead supports. Specify overhead backs separately for finished appearance in back-to-back or exposed applications.

Specify conversion kit MO7-SMB only if converting panel hung overheads to stanchion mounted.

Wall-mounting Morrison overhead cabinets: Use MO8-WMR to mount up to 120' of MO8 overheads. Specify one MO8-WMB for each overhead.

For Options overheads or Morrison or Options shelves, use MO6-WMSK to wall mount up to 9' of shelves or overheads. Kit includes wall mount rail and one vertical standard. Specify one additional MO6 WMSB for each shelf or overhead. Morrison shelves also require MB1-B13 shelf brackets.

Wall mount rails may be trimmed to length.

Specify conversion kit MO7-PMB only if converting stanchion mounted overheads to panel hung.

Wall mount wire manager is two-part wire concealment kit, 22"H.

Morrison Network privacy screen back screens

Standard Specials Systems

| description | w | d | h | pattern no. | 10 | 15 | 20 | 30 | 35 | 40 | 45 |
|-------------------------------------|-----|------|-----|------------------------|--------|--------|--------|--------|--------|--------|--------|
| Back of worksurface screens to 42"H | 24" | 3/4" | 15" | MZ1-B2415-(-)-Q | \$190. | \$214. | \$218. | \$241. | \$254. | \$269. | \$311. |
| | 24" | 3/4" | 19" | MZ1-B2419-(-)-Q | 242. | 262. | 269. | 294. | 311. | 322. | 351. |
| | 24" | 3/4" | 22" | MZ1-B2422-(-)-Q | 294. | 310. | 319. | 351. | 368. | 377. | 474. |

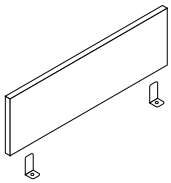

Order Code

| | |
|----------------|---------------------------------|
| Example: | MZ1-B2415-15-W210/20-Q |
| MZ1 | Morrison Network privacy screen |
| B | Back of worksurface |
| 24 | Width |
| 15 | Height |
| 15 | Surface type and group no. |
| W210/20 | Upholstery |
| Q | Standard Special |

Specification Information

Surface type:

| | |
|-----|-----------------|
| 10- | Fabric group 10 |
| 15- | Fabric group 15 |
| 20- | Fabric group 20 |
| 30- | Fabric group 30 |
| 35- | Fabric group 35 |
| 40- | Fabric group 40 |
| 45- | Fabric group 45 |

Back of worksurface screens provide visual barrier and tackable surface from underside of worksurface to a height of 42", 46" or 49".

Screen widths should correspond to straight worksurface width, or sum of VDT corner and return widths.

Use back of worksurface screen for VDT applications where one side is backed by a vertical panel.

VDT worksurfaces will accept back screens on only one back edge.

Back screens may not be used at the end of a straight worksurface; use end screens in this application.

Privacy screens are not available in a combination of fabrics.

Back of worksurface screens are full dimension: two smaller screens may be substituted for a larger one. For example, if using fabric grades 20-70, specify two 36" screens for a 72" surface.

Between back-to-back straight or VDT worksurfaces specify a single 3/4" back screen. This allows back-to-back 23 5/8"D or 29 5/8"D worksurfaces to plan on a precise 6" module.

15" high screens are used for a 42" horizon.

19"H screens are used to fill in space between worksurface and Morrison overhead.

22"H screens fill the space between worksurface and Reuter overhead.

All but shared end screens start at the bottom of the worksurface.

Privacy screens are supported by brackets fastened at worksurface inserts. Privacy screens include mounting brackets, insert kit, and stiffener clip.

For replacement screen stiffeners see Accessories page.

Privacy screens may be specified to achieve ASTM E-84 Class "A" flamespread rating.

Morrison vertical storage options kiosk

| description | width | depth | height | pattern number | Paint |
|---------------|-------|-------|--------|-----------------------------|----------|
| Options Kiosk | 24" | 24" | 18" | LV3-S18S-(L/R)-()-Q | \$1,236. |
| | 24" | 24" | 56" | LV3-S56-(L/R)-()-Q | 3,846. |
| | 24" | 30" | 64" | LV3-D64-(L/R)-()-Q | 4,163. |
| | 30" | 24" | 64" | LV3-W64-(L/R)-()-Q | 5,190. |

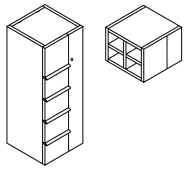

| Order Code | Specification Information | Application Notes |
|----------------------------------|--|--|
| Example: MV3-D64F-R612-Q | <i>Specify Melamine finishes for sides, top, and back of Options Kiosk.</i> | |
| MV3 Vertical storage | | |
| D 30" deep | | |
| 64 Height | Options Kiosk fronts may be specified in any standard Morrison painted finish. Sides, top and back are available in melamine only. Kiosk storage is available in full painted finishes only. | Options Kiosks are freestanding wood construction vertical storage with four Morrison file drawers, hinged door cabinet, and coat storage with door. Options Kiosks have painted fronts and melamine sides, back and interior. The melamine top is finished, with lock cams and a few pilot holes visible. |
| F Front access | | |
| R Right door hinge | | |
| 612 Case and front finish | | |
| Q Standard Special | | |
| | S- 24"W x 24"D D- 24"W x 30"D L- Hinged door for coats (shelves) on left R- Hinged door for coats (shelves) on right | Kiosks are identical to Options kiosks but painted on all surfaces. 64"H Kiosks include cabinet with hinged door over the file drawers. 18"H top cabinet attaches to 56"H Kiosk to create 74"H storage unit. Top cabinet includes front access hinged door storage over the coat storage and open shelves accessible from the sides. |
| | All kiosks have KnollKey lock for door, and internal sliding lock switch for files. | File supports for kiosk drawers must be ordered separately. |
| | | Flat top caps may be specified separately to coordinate with Morrison panel top caps; vault-shaped cupolas may also be used to prevent storage above kiosk. Kiosk back panels and extended depth top caps or cupolas are used with adjacent vertical panels. Back panel is notched to connect to panel with brackets and trim included. Specify straight connector track same height as vertical panel, and hi/low top cap for post configurations, in width of adjacent panel. |

Morrison Network T5 Task Light Daisy Chain

Standard Specials Systems

| description | type | w | d | h | pattern no. | Standard | Advanced |
|---|---------------------------------|-----|----|--------|---------------------------|----------|----------|
| Task Light, starter 9 ft. cord, fused male plug 1 ft. cord, female plug | Use with 24" and wider overhead | 19" | 4" | 1 1/2" | MN2T5E19()DCS()Q | \$342. | n/a |
| | Use with 30" and wider overhead | 25" | 4" | 1 1/2" | MN2T5E25()DCS()Q | 356. | 533. |
| | Use with 42" and wider overhead | 37" | 4" | 1 1/2" | MN2T5E37()DCS()Q | 390. | 554. |
| | Use with 60" and wider overhead | 49" | 4" | 1 1/2" | MN2T5E49()DCS()Q | 456. | 570. |

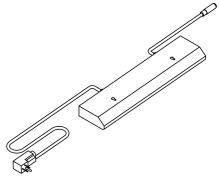

left hand shown

| | | | | | | | |
|---|---------------------------------|-----|----|--------|---------------------------|------|------|
| Task Light, adder 2 ft. cord, male plug 1 ft. cord, female plug | Use with 24" and wider overhead | 19" | 4" | 1 1/2" | MN2T5E19()DCA()Q | 374. | n/a |
| | Use with 30" and wider overhead | 25" | 4" | 1 1/2" | MN2T5E25()DCA()Q | 388. | 565. |
| | Use with 42" and wider overhead | 37" | 4" | 1 1/2" | MN2T5E37()DCA()Q | 422. | 586. |
| | Use with 60" and wider overhead | 49" | 4" | 1 1/2" | MN2T5E49()DCA()Q | 488. | 602. |

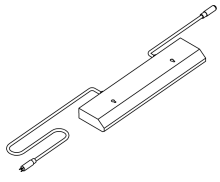

left hand shown

| | | | | | | | |
|--|---------------------------------|-----|----|--------|---------------------------|------|------|
| Task Light, ender 2 ft. cord, male plug | Use with 24" and wider overhead | 19" | 4" | 1 1/2" | MN2T5E19()DCE()Q | 261. | n/a |
| | Use with 30" and wider overhead | 25" | 4" | 1 1/2" | MN2T5E25()DCE()Q | 275. | 452. |
| | Use with 42" and wider overhead | 37" | 4" | 1 1/2" | MN2T5E37()DCE()Q | 309. | 473. |
| | Use with 60" and wider overhead | 49" | 4" | 1 1/2" | MN2T5E49()DCE()Q | 375. | 489. |

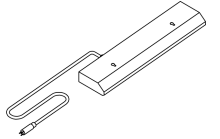

left hand shown

| Order Code | Specification Information | Application Notes |
|--------------------------------|--|---|
| Example: MN2T5E19SDCSLQ | <i>Specify:</i> | Task lights mount into the recess in the underside of overhead cabinets and shelves at least 6" wider than task light width. |
| MN2 Task Light | Width - Task Lights mount in cabinets and shelves at least 5" wider than light width. | Morrison Network task lights are mounted inside the horizontal beam of the overhead support. |
| T5 T5 lamp | 1. Type: (S) Standard (A) Advanced | Task light cord may be managed in either stanchion to desk support wireway. |
| E Electronic ballast | 2. Handedness L= Left handed (male plug on user's left side) R=Right handed (male plug on user's right side) | Task lights include T5 cool white (4100K) fluorescent lamp, electronic ballast, prismatic lens, rocker switch, one cord exit management clip and mounting hardware. |
| 19 Width | All housings are black. | Task lights are TCLP compliant and meet requirements of California Title 24. |
| S Standard | | Advanced task lights are fitted with ballast and lamp compliant with LEED requirements. |
| DC Daisy chain | | |
| S Starter | | |
| L Left handed | | |
| Q Special | | |

Morrison Options T5 Task Light Daisy Chain

| description | type | w | d | h | pattern no. | Standard | Advanced |
|---|---------------------------------|-----|----|--------|---------------------------|----------|----------|
| Task Light, starter 9 ft. cord, fused male plug 1 ft. cord, female plug | Use with 24" and wider overhead | 19" | 4" | 1 1/2" | LL2T5E19()DCS()Q | \$300. | n/a |
| | Use with 30" and wider overhead | 25" | 4" | 1 1/2" | LL2T5E25()DCS()Q | 343. | 533. |
| | Use with 42" and wider overhead | 37" | 4" | 1 1/2" | LL2T5E37()DCS()Q | 368. | 554. |
| | Use with 60" and wider overhead | 49" | 4" | 1 1/2" | LL2T5E49()DCS()Q | 411. | 570. |

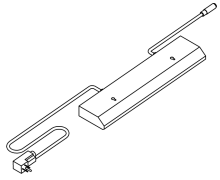

left hand shown

| | | | | | | | |
|---|---------------------------------|-----|----|--------|---------------------------|------|------|
| Task Light, adder 2 ft. cord, male plug 1 ft. cord, female plug | Use with 24" and wider overhead | 19" | 4" | 1 1/2" | LL2T5E19()DCA()Q | 332. | n/a |
| | Use with 30" and wider overhead | 25" | 4" | 1 1/2" | LL2T5E25()DCA()Q | 375. | 565. |
| | Use with 42" and wider overhead | 37" | 4" | 1 1/2" | LL2T5E37()DCA()Q | 400. | 586. |
| | Use with 60" and wider overhead | 49" | 4" | 1 1/2" | LL2T5E49()DCA()Q | 443. | 602. |

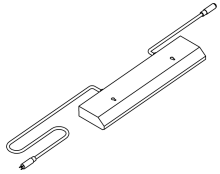

left hand shown

| | | | | | | | |
|--|---------------------------------|-----|----|--------|---------------------------|------|------|
| Task Light, ender 2 ft. cord, male plug | Use with 24" and wider overhead | 19" | 4" | 1 1/2" | LL2T5E19()DCE()Q | 219. | n/a |
| | Use with 30" and wider overhead | 25" | 4" | 1 1/2" | LL2T5E25()DCE()Q | 262. | 452. |
| | Use with 42" and wider overhead | 37" | 4" | 1 1/2" | LL2T5E37()DCE()Q | 287. | 473. |
| | Use with 60" and wider overhead | 49" | 4" | 1 1/2" | LL2T5E49()DCE()Q | 330. | 489. |

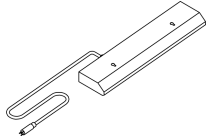

left hand shown

| Order Code | Specification Information | Application Notes |
|--------------------------------|---|---|
| Example: LL2T5E19SDCSLQ | <i>Specify:</i> | Task lights mount into the recess in the underside of overhead cabinets and shelves at least 6" wider than task light width. |
| LL2 Task Light | Width - Task Lights mount in cabinets and shelves at least 5" wider than light width. | Task lights include T5 cool white (4100K) fluorescent lamp, electronic ballast, prismatic lens, rocker switch, one cord exit management clip and mounting hardware. |
| T5 T5 lamp | 1. Type: (S) Standard (A) Advanced | Task light cordset is center exit. On smaller units cord exit is off-center, but still not handed. |
| E Electronic ballast | 2. Handedness: L= Left handed (male plug on user's left side) R=Right handed (male plug on user's right side) | Task lights are TCLP compliant and meet requirements of California Title 24. |
| 19 Width | All housings are black. | Advanced task lights are fitted with ballast and lamp compliant with LEED requirements. |
| S Standard | | |
| DC Daisy chain | | |
| S Starter | | |
| L Left handed | | |
| Q Special | | |

Wood Finishes:

V1 Techwood Closed Pore

| | |
|------|-----------------|
| Y316 | Maple |
| Y319 | Cherry |
| Y323 | Medium Walnut |
| Y326 | Dark Mahogany |
| Y327 | Light Oak |
| Y329 | Medium Oak |
| Y341 | Wenge * |
| Y342 | Medium Teak * |
| Y343 | Dark Grey Oak * |
| Y344 | Espresso |
| Y851 | Black Oak |
| Y811 | Natural |
| Y821 | Blond Maple |
| Y831 | Light Cherry |

*Not available on Reff optional Edges.

V1 - Techwood Closed Pore

Surface with matching synthetic edge:

Options applicable for 1/4" thick worksurfaces with standard flat edge only.

| | |
|------|---------------|
| S319 | Cherry |
| S316 | Maple |
| S323 | Medium Walnut |

V2 Natural Veneer

Closed Pore

| | |
|--------------------------------------|----------------------|
| V312 | Bronze Cherry |
| V316 | Maple |
| V411 | Light Walnut |
| V415 | Peacock Green Walnut |
| V417 | Old English Walnut |
| V418 | Smoked Walnut |
| V433 | Light Fawn Cherry |
| V436 | Medium Brown Cherry |
| <i>(all above V2's are flat cut)</i> | |
| V421 | Chalk Oak |
| V423 | Light Oak |
| V425 | Amber Oak |
| V427 | Brown Oak |
| <i>(all V2 Oak's are rift cut)</i> | |
| V439 | Straight Anigre |

V2 Natural Veneer with synthetic edge

Options applicable for 1/4" thick worksurfaces with standard flat edge only.

Flat Cut:

| | |
|------|----------------------|
| R319 | Medium Cherry |
| R315 | Light Cherry |
| R316 | Light Maple |
| R323 | Medium Walnut |
| R415 | Peacock Green Walnut |
| R417 | Old English Walnut |
| R421 | Chalk Oak |
| R427 | Brown Oak |
| R312 | Bronze Cherry |

V3 Exotic Veneer

| | |
|------|----------------------------|
| V512 | Figured Anigre |
| V513 | Graphite Oak (Rift cut) |
| V514 | Makore |
| V515 | Figured Sycamore |
| V517 | Natural Sapele |

(all above are quarter cut)

Glass Options:

| | |
|--|---------------------|
| TEMP | Clear Tempered (G1) |
| <i>Architectural Glass Options: (G2)</i> | |
| GL13 | Powder |
| GL8 | Wafer |
| GL6 | Block Matrix |

Locks

Black only

Laminate

Matching edge band unless noted otherwise

| | |
|-----|--------------------------|
| 111 | Jet Black |
| 114 | Folkstone Grey |
| 117 | Soft Grey |
| 118 | Bright White |
| 119 | Pumice |
| 121 | Micro Grey with 114 |
| | Folkstone grey edge band |
| 122 | Brushed Sand with 119 |
| | Pumice edge band |
| 123 | Brushed Grey with 128 |
| | Fog edge band |
| 124 | Medium Chery |
| 125 | Natural Maple |
| 126 | Natural Cherry |
| 127 | Walnut |
| 128 | Fog |
| 129 | Micro Sand with 119 |
| | Pumice edge band |

Paint Classifications:

Upcharge as applicable for paint class noted on applicable product pages

P1

| | |
|-----|----------------|
| 111 | Jet Black |
| 112 | Brown |
| 113 | Dark Grey |
| 114 | Folkstone Grey |
| 115 | Medium Grey |
| 116 | Sandstone |
| 117 | Soft Grey |

P2

| | |
|-----|----------------------|
| 611 | Beige Mist Metallic |
| 612 | Medium Metallic Grey |

P3

| | |
|-----|--------------|
| 118 | Bright White |
| 613 | Silver |

See matrix next page for finishes applicable by component

Mixed Finishes: (where applicable for work surfaces only)

To order mixed finishes, enter four digit finish code as follows:

Use 2 digit prefix to indicate surface finish (laminate)

| | |
|----|----------------|
| 11 | Jet Black |
| 14 | Folkstone Grey |
| 17 | Soft Grey |
| 18 | Medium Grey |
| 19 | Pumice |
| 21 | Micro Grey |
| 22 | Brushed Sand |
| 23 | Brushed Grey |
| 28 | Fog |
| 29 | Micro Sand |

Use 2 digit suffix to indicate edge finish (wood)

| | |
|----|----------------|
| 12 | for V312 |
| 16 | for V316, Y316 |
| Y9 | for Y319 |
| Y3 | for Y323 |
| 26 | for Y326 |
| 27 | for Y327 |
| 29 | for Y329 |
| 43 | for V433 |
| 45 | for V415 |
| 46 | for V436 |
| 47 | for V417 |
| 48 | for V418 |
| 49 | for V439 |
| 52 | for V512 |
| 53 | for V513 |
| 54 | for V514 |
| 55 | for V515 |
| 57 | for V517 |
| 61 | for V411 |
| 71 | for V421 |
| 73 | for V423 |
| 75 | for V425 |
| 77 | for V427 |

Example:

For a Micro Grey laminate surface with Bronzed Cherry edge, enter finish code 2112

For a Jet Black laminate surface with Light Maple edge, enter finish code 1116

Fabric Options

Grade 10

Bailey II (W359) ø
 Broadcloth (W288)
 Foundation (W351)
 Growth Spurt (W692)
 Newbury (W812) ø
 Solid Crepe (W257) ø
 Symbolic Detail (W693)
 Tailor Made (W133)
 Versatility (W432)

Grade 15

Regency (W210)

Grade 20

Banyan (W443)
 Bauhaus Block (W296A)
 Circle Line (W1146)
 Clarity (W281)
 Criss Cross (W305)
 Devon (W809) ø
 Labyrinth (W352)
 Melbourne (W228)
 Outback (W229)
 Reflect (W884) ø
 Resolution (W280)
 Walkabout (W230)
 Weave Three (W298)

Grade 30

Basket Draft (W249)
 Flow (W565)
 Harmony (W232)
 Interknit (W1090)
 Match Point (W1145)
 Micro (W465)*
 Progression (W403)
 Raku Cloth (W566) ø
 Relay (W1020) ▲

Grade 40

Clarkson (W1218)
 Ornament (W1078)
 Palladium (W1030) ▲
 Sennit (W337)
 Spinoff Nuance (W319)

Grade 45

Casual Elegance (W920)
 Dristi (K872)* ø

*with backing only

▲ Monolithic panels and tackboards only

ø May not be available in all colors.

The following textiles are approved for use on Reff panels. Consult Knoll representative for pricing:

Grade 50

Knoll Hopsack (K1206)
 Ricochet (W498)

Grade 55

Knoll Felt (K1207)
 Transition (W816)

Customers Own Material

Prices for panels that are to be manufactured with a customer supplied fabric will follow Grade 10 panel pricing.

COM fabrics are subject to a testing charge prior to acceptance for use on Reff panels. Panels bearing COM fabrics are subject to extended leadtimes. It is the responsibility of the customer's purchasing agent to ensure COM fabric is supplied for testing and manufacturing. Delays in receiving COM fabric for manufacturing will result in rescheduled delivery dates.

When specifying panel/fabrics use the following format to denote location on a tiled panel.

| Side 1 | | Side 2 |
|--------|-----------------|--------|
| 1E | Top of Panel | 2E |
| 1D | | 2D |
| 1C | | 2C |
| 1B | | 2B |
| 1A | Bottom of Panel | 2A |

(Side 1 is always the inside of the workstation.)

Panels with beltway one side: assume the beltway is on SIDE 1 of the panel.

Non-Wood Finishes

| Finishes | Panel Tiles, Worksurfaces & Components | Panel Top Trims Window Frames | Panel Base Side Plates | Panel Beltway Side Plates* | Leg and Bases | Interaction Style Legs | Pulls | Grommets |
|------------------------|--|----------------------------------|---------------------------|-------------------------------|------------------|---------------------------|-------|----------|
| | Jet Black | 111 | 111 | 111 | 111 | 111 | 111 | 111 |
| Dark grey | n/a | 113 | 113 | 113 | 113 | 113 | n/a | 113 |
| Medium grey | n/a | 115 | 115 | 115 | 115 | 115 | n/a | 115 |
| Soft grey | 117 | 117 | 117 | 117 | 117 | 117 | n/a | 117 |
| Folkstone grey | 114 | 114 | 114 | 114 | 114 | 114 | n/a | 114 |
| Pumice | 119 | 119 | 119 | 119 | 119 | 119 | n/a | 119 |
| Sandstone | n/a | 116 | 116 | 116 | 116 | 116 | n/a | 116 |
| Brown | n/a | 112 | 112 | 112 | 112 | 112 | 112 | 112 |
| Medium metallic grey | n/a | 612 | 612 | 612 | 612 | 612 | 612 | 612 |
| Silver | n/a | 613 | 613 | 613 | 613 | 613 | 613 | 613 |
| Bright White | 118 | 118 | 118 | 118 | 118 | 118 | 118 | 118 |
| Beige metallic mist | n/a | 611 | 611 | 611 | 611 | 611 | 611 | 611 |
| Micro Grey * | 121 | n/a | n/a | n/a | n/a | n/a | n/a | n/a |
| Brushed Sand * | 122 | n/a | n/a | n/a | n/a | n/a | n/a | n/a |
| Brushed Grey * | 123 | n/a | n/a | n/a | n/a | n/a | n/a | n/a |
| Fog | 128 | n/a | n/a | n/a | n/a | n/a | n/a | n/a |
| Micro Sand * | 129 | n/a | n/a | n/a | n/a | n/a | n/a | n/a |
| Plated Finishes | | | | | | | | |
| Satin brass | n/a | n/a | PZ | n/a | PZ | n/a | PZ | PZ |
| Brushed pewter | n/a | n/a | PT | n/a | PT | n/a | PT | PT |
| Polished chrome | n/a | n/a | PD | n/a | PD | n/a | n/a | PD |

n/a = not available

* = matching edge band not available, also not optional for panel tiles or components, worksurfaces only

Reff Panels

Monolithic

34", 42" and 49" high

Standard Specials Systems

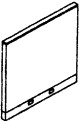
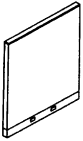
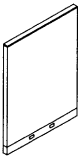

| description | h | w | pattern no. | V1 | V2 | V3 |
|--|---|--------|----------------------------------|--------|--------|----------|
| Wood/Wood Regular Acoustics |  | 18" | QR3B0P (11/22/33) 3418 () () | \$796. | \$817. | \$1,103. |
| | | 20" | QR3B0P (11/22/33) 3420 () () | 796. | 817. | 1,103. |
| | | 24" | QR3B0P (11/22/33) 3424 () () | 849. | 872. | 1,177. |
| | | 30" | QR3B0P (11/22/33) 3430 () () | 910. | 936. | 1,264. |
| | | 36" | QR3B0P (11/22/33) 3436 () () | 967. | 995. | 1,343. |
| | | 42" | QR3B0P (11/22/33) 3442 () () | 1,114. | 1,146. | 1,547. |
| | | 48" | QR3B0P (11/22/33) 3448 () () | 1,157. | 1,191. | 1,607. |
|  | 42" | 18" | QR3B0P (11/22/33) 4218 () () | 703. | 726. | 979. |
| | | 20" | QR3B0P (11/22/33) 4220 () () | 703. | 726. | 979. |
| | | 24" | QR3B0P (11/22/33) 4224 () () | 715. | 734. | 992. |
| | | 30" | QR3B0P (11/22/33) 4230 () () | 856. | 882. | 1,192. |
| | | 36" | QR3B0P (11/22/33) 4236 () () | 928. | 953. | 1,287. |
| | | 42" | QR3B0P (11/22/33) 4242 () () | 1,035. | 936. | 1,264. |
| | | 48" | QR3B0P (11/22/33) 4248 () () | 1,133. | 1,166. | 1,575. |
| | | 60" | QR3B0P (11/22/33) 4260 () () * | 1,233. | 1,268. | 1,712. |
| | | 66" | QR3B0P (11/22/33) 4266 () () * | 1,279. | 1,316. | 1,777. |
|  | 49" | 18" | QR3B0P (11/22/33) 4918 () () | 782. | 804. | 1,085. |
| | | 20" | QR3B0P (11/22/33) 4920 () () | 782. | 804. | 1,085. |
| | | 24" | QR3B0P (11/22/33) 4924 () () | 804. | 882. | 1,192. |
| | | 30" | QR3B0P (11/22/33) 4930 () () | 967. | 995. | 1,343. |
| | | 36" | QR3B0P (11/22/33) 4936 () () | 1,044. | 1,074. | 1,449. |
| | | 42" | QR3B0P (11/22/33) 4942 () () | 1,153. | 1,186. | 1,601. |
| | | 48" | QR3B0P (11/22/33) 4948 () () | 1,304. | 1,337. | 1,806. |
| | | 60" | QR3B0P (11/22/33) 4960 () () * | 1,407. | 1,446. | 1,952. |
| | | 66" | QR3B0P (11/22/33) 4966 () () * | 1,453. | 1,458. | 1,967. |
| 72" | QR3B0P (11/22/33) 4972 () () * | 1,498. | 1,541. | 2,080. | | |

| Order Code | Specification Information | Application Notes |
|---|---|---|
| Example: QR3B0PLL3418-A4K | <i>To order please specify pattern number including:</i> | |
| QR3 Reff Generation 3 Special | 1. Top trim profile | 1. Top trim profile: A = Flat B = Square C = Bullnose E = Extruded aluminum, anodized finish only |
| B0 No Beltway | 2. Base height | 2. Base height: 4 = 4" base height 6 = 6" base height (add \$47 per panel for this option) |
| P Monolithic panel | 3. Knockout option (K = with knockouts, N = without knockouts) | Applicable finishes are listed on page 102 and 103. |
| LL Laminage on both sides | 4. Panel side 1 finish(s) inside | Product on this page will accept wood grain laminate where laminate is currently an option. Panel product is subject to a 10% upcharge on Laminate/Laminate base panel price. |
| 34 34" high | 5. Panel side 2 finish(s) outside | |
| 18 18" wide | 6. Top trim finish | |
| (A) Flat style top trim | 7. Base finish | |
| (4) 4" base height | 8. <i>Optional:</i> specify (M) for panel frame to be milled for ported components. \$14 list upcharge applicable | |
| (K) Include knockouts in base | | |
| 118 Laminate selection - side 1 | | All panels on this page accept stacking modules except those indicated with an asterisk. |
| 118 Laminate selection - side 2 | | 6" Raceway option increases panel height by 2 ³ / ₄ ". |
| V316 Maple (top trim finish) | | All panels on this page have no high acoustical option or Beltway option. |
| 118 Bright White (base finish) | | Product on this page can be attached to posts 34"H, other 34", 42", 49", 64", and 79" panels without beltway. To attach 34"H panels to Beltway posts over 34"H, order appropriate attachment kit from standard Reff price list. |
| | | 79"H hookstrip reveal strips are ordered separately from page the standard Reff price list at no charge. |
| | | * These panel widths do not accept stacking modules. |

Reff Panels

Monolithic

64" and 79" high

| description | h | w | pattern no. | V1 | V2 | V3 |
|--------------------------------|---|-----|---|--------|--------|----------|
| Wood/Wood Regular Acoustics |  | 18" | QR3B0P (11/22/33) 6418 () () | \$931. | \$955. | \$1,290. |
| | | 20" | QR3B0P (11/22/33) 6420 () () | 931. | 955. | 1,290. |
| | | 24" | QR3B0P (11/22/33) 6424 () () | 1,016. | 1,045. | 1,411. |
| | | 30" | QR3B0P (11/22/33) 6430 () () | 1,152. | 1,185. | 1,600. |
| | | 36" | QR3B0P (11/22/33) 6436 () () | 1,242. | 1,279. | 1,727. |
| | | 42" | QR3B0P (11/22/33) 6442 () () | 1,376. | 1,417. | 1,913. |
| | | 48" | QR3B0P (11/22/33) 6448 () () | 1,550. | 1,596. | 2,155. |
| | | 60" | QR3B0P (11/22/33) 6460 () () * | 1,679. | 1,727. | 2,330. |
| | | 66" | QR3B0P (11/22/33) 6466 () () * | 1,737. | 1,786. | 2,413. |
| | | 72" | QR3B0P (11/22/33) 6472 () () * | 1,795. | 1,846. | 2,493. |
| |  | 18" | QR3B0P (11/22/33) 7918 () () * | 1,171. | 1,207. | 1,629. |
| | | 20" | QR3B0P (11/22/33) 7920 () () * | 1,168. | 1,207. | 1,629. |
| | | 24" | QR3B0P (11/22/33) 7924 () () * | 1,282. | 1,320. | 1,781. |
| | | 30" | QR3B0P (11/22/33) 7930 () () * | 1,448. | 1,490. | 2,011. |
| | | 36" | QR3B0P (11/22/33) 7936 () () * | 1,575. | 1,622. | 2,189. |
| | | 42" | QR3B0P (11/22/33) 7942 () () * | 1,745. | 1,795. | 2,423. |
| | | 48" | QR3B0P (11/22/33) 7948 () () * | 1,950. | 2,006. | 2,707. |
| | | 60" | QR3B0P (11/22/33) 7960 () () * | 2,098. | 2,160. | 2,915. |
| | | 66" | QR3B0P (11/22/33) 7966 () () * | 2,143. | 2,203. | 2,974. |
| | | 72" | QR3B0P (11/22/33) 7972 () () * | 2,183. | 2,249. | 3,037. |

| Order Code | Specification Information | Application Notes |
|---|---|---|
| Example: QR3B0PLL3418-A4K | <i>To order please specify pattern number including:</i> | |
| QR3 Reff Generation 3 Special | 1. Top trim profile | 1. Top trim profile: A = Flat B = Square C = Bullnose E = Extruded aluminum, anodized finish only |
| B0 No Beltway | 2. Base height | 2. Base height: 4 = 4" base height 6 = 6" base height (add \$47 per panel for this option) |
| P Monolithic panel | 3. Knockout option (K = with knockouts, N = without knockouts) | Applicable finishes are listed on page 102 and 103. |
| LL Laminate on both sides | 4. Panel side 1 finish(s) inside | Product on this page will accept wood grain laminate where laminate is currently an option. |
| 34 34" high | 5. Panel side 2 finish(s) outside | Panel product is subject to a 10% upcharge on Laminate/Laminate base panel price. |
| 18 18" wide | 6. Top trim finish | |
| (A) Flat style top trim | 7. Base finish | |
| (4) 4" base height | 8. <i>Optional:</i> specify (M) for panel frame to be milled for ported components. \$14 list upcharge applicable | |
| (K) Include knockouts in base | | |
| 118 Laminate selection - side 1 | | All panels on this page accept stacking modules. |
| 118 Laminate selection - side 2 | | 6" Raceway option increases panel height by 2 3/4". |
| V316 Maple (top trim finish) | | All panels on this page have no high acoustical option or Beltway option except those indicated with an asterisk. |
| 118 Bright White (base finish) | | Product on this page can be attached to posts 34"H, other 34", 42", 49", 64", and 79" panels without beltway. To attach 34"H panels to Beltway posts over 34"H, order appropriate attachment kit from the standard Reff price list. |
| | | 79"H hookstrip reveal strips are ordered separately from page standard Reff price list at no charge. |
| | | * These panel widths do not accept stacking modules. |

Reff Panels

Tiled

34", 42" and 49" High

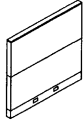
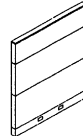
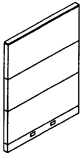
| description | h | w | pattern no. | V1 | V2 | V3 |
|---|---|-----|---------------------------------------|--------|--------|----------|
| Wood/Wood Regular Acoustics |  | 18" | QR3B0T (11/22/33) 3418 () () | \$885. | \$911. | \$1,230. |
| | | 20" | QR3B0T (11/22/33) 3420 () () | 885. | 911. | 1,230. |
| | | 24" | QR3B0T (11/22/33) 3424 () () | 946. | 973. | 1,313. |
| | | 30" | QR3B0T (11/22/33) 3430 () () | 1,007. | 1,034. | 1,397. |
| | | 36" | QR3B0T (11/22/33) 3436 () () | 1,065. | 1,095. | 1,479. |
| | | 42" | QR3B0T (11/22/33) 3442 () () | 1,211. | 1,246. | 1,683. |
| | | 48" | QR3B0T (11/22/33) 3448 () () | 1,249. | 1,285. | 1,735. |
|  | 42" | 18" | QR3B0T (11/22/33) 4218 () () | 995. | 1,022. | 1,380. |
| | | 20" | QR3B0T (11/22/33) 4220 () () | 995. | 1,022. | 1,380. |
| | | 24" | QR3B0T (11/22/33) 4224 () () | 1,057. | 1,086. | 1,467. |
| | | 30" | QR3B0T (11/22/33) 4230 () () | 1,130. | 1,161. | 1,567. |
| | | 36" | QR3B0T (11/22/33) 4236 () () | 1,193. | 1,226. | 1,655. |
| | | 42" | QR3B0T (11/22/33) 4242 () () | 1,331. | 1,367. | 1,846. |
| | | 48" | QR3B0T (11/22/33) 4248 () () | 1,394. | 1,434. | 1,936. |
|  | 49" | 18" | QR3B0T (11/22/33) 4918 () () | 1,112. | 1,145. | 1,546. |
| | | 20" | QR3B0T (11/22/33) 4920 () () | 1,112. | 1,145. | 1,546. |
| | | 24" | QR3B0T (11/22/33) 4924 () () | 1,180. | 1,213. | 1,637. |
| | | 30" | QR3B0T (11/22/33) 4930 () () | 1,263. | 1,298. | 1,752. |
| | | 36" | QR3B0T (11/22/33) 4936 () () | 1,331. | 1,367. | 1,846. |
| | | 42" | QR3B0T (11/22/33) 4942 () () | 1,484. | 1,527. | 2,060. |
| | | 48" | QR3B0T (11/22/33) 4948 () () | 1,559. | 1,606. | 2,167. |

| Order Code | Specification Information | Application Notes |
|---|---|--|
| Example: QR3B0TFF3418-A4K | <i>To order please specify pattern number including:</i> | <p>All panels on this page have no high acoustical option or Beltway option. Product on this page can be attached to posts 34"H, other 34", 42", 49", 64", and 79" panels without beltway. To attach 34" high panels to Beltway posts, order appropriate attachment kits from page standard Reff price list.</p> <p>The panels on this page will accept stacking modules to increase their height on 18" to 48"W panels only. The 60" to 72"W panels will not accept stacking modules on top of themselves.</p> <p>79"H hookstrip reveal strips are ordered separately from standard Reff price list at no charge.</p> |
| QR3 Reff Generation 3 Special | 34"h add per panel: \$28 for 18w and 20w \$30 for 24w and 30w \$32 for 36w and 42w \$44 for 48w | |
| B0 No Beltway | 42"h add per panel: \$50 for 18w and 20w \$56 for 24w and 30w \$68 for 36w and 42w \$84 for 48w | |
| T Tiled panel | 49"h add per panel: \$50 for 18w and 20w \$56 for 24w and 30w \$68 for 36w and 42w \$84 for 48w | |
| FF Fabric on both sides | 1. Top trim profile 2. Base height 3. Knockout option (K = with knockouts, N = without knockouts) | |
| 34 34" high | 4. Panel side 1 finish(s) inside 5. Panel side 2 finish(s) outside 6. Top trim finish 7. Base finish | |
| 18 18" wide | 8. <i>Optional:</i> specify (M) for panel frame to be milled for ported components. \$14 list upcharge applicable | |
| A Flat style top trim | 1. <i>Top trim profile:</i> A = Flat B = Square C = Bullnose E = Extruded Aluminum, anodized | |
| 4 4" base height | 2. <i>Base height:</i> 4 = 4" base height 6 = 6" base height (add \$47 per panel) | |
| K Include knockouts in base | 3. <i>Tile divider: (E option) applies to both sides</i> | |
| W281 Fabric selection - side 1 | | 6" Raceway option increases panel height by 2 3/4". |
| W281 Fabric selection - side 2 | | Applicable finishes are listed on page 102 and 103. |
| V316 Maple (top trim finish) | | Product on this page will accept wood grain laminate where laminate is currently an option. |
| 111 Jet Black (base finish) | | Panel product is subject to a 10% upcharge on Laminate/Laminate base panel price. |

Reff Panels

Tiled

64" and 79" High

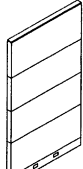
| description | h | w | pattern no. | V1 | V2 | V3 |
|--------------------------------|---|-----|---------------------------------------|----------|----------|----------|
| Wood/Wood Regular Acoustics |  | 18" | QR3B0T (11/22/33) 6418 () () | \$1,301. | \$1,338. | \$1,807. |
| | | 20" | QR3B0T (11/22/33) 6420 () () | 1,301. | 1,338. | 1,807. |
| | | 24" | QR3B0T (11/22/33) 6424 () () | 1,379. | 1,419. | 1,916. |
| | | 30" | QR3B0T (11/22/33) 6430 () () | 1,470. | 1,511. | 2,040. |
| | | 36" | QR3B0T (11/22/33) 6436 () () | 1,549. | 1,595. | 2,152. |
| | | 42" | QR3B0T (11/22/33) 6442 () () | 1,737. | 1,786. | 2,413. |
| | | 48" | QR3B0T (11/22/33) 6448 () () | 1,822. | 1,875. | 2,530. |

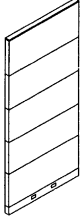
| | | | | | |
|---|-----|---------------------------------------|--------|--------|--------|
|  | 18" | QR3B0T (11/22/33) 7918 () () | 1,619. | 1,665. | 2,247. |
| | 20" | QR3B0T (11/22/33) 7920 () () | 1,619. | 1,665. | 2,247. |
| | 24" | QR3B0T (11/22/33) 7924 () () | 1,711. | 1,761. | 2,377. |
| | 30" | QR3B0T (11/22/33) 7930 () () | 1,795. | 1,846. | 2,493. |
| | 36" | QR3B0T (11/22/33) 7936 () () | 1,884. | 1,939. | 2,617. |
| | 42" | QR3B0T (11/22/33) 7942 () () | 2,108. | 2,168. | 2,927. |
| | 48" | QR3B0T (11/22/33) 7948 () () | 2,202. | 2,266. | 3,060. |

Order Code

| | |
|-------------|------------------------------|
| Example: | QR3B0TFF3418-A4K |
| QR3 | Reff Generation 3 Special |
| B0 | No Beltway |
| T | Tiled panel |
| FF | Fabric on both sides |
| 34 | 34" high |
| 18 | 18" wide |
| A | Flat style top trim |
| 4 | 4" base height |
| K | Include knockouts in base |
| W281 | Fabric selection - side 1 |
| W281 | Fabric selection - side 2 |
| V316 | Maple (top trim finish) |
| 111 | Jet Black (base finish) |

To order please specify pattern number including:

1. Top trim profile
2. Base height
3. Knockout option
(K = with knockouts,
N = without knockouts)
4. Panel side 1 finish(s) inside
5. Panel side 2 finish(s) outside
6. Top trim finish
7. Base finish
8. *Optional:* specify (M) for panel frame to be milled for ported components. \$14 list upcharge applicable

1. *Top trim profile:*

- A = Flat
- B = Square
- C = Bullnose
- E = Extruded Aluminum, anodized finish only

2. *Base height:*

- 4 = 4" base height
- 6 = 6" base height (add \$47 per panel)

3. *Tile divider: (E option) applies to both sides*

64" h add per panel:
\$78 for 18w and 20w
\$86 for 24w and 30w
\$96 for 36w and 42w
\$124 for 48w

79" h add per panel:
\$100 for 18w and 20w
\$116 for 24w and 30w
\$124 for 36w and 42w
\$168 for 48w

All panels on this page accept stacking modules.

6" Raceway option increases panel height by 2 3/4".

Applicable finishes are listed on page 102 and 103.

Product on this page will accept wood grain laminate where laminate is currently an option.

Panel product is subject to a 10% upcharge on Laminate/Laminate base panel price.

Application Notes

All panels on this page have no high acoustical option or Beltway option. Product on this page can be attached to posts 34"H, other 34", 42", 49", 64", and 79" panels without beltway. To attach 34" high panels to Beltway posts, order appropriate attachment kits from the standard Reff price list.

The panels on this page will accept stacking modules to increase their height on 18" to 48"W panels only. The 60" to 72"W panels will not accept stacking modules on top of themselves.

79"H hookstrip reveal strips are ordered separately from the standard Reff price list at no charge.

Reff Panels

Stacking modules and Slatwall

Standard Specials Systems

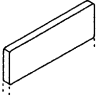
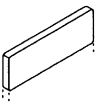
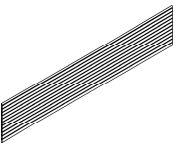
| description | height | width | pattern no. | lam. | AA | V1 | V2 | V3 |
|---|--------|-------|---------------------------------|--------|------|--------|--------|--------|
| Laminate/Laminate *,** | 8" | 18" | QR3S (LL/11/22/33) 0818 () () | \$275. | | \$285. | \$293. | \$396. |
| Wood/Wood | 8" | 20" | QR3S (LL/11/22/33) 0820 () () | 275. | | 285. | 293. | 396. |
| Regular Accoustics | 8" | 24" | QR3S (LL/11/22/33) 0824 () () | 285. | | 297. | 303. | 410. |
|  | 8" | 30" | QR3S (LL/11/22/33) 0830 () () | 315. | | 328. | 336. | 454. |
| | 8" | 36" | QR3S (LL/11/22/33) 0836 () () | 348. | | 362. | 373. | 503. |
| | 8" | 42" | QR3S (LL/11/22/33) 0842 () () | 376. | | 390. | 401. | 542. |
| | 8" | 48" | QR3S (LL/11/22/33) 0848 () () | 403. | | 418. | 431. | 583. |
| Laminate/Laminate * | 15" | 18" | QR3S (LL/11/22/33) 1518 () () | 368. | | 383. | 395. | 533. |
| Wood/Wood | 15" | 20" | QR3S (LL/11/22/33) 1520 () () | 368. | | 383. | 395. | 533. |
| Regular Accoustics | 15" | 24" | QR3S (LL/11/22/33) 1524 () () | 387. | | 402. | 414. | 559. |
|  | 15" | 30" | QR3S (LL/11/22/33) 1530 () () | 428. | | 445. | 457. | 617. |
| | 15" | 36" | QR3S (LL/11/22/33) 1536 () () | 467. | | 485. | 499. | 675. |
| | 15" | 42" | QR3S (LL/11/22/33) 1542 () () | 509. | | 529. | 545. | 735. |
| | 15" | 48" | QR3S (LL/11/22/33) 1548 () () | 546. | | 567. | 584. | 788. |
| Slatwall | 15" | 18" | QR2 SLAT 1518 () | 207. | 247. | | | |
|  | 15" | 20" | QR2 SLAT 1520 () | 220. | 260. | | | |
| | 15" | 24" | QR2 SLAT 1524 () | 239. | 280. | | | |
| | 15" | 30" | QR2 SLAT 1530 () | 287. | 338. | | | |
| | 15" | 36" | QR2 SLAT 1536 () | 319. | 377. | | | |
| | 15" | 42" | QR2 SLAT 1542 () | 369. | 436. | | | |
| | 15" | 48" | QR2 SLAT 1548 () | 417. | 493. | | | |

Available in anodized aluminum (AA)& painted finishes
Screws directly to panel frame

Order Code

| |
|--|
| Example: QR3SLL0820 |
| QR3 Reff Generation 3 |
| S Stacking module |
| LL Laminate/Laminate |
| 08 8" high |
| 20 20" wide |
| 118 Laminate selection - side 1 |
| 118 Laminate selection - side 2 |

Specification Information

To order please specify:

1. Pattern number including height and width
2. Panel side 1 finish
3. Panel side 2 finish

Product on this page will accept wood grain laminate where laminate is currently an option. Panel product is subject to a 10% upcharge on Laminate/Laminate base panel price.

Application Notes

* Not for use on 79"H panels.
* * Suitable only for top of any panel. Cannot be stacked upon.

8" module will not accept additional modules on top.

Use of 8" module on panel heights other than 34" h will require custom end trims and Hi-Lo parts.

Stacking modules on this page are high acoustic with a hard board septum and fiberglass.

Reff Panels

Midspan Off-set T-connectors

Standard Specials Systems

| description | h | pattern no. | list |
|--|-----|-----------------|--------|
| Mid-Span Connector | 42" | QS9G5875 | \$312. |
| To be used with Generation 3 panels only | 49" | QS9G5498 | 335. |
| | 64" | QS9G5499 | 437. |
| | 79" | QS9G5876 | 472. |
| <i>attach mid-span of a panel</i> | | | |
| Offset T-connectors | 42" | QS994873 | 430. |
| | 49" | QS9A8003 | 455. |
| | 64" | QS9A8002 | 491. |
| | 79" | QS9B2960 | 527. |

Reff System

Order Code

Specification Information

Application Notes

To be used in creating a panel run for visual separation only. Panels running off above connectors **are not loadbearing!**

Spine panel must be 1 piece and not a stackable creation.

Perpendicular panel can be 1 piece made of stackable modules.

Reff Panels

End trim, base drape&base raceway

Standard Specials Systems

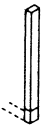
| description | h | w | pattern no. | Profile (A/B/C) | Profile (E) | list |
|---|-----|-----|---------------------------|-----------------|-------------|------|
|  End trim with hookstrip | 57" | | QR2ES4215() () () () | \$362. | \$250. | |
| | 57" | | QR2ES498() () () () | 362. | 250. | |
| | 72" | | QR2ES49158() () () () | 441. | 283. | |
| | 72" | | QR2ES648() () () () | 441. | 283. | |
| 1" h base drape&rigidizer | 1" | 96" | QS990981 | | | 166. |
| 2" h base drape&rigidizer | 2" | 96" | QS9A5986 | | | 326. |
| Base raceway with 2 extra date knockouts | 4" | 36" | QS9G2425 | | | 144. |
| | 4" | 42" | QS9G2320 | | | 165. |
| | 4" | 48" | QS9G2321 | | | 171. |

| Order Code | Specification Information | Application Notes |
|--|---|--|
| Example: QR2ES49158-A-6-V316-111 QR2 Reff Generation 2 ES End trim 49158 49+15+8=72" high A Flat profile 6 6" base height N Non electrical base V316 Trim finish, Maple 111 Jet Black (base finish) | <p>To order please specify pattern number including:</p> <p>End trim:</p> <ol style="list-style-type: none"> Trim profile <i>A = flat</i> <i>B = square</i> <i>C = bullnose</i> <i>E = extruded aluminum</i> Base height option <i>4 = 4"</i> <i>6 = 6"</i> Base type <i>E = electrical entry</i> <i>N = standard base</i> Finish, end trim <i>If profile A, B or C specify V1, V2, V3 or painted to match laminate</i> <i>If profile E specify AA-anodized aluminum or painted finish from page 0 excluding silver</i> Finish, end trim base <i>painted or plated finish</i> | <p>Add \$24 list for each end trim with 6" H base option. Does not apply to hi-lo end trims as they have no base.</p> <p>E profile end trim does not have base detail, but base height 4 or 6 required to determine overall height.</p> <p>End trim is for combination of panel and stackable module.</p> <p>Eg. QR2ES49158 is a 72" high end trim for a 49" h panel + 15" h stackable + 8" h stackable module. End trim for other panel combinations must be quoted thru custom product development.</p> <p>Base drape is for preventing light gap at base of a panel of a panel. Available in 8ft length and can be cut in field. Black finish only.</p> <p>Base raceway has 4 knockouts: 2 knockouts for electrical at standard location, 2 knockouts for date/communication at special location (5 3/4" from each end). Includes 4 standard knockout cover plates.</p> <p>Other panel widths are not available with extra data knockouts.</p> |

Reff Panels

U-channel wall starter cover

Standard Specials Systems

| description | h | w | d | pattern no. | list |
|--|-----|--------|---------|----------------------|--------|
| U-channel wall starter cover (does not cover hookstrip) | 34" | 2 1/2" | 13/16" | QRWSU34()() | \$403. |
| | 42" | 2 1/2" | 13/16" | QRWSU42()() | 494. |
| | 49" | 2 1/2" | 13/16" | QRWSU49()() | 578. |
| | 64" | 2 1/2" | 13/16" | QRWSU64()() | 757. |
| | 79" | 2 1/2" | 13/16" | QRWSU79()() | 932. |
| U-channel wall starter cover (covers hookstrip) | 34" | 2 1/2" | 1 1/16" | QRWSUH34()() | 403. |
| | 42" | 2 1/2" | 1 1/16" | QRWSUH42()() | 494. |
| | 49" | 2 1/2" | 1 1/16" | QRWSUH49()() | 578. |
| | 64" | 2 1/2" | 1 1/16" | QRWSUH64()() | 757. |
| | 79" | 2 1/2" | 1 1/16" | QRWSUH79()() | 932. |
| U-channel wall starter cover Field to ceiling | 21" | 2 1/2" | 1 1/16" | QRFCWSUH21() | 256. |
| | 25" | 2 1/2" | 1 1/16" | QRFCWSUH25() | 301. |
| | 37" | 2 1/2" | 1 1/16" | QRFCWSUH37() | 437. |

Reff System

Order Code

| | |
|--------------------------------|---------------------------|
| Example: QRWSUH79-6-111 | |
| QR | Reff |
| WS | Wall starter |
| U | U-channel cover |
| H | Hookstrip portion covered |
| 6 | 6" base height |
| 111 | Paint finish, jet black |

Specification Information

To order please specify pattern number including:

1. Base height option
4 = 4"
6 = 6" (add \$24 for this option)
2. Paint finish only

Application Notes

The U-channel is for covering up a wall starter. Hookstrip portion can be covered as well. Please note that if hookstrip portion is covered, panel-hung components and brackets cannot be used.

The U-channel is placed between drywall and wall starter. Slots in channel align with pre-drilled holds on wall on wall starter to allow for in-field leveling. There is an electrical entry at base of channel.

Field to ceiling wall starter cover is intended for 4" h base wall starter only.

Reff Worksurfaces

1 1/4" thick straight rectilinear

Standard Specials Systems

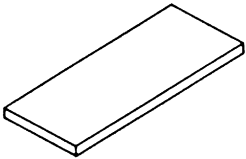
| description | d | w | pattern no. | L | M/V1 | V2 | V3 |
|--|-----|------|------------------------|--------|--------|--------|--------|
| Straight rectilinear work top  | 20" | 16" | QRSA161-N-() * | \$350. | \$382. | \$439. | \$593. |
| | | 102" | QRSA1021-() () | 686. | 742. | 853. | 1,152. |
| | | 108" | QRSA1081-() () | 745. | 801. | 921. | 1,244. |
| | | 114" | QRSA1141-() () | 804. | 860. | 989. | 1,335. |
| | | 120" | QRSA1201-() () | 863. | 919. | 1,057. | 1,427. |
| | 24" | 16" | QRSA162-N-() * | 368. | 401. | 461. | 623. |
| | | 102" | QRSA1022-() () | 758. | 821. | 944. | 1,275. |
| | | 108" | QRSA1082-() () | 817. | 880. | 1,012. | 1,366. |
| | | 114" | QRSA1142-() () | 876. | 939. | 1,080. | 1,458. |
| | | 120" | QRSA1202-() () | 935. | 998. | 1,148. | 1,549. |
| | 30" | 16" | QRSA163-N-() * | 402. | 437. | 503. | 678. |
| | | 102" | QRSA1023-() () | 805. | 874. | 1,005. | 1,357. |
| | | 108" | QRSA1083-() () | 864. | 933. | 1,073. | 1,448. |
| | | 114" | QRSA1143-() () | 923. | 992. | 1,141. | 1,540. |
| | | 120" | QRSA1203-() () | 982. | 1,051. | 1,209. | 1,632. |
| | 36" | 48" | QRSA484-() () | 674. | 735. | 845. | 1,141. |
| | | 54" | QRSA544-() () | 697. | 761. | 875. | 1,181. |
| | | 78" | QRSA784-() () | 804. | 873. | 1,004. | 1,355. |
| | | 84" | QRSA844-() () | 863. | 932. | 1,072. | 1,447. |
| | | 90" | QRSA904-() () | 922. | 991. | 1,140. | 1,539. |
| | | 96" | QRSA964-() () | 981. | 1,050. | 1,208. | 1,630. |
| | | 102" | QRSA1024-() () | 1,040. | 1,109. | 1,275. | 1,722. |
| | | 108" | QRSA1084-() () | 1,099. | 1,168. | 1,343. | 1,813. |
| | | 114" | QRSA1144-() () | 1,158. | 1,227. | 1,411. | 1,905. |
| | | 120" | QRSA1204-() () | 1,217. | 1,286. | 1,479. | 1,997. |

* For creating freestanding pedestal using standard Reff pedestal. Counterweights must be ordered separately.

| Order Code | Specification Information | Application Notes |
|------------------------------------|---|--|
| Example: QRSA903RL | <i>To order please specify pattern number including:</i> | Product on this page will accept woodgrain laminate where laminate is currently an option. List price for woodgrain laminate options will be current published laminate list price plus 10%. |
| QR Reff Standard Special | 1. Top thickness | |
| S Straight top | 2. Grommet option | Applicable finishes are listed on page 102 and 103. |
| A 1 1/4" thick | 3. Top finish type | |
| 90 90" wide | 4. Top finish | Knoll accepts no responsibility for special grommet locations which interfere with support or other hardware. All requests for special grommet locations must be approved through custom product development. |
| 3 30" deep | 5. Grommet finish | |
| R Recessed grommet location | <i>1. Thickness options:</i> A = 1 1/4" | Actual widths of worksurfaces are 1/8" less than nominal dimension. Actual depth is 1/8" less. |
| L Laminate finish | <i>2. Grommet options:</i> N = No grommets F = Flush front grommet location R = Recessed front (not recommended for 20"D and 24"D tops) A = Alternate location (for 36"D tops only) | |
| 114 Folkstone grey | <i>3. Finish type:</i> L = Laminate M = Wood/laminate mixed | |
| 111 Jet Black (grommet) | 1 = V1 2 = V2 3 = V3 | |

Reff Worksurfaces

1 1/4" thick straight rectilinear + Post

Standard Specials Systems

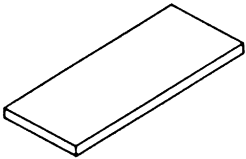
| description | d | w | pattern no. | lam. | M/V1 | V2 | V3 |
|---|----------------|---------------|---------------|--------|--------|--------|--------|
| Straight rectilinear work top + Post  | 20" | 26 1/2" | QRSAP261-()() | \$384. | \$420. | \$483. | \$652. |
| | | 32 1/2" | QRSAP321-()() | 406. | 443. | 509. | 688. |
| | | 38 1/2" | QRSAP381-()() | 421. | 464. | 534. | 720. |
| | | 44 1/2" | QRSAP441-()() | 443. | 480. | 552. | 745. |
| | | 50 1/2" | QRSAP501-()() | 460. | 499. | 574. | 775. |
| | | 56 1/2" | QRSAP561-()() | 497. | 540. | 621. | 838. |
| | | 62 1/2" | QRSAP621-()() | 509. | 557. | 641. | 865. |
| | | 68 1/2" | QRSAP681-()() | 538. | 586. | 674. | 910. |
| | | 74 1/2" | QRSAP741-()() | 545. | 592. | 681. | 919. |
| | | 80 1/2" | QRSAP801-()() | 577. | 634. | 729. | 984. |
| | | 86 1/2" | QRSAP861-()() | 604. | 658. | 757. | 1,022. |
| | | 92 1/2" | QRSAP921-()() | 627. | 683. | 785. | 1,060. |
| 98 1/2" | QRSAP981-()() | 686. | 742. | 853. | 1,152. | | |
| 104 1/2" | QRSAP1041-()() | 745. | 801. | 921. | 1,244. | | |
| 110 1/2" | QRSAP1101-()() | 804. | 860. | 989. | 1,335. | | |
| 24" | 26 1/2" | QRSAP262-()() | 417. | 453. | 521. | 703. | |
| | 32 1/2" | QRSAP322-()() | 431. | 474. | 545. | 736. | |
| | 38 1/2" | QRSAP382-()() | 448. | 487. | 560. | 756. | |
| | 44 1/2" | QRSAP442-()() | 476. | 524. | 603. | 814. | |
| | 50 1/2" | QRSAP502-()() | 509. | 557. | 641. | 865. | |
| | 56 1/2" | QRSAP562-()() | 549. | 599. | 689. | 930. | |
| | 62 1/2" | QRSAP622-()() | 563. | 617. | 710. | 958. | |
| | 68 1/2" | QRSAP682-()() | 591. | 644. | 741. | 1,000. | |
| | 74 1/2" | QRSAP742-()() | 617. | 675. | 776. | 1,048. | |
| | 80 1/2" | QRSAP802-()() | 643. | 703. | 808. | 1,091. | |
| | 86 1/2" | QRSAP862-()() | 675. | 734. | 844. | 1,140. | |
| | 92 1/2" | QRSAP922-()() | 699. | 762. | 876. | 1,183. | |
| 98 1/2" | QRSAP982-()() | 758. | 821. | 944. | 1,275. | | |
| 104 1/2" | QRSAP1042-()() | 817. | 880. | 1,012. | 1,366. | | |
| 110 1/2" | QRSAP1102-()() | 876. | 939. | 1,080. | 1,458. | | |
| 30" | 26 1/2" | QRSAP263-()() | 452. | 492. | 566. | 764. | |
| | 32 1/2" | QRSAP323-()() | 485. | 531. | 611. | 824. | |
| | 38 1/2" | QRSAP383-()() | 505. | 551. | 634. | 855. | |

Order Code

| | |
|------------|---------------------------|
| Example: | QRSAP263RL |
| QR | Reff Standard Special |
| S | Straight top |
| A | 1 1/4" thick |
| P | Post |
| 26 | 26 1/2" wide |
| 3 | 30" deep |
| R | Recessed grommet location |
| L | Laminate finish |
| 114 | Folkstone grey |
| 111 | Jet Black (grommet) |

Specification Information

To order please specify pattern number including:

1. Top thickness
2. Grommet option
3. Top finish type
4. Top finish
5. Grommet finish

1. Thickness options:
A = 1 1/4"

2. Grommet options:
N = No grommets
F = Flush front grommet location
R = Recessed front (not recommended for 20"D and 24"D tops)
A = Alternate location (for 36"D tops only)

3. Finish type:
L = Laminate
M = Wood/laminate mixed
1 = V1
2 = V2
3 = V3

Application Notes

Product on this page will accept woodgrain laminate where laminate is currently an option. List price for woodgrain laminate options will be current published laminate list price plus 10%.

Applicable finishes are listed on page 102 and 103.

Knoll accepts no responsibility for special grommet locations which interfere with support or other hardware. All requests for special grommet locations must be approved through custom product development.

Actual widths of worksurfaces are 1/8" less than nominal dimension. Actual depth is 1/8" less.

Products on this page are shipped without hardware which must be ordered separately from the support components section.

1 1/4" tops require support at mid point to reduce spans to 48" or less.

Reff System

Reff Worksurfaces

1 1/4" thick straight rectilinear + Post

Standard Specials Systems

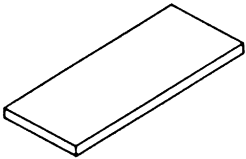
| description | d | w | pattern no. | lam. | M/V1 | V2 | V3 |
|---|-----|----------|----------------|--------|--------|--------|--------|
| Straight rectilinear work top + Post  | 30" | 44 1/2" | QRSAP443-()() | \$540. | \$589. | \$677. | \$914. |
| | | 50 1/2" | QRSAP503-()() | 584. | 637. | 733. | 989. |
| | | 56 1/2" | QRSAP563-()() | 605. | 660. | 759. | 1,025. |
| | | 62 1/2" | QRSAP623-()() | 616. | 674. | 775. | 1,046. |
| | | 68 1/2" | QRSAP683-()() | 634. | 690. | 793. | 1,071. |
| | | 74 1/2" | QRSAP743-()() | 662. | 723. | 831. | 1,122. |
| | | 80 1/2" | QRSAP803-()() | 688. | 752. | 865. | 1,167. |
| | | 86 1/2" | QRSAP863-()() | 721. | 786. | 904. | 1,220. |
| | | 92 1/2" | QRSAP923-()() | 746. | 815. | 937. | 1,265. |
| | | 98 1/2" | QRSAP983-()() | 805. | 874. | 1,005. | 1,357. |
| | | 104 1/2" | QRSAP1043-()() | 864. | 933. | 1,073. | 1,448. |
| | | 110 1/2" | QRSAP1103-()() | 923. | 992. | 1,141. | 1,540. |

Order Code

| | |
|------------|---------------------------|
| Example: | QRSAP263RL |
| QR | Reff Standard Special |
| S | Straight top |
| A | 1 1/4" thick |
| P | Post |
| 26 | 26 1/2" wide |
| 3 | 30" deep |
| R | Recessed grommet location |
| L | Laminate finish |
| 114 | Folkstone grey |
| 111 | Jet Black (grommet) |

Specification Information

To order please specify pattern number including:

1. Top thickness
2. Grommet option
3. Top finish type
4. Top finish
5. Grommet finish

1. Thickness options:
A = 1 1/4"

2. Grommet options:
N = No grommets
F = Flush front grommet location
R = Recessed front (not recommended for 20"D and 24"D tops)
A = Alternate location (for 36"D tops only)

3. Finish type:
L = Laminate
M = Wood/laminate mixed
1 = V1
2 = V2
3 = V3

Application Notes

Product on this page will accept woodgrain laminate where laminate is currently an option. List price for woodgrain laminate options will be current published laminate list price plus 10%.

Applicable finishes are listed on page 102 and 103.

Knoll accepts no responsibility for special grommet locations which interfere with support or other hardware. All requests for special grommet locations must be approved through custom product development.

Actual widths of worksurfaces are 1/16" less than nominal dimension. Actual depth is 1/8" less.

Products on this page are shipped without hardware which must be ordered separately from the support components section.

1 1/4" tops require support at mid point to reduce spans to 48" or less.

Reff Worksurfaces

1 3/4" thick straight rectilinear

Standard Specials Systems

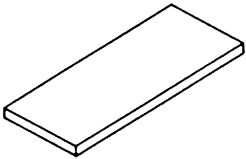
| description | d | w | pattern no. | lam. | M/V1 | V2 | V3 |
|--|-----|-----------------------|-----------------------|--------|--------|--------|----------|
| Straight rectilinear work top  | 20" | 16" | QRSB161-N-()* | \$455. | \$660. | \$759. | \$1,025. |
| | | 102" | QRSB1021-()() | 900. | 1,277. | 1,469. | 1,983. |
| | | 108" | QRSB1081-()() | 959. | 1,336. | 1,536. | 2,074. |
| | | 114" | QRSB1141-()() | 1,018. | 1,395. | 1,604. | 2,166. |
| | | 120" | QRSB1201-()() | 1,077. | 1,454. | 1,672. | 2,257. |
| | 24" | 16" | QRSB162-N-()* | 476. | 691. | 795. | 1,073. |
| | | 102" | QRSB1022-()() | 950. | 1,351. | 1,554. | 2,097. |
| | | 108" | QRSB1082-()() | 1,009. | 1,410. | 1,621. | 2,189. |
| | | 114" | QRSB1142-()() | 1,068. | 1,469. | 1,689. | 2,281. |
| | | 120" | QRSB1202-()() | 1,127. | 1,528. | 1,757. | 2,372. |
| | 30" | 16" | QRSB163-N-()* | 569. | 827. | 951. | 1,284. |
| | | 102" | QRSB1023-()() | 995. | 1,420. | 1,633. | 2,205. |
| | | 108" | QRSB1083-()() | 1,054. | 1,479. | 1,701. | 2,296. |
| | | 114" | QRSB1143-()() | 1,113. | 1,538. | 1,769. | 2,388. |
| | | 120" | QRSB1203-()() | 1,172. | 1,597. | 1,837. | 2,479. |
| | 36" | 48" | QRSB484-()() | 794. | 1,154. | 1,327. | 1,792. |
| | | 54" | QRSB544-()() | 818. | 1,186. | 1,364. | 1,841. |
| | | 78" | QRSB784-()() | 964. | 1,370. | 1,575. | 2,127. |
| | | 84" | QRSB844-()() | 1,023. | 1,429. | 1,643. | 2,219. |
| | | 90" | QRSB904-()() | 1,082. | 1,488. | 1,711. | 2,310. |
| 96" | | QRSB964-()() | 1,141. | 1,547. | 1,779. | 2,402. | |
| 102" | | QRSB1024-()() | 1,200. | 1,606. | 1,847. | 2,493. | |
| 108" | | QRSB1084-()() | 1,259. | 1,665. | 1,915. | 2,585. | |
| 114" | | QRSB1144-()() | 1,318. | 1,724. | 1,983. | 2,677. | |
| 120" | | QRSB1204-()() | 1,377. | 1,783. | 2,050. | 2,768. | |

* For creating freestanding pedestal using standard Reff pedestal. Counterweights must be ordered separately.

Order Code

| | |
|------------|---------------------------|
| Example: | QRSB903RL |
| QR | Reff Standard Special |
| S | Straight top |
| B | 1 3/4" thick |
| 90 | 90" wide |
| 3 | 30" deep |
| R | Recessed grommet location |
| L | Laminate finish |
| 114 | Folkstone grey |
| 111 | Jet Black (grommet) |

To order please specify pattern number including:

1. Top thickness
2. Grommet option
3. Top finish type
4. Top finish
5. Grommet finish

1. Thickness options:
B = 1 3/4"

2. Grommet options:
N = No grommets
F = Flush front grommet location
R = Recessed front (not recommended for 20"D and 24"D tops)

3. Finish type:
L = Laminate
M = Wood/laminate mixed
1 = V1
2 = V2
3 = V3

Applicable finishes are listed on page 102 and 103.

Knoll accepts no responsibility for special grommet locations which interfere with support or other hardware. All requests for special grommet locations must be approved through custom product development.

Actual widths of worksurfaces are 1/16" less than nominal dimension. Actual depth is 1/8" less.

1 3/4" thick laminate option is double post formed front and back, all others are edgebanded.

Products on this page are shipped without hardware which must be ordered separately from the support components section in standard Reff price list.

1 3/4" tops require support at mid point to reduce spans to 66" or less.

Mixed finish 1 3/4" tops are not post-formed.

Reff Worksurfaces

1 3/4" thick straight rectilinear + Post

Standard Specials Systems

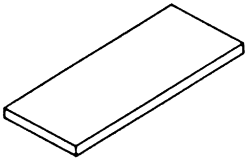
| description | d | w | pattern no. | lam. | M/V1 | V2 | V3 |
|---|----------|----------------|----------------|--------|--------|--------|----------|
| Straight rectilinear work top + Post  | 20" | 26 1/2" | QRSBP261-()() | \$472. | \$687. | \$790. | \$1,067. |
| | | 32 1/2" | QRSBP321-()() | 499. | 721. | 829. | 1,119. |
| | | 38 1/2" | QRSBP381-()() | 539. | 781. | 898. | 1,213. |
| | | 44 1/2" | QRSBP441-()() | 577. | 839. | 965. | 1,303. |
| | | 50 1/2" | QRSBP501-()() | 608. | 879. | 1,011. | 1,365. |
| | | 56 1/2" | QRSBP561-()() | 637. | 924. | 1,063. | 1,435. |
| | | 62 1/2" | QRSBP621-()() | 664. | 968. | 1,113. | 1,503. |
| | | 68 1/2" | QRSBP681-()() | 693. | 1,005. | 1,156. | 1,560. |
| | | 74 1/2" | QRSBP741-()() | 729. | 1,057. | 1,216. | 1,641. |
| | | 80 1/2" | QRSBP801-()() | 767. | 1,113. | 1,280. | 1,728. |
| | | 86 1/2" | QRSBP861-()() | 800. | 1,166. | 1,341. | 1,810. |
| | | 92 1/2" | QRSBP921-()() | 841. | 1,218. | 1,401. | 1,891. |
| | | 98 1/2" | QRSBP981-()() | 900. | 1,277. | 1,469. | 1,983. |
| | | 104 1/2" | QRSBP1041-()() | 959. | 1,336. | 1,536. | 2,074. |
| | | 110 1/2" | QRSBP1101-()() | 1,018. | 1,395. | 1,604. | 2,166. |
| 24" | 26 1/2" | QRSBP262-()() | 523. | 758. | 872. | 1,177. | |
| | 32 1/2" | QRSBP322-()() | 546. | 793. | 912. | 1,231. | |
| | 38 1/2" | QRSBP382-()() | 586. | 854. | 982. | 1,326. | |
| | 44 1/2" | QRSBP442-()() | 627. | 909. | 1,045. | 1,411. | |
| | 50 1/2" | QRSBP502-()() | 655. | 950. | 1,093. | 1,475. | |
| | 56 1/2" | QRSBP562-()() | 684. | 991. | 1,140. | 1,539. | |
| | 62 1/2" | QRSBP622-()() | 714. | 1,035. | 1,190. | 1,607. | |
| | 68 1/2" | QRSBP682-()() | 741. | 1,075. | 1,236. | 1,669. | |
| | 74 1/2" | QRSBP742-()() | 779. | 1,128. | 1,297. | 1,751. | |
| | 80 1/2" | QRSBP802-()() | 815. | 1,182. | 1,359. | 1,835. | |
| | 86 1/2" | QRSBP862-()() | 852. | 1,239. | 1,425. | 1,924. | |
| | 92 1/2" | QRSBP922-()() | 891. | 1,292. | 1,486. | 2,006. | |
| | 98 1/2" | QRSBP982-()() | 950. | 1,351. | 1,554. | 2,097. | |
| | 104 1/2" | QRSBP1042-()() | 1,009. | 1,410. | 1,621. | 2,189. | |
| | 110 1/2" | QRSBP1102-()() | 1,068. | 1,469. | 1,689. | 2,281. | |
| 30" | 26 1/2" | QRSBP263-()() | 588. | 856. | 984. | 1,329. | |
| | 32 1/2" | QRSBP323-()() | 611. | 887. | 1,020. | 1,377. | |
| | 38 1/2" | QRSBP383-()() | 643. | 935. | 1,075. | 1,452. | |

Order Code

| | |
|------------|---------------------------|
| Example: | QRSBP503RL |
| QR | Reff Standare Special |
| S | Straight top |
| B | 1 3/4" thick |
| P | Post |
| 50 | 24" wide |
| 3 | 30" deep |
| R | Recessed grommet location |
| L | Laminate finish |
| 114 | Folkstone grey |
| 111 | Jet Black (grommet) |

Specification Information

To order please specify pattern number including:

1. Top thickness
2. Grommet option
3. Top finish type
4. Top finish
5. Grommet finish

1. Thickness options:
B = 1 3/4"

2. Grommet options:
N = No grommets
F = Flush front grommet location
R = Recessed front (not recommended for 20"D and 24"D tops)

3. Finish type:
L = Laminate
M = Wood/laminate mixed
1 = V1
2 = V2
3 = V3

Applicable finishes are listed on page 102 and 103.

Knoll accepts no responsibility for special grommet locations which interfere with support or other hardware. All requests for special grommet locations must be approved through custom product development.

Actual widths of worksurfaces are 1/16" less than nominal dimension. Actual depth is 1/8" less.

Application Notes

1 3/4" thick laminate option is double post formed front and back, all others are edgebanded.

Products on this page are shipped without hardware which must be ordered separately from the support components section in standard Reff price list.

1 3/4" tops require support at mid point to reduce spans to 66" or less.

Mixed finish 1 3/4" tops are not post-formed.

Reff Worksurfaces

1 3/4" thick straight rectilinear + Post

Standard Specials Systems

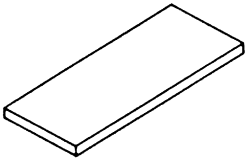
| description | d | w | pattern no. | lam. | M/V1 | V2 | V3 |
|---|-----|----------|----------------|--------|--------|----------|----------|
| Straight rectilinear work top + Post  | 30" | 44 1/2" | QRSBP443-()() | \$676. | \$978. | \$1,125. | \$1,518. |
| | | 50 1/2" | QRSBP503-()() | 707. | 1,022. | 1,175. | 1,587. |
| | | 56 1/2" | QRSBP563-()() | 730. | 1,058. | 1,217. | 1,643. |
| | | 62 1/2" | QRSBP623-()() | 760. | 1,103. | 1,268. | 1,712. |
| | | 68 1/2" | QRSBP683-()() | 789. | 1,143. | 1,314. | 1,775. |
| | | 74 1/2" | QRSBP743-()() | 826. | 1,199. | 1,379. | 1,861. |
| | | 80 1/2" | QRSBP803-()() | 865. | 1,254. | 1,442. | 1,947. |
| | | 86 1/2" | QRSBP863-()() | 899. | 1,306. | 1,502. | 2,028. |
| | | 92 1/2" | QRSBP923-()() | 936. | 1,361. | 1,565. | 2,113. |
| | | 98 1/2" | QRSBP983-()() | 995. | 1,420. | 1,633. | 2,205. |
| | | 104 1/2" | QRSBP1043-()() | 1,054. | 1,479. | 1,701. | 2,296. |
| | | 110 1/2" | QRSBP1103-()() | 1,113. | 1,538. | 1,769. | 2,388. |

Reff System

Order Code

| | |
|------------|---------------------------|
| Example: | QRSBP503RL |
| QR | Reff Standare Special |
| S | Straight top |
| B | 1 3/4" thick |
| P | Post |
| 50 | 24" wide |
| 3 | 30" deep |
| R | Recessed grommet location |
| L | Laminate finish |
| 114 | Folkstone grey |
| 111 | Jet Black (grommet) |

Specification Information

To order please specify pattern number including:

1. Top thickness
2. Grommet option
3. Top finish type
4. Top finish
5. Grommet finish

1. Thickness options:
B = 1 3/4"

2. Grommet options:
N = No grommets
F = Flush front grommet location
R = Recessed front (not recommended for 20"D and 24"D tops)

3. Finish type:
L = Laminate
M = Wood/laminate mixed
1 = V1
2 = V2
3 = V3

Applicable finishes are listed on page 102 and 103.

Knoll accepts no responsibility for special grommet locations which interfere with support or other hardware. All requests for special grommet locations must be approved through custom product development.

Actual widths of worksurfaces are 1/16" less than nominal dimension. Actual depth is 1/8" less.

Application Notes

1 3/4" thick laminate option is double post formed front and back, all others are edgebanded.

Products on this page are shipped without hardware which must be ordered separately from the support components section in standard Reff price list.

1 3/4" tops require support at mid point to reduce spans to 66" or less.

Mixed finish 1 3/4" tops are not post-formed.

Reff Worksurfaces
for calibre file
1 1/4" thick

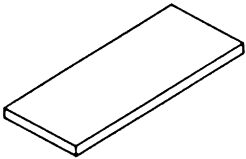
| description | d | w | pattern no. | lam. | M/V1 | V2 | V3 |
|---|-----|------|-----------------|--------|--------|--------|--------|
| File top, 1 1/4" thick  | 18" | 30" | QRSAC3018-()() | \$384. | \$420. | \$483. | \$652. |
| | | 36" | QRSAC3618-()() | 406. | 443. | 509. | 688. |
| | | 42" | QRSAC4218-()() | 421. | 464. | 534. | 720. |
| | | 48" | QRSAC4818-()() | 443. | 480. | 552. | 745. |
| | | 54" | QRSAC5418-()() | 460. | 499. | 574. | 775. |
| | | 60" | QRSAC6018-()() | 497. | 540. | 621. | 838. |
| | | 66" | QRSAC6618-()() | 510. | 557. | 641. | 865. |
| | | 72" | QRSAC7218-()() | 538. | 586. | 674. | 910. |
| | | 78" | QRSAC7818-()() | 549. | 592. | 681. | 919. |
| | | 84" | QRSAC8418-()() | 577. | 634. | 729. | 984. |
| | | 90" | QRSAC9018-()() | 604. | 658. | 757. | 1,022. |
| | | 96" | QRSAC9618-()() | 627. | 683. | 785. | 1,060. |
| | | 102" | QRSAC10218-()() | 686. | 742. | 853. | 1,152. |
| | | 108" | QRSAC10818-()() | 745. | 801. | 921. | 1,244. |
| | 36" | 36" | QRSAC3636-()() | 627. | 683. | 785. | 1,060. |
| | | 42" | QRSAC4236-()() | 650. | 709. | 815. | 1,101. |
| | | 54" | QRSAC5436-()() | 674. | 735. | 845. | 1,141. |
| | | 60" | QRSAC6036-()() | 697. | 761. | 875. | 1,181. |
| | | 66" | QRSAC6636-()() | 721. | 787. | 905. | 1,222. |
| | | 72" | QRSAC7236-()() | 745. | 814. | 936. | 1,264. |
| | | 78" | QRSAC7836-()() | 804. | 873. | 1,004. | 1,355. |
| | | 84" | QRSAC8436-()() | 863. | 932. | 1,072. | 1,447. |
| | | 90" | QRSAC9036-()() | 922. | 991. | 1,140. | 1,539. |

| Order Code | Specification Information | Application Notes |
|---------------------------------|--|---|
| Example: QRSAC3018 | <i>To order please specify pattern number including:</i> | Product on this page will accept woodgrain laminate where laminate is currently an option. |
| QR Reff Standard Special | 1. Top thickness | List price for woodgrain laminate options will be current published laminate list price plus 10%. |
| S Straight top | 2. Top finish type | Applicable finishes are listed on page 102 and 103. |
| A 1 1/4" thick | 3. Top finish | |
| C For calibre file | 1. Thickness options: A = 1 1/4" B = 1 3/4" | 1 3/4" thick laminate option is double post formed front and back, all others are edgebanded. |
| 30 30" wide | 3. Finish type: L = Laminate M = Wood/laminate mixed | Products on this page are exact width and depth and have no grommet or drilling. |
| 18 18" deep | 1 = V1 | Mixed finish 1 3/4" tops are not post-formed. |
| L Laminate finish | 2 = V2 | |
| 114 Folkstone grey | 3 = V3 | |

Reff Worksurfaces
for calibre file
1 3/4" thick

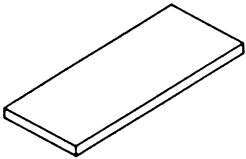
| description | d | w | pattern no. | lam. | M/V1 | V2 | V3 |
|---|-----|------|-----------------|--------|--------|--------|----------|
| File top, 1 3/4" thick  | 18" | 30" | QRSBC3018-()() | \$472. | \$687. | \$790. | \$1,067. |
| | | 36" | QRSBC3618-()() | 499. | 721. | 829. | 1,119. |
| | | 42" | QRSBC4218-()() | 539. | 781. | 898. | 1,213. |
| | | 48" | QRSBC4818-()() | 577. | 839. | 965. | 1,303. |
| | | 54" | QRSBC5418-()() | 608. | 879. | 1,011. | 1,365. |
| | | 60" | QRSBC6018-()() | 637. | 924. | 1,063. | 1,435. |
| | | 66" | QRSBC6618-()() | 664. | 968. | 1,113. | 1,503. |
| | | 72" | QRSBC7218-()() | 693. | 1,005. | 1,156. | 1,560. |
| | | 78" | QRSBC7818-()() | 729. | 1,057. | 1,216. | 1,641. |
| | | 84" | QRSBC8418-()() | 767. | 1,113. | 1,280. | 1,728. |
| | | 90" | QRSBC9018-()() | 800. | 1,166. | 1,341. | 1,810. |
| | | 96" | QRSBC9618-()() | 841. | 1,218. | 1,401. | 1,891. |
| | | 102" | QRSBC10218-()() | 900. | 1,277. | 1,469. | 1,983. |
| | | 108" | QRSBC10818-()() | 959. | 1,336. | 1,536. | 2,074. |
| | 36" | 36" | QRSBC3636-()() | 747. | 1,090. | 1,254. | 1,692. |
| | | 42" | QRSBC4236-()() | 771. | 1,122. | 1,290. | 1,742. |
| | | 54" | QRSBC5436-()() | 794. | 1,154. | 1,327. | 1,792. |
| | | 60" | QRSBC6036-()() | 818. | 1,186. | 1,364. | 1,841. |
| | | 66" | QRSBC6636-()() | 841. | 1,218. | 1,401. | 1,891. |
| | | 72" | QRSBC7236-()() | 905. | 1,311. | 1,508. | 2,035. |
| | | 78" | QRSBC7836-()() | 964. | 1,370. | 1,575. | 2,127. |
| | | 84" | QRSBC8436-()() | 1,023. | 1,429. | 1,643. | 2,219. |
| | | 90" | QRSBC9036-()() | 1,082. | 1,488. | 1,711. | 2,310. |

| Order Code | Specification Information | Application Notes |
|---------------------------------|--|---|
| Example: QRSBC3018 | <i>To order please specify pattern number including:</i> | 1 3/4" thick laminate option is double post formed front and back, all others are edgebanded. |
| QR Reff Standard Special | 1. Top thickness | Products on this page are exact width and depth and have no grommet or drilling. |
| S Straight top | 2. Top finish type | Mixed finish 1 3/4" tops are not post-formed. |
| B 1 3/4" thick | 3. Top finish | |
| C For calibre file | <i>1. Thickness options:</i> | |
| 30 30" wide | A = 1 1/4" | |
| 18 18" deep | B = 1 3/4" | |
| L Laminate finish | <i>3. Finish type:</i> | |
| 114 Folkstone grey | L = Laminate | |
| | M = Wood/laminate mixed | |
| | 1 = V1 | |
| | 2 = V2 | |
| | 3 = V3 | |

Applicable finishes are listed on page 102 and 103.

1 1/4" thick extended curvilinear corner tops

Left hand

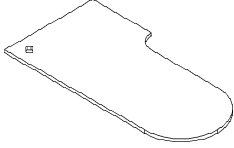
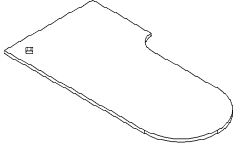
| description | w | d | pattern no. | lam. | M/V1 | V2 | V3 |
|---|--|-----|--------------------------|--------------------------|----------|----------|----------|
| Extended corner worktop, LH 24" deep return, 30" deep rounded  | 36" | 60" | QRCCDLA23660 () () () | \$1,909. | \$2,533. | \$2,913. | \$3,932. |
| | | 66" | QRCCDLA23666 () () () | 1,988. | 2,638. | 3,034. | 4,095. |
| | | 90" | QRCCDLA23690 () () () | 2,237. | 2,968. | 3,413. | 4,608. |
| | 42" | 60" | QRCCDLA24260 () () () | 2,125. | 2,780. | 3,197. | 4,316. |
| | | 66" | QRCCDLA24266 () () () | 2,165. | 2,833. | 3,258. | 4,398. |
| | | 72" | QRCCDLA24272 () () () | 2,205. | 2,886. | 3,319. | 4,481. |
| | | 78" | QRCCDLA24278 () () () | 2,244. | 2,938. | 3,379. | 4,561. |
| | | 84" | QRCCDLA24284 () () () | 2,327. | 3,049. | 3,506. | 4,734. |
| | | 90" | QRCCDLA24290 () () () | 2,371. | 3,106. | 3,572. | 4,822. |
| | | 96" | QRCCDLA24296 () () () | 2,414. | 3,162. | 3,636. | 4,909. |
| | 48" | 60" | QRCCDLA24860 () () () | 2,302. | 2,975. | 3,421. | 4,619. |
| | | 66" | QRCCDLA24866 () () () | 2,342. | 3,028. | 3,482. | 4,701. |
| | | 72" | QRCCDLA24872 () () () | 2,382. | 3,081. | 3,543. | 4,783. |
| | | 78" | QRCCDLA24878 () () () | 2,421. | 3,133. | 3,603. | 4,864. |
| | | 84" | QRCCDLA24884 () () () | 2,504. | 3,244. | 3,731. | 5,036. |
| | | 90" | QRCCDLA24890 () () () | 2,548. | 3,300. | 3,795. | 5,123. |
| | | 96" | QRCCDLA24896 () () () | 2,591. | 3,357. | 3,861. | 5,212. |
| | Extended corner worktop, LH 30" deep return, 30" deep rounded  | 36" | 60" | QRCCDLA33660 () () () | 1,909. | 2,533. | 2,913. |
| 66" | | | QRCCDLA33666 () () () | 1,988. | 2,638. | 3,034. | 4,095. |
| 90" | | | QRCCDLA33690 () () () | 2,237. | 2,968. | 3,413. | 4,608. |
| 42" | | 60" | QRCCDLA34260 () () () | 2,125. | 2,780. | 3,197. | 4,316. |
| | | 66" | QRCCDLA34266 () () () | 2,165. | 2,833. | 3,258. | 4,398. |
| | | 72" | QRCCDLA34272 () () () | 2,205. | 2,886. | 3,319. | 4,481. |
| | | 78" | QRCCDLA34278 () () () | 2,244. | 2,938. | 3,379. | 4,561. |
| | | 84" | QRCCDLA34284 () () () | 2,327. | 3,049. | 3,506. | 4,734. |
| | | 90" | QRCCDLA34290 () () () | 2,371. | 3,106. | 3,572. | 4,822. |
| | | 96" | QRCCDLA34296 () () () | 2,414. | 3,162. | 3,636. | 4,909. |
| 48" | | 60" | QRCCDLA34860 () () () | 2,302. | 2,975. | 3,421. | 4,619. |
| | | 66" | QRCCDLA34866 () () () | 2,342. | 3,028. | 3,482. | 4,701. |
| | | 72" | QRCCDLA34872 () () () | 2,382. | 3,081. | 3,543. | 4,783. |
| | | 78" | QRCCDLA34878 () () () | 2,421. | 3,133. | 3,603. | 4,864. |
| | | 84" | QRCCDLA34884 () () () | 2,504. | 3,244. | 3,731. | 5,036. |
| | | 90" | QRCCDLA34890 () () () | 2,548. | 3,300. | 3,795. | 5,123. |
| | | 96" | QRCCDLA34896 () () () | 2,591. | 3,357. | 3,861. | 5,212. |

Order Code

Specification Information

| | |
|----------|--|
| Example: | QRCCDLA23660N2 |
| QR | Reff Standard Special |
| CC | Curved corner |
| D | D top |
| L | Left Hand |
| A | 1 1/4" thick |
| 2 | 24" return |
| 36 | 36" d at straight edge of corner, 30" across "D" |
| 60 | 60" wide |
| N | No grommet |
| 2 | V2 finish |
| V319 | Medium Cherry |

To order please specify pattern number including:

1. Depth
2. Grommet option
3. Finish type
4. Finish
5. Grommet finish

2. Grommet options:
N = No grommets
F = Flush front grommet location

3. Finish type:
L = Laminate
M = Mixed (laminated surface with wood edge)
1 = V1
2 = V2
3 = V3

Product on this page will accept woodgrain laminate where laminate is currently an option.
List price for woodgrain laminate options will be current published laminate list price plus 10%.
Applicable finishes are listed on page 102 and 103.

Reff Worksurfaces

1 1/4" thick extended curvilinear corner tops

right hand

Standard Specials Systems

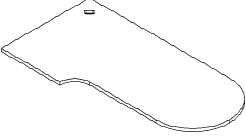
| description | w | d | pattern no. | lam. | M/V1 | V2 | V3 |
|---|--|-----|--------------------------|--------------------------|----------|----------|----------|
| Extended corner worktop, RH 24" deep return, 30" deep rounded  | 36" | 60" | QRCCDRA23660 () () () | \$1,909. | \$2,533. | \$2,913. | \$3,932. |
| | | 66" | QRCCDRA23666 () () () | 1,988. | 2,638. | 3,034. | 4,095. |
| | | 90" | QRCCDRA23690 () () () | 2,237. | 2,968. | 3,413. | 4,608. |
| | 42" | 60" | QRCCDRA24260 () () () | 2,125. | 2,780. | 3,197. | 4,316. |
| | | 66" | QRCCDRA24266 () () () | 2,165. | 2,833. | 3,258. | 4,398. |
| | | 72" | QRCCDRA24272 () () () | 2,205. | 2,886. | 3,319. | 4,481. |
| | | 78" | QRCCDRA24278 () () () | 2,244. | 2,938. | 3,379. | 4,561. |
| | | 84" | QRCCDRA24284 () () () | 2,327. | 3,049. | 3,506. | 4,734. |
| | | 90" | QRCCDRA24290 () () () | 2,371. | 3,106. | 3,572. | 4,822. |
| | | 96" | QRCCDRA24296 () () () | 2,414. | 3,162. | 3,636. | 4,909. |
| | 48" | 60" | QRCCDRA24860 () () () | 2,302. | 2,975. | 3,421. | 4,619. |
| | | 66" | QRCCDRA24866 () () () | 2,342. | 3,028. | 3,482. | 4,701. |
| | | 72" | QRCCDRA24872 () () () | 2,382. | 3,081. | 3,543. | 4,783. |
| | | 78" | QRCCDRA24878 () () () | 2,421. | 3,133. | 3,603. | 4,864. |
| | | 84" | QRCCDRA24884 () () () | 2,504. | 3,244. | 3,731. | 5,036. |
| | | 90" | QRCCDRA24890 () () () | 2,548. | 3,300. | 3,795. | 5,123. |
| | | 96" | QRCCDRA24896 () () () | 2,591. | 3,357. | 3,861. | 5,212. |
| | Extended corner worktop, RH 30" deep return, 30" deep rounded  | 36" | 60" | QRCCDRA33660 () () () | 1,909. | 2,533. | 2,913. |
| 66" | | | QRCCDRA33666 () () () | 1,988. | 2,638. | 3,034. | 4,095. |
| 90" | | | QRCCDRA33690 () () () | 2,237. | 2,968. | 3,413. | 4,608. |
| 42" | | 60" | QRCCDRA34260 () () () | 2,125. | 2,780. | 3,197. | 4,316. |
| | | 66" | QRCCDRA34266 () () () | 2,165. | 2,833. | 3,258. | 4,398. |
| | | 72" | QRCCDRA34272 () () () | 2,205. | 2,886. | 3,319. | 4,481. |
| | | 78" | QRCCDRA34278 () () () | 2,244. | 2,938. | 3,379. | 4,561. |
| | | 84" | QRCCDRA34284 () () () | 2,327. | 3,049. | 3,506. | 4,734. |
| | | 90" | QRCCDRA34290 () () () | 2,371. | 3,106. | 3,572. | 4,822. |
| | | 96" | QRCCDRA34296 () () () | 2,414. | 3,162. | 3,636. | 4,909. |
| 48" | | 60" | QRCCDRA34860 () () () | 2,302. | 2,975. | 3,421. | 4,619. |
| | | 66" | QRCCDRA34866 () () () | 2,342. | 3,028. | 3,482. | 4,701. |
| | | 72" | QRCCDRA34872 () () () | 2,382. | 3,081. | 3,543. | 4,783. |
| | | 78" | QRCCDRA34878 () () () | 2,421. | 3,133. | 3,603. | 4,864. |
| | | 84" | QRCCDRA34884 () () () | 2,504. | 3,244. | 3,731. | 5,036. |
| | | 90" | QRCCDRA34890 () () () | 2,548. | 3,300. | 3,795. | 5,123. |
| | | 96" | QRCCDRA34896 () () () | 2,591. | 3,357. | 3,861. | 5,212. |

Reff System

Order Code

| | |
|-------------|--|
| Example: | QRCCDRA23660N2 |
| QR | Reff Standard Special |
| CC | Curved corner |
| D | D top |
| R | Right Hand |
| A | 1 1/4" thick |
| 2 | 24" return |
| 36 | 36" d at straight edge of corner, 30" across "D" |
| 60 | 60" wide |
| N | No grommet |
| 2 | V2 finish |
| V319 | Medium Cherry |

Specification Information

To order please specify pattern number including:

1. Depth
2. Grommet option
3. Finish type
4. Finish
5. Grommet finish

2. Grommet options:
N = No grommets
F = Flush front grommet location

3. Finish type:
L = Laminate
M = Mixed (laminated surface with wood edge)
1 = V1
2 = V2
3 = V3

Product on this page will accept woodgrain laminate where laminate is currently an option. List price for woodgrain laminate options will be current published laminate list price plus 10%.

Applicable finishes are listed on page 102 and 103.

Reff Worksurfaces
 1 1/4" thick extended straight corner tops
 left and right hand

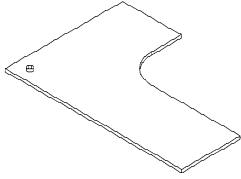
| description | d | w | pattern no. | lam. | M/V1 | V2 | V3 |
|--|-----|-----|--------------------------|--------|----------|----------|----------|
| Extended straight corner top, LH curved front corner 12" radius 24" deep return  | 54" | 36" | QRCEAL223654 () () () | \$736. | \$1,087. | \$1,250. | \$1,688. |
| | 54" | 42" | QRCEAL224254 () () () | 809. | 1,200. | 1,380. | 1,863. |
| | 60" | 48" | QRCEAL224860 () () () | 958. | 1,434. | 1,649. | 2,226. |
| | 66" | 36" | QRCEAL223666 () () () | 883. | 1,318. | 1,516. | 2,046. |
| | 66" | 42" | QRCEAL224266 () () () | 957. | 1,434. | 1,649. | 2,226. |
| | 66" | 48" | QRCEAL224866 () () () | 1,031. | 1,549. | 1,781. | 2,405. |
| | 78" | 36" | QRCEAL223678 () () () | 942. | 1,454. | 1,672. | 2,257. |
| | 78" | 42" | QRCEAL224278 () () () | 1,016. | 1,569. | 1,804. | 2,436. |
| | 78" | 48" | QRCEAL224878 () () () | 1,178. | 1,781. | 2,048. | 2,765. |
| | 84" | 36" | QRCEAL223684 () () () | 1,001. | 1,589. | 1,827. | 2,467. |
| | 84" | 42" | QRCEAL224284 () () () | 1,075. | 1,705. | 1,961. | 2,647. |
| | 90" | 36" | QRCEAL223690 () () () | 1,060. | 1,725. | 1,984. | 2,678. |
| | 90" | 42" | QRCEAL224290 () () () | 1,134. | 1,841. | 2,117. | 2,858. |
| | 90" | 48" | QRCEAL224890 () () () | 1,353. | 2,052. | 2,360. | 3,186. |
| | 96" | 36" | QRCEAL223696 () () () | 1,119. | 1,861. | 2,140. | 2,889. |
| | 96" | 42" | QRCEAL224296 () () () | 1,193. | 1,977. | 2,274. | 3,069. |

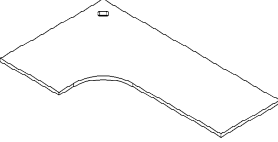
| | | | | | | | |
|---|-----|-----|--------------------------|--------|--------|--------|--------|
| Extended straight corner top, RH curved front corner 12" radius 24" deep return  | 54" | 36" | QRCEAR223654 () () () | 736. | 1,087. | 1,250. | 1,688. |
| | 54" | 42" | QRCEAR224254 () () () | 809. | 1,200. | 1,380. | 1,863. |
| | 60" | 48" | QRCEAR224860 () () () | 958. | 1,434. | 1,649. | 2,226. |
| | 66" | 36" | QRCEAR223666 () () () | 883. | 1,318. | 1,516. | 2,046. |
| | 66" | 42" | QRCEAR224266 () () () | 957. | 1,434. | 1,649. | 2,226. |
| | 66" | 48" | QRCEAR224866 () () () | 1,031. | 1,549. | 1,781. | 2,405. |
| | 78" | 36" | QRCEAR223678 () () () | 942. | 1,454. | 1,672. | 2,257. |
| | 78" | 42" | QRCEAR224278 () () () | 1,016. | 1,569. | 1,804. | 2,436. |
| | 78" | 48" | QRCEAR224878 () () () | 1,178. | 1,781. | 2,048. | 2,765. |
| | 84" | 36" | QRCEAR223684 () () () | 1,001. | 1,589. | 1,827. | 2,467. |
| | 84" | 42" | QRCEAR224284 () () () | 1,075. | 1,705. | 1,961. | 2,647. |
| | 90" | 36" | QRCEAR223690 () () () | 1,060. | 1,725. | 1,984. | 2,678. |
| | 90" | 42" | QRCEAR224290 () () () | 1,134. | 1,841. | 2,117. | 2,858. |
| | 90" | 48" | QRCEAR224890 () () () | 1,353. | 2,052. | 2,360. | 3,186. |
| | 96" | 36" | QRCEAR223696 () () () | 1,119. | 1,861. | 2,140. | 2,889. |
| | 96" | 42" | QRCEAR224296 () () () | 1,193. | 1,977. | 2,274. | 3,069. |

Order Code

| | |
|----------|-------------------------------|
| Example: | QRCEAL223654N2 |
| QR | Reff Standard Special |
| C | Corner |
| E | Extended |
| A | 1 1/4" thick |
| L | Left Hand |
| 22 | 24" returns |
| 36 | 36" d at corner straight edge |
| 54 | 54" wide |
| N | No grommet |
| 2 | V2 finish |
| V319 | Medium Cherry |

Specification Information

To order please specify pattern number including:

1. Return left hand depth
2. Return right hand depth
3. Width
4. Depth
5. Grommet option
6. Finish type
7. Finish
8. Grommet finish

5. Grommet options:

- N = No grommets
- F = Flush front grommet location

6. Finish type:

- L = Laminate
- M = Mixed (laminated surface with wood edge)
- 1 = V1
- 2 = V2
- 3 = V3

Product on this page will accept woodgrain laminate where laminate is currently an option.

List price for woodgrain laminate options will be current published laminate list price plus 10%.

Applicable finishes are listed on page 102 and 103.

Meeting tops

1 1/4" thick

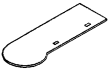
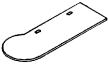
| description | w | d | pattern no. | lam. | M/V1 | V2 | V3 |
|--|-----|-----|------------------------|----------|----------|----------|----------|
| Worksurface 9-top  42" diameter | 54" | 30" | QRMA9A5430 N () () | \$1,679. | \$1,823. | \$2,096. | \$2,830. |
| | 54" | 36" | QRMA9A5436 N () () | 1,679. | 1,823. | 2,096. | 2,830. |
| | 60" | 30" | QRMA9A6030 N () () | 1,703. | 1,849. | 2,126. | 2,871. |
| | 60" | 36" | QRMA9A6036 N () () | 1,703. | 1,849. | 2,126. | 2,871. |
| | 66" | 30" | QRMA9A6630 () () () | 1,726. | 1,875. | 2,156. | 2,911. |
| | 66" | 36" | QRMA9A6636 () () () | 1,726. | 1,875. | 2,156. | 2,911. |
| | 72" | 30" | QRMA9A7230 () () () | 1,750. | 1,901. | 2,186. | 2,951. |
| | 72" | 36" | QRMA9A7236 () () () | 1,750. | 1,901. | 2,186. | 2,951. |
| | 78" | 30" | QRMA9A7830 () () () | 1,774. | 1,927. | 2,216. | 2,992. |
| | 78" | 36" | QRMA9A7836 () () () | 1,774. | 1,927. | 2,216. | 2,992. |
| | 84" | 36" | QRMA9A8436 () () () | 1,823. | 1,985. | 2,283. | 3,082. |
| | 96" | 36" | QRMA9A9636 () () () | 1,847. | 2,011. | 2,313. | 3,122. |
| Worksurface P-top  42" diameter | 54" | 30" | QRMPA5430 N () () | 1,679. | 1,823. | 2,096. | 2,830. |
| | 54" | 36" | QRMPA5436 N () () | 1,679. | 1,823. | 2,096. | 2,830. |
| | 60" | 30" | QRMPA6030 N () () | 1,703. | 1,849. | 2,126. | 2,871. |
| | 60" | 36" | QRMPA6036 N () () | 1,703. | 1,849. | 2,126. | 2,871. |
| | 66" | 30" | QRMPA6630 () () () | 1,726. | 1,875. | 2,156. | 2,911. |
| | 66" | 36" | QRMPA6636 () () () | 1,726. | 1,875. | 2,156. | 2,911. |
| | 72" | 30" | QRMPA7230 () () () | 1,750. | 1,901. | 2,186. | 2,951. |
| | 72" | 36" | QRMPA7236 () () () | 1,750. | 1,901. | 2,186. | 2,951. |
| | 78" | 30" | QRMPA7830 () () () | 1,774. | 1,927. | 2,216. | 2,992. |
| | 78" | 36" | QRMPA7836 () () () | 1,774. | 1,927. | 2,216. | 2,992. |
| | 84" | 36" | QRMPA8436 () () () | 1,823. | 1,985. | 2,283. | 3,082. |
| | 96" | 36" | QRMPA9636 () () () | 1,847. | 2,011. | 2,313. | 3,122. |

| Order Code | Specification Information | Application Information |
|---|---|--|
| Example: QRMPA5430N1 QR Reff Standard Special M9 Meeting 9-top A 1 1/4" thick 54 54" wide 30 30" deep N No grommet 1 V1 Y311 Beech | To order please specify pattern number including: 1. Top thickness 2. Width 3. Depth 4. Grommet option 5. Top finish type 6. Top finish 7. Grommet finish 1. Thickness options: A = 1 1/4" B = 1 3/4" 4. Grommet options: N = No grommet F = Flush front grommet location R = Recessed grommet location 5. Finish type: L = Laminate M = Wood/laminate mixed 1 = V1 2 = V2 3 = V3 | Actual widths of worksurface are 1/16" less than nominal dimension. Actual depth is 1/8" less than nominal dimension. Product on this page will accept woodgrain laminate where laminate is currently an option. List price for woodgrain laminate options will be current published laminate list price plus 10%. Applicable finishes are listed on page 102 and 103. See Planning Guide for standard grommet locations. Knoll assumes no responsibility for special grommet locations which interfere with support or other hardware. |

Refer to Planning Guide for modesty panel size requirements and all other support options.

1 3/4" laminate tops on this page are edge banded to match post-formed contours.

Products on this page are shipped without hardware which must be ordered separately from the support components section in standard Reff price list.

1 1/4" tops require support at mid point to reduce 48" spans or less.

1 3/4" tops require support at mid point to reduce spans to 66" or less.

Mixed finish 1 3/4" tops are not post-formed.

Meeting tops

1 3/4" thick

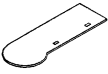
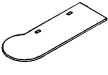
| description | w | d | pattern no. | lam. | M/V1 | V2 | V3 |
|---|-----|-----|---------------------------|----------|----------|----------|----------|
|  <p>Worksurface 9-top 42" diameter</p> | 54" | 30" | QRMPB5430 N () () () | \$1,857. | \$2,274. | \$2,615. | \$3,530. |
| | 54" | 36" | QRMPB5436 N () () () | 1,857. | 2,274. | 2,615. | 3,530. |
| | 60" | 30" | QRMPB6030 N () () () | 1,881. | 2,300. | 2,645. | 3,571. |
| | 60" | 36" | QRMPB6036 N () () () | 1,881. | 2,300. | 2,645. | 3,571. |
| | 66" | 30" | QRMPB6630 () () () () | 1,905. | 2,326. | 2,675. | 3,611. |
| | 66" | 36" | QRMPB6636 () () () () | 1,905. | 2,326. | 2,675. | 3,611. |
| | 72" | 30" | QRMPB7230 () () () () | 1,928. | 2,352. | 2,705. | 3,651. |
| | 72" | 36" | QRMPB7236 () () () () | 1,928. | 2,352. | 2,705. | 3,651. |
| | 78" | 30" | QRMPB7830 () () () () | 1,952. | 2,378. | 2,735. | 3,692. |
| | 78" | 36" | QRMPB7836 () () () () | 1,952. | 2,378. | 2,735. | 3,692. |
| | 84" | 36" | QRMPB8436 () () () () | 2,007. | 2,451. | 2,819. | 3,805. |
| | 96" | 36" | QRMPB9636 () () () () | 2,031. | 2,477. | 2,849. | 3,846. |
|  <p>Worksurface P-top 42" diameter</p> | 54" | 30" | QRMPB5430 N () () () | 1,857. | 2,274. | 2,615. | 3,530. |
| | 54" | 36" | QRMPB5436 N () () () | 1,857. | 2,274. | 2,615. | 3,530. |
| | 60" | 30" | QRMPB6030 N () () () | 1,881. | 2,300. | 2,645. | 3,571. |
| | 60" | 36" | QRMPB6036 N () () () | 1,881. | 2,300. | 2,645. | 3,571. |
| | 66" | 30" | QRMPB6630 () () () () | 1,905. | 2,326. | 2,675. | 3,611. |
| | 66" | 36" | QRMPB6636 () () () () | 1,905. | 2,326. | 2,675. | 3,611. |
| | 72" | 30" | QRMPB7230 () () () () | 1,928. | 2,352. | 2,705. | 3,651. |
| | 72" | 36" | QRMPB7236 () () () () | 1,928. | 2,352. | 2,705. | 3,651. |
| | 78" | 30" | QRMPB7830 () () () () | 1,952. | 2,378. | 2,735. | 3,692. |
| | 78" | 36" | QRMPB7836 () () () () | 2,031. | 2,477. | 2,849. | 3,846. |
| | 84" | 36" | QRMPB8436 () () () () | 1,952. | 2,378. | 2,735. | 3,692. |
| | 96" | 36" | QRMPB9636 () () () () | 2,007. | 2,451. | 2,819. | 3,805. |

| Order Code | Specification Information | Application Notes |
|--|--|---|
| <p>Example: QRMPB5430N1</p> <p>QR Reff Standard Special</p> <p>MP Meeting P-top</p> <p>B 1 3/4" thick</p> <p>54 54" wide</p> <p>30 30" deep</p> <p>N No grommet</p> <p>1 V1</p> <p>Y311 Beech</p> | <p>To order please specify pattern number including:</p> <ol style="list-style-type: none"> Top thickness Width Depth Grommet option Top finish type Top finish Grommet finish <p>1. Thickness options: A = 1 1/4" B = 1 3/4"</p> <p>4. Grommet options: N = No grommet F = Flush front grommet location R = Recessed grommet location</p> <p>5. Finish type: L = Laminate M = Wood/laminate mixed 1 = V1 2 = V2 3 = V3</p> | <p>Actual widths of worksurface are 1/16" less than nominal dimension. Actual depth is 1/8" less than nominal dimension.</p> <p>Additional spec option required for wrap around panel tops; specify mating trim profile. A = Flat B = Square C = Bullnose E = Extruded Aluminum</p> <p>Applicable finishes are listed on page 102 and 103.</p> <p>See Planning Guide for standard grommet locations.</p> <p>Knoll assumes no responsibility for special grommet locations which interfere with support or other hardware.</p> |

Refer to Planning Guide for modesty panel size requirements and all other support options.

1 3/4" laminate tops on this page are edge banded to match post-formed contours.

Products on this page are shipped without hardware which must be ordered separately from the support components section.

1 3/4" tops require support at mid point to reduce 48" spans or less.

1 3/4" tops require support at mid point to reduce spans to 66" or less.

Mixed finish 1 3/4" tops are not post-formed.

Reff Worksurfaces

straight front corner tops

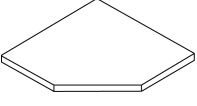
| description | Return d | d | Back w | w | pattern no. | lam. | M/V1 | V2 | V3 |
|--|-------------|-----|-----------|-----|------------------|--------|--------|----------|----------|
| 1 1/4" thick corner worksurface straight front corners  | 24" | 30" | 36" | 36" | QRKA 363623-()() | \$818. | \$917. | \$1,055. | \$1,424. |
| | 24" | 30" | 36" | 42" | QRKA 364223-()() | 859. | 968. | 1,113. | 1,503. |
| | 24" | 30" | 42" | 36" | QRKA 423623-()() | 859. | 968. | 1,113. | 1,503. |
| | 24" | 30" | 42" | 42" | QRKA 424223-()() | 905. | 1,020. | 1,173. | 1,584. |
| | 24" | 30" | 42" | 48" | QRKA 424823-()() | 977. | 1,103. | 1,268. | 1,712. |
| | 24" | 30" | 48" | 42" | QRKA 484223-()() | 977. | 1,103. | 1,268. | 1,712. |
| | 24" | 30" | 48" | 48" | QRKA 484823-()() | 1,027. | 1,156. | 1,329. | 1,795. |
| | 30" | 24" | 36" | 36" | QRKA 363632-()() | 818. | 917. | 1,055. | 1,424. |
| | 30" | 24" | 36" | 42" | QRKA 364232-()() | 859. | 968. | 1,113. | 1,503. |
| | 30" | 24" | 42" | 36" | QRKA 423632-()() | 859. | 968. | 1,113. | 1,503. |
| | 30" | 24" | 42" | 42" | QRKA 424232-()() | 905. | 1,020. | 1,173. | 1,584. |
| | 30" | 24" | 42" | 48" | QRKA 424832-()() | 977. | 1,103. | 1,268. | 1,712. |
| | 30" | 24" | 48" | 42" | QRKA 484232-()() | 977. | 1,103. | 1,268. | 1,712. |
| | 30" | 24" | 48" | 48" | QRKA 484832-()() | 1,027. | 1,156. | 1,329. | 1,795. |
| | 30" | 30" | 42" | 42" | QRKA 424233-()() | 905. | 1,020. | 1,173. | 1,584. |
| | 30" | 30" | 48" | 48" | QRKA 484833-()() | 1,027. | 1,156. | 1,329. | 1,795. |

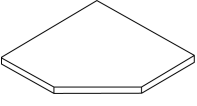
| | | | | | | | | | |
|--|-----|-----|-----|-----|------------------|--------|--------|--------|--------|
| 1 3/4" thick corner worksurface straight front corners  | 24" | 30" | 36" | 36" | QRKB 363623-()() | 977. | 1,239. | 1,425. | 1,924. |
| | 24" | 30" | 36" | 42" | QRKB 364223-()() | 1,030. | 1,293. | 1,487. | 2,007. |
| | 24" | 30" | 42" | 36" | QRKB 423623-()() | 1,030. | 1,293. | 1,487. | 2,007. |
| | 24" | 30" | 42" | 42" | QRKB 424223-()() | 1,087. | 1,358. | 1,562. | 2,108. |
| | 24" | 30" | 42" | 48" | QRKB 424823-()() | 1,176. | 1,455. | 1,673. | 2,259. |
| | 24" | 30" | 48" | 42" | QRKB 484223-()() | 1,176. | 1,455. | 1,673. | 2,259. |
| | 24" | 30" | 48" | 48" | QRKB 484823-()() | 1,233. | 1,519. | 1,747. | 2,358. |
| | 30" | 24" | 36" | 36" | QRKB 363632-()() | 977. | 1,239. | 1,425. | 1,924. |
| | 30" | 24" | 36" | 42" | QRKB 364232-()() | 1,030. | 1,293. | 1,487. | 2,007. |
| | 30" | 24" | 42" | 36" | QRKB 423632-()() | 1,030. | 1,293. | 1,487. | 2,007. |
| | 30" | 24" | 42" | 42" | QRKB 424232-()() | 1,087. | 1,358. | 1,562. | 2,108. |
| | 30" | 24" | 42" | 48" | QRKB 424832-()() | 1,176. | 1,455. | 1,673. | 2,259. |
| | 30" | 24" | 48" | 42" | QRKB 484232-()() | 1,176. | 1,455. | 1,673. | 2,259. |
| | 30" | 24" | 48" | 48" | QRKB 484832-()() | 1,233. | 1,519. | 1,747. | 2,358. |
| | 30" | 30" | 42" | 42" | QRKB 424233-()() | 1,087. | 1,358. | 1,562. | 2,108. |
| | 30" | 30" | 48" | 48" | QRKB 484833-()() | 1,233. | 1,519. | 1,747. | 2,358. |

| Order Code | Specification Information | Application Notes |
|----------------------------------|---|--|
| Example: QRKB363623N1 | <i>To order please specify pattern number including:</i> | Please call Custom Product Development for special grommet locations. |
| QR Reff Standard Special | 1. Top thickness | Knoll accepts no responsibility for special grommet locations which interfere with support hardware. |
| K Straight front corner | 2. Left hand width | |
| B 1 3/4" top thickness | 3. Right hand width | Products on this page are shipped without hardware which must be ordered separately from the support components section. |
| 36 36" wide on left back | 4. Return left hand depth | |
| 36 36" wide on right back | 5. Return right hand depth | Mixed finish 1 3/4" tops are not post-formed. |
| 2 24" deep on left side | 6. Grommet option | |
| 3 30" deep on right side | 7. Finish type | |
| N No grommet | 8. Top finish | |
| 1 V1 finish | 9. Grommet finish | |
| Y324 Ash | 1. <i>Top thickness:</i> A = 1 1/4" B = 1 3/4" | |
| | 6. <i>Grommet options:</i> N = No grommets F = Standard corner location | |
| | 7. <i>Finish type:</i> L = Laminate M = Wood/laminate mixed 1 = V1 2 = V2 3 = V3 | |

Reff Worksurfaces

curvilinear corner tops

Standard Specials Systems

| description | Return d | d | Back w | w | pattern no. | lam. | M/V1 | V2 | V3 |
|---|-------------|-----|-----------|-----|---------------------|--------|--------|----------|----------|
| 1 1/4" thick corner worksurface curved front corners | 24" | 30" | 36" | 36" | QRCA 363623-() () | \$818. | \$917. | \$1,055. | \$1,424. |
| | 24" | 30" | 36" | 42" | QRCA 364223-() () | 859. | 968. | 1,113. | 1,503. |
| | 24" | 30" | 42" | 36" | QRCA 423623-() () | 859. | 968. | 1,113. | 1,503. |
| | 24" | 30" | 42" | 42" | QRCA 424223-() () | 905. | 1,020. | 1,173. | 1,584. |
| | 24" | 30" | 42" | 48" | QRCA 424823-() () | 977. | 1,103. | 1,268. | 1,712. |
| | 24" | 30" | 48" | 42" | QRCA 484223-() () | 977. | 1,103. | 1,268. | 1,712. |
| | 24" | 30" | 48" | 48" | QRCA 484823-() () | 1,027. | 1,156. | 1,329. | 1,795. |
| | 30" | 24" | 36" | 36" | QRCA 363632-() () | 818. | 917. | 1,055. | 1,424. |
| | 30" | 24" | 36" | 42" | QRCA 364232-() () | 859. | 968. | 1,113. | 1,503. |
| | 30" | 24" | 42" | 36" | QRCA 423632-() () | 859. | 968. | 1,113. | 1,503. |
| | 30" | 24" | 42" | 42" | QRCA 424232-() () | 905. | 1,020. | 1,173. | 1,584. |
| | 30" | 24" | 42" | 48" | QRCA 424832-() () | 977. | 1,103. | 1,268. | 1,712. |
| | 30" | 24" | 48" | 42" | QRCA 484232-() () | 977. | 1,103. | 1,268. | 1,712. |
| | 30" | 24" | 48" | 48" | QRCA 484832-() () | 1,027. | 1,156. | 1,329. | 1,795. |
| | 30" | 30" | 42" | 42" | QRCA 424233-() () | 905. | 1,020. | 1,173. | 1,584. |
| | 30" | 30" | 48" | 48" | QRCA 484833-() () | 1,027. | 1,156. | 1,329. | 1,795. |

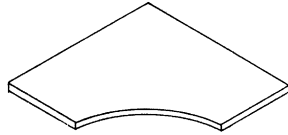

| Order Code | Specification Information | Application Notes |
|------------------------------|---|--|
| Example: QRCA363636N1 | <i>To order please specify pattern number including:</i> | Radius of curved front changes with overall top size. See Planning Guide. |
| QR | Reff Standard Special | Products on this page are shipped without hardware which must be ordered separately from the support components section. |
| C | Curved front corner | |
| A | 1 1/4" thick | |
| 36 | 36" wide on left back | |
| 36 | 36" wide on right back | |
| 2 | 24" deep on left side | |
| 3 | 30" deep on right side | |
| N | No grommet | |
| 1 | VI finish | See Planning Guide for grommet locations. |
| Y324 | Ash | Actual widths of worksurface are 1/16" less than nominal dimension. Actual depth is 1/8" less than nominal dimension. |
| | 5. <i>Grommet options:</i> N = No grommets F = Standard corner location | Knoll accepts no responsibility for special grommet locations which interfere with support or other hardware. |
| | 6. <i>Finish type:</i> L = Laminate M = Wood/laminate mixed 1 = V1 2 = V2 3 = V3 | Please call Custom Product Development for special grommet locations. |
| | | Product on this page will accept woodgrain laminate where laminate is currently an option. List price for woodgrain laminate options will be current published laminate list price plus 10%. |
| | | Applicable finishes are listed on page 102 and 103. |

Reff Worksurfaces

split curvilinear corner tops

Standard Specials Systems

| description | Return d | d | Back w | w | pattern no. | lam. | M/V1 | V2 | V3 |
|---|-------------|-----|-----------|-----|--------------------------|----------|----------|----------|----------|
| 1 1/4" thick split curvilinear corner worksurface with 10" D split front | 24" | 24" | 36" | 36" | QRCAS 363622-()() | \$1,408. | \$1,507. | \$1,733. | \$2,340. |
| | 24" | 24" | 42" | 42" | QRCAS 424222-()() | 1,495. | 1,610. | 1,851. | 2,500. |
| | 24" | 24" | 48" | 48" | QRCAS 484822-()() | 1,617. | 1,746. | 2,008. | 2,711. |
| | 30" | 30" | 42" | 42" | QRCAS 424233-()() | 1,495. | 1,610. | 1,851. | 2,500. |
| | 30" | 30" | 48" | 48" | QRCAS 484833-()() | 1,617. | 1,746. | 2,008. | 2,711. |

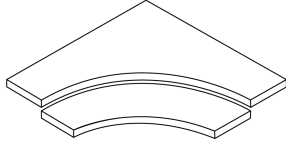

NOTE: Split Top Mechanism to be ordered separately from the Interaction Price List

Order IBST18 split-top mechanism for QRCAS363622, QRCAS424233

Order IBST22 split-top mechanism for QRCAS424222, QRCAS484822

Order IBST28 split-top mechanism for QRCAS484833

Reff System

| Order Code | Specification Information | Application Notes |
|-------------------------------|--|--|
| Example: QRCAS363622N1 | <i>To order please specify pattern number including:</i> | Radius of curved front changes with overall top size. See Planning Guide. |
| QR | Reff Standard Special | Products on this page are shipped without hardware which must be ordered separately from the support components section. |
| C | Curved front corner | |
| A | 1 1/4" thick | Curvilinear worksurfaces only available in 1 1/4" thick. |
| S | Split Top | |
| 36 | 36" wide on left back | See Planning Guide for grommet locations. |
| 36 | 36" wide on right back | |
| 2 | 24" deep on left side | Please call Custom Product Development for special grommet locations. |
| 2 | 24" deep on right side | |
| N | No grommet | Product on this page will accept woodgrain laminate where laminate is currently an option. List price for woodgrain laminate options will be current published laminate list price plus 10%. |
| 1 | VI finish | |
| Y324 | Ash | Applicable finishes are listed on page 102 and 103. |

| description | d | pattern no. | P1 | P2 | P3 |
|--------------------------------|-----|---------------------|-------|-----|-----|
| Cantilever bracket, panel hung | 11" | QRBC11 (L/R) | \$97. | | |
| | 18" | RBC18 (L/R) | 86. | 90. | 94. |

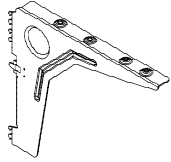

specify paint finish

| | | | | | |
|---------------------------|--|-------------|-----|--|--|
| Corner top corner bracket | | RBCC | 17. | | |
|---------------------------|--|-------------|-----|--|--|



available in black only

| Order Code | Specification Information | Application Notes |
|---------------------------------|---|---|
| Example: QRBC11L 115 | <i>To order please specify pattern number including:</i> 1. Left or right-hand, where applicable. 2. Finish | Applicable finishes are listed on page 102 and 103. |
| QR Reff Standard Special | | |
| B Bracket | | |
| C Cantilever | | |
| 11 18" deep | | |
| L Left hand | | |
| 115 Medium Grey | | |

Reff Worksurfaces
 Optional edge worksurface tops
 1 1/4" thick curvilinear corner
 2" Waterfall edge detail front only

| description | d left | d right | w left | w right | pattern no. | V1 | V2 | V3 |
|----------------------------|-----------|------------|-----------|------------|---------------------------------|----------|----------|----------|
| Curved corner work top | 20" | 20" | 48" | 48" | QRCAWF484811 () () () | \$2,362. | \$2,716. | \$3,667. |
| Profile edge on front only | 20" | 24" | 48" | 48" | QRCAWF484812 () () () | 2,443. | 2,809. | 3,793. |
| | 24" | 20" | 48" | 48" | QRCAWF484821 () () () | 2,443. | 2,809. | 3,793. |
| | 24" | 24" | 48" | 48" | QRCAWF484822 () () () | 2,600. | 2,990. | 4,037. |

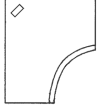

Radii of front edge varies with top dimensions

| Order Code | Specification Information | Application Notes |
|----------------------------------|---|--|
| Example: QRCAWF484811F2 | <i>To order please specify pattern number including:</i> | Products on this page are shipped without hardware which must be ordered separately from the support components section. |
| QR Reff Standard Special | 1. Grommet option | Curvilinear worksurfaces only available in 1 1/4" thick. |
| C Curved front corner | 2. Top finish type | See Planning Guide for grommet locations. |
| A 1 1/4" thick | 3. Top finish | Waterfall tops cannot be specified with semi-open pore finish. |
| WF Waterfall front | 4. Grommet finish | Knoll assumes no responsibility for special grommet locations which interfere with support or other hardware. |
| 48 48" wide on left back | <i>1. Grommet options:</i> | Waterfall worksurfaces should be specified in a configuration only with other waterfall worksurfaces. |
| 48 48" wide on right back | N = No grommet | Actual widths of worksurface are 1/16" less than nominal dimension. Actual depth is 1/8" less than nominal dimension. |
| 1 20" deep on left side | F = Standard corner location | |
| 1 20" deep on right side | <i>2. Finish type:</i> | |
| F Standard grommet | 1 = V1 | |
| 2 V2 finish | 2 = V2 | |
| V319 Medium cherry | 3 = V3 | |
| 111 Jet Black (grommet) | Applicable finishes are listed on page 102 and 103. | |
| | Products on this page do not accept the following finishes: Y341 Wenge Y342 Medium Teak Y343 Dark Grey Oak | |

conference room tops

1 1/4" and 1 3/4" thick round - No Grommets - No Drilling

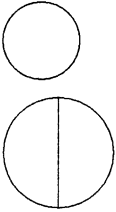
| description | h | dia | pattern no. | lam. | M/V1 | V2 | V3 | |
|---|---------------------|--------------------|--------------------|--------|--------|--------|----------|--|
| Round tops  | 1 1/4" | 24" | QRTA2424 () () | \$669. | \$728. | \$837. | \$1,130. | |
| | | 30" | QRTA3030 () () | 699. | 760. | 874. | 1,180. | |
| | | 54" | QRTA5454 () () * | 2,092. | 2,274. | 2,615. | 3,530. | |
| | * top in two pieces | | | | | | | |
| | 1 3/4" | 24" | QRTB2424 () () | 809. | 1,169. | 1,344. | 1,815. | |
| | | 30" | QRTB3030 () () | 839. | 1,201. | 1,381. | 1,865. | |
| 54" | | QRTB5454 () () * | 2,510. | 3,142. | 3,613. | 4,878. | | |
| * top in two pieces | | | | | | | | |

Order Code

| | |
|---------------------------|-----------------------|
| Example: QRTA30302 | |
| QR | Reff Standard Special |
| T | Rounded top |
| A | 1 1/4" thick |
| 36 | 36" wide |
| 30 | 30" deep |
| 2 | V2 finish |
| V319 | Medium cherry |

Specification Information

To order please specify pattern number including:

1. Top thickness
2. Width
3. Depth
4. Finish type
5. Finish

1. Thickness options:
A = 1 1/4"
B = 1 3/4"

4. Finish type:
L = Laminate
M = Wood/laminate mixed
1 = V1
2 = V2
3 = V3

*Round tops in two pieces.

Application Notes

Top to top brackets included.

See table base matrix in Planning Guide pages 140 and 141.

1 1/4" tops require support at mid point to reduce spans to 48" or less.

Tops have no radius on edges that adjoin.

1 3/4" tops require support at mid point to reduce spans to 66" or less.

Laminate and mixed finish 1 3/4" tops on this page are not post formed.

All tops on this page are without grommets or drillings. The intended use of these products is to provide conference room table options.

Actual widths of worksurface are 1/16" less than nominal dimension. Actual depth is 1/8" less than nominal dimension.

1 1/4" Product on this page will accept woodgrain laminate where laminate is currently an option. List price for woodgrain laminate options will be current published laminate list price plus 10%.

Applicable finishes are listed on page 102 and 103.

Reff Worksurfaces
conference room tops
1 1/4" thick
round and racetrack with 2" waterfall edge

Standard Specials Systems

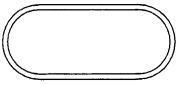
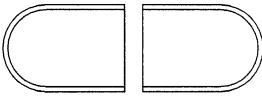
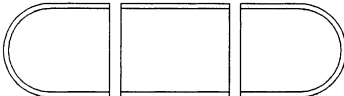
| description | w | d | pattern no. | V1 | V2 | V3 |
|---|--------------|------------|--|--------------------|--------------------|--------------------|
| Round top  | 48" | 48" | QRTAW4848 () () | \$3,302. | \$3,797. | \$5,126. |
| Racetrack top- 1 piece  | 96" | 48" | QRTAW9648 () () | 9,514. | 10,941. | 14,770. |
| Racetrack top- 2 piece Profile edge on all sides except on parting lines  | 120" 144" | 48" 48" | QRTAW12048 () () QRTAW14448 () () | 10,550. 11,452. | 12,133. 13,170. | 16,379. 17,779. |
| Racetrack top- 3 piece Profile edge on all sides except on parting lines  | 168" 192" | 48" 48" | QRTAW16848 () () QRTAW19248 () () | 14,501. 15,404. | 16,676. 17,715. | 22,513. 23,915. |

Reff System

| Order Code | Specification Information | Application Notes |
|---------------------------------|---|--|
| Example: QRTAW96482 | <i>To order please specify pattern number including:</i> | All tops on this page are without grommets or drillings. The intended use of these products is to provide conference room table options. Top to top brackets included. Tops have no radius on edges that adjoin. See table base matrix in Planning Guide for base supports recommended. 1 1/4" tops require support at mid point to reduce spans to 48" or less. Waterfall tops cannot be specified with semi-open pore finish. |
| QR Reff Standard Speical | 1. Top thickness 2. Finish type 3. Finish | |
| T Racetrack top | 1. <i>Thickness option:</i> A = 1 1/4" | Actual widths of worksurface are 1/16" less than nominal dimension. Actual depth is 1/8" less than nominal dimension. |
| A 1 1/4" thick | 2. <i>Finish type:</i> 1 = V1 2 = V2 3 = V3 | |
| W Waterfall all sides | Applicable finishes are listed on page 102 and 103. | |
| 96 96" wide | Products on this page do not accept the following finishes: Y341 Wenge Y342 Medium Teak Y343 Dark Grey Oak | |
| 42 42" deep | | |
| 2 V2 finish | | |
| V319 Medium cherry | | |

Reff Worksurfaces
conference room tops
1 1/4" thick
square and rectangular with 2" waterfall edge

Standard Specials Systems

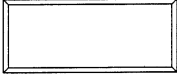
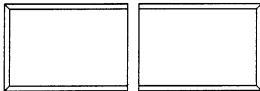
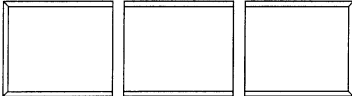
| description | w | d | pattern no. | V1 | V2 | V3 |
|---|--------------|------------|--|--------------------|--------------------|--------------------|
| Square top  | 48" | 48" | QRRAW4848 () () | \$2,902. | \$3,337. | \$4,505. |
| Rectangular top- 1 piece  | 96" | 48" | QRRAW9648 () () | 6,488. | 7,461. | 10,073. |
| Rectangular top- 2 piece Profile edge on all sides except on parting lines  | 120" 144" | 48" 48" | QRRAW12048 () () QRRAW14448 () () | 9,111. 9,988. | 10,478. 11,486. | 14,145. 15,506. |
| Rectangular top- 3 piece Profile edge on all sides except on parting lines  | 168" 192" | 48" 48" | QRRAW16848 () () QRRAW19248 () () | 12,825. 13,700. | 14,749. 15,755. | 19,911. 21,269. |

Order Code

| | |
|----------------------------|-----------------------|
| Example: QRRAW96482 | |
| QR | Reff Standard Special |
| R | Rectangular |
| A | 1 1/4" thick |
| W | Waterfall all sides |
| 96 | 96" wide |
| 48 | 48" deep |
| 2 | V2 finish |
| V319 | Medium cherry |

Specification Information

To order please specify pattern number including:

1. Top thickness
2. Finish type
3. Finish

1. Thickness option:
A = 1 1/4"

2. Finish type:
1 = V1
2 = V2
3 = V3

Applicable finishes are listed on page 102 and 103.

Products on this page do not accept the following finishes:
 Y341 Wenge
 Y342 Medium Teak
 Y343 Dark Grey Oak

Application Notes

All tops on this page are without grommets or drillings. The intended use of these products is to provide conference room table options.

Top to top brackets included.

Tops have no radius on edges that adjoin.

See table base matrix in Planning Guide for base supports recommended.

1 1/4" tops require support at mid point to reduce spans to 48" or less.

Waterfall tops cannot be specified with semi-open pore finish.

Actual widths of worksurface are 1/16" less than nominal dimension. Actual depth is 1/8" less than nominal dimension.

Reff support components end panels

Standard Specials Systems

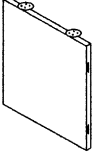
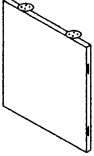
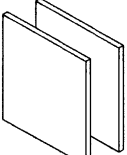
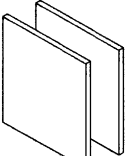
| description | d | w | h | pattern no. | lam. | M/V1 | V2 | V3 |
|---|-------------------------------------|-----|------|-------------------------|--------|--------|--------|--------|
| Endpanel, for use in building flush or cantilevered worksurfaces. Standard height | 1" | 35" | 26½" | QRE35F-() () | \$277. | \$457. | \$526. | \$709. |
|  | | | | | | | | |
| Endpanel, for use in building flush or cantilevered worksurfaces. Desk height | 1" | 35" | 28¾" | QREDH35F-() () | 291. | 480. | 552. | 745. |
|  | | | | | | | | |
| Endpanel, for recessed modesty worksurfaces. Standard height | 1" | 24" | 26½" | QRE24-() () | 523. | 850. | 978. | 1,320. |
|  | | | | | | | | |
| | <i>sold in pairs with 3" recess</i> | | | | | | | |
| Endpanel, for recessed modesty worksurfaces. Desk height | 1" | 24" | 28¾" | QREDH24-() () | 549. | 893. | 1,027. | 1,386. |
|  | | | | | | | | |
| | <i>sold in pairs with 3" recess</i> | | | | | | | |

Reff System

| Order Code | Specification Information | Application Notes |
|----------------------------------|--|--|
| Example: QRE35FL118 | <i>To order please specify pattern number including:</i> | Product on this page will accept woodgrain laminate where laminate is currently an option. List price for woodgrain laminate options will be current published laminate list price plus 10%. |
| QR Reff Standard Special | 1. <i>Finish type</i> | Glides ship with all supports on this page except the recessed modesty panel. |
| E End panel | 2. <i>Finish</i> | |
| 35 35" panel dimension | | Please see Planning Guide for freestanding planning instruction. |
| F Flush modesty placement | | |
| L Laminate | 1. <i>Finish type:</i> | Applicable finishes are listed on page 102 and 103. |
| 118 Bright White | L = Laminate | End panels come with all hardware necessary to attach to tops and each other to build freestanding desks. To join tops to tops or bridge assemblies to desk, hardware must be ordered. |
| | 1 = V1 | |
| | 2 = V2 | |
| | 3 = V3 | |

Reff support components modesty panels

| description | d | w | h | pattern no. | L | V1 | V2 | V3 |
|---|----|------|---------|--------------------------------|--------|--------|----------|----------|
| Modesty panels with hardware. ¹⁵ / ₁₆ " actual thickness (standard height) | 1" | 102" | 26 1/2" | QRB102(M/H)(F/R)() () | \$686. | \$942. | \$1,083. | \$1,462. |
| | 1" | 108" | 26 1/2" | QRB108(M/H)(F/R)() () | 746. | 1,006. | 1,156. | 1,561. |
| | 1" | 114" | 26 1/2" | QRB114(M/H)(F/R)() () | 807. | 1,069. | 1,230. | 1,660. |
| | 1" | 120" | 26 1/2" | QRB120(M/H)(F/R)() () | 867. | 1,133. | 1,303. | 1,759. |

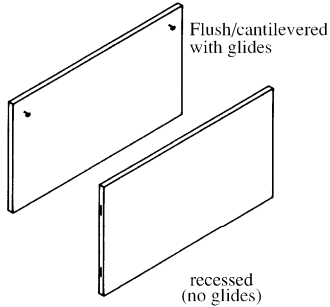

| | | | | | | | | |
|---|----|------|---------|------------------------------|------|--------|--------|--------|
| Modesty panels with hardware. ¹⁵ / ₁₆ " actual thickness (desk height) | 1" | 102" | 28 3/8" | QRBDH102M(F/R)() () | 720. | 989. | 1,137. | 1,535. |
| | 1" | 108" | 28 3/8" | QRBDH108M(F/R)() () | 784. | 1,056. | 1,214. | 1,639. |
| | 1" | 114" | 28 3/8" | QRBDH114M(F/R)() () | 847. | 1,123. | 1,291. | 1,743. |
| | 1" | 120" | 28 3/8" | QRBDH120M(F/R)() () | 911. | 1,190. | 1,368. | 1,847. |

| | | | | | | | | |
|--|----|-----|---------|-----------------------|------|------|------|------|
| Short modesty panel (standard height) | 1" | 28" | 26 1/2" | QRB28MR() () | 306. | 431. | 495. | 669. |
| | 1" | 34" | 26 1/2" | QRB34MR() () | 339. | 472. | 542. | 732. |
| | 1" | 46" | 26 1/2" | QRB46MR() () | 410. | 577. | 664. | 896. |
| | 1" | 58" | 26 1/2" | QRB58MR() () | 445. | 623. | 717. | 967. |

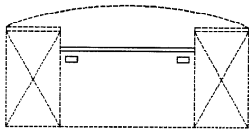

Use of short modesty panel

Pedestals and finished back for pedestal must each be ordered separately

Short modesty comes with attachment brackets to secure modesty panel to sides of pedestals.

Order:

28" modesty for 60" bow top

34" modesty for 66" bow top

46" modesty for 78" bow top

58" modesty for 90" bow top

When ordering 30"d bow top for use with short modesty, specify **recessed** grommet location

When ordering 36"d bow top for use with short modesty, specify **alternate** grommet location

| | | | | | | | | |
|--------------------------------------|----|-----|---------|-------------------------|------|------|------|--------|
| Short modesty panel (desk height) | 1" | 28" | 28 3/8" | QRBDH28MR() () | 321. | 452. | 520. | 702. |
| | 1" | 34" | 28 3/8" | QRBDH34MR() () | 356. | 495. | 569. | 769. |
| | 1" | 46" | 28 3/8" | QRBDH46MR() () | 431. | 606. | 697. | 941. |
| | 1" | 58" | 28 3/8" | QRBDH58MR() () | 467. | 654. | 752. | 1,016. |

| | |
|------------|--------------------------|
| Example: | QRBDH120MFL114 |
| QR | Reff Standard Special |
| B | Back panel |
| DH | Desk height (28 3/8") |
| 120 | 120" |
| M | Full height |
| F | Modesty placement, flush |
| L | Finish type, laminate |
| 114 | Finish, Folkstone grey |

To order please specify pattern number including:

1. Modesty type
2. Modesty placement
3. Finish type
4. Finish

1. Modesty type:
M = Full height (26 1/2"H or ²⁸³/₈")
H = Half height

2. Modesty placement:
F = Flush, cantilevered
R = Recessed

3. Finish type:
L = Laminate
1 = V1
2 = V2
3 = V3

Product on this page will accept woodgrain laminate where laminate is currently an option.
List price for woodgrain laminate options will be current published laminate list price plus 10%.

Modesty panels ship with all hardware necessary to attach to tops and each other to build freestanding desks. To join tops to tops or bridge assemblies to desk, hardware must be ordered separately.

Modesty panel lengths are nominal, length changes on option selected.

Glides ship with all supports on this page except the recessed modesty panel.

Please see Reff Planning Guide for freestanding planning instructions.

Reff support components

drum bases

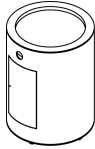
| description | dia | h | pattern no. | V1 | V2 | V3 |
|---|-----|---------|------------------|----------|--------|--------|
|  Drum base (standard height) | 20" | 26 1/2" | QR9D5459 ()() | \$4,598. | n/a | n/a |
| | 24" | 26 1/2" | QR9C7794 ()() | 4,725. | n/a | n/a |
| | 30" | 26 1/2" | QR9C7917 ()() | 4,901. | n/a | n/a |
| | 36" | 26 1/2" | QRSDA3627 ()() | 5,077. | 5,839. | 7,883. |
| | 20" | 26 1/2" | QR9C7801 ()() | n/a | 5,288. | n/a |
| | 20" | 26 1/2" | QR9G6777 ()() | n/a | n/a | 7,138. |
| | 24" | 26 1/2" | QR9C7798 ()() | n/a | 5,433. | n/a |
| | 24" | 26 1/2" | QR9G6778 ()() | n/a | n/a | 7,335. |
| | 30" | 26 1/2" | QR9C7919 ()() | n/a | 5,636. | n/a |
| | 30" | 26 1/2" | QR9G6779 ()() | n/a | n/a | 7,608. |

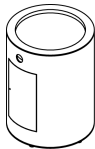
| | | | | | | |
|---|-----|---------|--------------------|--------|--------|--------|
|  Drum base (desk height) | 20" | 28 3/8" | QR9G0413 ()() | 4,652. | n/a | n/a |
| | 24" | 28 3/8" | QR9G1295 ()() | 4,818. | n/a | n/a |
| | 30" | 28 3/8" | QR9G2826 ()() | 4,987. | n/a | n/a |
| | 36" | 28 3/8" | QRSDHDA3628 ()() | 5,331. | 6,131. | 8,277. |
| | 20" | 28 3/8" | QR9G1171 ()() | n/a | 5,349. | n/a |
| | 20" | 28 3/8" | QR9G6780 ()() | n/a | n/a | 7,221. |
| | 24" | 28 3/8" | QR9G1173 ()() | n/a | 5,540. | n/a |
| | 24" | 28 3/8" | QR9G6781 ()() | n/a | n/a | 7,479. |
| | 30" | 28 3/8" | QR9G1499 ()() | n/a | 5,735. | n/a |
| | 30" | 28 3/8" | QR9G6782 ()() | n/a | n/a | 7,742. |

| | | | | | | |
|--|-----|---------|-----------------|--------|--------|--------|
| Drum base (standard height) No hinged access door | 36" | 26 1/2" | QRSD3627 ()() | 2,892. | 3,326. | 4,490. |
|--|-----|---------|-----------------|--------|--------|--------|

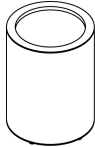

| | | | | | | |
|--|-----|---------|----------------|--------|--------|--------|
| Drum base (desk height) No hinged access door | 36" | 28 3/8" | QRSDHD3628 () | 3,037. | 3,493. | 4,716. |
|--|-----|---------|----------------|--------|--------|--------|

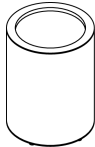

Order Code

| | |
|----------|--------------------------------|
| Example: | QR9C78012 V319 |
| | QR9C7801 Reff Standard Special |
| 2 | V2 Finish |
| V319 | Medium Cherry |

Specification Information

To order please specify pattern number including:

- Finish Type.
1 = V1
2 = V2
3 = V3

2. Finish

Applicable finishes are listed on page 102 and 103.

Application Notes

All Drum bases include sandbags for counterweight.

Features for drum with door only:

- 9" w x 16" h piano hinged access door with catch closure hardware & black knob pull.
- 8" dia. cutout at bottom.
- 2" dia. hole located centered above door
- 16" dia. cutout in top of 20" dia. Drum base
- 20" dia. cutout in top of 24" dia. Drum base
- 24" dia. cutout in top of 30" and 36" dia. Drum base

Reff Cabinetry
pedestals, 17" W
wood interiors, standard height

Standard Specials Systems

| description | w | d | h | pattern no. | L | V1 | V2 | V3 |
|--|-----|-----|---------|----------------------|----------|----------|----------|----------|
| Pedestal for UK filing standard height | 17" | 19" | 26 1/2" | QR211JUK-() W () L | \$1,335. | \$1,428. | \$1,642. | \$2,217. |
| BBF | 17" | 23" | 26 1/2" | QR212JUK-() W () L | 1,486. | 1,593. | 1,832. | 2,473. |
| | 17" | 29" | 26 1/2" | QR213JUK-() W () L | 1,618. | 1,735. | 1,995. | 2,694. |

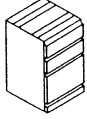

| | | | | | | | | |
|--|-----|-----|---------|----------------------|--------|--------|--------|--------|
| Pedestal for UK filing standard height | 17" | 19" | 26 1/2" | QR211KUK-() W () L | 1,243. | 1,332. | 1,532. | 2,068. |
| FF | 17" | 23" | 26 1/2" | QR212KUK-() W () L | 1,466. | 1,571. | 1,807. | 2,439. |
| | 17" | 29" | 26 1/2" | QR213KUK-() W () L | 1,598. | 1,715. | 1,972. | 2,663. |

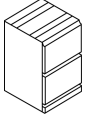

| | | | | | | | | |
|----------------------|-----|----|---------|-------------------|------|------|------|------|
| Pedestal back for UK | 17" | 1" | 26 1/2" | QRPAB17UK-() () | 140. | 146. | 167. | 226. |
|----------------------|-----|----|---------|-------------------|------|------|------|------|

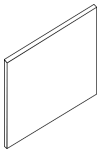

Order Code

Example: **QR211JUKLWDL**

| | |
|-----------|-----------------------|
| QR | Reff Standard Special |
| 2 | 26 1/2" H |
| 1 | 17" wide |
| 1 | 19" deep |
| J | Box box file config. |
| L | Laminate finish |
| W | Wood interior |
| D | Metal D-pull |
| L | Lock hole drilled |

Applicable finishes are listed on page 102 and 103.

Specification Information

To order please specify pattern number including:

1. Finish type
2. Pull option
3. Keying instructions
4. Finish

***After specifying product code, provide keying instructions.**

1. *Finish type:*
L = Laminate
1 = V1
2 = V2
3 = V3

2. *Interior options:*
W = Wood

Application Notes

3. *Pull options:*
D = Metal D-pull
J = Routed pull
C = Nickel C-pull (nickel finish only)
S = S-pull (stainless steel finish only)

4. *Lock options:*
L = Drilled to accept lock

6. Refer to page 199 for keying instructions.

Product on this page excluding J-pull option will accept woodgrain laminate where laminate is currently an option.

List price for woodgrain laminate options will be current published laminate list price plus 10%.

Each pedestal with wood drawers includes one pencil tray and two tray dividers in top box drawer.

Pedestals must be ordered with back panel to achieve full depth without a modesty panel.

Pedestals do not come with lock included. Keying instructions must accompany all cabinet orders.

File drawers include file bars for front to back and side to side filing. File drawers do not support bottom loading.

Random locks are factory installed.

Keyalike are field installed using the KnollKey order form.

Each locking pedestal on this page counts for one lock core.

Reff Cabinetry
pedestals, 17" W
wood interiors, desk height

Standard Specials Systems

| description | w | d | h | pattern no. | L | V1 | V2 | V3 |
|------------------------|-----|-----|----------------------------------|----------------------|----------|----------|----------|----------|
| Pedestal for UK filing | 17" | 19" | 28 ³ / ₈ " | QR111JUK-() W () L | \$1,402. | \$1,500. | \$1,725. | \$2,329. |
| desk height | 17" | 23" | 28 ³ / ₈ " | QR112JUK-() W () L | 1,559. | 1,673. | 1,924. | 2,597. |
| BBF | 17" | 29" | 28 ³ / ₈ " | QR113JUK-() W () L | 1,698. | 1,823. | 2,096. | 2,830. |

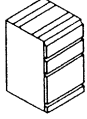

| | | | | | | | | |
|------------------------|-----|-----|----------------------------------|----------------------|--------|--------|--------|--------|
| Pedestal for UK filing | 17" | 19" | 28 ³ / ₈ " | QR111KUK-() W () L | 1,306. | 1,398. | 1,608. | 2,170. |
| desk height | 17" | 23" | 28 ³ / ₈ " | QR112KUK-() W () L | 1,538. | 1,648. | 1,895. | 2,559. |
| FF | 17" | 29" | 28 ³ / ₈ " | QR113KUK-() W () L | 1,677. | 1,801. | 2,071. | 2,796. |

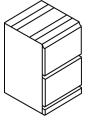

| | | | | | | | | |
|----------------------|-----|----|----------------------------------|--------------------|------|------|------|------|
| Pedestal back for UK | 17" | 1" | 28 ³ / ₈ " | QRPDHB17UK-() () | 148. | 153. | 177. | 236. |
|----------------------|-----|----|----------------------------------|--------------------|------|------|------|------|

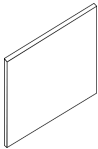

Order Code

Example: **QR211JUKLWDL**

| | |
|-----------|-----------------------|
| QR | Reff Standard Special |
| 2 | 26 1/2" H |
| 1 | 17" wide |
| 1 | 19" deep |
| J | Box box file config. |
| L | Laminate finish |
| W | Wood interior |
| D | Metal D-pull |
| L | Lock hole drilled |

Applicable finishes are listed on page 102 and 103.

Specification Information

To order please specify pattern number including:

1. Finish type
2. Pull option
3. Keying instructions
4. Finish

***After specifying product code, provide keying instructions.**

1. *Finish type:*
L = Laminate
1 = V1
2 = V2
3 = V3

2. *Interior options:*
W = Wood

Application Notes

3. *Pull options:*
D = Metal D-pull
J = Routed pull
C = Nickel C-pull (nickel finish only)
S = S-pull (stainless steel finish only)

4. *Lock options:*
L = Drilled to accept lock

6. Refer to page 199 for keying instructions.

Product on this page excluding J-pull option will accept woodgrain laminate where laminate is currently an option.
List price for woodgrain laminate options will be current published laminate list price plus 10%.

Each pedestal with wood drawers includes one pencil tray and two tray dividers in top box drawer.

Pedestals must be ordered with back panel to achieve full depth without a modesty panel.

Pedestals do not come with lock included. Keying instructions must accompany all cabinet orders.

File drawers include file bars for front to back and side to side filing. File drawers do not support bottom loading.

Random locks are factory installed.

Keyalike are field installed using the KnollKey order form.

Each locking pedestal on this page counts for one lock core.

Reff Cabinetry
pedestals, 30" and 36" W
wood interiors

Standard Specials Systems

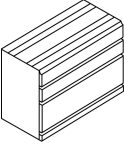
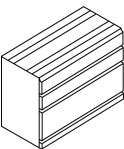
| description | w | d | h | pattern no. | L | V1 | V2 | V3 |
|---|-----|-----|---------|---------------------------|----------|----------|----------|----------|
| Pedestal standard height BBF  | 30" | 19" | 26 1/2" | QRP231J-() () L () () | \$1,725. | \$1,846. | \$2,123. | \$2,866. |
| | 30" | 23" | 26 1/2" | QRP232J-() () L () () | 1,915. | 2,053. | 2,361. | 3,187. |
| | 36" | 19" | 26 1/2" | QRP261J-() () L () () | 2,133. | 2,282. | 2,624. | 3,543. |
| | 36" | 23" | 26 1/2" | QRP262J-() () L () () | 2,346. | 2,516. | 2,893. | 3,906. |
| Pedestal desk height BBF  | 30" | 19" | 28 3/8" | QRP301J-() () L () () | 1,811. | 1,938. | 2,229. | 3,009. |
| | 30" | 23" | 28 3/8" | QRP302J-() () L () () | 2,011. | 2,156. | 2,479. | 3,347. |
| | 36" | 19" | 28 3/8" | QRP361J-() () L () () | 2,240. | 2,397. | 2,757. | 3,721. |
| | 36" | 23" | 28 3/8" | QRP362J-() () L () () | 2,463. | 2,642. | 3,038. | 4,102. |

| Order Code | Specification Information | Application Notes |
|-------------------------------|---|---|
| Example: RP211JLWDL | <i>To order please specify pattern number including:</i> | <i>4. Pull options:</i> |
| R Reff | 1. Hinge location, where applicable | D = Metal D-pull |
| P Pedestal | 2. Finish type | J = Routed pull |
| 2 26 1/2"H | 3. Interior option | C = Nickel C-pull (nickel finish only) |
| 1 16" wide | 4. Pull option | S = S-pull (stainless steel finish only) |
| 1 19" deep | 5. Lock option, applicable hinged doors only | <i>5. Lock options:</i> |
| J Box box file config. | 6. Keying instructions | L = Drilled to accept lock |
| L Laminate finish | 7. Finish | N = No drilling |
| W Wood interior | *After specifying product code, provide keying instructions. | 6. Refer to page 199 for keying instructions. |
| D Metal D-pull | <i>1. Hinge location:</i> | Product on this page excluding J-pull option will accept woodgrain laminate where laminate is currently an option. |
| L Lock hole drilled | L = Left hand | List price for woodgrain laminate options will be current published laminate list price plus 10%. |
| | R = Right hand | Pedestals must be ordered with back panel to achieve full depth without a modesty panel. |
| | <i>2. Finish type:</i> | |
| | L = Laminate | |
| | 1 = V1 | |
| | 2 = V2 | |
| | 3 = V3 | |
| | <i>3. Interior options:</i> | |
| | W = Wood | |
| | | Pedestals do not come with lock included. Keying instructions must accompany all cabinet orders. |
| | | Hinge door cabinets have optional lock drilling which can be specified in the cabinet product code. |
| | | Mobile pedestals are always equipped with finished backs. |
| | | File drawers include file bars for front to back and side to side filing. File drawers do not support bottom loading. |
| | | Random locks are factory installed. |
| | | Keyalike are field installed using the KnollKey order form. |
| | | Each locking pedestal on this page counts for one lock core. |

Applicable finishes are listed on page 102 and 103.

Reff Cabinetry
pedestals, 30" and 36" W
metal interiors

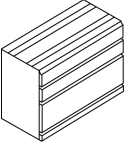
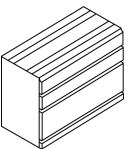
| description | w | d | h | pattern no. | L | V1 | V2 | V3 |
|---|-----|-----|---------|---------------------------|----------|----------|----------|----------|
| Pedestal standard height BBF  | 30" | 19" | 26 1/2" | QRP231J-() () L () () | \$1,437. | \$1,540. | \$1,771. | \$2,391. |
| | 30" | 23" | 26 1/2" | QRP232J-() () L () () | 1,477. | 1,585. | 1,823. | 2,461. |
| | 36" | 19" | 26 1/2" | QRP261J-() () L () () | 1,534. | 1,643. | 1,889. | 2,551. |
| | 36" | 23" | 26 1/2" | QRP262J-() () L () () | 1,567. | 1,682. | 1,934. | 2,611. |
| Pedestal desk height BBF  | 30" | 19" | 28 3/8" | QRP301J-() () L () () | 1,509. | 1,617. | 1,860. | 2,510. |
| | 30" | 23" | 28 3/8" | QRP302J-() () L () () | 1,552. | 1,664. | 1,914. | 2,583. |
| | 36" | 19" | 28 3/8" | QRP361J-() () L () () | 1,611. | 1,725. | 1,984. | 2,678. |
| | 36" | 23" | 28 3/8" | QRP362J-() () L () () | 1,645. | 1,765. | 2,030. | 2,740. |

Reff System

| Order Code | Specification Information | Application Notes |
|--|---|--|
| <p>Example: RP211JLWDL</p> <p>R Reff</p> <p>P Pedestal</p> <p>2 26 1/2"H</p> <p>1 16" wide</p> <p>1 19" deep</p> <p>J Box box file config.</p> <p>L Laminate finish</p> <p>W Wood interior</p> <p>D Metal D-pull</p> <p>L Lock hole drilled</p> | <p>To order please specify pattern number including:</p> <ol style="list-style-type: none"> Hinge location, where applicable Finish type Interior option Pull option Lock option, applicable hinged doors only Keying instructions Finish <p>*After specifying product code, provide keying instructions.</p> <p>1. Hinge location: L = Left hand R = Right hand</p> <p>2. Finish type: L = Laminate 1 = V1 2 = V2 3 = V3</p> <p>3. Interior options: M = Metal</p> | <p>4. Pull options: D = Metal D-pull J = Routed pull C = Nickel C-pull (nickel finish only) S = S-pull (stainless steel finish only)</p> <p>5. Lock options: L = Drilled to accept lock N = No drilling</p> <p>6. Refer to page 199 for keying instructions.</p> <p>Product on this page excluding J-pull option will accept woodgrain laminate where laminate is currently an option. List price for woodgrain laminate options will be current published laminate list price plus 10%.</p> <p>Pedestals must be ordered with back panel to achieve full depth without a modesty panel.</p> |

Applicable finishes are listed on page 102 and 103.

Pedestals do not come with lock included. Keying instructions must accompany all cabinet orders.

Hinge door cabinets have optional lock drilling which can be specified in the cabinet product code.

Mobile pedestals are always equipped with finished backs.

File drawers include file bars for front to back and side to side filing. File drawers do not support bottom loading.

Random locks are factory installed.

Keyalike are field installed using the KnollKey order form.

Each locking pedestal on this page counts for one lock core.

Reff Cabinetry
Cabinets (use with 26 1/2" h support components)
 38" high
 wood interior

| description | w | d | h | pattern no. | L | V1 | V2 | V3 |
|---|-----|-----|-----|-----------------------------------|----------|----------|----------|----------|
| 3 Drawer lateral file with anit-tip bar device | 30" | 20" | 38" | QRC332F- () () L () () | \$2,419. | \$3,172. | \$3,648. | \$4,925. |
| | 30" | 24" | 38" | QRC333F- () () L () () | 2,656. | 3,487. | 4,010. | 5,414. |
| | 36" | 20" | 38" | QRC362F- () () L () () | 3,026. | 3,964. | 4,559. | 6,154. |
| | 36" | 24" | 38" | QRC363F- () () L () () | 3,324. | 4,355. | 5,008. | 6,761. |

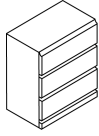

| Order Code | Specification Information | Application Notes |
|---------------------------------|---|---|
| Example: QRC332FLWJL | <i>To order please specify pattern number including:</i> | Key alike are field installed using the KnollKey order form. Random locks are factory installed. |
| QR Reff Standard Special | 1. Hinge location, where applicable | Cabinets do not come with lock included. Keying instructions must accompany all cabinet orders. |
| C Cabinets | 2. Finish type | Hinge door cabinets have optional lock drilling which can be specified in the cabinet product code. |
| 3 38" high | 3. Interior option | <i>*Note:</i> Wardrobe cabinets do not come equipped with coat rod and boot tray. Please specify separately from standard Reff price list. |
| 3 30" wide | 4. Pull option | File drawers include file bars for front to back and side to side filing. |
| 2 20" deep | 5. Lock option, where applicable | File drawers do not support bottom loading. |
| F File drawer | 6. Finish, cabinet | Applicable finishes are listed on page 102 and 103. |
| L Laminate finish type | 7. Finish, pull when applicable | |
| W Wood interior | 8. Keying instructions | |
| J Routed pull | *After specifying product code, provide keying instructions. | |
| L Lock drilling | 1. <i>Hinge location:</i> L = Left hand R = Right hand | |
| | 2. <i>Finish type:</i> L = Laminate 1 = V1 2 = V2 3 = V3 | |
| | 3. <i>Interior options:</i> W = Wood | |
| | 4. <i>Pull options:</i> D = Metal D-pull J = Routed pull C = Nickel C-pull (nickel finish only) S = S-pull (stainless steel finish only) | |
| | 5. <i>Lock options:</i> L = Lock hole drilled N = No lock drilling | |
| | 8. Refer to page 199 for keying instructions. | |
| | Product on this page excluding J-pull option will accept woodgrain laminate where laminate is currently an option. List price for woodgrain laminate options will be current published laminate list price plus 10%. | |
| | Specify shelf paint finish on open cabinets with metal interiors. | |
| | Please note: Shelf adjustability is limited to approximately 2.5" up or down per shelf from predetermined shelf height. | |

Reff Cabinetry
 Cabinets (use with 26¹/₂" h support components)
 38" high
 metal interior

| description | width | depth | height | pattern no. | L | V1 | V2 | V3 |
|---|-------|-------|--------|-----------------------------------|----------|----------|----------|----------|
| 3 Drawer lateral file with anit-tip bar device | 30" | 20" | 38" | QRC332F- () () L () () | \$2,261. | \$2,963. | \$3,407. | \$4,600. |
| | 30" | 24" | 38" | QRC333F- () () L () () | 2,495. | 3,271. | 3,762. | 5,078. |
| | 36" | 20" | 38" | QRC362F- () () L () () | 2,867. | 3,757. | 4,321. | 5,833. |
| | 36" | 24" | 38" | QRC363F- () () L () () | 3,165. | 4,151. | 4,774. | 6,444. |

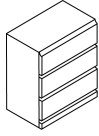

Order Code

| | |
|-----------|-----------------------|
| Example: | QRC332FLWJL |
| QR | Reff Standard Special |
| C | Cabinets |
| 3 | 38" high |
| 3 | 30" wide |
| 2 | 20" deep |
| F | File drawer |
| L | Laminate finish type |
| W | Wood interior |
| J | Routed pull |
| L | Lock drilling |

Specification Information

To order please specify pattern number including:

- Hinge location, where applicable
- Finish type
- Interior option
- Pull option
- Lock option, where applicable
- Finish, cabinet
- Finish, pull when applicable
- Keying instructions

***After specifying product code, provide keying instructions.**

1. Hinge location:
 L = Left hand
 R = Right hand

2. Finish type:
 L = Laminate
 1 = V1
 2 = V2
 3 = V3

3. Interior options:
 M = Metal

4. Pull options:
 D = Metal D-pull
 J = Routed pull
 C = Nickel C-pull (nickel finish only)
 S = S-pull (stainless steel finish only)

5. Lock options:
 L = Lock hole drilled
 N = No lock drilling

8. Refer to page 199 for keying instructions.

Product on this page excluding J-pull option will accept woodgrain laminate where laminate is currently an option.
 List price for woodgrain laminate options will be current published laminate list price plus 10%.
 Specify shelf paint finish on open cabinets with metal interiors.
 Please note: Shelf adjustability is limited to approximately 2.5" up or down per shelf from predetermined shelf height.

Application Notes

Key alike are field installed using the KnollKey order form. Random locks are factory installed.

Cabinets do not come with lock included. Keying instructions must accompany all cabinet orders.

Hinge door cabinets have optional lock drilling which can be specified in the cabinet product code.

**Note:*
 Wardrobe cabinets do not come equipped with coat rod and boot tray. Please specify separately from standard Reff price list.

File drawers include file bars for front to back and side to side filing.

File drawers do not support bottom loading.

Applicable finishes are listed on page 102 and 103.

Reff Cabinetry
 Cabinets (use with 26 1/2" h support components)
 64" high
 wood interior

| description | w | d | h | pattern no. | L | V1 | V2 | V3 |
|--|-----|-----|-----|-----------------------------------|----------|----------|----------|----------|
|  Storage open above w/2 adj shelves, FF below | 16" | 20" | 64" | QRC612G- () () L () () | \$2,232. | \$2,901. | \$3,336. | \$4,504. |
| | 16" | 24" | 64" | QRC613G- () () L () () | 2,446. | 3,178. | 3,655. | 4,934. |
| | 30" | 20" | 64" | QRC632G- () () L () () | 2,772. | 3,608. | 4,149. | 5,601. |
| | 30" | 24" | 64" | QRC633G- () () L () () | 3,058. | 3,983. | 4,580. | 6,184. |
| | 36" | 20" | 64" | QRC662G- () () L () () | 3,041. | 3,959. | 4,553. | 6,146. |
| | 36" | 24" | 64" | QRC663G- () () L () () | 3,356. | 4,374. | 5,030. | 6,791. |

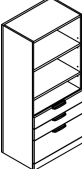
| | | | | | | | | |
|---|-----|-----|-----|-----------------------------------|--------|--------|--------|--------|
|  Storage open above w/2 adj shelves, BBF below | 16" | 20" | 64" | QRC612P- () () L () () | 2,297. | 2,983. | 3,430. | 4,631. |
| | 16" | 24" | 64" | QRC613P- () () L () () | 2,525. | 3,284. | 3,777. | 5,098. |
| | 30" | 20" | 64" | QRC632P- () () L () () | 2,666. | 3,470. | 3,990. | 5,387. |
| | 30" | 24" | 64" | QRC633P- () () L () () | 2,921. | 3,803. | 4,373. | 5,904. |
| | 36" | 20" | 64" | QRC662P- () () L () () | 2,927. | 3,808. | 4,379. | 5,912. |
| | 36" | 24" | 64" | QRC663P- () () L () () | 3,201. | 4,176. | 4,802. | 6,483. |

Order Code

| | |
|-----------|-----------------------|
| Example: | QRC332FLWJL |
| QR | Reff Standard Special |
| C | Cabinets |
| 3 | 38" high |
| 3 | 30" wide |
| 2 | 20" deep |
| F | File drawer |
| L | Laminate finish type |
| W | Wood interior |
| J | Routed pull |
| L | Lock drilling |

Specification Information

To order please specify pattern number including:

- Hinge location, where applicable
- Finish type
- Interior option
- Pull option
- Lock option, where applicable
- Finish, cabinet
- Finish, pull when applicable
- Keying instructions

***After specifying product code, provide keying instructions.**

1. Hinge location:
 L = Left hand
 R = Right hand

2. Finish type:
 L = Laminate
 1 = V1
 2 = V2
 3 = V3

3. Interior options:
 W = Wood

4. Pull options:
 D = Metal D-pull
 J = Routed pull
 C = Nickel C-pull (nickel finish only)
 S = S-pull (stainless steel finish only)

5. Lock options:
 L = Lock hole drilled
 N = No lock drilling

8. Refer to page 199 for keying instructions.

Product on this page excluding J-pull option will accept woodgrain laminate where laminate is currently an option.
 List price for woodgrain laminate options will be current published laminate list price plus 10%.
 Specify shelf paint finish on open cabinets with metal interiors.
 Please note: Shelf adjustability is limited to approximately 2.5" up or down per shelf from predetermined shelf height.

Application Notes

Key alike are field installed using the KnollKey order form. Random locks are factory installed.

Cabinets do not come with lock included. Keying instructions must accompany all cabinet orders.

Hinge door cabinets have optional lock drilling which can be specified in the cabinet product code.

**Note:*
 Wardrobe cabinets do not come equipped with coat rod and boot tray. Please specify separately from standard Reff price list.

File drawers include file bars for front to back and side to side filing.

File drawers do not support bottom loading.

Applicable finishes are listed on page 102 and 103.

Reff Cabinetry
 Cabinets (use with 26 1/2" h support components)
 64" high
 metal interior

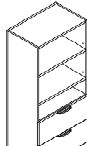
| description | w | d | h | pattern no. | L | V1 | V2 | V3 |
|---|-----|-----|-----|-----------------------------------|----------|----------|----------|----------|
| Storage open above w/2 adj shelves, FF below  | 16" | 20" | 64" | QRC612G- () () L () () | \$2,100. | \$2,724. | \$3,133. | \$4,229. |
| | 16" | 24" | 64" | QRC613G- () () L () () | 2,310. | 3,003. | 3,453. | 4,662. |
| | 30" | 20" | 64" | QRC632G- () () L () () | 2,638. | 3,432. | 3,947. | 5,328. |
| | 30" | 24" | 64" | QRC633G- () () L () () | 2,926. | 3,807. | 4,378. | 5,910. |
| | 36" | 20" | 64" | QRC662G- () () L () () | 2,906. | 3,782. | 4,349. | 5,872. |
| | 36" | 24" | 64" | QRC663G- () () L () () | 3,223. | 4,199. | 4,829. | 6,519. |

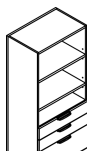
| | | | | | | | | |
|--|-----|-----|-----|-----------------------------------|--------|--------|--------|--------|
| Storage open above w/2 adj shelves, BBF below  | 16" | 20" | 64" | QRC612P- () () L () () | 2,162. | 2,807. | 3,228. | 4,358. |
| | 16" | 24" | 64" | QRC613P- () () L () () | 2,391. | 3,111. | 3,578. | 4,830. |
| | 30" | 20" | 64" | QRC632P- () () L () () | 2,531. | 3,292. | 3,786. | 5,111. |
| | 30" | 24" | 64" | QRC633P- () () L () () | 2,784. | 3,626. | 4,170. | 5,629. |
| | 36" | 20" | 64" | QRC662P- () () L () () | 2,791. | 3,633. | 4,178. | 5,640. |
| | 36" | 24" | 64" | QRC663P- () () L () () | 3,069. | 3,996. | 4,595. | 6,204. |

Order Code

| | |
|-----------|-----------------------|
| Example: | QRC332FLWJL |
| QR | Reff Standard Special |
| C | Cabinets |
| 3 | 38" high |
| 3 | 30" wide |
| 2 | 20" deep |
| F | File drawer |
| L | Laminate finish type |
| W | Wood interior |
| J | Routed pull |
| L | Lock drilling |

Specification Information

To order please specify pattern number including:

- Hinge location, where applicable
- Finish type
- Interior option
- Pull option
- Lock option, where applicable
- Finish, cabinet
- Finish, pull when applicable
- Keying instructions

***After specifying product code, provide keying instructions.**

1. Hinge location:
 L = Left hand
 R = Right hand

2. Finish type:
 L = Laminate
 1 = V1
 2 = V2
 3 = V3

3. Interior options:
 M = Metal

4. Pull options:
 D = Metal D-pull
 J = Routed pull
 C = Nickel C-pull (nickel finish only)
 S = S-pull (stainless steel finish only)

5. Lock options:
 L = Lock hole drilled
 N = No lock drilling

8. Refer to page 199 for keying instructions.

Product on this page excluding J-pull option will accept woodgrain laminate where laminate is currently an option.
 List price for woodgrain laminate options will be current published laminate list price plus 10%.
 Specify shelf paint finish on open cabinets with metal interiors.
 Please note: Shelf adjustability is limited to approximately 2.5" up or down per shelf from predetermined shelf height.

Application Notes

Key alike are field installed using the KnollKey order form. Random locks are factory installed.

Cabinets do not come with lock included. Keying instructions must accompany all cabinet orders.

Hinge door cabinets have optional lock drilling which can be specified in the cabinet product code.

*Note:
 Wardrobe cabinets do not come equipped with coat rod and boot tray. Please specify separately from standard Reff price list.

File drawers include file bars for front to back and side to side filing.

File drawers do not support bottom loading.

Applicable finishes are listed on page 102 and 103.

Reff Cabinetry
 Cabinets (use with 26 1/2" h support components)
 72" high
 wood interior

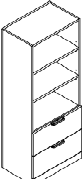
| description | w | d | h | pattern no. | L | V1 | V2 | V3 |
|--|-----|-----|-----|-------------------------------|----------|----------|----------|----------|
|  Storage open above w/2 adj shelves, FF below | 16" | 20" | 72" | QRC712G-() () L () () () | \$2,352. | \$3,057. | \$3,516. | \$4,746. |
| | 16" | 24" | 72" | QRC713G-() () L () () () | 2,584. | 3,361. | 3,865. | 5,218. |
| | 30" | 20" | 72" | QRC732G-() () L () () () | 2,928. | 3,809. | 4,380. | 5,913. |
| | 30" | 24" | 72" | QRC733G-() () L () () () | 3,196. | 4,165. | 4,790. | 6,466. |
| | 36" | 20" | 72" | QRC762G-() () L () () () | 3,161. | 4,117. | 4,735. | 6,392. |
| | 36" | 24" | 72" | QRC763G-() () L () () () | 3,433. | 4,474. | 5,145. | 6,946. |

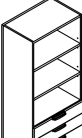
| | | | | | | | | |
|---|-----|-----|-----|-------------------------------|--------|--------|--------|--------|
|  Storage open above w/2 adj shelves, BBF below | 16" | 20" | 72" | QRC712P-() () L () () () | 2,431. | 3,162. | 3,636. | 4,909. |
| | 16" | 24" | 72" | QRC713P-() () L () () () | 2,660. | 3,462. | 3,981. | 5,375. |
| | 30" | 20" | 72" | QRC732P-() () L () () () | 2,834. | 3,689. | 4,242. | 5,727. |
| | 30" | 24" | 72" | QRC733P-() () L () () () | 3,103. | 4,041. | 4,647. | 6,274. |
| | 36" | 20" | 72" | QRC762P-() () L () () () | 3,107. | 4,046. | 4,653. | 6,281. |
| | 36" | 24" | 72" | QRC763P-() () L () () () | 3,405. | 4,437. | 5,103. | 6,888. |

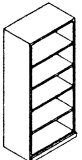
| | | | | | | | | |
|--|-----|-----|-----|-------------------------|--------|--------|--------|--------|
|  Cabinet with open shelves | 30" | 15" | 72" | QRC731B-() () () () | 2,329. | 3,036. | 3,491. | 4,713. |
| | 36" | 15" | 72" | QRC761B-() () () () | 2,609. | 3,401. | 3,911. | 5,280. |

Note: Cabinet must be secured to wall to prevent tipping. Hardware is included.

| Order Code | Specification Information | Application Notes | |
|--|---|--|--|
| Example: RC732BLMNN R Reff C Cabinets 7 72" high 3 30" wide 2 20" deep B Full bookcase L Laminate finish M Metal interior N No drilling N No drilling | <i>To order please specify pattern number including:</i> 1. Hinge location, where applicable 2. Finish type 3. Interior option 4. Pull option 5. Lock option, where applicable 6. Finish, cabinet 7. Finish, pull when applicable 8. Left hand side of cabinet drilling: N = No drilling Size to drill for each workwall: S0 = 19"H x 15"D S1 = 19"H x 20"D T0 = 23"H x 15"D T1 = 23"H x 20"D 9. Right hand side of cabinet drilling: same as #8 above. 10. Keying instructions *After specifying product code, provide keying instructions. | 1. <i>Hinge location:</i> L = Left hand R = Right hand 2. <i>Finish type:</i> L = Laminate 1 = V1 2 = V2 3 = V3 3. <i>Interior options:</i> W = Wood 4. <i>Pull options:</i> D = Metal D-pull J = Routed pull C = Nickel C-pull (nickel finish only) S = S-pull (stainless steel finish only) 5. <i>Lock options:</i> L = Lock hole drilled N = No lock drilling 10. Refer to page 199 for keying instructions. Product on this page excluding J-pull option will accept woodgrain laminate where laminate is currently an option. List price for woodgrain laminate options will be current published laminate list price plus 10%. | Key alike are field installed using the KnollKey order form. Random locks are factory installed. Cabinets do not come with lock included. Keying instructions must accompany all cabinet orders. Hinge door cabinets have optional lock drilling which can be specified in the cabinet product code. Wardrobe cabinets do not come equipped with coat rod and boot tray. Please specify separately from standard Reff price list. File drawers include file bars for front to back and side to side filing. File drawers do not support bottom loading. Applicable finishes are listed on page 102 and 103. |

Please note: Shelf adjustability is limited to approximately 2.5" up or down per shelf from predetermined shelf height.

Reff Cabinetry

Cabinets (use with 26 1/2" h support components)

72" high

metal interior

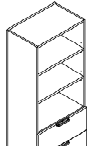
| description | w | d | h | pattern no. | L, metal interiors | V1 | V2 | V3 |
|--|-----|-----|-----|---------------------------------------|--------------------|----------|----------|----------|
|  Storage open above w/2 adj shelves, FF below | 16" | 20" | 72" | QRC712G- () () L () () () | \$2,217. | \$2,878. | \$3,310. | \$4,468. |
| | 16" | 24" | 72" | QRC713G- () () L () () () | 2,422. | 3,186. | 3,664. | 4,946. |
| | 30" | 20" | 72" | QRC732G- () () L () () () | 2,792. | 3,637. | 4,183. | 5,646. |
| | 30" | 24" | 72" | QRC733G- () () L () () () | 3,063. | 3,989. | 4,587. | 6,193. |
| | 36" | 20" | 72" | QRC762G- () () L () () () | 3,026. | 3,940. | 4,531. | 6,117. |
| | 36" | 24" | 72" | QRC763G- () () L () () () | 3,297. | 4,297. | 4,942. | 6,671. |

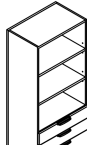
| | | | | | | | | |
|---|-----|-----|-----|---------------------------------------|--------|--------|--------|--------|
|  Storage open above w/2 adj shelves, BBF below | 16" | 20" | 72" | QRC712P- () () L () () () | 2,299. | 2,985. | 3,433. | 4,634. |
| | 16" | 24" | 72" | QRC713P- () () L () () () | 2,525. | 3,284. | 3,777. | 5,098. |
| | 30" | 20" | 72" | QRC732P- () () L () () () | 2,698. | 3,510. | 4,036. | 5,449. |
| | 30" | 24" | 72" | QRC733P- () () L () () () | 2,968. | 3,866. | 4,446. | 6,002. |
| | 36" | 20" | 72" | QRC762P- () () L () () () | 2,973. | 3,871. | 4,452. | 6,010. |
| | 36" | 24" | 72" | QRC763P- () () L () () () | 3,272. | 4,259. | 4,898. | 6,612. |

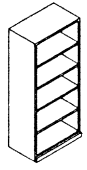
| | | | | | | | | |
|--|-----|-----|-----|---------------------------------|--------|--------|--------|--------|
|  Cabinet with open shelves | 30" | 15" | 72" | QRC731B- () () () () | 2,171. | 2,830. | 3,255. | 4,394. |
| | 36" | 15" | 72" | QRC761B- () () () () | 2,450. | 3,192. | 3,671. | 4,956. |

Note: Cabinet must be secured to wall to prevent tipping. Hardware is included.

Order Code

| | |
|----------------------------|-----------------|
| Example: RC732BLMNN | |
| R | Reff |
| C | Cabinets |
| 7 | 72" high |
| 3 | 30" wide |
| 2 | 20" deep |
| B | Full bookcase |
| L | Laminate finish |
| M | Metal interior |
| N | No drilling |
| N | No drilling |

Please note: Shelf adjustability is limited to approximately 2.5" up or down per shelf from predetermined shelf height.

Specification Information

To order please specify pattern number including:

- Hinge location, where applicable
- Finish type
- Interior option
- Pull option
- Lock option, where applicable
- Finish, cabinet
- Finish, pull when applicable
- Left hand side of cabinet drilling:
N = No drilling
Size to drill for each workwall:
S0 = 19"H x 15"D
S1 = 19"H x 20"D
T0 = 23"H x 15"D
T1 = 23"H x 20"D
- Right hand side of cabinet drilling: same as #8 above.
- Keying instructions

*After specifying product code, provide keying instructions.

1. Hinge location:

L = Left hand
R = Right hand

2. Finish type:

L = Laminate
1 = V1
2 = V2
3 = V3

3. Interior options:

M = Metal

4. Pull options:

D = Metal D-pull
J = Routed pull
C = Nickel C-pull (nickel finish only)
S = S-pull (stainless steel finish only)

5. Lock options:

L = Lock hole drilled
N = No lock drilling

10. Refer to page 199 for keying instructions.

Product on this page excluding J-pull option will accept woodgrain laminate where laminate is currently an option.
List price for woodgrain laminate options will be current published laminate list price plus 10%.

Application Notes

Key alike are field installed using the KnollKey order form. Random locks are factory installed.

Cabinets do not come with lock included. Keying instructions must accompany all cabinet orders.

Hinge door cabinets have optional lock drilling which can be specified in the cabinet product code.

Wardrobe cabinets do not come equipped with coat rod and boot tray. Please specify separately from standard Reff price list.

File drawers include file bars for front to back and side to side filing.

File drawers do not support bottom loading.

Applicable finishes are listed on page 102 and 103.

Reff Cabinetry
 Cabinets (use with 28³/₈" h support components)
 40¹/₂" high
 wood interior

| description | w | d | h | pattern no. | L | V1 | V2 | V3 |
|---|-----|-----|----------------------------------|---|----------|----------|----------|----------|
| 3 Drawer lateral file with anit-tip bar device | 30" | 20" | 40 ¹ / ₂ " | QRC332DHF () () L () () | \$2,193. | \$2,875. | \$3,306. | \$4,463. |
| | 30" | 24" | 40 ¹ / ₂ " | QRC333DHF () () L () () | 2,418. | 3,170. | 3,646. | 4,921. |
| | 36" | 20" | 40 ¹ / ₂ " | QRC362DHF () () L () () | 2,794. | 3,665. | 4,215. | 5,690. |
| | 36" | 24" | 40 ¹ / ₂ " | QRC363DHF () () L () () | 3,066. | 4,020. | 4,623. | 6,241. |

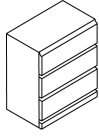

Order Code

| | |
|-----------|---------------------------------------|
| Example: | QRC332DHFLWJL |
| QR | Reff Standard Special |
| C | Cabinets |
| 3 | 40 ¹ / ₂ " high |
| 3 | 30" wide |
| 2 | 20" deep |
| DH | Desk height |
| F | File drawer |
| L | Laminate finish type |
| W | Wood interior |
| J | Routed pull |
| L | Lock drilling |

Specification Notes

To order please specify pattern number including:

1. Finish type
2. Interior option
3. Pull option
4. Finish, cabinet
5. Finish, pull when applicable
6. Keying instructions

***After specifying product code, provide keying instructions.**

1. *Finish type:*
 L = Laminate
 1 = V1
 2 = V2
 2 = V3

2. *Interior options:*
 W = Wood

Application Notes

Key alike are field installed using the KnollKey order form. Random locks are factory installed.

File drawers include file bars for front to back and side to side filing.

Reff Cabinetry
 Cabinets (use with 28^{3/8}" h support components)
 40^{1/2}" high
 metal interior

| description | w | d | h | pattern no. | L | V1 | V2 | V3 |
|---|-----|-----|---------------------|---|----------|----------|----------|----------|
| 3 Drawer lateral file with anit-tip bar device | 30" | 20" | 40 ^{1/2} " | QRC332DHF () () L () () | \$2,036. | \$2,669. | \$3,069. | \$4,144. |
| | 30" | 24" | 40 ^{1/2} " | QRC333DHF () () L () () | 2,267. | 2,971. | 3,417. | 4,612. |
| | 36" | 20" | 40 ^{1/2} " | QRC362DHF () () L () () | 2,629. | 3,448. | 3,965. | 5,353. |
| | 36" | 24" | 40 ^{1/2} " | QRC363DHF () () L () () | 2,902. | 3,805. | 4,376. | 5,907. |

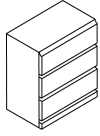

Order Code

| | |
|-----------|--------------------------|
| Example: | QRC332DHFLWJL |
| QR | Reff Standard Special |
| C | Cabinets |
| 3 | 40 ^{1/2} " high |
| 3 | 30" wide |
| 2 | 20" deep |
| DH | Desk height |
| F | File drawer |
| L | Laminate finish type |
| W | Wood interior |
| J | Routed pull |
| L | Lock drilling |

Specification Information

To order please specify pattern number including:

1. Finish type
2. Interior option
3. Pull option
4. Finish, cabinet
5. Finish, pull when applicable
6. Keying instructions

***After specifying product code, provide keying instructions.**

1. Finish type:
 L = Laminate
 1 = V1
 2 = V2
 2 = V3

2. Interior options:
 W = Wood

Application Notes

Key alike are field installed using the KnollKey order form. Random locks are factory installed.

File drawers include file bars for front to back and side to side filing.

Product on this page excluding J-pull option will accept woodgrain laminate where laminate is currently an option.
 List price for woodgrain laminate options will be current published laminate list price plus 10%.

Reff Cabinetry
Cabinets (use with 28³/₈" h support components)
 68" high
 wood interior

| description | w | d | h | pattern no. | L | V1 | V2 | V3 |
|---|-----|-----|-----|--|----------|----------|----------|----------|
| Cabinet with hinged doors for coat rod and boot tray* | 16" | 20" | 68" | QRC612DHD (L/R) () W () () () | \$1,963. | \$2,571. | \$2,957. | \$3,991. |
| | 16" | 24" | 68" | QRC613DHD (L/R) () W () () () | 2,150. | 2,818. | 3,241. | 4,375. |
| | 30" | 20" | 68" | QRC632DHD () W () () () | 2,397. | 3,141. | 3,612. | 4,876. |
| | 30" | 24" | 68" | QRC633DHD () W () () () | 2,469. | 3,241. | 3,727. | 5,032. |
| | 36" | 20" | 68" | QRC662DHD () W () () () | 2,654. | 3,480. | 4,002. | 5,403. |
| | 36" | 24" | 68" | QRC663DHD () W () () () | 2,712. | 3,579. | 4,116. | 5,556. |

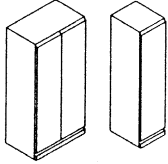

| | | | | | | | | |
|--|-----|-----|-----|------------------------------------|--------|--------|--------|--------|
| Cabinet with hinged doors and 3 adj. shelves | 16" | 20" | 68" | QRC612DHC (L/R) () () () | 2,241. | 2,937. | 3,378. | 4,560. |
| | 16" | 24" | 68" | QRC613DHC (L/R) () () () | 2,483. | 3,253. | 3,741. | 5,051. |
| | 30" | 20" | 68" | QRC632DHC () () () | 2,919. | 3,825. | 4,399. | 5,939. |
| | 30" | 24" | 68" | QRC633DHC () () () | 3,208. | 4,207. | 4,838. | 6,531. |
| | 36" | 20" | 68" | QRC662DHC () () () | 3,177. | 4,161. | 4,785. | 6,460. |
| | 36" | 24" | 68" | QRC663DHC () () () | 3,466. | 4,543. | 5,224. | 7,053. |

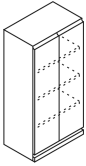

| | | | | | | | | |
|---|-----|-----|-----|------------------------------------|--------|--------|--------|--------|
| Cabinet with full height doors half wardrobe and half shelves | 30" | 20" | 68" | QRC632DHE (L/R) () () () | 3,366. | 4,410. | 5,072. | 6,847. |
| | 30" | 24" | 68" | QRC633DHE (L/R) () () () | 3,714. | 4,870. | 5,600. | 7,560. |
| | 36" | 20" | 68" | QRC662DHE (L/R) () () () | 3,703. | 4,850. | 5,577. | 7,529. |
| | 36" | 24" | 68" | QRC663DHE (L/R) () () () | 4,085. | 5,357. | 6,161. | 8,317. |

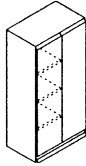

Left hand shown

Order Code

| | |
|-----------|--------------------------|
| Example: | QRC612DHDLWJN |
| QR | Reff Standard Special |
| C | Cabinets |
| 6 | 68" high |
| 1 | 16" wide |
| 2 | 20" deep |
| DH | Desk height |
| D | Wardrobe |
| L | Left hand hinge location |
| L | Laminate finish type |
| W | Wood interior |
| J | Routed pull |
| N | No lock drilling |

Specification Information

To order please specify pattern number including:

- Hinge location, where applicable
- Finish type
- Interior option
- Pull option
- Lock option, where applicable
- Finish, cabinet
- Finish, pull when applicable
- Keying instructions

***After specifying product code, provide keying instructions.**

- Hinge location:**
L = Left hand
R = Right hand
- Finish type:**
L = Laminate
1 = V1
2 = V2
3 = V3
- Interior options:**
W = Wood

- Pull options:**
D = Metal D-pull
J = Routed pull
C = Nickel C-pull (nickel finish only)
S = S-pull (stainless steel finish only)
- Lock options:**
L = Lock hole drilled
N = No lock drilling
- Refer to page 199 for keying instructions.

Product on this page excluding J-pull option will accept woodgrain laminate where laminate is currently an option.
 List price for woodgrain laminate options will be current published laminate list price plus 10%.
 Specify shelf paint finish on open cabinets with metal interiors.
 Please note: Shelf adjustability is limited to approximately 2.5" up or down per shelf from predetermined shelf height.

Application Notes

Key alike are field installed using the KnollKey order form. Random locks are factory installed.

Cabinets do not come with lock included. Keying instructions must accompany all cabinet orders.

Hinge door cabinets have optional lock drilling which can be specified in the cabinet product code.

**Note:*
 Wardrobe cabinets do not come equipped with coat rod and boot tray. Please specify separately from standard Reff price list.

File drawers include file bars for front to back and side to side filing.

File drawers do not support bottom loading.

Applicable finishes are listed on page 102 and 103.

Reff Cabinetry

Cabinets (use with 28³/₈" h support components)

68" high

wood interior

| description | w | d | h | pattern no. | L | V1 | V2 | V3 |
|--|-----|-----|-----|------------------------------|----------|----------|----------|----------|
| Cabinet with two 24 ¹ / ₄ " doors and two adj. shelves | 30" | 20" | 68" | QRC632DHH () () () | \$2,620. | \$3,438. | \$3,954. | \$5,338. |
| | 30" | 24" | 68" | QRC633DHH () () () | 2,877. | 3,772. | 4,337. | 5,855. |
| | 36" | 20" | 68" | QRC662DHH () () () | 2,877. | 3,772. | 4,337. | 5,855. |
| | 36" | 24" | 68" | QRC663DHH () () () | 3,133. | 4,110. | 4,727. | 6,381. |

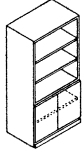

| | | | | | | | | |
|---|-----|-----|-----|------------------------------|--------|--------|--------|--------|
| Cabinet with two sets of hinged doors, two pull-out shelves and ventilation. Audio visual cabinet | 30" | 20" | 68" | QRC632DHI () () () | 3,673. | 4,814. | 5,536. | 7,473. |
| | 30" | 24" | 68" | QRC633DHI () () () | 4,043. | 5,298. | 6,093. | 8,226. |
| | 36" | 20" | 68" | QRC662DHI () () () | 3,929. | 5,152. | 5,925. | 7,999. |
| | 36" | 24" | 68" | QRC663DHI () () () | 4,299. | 5,637. | 6,483. | 8,752. |

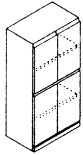

| | | | | | | | | |
|---|-----|-----|-----|------------------------------------|--------|--------|--------|--------|
| Cabinet with BBF below and hinged doors above | 16" | 20" | 68" | QRC612DHP (L/R) () () () | 2,746. | 3,596. | 4,136. | 5,583. |
| | 16" | 24" | 68" | QRC613DHP (L/R) () () () | 3,029. | 3,970. | 4,565. | 6,163. |
| | 30" | 20" | 68" | QRC632DHP () () () | 3,205. | 4,200. | 4,830. | 6,521. |
| | 30" | 24" | 68" | QRC633DHP () () () | 3,520. | 4,613. | 5,305. | 7,161. |
| | 36" | 20" | 68" | QRC662DHP () () () | 3,527. | 4,619. | 5,312. | 7,172. |
| | 36" | 24" | 68" | QRC663DHP () () () | 3,868. | 5,075. | 5,836. | 7,878. |

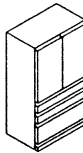

Order Code

| | |
|-----------|--------------------------|
| Example: | QRC612DHDLWJN |
| QR | Reff Standard Special |
| C | Cabinets |
| 6 | 68" high |
| 1 | 16" wide |
| 2 | 20" deep |
| DH | Desk height |
| D | Wardrobe |
| L | Left hand hinge location |
| L | Laminate finish type |
| W | Wood interior |
| J | Routed pull |
| N | No lock drilling |

Specification Information

To order please specify pattern number including:

- Hinge location, where applicable
- Finish type
- Interior option
- Pull option
- Lock option, where applicable
- Finish, cabinet
- Finish, pull when applicable
- Keying instructions

***After specifying product code, provide keying instructions.**

1. Hinge location:
L = Left hand
R = Right hand

2. Finish type:
L = Laminate
1 = V1
2 = V2
3 = V3

3. Interior options:
W = Wood

4. Pull options:
D = Metal D-pull
J = Routed pull
C = Nickel C-pull (nickel finish only)
S = S-pull (stainless steel finish only)

5. Lock options:
L = Lock hole drilled
N = No lock drilling

8. Refer to page 199 for keying instructions.

Product on this page excluding J-pull option will accept woodgrain laminate where laminate is currently an option.
List price for woodgrain laminate options will be current published laminate list price plus 10%.

Specify shelf paint finish on open cabinets with metal interiors.

Please note: Shelf adjustability is limited to approximately 2.5" up or down per shelf from predetermined shelf height.

Application Notes

Key alike are field installed using the KnollKey order form. Random locks are factory installed.

Cabinets do not come with lock included. Keying instructions must accompany all cabinet orders.

Hinge door cabinets have optional lock drilling which can be specified in the cabinet product code.

*Note:
Wardrobe cabinets do not come equipped with coat rod and boot tray. Please specify separately from standard Reff price list.

File drawers include file bars for front to back and side to side filing.

File drawers do not support bottom loading.

Applicable finishes are listed on page 102 and 103.

Reff Cabinetry
 Cabinets (use with 28³/₈" h support components)
 68" high
 metal interior

| description | w | d | h | pattern no. | L | V1 | V2 | V3 |
|--|-----|-----|-----|----------------------------|----------|----------|----------|----------|
| Cabinet with hinged doors and 3 adj. shelves | 16" | 20" | 68" | QRC612DHC (L/R)() () () | \$2,078. | \$2,717. | \$3,125. | \$4,219. |
| | 16" | 24" | 68" | QRC613DHC (L/R)() () () | 2,316. | 3,036. | 3,492. | 4,714. |
| | 30" | 20" | 68" | QRC632DHC () () () () | 2,754. | 3,611. | 4,152. | 5,606. |
| | 30" | 24" | 68" | QRC633DHC () () () () | 3,042. | 3,989. | 4,587. | 6,192. |
| | 36" | 20" | 68" | QRC662DHC () () () () | 3,010. | 3,946. | 4,538. | 6,126. |
| | 36" | 24" | 68" | QRC663DHC () () () () | 3,297. | 4,325. | 4,973. | 6,714. |

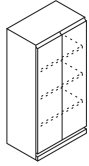

| | | | | | | | | |
|---|-----|-----|-----|----------------------------|--------|--------|--------|--------|
| Cabinet with full height doors half wardrobe and half shelves | 30" | 20" | 68" | QRC632DHE (L/R)() () () | 3,200. | 4,192. | 4,821. | 6,508. |
| | 30" | 24" | 68" | QRC633DHE (L/R)() () () | 3,549. | 4,650. | 5,348. | 7,219. |
| | 36" | 20" | 68" | QRC662DHE (L/R)() () () | 3,535. | 4,631. | 5,326. | 7,190. |
| | 36" | 24" | 68" | QRC663DHE (L/R)() () () | 3,920. | 5,140. | 5,911. | 7,980. |

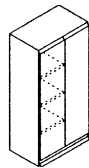

Left hand shown

Order Code

Example: **QRC612DHCLLMJL-114**

| | |
|------------|-------------------------------|
| QR | Reff Standard Special |
| C | Cabinets |
| 6 | 68" high |
| 1 | 16" wide |
| 2 | 20" deep |
| DH | Desk height |
| C | Hinged door w/ 3 adj. shelves |
| L | Left hand hinge location |
| L | Laminate finish type |
| M | Metal interior |
| J | Routed pull |
| L | Locking |
| 114 | Finish, Folkstone grey |

Specification Information

To order please specify pattern number including:

- Hinge location, where applicable
- Finish type
- Interior option
- Pull option
- Lock option, where applicable
- Finish, cabinet
- Finish, pull when applicable
- Keying instructions

***After specifying product code, provide keying instructions.**

1. Hinge location:
 L = Left hand
 R = Right hand

2. Finish type:
 L = Laminate
 1 = V1
 2 = V2
 3 = V3

3. Interior options:
 M = Metal (If laminate case finish-shelves painted to match; if V1, V2 or V3 case finish-shelves painted black; drawer interiors painted black metal)

4. Pull options:
 D = Metal D-pull
 J = Routed pull
 C = Nickel C-pull (nickel finish only)
 S = S-pull (stainless steel finish only)

5. Lock options:
 L = Lock hole drilled
 N = No drilling

8. Refer to page 199 for keying instructions.

Product on this page excluding J-pull option will accept woodgrain laminate where laminate is currently an option.
 List price for woodgrain laminate options will be current published laminate list price plus 10%.

Key alike are field installed using the KnollKey order form. Random locks are factory installed.

Please note: Shelf adjustability is limited to approximately 2.5" up or down per shelf from predetermined shelf height.

Application Notes

Specify finish of metal shelves to match laminate.

Cabinets do not come with lock included. Keying instructions must accompany all cabinet orders.

Hinge door cabinets have optional lock drilling which can be specified in the cabinet product code.

*Wardrobe cabinets do not come equipped with coat rod and boot tray. Please specify separately. See page 0.

File drawers include file bars for front to back and side to side filing.

File drawers do not support bottom loading.

Applicable finishes are listed on page 0 and 0.

Reff Cabinetry

Cabinets (use with 28³/₈" h support components)

68" high

metal interior

| description | w | d | h | pattern no. | L | V1 | V2 | V3 |
|--|-----|-----|-----|------------------------------|----------|----------|----------|----------|
| Cabinet with two 24 ¹ / ₄ " doors and two adj. shelves | 30" | 20" | 68" | QRC632DHH () () () | \$2,454. | \$3,220. | \$3,703. | \$4,999. |
| | 30" | 24" | 68" | QRC633DHH () () () | 2,713. | 3,552. | 4,085. | 5,514. |
| | 36" | 20" | 68" | QRC662DHH () () () | 2,713. | 3,552. | 4,085. | 5,514. |
| | 36" | 24" | 68" | QRC663DHH () () () | 2,970. | 3,892. | 4,476. | 6,042. |

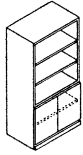

| | | | | | | | | |
|---|-----|-----|-----|------------------------------------|--------|--------|--------|--------|
| Cabinet with BBF below and hinged doors above | 16" | 20" | 68" | QRC612DHP (L/R) () () () | 2,580. | 3,379. | 3,886. | 5,246. |
| | 16" | 24" | 68" | QRC613DHP (L/R) () () () | 2,863. | 3,755. | 4,319. | 5,830. |
| | 30" | 20" | 68" | QRC632DHP () () () | 3,037. | 3,980. | 4,578. | 6,180. |
| | 30" | 24" | 68" | QRC633DHP () () () | 3,351. | 4,394. | 5,053. | 6,822. |
| | 36" | 20" | 68" | QRC662DHP () () () | 3,360. | 4,401. | 5,061. | 6,833. |
| | 36" | 24" | 68" | QRC663DHP () () () | 3,704. | 4,852. | 5,580. | 7,533. |

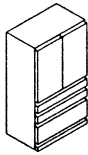

Order Code

Example: **QRC612DHCLLMJL-114**

| | |
|------------|-------------------------------|
| QR | Reff Standard Special |
| C | Cabinets |
| 6 | 68" high |
| 1 | 16" wide |
| 2 | 20" deep |
| DH | Desk height |
| C | Hinged door w/ 3 adj. shelves |
| L | Left hand hinge location |
| L | Laminate finish type |
| M | Metal interior |
| J | Routed pull |
| L | Locking |
| 114 | Finish, Folkstone grey |

Specification Information

To order please specify pattern number including:

- Hinge location, where applicable
- Finish type
- Interior option
- Pull option
- Lock option, where applicable
- Finish, cabinet
- Finish, pull when applicable
- Keying instructions

***After specifying product code, provide keying instructions.**

1. Hinge location:

L = Left hand
R = Right hand

2. Finish type:

L = Laminate
1 = V1
2 = V2
3 = V3

3. Interior options:

M = Metal (If laminate case finish-shelves painted to match; if V1, V2 or V3 case finish-shelves painted black; drawer interiors painted black metal)

4. Pull options:

D = Metal D-pull
J = Routed pull
C = Nickel C-pull (nickel finish only)
S = S-pull (stainless steel finish only)

5. Lock options:

L = Lock hole drilled
N = No drilling

8. Refer to page 199 for keying instructions.

Product on this page excluding J-pull option will accept woodgrain laminate where laminate is currently an option.

List price for woodgrain laminate options will be current published laminate list price plus 10%.

Key alike are field installed using the KnollKey order form. Random locks are factory installed.

Please note: Shelf adjustability is limited to approximately 2.5" up or down per shelf from predetermined shelf height.

Application Notes

Specify finish of metal shelves to match laminate.

Cabinets do not come with lock included. Keying instructions must accompany all cabinet orders.

Hinge door cabinets have optional lock drilling which can be specified in the cabinet product code.

*Wardrobe cabinets do not come equipped with coat rod and boot tray. Please specify separately. See page 0.

File drawers include file bars for front to back and side to side filing.

File drawers do not support bottom loading.

Applicable finishes are listed on page 0 and 0.

Reff Cabinetry

Cabinets (use with 28³/₈" h support components)

75" high

wood interior

Standard Specials Systems

| description | w | d | h | pattern no. | L | V1 | V2 | V3 |
|--|-----|-----|-----|-------------------------------|----------|----------|----------|----------|
| Cabinet with adjustable shelving for coat rod and boot tray interior | 30" | 15" | 75" | QRC731DHBW () () () | \$2,446. | \$3,188. | \$3,666. | \$4,949. |
| | 36" | 15" | 75" | QRC761DHBW () () () | 2,740. | 3,571. | 4,107. | 5,544. |

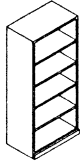

4 adjustable shelves
 Note: Cabinet must be secured to wall to prevent tipping. Hardware is included.

| | | | | | | | | |
|---|-----|-----|-----|---|--------|--------|--------|--------|
| Cabinet with hinged doors for coat rod and boot tray* | 16" | 20" | 75" | QRC712DHD (L/R) () W () () () | 2,164. | 2,819. | 3,242. | 4,376. |
| | 16" | 24" | 75" | QRC713DHD (L/R) () W () () () | 2,377. | 3,096. | 3,560. | 4,807. |

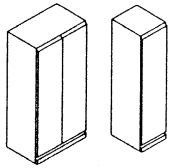

Requires one lock core per cabinet
 Note: Wardrobe cabinets do not come equipped with coat rod and boot tray. Please specify separately from standard Reff price list.

| Order Code | Specification Information | Application Notes |
|-------------------------------------|--|--|
| Example: QRC731DHBW(2)(V316) | To order please specify pattern number including: | Cabinets on this page are engineered to align with front sets of 28 ³ / ₈ " h pedestals and are intended for "desk height" planning applications. Do not mix products from 26¹/₂" h (standard height) planning model with 28³/₈" h (desk height) planning model in any one configuration. |
| QR Reff Standard Special | | 75" nominal height - actual height 75.125" |
| C Cabinet | 1. <i>Hinge location (where applicable)</i> L = left hand R = right hand | Shelf adjustability is 2.5" up or down per shelf from equal drilled spacing. |
| 7 75" h (nominal) | 2. <i>Finish type</i> L = laminate 1 = V1 2 = V2 3 = V3 | File drawers include file bars for front to back and side to side filing. |
| 3 30" w (nominal) | 3. <i>Interior Option</i> W = wood (shelves match case finish or wood drawer interiors) | File drawers support bottom loading. |
| 1 15" d (nominal) | 4. <i>Pull Option (where applicable)</i> D = metal D-pull (finish optional) J = routed J-pull (finish matches case) C = nickel finish C-pull (nickel finish only) S = S-pull (stainless steel finish only) | |
| DH Desk height | | |
| B Open bookcase | | |
| W Interior option, wood | | |
| 2 Finish type, V2 | | |
| V316 Finish, light maple | | |
| | 5. <i>Lock option (where applicable)</i> Optional hinged door configurations only Drawers always lock drilled L = drilled to accept lock N = no drilling | |
| | 6. <i>Cabinet finish</i> | |
| | 7. <i>Optional pull finish where applicable</i> | |
| | 8. <i>Optional drilling to support workwall, left side</i> N = no drilling S0 = 19" h x 15" d S1 = 19" h x 20" d T0 = 23" h x 15" d T1 = 23" h x 20" d | |
| | 9. <i>Optional drilling to support workwall, right side</i> *drilling options same as #8 above | |

Applicable finishes are listed on page 102 and 103.

Product on this page excluding J-pull option will accept woodgrain laminate where laminate is currently an option.
 List price for woodgrain laminate options will be current published laminate list price plus 10%.

Cabinets do not come with lock included. Keying instructions must accompany all cabinet orders, refer to page 199.
 Random locks are factory installed. Key-alike are field installed using the KnollKey order form.

Reff Cabinetry

Cabinets (use with 28³/₈" h support components)

75" high

wood interior

| description | w | d | h | pattern no. | L | V1 | V2 | V3 |
|---|-----|-----|-----|-----------------------------------|----------|----------|----------|----------|
| Cabinet with hinged door and 4 adj. shelves | 16" | 20" | 75" | QRC712DHC(L/R) () () () | \$2,506. | \$3,283. | \$3,775. | \$5,096. |
| | 16" | 24" | 75" | QRC713DHC(L/R) () () () | 2,760. | 3,620. | 4,163. | 5,620. |
| | 30" | 20" | 75" | QRC732DHC () () () | 3,220. | 4,218. | 4,850. | 6,548. |
| | 30" | 24" | 75" | QRC733DHC () () () | 3,554. | 4,657. | 5,355. | 7,230. |
| | 36" | 20" | 75" | QRC762DHC () () () | 3,539. | 4,641. | 5,337. | 7,205. |
| | 36" | 24" | 75" | QRC763DHC () () () | 3,910. | 5,124. | 5,893. | 7,955. |

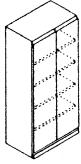

| | | | | | | | | |
|--|-----|-----|-----|------------------------------|--------|--------|--------|--------|
| Cabinet with two hinged 24 ¹ / ₄ " doors and two open adj. shelves | 30" | 20" | 75" | QRC732DHH () () () | 3,090. | 4,053. | 4,661. | 6,292. |
| | 30" | 24" | 75" | QRC733DHH () () () | 3,398. | 4,459. | 5,127. | 6,922. |
| | 36" | 20" | 75" | QRC762DHH () () () | 3,382. | 4,430. | 5,095. | 6,878. |
| | 36" | 24" | 75" | QRC763DHH () () () | 3,690. | 4,835. | 5,560. | 7,506. |

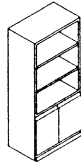

| Order Code | Specification Information | Application Notes |
|-------------------------------------|--|--|
| Example: QRC731DHBW(2)(V316) | <i>To order please specify pattern number including:</i> | |
| QR Ref Standard Special | 5. <i>Lock option (where applicable)</i> | Cabinets on this page are engineered to align with front sets of 28 ³ / ₈ " h pedestals and are intended for "desk height" planning applications. Do not mix products from 26¹/₂" h (standard height) planning model with 28³/₈" h (desk height) planning model in any one configuration. |
| C Cabinet | 1. <i>Hinge location (where applicable)</i> | 75" nominal height - actual height 75.125" |
| 7 75" h (nominal) | L = left hand | Shelf adjustability is 2.5" up or down per shelf from equal drilled spacing. |
| 3 30" w (nominal) | R = right hand | File drawers include file bars for front to back and side to side filing. |
| 1 15" d (nominal) | 2. <i>Finish type</i> | File drawers support bottom loading. |
| DH Desk height | L = laminate | |
| B Open bookcase | 1 = V1 | |
| W Interior option, wood | 2 = V2 | |
| 2 Finish type, V2 | 3 = V3 | |
| V316 Finish, light maple | 3. <i>Interior Option</i> | |
| | W = wood (shelves match case finish or wood drawer interiors) | |
| | 4. <i>Pull Option (where applicable)</i> | |
| | D = metal D-pull (finish optional) | |
| | J = routed J-pull (finish matches case) | |
| | C = nickel finish C-pull (nickel finish only) | |
| | S = S-pull (stainless steel finish only) | |
| | 6. <i>Cabinet finish</i> | |
| | 7. <i>Optional pull finish where applicable</i> | |
| | 8. <i>Optional drilling to support workwall, left side</i> | |
| | N = no drilling | |
| | S0 = 19"h x 15"d | |
| | S1 = 19"h x 20"d | |
| | T0 = 23"h x 15"d | |
| | T1 = 23"h x 20"d | |
| | 9. <i>Optional drilling to support workwall, right side</i> | |
| | *drilling options same as #8 above | |
| | Product on this page excluding J-pull option will accept woodgrain laminate where laminate is currently an option. | |
| | List price for woodgrain laminate options will be current published laminate list price plus 10%. | |
| | Cabinets do not come with lock included. Keying instructions must accompany all cabinet orders, refer to page 199. | |
| | Random locks are factory installed. | |
| | Key-alike are field installed using the KnollKey order form. | |

Applicable finishes are listed on page 102 and 103.

Reff Cabinetry
Cabinets (use with 28³/₈" h support components)
75" high
wood interior

| description | w | d | h | pattern no. | L | V1 | V2 | V3 |
|---|-----|-----|-----|------------------------------|----------|----------|----------|----------|
| Cabinet with two sets of hinged doors, two pull-out shelves and ventilation. Audio visual cabinet | 30" | 20" | 75" | QRC732DHI () () () | \$4,071. | \$5,333. | \$6,133. | \$8,280. |
| | 30" | 24" | 75" | QRC733DHI () () () | 4,493. | 5,889. | 6,772. | 9,143. |
| | 36" | 20" | 75" | QRC762DHI () () () | 4,415. | 5,789. | 6,657. | 8,987. |
| | 36" | 24" | 75" | QRC763DHI () () () | 4,876. | 6,393. | 7,352. | 9,925. |

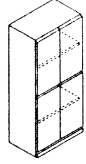

Requires two lock cores per cabinet

| | | | | | | | | |
|---|-----|-----|-----|-----------------------------------|--------|--------|--------|--------|
| Cabinet with BBF below and hinged doors above | 16" | 20" | 75" | QRC712DHP(L/R) () () () | 2,912. | 3,818. | 4,391. | 5,928. |
| | 16" | 24" | 75" | QRC713DHP(L/R) () () () | 3,197. | 4,191. | 4,819. | 6,506. |
| | 30" | 20" | 75" | QRC732DHP () () () | 3,412. | 4,472. | 5,143. | 6,943. |
| | 30" | 24" | 75" | QRC733DHP () () () | 3,746. | 4,907. | 5,643. | 7,619. |
| | 36" | 20" | 75" | QRC762DHP () () () | 3,750. | 4,914. | 5,651. | 7,629. |
| | 36" | 24" | 75" | QRC763DHP () () () | 4,120. | 5,399. | 6,209. | 8,382. |

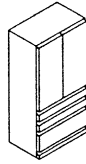

Requires two lock cores per cabinet

| Order Code | Specification Information | Application Notes |
|-------------------------------------|--|--|
| Example: QRC731DHBW(2)(V316) | <i>To order please specify pattern number including:</i> | |
| QR Reff Standard Special | 5. <i>Lock option (where applicable)</i> | Cabinets on this page are engineered to align with front sets of 28 ³ / ₈ " h pedestals and are intended for "desk height" planning applications. Do not mix products from 26¹/₂" h (standard height) planning model with 28³/₈" h (desk height) planning model in any one configuration. |
| C Cabinet | Optional hinged door configurations only Drawers always lock drilled L = drilled to accept lock N = no drilling | |
| 7 75" h (nominal) | 1. <i>Hinge location (where applicable)</i> L = left hand R = right hand | 75" nominal height - actual height 75.125" |
| 3 30" w (nominal) | 2. <i>Finish type</i> L = laminate 1 = V1 2 = V2 3 = V3 | |
| 1 15" d (nominal) | 3. <i>Interior Option</i> W = wood (shelves match case finish or wood drawer interiors) | Shelf adjustability is 2.5" up or down per shelf from equal drilled spacing. |
| DH Desk height | 4. <i>Pull Option (where applicable)</i> D = metal D-pull (finish optional) J = routed J-pull (finish matches case) C = nickel finish C-pull (nickel finish only) S = S-pull (stainless steel finish only) | |
| B Open bookcase | | File drawers include file bars for front to back and side to side filing. |
| W Interior option, wood | | File drawers support bottom loading. |
| 2 Finish type, V2 | | |
| V316 Finish, light maple | | |

Applicable finishes are listed on page 102 and 103.

Product on this page excluding J-pull option will accept woodgrain laminate where laminate is currently an option. List price for woodgrain laminate options will be current published laminate list price plus 10%.

Cabinets do not come with lock included. Keying instructions must accompany all cabinet orders, refer to page 199. Random locks are factory installed. Key-alike are field installed using the KnollKey order form.

Reff Cabinetry

Cabinets (use with 28³/₈" h support components)

75" high

metal interior

| description | w | d | h | pattern no. | L | V1 | V2 | V3 |
|---|-----|-----|-----|-------------------------------|----------|----------|----------|----------|
| Cabinet with adjustable shelving metal interior | 30" | 15" | 75" | QRC731DHBM () () () | \$2,280. | \$2,972. | \$3,418. | \$4,614. |
| | 36" | 15" | 75" | QRC761DHBM () () () | 2,572. | 3,352. | 3,855. | 5,204. |

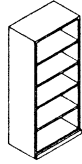

4 adjustable shelves

Note: Cabinet must be secured to wall to prevent tipping. Hardware is included.

| | | | | | | | | |
|---|-----|-----|-----|-----------------------------------|--------|--------|--------|--------|
| Cabinet with hinged door and 4 adj. shelves | 16" | 20" | 75" | QRC712DHC(L/R) () () () | 2,338. | 3,062. | 3,521. | 4,753. |
| | 16" | 24" | 75" | QRC713DHC(L/R) () () () | 2,596. | 3,402. | 3,912. | 5,281. |
| | 30" | 20" | 75" | QRC732DHC () () () | 3,052. | 4,002. | 4,602. | 6,213. |
| | 30" | 24" | 75" | QRC733DHC () () () | 3,386. | 4,437. | 5,103. | 6,889. |
| | 36" | 20" | 75" | QRC762DHC () () () | 3,374. | 4,424. | 5,087. | 6,868. |
| | 36" | 24" | 75" | QRC763DHC () () () | 3,744. | 4,903. | 5,639. | 7,612. |

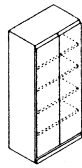

Requires one lock core per cabinet

Shelves painted metal

| Order Code | Specification Information | Application Notes |
|-------------------------------------|---|--|
| Example: QRC731DHBM(2)(V316) | <i>To order please specify pattern number including:</i> | |
| QR Ref Standard Special | | |
| C Cabinet | 1. <i>Hinge location (where applicable)</i> L = left hand R = right hand | |
| 7 75" h (nominal) | 2. <i>Finish type</i> L = laminate 1 = V1 2 = V2 3 = V3 | |
| 3 30" w (nominal) | 3. <i>Interior Option</i> M = metal (metal shelves or metal drawers) *If laminate case, specify finish of metal shelves to match; if case V1 or V2 finish, shelves are black) | |
| 1 15" d (nominal) | 4. <i>Pull Option (where applicable)</i> D = metal D-pull (finish optional) J = routed J-pull (finish matches case) C = nickel finish C-pull (nickel finish only) S = S-pull (stainless steel finish only) | |
| DH Desk height | 5. <i>Lock option (where applicable)</i> Optional hinged door configurations only Drawers always lock drilled L = drilled to accept lock N = no drilling | Cabinets on this page are engineered to align with front sets of 28 ³ / ₈ " h pedestals and are intended for "desk height" planning applications. Do not mix products from 26¹/₂" h (standard height) planning model with 28³/₈" h (desk height) planning model in any one configuration. |
| B Open bookcase | 6. <i>Cabinet finish</i> | 75" nominal height - actual height 75.125" |
| M Interior option, metal | 7. <i>Optional pull finish where applicable</i> | Shelf adjustability is 2.5" up or down per shelf from equal drilled spacing. |
| 2 Finish type, V2 | 8. <i>Optional drilling to support workwall, left side</i> N = no drilling S0 = 19" h x 15" d S1 = 19" h x 20" d T0 = 23" h x 15" d T1 = 23" h x 20" d | File drawers include file bars for front to back and side to side filing. |
| V316 Finish, light maple | 9. <i>Optional drilling to support workwall, right side</i> *drilling options same as #8 above | File drawers support bottom loading. |
| | Product on this page excluding J-pull option will accept woodgrain laminate where laminate is currently an option. List price for woodgrain laminate options will be current published laminate list price plus 10%. | |
| | Cabinets do not come with lock included. Keying instructions must accompany all cabinet orders, refer to page 199. Random locks are factory installed. Key-alike are field installed using the KnollKey order form. | |

Applicable finishes are listed on page 102 and 103.

Reff Cabinetry

Cabinets (use with 28³/₈" h support components)

75" high

metal interior

Standard Specials Systems

| description | w | d | h | pattern no. | L | V1 | V2 | V3 |
|--|-----|-----|-----|------------------------------|----------|----------|----------|----------|
| Cabinet with two hinged 24 ¹ / ₄ " doors and two open adj. shelves | 30" | 20" | 75" | QRC732DHH () () () | \$2,932. | \$3,837. | \$4,413. | \$5,957. |
| | 30" | 24" | 75" | QRC733DHH () () () | 3,239. | 4,240. | 4,876. | 6,583. |
| | 36" | 20" | 75" | QRC762DHH () () () | 3,221. | 4,218. | 4,850. | 6,548. |
| | 36" | 24" | 75" | QRC763DHH () () () | 3,531. | 4,621. | 5,314. | 7,174. |

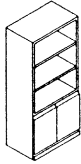

| | | | | | | | | |
|---|-----|-----|-----|-----------------------------------|--------|--------|--------|--------|
| Cabinet with BBF below and hinged doors above | 16" | 20" | 75" | QRC712DHP(L/R) () () () | 2,749. | 3,599. | 4,139. | 5,587. |
| | 16" | 24" | 75" | QRC713DHP(L/R) () () () | 3,029. | 3,970. | 4,565. | 6,163. |
| | 30" | 20" | 75" | QRC732DHP () () () | 3,243. | 4,250. | 4,887. | 6,598. |
| | 30" | 24" | 75" | QRC733DHP () () () | 3,578. | 4,690. | 5,394. | 7,282. |
| | 36" | 20" | 75" | QRC762DHP () () () | 3,584. | 4,697. | 5,402. | 7,292. |
| | 36" | 24" | 75" | QRC763DHP () () () | 3,955. | 5,178. | 5,955. | 8,039. |

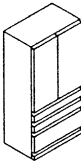

| Order Code | Specification Information | Application Notes |
|-------------------------------------|--|--|
| Example: QRC731DHBM(2)(V316) | <i>To order please specify pattern number including:</i> | |
| QR Ref Standard Special | 5. <i>Lock option (where applicable)</i> | Cabinets on this page are engineered to align with front sets of 28 ³ / ₈ " h pedestals and are intended for "desk height" planning applications. Do not mix products from 26¹/₂" h (standard height) planning model with 28³/₈" h (desk height) planning model in any one configuration. |
| C Cabinet | 1. <i>Hinge location (where applicable)</i> | 75" nominal height - actual height 75.125" |
| 7 75" h (nominal) | L = left hand | Shelf adjustability is 2.5" up or down per shelf from equal drilled spacing. |
| 3 30" w (nominal) | R = right hand | File drawers include file bars for front to back and side to side filing. |
| 1 15" d (nominal) | 2. <i>Finish type</i> | File drawers support bottom loading. |
| DH Desk height | L = laminate | |
| B Open bookcase | 1 = V1 | |
| M Interior option, metal | 2 = V2 | |
| 2 Finish type, V2 | 3 = V3 | |
| V316 Finish, light maple | 3. <i>Interior Option</i> | |
| | M = metal (metal shelves or metal drawers) | |
| | *If laminate case, specify finish of metal shelves to match; if case V1 or V2 finish, shelves are black) | |
| | 4. <i>Pull Option (where applicable)</i> | |
| | D = metal D-pull (finish optional) | |
| | J = routed J-pull (finish matches case) | |
| | C = nickel finish C-pull (nickel finish only) | |
| | S = S-pull (stainless steel finish only) | |
| | 6. <i>Cabinet finish</i> | |
| | 7. <i>Optional pull finish where applicable</i> | |
| | 8. <i>Optional drilling to support workwall, left side</i> | |
| | N = no drilling | |
| | S0 = 19"h x 15"d | |
| | S1 = 19"h x 20"d | |
| | T0 = 23"h x 15"d | |
| | T1 = 23"h x 20"d | |
| | 9. <i>Optional drilling to support workwall, right side</i> | |
| | *drilling options same as #8 above | |
| | Product on this page excluding J-pull option will accept woodgrain laminate where laminate is currently an option. | |
| | List price for woodgrain laminate options will be current published laminate list price plus 10%. | |
| | Cabinets do not come with lock included. Keying instructions must accompany all cabinet orders, refer to page 199. | |
| | Random locks are factory installed. Key-alike are field installed using the KnollKey order form. | |

Applicable finishes are listed on page 102 and 103.

Reff Overhead storage
*overdesk units, standard height planning model
 use with 1 1/4" worksurfaces and 26 1/2" h support*

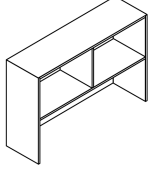
| description | d | w | h | doors | pattern no. | lam. | V1 | V2 | V3 |
|--|-----|-----|---------|-------|----------------------------------|----------|----------|----------|----------|
| For 1 1/4" worksurfaces Open, 14" deep  | 14" | 30" | 44 1/4" | | QROAO30T0 () () () () | \$1,565. | \$1,956. | \$2,249. | \$3,037. |
| | 14" | 36" | 44 1/4" | | QROAO36T0 () () () () | 1,640. | 2,054. | 2,362. | 3,189. |
| | 14" | 42" | 44 1/4" | | QROAO42T0 () () () () | 1,716. | 2,152. | 2,475. | 3,341. |
| | 14" | 48" | 44 1/4" | | QROAO48T0 () () () () | 1,791. | 2,250. | 2,588. | 3,493. |
| | 14" | 54" | 44 1/4" | | QROAO54T0 () () () () | 1,867. | 2,348. | 2,700. | 3,645. |
| | 14" | 66" | 44 1/4" | | QROAO66T0 () () () () | 2,381. | 2,991. | 3,440. | 4,644. |
| | 14" | 78" | 44 1/4" | | QROAO78T0 () () () () | 2,532. | 2,701. | 3,106. | 4,193. |
| | 14" | 84" | 44 1/4" | | QROAO84T0 () () () () | 2,605. | 3,285. | 3,778. | 5,100. |

center divider on 42" and wider.

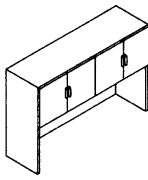
| | | | | | | | | | |
|--|-----|-----|---------|---|--|--------|--------|--------|--------|
| For 1 1/4" worksurfaces Hinged doors, 15" deep  | 15" | 30" | 44 1/4" | 2 | QROAH30T0 () () () () () () | 2,289. | 2,867. | 3,297. | 4,451. |
| | 15" | 36" | 44 1/4" | 2 | QROAH36T0 () () () () () () | 2,423. | 3,036. | 3,491. | 4,713. |
| | 15" | 42" | 44 1/4" | 3 | QROAH42T0 () () () () () () | 2,556. | 3,205. | 3,686. | 4,976. |
| | 15" | 48" | 44 1/4" | 3 | QROAH48T0 () () () () () () | 2,689. | 3,374. | 3,880. | 5,238. |
| | 15" | 54" | 44 1/4" | 3 | QROAH54T0 () () () () () () | 2,823. | 3,542. | 4,073. | 5,499. |
| | 15" | 66" | 44 1/4" | 4 | QROAH66T0 () () () () () () | 3,577. | 4,480. | 5,152. | 6,955. |
| | 15" | 78" | 44 1/4" | 4 | QROAH78T0 () () () () () () | 3,843. | 4,818. | 5,541. | 7,480. |
| | 15" | 84" | 44 1/4" | 6 | QROAH84T0 () () () () () () | 3,977. | 4,987. | 5,735. | 7,742. |

| Order Code | Specification Information | Application Notes |
|---------------------------------------|---|--|
| Example: QROAF30S0LJLBF118 () | To order please specify pattern number including: | Shipped knocked-down. |
| QR Reff Standard Special | | Open cabinets require no locks. |
| O Overhead | | Tasklights not included. |
| A For 1 1/4" top mounting | | Tackboard included, fabric railroaded. |
| F Flip door | | C, D and S pulls are not available for flip door units. |
| 30 30" wide | | All flip door cabinets on this page are nominal 19"H not 23"H. |
| S Standard height | | Open/hinge doors are nominal 23"H, actual 22 3/8". |
| 0 15" deep | | Locks are not factory installed. |
| L Finish type, laminate | | Include grommet (black only) in back panel for task light cord. If used in open plan areas specify "no grommet." |
| J J-pull | | Wire manager is included and mounts adjacent to tackboard. Specify color. |
| L Locks included | | |
| BF Cord escape, back feed | | |
| 118 Finish, Bright White | | |
| (W250) Fabric | | |
| | 1. Configuration option O = Open H = Hinged door F = Flip door | |
| | 2. Width | |
| | 3. Storage option S0 = 19"h x 15"d S1 = 19"h x 20"d T0 = 23"h x 15"d T1 = 23"h x 20"d | |
| | 4. Finish type L = Laminate 1 = V1 2 = V2 3 = V3 | |
| | 5. Pull option for hinged door only D = Metal D-pull (for hinged doors only) J = Routed pull C = Nickel C-pull (nickel finish only, for hinged doors only) S = Stainless steel finish S-pull (stainless steel finish only, for hinged doors only) | |
| | 6. Lock option L = Lockhole drilled N = No lock drilling | |
| | 7. Cord escape option | |
| | 8. Finish | |
| | 9. Pull finish where applicable | |
| | 10. Fabric for tackboard | |
| | Product on this page excluding J-pull option will accept woodgrain laminate where laminate is currently an option. List price for woodgrain laminate options will be current published laminate list price plus 10%. | |
| | *After specifying product code, provide keying instructions. | |
| | Overdesk unit will achieve 72" nominal height when used with correct top. | |
| | The clearance under the overhead to the top of the worksurface is approximately 21 1/4". | |
| | Applicable finishes are listed on page 102 and 103. | |
| | Odd numbered hinged door is always on left side, left hinged. | |

Reff Overhead storage
overdesk units, standard height planning model
use with 1 1/4" worksurfaces and 26 1/2" h support

| description | d | w | h | doors | pattern no. | lam. | V1 | V2 | V3 |
|-------------------------|-----|-----|---------|-------|----------------------------------|----------|----------|----------|----------|
| For 1 1/4" worksurfaces | 15" | 30" | 44 1/4" | 1 | QROAF30S0 () () () () | \$1,509. | \$2,059. | \$2,368. | \$3,197. |
| Flip doors, 15" deep | 15" | 36" | 44 1/4" | 1 | QROAF36S0 () () () () | 1,736. | 2,367. | 2,722. | 3,675. |
| | 15" | 42" | 44 1/4" | 1 | QROAF42S0 () () () () | 1,962. | 2,675. | 3,076. | 4,153. |
| | 15" | 48" | 44 1/4" | 1 | QROAF48S0 () () () () | 2,189. | 2,983. | 3,430. | 4,631. |
| | 15" | 54" | 44 1/4" | 2 | QROAF54S0 () () () () | 2,415. | 3,291. | 3,785. | 5,109. |
| | 15" | 66" | 44 1/4" | 2 | QROAF66S0 () () () () | 2,869. | 4,171. | 4,797. | 6,475. |
| | 15" | 78" | 44 1/4" | 2 | QROAF78S0 () () () () | 3,717. | 4,754. | 5,467. | 7,381. |
| | 15" | 90" | 44 1/4" | 2 | QROAF90S0 () () () () | 3,807. | 4,883. | 5,615. | 7,581. |

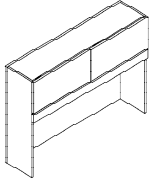

| | | | | | | | | | |
|-------------------------|-----|-----|---------|--|----------------------------------|--------|--------|--------|--------|
| For 1 1/4" worksurfaces | 19" | 30" | 44 1/4" | | QROAO30T1 () () () () | 1,657. | 2,061. | 2,370. | 3,200. |
| Open, 19" deep | 19" | 36" | 44 1/4" | | QROAO36T1 () () () () | 1,738. | 2,169. | 2,494. | 3,367. |
| | 19" | 42" | 44 1/4" | | QROAO42T1 () () () () | 1,820. | 2,276. | 2,617. | 3,533. |
| | 19" | 48" | 44 1/4" | | QROAO48T1 () () () () | 1,901. | 2,384. | 2,742. | 3,701. |
| | 19" | 54" | 44 1/4" | | QROAO54T1 () () () () | 1,982. | 2,491. | 2,865. | 3,867. |
| | 19" | 66" | 44 1/4" | | QROAO66T1 () () () () | 2,520. | 3,166. | 3,641. | 4,915. |
| | 19" | 78" | 44 1/4" | | QROAO78T1 () () () () | 2,602. | 3,381. | 3,888. | 5,249. |
| | 19" | 84" | 44 1/4" | | QROAO84T1 () () () () | 2,766. | 3,488. | 4,011. | 5,415. |

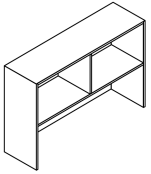

center divider on 42" and wider.

| Order Code | Specification Information | Application Notes |
|--------------------------------------|--|--|
| Example: QROAF30S0LJLBF118() | To order please specify pattern number including: | Shipped knocked-down. |
| QR Reff Standard Special | 1. Configuration option | Open cabinets require no locks. |
| O Overhead | O = Open | Tasklights not included. |
| A For 1 1/4" top mounting | H = Hinged door | Tackboard included, fabric railroaded. |
| F Flip door | F = Flip door | C, D and S pulls are not available for flip door units. |
| 30 30" wide | 2. Width | All flip door cabinets on this page are nominal 19"H not 23"H. |
| S Standard height | 3. Storage option | Open/hinge doors are nominal 23"H, actual 22 3/8". |
| 0 15" deep | S0 = 19"h x 15"d | Locks are not factory installed. |
| L Finish type, laminate | S1 = 19"h x 20"d | Include grommet (black only) in back panel for task light cord. If used in open plan areas specify "no grommet." |
| J J-pull | T0 = 23"h x 15"d | Wire manager is included and mounts adjacent to tackboard. Specify color. |
| L Locks included | T1 = 23"h x 20"d | |
| BF Cord escape, back feed | 4. Finish type | |
| 118 Finish, Bright White | L = Laminate | |
| (W250) Fabric | 1 = V1 | |
| | 2 = V2 | |
| | 3 = V3 | |
| | 5. Pull option for hinged door only | |
| | D = Metal D-pull (for hinged doors only) | |
| | J = Routed pull | |
| | C = Nickel C-pull (nickel finish only, for hinged doors only) | |
| | S = Stainless steel finish S-pull (stainless steel finish only, for hinged doors only) | |
| | 6. Lock option | |
| | L = Lockhole drilled | |
| | N = No lock drilling | |
| | 7. Cord escape option | |
| | 8. Finish | |
| | 9. Pull finish where applicable | |
| | 10. Fabric for tackboard | |
| | Product on this page excluding J-pull option will accept woodgrain laminate where laminate is currently an option. | |
| | List price for woodgrain laminate options will be current published laminate list price plus 10%. | |
| | *After specifying product code, provide keying instructions. | |
| | Overdesk unit will achieve 72" nominal height when used with correct top. | |
| | The clearance under the overhead to the top of the worksurface is approximately 21 1/4". | |
| | Applicable finishes are listed on page 102 and 103. | |
| | Odd numbered hinged door is always on left side, left hinged. | |

Reff Overhead storage
overdesk units, standard height planning model
use with 1 1/4" worksurfaces and 26 1/2" h support

| description | d | w | h | doors | pattern no. | lam. | V1 | V2 | V3 |
|-------------------------|-----|-----|---------|-------|--|----------|----------|----------|----------|
| For 1 1/4" worksurfaces | 20" | 30" | 44 1/4" | 2 | QROAH30T1 () () () () () () | \$2,411. | \$3,020. | \$3,473. | \$4,689. |
| Hinged doors, 20" deep | 20" | 36" | 44 1/4" | 2 | QROAH36T1 () () () () () () | 2,555. | 3,201. | 3,681. | 4,970. |
| | 20" | 42" | 44 1/4" | 3 | QROAH42T1 () () () () () () | 2,699. | 3,383. | 3,890. | 5,252. |
| | 20" | 48" | 44 1/4" | 3 | QROAH48T1 () () () () () () | 2,843. | 3,565. | 4,100. | 5,535. |
| | 20" | 54" | 44 1/4" | 3 | QROAH54T1 () () () () () () | 2,987. | 3,747. | 4,309. | 5,817. |
| | 20" | 66" | 44 1/4" | 4 | QROAH66T1 () () () () () () | 3,776. | 4,729. | 5,438. | 7,342. |
| | 20" | 78" | 44 1/4" | 4 | QROAH78T1 () () () () () () | 3,920. | 5,094. | 5,858. | 7,908. |
| | 20" | 84" | 44 1/4" | 6 | QROAH84T1 () () () () () () | 4,207. | 5,276. | 6,067. | 8,191. |

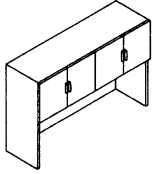

| | | | | | | | | | |
|-------------------------|-----|-----|---------|---|----------------------------------|--------|--------|--------|--------|
| For 1 1/4" worksurfaces | 20" | 30" | 44 1/4" | 1 | QROAF30S1 () () () () | 1,608. | 2,191. | 2,520. | 3,402. |
| Flip doors, 20" deep | 20" | 36" | 44 1/4" | 1 | QROAF36S1 () () () () | 1,846. | 2,515. | 2,892. | 3,905. |
| | 20" | 42" | 44 1/4" | 1 | QROAF42S1 () () () () | 2,083. | 2,838. | 3,264. | 4,406. |
| | 20" | 48" | 44 1/4" | 1 | QROAF48S1 () () () () | 2,320. | 3,161. | 3,635. | 4,907. |
| | 20" | 54" | 44 1/4" | 2 | QROAF54S1 () () () () | 2,557. | 3,485. | 4,008. | 5,410. |
| | 20" | 66" | 44 1/4" | 2 | QROAF66S1 () () () () | 3,030. | 4,404. | 5,065. | 6,837. |
| | 20" | 78" | 44 1/4" | 2 | QROAF78S1 () () () () | 3,929. | 5,028. | 5,782. | 7,806. |
| | 20" | 90" | 44 1/4" | 2 | QROAF90S1 () () () () | 4,031. | 5,172. | 5,948. | 8,030. |

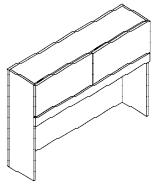

| Order Code | Specification Information | Application Notes |
|--------------------------------------|--|--|
| Example: QROAF30S0LJLBF118() | To order please specify pattern number including: | Shipped knocked-down. |
| QR Reff Standard Special | 1. Configuration option | Open cabinets require no locks. |
| O Overhead | O = Open | Tasklights not included. |
| A For 1 1/4" top mounting | H = Hinged door | Tackboard included, fabric railroaded. |
| F Flip door | F = Flip door | C, D and S pulls are not available for flip door units. |
| 30 30" wide | 2. Width | All flip door cabinets on this page are nominal 19"H not 23"H. |
| S Standard height | 3. Storage option | Open/hinge doors are nominal 23"H, actual 22 3/8". |
| 0 15" deep | S0 = 19"h x 15"d | Locks are not factory installed. |
| L Finish type, laminate | S1 = 19"h x 20"d | Include grommet (black only) in back panel for task light cord. If used in open plan areas specify "no grommet." |
| J J-pull | T0 = 23"h x 15"d | Wire manager is included and mounts adjacent to tackboard. Specify color. |
| L Locks included | T1 = 23"h x 20"d | |
| BF Cord escape, back feed | 4. Finish type | |
| 118 Finish, Bright White | L = Laminate | |
| (W250) Fabric | 1 = V1 | |
| | 2 = V2 | |
| | 3 = V3 | |
| | 5. Pull option for hinged door only | |
| | D = Metal D-pull (for hinged doors only) | |
| | J = Routed pull | |
| | C = Nickel C-pull (nickel finish only, for hinged doors only) | |
| | S = Stainless steel finish S-pull (stainless steel finish only, for hinged doors only) | |
| | 6. Lock option | |
| | L = Lockhole drilled | |
| | N = No lock drilling | |
| | 7. Cord escape option | |
| | 8. Finish | |
| | 9. Pull finish where applicable | |
| | 10. Fabric for tackboard | |
| | Product on this page excluding J-pull option will accept woodgrain laminate where laminate is currently an option. | |
| | List price for woodgrain laminate options will be current published laminate list price plus 10%. | |
| | *After specifying product code, provide keying instructions. | |
| | Overdesk unit will achieve 72" nominal height when used with correct top. | |
| | The clearance under the overhead to the top of the worksurface is approximately 21 1/4". | |
| | Applicable finishes are listed on page 102 and 103. | |
| | Odd numbered hinged door is always on left side, left hinged. | |

Reff Overhead storage
*overdesk units, standard height planning model
 use with 1³/₄" worksurfaces and 26¹/₂"h support*

| description | d | w | h | doors | pattern no. | lam. | V1 | V2 | V3 |
|--|-----|-----|----------------------------------|-------|----------------------------------|----------|----------|----------|----------|
| For 1 ³ / ₄ " worksurfaces Open, 14" deep | 14" | 30" | 43 ³ / ₄ " | | QROB030T0 () () () () | \$1,429. | \$1,809. | \$2,080. | \$2,808. |
| | 14" | 36" | 43 ³ / ₄ " | | QROB036T0 () () () () | 1,543. | 1,952. | 2,245. | 3,030. |
| | 14" | 42" | 43 ³ / ₄ " | | QROB042T0 () () () () | 1,658. | 2,095. | 2,409. | 3,252. |
| | 14" | 48" | 43 ³ / ₄ " | | QROB048T0 () () () () | 1,772. | 2,237. | 2,573. | 3,473. |
| | 14" | 54" | 43 ³ / ₄ " | | QROB054T0 () () () () | 1,887. | 2,380. | 2,737. | 3,695. |
| | 14" | 66" | 43 ³ / ₄ " | | QROB066T0 () () () () | 2,392. | 3,027. | 3,481. | 4,699. |
| | 14" | 78" | 43 ³ / ₄ " | | QROB078T0 () () () () | 2,621. | 3,312. | 3,809. | 5,142. |
| | 14" | 84" | 43 ³ / ₄ " | | QROB084T0 () () () () | 2,735. | 3,455. | 3,973. | 5,364. |

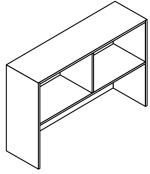

center divider on 42" and wider.

| | | | | | | | | | |
|--|-----|-----|----------------------------------|---|--------------------------------------|--------|--------|--------|--------|
| For 1 ³ / ₄ " worksurfaces Hinged doors, 15" deep | 15" | 30" | 43 ³ / ₄ " | 2 | QROBH30T0 () () () () () | 2,316. | 2,896. | 3,330. | 4,496. |
| | 15" | 36" | 43 ³ / ₄ " | 2 | QROBH36T0 () () () () () | 2,451. | 3,067. | 3,527. | 4,762. |
| | 15" | 42" | 43 ³ / ₄ " | 3 | QROBH42T0 () () () () () | 2,585. | 3,238. | 3,724. | 5,027. |
| | 15" | 48" | 43 ³ / ₄ " | 3 | QROBH48T0 () () () () () | 2,720. | 3,409. | 3,920. | 5,292. |
| | 15" | 54" | 43 ³ / ₄ " | 3 | QROBH54T0 () () () () () | 2,854. | 3,580. | 4,117. | 5,558. |
| | 15" | 66" | 43 ³ / ₄ " | 4 | QROBH66T0 () () () () () | 3,618. | 4,530. | 5,210. | 7,033. |
| | 15" | 78" | 43 ³ / ₄ " | 4 | QROBH78T0 () () () () () | 3,887. | 4,873. | 5,604. | 7,565. |
| | 15" | 84" | 43 ³ / ₄ " | 6 | QROBH84T0 () () () () () | 4,020. | 5,045. | 5,802. | 7,832. |

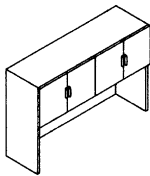

| Order Code | Specification Information | Application Notes |
|---|---|--|
| Example: QROBF30S0LJLBF118() | To order please specify pattern number including: | Shipped knocked-down. |
| QR Reff Standard Special | 1. Configuration option | Open cabinets require no locks. |
| O Overhead | O = Open | Tasklights not included. |
| B For 1 ³ / ₄ " top mounting | H = Hinged door | Tackboard included, fabric railroded. |
| F Flip door | F = Flip door | C, D and S pulls are not available for flip door units. |
| 30 30" wide | 2. Width | All flip door cabinets on this page are nominal 19"H not 23"H. |
| S Standard height | 3. Storage option | Open/hinge doors are nominal 23"H, actual 22 ³ / ₈ ". |
| 0 15" deep | S0 = 19"h x 15"d | Locks are not factory installed. |
| L Finish type, laminate | S1 = 19"h x 20"d | Include grommet (black only) in back panel for task light cord. If used in open plan areas specify "no grommet." |
| J J-pull | T0 = 23"h x 15"d | Wire manager is included and mounts adjacent to tackboard. Specify color. |
| L Locks included | T1 = 23"h x 20"d | |
| BF Cord escape, back feed | 4. Finish type | |
| 118 Finish, Bright White | L = Laminate | |
| (W250) Fabric | 1 = V1 | |
| | 2 = V2 | |
| | 3 = V3 | |
| | 5. Pull option for hinged door only | |
| | D = Metal D-pull (for hinged doors only) | |
| | J = Routed pull | |
| | C = Nickel C-pull (nickel finish only, for hinged doors only) | |
| | S = Stainless steel finish S-pull (stainless steel finish only, for hinged doors only) | |
| | 6. Lock option | |
| | L = Lockhole drilled | |
| | N = No lock drilling | |
| | 7. Cord escape option | |
| | 8. Finish | |
| | 9. Pull finish where applicable | |
| | 10. Fabric for tackboard | |
| | *After specifying product code, provide keying instructions. | |
| | Overdesk unit will achieve 72" nominal height when used with correct top. | |
| | The clearance under the overhead to the top of the worksurface is approximately 20 ³ / ₄ ". | |
| | Applicable finishes are listed on page 102 and 103. | |
| | Odd numbered hinged door is always on left side, left hinged. | |

Reff Overhead storage
*overdesk units, standard height planning model
 use with 1 3/4" worksurfaces and 26 1/2" h support*

| description | d | w | h | doors | pattern no. | lam. | V1 | V2 | V3 |
|-------------------------|-----|-----|---------|-------|----------------------------------|----------|----------|----------|----------|
| For 1 3/4" worksurfaces | 15" | 30" | 43 3/4" | 1 | QROBF30S0 () () () () | \$1,522. | \$2,079. | \$2,391. | \$3,228. |
| Flip doors, 15" deep | 15" | 36" | 43 3/4" | 1 | QROBF36S0 () () () () | 1,752. | 2,392. | 2,751. | 3,714. |
| | 15" | 42" | 43 3/4" | 1 | QROBF42S0 () () () () | 1,982. | 2,705. | 3,111. | 4,200. |
| | 15" | 48" | 43 3/4" | 1 | QROBF48S0 () () () () | 2,213. | 3,017. | 3,470. | 4,684. |
| | 15" | 54" | 43 3/4" | 2 | QROBF54S0 () () () () | 2,443. | 3,330. | 3,829. | 5,170. |
| | 15" | 66" | 43 3/4" | 2 | QROBF66S0 () () () () | 2,902. | 4,219. | 4,852. | 6,550. |
| | 15" | 78" | 43 3/4" | 2 | QROBF78S0 () () () () | 3,759. | 4,804. | 5,525. | 7,458. |
| | 15" | 90" | 43 3/4" | 2 | QROBF90S0 () () () () | 3,852. | 4,943. | 5,684. | 7,674. |

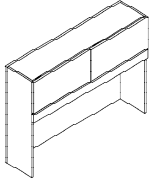

| | | | | | | | | | |
|-------------------------|-----|-----|---------|--|----------------------------------|--------|--------|--------|--------|
| For 1 3/4" worksurfaces | 19" | 30" | 43 3/4" | | QROBO30T1 () () () () | 1,752. | 2,183. | 2,510. | 3,389. |
| Open, 19" deep | 19" | 36" | 43 3/4" | | QROBO36T1 () () () () | 1,815. | 2,268. | 2,608. | 3,521. |
| | 19" | 42" | 43 3/4" | | QROBO42T1 () () () () | 1,877. | 2,353. | 2,706. | 3,653. |
| | 19" | 48" | 43 3/4" | | QROBO48T1 () () () () | 1,940. | 2,438. | 2,804. | 3,785. |
| | 19" | 54" | 43 3/4" | | QROBO54T1 () () () () | 2,002. | 2,523. | 2,901. | 3,917. |
| | 19" | 66" | 43 3/4" | | QROBO66T1 () () () () | 2,550. | 3,203. | 3,683. | 4,973. |
| | 19" | 78" | 43 3/4" | | QROBO78T1 () () () () | 2,676. | 3,374. | 3,880. | 5,238. |
| | 19" | 84" | 43 3/4" | | QROBO84T1 () () () () | 2,739. | 3,459. | 3,978. | 5,370. |

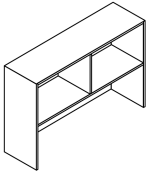

center divider on 42" and wider.

| Order Code | Specification Information | Application Notes |
|--------------------------------------|--|--|
| Example: QROBF30S0LJLBF118() | To order please specify pattern number including: | Shipped knocked-down. |
| QR Reff Standard Special | 1. Configuration option | Open cabinets require no locks. |
| O Overhead | O = Open | Tasklights not included. |
| B For 1 3/4" top mounting | H = Hinged door | Tackboard included, fabric railroded. |
| F Flip door | F = Flip door | C, D and S pulls are not available for flip door units. |
| 30 30" wide | 2. Width | All flip door cabinets on this page are nominal 19"H not 23"H. |
| S Standard height | 3. Storage option | Open/hinge doors are nominal 23"H, actual 22 3/8". |
| 0 15" deep | S0 = 19"h x 15"d | Locks are not factory installed. |
| L Finish type, laminate | S1 = 19"h x 20"d | Include grommet (black only) in back panel for task light cord. If used in open plan areas specify "no grommet." |
| J J-pull | T0 = 23"h x 15"d | Wire manager is included and mounts adjacent to tackboard. Specify color. |
| L Locks included | T1 = 23"h x 20"d | |
| BF Cord escape, back feed | 4. Finish type | |
| 118 Finish, Bright White | L = Laminate | |
| (W250) Fabric | 1 = V1 | |
| | 2 = V2 | |
| | 3 = V3 | |
| | 5. Pull option for hinged door only | |
| | D = Metal D-pull (for hinged doors only) | |
| | J = Routed pull | |
| | C = Nickel C-pull (nickel finish only, for hinged doors only) | |
| | S = Stainless steel finish S-pull (stainless steel finish only, for hinged doors only) | |
| | 6. Lock option | |
| | L = Lockhole drilled | |
| | N = No lock drilling | |
| | 7. Cord escape option | |
| | 8. Finish | |
| | 9. Pull finish where applicable | |
| | 10. Fabric for tackboard | |
| | *After specifying product code, provide keying instructions. | |
| | Overdesk unit will achieve 72" nominal height when used with correct top. | |
| | The clearance under the overhead to the top of the worksurface is approximately 20 3/4". | |
| | Applicable finishes are listed on page 102 and 103. | |
| | Odd numbered hinged door is always on left side, left hinged. | |

Reff Overhead storage
*overdesk units, standard height planning model
 use with 1³/₄" worksurfaces and 26¹/₂"h support*

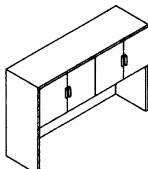
| description | d | w | h | doors | pattern no. | lam. | V1 | V2 | V3 |
|---|-----|-----|----------------------------------|-------|--|----------|----------|----------|----------|
| For 1 ³ / ₄ " worksurfaces | 20" | 30" | 43 ³ / ₄ " | 2 | QROBH30T1 () () () () () () | \$2,441. | \$3,042. | \$3,498. | \$4,723. |
| Hinged doors, 20" deep  | 20" | 36" | 43 ³ / ₄ " | 2 | QROBH36T1 () () () () () () | 2,587. | 3,227. | 3,711. | 5,010. |
| | 20" | 42" | 43 ³ / ₄ " | 3 | QROBH42T1 () () () () () () | 2,732. | 3,413. | 3,925. | 5,299. |
| | 20" | 48" | 43 ³ / ₄ " | 3 | QROBH48T1 () () () () () () | 2,877. | 3,598. | 4,138. | 5,586. |
| | 20" | 54" | 43 ³ / ₄ " | 3 | QROBH54T1 () () () () () () | 3,022. | 3,783. | 4,350. | 5,873. |
| | 20" | 66" | 43 ³ / ₄ " | 4 | QROBH66T1 () () () () () () | 3,820. | 4,783. | 5,500. | 7,426. |
| | 20" | 78" | 43 ³ / ₄ " | 4 | QROBH78T1 () () () () () () | 4,110. | 5,153. | 5,926. | 8,000. |
| | 20" | 84" | 43 ³ / ₄ " | 4 | QROBH84T1 () () () () () () | 4,254. | 5,338. | 6,139. | 8,287. |

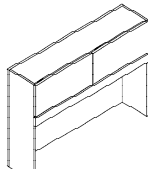
| | | | | | | | | | |
|---|-----|-----|----------------------------------|---|----------------------------------|--------|--------|--------|--------|
| For 1 ³ / ₄ " worksurfaces | 20" | 30" | 43 ³ / ₄ " | 1 | QROBF30S1 () () () () | 1,630. | 2,217. | 2,550. | 3,442. |
| Flip doors, 20" deep  | 20" | 36" | 43 ³ / ₄ " | 1 | QROBF36S1 () () () () | 1,869. | 2,543. | 2,924. | 3,948. |
| | 20" | 42" | 43 ³ / ₄ " | 1 | QROBF42S1 () () () () | 2,109. | 2,869. | 3,299. | 4,454. |
| | 20" | 48" | 43 ³ / ₄ " | 1 | QROBF48S1 () () () () | 2,348. | 3,194. | 3,673. | 4,959. |
| | 20" | 54" | 43 ³ / ₄ " | 2 | QROBF54S1 () () () () | 2,588. | 3,520. | 4,048. | 5,465. |
| | 20" | 66" | 43 ³ / ₄ " | 2 | QROBF66S1 () () () () | 3,066. | 4,453. | 5,121. | 6,913. |
| | 20" | 78" | 43 ³ / ₄ " | 2 | QROBF78S1 () () () () | 3,978. | 5,088. | 5,851. | 7,899. |
| | 20" | 90" | 43 ³ / ₄ " | 2 | QROBF90S1 () () () () | 4,079. | 5,231. | 6,016. | 8,121. |

| Order Code | Specification Information | Application Notes |
|---|---|--|
| Example: QROBF30S0LJLBF118() | To order please specify pattern number including: | Shipped knocked-down. |
| QR Reff Standard Special | 1. Configuration option | Open cabinets require no locks. |
| O Overhead | O = Open | Tasklights not included. |
| B For 1 ³ / ₄ " top mounting | H = Hinged door | Tackboard included, fabric railroded. |
| F Flip door | F = Flip door | C, D and S pulls are not available for flip door units. |
| 30 30" wide | 2. Width | All flip door cabinets on this page are nominal 19"H not 23"H. |
| S Standard height | 3. Storage option | Open/hinge doors are nominal 23"H, actual 22 ³ / ₈ ". |
| 0 15" deep | S0 = 19"h x 15"d | Locks are not factory installed. |
| L Finish type, laminate | S1 = 19"h x 20"d | Include grommet (black only) in back panel for task light cord. If used in open plan areas specify "no grommet." |
| J J-pull | T0 = 23"h x 15"d | Wire manager is included and mounts adjacent to tackboard. Specify color. |
| L Locks included | T1 = 23"h x 20"d | |
| BF Cord escape, back feed | 4. Finish type | |
| 118 Finish, Bright White | L = Laminate | |
| (W250) Fabric | 1 = V1 | |
| | 2 = V2 | |
| | 3 = V3 | |
| | 5. Pull option for hinged door only | |
| | D = Metal D-pull (for hinged doors only) | |
| | J = Routed pull | |
| | C = Nickel C-pull (nickel finish only, for hinged doors only) | |
| | S = Stainless steel finish S-pull (stainless steel finish only, for hinged doors only) | |
| | 6. Lock option | |
| | L = Lockhole drilled | |
| | N = No lock drilling | |
| | 7. Cord escape option | |
| | 8. Finish | |
| | 9. Pull finish where applicable | |
| | 10. Fabric for tackboard | |
| | *After specifying product code, provide keying instructions. | |
| | Overdesk unit will achieve 72" nominal height when used with correct top. | |
| | The clearance under the overhead to the top of the worksurface is approximately 20 ³ / ₄ ". | |
| | Applicable finishes are listed on page 102 and 103. | |
| | Odd numbered hinged door is always on left side, left hinged. | |

Reff Overhead storage
overdesk units, desk height planning model
use with 1 1/4" worksurfaces and 28 3/8" h support

| description | d | w | h | doors | pattern no. | lam. | V1 | V2 | V3 |
|-------------------------|-----|-----|---------|-------|--------------------------------|----------|----------|----------|----------|
| For 1 1/4" worksurfaces | 14" | 30" | 45 1/2" | | QROAO30T0DH () () () | \$1,643. | \$2,054. | \$2,362. | \$3,189. |
| Open, 14" deep | 14" | 36" | 45 1/2" | | QROAO36T0DH () () () | 1,723. | 2,157. | 2,481. | 3,349. |
| | 14" | 42" | 45 1/2" | | QROAO42T0DH () () () | 1,802. | 2,260. | 2,599. | 3,509. |
| | 14" | 48" | 45 1/2" | | QROAO48T0DH () () () | 1,881. | 2,363. | 2,717. | 3,669. |
| | 14" | 54" | 45 1/2" | | QROAO54T0DH () () () | 1,960. | 2,466. | 2,836. | 3,828. |
| | 14" | 66" | 45 1/2" | | QROAO66T0DH () () () | 2,500. | 3,141. | 3,612. | 4,876. |
| | 14" | 78" | 45 1/2" | | QROAO78T0DH () () () | 2,659. | 3,347. | 3,849. | 5,196. |
| | 14" | 84" | 45 1/2" | | QROAO84T0DH () () () | 2,735. | 3,449. | 3,966. | 5,355. |

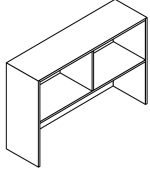

center divider on 42" and wider.

| Order Code | Specification Information | Application Notes |
|---|--|---|
| Example: QROAO30T0DHLBF118 () | <i>To order please specify pattern number including:</i> | <p>Products on this page are engineered to align with 75" h cabinets. Be sure storage dimension options and drilling options correspond accordingly. For storage options below the work surface, specify 28 3/8" h products. ; do not mix products from 26 1/2" h (standard height) planning model with 28 3/8" h (desk height) planning model in any one configuration.</p> <p>Overdesk unit will achieve 75" nominal height - actual height 75.125", when used with correct thickness of top.</p> <p>Clearance below overhead storage to top of work surface is approximately 23 1/8" h.</p> <p>Applicable finishes are listed on page 102 and 103.</p> <p>Odd numbered hinged door is always on left side, left hinged.</p> |
| QR Reff Standard Special | 1. <i>Configuration option (embedded in pattern number)</i> O = Open H = Hinged doors F = Flip doors | |
| O Overhead | 2. <i>Storage option (embedded in pattern number)</i> S0 = 19" h x 15" d S1 = 19" h x 20" d T0 = 23" h x 15" d T1 = 23" h x 20" d | |
| A For mounting on 1 1/4" thick top | 3. <i>Finish type</i> L = laminate | |
| O Open | 4. <i>Pull option</i> (Optional hinged door configurations only) D = metal D-pull (finish optional) J = routed J-pull (finish matches case) C = nickel finish C-pull (nickel finish only) S = S-pull (stainless steel finish only) | |
| 30 30" wide | 5. <i>Lock option</i> (Optional hinged door configurations only) L = drilled to accept lock N = no drilling | |
| T 23" h storage | 6. <i>Tasklight cord escape</i> BF = back feed FF = front feed | |
| 0 15" d storage | 7. <i>Finish</i> | |
| DH desk height, 75" height overall | 8. <i>Optional pull finish, where applicable</i> | |
| L Finish type, laminate | 9. <i>Fabric for tackboard</i> | |
| BF Cord escape, back feed | Product on this page excluding J-pull option will accept woodgrain laminate where laminate is currently an option. List price for woodgrain laminate options will be current published laminate list price plus 10%. | |
| 118 Finish, Bright White | Overdesk units do not come with lock included. Keying instructions must accompany all orders, refer to page 199. Random locks are factory installed. Key-alike are field installed using the KnollKey order form. | |
| () Fabric selection | Products on this page shipped knocked-down. Tasklights not included. Tackboard included, fabric orientation applied railroaded. Wire manager included and mounts adjacent to tackboard. Specify color. Include grommet (black only) in back panel for tasklight cord. If used in open plan areas, specify "no grommet" | |

dimensions noted nominal

Reff Overhead storage
overdesk units, desk height planning model
use with 1 1/4" worksurfaces and 28 3/8" h support

| description | d | w | h | doors | pattern no. | lam. | V1 | V2 | V3 |
|-------------------------|-----|-----|---------|-------|--|----------|----------|----------|----------|
| For 1 1/4" worksurfaces | 15" | 30" | 45 1/2" | 2 | QROAH30T0DH () () () () () | \$2,404. | \$3,011. | \$3,463. | \$4,675. |
| Hinged doors, 15" deep | 15" | 36" | 45 1/2" | 2 | QROAH36T0DH () () () () () | 2,544. | 3,188. | 3,666. | 4,949. |
| | 15" | 42" | 45 1/2" | 3 | QROAH42T0DH () () () () () | 2,683. | 3,365. | 3,870. | 5,224. |
| | 15" | 48" | 45 1/2" | 3 | QROAH48T0DH () () () () () | 2,824. | 3,542. | 4,073. | 5,499. |
| | 15" | 54" | 45 1/2" | 3 | QROAH54T0DH () () () () () | 2,964. | 3,719. | 4,277. | 5,774. |
| | 15" | 66" | 45 1/2" | 4 | QROAH66T0DH () () () () () | 3,756. | 4,704. | 5,410. | 7,303. |
| | 15" | 78" | 45 1/2" | 4 | QROAH78T0DH () () () () () | 4,036. | 5,059. | 5,818. | 7,854. |
| | 15" | 84" | 45 1/2" | 6 | QROAH84T0DH () () () () () | 4,176. | 5,236. | 6,021. | 8,129. |

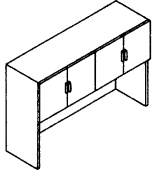

| Order Code | Specification Information | Application Notes |
|---|--|---|
| Example: QROAO30T0DHLBF118() | To order please specify pattern number including: | <p>Products on this page are engineered to align with 75" h cabinets. Be sure storage dimension options and drilling options correspond accordingly. For storage options below the worksurface, specify 28 3/8" h products. ; do not mix products from 26 1/2" h (standard height) planning model with 28 3/8" h (desk height) planning model in any one configuration.</p> <p>Overdesk unit will achieve 75" nominal height - actual height 75.125", when used with correct thickness of top.</p> <p>Clearance below overhead storage to top of worksurface is approximately 23 1/8" h.</p> <p>Applicable finishes are listed on page 102 and 103.</p> <p>Odd numbered hinged door is always on left side, left hinged.</p> |
| QR Reff Standard Special | 1. Configuration option (embedded in pattern number) O = Open H = Hinged doors F = Flip doors | |
| O Overhead | 2. Storage option (embedded in pattern number) S0 = 19" h x 15" d S1 = 19" h x 20" d T0 = 23" h x 15" d T1 = 23" h x 20" d | |
| A For mounting on 1 1/4" thick top | 3. Finish type L = laminate | |
| O Open | 4. Pull option (Optional hinged door configurations only) D = metal D-pull (finish optional) J = routed J-pull (finish matches case) C = nickel finish C-pull (nickel finish only) S = S-pull (stainless steel finish only) | |
| 30 30" wide | 5. Lock option (Optional hinged door configurations only) L = drilled to accept lock N = no drilling | |
| T 23" h storage | 6. Tasklight cord escape BF = back feed FF = front feed | |
| 0 15" d storage | 7. Finish | |
| DH desk height, 75" height overall | 8. Optional pull finish, where applicable | |
| L Finish type, laminate | 9. Fabric for tackboard | |
| BF Cord escape, back feed | Product on this page excluding J-pull option will accept woodgrain laminate where laminate is currently an option. List price for woodgrain laminate options will be current published laminate list price plus 10%. | |
| 118 Finish, Bright White | Overdesk units do not come with lock included. Keying instructions must accompany all orders, refer to page 199. Random locks are factory installed. Key-alike are field installed using the KnollKey order form. | |
| () Fabric selection | Products on this page shipped knocked-down. Tasklights not included. Tackboard included, fabric orientation applied railroaded. Wire manager included and mounts adjacent to tackboard. Specify color. Include grommet (black only) in back panel for tasklight cord. If used in open plan areas, specify "no grommet" | |

dimensions noted nominal

Reff Overhead storage
overdesk units, desk height planning model
use with 1 1/4" worksurfaces and 28 3/8" h support

| description | d | w | h | doors | pattern no. | lam. | V1 | V2 | V3 |
|-------------------------|-----|-----|---------|-------|----------------------------|----------|----------|----------|----------|
| For 1 1/4" worksurfaces | 15" | 30" | 45 1/2" | 1 | QROAF30S0DH() () () () | \$1,585. | \$2,162. | \$2,486. | \$3,357. |
| Flip doors, 15" deep | 15" | 36" | 45 1/2" | 1 | QROAF36S0DH() () () () | 1,823. | 2,485. | 2,858. | 3,858. |
| | 15" | 42" | 45 1/2" | 1 | QROAF42S0DH() () () () | 2,060. | 2,809. | 3,230. | 4,361. |
| | 15" | 48" | 45 1/2" | 1 | QROAF48S0DH() () () () | 2,299. | 3,132. | 3,602. | 4,862. |
| | 15" | 54" | 45 1/2" | 2 | QROAF54S0DH() () () () | 2,536. | 3,456. | 3,974. | 5,365. |
| | 15" | 66" | 45 1/2" | 2 | QROAF66S0DH() () () () | 3,013. | 4,380. | 5,037. | 6,800. |
| | 15" | 78" | 45 1/2" | 2 | QROAF78S0DH() () () () | 3,903. | 4,992. | 5,741. | 7,750. |
| | 15" | 90" | 45 1/2" | 2 | QROAF90S0DH() () () () | 3,997. | 5,127. | 5,896. | 7,960. |

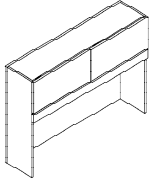

| Order Code | Specification Information | Application Notes |
|---|--|---|
| Example: QROAO30T0DHLBF118() | To order please specify pattern number including: | <p>Products on this page are engineered to align with 75" h cabinets. Be sure storage dimension options and drilling options correspond accordingly. For storage options below the work surface, specify 28 3/8" h products. ; do not mix products from 26 1/2" h (standard height) planning model with 28 3/8" h (desk height) planning model in any one configuration.</p> <p>Overdesk unit will achieve 75" nominal height - actual height 75.125", when used with correct thickness of top.</p> <p>Clearance below overhead storage to top of work surface is approximately 23 1/8" h.</p> <p>Applicable finishes are listed on page 102 and 103.</p> <p>Odd numbered hinged door is always on left side, left hinged.</p> |
| QR Reff Standard Special | 1. Configuration option (embedded in pattern number) O = Open H = Hinged doors F = Flip doors | |
| O Overhead | 2. Storage option (embedded in pattern number) S0 = 19" h x 15" d S1 = 19" h x 20" d T0 = 23" h x 15" d T1 = 23" h x 20" d | |
| A For mounting on 1 1/4" thick top | 3. Finish type L = laminate | |
| O Open | 4. Pull option (Optional hinged door configurations only) D = metal D-pull (finish optional) J = routed J-pull (finish matches case) C = nickel finish C-pull (nickel finish only) S = S-pull (stainless steel finish only) | |
| 30 30" wide | 5. Lock option (Optional hinged door configurations only) L = drilled to accept lock N = no drilling | |
| T 23" h storage | 6. Tasklight cord escape BF = back feed FF = front feed | |
| 0 15" d storage | 7. Finish | |
| DH desk height, 75" height overall | 8. Optional pull finish, where applicable | |
| L Finish type, laminate | 9. Fabric for tackboard | |
| BF Cord escape, back feed | Product on this page excluding J-pull option will accept woodgrain laminate where laminate is currently an option. List price for woodgrain laminate options will be current published laminate list price plus 10%. | |
| 118 Finish, Bright White | Overdesk units do not come with lock included. Keying instructions must accompany all orders, refer to page 199. Random locks are factory installed. Key-alike are field installed using the KnollKey order form. | |
| () Fabric selection | Products on this page shipped knocked-down. Tasklights not included. Tackboard included, fabric orientation applied railroaded. Wire manager included and mounts adjacent to tackboard. Specify color. Include grommet (black only) in back panel for tasklight cord. If used in open plan areas, specify "no grommet" | |

dimensions noted nominal

Reff Overhead storage
overdesk units, desk height planning model
use with 1 1/4" worksurfaces and 28 3/8" h support

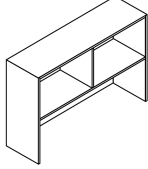
| description | d | w | h | doors | pattern no. | lam. | V1 | V2 | V3 |
|--|-----|-----|---------|-------|--------------------------------|----------|----------|----------|----------|
| For 1 1/4" worksurfaces Open, 19" deep  | 19" | 30" | 45 1/2" | | QROAO30T1DH () () () | \$1,739. | \$2,165. | \$2,490. | \$3,361. |
| | 19" | 36" | 45 1/2" | | QROAO36T1DH () () () | 1,825. | 2,277. | 2,619. | 3,535. |
| | 19" | 42" | 45 1/2" | | QROAO42T1DH () () () | 1,910. | 2,390. | 2,749. | 3,710. |
| | 19" | 48" | 45 1/2" | | QROAO48T1DH () () () | 1,997. | 2,503. | 2,878. | 3,886. |
| | 19" | 54" | 45 1/2" | | QROAO54T1DH () () () | 2,082. | 2,616. | 3,008. | 4,061. |
| | 19" | 66" | 45 1/2" | | QROAO66T1DH () () () | 2,647. | 3,324. | 3,823. | 5,161. |
| | 19" | 78" | 45 1/2" | | QROAO78T1DH () () () | 2,732. | 3,550. | 4,082. | 5,511. |
| | 19" | 84" | 45 1/2" | | QROAO84T1DH () () () | 2,904. | 3,662. | 4,211. | 5,685. |

center divider on 42" and wider.

| Order Code | Specification Information | Application Notes |
|---|--|--|
| Example: QROAO30T0DHLBF118() | <i>To order please specify pattern number including:</i> | Products on this page are engineered to align with 75" h cabinets. Be sure storage dimension options and drilling options correspond accordingly. For storage options below the work surface, specify 28 3/8" h products. ; do not mix products from 26 1/2" h (standard height) planning model with 28 3/8" h (desk height) planning model in any one configuration. Overdesk unit will achieve 75" nominal height - actual height 75.125", when used with correct thickness of top. Clearance below overhead storage to top of work surface is approximately 23 1/8" h. Applicable finishes are listed on page 102 and 103. Odd numbered hinged door is always on left side, left hinged. |
| QR Reff Standard Special | 1. <i>Configuration option (embedded in pattern number)</i> O = Open H = Hinged doors F = Flip doors | |
| O Overhead | 2. <i>Storage option (embedded in pattern number)</i> S0 = 19" h x 15" d S1 = 19" h x 20" d T0 = 23" h x 15" d T1 = 23" h x 20" d | |
| A For mounting on 1 1/4" thick top | 3. <i>Finish type</i> L = laminate 1 = V1 2 = V2 3 = V3 | |
| O Open | 4. <i>Pull option</i> (Optional hinged door configurations only) D = metal D-pull (finish optional) J = routed J-pull (finish matches case) C = nickel finish C-pull (nickel finish only) S = S-pull (stainless steel finish only) | |
| 30 30" wide | 5. <i>Lock option</i> (Optional hinged door configurations only) L = drilled to accept lock N = no drilling | |
| T 23" h storage | 6. <i>Tasklight cord escape</i> BF = back feed FF = front feed | |
| 0 15" d storage | 7. <i>Finish</i> | |
| DH desk height, 75" height overall | 8. <i>Optional pull finish, where applicable</i> | |
| L Finish type, laminate | 9. <i>Fabric for tackboard</i> Product on this page excluding J-pull option will accept woodgrain laminate where laminate is currently an option. List price for woodgrain laminate options will be current published laminate list price plus 10%. Overdesk units do not come with lock included. Keying instructions must accompany all orders, refer to page 199. Random locks are factory installed. Key-alike are field installed using the KnollKey order form. Products on this page shipped knocked-down. Tasklights not included. Tackboard included, fabric orientation applied railroaded. Wire manager included and mounts adjacent to tackboard. Specify color. Include grommet (black only) in back panel for tasklight cord. If used in open plan areas, specify "no grommet" | |
| BF Cord escape, back feed | | |
| 118 Finish, Bright White | | |
| () Fabric selection | | |

dimensions noted nominal

Reff Overhead storage
overdesk units, desk height planning model
use with 1 1/4" worksurfaces and 28 3/8" h support

| description | d | w | h | doors | pattern no. | lam. | V1 | V2 | V3 |
|-------------------------|-----|-----|---------|-------|--|----------|----------|----------|----------|
| For 1 1/4" worksurfaces | 20" | 30" | 45 1/2" | 2 | QROAH30T1DH () () () () () () | \$2,531. | \$3,171. | \$3,647. | \$4,923. |
| Hinged doors, 20" deep | 20" | 36" | 45 1/2" | 2 | QROAH36T1DH () () () () () () | 2,682. | 3,361. | 3,865. | 5,218. |
| | 20" | 42" | 45 1/2" | 3 | QROAH42T1DH () () () () () () | 2,833. | 3,552. | 4,085. | 5,514. |
| | 20" | 48" | 45 1/2" | 3 | QROAH48T1DH () () () () () () | 2,984. | 3,743. | 4,304. | 5,811. |
| | 20" | 54" | 45 1/2" | 3 | QROAH54T1DH () () () () () () | 3,136. | 3,934. | 4,524. | 6,108. |
| | 20" | 66" | 45 1/2" | 4 | QROAH66T1DH () () () () () () | 3,965. | 4,966. | 5,711. | 7,710. |
| | 20" | 78" | 45 1/2" | 4 | QROAH78T1DH () () () () () () | 4,116. | 5,349. | 6,151. | 8,304. |
| | 20" | 84" | 45 1/2" | 6 | QROAH84T1DH () () () () () () | 4,417. | 5,540. | 6,371. | 8,601. |

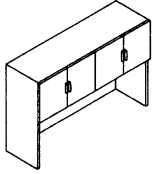

| Order Code | Specification Information | Application Notes |
|---|--|---|
| Example: QROAO30T0DHLBF118() | To order please specify pattern number including: | <p>Products on this page are engineered to align with 75" h cabinets. Be sure storage dimension options and drilling options correspond accordingly. For storage options below the work surface, specify 28 3/8" h products. ; do not mix products from 26 1/2" h (standard height) planning model with 28 3/8" h (desk height) planning model in any one configuration.</p> <p>Overdesk unit will achieve 75" nominal height - actual height 75.125", when used with correct thickness of top.</p> <p>Clearance below overhead storage to top of work surface is approximately 23 1/8" h.</p> <p>Applicable finishes are listed on page 102 and 103.</p> <p>Odd numbered hinged door is always on left side, left hinged.</p> |
| QR Reff Standard Special | 1. Configuration option (embedded in pattern number) O = Open H = Hinged doors F = Flip doors | |
| O Overhead | 2. Storage option (embedded in pattern number) S0 = 19" h x 15" d S1 = 19" h x 20" d T0 = 23" h x 15" d T1 = 23" h x 20" d | |
| A For mounting on 1 1/4" thick top | 3. Finish type L = laminate | |
| O Open | 4. Pull option (Optional hinged door configurations only) D = metal D-pull (finish optional) J = routed J-pull (finish matches case) C = nickel finish C-pull (nickel finish only) S = S-pull (stainless steel finish only) | |
| 30 30" wide | 5. Lock option (Optional hinged door configurations only) L = drilled to accept lock N = no drilling | |
| T 23" h storage | 6. Tasklight cord escape BF = back feed FF = front feed | |
| 0 15" d storage | 7. Finish | |
| DH desk height, 75" height overall | 8. Optional pull finish, where applicable | |
| L Finish type, laminate | 9. Fabric for tackboard | |
| BF Cord escape, back feed | Product on this page excluding J-pull option will accept woodgrain laminate where laminate is currently an option. List price for woodgrain laminate options will be current published laminate list price plus 10%. | |
| 118 Finish, Bright White | Overdesk units do not come with lock included. Keying instructions must accompany all orders, refer to page 199. Random locks are factory installed. Key-alike are field installed using the KnollKey order form. | |
| () Fabric selection | Products on this page shipped knocked-down. Tasklights not included. Tackboard included, fabric orientation applied railroaded. Wire manager included and mounts adjacent to tackboard. Specify color. Include grommet (black only) in back panel for tasklight cord. If used in open plan areas, specify "no grommet" | |

dimensions noted nominal

Reff Overhead storage
overdesk units, desk height planning model
use with 1 1/4" worksurfaces and 28 3/8" h support

| description | d | w | h | doors | pattern no. | lam. | V1 | V2 | V3 |
|-------------------------|-----|-----|---------|-------|------------------------------------|----------|----------|----------|----------|
| For 1 1/4" worksurfaces | 20" | 30" | 45 1/2" | 1 | QROAF30S1DH () () () () | \$1,689. | \$2,301. | \$2,646. | \$3,572. |
| Flip doors, 20" deep | 20" | 36" | 45 1/2" | 1 | QROAF36S1DH () () () () | 1,938. | 2,640. | 3,036. | 4,099. |
| | 20" | 42" | 45 1/2" | 1 | QROAF42S1DH () () () () | 2,187. | 2,980. | 3,427. | 4,626. |
| | 20" | 48" | 45 1/2" | 1 | QROAF48S1DH () () () () | 2,436. | 3,319. | 3,817. | 5,153. |
| | 20" | 54" | 45 1/2" | 2 | QROAF54S1DH () () () () | 2,685. | 3,659. | 4,208. | 5,681. |
| | 20" | 66" | 45 1/2" | 2 | QROAF66S1DH () () () () | 3,181. | 4,624. | 5,318. | 7,179. |
| | 20" | 78" | 45 1/2" | 2 | QROAF78S1DH () () () () | 4,126. | 5,279. | 6,071. | 8,196. |
| | 20" | 90" | 45 1/2" | 2 | QROAF90S1DH () () () () | 4,233. | 5,431. | 6,246. | 8,432. |

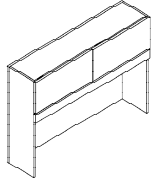

| Order Code | Specification Information | Application Notes |
|---|---|---|
| Example: QROAO30T0DHLBF118() | To order please specify pattern number including: | |
| QR Reff Standard Special | 1. Configuration option (embedded in pattern number) O = Open H = Hinged doors F = Flip doors | 6. Tasklight cord escape BF = back feed FF = front feed |
| O Overhead | 2. Storage option (embedded in pattern number) S0 = 19"h x 15"d S1 = 19"h x 20"d T0 = 23"h x 15"d T1 = 23"h x 20"d | 7. Finish |
| A For mounting on 1 1/4" thick top | 3. Finish type L = laminate | 8. Optional pull finish, where applicable |
| O Open | 4. Pull option (Optional hinged door configurations only) D = metal D-pull (finish optional) J = routed J-pull (finish matches case) C = nickel finish C-pull (nickel finish only) S = S-pull (stainless steel finish only) | 9. Fabric for tackboard |
| 30 30" wide | 5. Lock option (Optional hinged door configurations only) L = drilled to accept lock N = no drilling | Product on this page excluding J-pull option will accept woodgrain laminate where laminate is currently an option. List price for woodgrain laminate options will be current published laminate list price plus 10%. |
| T 23"h storage | | Overdesk units do not come with lock included. Keying instructions must accompany all orders, refer to page 199. Random locks are factory installed. Key-alike are field installed using the KnollKey order form. |
| 0 15"d storage | | Products on this page shipped knocked-down. |
| DH desk height, 75" height overall | | Tasklights not included. |
| L Finish type, laminate | | Tackboard included, fabric orientation applied railroaded. |
| BF Cord escape, back feed | | Wire manager included and mounts adjacent to tackboard. Specify color. |
| 118 Finish, Bright White | | Include grommet (black only) in back panel for tasklight cord. If used in open plan areas, specify "no grommet" |
| () Fabric selection | | |

dimensions noted nominal

Products on this page are engineered to align with 75" h cabinets. Be sure storage dimension options and drilling options correspond accordingly. For storage options below the worksurface, specify 28 3/8" h products. ; **do not mix products from 26 1/2" h (standard height) planning model with 28 3/8" h (desk height) planning model in any one configuration.**

Overdesk unit will achieve 75" nominal height - actual height 75.125", when used with correct thickness of top.

Clearance below overhead storage to top of worksurface is approximately 23 1/8" h.

Applicable finishes are listed on page 102 and 103.

Odd numbered hinged door is always on left side, left hinged.

Reff Overhead storage
overdesk units, desk height planning model
use with 1³/₄" worksurfaces and 28³/₈"h support

| description | d | w | h | doors | pattern no. | L | V1 | V2 | V3 |
|--|-----|-----|-----|-------|-------------------------|----------|----------|----------|----------|
| For 1 ³ / ₄ " worksurfaces | 14" | 30" | 45" | | QROBO30T0DH () () () | \$1,501. | \$1,899. | \$2,184. | \$2,948. |
| Open, 14" deep | 14" | 36" | 45" | | QROBO36T0DH () () () | 1,620. | 2,049. | 2,356. | 3,181. |
| | 14" | 42" | 45" | | QROBO42T0DH () () () | 1,741. | 2,199. | 2,529. | 3,414. |
| | 14" | 48" | 45" | | QROBO48T0DH () () () | 1,861. | 2,349. | 2,701. | 3,647. |
| | 14" | 54" | 45" | | QROBO54T0DH () () () | 1,981. | 2,499. | 2,874. | 3,880. |
| | 14" | 66" | 45" | | QROBO66T0DH () () () | 2,511. | 3,178. | 3,655. | 4,934. |
| | 14" | 78" | 45" | | QROBO78T0DH () () () | 2,752. | 3,478. | 4,000. | 5,400. |
| | 14" | 84" | 45" | | QROBO84T0DH () () () | 2,872. | 3,628. | 4,172. | 5,632. |

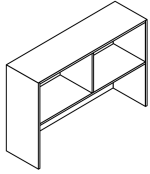

center divider on 42" and wider.

| Order Code | Specification Information | Application Notes |
|--|---|--|
| Example: QROBO30T0DHLBF118() | <i>To order please specify pattern number including:</i> | |
| QR Reff Standard Special | | |
| O Overhead | 1. <i>Configuration option (embedded in pattern number)</i> O = Open H = Hinged doors F = Flip doors | 6. <i>Tasklight cord escape</i> BF = back feed FF = front feed |
| B For mounting on 1 ³ / ₄ " thick top | 2. <i>Storage option (embedded in pattern number)</i> S0 = 19"h x 15"d S1 = 19"h x 20"d T0 = 23"h x 15"d T1 = 23"h x 20"d | 7. <i>Finish</i> |
| O Open | 3. <i>Finish type</i> L = laminate 1 = V1 2 = V2 3 = V3 | 8. <i>Optional pull finish, where applicable</i> |
| 30 30" wide | 4. <i>Pull option</i> (Optional hinged door configurations only) D = metal D-pull (finish optional) J = routed J-pull (finish matches case) C = nickel finish C-pull (nickel finish only) S = S-pull (stainless steel finish only) | 9. <i>Fabric for tackboard</i> |
| T 23"h storage | | Overdesk units do not come with lock included. Keying instructions must accompany all orders, refer to page 199. Random locks are factory installed. Key-alike are field installed using the KnollKey order form. |
| 0 15"d storage | | Products on this page shipped knocked-down. |
| DH desk height, 75" height overall | | Tasklights not included. |
| L Finish type, laminate | | Tackboard included, fabric orientation applied railroaded. |
| BF Cord escape, back feed | | Wire manager included and mounts adjacent to tackboard. Specify color. |
| 118 Finish, Bright White | | Include grommet (black only) in back panel for tasklight cord. If used in open plan areas, specify "no grommet" |
| () Fabric selection | 5. <i>Lock option</i> (Optional hinged door configurations only) L = drilled to accept lock N = no drilling | Products on this page are engineered to align with 75"h cabinets. Be sure storage dimension options and drilling options correspond accordingly. For storage options below the worksurface, specify 28 ³ / ₈ "h products; do not mix products from 26¹/₂"h (standard height) planning model with 28³/₈"h (desk height) planning model in any one configuration. |

dimensions noted nominal

Overdesk unit will achieve 75" nominal height - actual height 75.125", when used with correct thickness of top.

Clearance below overhead storage to top of worksurface is approximately 22⁵/₈"h.

Applicable finishes are listed on page 102 and 103.

Odd numbered hinged door is always on left side, left hinged.

Reff Overhead storage
overdesk units, desk height planning model
use with 1³/₄" worksurfaces and 28³/₈"h support

| description | d | w | h | doors | pattern no. | L | V1 | V2 | V3 |
|--|-----|-----|-----|-------|---------------------------------|----------|----------|----------|----------|
| For 1 ³ / ₄ " worksurfaces | 15" | 30" | 45" | 2 | QROBH30T0DH () () () () () | \$2,432. | \$3,041. | \$3,497. | \$4,721. |
| Hinged doors, 15" deep | 15" | 36" | 45" | 2 | QROBH36T0DH () () () () () | 2,574. | 3,220. | 3,703. | 4,999. |
| | 15" | 42" | 45" | 3 | QROBH42T0DH () () () () () | 2,715. | 3,400. | 3,910. | 5,279. |
| | 15" | 48" | 45" | 3 | QROBH48T0DH () () () () () | 2,856. | 3,579. | 4,116. | 5,556. |
| | 15" | 54" | 45" | 3 | QROBH54T0DH () () () () () | 2,997. | 3,759. | 4,323. | 5,836. |
| | 15" | 66" | 45" | 4 | QROBH66T0DH () () () () () | 3,798. | 4,757. | 5,471. | 7,385. |
| | 15" | 78" | 45" | 4 | QROBH78T0DH () () () () () | 4,082. | 5,117. | 5,885. | 7,944. |
| | 15" | 84" | 45" | 4 | QROBH84T0DH () () () () () | 4,221. | 5,297. | 6,092. | 8,224. |

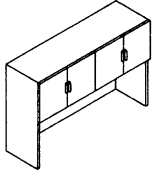

| Order Code | Specification Information | Application Notes |
|--|---|---|
| Example: QROBO30T0DHLBF118() | <i>To order please specify pattern number including:</i> | |
| QR Reff Standard Special | 1. <i>Configuration option (embedded in pattern number)</i> | 6. <i>Tasklight cord escape</i> |
| O Overhead | O = Open | BF = back feed |
| B For mounting on 1 ³ / ₄ " thick top | H = Hinged doors | FF = front feed |
| O Open | F = Flip doors | 7. <i>Finish</i> |
| 30 30" wide | 2. <i>Storage option (embedded in pattern number)</i> | 8. <i>Optional pull finish, where applicable</i> |
| T 23"h storage | S0 = 19"h x 15"d | 9. <i>Fabric for tackboard</i> |
| 0 15"d storage | S1 = 19"h x 20"d | |
| DH desk height, 75" height overall | T0 = 23"h x 15"d | Overdesk units do not come with lock included. Keying instructions must accompany all orders, refer to page 199. Random locks are factory installed. Key-alike are field installed using the KnollKey order form. |
| L Finish type, laminate | T1 = 23"h x 20"d | Products on this page shipped knocked-down. |
| BF Cord escape, back feed | 3. <i>Finish type</i> | Tasklights not included. |
| 118 Finish, Bright White | L = laminate | Tackboard included, fabric orientation applied railroaded. |
| () Fabric selection | 1 = V1 | Wire manager included and mounts adjacent to tackboard. Specify color. |
| | 2 = V2 | Include grommet (black only) in back panel for tasklight cord. If used in open plan areas, specify "no grommet" |
| | 3 = V3 | |
| | 4. <i>Pull option</i> | |
| | (Optional hinged door configurations only) | |
| | D = metal D-pull (finish optional) | |
| | J = routed J-pull (finish matches case) | |
| | C = nickel finish C-pull (nickel finish only) | |
| | S = S-pull (stainless steel finish only) | |
| | 5. <i>Lock option</i> | |
| | (Optional hinged door configurations only) | |
| | L = drilled to accept lock | |
| | N = no drilling | |

dimensions noted nominal

Reff Overhead storage
overdesk units, desk height planning model
use with 1³/₄" worksurfaces and 28³/₈"h support

| description | d | w | h | doors | pattern no. | L | V1 | V2 | V3 |
|--|-----|-----|-----|-------|------------------------------------|----------|----------|----------|----------|
| For 1 ³ / ₄ " worksurfaces | 15" | 30" | 45" | 1 | QROBF30S0DH () () () () | \$1,599. | \$2,183. | \$2,510. | \$3,389. |
| Flip doors, 15" deep | 15" | 36" | 45" | 1 | QROBF36S0DH () () () () | 1,840. | 2,511. | 2,888. | 3,898. |
| | 15" | 42" | 45" | 1 | QROBF42S0DH () () () () | 2,082. | 2,840. | 3,266. | 4,409. |
| | 15" | 48" | 45" | 1 | QROBF48S0DH () () () () | 2,323. | 3,168. | 3,643. | 4,918. |
| | 15" | 54" | 45" | 2 | QROBF54S0DH () () () () | 2,565. | 3,496. | 4,020. | 5,428. |
| | 15" | 66" | 45" | 2 | QROBF66S0DH () () () () | 3,047. | 4,429. | 5,093. | 6,876. |
| | 15" | 78" | 45" | 2 | QROBF78S0DH () () () () | 3,947. | 5,044. | 5,801. | 7,831. |
| | 15" | 90" | 45" | 2 | QROBF90S0DH () () () () | 4,044. | 5,190. | 5,969. | 8,057. |

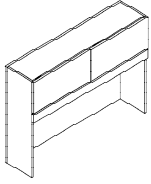

| Order Code | Specification Information | Application Notes |
|--|---|---|
| Example: QROBO30T0DHLBF118 () | <i>To order please specify pattern number including:</i> | |
| QR Reff Standard Special | 1. <i>Configuration option (embedded in pattern number)</i> | 6. <i>Tasklight cord escape</i> BF = back feed FF = front feed |
| O Overhead | O = Open | 7. <i>Finish</i> |
| B For mounting on 1 ³ / ₄ " thick top | H = Hinged doors | 8. <i>Optional pull finish, where applicable</i> |
| O Open | F = Flip doors | 9. <i>Fabric for tackboard</i> |
| 30 30" wide | 2. <i>Storage option (embedded in pattern number)</i> | Overdesk units do not come with lock included. Keying instructions must accompany all orders, refer to page 199. Random locks are factory installed. Key-alike are field installed using the KnollKey order form. |
| T 23"h storage | S0 = 19"h x 15"d | Products on this page shipped knocked-down. |
| 0 15"d storage | S1 = 19"h x 20"d | Tasklights not included. |
| DH desk height, 75" height overall | T0 = 23"h x 15"d | Tackboard included, fabric orientation applied railroaded. |
| L Finish type, laminate | T1 = 23"h x 20"d | Wire manager included and mounts adjacent to tackboard. Specify color. |
| BF Cord escape, back feed | 3. <i>Finish type</i> | Include grommet (black only) in back panel for tasklight cord. If used in open plan areas, specify "no grommet" |
| 118 Finish, Bright White | L = laminate | |
| () Fabric selection | 1 = V1 | |
| | 2 = V2 | |
| | 3 = V3 | |
| | 4. <i>Pull option</i> (Optional hinged door configurations only) | |
| | D = metal D-pull (finish optional) | |
| | J = routed J-pull (finish matches case) | |
| | C = nickel finish C-pull (nickel finish only) | |
| | S = S-pull (stainless steel finish only) | |
| | 5. <i>Lock option</i> (Optional hinged door configurations only) | |
| | L = drilled to accept lock | |
| | N = no drilling | |

dimensions noted nominal

Products on this page are engineered to align with 75"h cabinets. Be sure storage dimension options and drilling options correspond accordingly. For storage options below the worksurface, specify 28³/₈"h products; **do not mix products from 26¹/₂"h (standard height) planning model with 28³/₈"h (desk height) planning model in any one configuration.**

Overdesk unit will achieve 75" nominal height - actual height 75.125", when used with correct thickness of top.

Clearance below overhead storage to top of worksurface is approximately 22⁵/₈"h.

Applicable finishes are listed on page 102 and 103.

Odd numbered hinged door is always on left side, left hinged.

Reff Overhead storage
overdesk units, desk height planning model
use with 1³/₄" worksurfaces and 28³/₈"h support

| description | d | w | h | doors | pattern no. | L | V1 | V2 | V3 |
|--|-----|-----|-----|-------|-------------------------|----------|----------|----------|----------|
| For 1 ³ / ₄ " worksurfaces Open, 19" deep | 19" | 30" | 45" | | QROBO30T1DH () () () | \$1,840. | \$2,292. | \$2,636. | \$3,558. |
| | 19" | 36" | 45" | | QROBO36T1DH () () () | 1,906. | 2,381. | 2,738. | 3,697. |
| | 19" | 42" | 45" | | QROBO42T1DH () () () | 1,972. | 2,471. | 2,842. | 3,836. |
| | 19" | 48" | 45" | | QROBO48T1DH () () () | 2,037. | 2,560. | 2,944. | 3,974. |
| | 19" | 54" | 45" | | QROBO54T1DH () () () | 2,103. | 2,649. | 3,046. | 4,113. |
| | 19" | 66" | 45" | | QROBO66T1DH () () () | 2,677. | 3,363. | 3,867. | 5,221. |
| | 19" | 78" | 45" | | QROBO78T1DH () () () | 2,810. | 3,542. | 4,073. | 5,499. |
| | 19" | 84" | 45" | | QROBO84T1DH () () () | 2,876. | 3,632. | 4,177. | 5,639. |

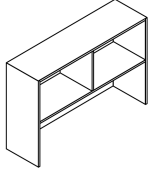

center divider on 42" and wider.

| Order Code | Specification Information | Application Notes |
|--|---|---|
| Example: QROBO30T0DHLBF118() | To order please specify pattern number including: | <p>Products on this page are engineered to align with 75" h cabinets. Be sure storage dimension options and drilling options correspond accordingly. For storage options below the worksurface, specify 28³/₈" h products; do not mix products from 26¹/₂" h (standard height) planning model with 28³/₈" h (desk height) planning model in any one configuration.</p> <p>Overdesk unit will achieve 75" nominal height - actual height 75.125", when used with correct thickness of top.</p> <p>Clearance below overhead storage to top of worksurface is approximately 22⁵/₈" h.</p> <p>Applicable finishes are listed on page 102 and 103.</p> <p>Odd numbered hinged door is always on left side, left hinged.</p> |
| QR Reff Standard Special | | |
| O Overhead | | |
| B For mounting on 1 ³ / ₄ " thick top | | |
| O Open | | |
| 30 30" wide | | |
| T 23" h storage | | |
| 0 15" d storage | | |
| DH desk height, 75" height overall | | |
| L Finish type, laminate | | |
| BF Cord escape, back feed | | |
| 118 Finish, Bright White | | |
| () Fabric selection | | |
| | <p>1. Configuration option (embedded in pattern number) O = Open H = Hinged doors F = Flip doors</p> <p>2. Storage option (embedded in pattern number) S0 = 19" h x 15" d S1 = 19" h x 20" d T0 = 23" h x 15" d T1 = 23" h x 20" d</p> <p>3. Finish type L = laminate 1 = V1 2 = V2 3 = V3</p> <p>4. Pull option (Optional hinged door configurations only) D = metal D-pull (finish optional) J = routed J-pull (finish matches case) C = nickel finish C-pull (nickel finish only) S = S-pull (stainless steel finish only)</p> <p>5. Lock option (Optional hinged door configurations only) L = drilled to accept lock N = no drilling</p> <p>6. Tasklight cord escape BF = back feed FF = front feed</p> <p>7. Finish</p> <p>8. Optional pull finish, where applicable</p> <p>9. Fabric for tackboard</p> <p>Overdesk units do not come with lock included. Keying instructions must accompany all orders, refer to page 199. Random locks are factory installed. Key-alike are field installed using the KnollKey order form.</p> <p>Products on this page shipped knocked-down.</p> <p>Tasklights not included.</p> <p>Tackboard included, fabric orientation applied railroaded.</p> <p>Wire manager included and mounts adjacent to tackboard. Specify color.</p> <p>Include grommet (black only) in back panel for tasklight cord. If used in open plan areas, specify "no grommet"</p> | |

dimensions noted nominal

Reff Overhead storage
overdesk units, desk height planning model
use with 1³/₄" worksurfaces and 28³/₈"h support

| description | d | w | h | doors | pattern no. | L | V1 | V2 | V3 |
|--|-----|-----|-----|-------|---------------------------------|----------|----------|----------|----------|
| For 1 ³ / ₄ " worksurfaces | 20" | 30" | 45" | 2 | QROBH30T1DH () () () () () | \$2,563. | \$3,194. | \$3,673. | \$4,959. |
| Hinged doors, 20" deep | 20" | 36" | 45" | 2 | QROBH36T1DH () () () () () | 2,716. | 3,389. | 3,897. | 5,261. |
| | 20" | 42" | 45" | 3 | QROBH42T1DH () () () () () | 2,869. | 3,583. | 4,120. | 5,563. |
| | 20" | 48" | 45" | 3 | QROBH48T1DH () () () () () | 3,021. | 3,778. | 4,345. | 5,865. |
| | 20" | 54" | 45" | 3 | QROBH54T1DH () () () () () | 3,173. | 3,972. | 4,568. | 6,167. |
| | 20" | 66" | 45" | 4 | QROBH66T1DH () () () () () | 4,011. | 5,022. | 5,775. | 7,797. |
| | 20" | 78" | 45" | 4 | QROBH78T1DH () () () () () | 4,315. | 5,411. | 6,223. | 8,401. |
| | 20" | 84" | 45" | 6 | QROBH84T1DH () () () () () | 4,466. | 5,605. | 6,446. | 8,702. |

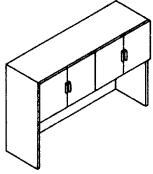

| Order Code | Specification Information | Application Notes |
|--|---|--|
| Example: QROBO30T0DHLBF118() | To order please specify pattern number including: | |
| QR Reff Standard Special | 1. Configuration option (embedded in pattern number) O = Open H = Hinged doors F = Flip doors | 6. Tasklight cord escape BF = back feed FF = front feed |
| O Overhead | 2. Storage option (embedded in pattern number) S0 = 19"h x 15"d S1 = 19"h x 20"d T0 = 23"h x 15"d T1 = 23"h x 20"d | 7. Finish |
| B For mounting on 1 ³ / ₄ " thick top | 3. Finish type L = laminate 1 = V1 2 = V2 3 = V3 | 8. Optional pull finish, where applicable |
| O Open | 4. Pull option (Optional hinged door configurations only) D = metal D-pull (finish optional) J = routed J-pull (finish matches case) C = nickel finish C-pull (nickel finish only) S = S-pull (stainless steel finish only) | 9. Fabric for tackboard |
| 30 30" wide | 5. Lock option (Optional hinged door configurations only) L = drilled to accept lock N = no drilling | Overdesk units do not come with lock included. Keying instructions must accompany all orders, refer to page 199. Random locks are factory installed. Key-alike are field installed using the KnollKey order form. |
| T 23"h storage | | Products on this page shipped knocked-down. |
| 0 15"d storage | | Tasklights not included. |
| DH desk height, 75" height overall | | Tackboard included, fabric orientation applied railroaded. |
| L Finish type, laminate | | Wire manager included and mounts adjacent to tackboard. Specify color. |
| BF Cord escape, back feed | | Include grommet (black only) in back panel for tasklight cord. If used in open plan areas, specify "no grommet" |
| 118 Finish, Bright White | | Products on this page are engineered to align with 75"h cabinets. Be sure storage dimension options and drilling options correspond accordingly. For storage options below the worksurface, specify 28 ³ / ₈ "h products; do not mix products from 26¹/₂"h (standard height) planning model with 28³/₈"h (desk height) planning model in any one configuration. |
| () Fabric selection | | Overdesk unit will achieve 75" nominal height - actual height 75.125", when used with correct thickness of top. |
| | | Clearance below overhead storage to top of worksurface is approximately 22 ⁵ / ₈ "h. |
| | | Applicable finishes are listed on page 102 and 103. |
| | | Odd numbered hinged door is always on left side, left hinged. |

dimensions noted nominal

Reff Overhead storage
overdesk units, desk height planning model
use with 1³/₄" worksurfaces and 28³/₈"h support

| description | d | w | h | doors | pattern no. | L | V1 | V2 | V3 |
|--|-----|-----|-----|-------|------------------------------------|----------|----------|----------|----------|
| For 1 ³ / ₄ " worksurfaces | 20" | 30" | 45" | 1 | QROBF30S1DH () () () () | \$1,711. | \$2,328. | \$2,677. | \$3,614. |
| Flip doors, 20" deep | 20" | 36" | 45" | 1 | QROBF36S1DH () () () () | 1,962. | 2,670. | 3,070. | 4,145. |
| | 20" | 42" | 45" | 1 | QROBF42S1DH () () () () | 2,214. | 3,012. | 3,464. | 4,676. |
| | 20" | 48" | 45" | 1 | QROBF48S1DH () () () () | 2,466. | 3,354. | 3,857. | 5,207. |
| | 20" | 54" | 45" | 2 | QROBF54S1DH () () () () | 2,718. | 3,696. | 4,250. | 5,738. |
| | 20" | 66" | 45" | 2 | QROBF66S1DH () () () () | 3,219. | 4,676. | 5,377. | 7,259. |
| | 20" | 78" | 45" | 2 | QROBF78S1DH () () () () | 4,177. | 5,343. | 6,144. | 8,295. |
| | 20" | 90" | 45" | 2 | QROBF90S1DH () () () () | 4,283. | 5,492. | 6,316. | 8,526. |

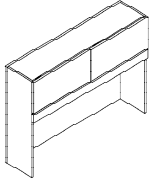

| Order Code | Specification Information | Application Notes |
|--|---|---|
| Example: QROBO30T0DHLBF118 () | <i>To order please specify pattern number including:</i> | |
| QR Reff Standard Special | 1. <i>Configuration option (embedded in pattern number)</i> | 6. <i>Tasklight cord escape</i> BF = back feed FF = front feed |
| O Overhead | O = Open | 7. <i>Finish</i> |
| B For mounting on 1 ³ / ₄ " thick top | H = Hinged doors | 8. <i>Optional pull finish, where applicable</i> |
| O Open | F = Flip doors | 9. <i>Fabric for tackboard</i> |
| 30 30" wide | 2. <i>Storage option (embedded in pattern number)</i> | Overdesk units do not come with lock included. Keying instructions must accompany all orders, refer to page 199. Random locks are factory installed. Key-alike are field installed using the KnollKey order form. |
| T 23"h storage | S0 = 19"h x 15"d | Products on this page shipped knocked-down. |
| 0 15"d storage | S1 = 19"h x 20"d | Tasklights not included. |
| DH desk height, 75" height overall | T0 = 23"h x 15"d | Tackboard included, fabric orientation applied railroaded. |
| L Finish type, laminate | T1 = 23"h x 20"d | Wire manager included and mounts adjacent to tackboard. Specify color. |
| BF Cord escape, back feed | 3. <i>Finish type</i> | Include grommet (black only) in back panel for tasklight cord. If used in open plan areas, specify "no grommet" |
| 118 Finish, Bright White | L = laminate | |
| () Fabric selection | 1 = V1 | |
| | 2 = V2 | |
| | 3 = V3 | |
| | 4. <i>Pull option</i> (Optional hinged door configurations only) | |
| | D = metal D-pull (finish optional) | |
| | J = routed J-pull (finish matches case) | |
| | C = nickel finish C-pull (nickel finish only) | |
| | S = S-pull (stainless steel finish only) | |
| | 5. <i>Lock option</i> (Optional hinged door configurations only) | |
| | L = drilled to accept lock | |
| | N = no drilling | |

dimensions noted nominal

Reff Overhead storage panel hung and wall hung cabinets

Standard Specials Systems

| description | h | w | d | locks req'd | doors | pattern no. | L | V1 | V2 | V3 |
|--|-----|-----|-----|-------------|-------|----------------------------------|----------|----------|----------|----------|
| Panel hung overhead cabinet (hinged door, no back) | 19" | 24" | 14" | 1 | 2 | QROPH24S0 () () () () | \$1,560. | \$1,610. | \$1,851. | \$2,500. |
| | | 42" | 14" | 2 | 3 | QROPH42S0 () () () () | 2,052. | 2,117. | 2,435. | 3,287. |
| | | 48" | 14" | 2 | 3 | QROPH48S0 () () () () | 2,185. | 2,255. | 2,593. | 3,501. |
| | | 54" | 14" | 2 | 3 | QROPH54S0 () () () () | 2,224. | 2,299. | 2,644. | 3,569. |
| | | 84" | 14" | 3 | 5 | QROPH84S0 () () () () | 3,001. | 3,100. | 3,565. | 4,813. |

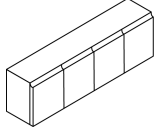

| description | h | w | d | locks req'd | doors | pattern no. | L | V1 | V2 | V3 |
|---|-----|-----|-----|-------------|-------|----------------------------------|--------|--------|--------|--------|
| Wall hung overhead cabinet (hinged door, with back) | 19" | 24" | 15" | 1 | 2 | QROMH24S0 () () () () | 2,850. | 2,944. | 3,386. | 4,571. |
| | | 42" | 15" | 2 | 3 | QROMH42S0 () () () () | 3,279. | 3,383. | 3,890. | 5,252. |
| | | 48" | 15" | 2 | 3 | QROMH48S0 () () () () | 3,390. | 3,499. | 4,024. | 5,432. |
| | | 54" | 15" | 2 | 3 | QROMH54S0 () () () () | 3,407. | 3,520. | 4,048. | 5,465. |
| | | 66" | 15" | 2 | 4 | QROMH66S0 () () () () | 3,605. | 3,725. | 4,284. | 5,783. |
| | | 78" | 15" | 2 | 4 | QROMH78S0 () () () () | 4,171. | 4,308. | 4,954. | 6,688. |
| | | 84" | 15" | 3 | 6 | QROMH84S0 () () () () | 4,643. | 4,797. | 5,517. | 7,447. |
| | | 90" | 15" | 3 | 6 | QROMH90S0 () () () () | 4,879. | 5,041. | 5,797. | 7,826. |
| | | 96" | 15" | 3 | 6 | QROMH96S0 () () () () | 5,115. | 5,285. | 6,078. | 8,205. |

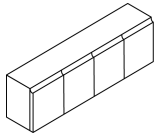

| Order Code | Specification Information | Application Notes |
|---------------------------------|---|--|
| Example: QROPH24S0DLL | <i>To order please specify pattern number including:</i> | |
| QR Reff Standard Special | 1. Configuration option (<i>embedded in pattern no.</i>) <i>H = Hinged door</i> <i>O = Open</i> <i>F = Flip door</i> | Panel-hung cabinets are shipped knocked-down. Wall-hung overhead cabinets are shipped assembled. |
| O Overhead | 2. Storage option (<i>embedded in pattern no.</i>) <i>S0 = 19"h x 14"d open/15"d hinged door</i> <i>T0 = 23"h x 14"d open/15"d hinged door</i> | Open cabinets require no locks. |
| P Panel hung | 3. Finish type | Tasklights are not included. |
| H Hinged door | 4. Pull option <i>applicable hinged doors only</i> | D-Pulls are not available for flip door units. |
| 24 24" wide | 5. Lock option | Hardware included for overhead cabinets. |
| S Standard height, 19"h | 6. Finish, case | The manufacturer does not take responsibility for the installation or the security of cabinets to the wall. |
| 0 15" deep | 7. Finish, pull when applicable | *Keying instructions must accompany all cabinet orders. |
| D D-pull | 8. Keying instructions | Panel-hung overheads come with no backs. |
| L Lock hole drilled | *After specifying product code, provide keying instructions. | Random keys are factory installed. |
| L Laminate finish | Dimensions are nominal. | Order overheads with a KnollKey order form. |
| | Product not available where prices do not appear. | |
| | 3. <i>Finish type options:</i> L = Laminate 1 = V1 techwood 2 = V2 conventional veneer 3 = V3 exotic veneer | |
| | 4. <i>Pull Options:</i> D = Metal D-pull for hinged door only J = Routed pull C = Nickel finish C-pull for hinged door only (nickel finish only) S = Stainless steel finish S-pull for hinged door only (stainless steel finish only) | |
| | 5. <i>Lock options:</i> L = Lock hole drilled N = No lockdrilling | |
| | 8. Refer to page 199 for keying instructions. | |
| | Product on this page excluding J-pull option will accept woodgrain laminate where laminate is currently an option. List price for woodgrain laminate options will be current published laminate list price plus 10%. | |
| | Applicable finishes are listed on page 102 and 103. | |
| | Sliding rails order separately on page from Reff price list. | |

Reff System

Reff Overhead storage

Standard Specials Systems

open hutch wood interior

| description | h | w | d | pattern no. | L | V1 | V2 | V3 |
|---|---------|-----|-----|--------------------------|----------|----------|----------|----------|
| Hutch for 1 1/4" top, 26 1/2" h component | 44 1/4" | 30" | 14" | QROAO30BW () () | \$1,831. | \$2,400. | \$2,760. | \$3,726. |
| | 44 1/4" | 36" | 14" | QROAO36BW () () | 2,015. | 2,643. | 3,039. | 4,103. |

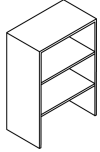

No baseboard
No bottom shelf
2 adjustable shelves

| | | | | | | | | |
|---|---------|-----|-----|----------------------------|--------|--------|--------|--------|
| Hutch for 1 1/4" top, 28 3/8" h component | 45 1/2" | 30" | 14" | QROAO30DHBW () () | 1,923. | 2,520. | 2,898. | 3,912. |
| | 45 1/2" | 36" | 14" | QROAO36DHBW () () | 2,116. | 2,775. | 3,191. | 4,308. |

No baseboard
No bottom shelf
2 adjustable shelves

| | | | | | | | | |
|---|---------|-----|-----|--------------------------|--------|--------|--------|--------|
| Hutch for 1 3/4" top, 26 1/2" h component | 43 3/4" | 30" | 14" | QROBO30BW () () | 1,831. | 2,400. | 2,760. | 3,726. |
| | 43 3/4" | 36" | 14" | QROBO36BW () () | 2,015. | 2,643. | 3,039. | 4,103. |

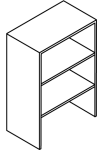

No baseboard
No bottom shelf
2 adjustable shelves

| | | | | | | | | |
|---|-----|-----|-----|----------------------------|--------|--------|--------|--------|
| Hutch for 1 3/4" top, 28 3/8" h component | 45" | 30" | 14" | QROBO30DHBW () () | 1,923. | 2,520. | 2,898. | 3,912. |
| | 45" | 36" | 14" | QROBO36DHBW () () | 2,116. | 2,775. | 3,191. | 4,308. |

No baseboard
No bottom shelf
2 adjustable shelves

| Order Code | Specification Information | Application Notes |
|------------------------------------|--|---|
| Example: QROAO30BW(2)(V316) | <i>To order please specify pattern number including:</i> | Product on this page will accept woodgrain laminate where laminate is currently an option. List price for woodgrain laminate options will be current published laminate list price plus 10%. |
| QR Reff Standard Special | | 14" deep gable aligns with the gable depth of standard 15" deep overdesk. |
| O Overhead storage | 1. <i>Interior Option</i> W = wood (shelves match case finish or wood drawer interiors) | |
| A for 1 1/4" top | 2. <i>Finish type</i> L = laminate 1 = V1 2 = V2 3 = V3 | Shelf adjustability is 2.5" up or down per shelf from equal drilled spacing. |
| O Open hutch | 3. <i>Cabinet finish</i> | |
| 30 30" w (nominal) | | |
| B Bookcase | | |
| W Interior option, wood | | |
| 2 Finish type, V2 | | |
| V316 Finish, light maple | | |

*open hutch
metal interior*

| description | h | w | d | pattern no. | L | V1 | V2 | V3 |
|---|---------|-----|-----|--------------------------|----------|----------|----------|----------|
| Hutch for 1 1/4" top, 26 1/2" h component | 44 1/4" | 30" | 14" | QROAO30BM () () | \$1,676. | \$2,194. | \$2,523. | \$3,406. |
| | 44 1/4" | 36" | 14" | QROAO36BM () () | 1,854. | 2,434. | 2,799. | 3,779. |

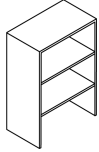

No baseboard
No bottom shelf
2 adjustable shelves

| | | | | | | | | |
|---|---------|-----|-----|----------------------------|--------|--------|--------|--------|
| Hutch for 1 1/4" top, 28 3/8" h component | 45 1/2" | 30" | 14" | QROAO30DHBM () () | 1,759. | 2,303. | 2,648. | 3,575. |
| | 45 1/2" | 36" | 14" | QROAO36DHBM () () | 1,947. | 2,556. | 2,939. | 3,968. |

No baseboard
No bottom shelf
2 adjustable shelves

| | | | | | | | | |
|---|---------|-----|-----|--------------------------|--------|--------|--------|--------|
| Hutch for 1 3/4" top, 26 1/2" h component | 43 3/4" | 30" | 14" | QROBO30BM () () | 1,676. | 2,194. | 2,523. | 3,406. |
| | 43 3/4" | 36" | 14" | QROBO36BM () () | 1,854. | 2,434. | 2,799. | 3,779. |

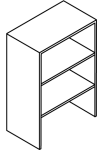

No baseboard
No bottom shelf
2 adjustable shelves

| | | | | | | | | |
|---|-----|-----|-----|----------------------------|--------|--------|--------|--------|
| Hutch for 1 3/4" top, 28 3/8" h component | 45" | 30" | 14" | QROBO30DHBM () () | 1,759. | 2,303. | 2,648. | 3,575. |
| | 45" | 36" | 14" | QROBO36DHBM () () | 1,947. | 2,556. | 2,939. | 3,968. |

No baseboard
No bottom shelf
2 adjustable shelves

| Order Code | Specification Information | Application Notes |
|------------------------------------|--|--|
| Example: QROAO30BM(2)(V316) | <i>To order please specify pattern number including:</i> | Product on this page will accept woodgrain laminate where laminate is currently an option. List price for woodgrain laminate options will be current published laminate list price plus 10%. |
| QR Reff Standard Special | 1. <i>Interior Option</i> M = metal shelves *If laminate case, finish of metal shelves to match; if case V1 or V2 finish, shelves are black) | |
| O Overhead storage | 2. <i>Finish type</i> L = laminate 1 = V1 2 = V2 3 = V3 | 14" deep gable aligns with the gable depth of standard 15" deep overdesk. Shelf adjustability is 2.5" up or down per shelf from equal drilled spacing. |
| A for 1 1/4" top | 3. <i>Cabinet finish</i> | |
| O Open hutch | | |
| 30 30" w (nominal) | | |
| B Bookcase | | |
| M Interior option, metal | | |
| 2 Finish type, V2 | | |
| V316 Finish, light maple | | |

Reff Overhead storage T5 Task Light for Reff Daisy Chain

| description | type | w | d | h | pattern no. | Standard | Advanced |
|---|---------------------------------|-----|----|--------|--------------------------|----------|----------|
| Task Light, starter 9 ft. cord, fused male plug 1 ft. cord, female plug | Use with 24" and wider overhead | 19" | 4" | 1 1/2" | RTL5E19()DCS()Q | \$389. | n/a |
| | Use with 30" and wider overhead | 25" | 4" | 1 1/2" | RTL5E25()DCS()Q | 395. | 507. |
| | Use with 42" and wider overhead | 37" | 4" | 1 1/2" | RTL5E37()DCS()Q | 400. | 527. |
| | Use with 60" and wider overhead | 49" | 4" | 1 1/2" | RTL5E49()DCS()Q | 405. | 542. |
| | Use with 72" and wider overhead | 61" | 4" | 1 1/2" | RTL5E61()DCS()Q | 420. | 558. |
| | Use with 84" and wider overhead | 73" | 4" | 1 1/2" | RTL5E73()DCS()Q | 445. | 573. |
| | Use with 96" and wider overhead | 85" | 4" | 1 1/2" | RTL5E85()DCS()Q | 522. | 589. |

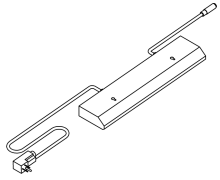

left hand shown

| | | | | | | | |
|---|---------------------------------|-----|----|--------|--------------------------|------|------|
| Task Light, adder 2 ft. cord, male plug 1 ft. cord, female plug | Use with 24" and wider overhead | 19" | 4" | 1 1/2" | RTL5E19()DCA()Q | 421. | n/a |
| | Use with 30" and wider overhead | 25" | 4" | 1 1/2" | RTL5E25()DCA()Q | 427. | 539. |
| | Use with 42" and wider overhead | 37" | 4" | 1 1/2" | RTL5E37()DCA()Q | 432. | 559. |
| | Use with 60" and wider overhead | 49" | 4" | 1 1/2" | RTL5E49()DCA()Q | 437. | 574. |
| | Use with 72" and wider overhead | 61" | 4" | 1 1/2" | RTL5E61()DCA()Q | 452. | 590. |
| | Use with 84" and wider overhead | 73" | 4" | 1 1/2" | RTL5E73()DCA()Q | 477. | 605. |
| | Use with 96" and wider overhead | 85" | 4" | 1 1/2" | RTL5E85()DCA()Q | 554. | 621. |

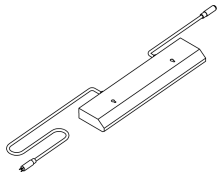

left hand shown

| | | | | | | | |
|--|---------------------------------|-----|----|--------|--------------------------|------|------|
| Task Light, ender 2 ft. cord, male plug | Use with 24" and wider overhead | 19" | 4" | 1 1/2" | RTL5E19()DCE()Q | 308. | n/a |
| | Use with 30" and wider overhead | 25" | 4" | 1 1/2" | RTL5E25()DCE()Q | 314. | 426. |
| | Use with 42" and wider overhead | 37" | 4" | 1 1/2" | RTL5E37()DCE()Q | 319. | 446. |
| | Use with 60" and wider overhead | 49" | 4" | 1 1/2" | RTL5E49()DCE()Q | 324. | 461. |
| | Use with 72" and wider overhead | 61" | 4" | 1 1/2" | RTL5E61()DCE()Q | 339. | 477. |
| | Use with 84" and wider overhead | 73" | 4" | 1 1/2" | RTL5E73()DCE()Q | 364. | 492. |
| | Use with 96" and wider overhead | 85" | 4" | 1 1/2" | RTL5E85()DCE()Q | 441. | 508. |

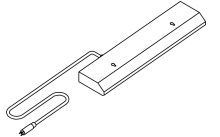

left hand shown

| Order Code | Specification Information | Application Notes |
|---|--|---|
| Example: RTL5E19SDCSLQ RTL Task Light T5 T5 lamp E Electronic ballast 19 Width S Standard DC Daisy chain S Starter L Left handed Q Special | Specify: Width - Task Lights mount in cabinets and shelves at least 5" wider than light width. 1. Type: (S) Standard (A) Advanced 2. Handedness L= Left handed (male plug on user's left side) R=Right handed (male plug on user's right side) All housings are black. | Task lights mount into the recess in the underside of overhead cabinets and shelves at least 5" wider than task light width. Task lights include T5 cool white (4100K) fluorescent lamp, electronic ballast, prismatic lens, rocker switch, one cord exit management clip and mounting hardware. Cord management clips must be ordered separately. Task lights are TCLP compliant and meet requirements of California Title 24. Advanced task lights are fitted with ballast and lamp compliant with LEED requirements. |

| description | w | h | pattern no. | list |
|-------------------------|-----|-----|----------------|--------|
| Panel hung tackboard | 24" | 24" | QRPHTB2424 () | \$315. |
| Note: Fabric railroaded | 36" | 24" | QRPHTB3624 () | 387. |
| | 48" | 24" | QRPHTB4824 () | 472. |
| | 54" | 24" | QRPHTB5424 () | 514. |
| | 60" | 24" | QRPHTB6024 () | 557. |
| | 72" | 24" | QRPHTB7224 () | 642. |

available in all standard grades of fabric

| | | | | |
|---|-----|-----|----------------|------|
| Wall hung tackboard | 24" | 24" | QRWHTB2424 () | 349. |
| Note: Fabric railroaded Velcro supplied | 54" | 24" | QRWHTB5424 () | 505. |
| | 60" | 24" | QRWHTB6024 () | 548. |
| | 72" | 24" | QRWHTB7224 () | 632. |

available in all standard grades of fabric

Order Code

Specification Information

Application Notes

To order please specify:

1. Pattern number
2. Fabric (Tackboards)

Finishes**L - Laminate**

Matching edge band unless noted otherwise

| | |
|-----|--|
| 117 | Soft Grey |
| 118 | Bright White |
| 114 | Folkstone Grey |
| 111 | Jet Black |
| 119 | Pumice |
| 121 | Micro Grey with 114 Folkstone grey edge band |
| 122 | Brushed Sand with 119 Pumice edge band |
| 123 | Brushed Grey with 128 Fog edge band |
| 128 | Fog |
| 129 | Micro Sand with 119 Pumice edge band |
| 124 | Medium Cherry |
| 125 | Natural Maple |
| 126 | Natural Cherry |
| 127 | Walnut |

V1 - Techwood Closed Pore

| | |
|------|---------------|
| Y316 | Maple |
| Y319 | Cherry |
| Y323 | Medium Walnut |
| Y326 | Dark Mahogany |
| Y327 | Light Oak |
| Y329 | Medium Oak |
| Y341 | Wenge |
| Y342 | Medium Teak |
| Y343 | Dark Grey Oak |
| Y344 | Espresso |
| Y851 | Black Oak |
| Y811 | Natural |
| Y821 | Blond Maple |
| Y831 | Light Cherry |

V2 – Natural veneer

| | |
|--------------------------------------|----------------------|
| V312 | Bronze Cherry |
| V316 | Maple |
| V411 | Light Walnut |
| V415 | Peacock Green Walnut |
| V417 | Old English Walnut |
| V418 | Smoked Walnut |
| V433 | Light Fawn Cherry |
| V436 | Medium Brown Cherry |
| <i>(all above V2's are flat cut)</i> | |
| V421 | Chalk Oak |
| V423 | Light Oak |
| V425 | Amber Oak |
| V427 | Brown Oak |
| Y439 | Straight Anigre |
| <i>(all V2 Oaks are rift cut)</i> | |

V3 – Exotic veneer

| | |
|----------------------------------|----------------------------|
| V512 | Figured Anigre |
| V514 | Makore |
| V515 | Figured Sycamore |
| V513 | Graphite Oak (rift cut) |
| V517 | Natural Sapele |
| <i>(all V3s are quarter cut)</i> | |

Paint

| | |
|-----------|----------------------|
| P1 | |
| 111 | Jet Black |
| 112 | Brown |
| 113 | Dark Grey |
| 114 | Folkstone Grey |
| 115 | Medium Grey |
| 116 | Sandstone |
| 117 | Soft Grey |
| P2 | |
| 611 | Beige Mist Metallic |
| 612 | Medium Metallic Grey |
| P3 | |
| 118 | Bright White |
| 613 | Silver |

Anodized

| | |
|----|-------------------|
| AA | Anodized Aluminum |
|----|-------------------|

Plated

| | |
|----|----------------|
| PT | Brushed Pewter |
|----|----------------|

Glass G1

| | |
|------|----------------|
| TEMP | Clear Tempered |
|------|----------------|

Architectural Glass G2

| | |
|------|--------------|
| GL6 | Block Matrix |
| GL13 | Powder |

Mixed Finishes: (where applicable for work surfaces only)

To order mixed finishes, enter four digit finish code as follows:

Use 2 digit prefix to indicate surface finish (laminate)

| | |
|----|----------------|
| 11 | Jet Black |
| 14 | Folkstone Grey |
| 17 | Soft Grey |
| 18 | Bright White |
| 19 | Pumice |
| 21 | Micro Grey |
| 22 | Brushed Sand |
| 23 | Brushed Grey |
| 28 | Fog |
| 29 | Micro Sand |

Use 2 digit suffix to indicate edge finish (wood)

| | |
|----|----------------|
| 12 | for V312 |
| 16 | for V316, Y316 |
| Y9 | for Y319 |
| Y3 | for Y323 |
| 26 | for Y326 |
| 27 | for Y327 |
| 29 | for Y329 |
| 43 | for V433 |
| 45 | for V415 |
| 46 | for V436 |
| 47 | for V417 |
| 48 | for V418 |
| 52 | for V512 |
| 53 | for V513 |
| 54 | for V514 |
| 55 | for V515 |
| 57 | for V517 |
| 61 | for V411 |
| 71 | for V421 |
| 73 | for V423 |
| 75 | for V425 |
| 77 | for V427 |

Example:

For a Micro Grey laminate surface with Bronzed Cherry edge, enter finish code 2112

For a Jet Black laminate surface with Light Maple edge, enter finish code 1116

Conference room top

1 1/4" Thick - No grommet, no drilling

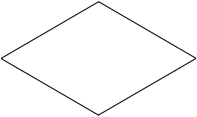
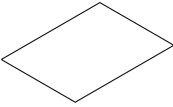
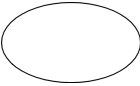
| description | w | d | dia. | pattern no. | L | M | V1 | V2 | V3 |
|--|-----|-----|------|---------------------------|--------|----------|----------|----------|----------|
| Square top - tapered 4 sides  | 30" | 30" | | QAW1T43030 () () | \$752. | \$1,030. | \$1,030. | \$1,185. | \$1,599. |
| | 36" | 36" | | QAW1T43636 () () | 827. | 1,133. | 1,133. | 1,303. | 1,759. |
| | 42" | 42" | | QAW1T44242 () () | 952. | 1,304. | 1,304. | 1,500. | 2,025. |
| | 48" | 48" | | QAW1T44848 () () | 1,096. | 1,502. | 1,502. | 1,727. | 2,331. |
| Rectangular top - tapered 4 sides  | 48" | 30" | | QAW1T44830 () () | 988. | 1,354. | 1,354. | 1,557. | 2,101. |
| | 60" | 30" | | QAW1T46030 () () | 1,084. | 1,485. | 1,485. | 1,708. | 2,306. |
| | 72" | 30" | | QAW1T47230 () () | 1,179. | 1,615. | 1,615. | 1,858. | 2,508. |
| | 72" | 36" | | QAW1T47236 () () | 1,225. | 1,678. | 1,678. | 1,930. | 2,605. |
| Round top - tapered edge  | | | 24" | QAW1TR24 () () | 955. | 1,308. | 1,308. | 1,505. | 2,031. |
| | | | 30" | QAW1TR30 () () | 986. | 1,351. | 1,351. | 1,553. | 2,097. |
| | | | 36" | QAW1TR36 () () | 1,017. | 1,393. | 1,393. | 1,602. | 2,163. |
| | | | 42" | QAW1TR42 () () | 1,102. | 1,510. | 1,510. | 1,736. | 2,344. |
| | | | 48" | QAW1TR48 () () | 1,256. | 1,721. | 1,721. | 1,979. | 2,671. |

Order Code

| | |
|-------------|--------------------------|
| Example: | QAW1T43030-V-V316 |
| QA | AutoStrada |
| W | Worksurface |
| 1 | Generation 1 |
| T4 | Tapered edge 4 sides |
| 30 | 30" wide |
| 30 | 30" deep |
| V | Surface type, veneer |
| V316 | Maple |

Specification Information

To order please specify pattern number including:

1. Width
2. Depth
3. Surface type
L = Laminat
M = Mixed, Laminat surface/V1, V2 or V3 edge
V = V1, V2 or V3
4. Finish, Surface
 Laminat, Mixed, V1, V2 or V3 finish

Application Notes

5. Finish, Edge
Must be same as surface finish unless M surface type specified, then must be V1, V2 or V3 finish

Product on this page will accept wood grain laminate where laminate is currently an option.
 List price for wood grain laminate options will be current published laminate list price plus 10%.

Grommets are not optional for tables.

Stiffener included with rectangular tables 60"w and over.

Note: Metal inserts are required in order to create freestanding tables. Table legs must be positioned in accordance with BIFMA guidelines.

AutoStrada Cabinets

Freestanding cabinets for private office

Standard Specials Systems

| description | h | w | d | pattern no. | L | V1 | V2 | V3 |
|---|-----|-----|-----|--------------------------|----------|----------|----------|----------|
| File drawers (2) with hinged doors and wood shelves above | 70" | 30" | 24" | QACG722WE () () | \$3,928. | \$5,093. | \$6,036. | \$8,148. |
| | 70" | 36" | 24" | QACG723WE () () | 4,038. | 5,236. | 6,204. | 8,376. |
| | 84" | 30" | 24" | QACG822WE () () | 4,615. | 5,980. | 7,086. | 9,566. |
| | 84" | 36" | 24" | QACG823WE () () | 4,744. | 6,147. | 7,284. | 9,834. |

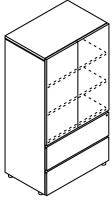

| description | h | w | d | pattern no. | L | V1 | V2 | V3 |
|----------------------------|-----|-----|-----|-------------------------|--------|--------|--------|--------|
| Wardrobe, with hinged door | 70" | 16" | 24" | QACDL720 () () | 2,811. | 3,514. | 4,164. | 5,622. |
| | 70" | 16" | 24" | QACDR720 () () | 2,811. | 3,514. | 4,164. | 5,622. |
| | 70" | 19" | 24" | QACDL721 () () | 2,811. | 3,514. | 4,164. | 5,622. |
| | 70" | 19" | 24" | QACDR721 () () | 2,811. | 3,514. | 4,164. | 5,622. |
| | 84" | 16" | 24" | QACDL820 () () | 3,356. | 4,225. | 5,007. | 6,759. |
| | 84" | 16" | 24" | QACDR820 () () | 3,356. | 4,225. | 5,007. | 6,759. |
| | 84" | 19" | 24" | QACDL821 () () | 3,356. | 4,225. | 5,007. | 6,759. |
| | 84" | 19" | 24" | QACDR821 () () | 3,356. | 4,225. | 5,007. | 6,759. |

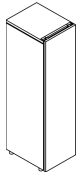

| Order Code | Specification Information | Application Notes |
|---|---|--|
| Example: QACG722WE316AAAA | <i>To order please specify pattern number including:</i> | |
| QA AutoStrada | | |
| C Cabinet | | |
| G 2 file drawers below, hinged doors above | 1. Height 7 = 70" h 8 = 84" h | Cabinets on this page are styled for the private office and include aluminum feet detail which is optional addition to lower storage beginning on page 0. Specify 70" h cabinets for use with single high overhead storage and 84" h cabinets for use with double high overhead storage. |
| 7 70" high | 2. Width 2 = 30" wide 3 = 36" wide | |
| 2 24" deep | 3. Interior & shelf W = wood drawer interior and wood shelves | |
| 2 30" wide | 4. Extruded aluminum pull E = extruded aluminum pull (default) | |
| W Wood interior only | 5. Finish <i>Laminate, V1, V2 or V3 finish</i> | |
| E Extruded Aluminum Pull | 6. Finish, Aluminum trim (trim & if pull) AA - Anodized aluminum or painted finish option from page 0 excluding silver | |
| V316 Finish, Maple | 7. Finish, cabinet feet AA - Anodized aluminum or painted finish option from page 0 excluding silver | |
| AA Finish, trim & pull, anodized aluminum | See page 0 for finish options applicable. | No pull in hinged doors. |
| AA Finish, cabinet feet, anodized alum | Product on this page will accept wood grain laminate where laminate is currently an option. List price for wood grain laminate options will be current published laminate list price plus 10%. | 84" high cabinets include wall cleat for stability. |
| | | Hinged doors feature touch latches and do not lock. Sliding doors do not lock. File drawers dilled for locks, keying instructions must accompany order. |
| | | Coat rod included in wardrobes. |

AutoStrada Lower Storage

Wood or laminate case

Standard Specials Systems

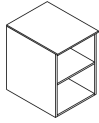
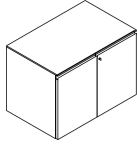
| description | type | h | w | d | pattern no. | L | V1 | V2 | V3 |
|---|----------|-----|-----|-----|-------------------------------------|--------|--------|----------|----------|
| Lower storage, open with an adj. shelf  | 19" deep | 26" | 16" | 19" | QAFPO10W () | \$885. | \$947. | \$1,089. | \$1,470. |
| | 19" deep | 26" | 19" | 19" | QAFPO11W () | 885. | 947. | 1,089. | 1,470. |
| | 19" deep | 26" | 30" | 19" | QAFPO12W () | 1,068. | 1,142. | 1,314. | 1,774. |
| | 19" deep | 26" | 36" | 19" | QAFPO13W () | 1,358. | 1,454. | 1,672. | 2,257. |
| | 23" deep | 26" | 16" | 23" | QAFPO20W () | 1,031. | 1,103. | 1,269. | 1,712. |
| | 23" deep | 26" | 19" | 23" | QAFPO21W () | 1,031. | 1,103. | 1,269. | 1,712. |
| | 23" deep | 26" | 30" | 23" | QAFPO22W () | 1,240. | 1,327. | 1,526. | 2,060. |
| | 23" deep | 26" | 36" | 23" | QAFPO23W () | 1,576. | 1,686. | 1,939. | 2,617. |
| Lower storage, full height hinged doors  | 19" deep | 26" | 16" | 19" | QAFDDL10 () ()W () | 1,044. | 1,117. | 1,284. | 1,734. |
| | 19" deep | 26" | 16" | 19" | QAFDDR10 () ()W () | 1,044. | 1,117. | 1,284. | 1,734. |
| | 19" deep | 26" | 19" | 19" | QAFDDL11 () ()W () | 1,044. | 1,117. | 1,284. | 1,734. |
| | 19" deep | 26" | 19" | 19" | QAFDDR11 () ()W () | 1,044. | 1,117. | 1,284. | 1,734. |
| | 19" deep | 26" | 30" | 19" | QAFDDL12 () ()W () | 1,226. | 1,312. | 1,509. | 2,037. |
| | 19" deep | 26" | 36" | 19" | QAFDDL13 () ()W () | 1,517. | 1,623. | 1,867. | 2,520. |
| | 23" deep | 26" | 16" | 23" | QAFDDL20 () ()W () | 1,190. | 1,273. | 1,464. | 1,976. |
| | 23" deep | 26" | 16" | 23" | QAFDDR20 () ()W () | 1,190. | 1,273. | 1,464. | 1,976. |
| | 23" deep | 26" | 19" | 23" | QAFDDL21 () ()W () | 1,190. | 1,273. | 1,464. | 1,976. |
| | 23" deep | 26" | 19" | 23" | QAFDDR21 () ()W () | 1,190. | 1,273. | 1,464. | 1,976. |
| | 23" deep | 26" | 30" | 23" | QAFDDL22 () ()W () | 1,399. | 1,497. | 1,722. | 2,324. |
| | 23" deep | 26" | 36" | 23" | QAFDDL23 () ()W () | 1,734. | 1,856. | 2,134. | 2,881. |

Example: **QAFPO10W-114**

| | |
|------------|-------------------------|
| QA | AutoStrada |
| F | Floor standing |
| P | Pedestal |
| O | Open with an adj. shelf |
| W | Wood interior only |
| 1 | 20" deep nominal |
| 0 | 16" wide |
| 114 | Finish, Folkstone grey |

To order please specify pattern number including:

- Hand (applicable 16" and 19" wide units)
L = hinges on left
R = hinges on right
- Depth
1 = 20" deep
2 = 24" deep
- Width
0 = 16" wide
1 = 19" wide
2 = 30" wide
3 = 36" wide
4 = 42" wide
- Pull
E = Extruded aluminum pull
P = Extruded aluminum protruding pull

- Lock option
L = drilled for locks
N = not drilled for locks
- Interior
W = wood interior (only)
- Finish
Laminate, V1, V2 or V3 finish
- Finish, pull
Anodized aluminum or painted finish options listed on page 0 excluding silver.

Optional lock drilled to be specified. If drilled for locks selected, keying instructions must accompany order.

See page 0 for finish options applicable.

Product on this page will accept wood grain laminate where laminate is currently an option. List price for wood grain laminate options will be current published laminate list price plus 10%.

Units on this page include a finished sub-top and anti-tip spacer. Height to underside of worksurface including anti-tip spacer is 27" h. Optional work surface stand-offs (to use in place of anti-tip spacer) are specified separately from page 0.

Primary finished top required in freestanding applications, ordered separately when item stands alone.

Note: Optional cabinet feet are recommended when units used in free-standing applications to achieve overall desk height of 29⁵/₈" (see page 0).

Note: Above pedestals do not allow for 2 rows of binder storage.

AutoStrada T5 Task Light Daisy Chain

Standard Specials Systems

| description | type | w | d | h | pattern no. | Standard | Advanced |
|---|---------------------------------|-----|----|--------|---------------------------|----------|----------|
| Task Light, starter 9 ft. cord, fused male plug 1 ft. cord, female plug | Use with 24" and wider overhead | 19" | 4" | 1 1/2" | AL1T5E19()DCS()Q | \$397. | n/a |
| | Use with 30" and wider overhead | 25" | 4" | 1 1/2" | AL1T5E25()DCS()Q | 402. | 518. |
| | Use with 42" and wider overhead | 37" | 4" | 1 1/2" | AL1T5E37()DCS()Q | 407. | 538. |
| | Use with 60" and wider overhead | 49" | 4" | 1 1/2" | AL1T5E49()DCS()Q | 412. | 554. |
| | Use with 72" and wider overhead | 61" | 4" | 1 1/2" | AL1T5E61()DCS()Q | 428. | 570. |
| | Use with 84" and wider overhead | 73" | 4" | 1 1/2" | AL1T5E73()DCS()Q | 454. | 587. |
| | Use with 96" and wider overhead | 85" | 4" | 1 1/2" | AL1T5E85()DCS()Q | 533. | 603. |

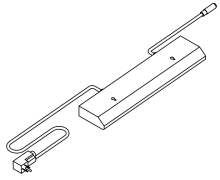

left hand shown

| | | | | | | | |
|---|---------------------------------|-----|----|--------|---------------------------|------|------|
| Task Light, adder 2 ft. cord, male plug 1 ft. cord, female plug | Use with 24" and wider overhead | 19" | 4" | 1 1/2" | AL1T5E19()DCA()Q | 429. | n/a |
| | Use with 30" and wider overhead | 25" | 4" | 1 1/2" | AL1T5E25()DCA()Q | 434. | 550. |
| | Use with 42" and wider overhead | 37" | 4" | 1 1/2" | AL1T5E37()DCA()Q | 439. | 570. |
| | Use with 60" and wider overhead | 49" | 4" | 1 1/2" | AL1T5E49()DCA()Q | 444. | 586. |
| | Use with 72" and wider overhead | 61" | 4" | 1 1/2" | AL1T5E61()DCA()Q | 460. | 602. |
| | Use with 84" and wider overhead | 73" | 4" | 1 1/2" | AL1T5E73()DCA()Q | 486. | 619. |
| | Use with 96" and wider overhead | 85" | 4" | 1 1/2" | AL1T5E85()DCA()Q | 565. | 635. |

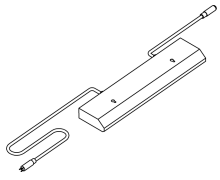

left hand shown

| | | | | | | | |
|--|---------------------------------|-----|----|--------|---------------------------|------|------|
| Task Light, ender 2 ft. cord, male plug | Use with 24" and wider overhead | 19" | 4" | 1 1/2" | AL1T5E19()DCE()Q | 316. | n/a |
| | Use with 30" and wider overhead | 25" | 4" | 1 1/2" | AL1T5E25()DCE()Q | 321. | 437. |
| | Use with 42" and wider overhead | 37" | 4" | 1 1/2" | AL1T5E37()DCE()Q | 326. | 457. |
| | Use with 60" and wider overhead | 49" | 4" | 1 1/2" | AL1T5E49()DCE()Q | 331. | 473. |
| | Use with 72" and wider overhead | 61" | 4" | 1 1/2" | AL1T5E61()DCE()Q | 347. | 489. |
| | Use with 84" and wider overhead | 73" | 4" | 1 1/2" | AL1T5E73()DCE()Q | 373. | 506. |
| | Use with 84" and wider overhead | 85" | 4" | 1 1/2" | AL1T5E85()DCE()Q | 452. | 522. |

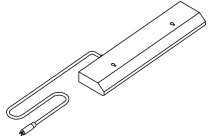

left hand shown

| Order Code | Specification Information | Application Notes |
|----------------------------------|--|---|
| Example: AL1T5E19SDCSLQ | <i>Specify:</i> | Task lights mount into the recess in the underside of overhead cabinets and shelves at least 5" wider than task light width. |
| AL1 AutoStrada Task Light | Width - Task Lights mount in cabinets and shelves at least 5" wider than light width. | Task Light fit to overhead cabinets without the use of filler panels. |
| T5 T5 lamp | 1. Type: (S) Standard (A) Advanced | All lights feature two screw-mounting keyholes. |
| E Electronic ballast | 2. Handedness L= Left handed (male plug on user's left side) R=Right handed (male plug on user's right side) | Task lights include T5 cool white (4100K) fluorescent lamp, electronic ballast, prismatic lens, rocker switch, one cord exit management clip and mounting hardware. |
| 19 Width | All housings are black. | Task lights are TCLP compliant and meet requirements of California Title 24. |
| S Standard | | Advanced task lights are fitted with ballast and lamp compliant with LEED requirements. |
| DC Daisy chain | | |
| S Starter | | |
| L Left handed | | |
| Q Special | | |

T5 Task Light for Reuter Overhead Storage Daisy Chain

| description | type | w | d | h | pattern no. | Standard | Advanced |
|---|---------------------------------|-----|----|--------|---------------------------|----------|----------|
| Task Light, starter 9 ft. cord, fused male plug 1 ft. cord, female plug | Use with 24" and wider overhead | 19" | 4" | 1 1/2" | RTAT5E19()DCS()Q | \$351. | n/a |
| | Use with 30" and wider overhead | 25" | 4" | 1 1/2" | RTAT5E25()DCS()Q | 367. | 533. |
| | Use with 42" and wider overhead | 37" | 4" | 1 1/2" | RTAT5E37()DCS()Q | 385. | 554. |
| | Use with 60" and wider overhead | 49" | 4" | 1 1/2" | RTAT5E49()DCS()Q | 406. | 570. |
| | Use with 66" and wider overhead | 61" | 4" | 1 1/2" | RTAT5E61()DCS()Q | 423. | 588. |

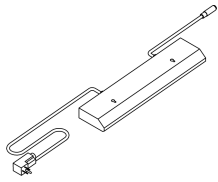

left hand shown

| | | | | | | | |
|---|---------------------------------|-----|----|--------|---------------------------|------|------|
| Task Light, adder 2 ft. cord, male plug 1 ft. cord, female plug | Use with 24" and wider overhead | 19" | 4" | 1 1/2" | RTAT5E19()DCA()Q | 383. | n/a |
| | Use with 30" and wider overhead | 25" | 4" | 1 1/2" | RTAT5E25()DCA()Q | 399. | 565. |
| | Use with 42" and wider overhead | 37" | 4" | 1 1/2" | RTAT5E37()DCA()Q | 417. | 586. |
| | Use with 60" and wider overhead | 49" | 4" | 1 1/2" | RTAT5E49()DCA()Q | 438. | 602. |
| | Use with 66" and wider overhead | 61" | 4" | 1 1/2" | RTAT5E61()DCA()Q | 455. | 620. |

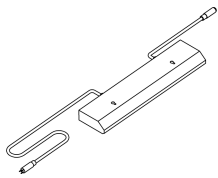

left hand shown

| | | | | | | | |
|--|---------------------------------|-----|----|--------|---------------------------|------|------|
| Task Light, ender 2 ft. cord, male plug | Use with 24" and wider overhead | 19" | 4" | 1 1/2" | RTAT5E19()DCE()Q | 270. | n/a |
| | Use with 30" and wider overhead | 25" | 4" | 1 1/2" | RTAT5E25()DCE()Q | 286. | 452. |
| | Use with 42" and wider overhead | 37" | 4" | 1 1/2" | RTAT5E37()DCE()Q | 304. | 473. |
| | Use with 60" and wider overhead | 49" | 4" | 1 1/2" | RTAT5E49()DCE()Q | 325. | 489. |
| | Use with 66" and wider overhead | 61" | 4" | 1 1/2" | RTAT5E61()DCE()Q | 342. | 507. |

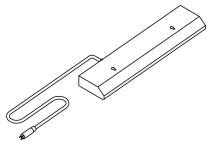

left hand shown

| Order Code | Specification Information | Application Notes |
|--------------------------------|--|---|
| Example: RTAT5E19SDCSLQ | <i>Specify:</i> | Task lights mount into the recess in the underside of overhead cabinets and shelves at least 5" wider than task light width. |
| RTA Task Light | Width - Task Lights mount in cabinets and shelves at least 5" wider than light width. | Task lights include T5 cool white (4100K) fluorescent lamp, electronic ballast, prismatic lens, rocker switch, one cord exit management clip and mounting hardware. |
| T5 T5 lamp | 1. Type: (S) Standard (A) Advanced | Task lights are TCLP compliant and meet requirements of California Title 24. |
| E Electronic ballast | 2. Handedness L= Left handed (male plug on user's left side) R=Right handed (male plug on user's right side) | Advanced task lights are fitted with ballast and lamp compliant with LEED requirements. |
| 19 Width | All housings are black. | |
| S Standard | | |
| DC Daisy chain | | |
| S Starter | | |
| L Left handed | | |
| Q Special | | |

The Graham Collection T5 Task Light

Daisy Chain

Standard Specials Systems

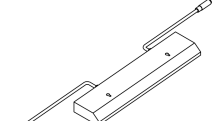
| description | type | w | d | h | pattern no. | Standard | Advanced |
|--|---------------------------------|-----|----|--------|---------------------------|----------|----------|
| Task Light, starter 9 ft. cord, fused male plug 1 ft. cord, female plug  | Use with 24" and wider overhead | 19" | 4" | 1 1/2" | GTLT5E19()DCS()Q | \$400. | n/a |
| | Use with 30" and wider overhead | 25" | 4" | 1 1/2" | GTLT5E25()DCS()Q | 406. | 524. |
| | Use with 42" and wider overhead | 37" | 4" | 1 1/2" | GTLT5E37()DCS()Q | 412. | 544. |
| | Use with 60" and wider overhead | 49" | 4" | 1 1/2" | GTLT5E49()DCS()Q | 417. | 560. |
| | Use with 72" and wider overhead | 61" | 4" | 1 1/2" | GTLT5E61()DCS()Q | 432. | 577. |
| | Use with 84" and wider overhead | 73" | 4" | 1 1/2" | GTLT5E73()DCS()Q | 458. | 594. |
| | Use with 96" and wider overhead | 85" | 4" | 1 1/2" | GTLT5E85()DCS()Q | 538. | 609. |

left hand shown

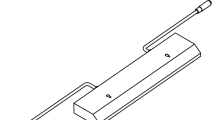
| | | | | | | | |
|--|---------------------------------|-----|----|--------|---------------------------|------|------|
| Task Light, adder 2 ft. cord, male plug 1 ft. cord, female plug  | Use with 24" and wider overhead | 19" | 4" | 1 1/2" | GTLT5E19()DCA()Q | 432. | n/a |
| | Use with 30" and wider overhead | 25" | 4" | 1 1/2" | GTLT5E25()DCA()Q | 438. | 556. |
| | Use with 42" and wider overhead | 37" | 4" | 1 1/2" | GTLT5E37()DCA()Q | 444. | 576. |
| | Use with 60" and wider overhead | 49" | 4" | 1 1/2" | GTLT5E49()DCA()Q | 449. | 592. |
| | Use with 72" and wider overhead | 61" | 4" | 1 1/2" | GTLT5E61()DCA()Q | 464. | 609. |
| | Use with 84" and wider overhead | 73" | 4" | 1 1/2" | GTLT5E73()DCA()Q | 490. | 626. |
| | Use with 96" and wider overhead | 85" | 4" | 1 1/2" | GTLT5E85()DCA()Q | 570. | 641. |

left hand shown

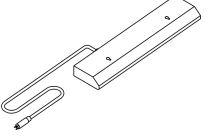
| | | | | | | | |
|---|---------------------------------|-----|----|--------|---------------------------|------|------|
| Task Light, ender 2 ft. cord, male plug  | Use with 24" and wider overhead | 19" | 4" | 1 1/2" | GTLT5E19()DCE()Q | 319. | n/a |
| | Use with 30" and wider overhead | 25" | 4" | 1 1/2" | GTLT5E25()DCE()Q | 325. | 443. |
| | Use with 42" and wider overhead | 37" | 4" | 1 1/2" | GTLT5E37()DCE()Q | 331. | 463. |
| | Use with 60" and wider overhead | 49" | 4" | 1 1/2" | GTLT5E49()DCE()Q | 336. | 479. |
| | Use with 72" and wider overhead | 61" | 4" | 1 1/2" | GTLT5E61()DCE()Q | 351. | 496. |
| | Use with 84" and wider overhead | 73" | 4" | 1 1/2" | GTLT5E73()DCE()Q | 377. | 513. |
| | Use with 96" and wider overhead | 85" | 4" | 1 1/2" | GTLT5E85()DCE()Q | 457. | 528. |

left hand shown

| Order Code | Specification Information | Application Notes |
|--------------------------------|--|--|
| Example: GTLT5E19SDCSLQ | <i>Specify:</i> | T5 tasklights are TCLP compliant and meet requirements of California Title 24. |
| G Graham Collection | Width - Task Lights mount in cabinets and shelves at least 5" wider than light width. | T5 tasklight include T5 cool white (4100K) fluorescent lamp; electronic ballast, prismatic lens, rocker switch, one cord exit management clip and mounting hardware. |
| TL Task light | 1. Type: (S) Standard (A) Advanced | * Advanced tasklights are fitted with ballast and lamp compliant with LEED requirements. |
| T5 T5 lamp | 2. Handedness L= Left handed (male plug on user's left side) R=Right handed (male plug on user's right side) | |
| E Electronic ballast | | |
| 19 Width | | |
| S Standard | | |
| DC Daisy chain | | |
| S Starter | | |
| L Left handed | | |
| Q Special | | |

All housings are black.

Alpha-Numeric Index

| <i>pattern no.</i> | <i>page</i> | <i>pattern no.</i> | <i>page</i> | <i>pattern no.</i> | <i>page</i> | <i>pattern no.</i> | <i>page</i> |
|--------------------|-------------|--------------------|-------------|--------------------|-------------|--------------------|-------------|
| AA1EPS80Q | 32 | D1BD7848SRQ | 18 | D1L4866DDNQ | 15 | DIR3918NQ | 7 |
| AL1T5E19 | 184 | D1BD8448DLQ | 18 | D1L4872DDNQ | 15 | DIR3924NQ | 8 |
| AL1T5E25 | 184 | D1BD8448DRQ | 18 | D1L4878DSNQ | 16 | DIR3930NQ | 9 |
| AL1T5E37 | 184 | D1BD8448SLQ | 18 | D1L4878SDNQ | 16 | DIR3936NQ | 10 |
| AL1T5E49 | 184 | D1BD8448SRQ | 18 | D1L4878SSNQ | 14 | DIR4236NQ | 10 |
| AL1T5E61 | 184 | D1C4230GQ | 13 | D1L4884DDNQ | 15 | DIR4518NQ | 7 |
| AL1T5E73 | 184 | D1C4230NQ | 13 | D1L4884DSNQ | 16 | DIR4524NQ | 8 |
| AL1T5E85 | 184 | D1C4836GQ | 13 | D1L4884SDNQ | 16 | DIR4530NQ | 9 |
| AW1-CS2412Q | 90 | D1C4836NQ | 13 | D1L4896DDNQ | 15 | DIR4536NQ | 10 |
| AW1-CS3012Q | 90 | D1CRR30Q | 18 | D1L4896DSNQ | 16 | DIR4836NQ | 10 |
| AW1-CS4212Q | 90 | D1CS3624GQ | 13 | D1L4896SSNQ | 14 | DIR5118NQ | 7 |
| AW1-CS5412Q | 90 | D1CS3624NQ | 13 | D1L5436DSNQ | 16 | DIR5124NQ | 8 |
| AW1-CS6612Q | 90 | D1D3024NQ | 17 | D1L5436SDNQ | 16 | DIR5130NQ | 9 |
| AW1-F2430Q | 90 | D1D3030NQ | 17 | D1L5436SSNQ | 14 | DIR5136NQ | 10 |
| AW1-F3030Q | 90 | D1D3624NQ | 17 | D1L5442SSNQ | 14 | DIR5436NQ | 10 |
| AW1-F4230Q | 90 | D1D3630NQ | 17 | D1L5448SSNQ | 14 | DIR5718NQ | 7 |
| AW1-F5430Q | 90 | D1D5424NQ | 17 | D1L6036SSNQ | 14 | DIR5724NQ | 8 |
| AW1-F6630Q | 90 | D1D5430NQ | 17 | D1L6042DDNQ | 15 | DIR5730NQ | 9 |
| AW1-F7830Q | 90 | D1D5436NQ | 17 | D1L6048DDNQ | 15 | DIR5736NQ | 10 |
| AW1-S2430Q | 90 | D1D6024NQ | 17 | D1L6642DDNQ | 15 | DIR6318NQ | 7 |
| AW1-S3030Q | 90 | D1D6036NQ | 17 | D1L6642DSNQ | 16 | DIR6324NQ | 8 |
| AW1-S4230Q | 90 | D1D6624NQ | 17 | D1L6642SDNQ | 16 | DIR6330NQ | 9 |
| AW1-S5424Q | 90 | D1D6636NQ | 17 | D1L6648DDNQ | 15 | DIR6336NQ | 10 |
| AW1-S5430Q | 90 | D1D7224NQ | 17 | D1L7236SSNQ | 14 | DIR6918NQ | 7 |
| AW1-S6630Q | 90 | D1D7824NQ | 17 | D1L7242DDNQ | 15 | DIR6924NQ | 8 |
| AW1-S7824Q | 90 | D1D7830NQ | 17 | D1L7248DDNQ | 15 | DIR6930NQ | 9 |
| AW1-S7830Q | 90 | D1D7836NQ | 17 | D1L7836SSNQ | 14 | DIR6936NQ | 10 |
| AX1E28Q | 32 | D1D8424NQ | 17 | D1L8442SSNQ | 14 | DIR7518NQ | 7 |
| AX1E80Q | 32 | D1D8430NQ | 17 | D1L8448DDNQ | 15 | DIR7524NQ | 8 |
| CE10236Q | 39 | D1D8436NQ | 17 | D1L8448DSNQ | 16 | DIR7530NQ | 9 |
| CE11418Q | 39 | D1D9624NQ | 17 | D1L8448SDNQ | 16 | DIR7536NQ | 10 |
| CE11436Q | 39 | D1D9630NQ | 17 | D1L9648DDNQ | 15 | DIR7836NQ | 10 |
| CE12036Q | 39 | D1D9636NQ | 17 | D1L9648SSNQ | 14 | DIR8118NQ | 7 |
| CE4836Q | 39 | D1L3648DSNQ | 16 | D1P5430NQ | 18 | DIR8124NQ | 8 |
| CE5436Q | 39 | D1L3648SDNQ | 16 | D1P6030NQ | 18 | DIR8130NQ | 9 |
| CE6618Q | 39 | D1L3648SSNQ | 14 | D1P7836NQ | 18 | DIR8136NQ | 10 |
| CE6636Q | 39 | D1L3654SDNQ | 16 | D1P8430NQ | 18 | DIR8436NQ | 10 |
| CE7818Q | 39 | D1L3654SSNQ | 14 | D1P9030NQ | 18 | DIR8718NQ | 7 |
| CE7836Q | 39 | D1L3660SSNQ | 14 | DIR10224NQ | 8 | DIR8724NQ | 8 |
| CE9618Q | 39 | D1L3672SSNQ | 14 | DIR10230NQ | 9 | DIR8730NQ | 9 |
| CE9636Q | 39 | D1L3678SSNQ | 14 | DIR10236NQ | 10 | DIR8736NQ | 10 |
| D195430NQ | 18 | D1L4242DDNQ | 15 | DIR10824NQ | 8 | DIR9036NQ | 10 |
| D196030NQ | 18 | D1L4242DSNQ | 16 | DIR10830NQ | 9 | DIR9318NQ | 7 |
| D197836NQ | 18 | D1L4242SDNQ | 16 | DIR10836NQ | 10 | DIR9324NQ | 8 |
| D198430NQ | 18 | D1L4248DSNQ | 16 | DIR11430NQ | 9 | DIR9330NQ | 9 |
| D199030NQ | 18 | D1L4248SDNQ | 16 | DIR11436NQ | 10 | DIR9336NQ | 10 |
| D1BD5448DLQ | 17 | D1L4248SSNQ | 14 | DIR12024NQ | 8 | DIR9636NQ | 10 |
| D1BD5448DRQ | 17 | D1L4254SSNQ | 14 | DIR12030NQ | 9 | DIR9918NQ | 7 |
| D1BD5448SLQ | 17 | D1L4260DDNQ | 15 | DIR12036NQ | 10 | DIR9924NQ | 8 |
| D1BD5448SRQ | 17 | D1L4266DDNQ | 15 | DIR1818NQ | 7 | DIR9930NQ | 9 |
| D1BD6048DLQ | 17 | D1L4266DSNQ | 16 | DIR2118NQ | 7 | DIR9936NQ | 10 |
| D1BD6048DRQ | 17 | D1L4266SDNQ | 16 | DIR2124NQ | 8 | DIW302430NQ | 12 |
| D1BD6048SLQ | 18 | D1L4272DDNQ | 15 | DIR2718NQ | 7 | DIW303024NQ | 11 |
| D1BD6048SRQ | 18 | D1L4272DSNQ | 16 | DIR2724NQ | 8 | DIW361824NQ | 12 |
| D1BD7242DLQ | 18 | D1L4272SDNQ | 16 | DIR2730NQ | 9 | DIW362418NQ | 11 |
| D1BD7242DRQ | 18 | D1L4284SSNQ | 14 | DIR3036NQ | 10 | DIW482436NQ | 12 |
| D1BD7242SLQ | 18 | D1L4836SSNQ | 14 | DIR3318NQ | 7 | DIW483624NQ | 11 |
| D1BD7242SRQ | 18 | D1L4842SDNQ | 16 | DIR3324NQ | 8 | DIW542430NQ | 12 |
| D1BD7848DLQ | 18 | D1L4842SSNQ | 14 | DIR3330NQ | 9 | DIW543024NQ | 11 |
| D1BD7848DRQ | 18 | D1L4854SSNQ | 14 | DIR3336NQ | 10 | DIW601830NQ | 12 |
| D1BD7848SLQ | 18 | D1L4860DDNQ | 15 | DIR3636NQ | 10 | DIW602430NQ | 12 |

| <i>pattern no.</i> | <i>page</i> | <i>pattern no.</i> | <i>page</i> | <i>pattern no.</i> | <i>page</i> | <i>pattern no.</i> | <i>page</i> |
|---------------------|-------------|--------------------|-------------|--------------------|-------------|--------------------|-------------|
| D1W602436NQ | 12 | DE(OE/OT)PM24Q | 22 | ELAT5E49 | 40 | LU1-C4248DD-Q | 87 |
| D1W603018NQ | 11 | DE(OE/OT)PM30Q | 22 | EP1DL36LQ | 28 | LU1-C4248DS-Q | 86 |
| D1W603024NQ | 11 | DE(OE/OT)PM36Q | 22 | EP1DL36RQ | 28 | LU1-C4248SD-Q | 86 |
| D1W603624NQ | 11 | DE(OE/OT)PM42Q | 22 | EP1DL42LQ | 28 | LU1-C4248SS-Q | 86 |
| D1W662430NQ | 12 | DE(OE/OT)PM48Q | 22 | EP1DL42RQ | 28 | LU1-C4260DD-Q | 87 |
| D1W662436NQ | 12 | DE(OE/OT)RBI56Q | 25 | EP1DL48LQ | 29 | LU1-C4260DS-Q | 86 |
| D1W663024NQ | 11 | DE(OE/OT)VPIJQ | 24 | EP1DL48RQ | 29 | LU1-C4260SD-Q | 86 |
| D1W663624NQ | 11 | DES(OE/OT)BPCNPQ | 23 | EP1SDOLQ | 29 | LU1-C4260SS-Q | 86 |
| D1W723036NQ | 12 | DES(OE/OT)BPCWPQ | 23 | EP1SDORQ | 29 | LU1-C4266DD-Q | 87 |
| D1W723630NQ | 11 | DES(OE/OT)BPJ18NPQ | 23 | EP1SDSLQ | 29 | LU1-C4266DS-Q | 86 |
| D1W782430NQ | 12 | DES(OE/OT)BPJ18WPQ | 23 | EP1SDSRQ | 29 | LU1-C4266SD-Q | 86 |
| D1W782436NQ | 12 | DES(OE/OT)BPJ24NPQ | 23 | EP3DL36LQ | 30 | LU1-C4266SS-Q | 86 |
| D1W783024NQ | 11 | DES(OE/OT)BPJ24WPQ | 23 | EP3DL36RQ | 30 | LU1-C4272DD-Q | 87 |
| D1W783624NQ | 11 | DES(OE/OT)BPJ30NPQ | 23 | EP3DL42LQ | 30 | LU1-C4272DS-Q | 86 |
| D1W842436NQ | 12 | DES(OE/OT)BPJ30WPQ | 23 | EP3DL42RQ | 30 | LU1-C4272SD-Q | 86 |
| D1W843624NQ | 11 | DES(OE/OT)BPJ36NPQ | 23 | EP3DL48LQ | 31 | LU1-C4272SS-Q | 86 |
| D1W902430NQ | 12 | DES(OE/OT)BPJ36WPQ | 23 | EP3DL48RQ | 31 | LU1-C4842DD-Q | 87 |
| D1W903024NQ | 11 | DES(OE/OT)BPJ42NPQ | 23 | EP3SDOLQ | 31 | LU1-C4842DS-Q | 86 |
| D1W962430NQ | 12 | DES(OE/OT)BPJ42WPQ | 23 | EP3SDORQ | 31 | LU1-C4842SD-Q | 86 |
| D1W962436NQ | 12 | DES(OE/OT)BPJ48NPQ | 23 | EP3SDSLQ | 31 | LU1-C4842SS-Q | 86 |
| D1W963024NQ | 11 | DES(OE/OT)BPJ48WPQ | 23 | EP3SDSRQ | 31 | LU1-C4860DD-Q | 87 |
| D1W963036NQ | 12 | DES(OE/OT)BPJ54WPQ | 23 | EW12418CQ | 33 | LU1-C4866DD-Q | 87 |
| D1W963624NQ | 11 | DES(OE/OT)BPJ60WPQ | 23 | EW12418Q | 33 | LU1-C4866DS-Q | 86 |
| D1W963630NQ | 11 | DES(OE/OT)BPJ66WPQ | 23 | EW14236CQ | 33 | LU1-C4866SD-Q | 86 |
| DB1BD48DLQ | 17 | DES(OE/OT)BPJ72WPQ | 23 | EW14236Q | 33 | LU1-C4866SS-Q | 86 |
| DB1BD48DRQ | 17 | DES(OE/OT)BPJ78WPQ | 23 | EW16615Q | 33 | LU1-C4872DD-Q | 87 |
| DE0DRAQ | 22 | DES(OE/OT)BPJ84WPQ | 23 | EW1(9/P)6030Q | 36 | LU1-C6042DD-Q | 87 |
| DE0DRBQ | 22 | DES(OE/OT)BPJ96WPQ | 23 | EW1(9/P)9636Q | 36 | LU1-C6042DS-Q | 86 |
| DE0DRCQ | 22 | DL3T5E19 | 26 | EW1BD3672S | 34 | LU1-C6042SD-Q | 86 |
| DE0DRXQ | 22 | DL3T5E25 | 26 | EW1BD4860D | 34 | LU1-C6042SS-Q | 86 |
| DE(OE/OT)BI56(L/R)Q | 25 | DL3T5E37 | 26 | EW1BD4872D | 34 | LU1-C6048DD-Q | 87 |
| DE(OE/OT)BPM301Q | 23 | DL3T5E49 | 26 | EW1BD6036S | 34 | LU1-C6642DD-Q | 87 |
| DE(OE/OT)BPM302Q | 23 | DP5CHQ | 20 | EW1BD6048D | 34 | LU1-C6642DS-Q | 86 |
| DE(OE/OT)BPM361Q | 23 | DS3WMC1430Q | 20 | EW1BS3672D | 34 | LU1-C6642SD-Q | 86 |
| DE(OE/OT)BPM362Q | 23 | DS3WMC1433Q | 20 | EW1BS3678S | 34 | LU1-C6642SS-Q | 86 |
| DE(OE/OT)BPM421Q | 23 | DS3WMC1436Q | 20 | EW1BS4272S | 34 | LU1-C6648DD-Q | 87 |
| DE(OE/OT)BPM422Q | 23 | DS3WMC1442Q | 20 | EW1BS6060S | 34 | LU1-C6648DS-Q | 86 |
| DE(OE/OT)BPM481Q | 23 | DS3WMC1448Q | 20 | EW1BS7236D | 34 | LU1-C6648SD-Q | 86 |
| DE(OE/OT)BPM482Q | 23 | DS3WMC2130Q | 20 | EW1BS7242S | 34 | LU1-C6648SS-Q | 86 |
| DE(OE/OT)CH144Q | 25 | DS3WMC2133Q | 20 | EW1BS7836S | 34 | LU1-C7242DD-Q | 87 |
| DE(OE/OT)PCNPQ | 22 | DS3WMC2136Q | 20 | EW1CC4215EEQ | 35 | LU1-C7242DS-Q | 86 |
| DE(OE/OT)PCWPQ | 22 | DS3WMC2142Q | 20 | EW1CC4215EQ | 35 | LU1-C7242SD-Q | 86 |
| DE(OE/OT)PJ120WPQ | 24 | DS3WMC2148Q | 20 | EW1CC4215Q | 35 | LU1-C7242SS-Q | 86 |
| DE(OE/OT)PJ126WPQ | 24 | DT1BYD602430Q | 19 | EW1CC482430GQ | 35 | LU1-C7248DD-Q | 87 |
| DE(OE/OT)PJ138WPQ | 24 | DT1BYD6036Q | 19 | EW1CC483024GQ | 35 | LU1-J24A-(L/R)-Q | 88 |
| DE(OE/OT)PJ144WPQ | 24 | DT1BYD662430Q | 19 | EW1CC483030GQ | 35 | LU1-J30A-(L/R)-Q | 88 |
| DE(OE/OT)PJ18NPQ | 22 | DT1BYD6636Q | 19 | EW3(9/P)6630Q | 38 | LU1-J36A-(L/R)-Q | 88 |
| DE(OE/OT)PJ18WPQ | 22 | DT1BYD722430Q | 19 | EW3BS3678S | 37 | LU1-J42A-(L/R)-Q | 88 |
| DE(OE/OT)PJ24NPQ | 22 | DT1BYD7236Q | 19 | EW3BS7836S | 37 | LU1-J48A-(L/R)-Q | 88 |
| DE(OE/OT)PJ24WPQ | 22 | DT1BYD7242Q | 19 | EW3CC483024GQ | 37 | LU1-J54A-(L/R)-Q | 88 |
| DE(OE/OT)PJ30NPQ | 22 | DT1BYD782430Q | 19 | EW3D7230Q | 38 | LU1-J60A-(L/R)-Q | 88 |
| DE(OE/OT)PJ30WPQ | 22 | DT1BYD7836Q | 19 | GTLT5E19 | 186 | LU1-J66A-(L/R)-Q | 88 |
| DE(OE/OT)PJ36NPQ | 22 | DT1BYD7842Q | 19 | GTLT5E25 | 186 | LU1-J72A-(L/R)-Q | 88 |
| DE(OE/OT)PJ36WPQ | 22 | DT1BYD842430Q | 19 | GTLT5E37 | 186 | LU1-J78A-(L/R)-Q | 88 |
| DE(OE/OT)PJ42NPQ | 22 | DT1BYD8436Q | 19 | GTLT5E49 | 186 | LU1-J84A-(L/R)-Q | 88 |
| DE(OE/OT)PJ42WPQ | 22 | DT1BYD8442Q | 19 | GTLT5E61 | 186 | LU1-J90A-(L/R)-Q | 88 |
| DE(OE/OT)PJ48NPQ | 22 | DT1BYD902430Q | 19 | GTLT5E73 | 186 | LU1-J96A-(L/R)-Q | 88 |
| DE(OE/OT)PJ48WPQ | 22, 24 | DT1BYD9036Q | 19 | GTLT5E85 | 186 | LU1-P72SA-L-Q | 85 |
| DE(OE/OT)PJ54WPQ | 22, 24 | DT1BYD9042Q | 19 | LL2T5E19 | 101 | LU1-P72SA-R-Q | 85 |
| DE(OE/OT)PJ60WPQ | 22, 24 | DT1BYD962430Q | 19 | LL2T5E25 | 101 | LU1-P78DA-L-Q | 85 |
| DE(OE/OT)PJ66WPQ | 22 | DT1BYD9636Q | 19 | LL2T5E37 | 101 | LU1-P78DA-R-Q | 85 |
| DE(OE/OT)PJ72WPQ | 22 | DT1BYD9642Q | 19 | LL2T5E49 | 101 | LU1-R6636B-(L/R)-Q | 84 |
| DE(OE/OT)PJ78WPQ | 22 | ELAT5E19 | 40 | LU1-C4242DD-Q | 87 | LU1-R7836B-(L/R)-Q | 84 |
| DE(OE/OT)PJ84WPQ | 22 | ELAT5E25 | 40 | LU1-C4242DS-Q | 86 | LU1-R8730B-(L/R)-Q | 84 |
| DE(OE/OT)PJ96WPQ | 22 | ELAT5E37 | 40 | LU1-C4242SD-Q | 86 | LU1-R9036B-(L/R)-Q | 84 |

| <i>pattern no.</i> | <i>page</i> | <i>pattern no.</i> | <i>page</i> | <i>pattern no.</i> | <i>page</i> | <i>pattern no.</i> | <i>page</i> |
|--------------------|-------------|--------------------|-------------|--------------------|-------------|----------------------|-------------|
| LU1-S10218-A-Q | 76 | LU1-S2618-B-Q | 80 | LU1-S6824-A-Q | 81 | LU1-W84A-(L/R)-Q | 89 |
| LU1-S10218-B-Q | 76 | LU1-S2624-A-Q | 81 | LU1-S6824-B-Q | 81 | LU1-W90A-(L/R)-Q | 89 |
| LU1-S10224-A-Q | 77 | LU1-S2624-B-Q | 81 | LU1-S6830-A-Q | 82 | LU1-W96A-(L/R)-Q | 89 |
| LU1-S10224-B-Q | 77 | LU1-S2630-A-Q | 82 | LU1-S6830-B-Q | 82 | LV3-D64-(L/R) | 99 |
| LU1-S10230-A-Q | 78 | LU1-S2630-B-Q | 82 | LU1-S6836-A-Q | 83 | LV3-S18S-(L/R) | 99 |
| LU1-S10230-B-Q | 78 | LU1-S3218-A-Q | 80 | LU1-S6836-B-Q | 83 | LV3-S56-(L/R) | 99 |
| LU1-S10236-A-Q | 79 | LU1-S3218-B-Q | 80 | LU1-S7236-A-Q | 79 | LV3-W64-(L/R) | 99 |
| LU1-S10236-B-Q | 79 | LU1-S3224-A-Q | 81 | LU1-S7236-B-Q | 79 | MC1-30H1 | 47, 48 |
| LU1-S10418-A-Q | 80 | LU1-S3224-B-Q | 81 | LU1-S7418-A-Q | 80 | MC1-30H1V | 48 |
| LU1-S10418-B-Q | 80 | LU1-S3230-A-Q | 82 | LU1-S7418-B-Q | 80 | MC1-30S2 | 45, 46 |
| LU1-S10424-A-Q | 81 | LU1-S3230-B-Q | 82 | LU1-S7424-A-Q | 81 | MC1-30S2V | 46 |
| LU1-S10424-B-Q | 81 | LU1-S3636-A-Q | 79 | LU1-S7424-B-Q | 81 | MC1-39H1 | 47, 48 |
| LU1-S10430-A-Q | 82 | LU1-S3636-B-Q | 79 | LU1-S7430-A-Q | 82 | MC1-39H1V | 48 |
| LU1-S10430-B-Q | 82 | LU1-S3818-A-Q | 80 | LU1-S7430-B-Q | 82 | MC1-39S2 | 45, 46 |
| LU1-S10436-A-Q | 83 | LU1-S3818-B-Q | 80 | LU1-S7436-A-Q | 83 | MC1-39S2V | 46 |
| LU1-S10436-B-Q | 83 | LU1-S3824-A-Q | 81 | LU1-S7436-B-Q | 83 | MC1-42H1 | 47, 48 |
| LU1-S10830-A-Q | 78 | LU1-S3824-B-Q | 81 | LU1-S7836-A-Q | 79 | MC1-42H1V | 48 |
| LU1-S10830-B-Q | 78 | LU1-S3830-A-Q | 82 | LU1-S7836-B-Q | 79 | MC1-42S2 | 45, 46 |
| LU1-S10836-A-Q | 79 | LU1-S3830-B-Q | 82 | LU1-S8018-A-Q | 80 | MC1-42S2V | 46 |
| LU1-S10836-B-Q | 79 | LU1-S3836-A-Q | 83 | LU1-S8018-B-Q | 80 | MC1-48H1 | 47, 48 |
| LU1-S11018-A-Q | 80 | LU1-S3836-B-Q | 83 | LU1-S8024-A-Q | 81 | MC1-48H1V | 48 |
| LU1-S11018-B-Q | 80 | LU1-S4236-A-Q | 79 | LU1-S8024-B-Q | 81 | MC1-48S2 | 45, 46 |
| LU1-S11024-A-Q | 81 | LU1-S4236-B-Q | 79 | LU1-S8030-A-Q | 82 | MC1-48S2V | 46 |
| LU1-S11024-B-Q | 81 | LU1-S4418-A-Q | 80 | LU1-S8030-B-Q | 82 | MC1-56H1 | 47, 48 |
| LU1-S11030-A-Q | 82 | LU1-S4418-B-Q | 80 | LU1-S8036-A-Q | 83 | MC1-56H1V | 48 |
| LU1-S11030-B-Q | 82 | LU1-S4424-A-Q | 81 | LU1-S8036-B-Q | 83 | MC1-56S2 | 45, 46 |
| LU1-S11036-A-Q | 83 | LU1-S4424-B-Q | 81 | LU1-S8436-A-Q | 79 | MC1-56S2V | 46 |
| LU1-S11036-B-Q | 83 | LU1-S4430-A-Q | 82 | LU1-S8436-B-Q | 79 | MC1-64S2 | 45, 46 |
| LU1-S11418-A-Q | 76 | LU1-S4430-B-Q | 82 | LU1-S8618-A-Q | 80 | MC1-64S2V | 46 |
| LU1-S11418-B-Q | 76 | LU1-S4436-A-Q | 83 | LU1-S8618-B-Q | 80 | MC1-74H1 | 47, 48 |
| LU1-S11424-A-Q | 77 | LU1-S4436-B-Q | 83 | LU1-S8624-A-Q | 81 | MC1-74H1V | 48 |
| LU1-S11424-B-Q | 77 | LU1-S4836-A-Q | 79 | LU1-S8624-B-Q | 81 | MC1-74S2 | 45, 46 |
| LU1-S11430-A-Q | 78 | LU1-S4836-B-Q | 79 | LU1-S8630-A-Q | 82 | MC1-74S2V | 46 |
| LU1-S11430-B-Q | 78 | LU1-S5018-A-Q | 80 | LU1-S8630-B-Q | 82 | MC1-80H1 | 47, 48 |
| LU1-S11436-A-Q | 79 | LU1-S5018-B-Q | 80 | LU1-S8636-A-Q | 83 | MC1-80H1V | 48 |
| LU1-S11436-B-Q | 79 | LU1-S5024-A-Q | 81 | LU1-S8636-B-Q | 83 | MC1-80S2 | 45, 46 |
| LU1-S11618-A-Q | 80 | LU1-S5024-B-Q | 81 | LU1-S9036-A-Q | 79 | MC1-80S2V | 46 |
| LU1-S11618-B-Q | 80 | LU1-S5030-A-Q | 82 | LU1-S9036-B-Q | 79 | MC1-C30Q | 49 |
| LU1-S11624-A-Q | 81 | LU1-S5030-B-Q | 82 | LU1-S9218-A-Q | 80 | MC1-C39Q | 49 |
| LU1-S11624-B-Q | 81 | LU1-S5036-A-Q | 83 | LU1-S9218-B-Q | 80 | MC1-C42Q | 49 |
| LU1-S11630-A-Q | 82 | LU1-S5036-B-Q | 83 | LU1-S9224-A-Q | 81 | MC1-C48Q | 49 |
| LU1-S11630-B-Q | 82 | LU1-S5436-A-Q | 79 | LU1-S9224-B-Q | 81 | MC1-C56Q | 49 |
| LU1-S11636-A-Q | 83 | LU1-S5436-B-Q | 79 | LU1-S9230-A-Q | 82 | MC1-C64Q | 49 |
| LU1-S11636-B-Q | 83 | LU1-S5618-A-Q | 80 | LU1-S9230-B-Q | 82 | MC1-C74Q | 49 |
| LU1-S12030-A-Q | 78 | LU1-S5618-B-Q | 80 | LU1-S9236-A-Q | 83 | MC1-C80Q | 49 |
| LU1-S12030-B-Q | 78 | LU1-S5624-A-Q | 81 | LU1-S9236-B-Q | 83 | MK4-K10226-P/V-Q | 92 |
| LU1-S12036-A-Q | 79 | LU1-S5624-B-Q | 81 | LU1-S9636-A-Q | 79 | MK4-K10826-P/V-Q | 92 |
| LU1-S12036-B-Q | 79 | LU1-S5630-A-Q | 82 | LU1-S9636-B-Q | 79 | MK4-K11426-P/V-Q | 92 |
| LU1-S1818-A-Q | 76 | LU1-S5630-B-Q | 82 | LU1-S9818-A-Q | 80 | MK4-K12026-P/V-Q | 92 |
| LU1-S1818-B-Q | 76 | LU1-S5636-A-Q | 83 | LU1-S9818-B-Q | 80 | MK4-K1826-P/V-Q | 92 |
| LU1-S1824-A-Q | 77 | LU1-S5636-B-Q | 83 | LU1-S9824-A-Q | 81 | MK4-K2426-P/V-Q | 92 |
| LU1-S1824-B-Q | 77 | LU1-S6036-A-Q | 79 | LU1-S9824-B-Q | 81 | MK4-K3026-P/V-Q | 92 |
| LU1-S1830-A-Q | 78 | LU1-S6036-B-Q | 79 | LU1-S9830-A-Q | 82 | MK4-K3626-P/V-Q | 92 |
| LU1-S1830-B-Q | 78 | LU1-S6218-A-Q | 80 | LU1-S9830-B-Q | 82 | MK4-K4226-P/V-Q | 92 |
| LU1-S2018-A-Q | 80 | LU1-S6218-B-Q | 80 | LU1-S9836-A-Q | 83 | MK4-K4826-P/V-Q | 92 |
| LU1-S2018-B-Q | 80 | LU1-S6224-A-Q | 81 | LU1-S9836-B-Q | 83 | MK4-K5426-P/V-Q | 92 |
| LU1-S2024-A-Q | 81 | LU1-S6224-B-Q | 81 | LU1-W30A-(L/R)-Q | 89 | MK4-K8426-P/V-Q | 92 |
| LU1-S2024-B-Q | 81 | LU1-S6230-A-Q | 82 | LU1-W36A-(L/R)-Q | 89 | MK4-K9026-P/V-Q | 92 |
| LU1-S2030-A-Q | 82 | LU1-S6230-B-Q | 82 | LU1-W42A-(L/R)-Q | 89 | MK4-K9626-P/V-Q | 92 |
| LU1-S2030-B-Q | 82 | LU1-S6236-A-Q | 83 | LU1-W48A-(L/R)-Q | 89 | MK4-R10226-P/V-L/R-Q | 93 |
| LU1-S2418-A-Q | 76 | LU1-S6236-B-Q | 83 | LU1-W54A-(L/R)-Q | 89 | MK4-R10826-P/V-L/R-Q | 93 |
| LU1-S2418-B-Q | 76 | LU1-S6636-A-Q | 79 | LU1-W60A-(L/R)-Q | 89 | MK4-R11426-P/V-L/R-Q | 93 |
| LU1-S2430-A-Q | 78 | LU1-S6636-B-Q | 79 | LU1-W66A-(L/R)-Q | 89 | MK4-R12026-P/V-L/R-Q | 93 |
| LU1-S2430-B-Q | 78 | LU1-S6818-A-Q | 80 | LU1-W72A-(L/R)-Q | 89 | MK4-R1826-P/V-L/R-Q | 93 |
| LU1-S2618-A-Q | 80 | LU1-S6818-B-Q | 80 | LU1-W78A-(L/R)-Q | 89 | MK4-R2426-P/V-L/R-Q | 93 |

| <i>pattern no.</i> | <i>page</i> | <i>pattern no.</i> | <i>page</i> | <i>pattern no.</i> | <i>page</i> | <i>pattern no.</i> | <i>page</i> |
|---------------------|-------------|--------------------|-------------|--------------------|-------------|--------------------|-------------|
| MK4-R5426-P/V-L/R-Q | 93 | MS2-U11413-H-Q | 96 | MU1-C4872DD-Q | 73 | MU1-S10218-A-Q | 62 |
| MK4-R7826-P/V-L/R-Q | 93 | MS2-U11413-Q | 96 | MU1-C6042DD-Q | 73 | MU1-S10218-B-Q | 62 |
| MK4-R8426-P/V-L/R-Q | 93 | MS2-U12013-H-Q | 96 | MU1-C6042DS-Q | 73 | MU1-S10224-A-Q | 63 |
| MK4-R9026-P/V-L/R-Q | 93 | MS2-U12013-Q | 96 | MU1-C6042SD-Q | 72 | MU1-S10224-B-Q | 63 |
| MK4-R9626-P/V-L/R-Q | 93 | MS2-U5413-H-Q | 96 | MU1-C6042SS-Q | 72 | MU1-S10230-A-Q | 64 |
| MK4-T10226-P/V-Q | 92 | MS2-U5413-Q | 96 | MU1-C6048DD-Q | 73 | MU1-S10230-B-Q | 64 |
| MK4-T10826-P/V-Q | 92 | MS2-U9613-H-Q | 96 | MU1-C6642DD-Q | 73 | MU1-S10236-B-Q | 65 |
| MK4-T11426-P/V-Q | 92 | MS2-U9613-Q | 96 | MU1-C6642DS-Q | 73 | MU1-S10236-R-Q | 65 |
| MK4-T12026-P/V-Q | 92 | MS2-W10213-H-Q | 95 | MU1-C6642SD-Q | 72 | MU1-S10418-A-Q | 66 |
| MK4-T1826-P/V-Q | 92 | MS2-W10213-Q | 95 | MU1-C6642SS-Q | 72 | MU1-S10418-B-Q | 66 |
| MK4-T2426-P/V-Q | 92 | MS2-W10813-H-Q | 95 | MU1-C6648DD-Q | 73 | MU1-S10424-A-Q | 67 |
| MK4-T3026-P/V-Q | 92 | MS2-W10813-Q | 95 | MU1-C6648DS-Q | 73 | MU1-S10424-B-Q | 67 |
| MK4-T3626-P/V-Q | 92 | MS2-W11413-H-Q | 95 | MU1-C6648SD-Q | 72 | MU1-S10430-A-Q | 68 |
| MK4-T4226-P/V-Q | 92 | MS2-W11413-Q | 95 | MU1-C6648SS-Q | 72 | MU1-S10430-B-Q | 68 |
| MK4-T4826-P/V-Q | 92 | MS2-W12013-H-Q | 95 | MU1-C7242DD-Q | 73 | MU1-S10436-B-Q | 69 |
| MK4-T5426-P/V-Q | 92 | MS2-W12013-Q | 95 | MU1-C7242DS-Q | 73 | MU1-S10436-R-Q | 69 |
| MK4-T8426-P/V-Q | 92 | MS2-W5413-H-Q | 95 | MU1-C7242SD-Q | 72 | MU1-S10818-A-Q | 62 |
| MK4-T9026-P/V-Q | 92 | MS2-W5413-Q | 95 | MU1-C7242SS-Q | 72 | MU1-S10818-B-Q | 62 |
| MK4-T9626-P/V-Q | 92 | MS2-W9613-H-Q | 95 | MU1-C7248DD-Q | 73 | MU1-S10824-A-Q | 63 |
| MK4-V2448-P/V-Q | 91 | MS2-W9613-Q | 95 | MU1-J24A-L-Q | 74 | MU1-S10824-B-Q | 63 |
| MK4-V2648-P/V-Q | 91 | MT1-30S2 | 50, 51 | MU1-J24A-R-Q | 74 | MU1-S10830-A-Q | 64 |
| MK4-X2448-P/V-Q | 91 | MT1-30S2V | 51 | MU1-J30A-L-Q | 74 | MU1-S10830-B-Q | 64 |
| MK4-X2648-P/V-Q | 91 | MT1-39S2 | 50, 51 | MU1-J30A-R-Q | 74 | MU1-S10836-B-Q | 65 |
| MM3-IS42F-Q | 94 | MT1-39S2V | 51 | MU1-J36A-L-Q | 74 | MU1-S10836-R-Q | 65 |
| MM3-IS48F-Q | 94 | MT1-42S2 | 50, 51 | MU1-J36A-R-Q | 74 | MU1-S11018-A-Q | 66 |
| MM3-IS54F-Q | 94 | MT1-42S2V | 51 | MU1-J42A-L-Q | 74 | MU1-S11018-B-Q | 66 |
| MM3-IS54R-Q | 94 | MT1-48S2 | 50, 51 | MU1-J42A-R-Q | 74 | MU1-S11024-A-Q | 67 |
| MM3-IS84F-Q | 94 | MT1-48S2V | 51 | MU1-J48A-L-Q | 74 | MU1-S11024-B-Q | 67 |
| MM3-IS84R-Q | 94 | MT1-56S2 | 50, 51 | MU1-J48A-R-Q | 74 | MU1-S11030-A-Q | 68 |
| MM3-IS90F-Q | 94 | MT1-56S2V | 51 | MU1-J54A-L-Q | 74 | MU1-S11030-B-Q | 68 |
| MM3-IS90R-Q | 94 | MT1-64S2 | 50, 51 | MU1-J54A-R-Q | 74 | MU1-S11036-B-Q | 69 |
| MM3-IS96F-Q | 94 | MT1-64S2V | 51 | MU1-J60A-L-Q | 74 | MU1-S11036-R-Q | 69 |
| MM3-IS96R-Q | 94 | MT1-74S2 | 50, 51 | MU1-J60A-R-Q | 74 | MU1-S11418-A-Q | 62 |
| MN2T5E19 | 100 | MT1-74S2V | 51 | MU1-J66A-L-Q | 74 | MU1-S11418-B-Q | 62 |
| MN2T5E25 | 100 | MT1-80S2 | 50, 51 | MU1-J66A-R-Q | 74 | MU1-S11424-A-Q | 63 |
| MN2T5E37 | 100 | MT1-80S2V | 51 | MU1-J72A-L-Q | 74 | MU1-S11424-B-Q | 63 |
| MN2T5E49 | 100 | MT5-CS2 | 49 | MU1-J72A-R-Q | 74 | MU1-S11430-A-Q | 64 |
| MO8-24 | 97 | MU1-C4242DD-Q | 73 | MU1-J78A-L-Q | 74 | MU1-S11430-B-Q | 64 |
| MO8-N24 | 97 | MU1-C4242DS-Q | 73 | MU1-J78A-R-Q | 74 | MU1-S11436-B-Q | 65 |
| MP2-CPP | 49 | MU1-C4242SD-Q | 72 | MU1-J84A-L-Q | 74 | MU1-S11436-R-Q | 65 |
| MP3-W0818-C/S/T-Q | 44 | MU1-C4248DD-Q | 73 | MU1-J84A-R-Q | 74 | MU1-S11618-A-Q | 66 |
| MP3-W0824-C/S/T-Q | 44 | MU1-C4248DS-Q | 73 | MU1-J90A-L-Q | 74 | MU1-S11618-B-Q | 66 |
| MP3-W0830-C/S/T-Q | 44 | MU1-C4248SD-Q | 72 | MU1-J90A-R-Q | 74 | MU1-S11624-A-Q | 67 |
| MP3-W0836-C/S/T-Q | 44 | MU1-C4248SS-Q | 72 | MU1-J96A-L-Q | 74 | MU1-S11624-B-Q | 67 |
| MP3-W0842-C/S/T-Q | 44 | MU1-C4260DD-Q | 73 | MU1-J96A-R-Q | 74 | MU1-S11630-A-Q | 68 |
| MP3-W0848-C/S/T-Q | 44 | MU1-C4260DS-Q | 73 | MU1-P66DA-L-Q | 71 | MU1-S11630-B-Q | 68 |
| MP3-W0860-C/S/T-Q | 44 | MU1-C4260SD-Q | 72 | MU1-P66DA-R-Q | 71 | MU1-S11636-B-Q | 69 |
| MP3-W1418-C/S/T-Q | 44 | MU1-C4260SS-Q | 72 | MU1-P66SA-L-Q | 71 | MU1-S11636-R-Q | 69 |
| MP3-W1424-C/S/T-Q | 44 | MU1-C4266DD-Q | 73 | MU1-P66SA-R-Q | 71 | MU1-S12018-A-Q | 62 |
| MP3-W1430-C/S/T-Q | 44 | MU1-C4266DS-Q | 73 | MU1-P72DA-L-Q | 71 | MU1-S12018-B-Q | 62 |
| MP3-W1436-C/S/T-Q | 44 | MU1-C4266SD-Q | 72 | MU1-P72DA-R-Q | 71 | MU1-S12024-A-Q | 63 |
| MP3-W1442-C/S/T-Q | 44 | MU1-C4266SS-Q | 72 | MU1-P78SA-L-Q | 71 | MU1-S12024-B-Q | 63 |
| MP3-W1448-C/S/T-Q | 44 | MU1-C4272DD-Q | 73 | MU1-P78SA-R-Q | 71 | MU1-S12030-A-Q | 64 |
| MP3-W1460-C/S/T-Q | 44 | MU1-C4272DS-Q | 73 | MU1-R6636-B-Q | 70 | MU1-S12030-B-Q | 64 |
| MP3-W2618-C/S/T-Q | 44 | MU1-C4272SD-Q | 72 | MU1-R6636-E-Q | 70 | MU1-S12036-B-Q | 65 |
| MP3-W2624-C/S/T-Q | 44 | MU1-C4272SS-Q | 72 | MU1-R6636-R-Q | 70 | MU1-S12036-R-Q | 65 |
| MP3-W2630-C/S/T-Q | 44 | MU1-C4842DD-Q | 73 | MU1-R7836-B-Q | 70 | MU1-S1818-A-Q | 62 |
| MP3-W2636-C/S/T-Q | 44 | MU1-C4842DS-Q | 73 | MU1-R7836-E-Q | 70 | MU1-S1818-B-Q | 62 |
| MP3-W2642-C/S/T-Q | 44 | MU1-C4842SD-Q | 72 | MU1-R7836-R-Q | 70 | MU1-S1824-A-Q | 63 |
| MP3-W2648-C/S/T-Q | 44 | MU1-C4842SS-Q | 72 | MU1-R8730-B-Q | 70 | MU1-S1824-B-Q | 63 |
| MP3-W2660-C/S/T-Q | 44 | MU1-C4860DD-Q | 73 | MU1-R8730-E-Q | 70 | MU1-S1830-A-Q | 64 |
| MS2-U10213-H-Q | 96 | MU1-C4866DD-Q | 73 | MU1-R8730-R-Q | 70 | MU1-S1830-B-Q | 64 |
| MS2-U10213-Q | 96 | MU1-C4866DS-Q | 73 | MU1-R9036-B-Q | 70 | MU1-S2018-A-Q | 66 |
| MS2-U10813-H-Q | 96 | MU1-C4866SD-Q | 72 | MU1-R9036-E-Q | 70 | MU1-S2018-B-Q | 66 |
| MS2-U10813-Q | 96 | MU1-C4866SS-Q | 72 | MU1-R9036-R-Q | 70 | MU1-S2024-A-Q | 67 |

| <i>pattern no.</i> | <i>page</i> | <i>pattern no.</i> | <i>page</i> | <i>pattern no.</i> | <i>page</i> | <i>pattern no.</i> | <i>page</i> |
|--------------------|-------------|--------------------|-------------|--------------------|-------------|--------------------|-------------|
| MU1-S2024-B-Q | 67 | MU1-S6036-R-Q | 65 | MU1-S9236-B-Q | 69 | MW2-S11418-B-Q | 54 |
| MU1-S2030-A-Q | 68 | MU1-S6218-A-Q | 66 | MU1-S9236-R-Q | 69 | MW2-S11424-A-Q | 55 |
| MU1-S2030-B-Q | 68 | MU1-S6218-B-Q | 66 | MU1-S9618-A-Q | 62 | MW2-S11424-B-Q | 55 |
| MU1-S2418-A-Q | 62 | MU1-S6224-A-Q | 67 | MU1-S9618-B-Q | 62 | MW2-S11430-A-Q | 56 |
| MU1-S2430-A-Q | 64 | MU1-S6224-B-Q | 67 | MU1-S9636-B-Q | 65 | MW2-S11430-B-Q | 56 |
| MU1-S2430-B-Q | 64 | MU1-S6230-A-Q | 68 | MU1-S9636-R-Q | 65 | MW2-S11436-B-Q | 57 |
| MU1-S2618-A-Q | 66 | MU1-S6230-B-Q | 68 | MU1-S9818-A-Q | 66 | MW2-S11436-R-Q | 57 |
| MU1-S2618-B-Q | 66 | MU1-S6236-B-Q | 69 | MU1-S9818-B-Q | 66 | MW2-S11618-A-Q | 58 |
| MU1-S2624-A-Q | 67 | MU1-S6236-R-Q | 69 | MU1-S9824-A-Q | 67 | MW2-S11618-B-Q | 58 |
| MU1-S2624-B-Q | 67 | MU1-S6618-A-Q | 62 | MU1-S9824-B-Q | 67 | MW2-S11624-A-Q | 59 |
| MU1-S2630-A-Q | 68 | MU1-S6636-B-Q | 65 | MU1-S9830-A-Q | 68 | MW2-S11624-B-Q | 59 |
| MU1-S2630-B-Q | 68 | MU1-S6636-R-Q | 65 | MU1-S9830-B-Q | 68 | MW2-S11630-A-Q | 60 |
| MU1-S3018-A-Q | 62 | MU1-S6818-A-Q | 66 | MU1-S9836-B-Q | 69 | MW2-S11630-B-Q | 60 |
| MU1-S3218-A-Q | 66 | MU1-S6818-B-Q | 66 | MU1-S9836-R-Q | 69 | MW2-S11636-B-Q | 61 |
| MU1-S3218-B-Q | 66 | MU1-S6824-A-Q | 67 | MU1-W30A-L-Q | 75 | MW2-S11636-R-Q | 61 |
| MU1-S3224-A-Q | 67 | MU1-S6824-B-Q | 67 | MU1-W30A-R-Q | 75 | MW2-S12018-A-Q | 54 |
| MU1-S3224-B-Q | 67 | MU1-S6830-A-Q | 68 | MU1-W54A-L-Q | 75 | MW2-S12018-B-Q | 54 |
| MU1-S3230-A-Q | 68 | MU1-S6830-B-Q | 68 | MU1-W54A-R-Q | 75 | MW2-S12024-A-Q | 55 |
| MU1-S3230-B-Q | 68 | MU1-S6836-B-Q | 69 | MU1-W60A-L-Q | 75 | MW2-S12024-B-Q | 55 |
| MU1-S3618-A-Q | 62 | MU1-S6836-R-Q | 69 | MU1-W60A-R-Q | 75 | MW2-S12030-A-Q | 56 |
| MU1-S3636-B-Q | 65 | MU1-S7218-A-Q | 62 | MU1-W66A-L-Q | 75 | MW2-S12030-B-Q | 56 |
| MU1-S3636-R-Q | 65 | MU1-S7236-B-Q | 65 | MU1-W66A-R-Q | 75 | MW2-S12036-B-Q | 57 |
| MU1-S3818-A-Q | 66 | MU1-S7236-R-Q | 65 | MU1-W72A-L-Q | 75 | MW2-S12036-R-Q | 57 |
| MU1-S3818-B-Q | 66 | MU1-S7418-A-Q | 66 | MU1-W72A-R-Q | 75 | MW2-S1818-A-Q | 54 |
| MU1-S3824-A-Q | 67 | MU1-S7418-B-Q | 66 | MU1-W78A-L-Q | 75 | MW2-S1818-B-Q | 54 |
| MU1-S3824-B-Q | 67 | MU1-S7424-A-Q | 67 | MU1-W78A-R-Q | 75 | MW2-S1824-A-Q | 55 |
| MU1-S3830-A-Q | 68 | MU1-S7424-B-Q | 67 | MU1-W84A-L-Q | 75 | MW2-S1824-B-Q | 55 |
| MU1-S3830-B-Q | 68 | MU1-S7430-A-Q | 68 | MU1-W84A-R-Q | 75 | MW2-S1830-A-Q | 56 |
| MU1-S3836-B-Q | 69 | MU1-S7430-B-Q | 68 | MU1-W90A-L-Q | 75 | MW2-S1830-B-Q | 56 |
| MU1-S3836-R-Q | 69 | MU1-S7436-B-Q | 69 | MU1-W90A-R-Q | 75 | MW2-S2018-A-Q | 58 |
| MU1-S4218-A-Q | 62 | MU1-S7436-R-Q | 69 | MU1-W96A-L-Q | 75 | MW2-S2018-B-Q | 58 |
| MU1-S4236-B-Q | 65 | MU1-S7818-A-Q | 62 | MU1-W96A-R-Q | 75 | MW2-S2024-A-Q | 59 |
| MU1-S4236-R-Q | 65 | MU1-S7818-B-Q | 62 | MW2-S10218-A-Q | 54 | MW2-S2024-B-Q | 59 |
| MU1-S4418-A-Q | 66 | MU1-S7836-B-Q | 65 | MW2-S10218-B-Q | 54 | MW2-S2030-A-Q | 60 |
| MU1-S4418-B-Q | 66 | MU1-S7836-R-Q | 65 | MW2-S10224-A-Q | 55 | MW2-S2030-B-Q | 60 |
| MU1-S4424-A-Q | 67 | MU1-S8018-A-Q | 66 | MW2-S10224-B-Q | 55 | MW2-S2418-A-Q | 54 |
| MU1-S4424-B-Q | 67 | MU1-S8018-B-Q | 66 | MW2-S10230-A-Q | 56 | MW2-S2418-B-Q | 54 |
| MU1-S4430-A-Q | 68 | MU1-S8024-A-Q | 67 | MW2-S10230-B-Q | 56 | MW2-S2430-A-Q | 56 |
| MU1-S4430-B-Q | 68 | MU1-S8024-B-Q | 67 | MW2-S10236-B-Q | 57 | MW2-S2430-B-Q | 56 |
| MU1-S4436-B-Q | 69 | MU1-S8030-A-Q | 68 | MW2-S10236-R-Q | 57 | MW2-S2618-A-Q | 58 |
| MU1-S4436-R-Q | 69 | MU1-S8030-B-Q | 68 | MW2-S10418-A-Q | 58 | MW2-S2618-B-Q | 58 |
| MU1-S4818-A-Q | 62 | MU1-S8036-B-Q | 69 | MW2-S10418-B-Q | 58 | MW2-S2624-A-Q | 59 |
| MU1-S4836-B-Q | 65 | MU1-S8036-R-Q | 69 | MW2-S10424-A-Q | 59 | MW2-S2624-B-Q | 59 |
| MU1-S4836-R-Q | 65 | MU1-S8418-A-Q | 62 | MW2-S10424-B-Q | 59 | MW2-S2630-A-Q | 60 |
| MU1-S5018-A-Q | 66 | MU1-S8418-B-Q | 62 | MW2-S10430-A-Q | 60 | MW2-S2630-B-Q | 60 |
| MU1-S5018-B-Q | 66 | MU1-S8436-B-Q | 65 | MW2-S10430-B-Q | 60 | MW2-S3018-A-Q | 54 |
| MU1-S5024-A-Q | 67 | MU1-S8436-R-Q | 65 | MW2-S10436-B-Q | 61 | MW2-S3218-A-Q | 58 |
| MU1-S5024-B-Q | 67 | MU1-S8618-A-Q | 66 | MW2-S10436-R-Q | 61 | MW2-S3218-B-Q | 58 |
| MU1-S5030-A-Q | 68 | MU1-S8618-B-Q | 66 | MW2-S10818-A-Q | 54 | MW2-S3224-A-Q | 59 |
| MU1-S5030-B-Q | 68 | MU1-S8624-A-Q | 67 | MW2-S10818-B-Q | 54 | MW2-S3224-B-Q | 59 |
| MU1-S5036-B-Q | 69 | MU1-S8624-B-Q | 67 | MW2-S10824-A-Q | 55 | MW2-S3230-A-Q | 60 |
| MU1-S5036-R-Q | 69 | MU1-S8630-A-Q | 68 | MW2-S10824-B-Q | 55 | MW2-S3230-B-Q | 60 |
| MU1-S5418-A-Q | 62 | MU1-S8630-B-Q | 68 | MW2-S10830-A-Q | 56 | MW2-S3618-A-Q | 54 |
| MU1-S5436-B-Q | 65 | MU1-S8636-B-Q | 69 | MW2-S10830-B-Q | 56 | MW2-S3636-B-Q | 57 |
| MU1-S5436-R-Q | 65 | MU1-S8636-R-Q | 69 | MW2-S10836-B-Q | 57 | MW2-S3636-R-Q | 57 |
| MU1-S5618-A-Q | 66 | MU1-S9018-A-Q | 62 | MW2-S10836-R-Q | 57 | MW2-S3818-A-Q | 58 |
| MU1-S5618-B-Q | 66 | MU1-S9018-B-Q | 62 | MW2-S11018-A-Q | 58 | MW2-S3818-B-Q | 58 |
| MU1-S5624-A-Q | 67 | MU1-S9036-B-Q | 65 | MW2-S11018-B-Q | 58 | MW2-S3824-A-Q | 59 |
| MU1-S5624-B-Q | 67 | MU1-S9036-R-Q | 65 | MW2-S11024-A-Q | 59 | MW2-S3824-B-Q | 59 |
| MU1-S5630-A-Q | 68 | MU1-S9218-A-Q | 66 | MW2-S11024-B-Q | 59 | MW2-S3830-A-Q | 60 |
| MU1-S5630-B-Q | 68 | MU1-S9218-B-Q | 66 | MW2-S11030-A-Q | 60 | MW2-S3830-B-Q | 60 |
| MU1-S5636-B-Q | 69 | MU1-S9224-A-Q | 67 | MW2-S11030-B-Q | 60 | MW2-S3836-B-Q | 61 |
| MU1-S5636-R-Q | 69 | MU1-S9224-B-Q | 67 | MW2-S11036-B-Q | 61 | MW2-S3836-R-Q | 61 |
| MU1-S6018-A-Q | 62 | MU1-S9230-A-Q | 68 | MW2-S11036-R-Q | 61 | MW2-S4218-A-Q | 54 |
| MU1-S6036-B-Q | 65 | MU1-S9230-B-Q | 68 | MW2-S11418-A-Q | 54 | MW2-S4236-B-Q | 57 |

| <i>pattern no.</i> | <i>page</i> | <i>pattern no.</i> | <i>page</i> | <i>pattern no.</i> | <i>page</i> | <i>pattern no.</i> | <i>page</i> |
|--------------------|-------------|--------------------|-------------|------------------------|-------------|------------------------|-------------|
| MW2-S4236-R-Q | 57 | MW2-S8024-B-Q | 59 | QAFPDR11 | 183 | QR3B0P (11/22/33) 3430 | 104 |
| MW2-S4418-A-Q | 58 | MW2-S8030-A-Q | 60 | QAFPDR20 | 183 | QR3B0P (11/22/33) 3436 | 104 |
| MW2-S4418-B-Q | 58 | MW2-S8030-B-Q | 60 | QAFPDR21 | 183 | QR3B0P (11/22/33) 3442 | 104 |
| MW2-S4424-A-Q | 59 | MW2-S8036-B-Q | 61 | QAFPO10W | 183 | QR3B0P (11/22/33) 3448 | 104 |
| MW2-S4424-B-Q | 59 | MW2-S8036-R-Q | 61 | QAFPO11W | 183 | QR3B0P (11/22/33) 4218 | 104 |
| MW2-S4430-A-Q | 60 | MW2-S8418-A-Q | 54 | QAFPO12W | 183 | QR3B0P (11/22/33) 4220 | 104 |
| MW2-S4430-B-Q | 60 | MW2-S8418-B-Q | 54 | QAFPO13W | 183 | QR3B0P (11/22/33) 4224 | 104 |
| MW2-S4436-B-Q | 61 | MW2-S8436-B-Q | 57 | QAFPO20W | 183 | QR3B0P (11/22/33) 4230 | 104 |
| MW2-S4436-R-Q | 61 | MW2-S8436-R-Q | 57 | QAFPO21W | 183 | QR3B0P (11/22/33) 4236 | 104 |
| MW2-S4818-A-Q | 54 | MW2-S8618-A-Q | 58 | QAFPO22W | 183 | QR3B0P (11/22/33) 4242 | 104 |
| MW2-S4836-B-Q | 57 | MW2-S8618-B-Q | 58 | QAFPO23W | 183 | QR3B0P (11/22/33) 4248 | 104 |
| MW2-S4836-R-Q | 57 | MW2-S8624-A-Q | 59 | QAW1T43030 | 181 | QR3B0P (11/22/33) 4260 | 104 |
| MW2-S5018-A-Q | 58 | MW2-S8624-B-Q | 59 | QAW1T43636 | 181 | QR3B0P (11/22/33) 4266 | 104 |
| MW2-S5018-B-Q | 58 | MW2-S8630-A-Q | 60 | QAW1T44242 | 181 | QR3B0P (11/22/33) 4272 | 104 |
| MW2-S5024-A-Q | 59 | MW2-S8630-B-Q | 60 | QAW1T44830 | 181 | QR3B0P (11/22/33) 4918 | 104 |
| MW2-S5024-B-Q | 59 | MW2-S8636-B-Q | 61 | QAW1T44848 | 181 | QR3B0P (11/22/33) 4920 | 104 |
| MW2-S5030-A-Q | 60 | MW2-S8636-R-Q | 61 | QAW1T46030 | 181 | QR3B0P (11/22/33) 4924 | 104 |
| MW2-S5030-B-Q | 60 | MW2-S9018-A-Q | 54 | QAW1T47230 | 181 | QR3B0P (11/22/33) 4930 | 104 |
| MW2-S5036-B-Q | 61 | MW2-S9018-B-Q | 54 | QAW1T47236 | 181 | QR3B0P (11/22/33) 4936 | 104 |
| MW2-S5036-R-Q | 61 | MW2-S9036-B-Q | 57 | QAW1TR24 | 181 | QR3B0P (11/22/33) 4942 | 104 |
| MW2-S5418-A-Q | 54 | MW2-S9036-R-Q | 57 | QAW1TR30 | 181 | QR3B0P (11/22/33) 4948 | 104 |
| MW2-S5436-B-Q | 57 | MW2-S9218-A-Q | 58 | QAW1TR36 | 181 | QR3B0P (11/22/33) 4960 | 104 |
| MW2-S5436-R-Q | 57 | MW2-S9218-B-Q | 58 | QAW1TR42 | 181 | QR3B0P (11/22/33) 4966 | 104 |
| MW2-S5618-A-Q | 58 | MW2-S9224-A-Q | 59 | QAW1TR48 | 181 | QR3B0P (11/22/33) 4972 | 104 |
| MW2-S5618-B-Q | 58 | MW2-S9224-B-Q | 59 | QDMRD6436(L/R)()-L | 52 | QR3B0P (11/22/33) 6418 | 105 |
| MW2-S5624-A-Q | 59 | MW2-S9230-A-Q | 60 | QDMRD6436(L/R)()-N | 52 | QR3B0P (11/22/33) 6420 | 105 |
| MW2-S5624-B-Q | 59 | MW2-S9230-B-Q | 60 | QDMRD6442(L/R)()-L | 52 | QR3B0P (11/22/33) 6424 | 105 |
| MW2-S5630-A-Q | 60 | MW2-S9236-B-Q | 61 | QDMRD6442(L/R)()-N | 52 | QR3B0P (11/22/33) 6430 | 105 |
| MW2-S5630-B-Q | 60 | MW2-S9236-R-Q | 61 | QDMRD6448(L/R)()-L | 52 | QR3B0P (11/22/33) 6436 | 105 |
| MW2-S5636-B-Q | 61 | MW2-S9618-A-Q | 54 | QDMRD6448(L/R)()-N | 52 | QR3B0P (11/22/33) 6442 | 105 |
| MW2-S5636-R-Q | 61 | MW2-S9618-B-Q | 54 | QDMRD7836(L/R)()-L | 52 | QR3B0P (11/22/33) 6448 | 105 |
| MW2-S6018-A-Q | 54 | MW2-S9636-B-Q | 57 | QDMRD7836(L/R)()-N | 52 | QR3B0P (11/22/33) 6460 | 105 |
| MW2-S6036-B-Q | 57 | MW2-S9636-R-Q | 57 | QDMRD7842(L/R)()-L | 52 | QR3B0P (11/22/33) 6466 | 105 |
| MW2-S6036-R-Q | 57 | MW2-S9818-A-Q | 58 | QDMRD7842(L/R)()-N | 52 | QR3B0P (11/22/33) 6472 | 105 |
| MW2-S6218-A-Q | 58 | MW2-S9818-B-Q | 58 | QDMRD7848(L/R)()-L | 52 | QR3B0P (11/22/33) 7918 | 105 |
| MW2-S6218-B-Q | 58 | MW2-S9824-A-Q | 59 | QDMRD7848(L/R)()-N | 52 | QR3B0P (11/22/33) 7920 | 105 |
| MW2-S6224-A-Q | 59 | MW2-S9824-B-Q | 59 | QDMRDFT36 | 52 | QR3B0P (11/22/33) 7924 | 105 |
| MW2-S6224-B-Q | 59 | MW2-S9830-A-Q | 60 | QDMRDFT42 | 52 | QR3B0P (11/22/33) 7930 | 105 |
| MW2-S6230-A-Q | 60 | MW2-S9830-B-Q | 60 | QDMRDFT48 | 52 | QR3B0P (11/22/33) 7936 | 105 |
| MW2-S6230-B-Q | 60 | MW2-S9836-B-Q | 61 | QR111JUK | 137 | QR3B0P (11/22/33) 7942 | 105 |
| MW2-S6236-B-Q | 61 | MW2-S9836-R-Q | 61 | QR111KUK | 137 | QR3B0P (11/22/33) 7948 | 105 |
| MW2-S6236-R-Q | 61 | MZ1-B2415 | 98 | QR112JUK | 137 | QR3B0P (11/22/33) 7960 | 105 |
| MW2-S6618-A-Q | 54 | MZ1-B2419 | 98 | QR112KUK | 137 | QR3B0P (11/22/33) 7966 | 105 |
| MW2-S6818-A-Q | 58 | MZ1-B2422 | 98 | QR113JUK | 137 | QR3B0P (11/22/33) 7972 | 105 |
| MW2-S6818-B-Q | 58 | QACDL720 | 182 | QR113KUK | 137 | QR3B0T (11/22/33) 3418 | 106 |
| MW2-S6824-A-Q | 59 | QACDL721 | 182 | QR2 SLAT 1518 | 108 | QR3B0T (11/22/33) 3420 | 106 |
| MW2-S6824-B-Q | 59 | QACDL820 | 182 | QR2 SLAT 1520 | 108 | QR3B0T (11/22/33) 3424 | 106 |
| MW2-S6830-A-Q | 60 | QACDL821 | 182 | QR2 SLAT 1524 | 108 | QR3B0T (11/22/33) 3430 | 106 |
| MW2-S6830-B-Q | 60 | QACDR720 | 182 | QR2 SLAT 1530 | 108 | QR3B0T (11/22/33) 3436 | 106 |
| MW2-S6836-B-Q | 61 | QACDR721 | 182 | QR2 SLAT 1536 | 108 | QR3B0T (11/22/33) 3442 | 106 |
| MW2-S6836-R-Q | 61 | QACDR820 | 182 | QR2 SLAT 1542 | 108 | QR3B0T (11/22/33) 3448 | 106 |
| MW2-S7218-A-Q | 54 | QACDR821 | 182 | QR2 SLAT 1548 | 108 | QR3B0T (11/22/33) 4218 | 106 |
| MW2-S7418-A-Q | 58 | QACG722WE | 182 | QR211JUK | 136 | QR3B0T (11/22/33) 4220 | 106 |
| MW2-S7418-B-Q | 58 | QACG723WE | 182 | QR211KUK | 136 | QR3B0T (11/22/33) 4224 | 106 |
| MW2-S7424-A-Q | 59 | QACG822WE | 182 | QR212JUK | 136 | QR3B0T (11/22/33) 4230 | 106 |
| MW2-S7424-B-Q | 59 | QACG823WE | 182 | QR212KUK | 136 | QR3B0T (11/22/33) 4236 | 106 |
| MW2-S7430-A-Q | 60 | QAFPD12 | 183 | QR213JUK | 136 | QR3B0T (11/22/33) 4242 | 106 |
| MW2-S7430-B-Q | 60 | QAFPD13 | 183 | QR213KUK | 136 | QR3B0T (11/22/33) 4248 | 106 |
| MW2-S7436-B-Q | 61 | QAFPD22 | 183 | QR2ES4215 | 110 | QR3B0T (11/22/33) 4918 | 106 |
| MW2-S7436-R-Q | 61 | QAFPD23 | 183 | QR2ES49158 | 110 | QR3B0T (11/22/33) 4920 | 106 |
| MW2-S7818-A-Q | 54 | QAFPD110 | 183 | QR2ES498 | 110 | QR3B0T (11/22/33) 4924 | 106 |
| MW2-S7818-B-Q | 54 | QAFPD111 | 183 | QR2ES648 | 110 | QR3B0T (11/22/33) 4930 | 106 |
| MW2-S8018-A-Q | 58 | QAFPD120 | 183 | QR3B0P (11/22/33) 3418 | 104 | QR3B0T (11/22/33) 4936 | 106 |
| MW2-S8018-B-Q | 58 | QAFPD121 | 183 | QR3B0P (11/22/33) 3420 | 104 | QR3B0T (11/22/33) 4942 | 106 |
| MW2-S8024-A-Q | 59 | QAFPDR10 | 183 | QR3B0P (11/22/33) 3424 | 104 | QR3B0T (11/22/33) 4948 | 106 |

| <i>pattern no.</i> | <i>page</i> | <i>pattern no.</i> | <i>page</i> | <i>pattern no.</i> | <i>page</i> | <i>pattern no.</i> | <i>page</i> |
|-------------------------|-------------|--------------------|-------------|--------------------|-------------|--------------------|-------------|
| QR3B0T (11/22/33) 6418 | 107 | QRC333DHF | 146, 147 | QRC732G | 144, 145 | QRCCDLA33660 | 120 |
| QR3B0T (11/22/33) 6420 | 107 | QRC333F | 140, 141 | QRC732P | 144, 145 | QRCCDLA33666 | 120 |
| QR3B0T (11/22/33) 6424 | 107 | QRC362DHF | 146, 147 | QRC733DHC | 153, 155 | QRCCDLA33690 | 120 |
| QR3B0T (11/22/33) 6430 | 107 | QRC362F | 140, 141 | QRC733DHH | 153, 156 | QRCCDLA34260 | 120 |
| QR3B0T (11/22/33) 6436 | 107 | QRC363DHF | 146, 147 | QRC733DHI | 154 | QRCCDLA34266 | 120 |
| QR3B0T (11/22/33) 6442 | 107 | QRC363F | 140, 141 | QRC733DHP | 154, 156 | QRCCDLA34272 | 120 |
| QR3B0T (11/22/33) 6448 | 107 | QRC612DHC (L/R) | 148, 150 | QRC733G | 144, 145 | QRCCDLA34278 | 120 |
| QR3B0T (11/22/33) 7918 | 107 | QRC612DHD (L/R) | 148 | QRC733P | 144, 145 | QRCCDLA34284 | 120 |
| QR3B0T (11/22/33) 7920 | 107 | QRC612DHP (L/R) | 149, 151 | QRC761B | 144, 145 | QRCCDLA34290 | 120 |
| QR3B0T (11/22/33) 7924 | 107 | QRC612G | 142, 143 | QRC761DHBM | 155 | QRCCDLA34296 | 120 |
| QR3B0T (11/22/33) 7930 | 107 | QRC612P | 142, 143 | QRC761DHBW | 152 | QRCCDLA34860 | 120 |
| QR3B0T (11/22/33) 7936 | 107 | QRC613DHC (L/R) | 148, 150 | QRC762DHC | 153, 155 | QRCCDLA34866 | 120 |
| QR3B0T (11/22/33) 7942 | 107 | QRC613DHD (L/R) | 148 | QRC762DHH | 153, 156 | QRCCDLA34872 | 120 |
| QR3B0T (11/22/33) 7948 | 107 | QRC613DHP (L/R) | 149, 151 | QRC762DHI | 154 | QRCCDLA34878 | 120 |
| QR3S (LL/11/22/33) 0818 | 108 | QRC613G | 142, 143 | QRC762DHP | 154, 156 | QRCCDLA34884 | 120 |
| QR3S (LL/11/22/33) 0820 | 108 | QRC613P | 142, 143 | QRC762G | 144, 145 | QRCCDLA34890 | 120 |
| QR3S (LL/11/22/33) 0824 | 108 | QRC632DHC | 148, 150 | QRC762P | 144, 145 | QRCCDLA34896 | 120 |
| QR3S (LL/11/22/33) 0830 | 108 | QRC632DHD | 148 | QRC763DHC | 153, 155 | QRCCDRA23660 | 121 |
| QR3S (LL/11/22/33) 0836 | 108 | QRC632DHE (L/R) | 148, 150 | QRC763DHH | 153, 156 | QRCCDRA23666 | 121 |
| QR3S (LL/11/22/33) 0842 | 108 | QRC632DHH | 149, 151 | QRC763DHI | 154 | QRCCDRA23690 | 121 |
| QR3S (LL/11/22/33) 0848 | 108 | QRC632DHI | 149 | QRC763DHP | 154, 156 | QRCCDRA24260 | 121 |
| QR3S (LL/11/22/33) 1518 | 108 | QRC632DHP | 149, 151 | QRC763G | 144, 145 | QRCCDRA24266 | 121 |
| QR3S (LL/11/22/33) 1520 | 108 | QRC632C | 142, 143 | QRC763P | 144, 145 | QRCCDRA24272 | 121 |
| QR3S (LL/11/22/33) 1524 | 108 | QRC632P | 142, 143 | QRCA 363623 | 126 | QRCCDRA24278 | 121 |
| QR3S (LL/11/22/33) 1530 | 108 | QRC633DHC | 148, 150 | QRCA 363632 | 126 | QRCCDRA24284 | 121 |
| QR3S (LL/11/22/33) 1536 | 108 | QRC633DHD | 148 | QRCA 364223 | 126 | QRCCDRA24290 | 121 |
| QR3S (LL/11/22/33) 1542 | 108 | QRC633DHE (L/R) | 148, 150 | QRCA 364232 | 126 | QRCCDRA24296 | 121 |
| QR3S (LL/11/22/33) 1548 | 108 | QRC633DHH | 149, 151 | QRCA 423623 | 126 | QRCCDRA24860 | 121 |
| QR9C7794 | 135 | QRC633DHI | 149 | QRCA 423632 | 126 | QRCCDRA24866 | 121 |
| QR9C7798 | 135 | QRC633DHP | 149, 151 | QRCA 424223 | 126 | QRCCDRA24872 | 121 |
| QR9C7801 | 135 | QRC633C | 142, 143 | QRCA 424232 | 126 | QRCCDRA24878 | 121 |
| QR9C7917 | 135 | QRC633P | 142, 143 | QRCA 424233 | 126 | QRCCDRA24884 | 121 |
| QR9C7919 | 135 | QRC662DHC | 148, 150 | QRCA 424823 | 126 | QRCCDRA24890 | 121 |
| QR9D5459 | 135 | QRC662DHD | 148 | QRCA 424832 | 126 | QRCCDRA24896 | 121 |
| QR9G0413 | 135 | QRC662DHE (L/R) | 148, 150 | QRCA 484223 | 126 | QRCCDRA33660 | 121 |
| QR9G1171 | 135 | QRC662DHH | 149, 151 | QRCA 484232 | 126 | QRCCDRA33666 | 121 |
| QR9G1173 | 135 | QRC662DHI | 149 | QRCA 484823 | 126 | QRCCDRA33690 | 121 |
| QR9G1295 | 135 | QRC662DHP | 149, 151 | QRCA 484832 | 126 | QRCCDRA34260 | 121 |
| QR9G1499 | 135 | QRC662C | 142, 143 | QRCA 484833 | 126 | QRCCDRA34266 | 121 |
| QR9G2826 | 135 | QRC662P | 142, 143 | QRCA 484833 | 126 | QRCCDRA34272 | 121 |
| QR9G6777 | 135 | QRC663DHC | 148, 150 | QRCA 484833 | 126 | QRCCDRA34278 | 121 |
| QR9G6778 | 135 | QRC663DHD | 148 | QRCA 484832 | 126 | QRCCDRA34284 | 121 |
| QR9G6779 | 135 | QRC663DHE (L/R) | 148, 150 | QRCA 484822 | 127 | QRCCDRA34290 | 121 |
| QR9G6780 | 135 | QRC663DHH | 149, 151 | QRCA 484833 | 127 | QRCCDRA34296 | 121 |
| QR9G6781 | 135 | QRC663DHI | 149 | QRCAWF484811 | 129 | QRCCDRA34860 | 121 |
| QR9G6782 | 135 | QRC663DHP | 149, 151 | QRCAWF484812 | 129 | QRCCDRA34866 | 121 |
| QRB102(M/H)(F/R) | 134 | QRC663C | 142, 143 | QRCAWF484821 | 129 | QRCCDRA34872 | 121 |
| QRB108(M/H)(F/R) | 134 | QRC663P | 142, 143 | QRCAWF484822 | 129 | QRCCDRA34878 | 121 |
| QRB114(M/H)(F/R) | 134 | QRC712DHC(L/R) | 153, 155 | QRCCDLA23660 | 120 | QRCCDRA34884 | 121 |
| QRB120(M/H)(F/R) | 134 | QRC712DHD (L/R) | 152 | QRCCDLA23666 | 120 | QRCCDRA34890 | 121 |
| QRB28MR | 134 | QRC712DHP(L/R) | 154, 156 | QRCCDLA23690 | 120 | QRCCDRA34896 | 121 |
| QRB34MR | 134 | QRC712G | 144, 145 | QRCCDLA24260 | 120 | QRCEAL223654 | 122 |
| QRB46MR | 134 | QRC712P | 144, 145 | QRCCDLA24266 | 120 | QRCEAL223666 | 122 |
| QRB58MR | 134 | QRC713DHC(L/R) | 153, 155 | QRCCDLA24272 | 120 | QRCEAL223678 | 122 |
| QRBC11 (L/R) | 128 | QRC713DHD (L/R) | 152 | QRCCDLA24278 | 120 | QRCEAL223684 | 122 |
| QRBDH102M(F/R) | 134 | QRC713DHP(L/R) | 154, 156 | QRCCDLA24284 | 120 | QRCEAL223690 | 122 |
| QRBDH108M(F/R) | 134 | QRC713G | 144, 145 | QRCCDLA24290 | 120 | QRCEAL223696 | 122 |
| QRBDH114M(F/R) | 134 | QRC713P | 144, 145 | QRCCDLA24296 | 120 | QRCEAL224254 | 122 |
| QRBDH120M(F/R) | 134 | QRC731B | 144, 145 | QRCCDLA24860 | 120 | QRCEAL224266 | 122 |
| QRBDH28MR | 134 | QRC731DHBM | 155 | QRCCDLA24866 | 120 | QRCEAL224278 | 122 |
| QRBDH34MR | 134 | QRC731DHBW | 152 | QRCCDLA24872 | 120 | QRCEAL224284 | 122 |
| QRBDH46MR | 134 | QRC732DHC | 153, 155 | QRCCDLA24878 | 120 | QRCEAL224290 | 122 |
| QRBDH58MR | 134 | QRC732DHH | 153, 156 | QRCCDLA24884 | 120 | QRCEAL224296 | 122 |
| QRC332DHF | 146, 147 | QRC732DHI | 154 | QRCCDLA24890 | 120 | QRCEAL224860 | 122 |
| QRC332F | 140, 141 | QRC732DHP | 154, 156 | QRCCDLA24896 | 120 | QRCEAL224866 | 122 |

| <i>pattern no.</i> | <i>page</i> | <i>pattern no.</i> | <i>page</i> | <i>pattern no.</i> | <i>page</i> | <i>pattern no.</i> | <i>page</i> |
|--------------------|-------------|--------------------|-------------|--------------------|-------------|--------------------|-------------|
| QRCEAL224878 | 122 | QRM9A7830 | 123 | QROAF78S0DH | 165 | QROA054T1 | 158 |
| QRCEAL224890 | 122 | QRM9A7836 | 123 | QROAF78S1 | 159 | QROA054T1DH | 166 |
| QRCEAR223654 | 122 | QRM9A8436 | 123 | QROAF78S1DH | 168 | QROA066T0 | 157 |
| QRCEAR223666 | 122 | QRM9A9636 | 123 | QROAF90S0 | 158 | QROA066T0DH | 163 |
| QRCEAR223678 | 122 | QRM9B5430 N | 124 | QROAF90S0DH | 165 | QROA066T1 | 158 |
| QRCEAR223684 | 122 | QRM9B5436 N | 124 | QROAF90S1 | 159 | QROA066T1DH | 166 |
| QRCEAR223690 | 122 | QRM9B6030 N | 124 | QROAF90S1DH | 168 | QROA078T0 | 157 |
| QRCEAR223696 | 122 | QRM9B6036 N | 124 | QROAH30T0 | 157 | QROA078T0DH | 163 |
| QRCEAR224254 | 122 | QRM9B6630 | 124 | QROAH30T0DH | 164 | QROA078T1 | 158 |
| QRCEAR224266 | 122 | QRM9B6636 | 124 | QROAH30T1 | 159 | QROA078T1DH | 166 |
| QRCEAR224278 | 122 | QRM9B7230 | 124 | QROAH30T1DH | 167 | QROA084T0 | 157 |
| QRCEAR224284 | 122 | QRM9B7236 | 124 | QROAH36T0 | 157 | QROA084T0DH | 163 |
| QRCEAR224290 | 122 | QRM9B7830 | 124 | QROAH36T0DH | 164 | QROA084T1 | 158 |
| QRCEAR224296 | 122 | QRM9B7836 | 124 | QROAH36T1 | 159 | QROA084T1DH | 166 |
| QRCEAR224860 | 122 | QRM9B8436 | 124 | QROAH36T1DH | 167 | QROBF30S0 | 161 |
| QRCEAR224866 | 122 | QRM9B9636 | 124 | QROAH42T0 | 157 | QROBF30S0DH | 171 |
| QRCEAR224878 | 122 | QRMPA5430 N | 123 | QROAH42T0DH | 164 | QROBF30S1 | 162 |
| QRCEAR224890 | 122 | QRMPA5436 N | 123 | QROAH42T1 | 159 | QROBF30S1DH | 174 |
| QRE24 | 133 | QRMPA6030 N | 123 | QROAH42T1DH | 167 | QROBF36S0 | 161 |
| QRE35F | 133 | QRMPA6036 N | 123 | QROAH48T0 | 157 | QROBF36S0DH | 171 |
| QREDH24 | 133 | QRMPA6630 | 123 | QROAH48T0DH | 164 | QROBF36S1 | 162 |
| QREDH35F | 133 | QRMPA6636 | 123 | QROAH48T1 | 159 | QROBF36S1DH | 174 |
| QRFTCWSUH21 | 111 | QRMPA7230 | 123 | QROAH48T1DH | 167 | QROBF42S0 | 161 |
| QRFTCWSUH25 | 111 | QRMPA7236 | 123 | QROAH54T0 | 157 | QROBF42S0DH | 171 |
| QRFTCWSUH37 | 111 | QRMPA7830 | 123 | QROAH54T0DH | 164 | QROBF42S1 | 162 |
| QRKA 363623 | 125 | QRMPA7836 | 123 | QROAH54T1 | 159 | QROBF42S1DH | 174 |
| QRKA 363632 | 125 | QRMPA8436 | 123 | QROAH54T1DH | 167 | QROBF48S0 | 161 |
| QRKA 364223 | 125 | QRMPA9636 | 123 | QROAH66T0 | 157 | QROBF48S0DH | 171 |
| QRKA 364232 | 125 | QRMPB5430 N | 124 | QROAH66T0DH | 164 | QROBF48S1 | 162 |
| QRKA 423623 | 125 | QRMPB5436 N | 124 | QROAH66T1 | 159 | QROBF48S1DH | 174 |
| QRKA 423632 | 125 | QRMPB6030 N | 124 | QROAH66T1DH | 167 | QROBF54S0 | 161 |
| QRKA 424223 | 125 | QRMPB6036 N | 124 | QROAH78T0 | 157 | QROBF54S0DH | 171 |
| QRKA 424232 | 125 | QRMPB6630 | 124 | QROAH78T0DH | 164 | QROBF54S1 | 162 |
| QRKA 424233 | 125 | QRMPB6636 | 124 | QROAH78T1 | 159 | QROBF54S1DH | 174 |
| QRKA 424823 | 125 | QRMPB7230 | 124 | QROAH78T1DH | 167 | QROBF66S0 | 161 |
| QRKA 424832 | 125 | QRMPB7236 | 124 | QROAH84T0 | 157 | QROBF66S0DH | 171 |
| QRKA 484223 | 125 | QRMPB7830 | 124 | QROAH84T0DH | 164 | QROBF66S1 | 162 |
| QRKA 484232 | 125 | QRMPB7836 | 124 | QROAH84T1 | 159 | QROBF66S1DH | 174 |
| QRKA 484823 | 125 | QRMPB8436 | 124 | QROAH84T1DH | 167 | QROBF78S0 | 161 |
| QRKA 484832 | 125 | QRMPB9636 | 124 | QROA030BM | 177 | QROBF78S0DH | 171 |
| QRKA 484833 | 125 | QROAF30S0 | 158 | QROA030BW | 176 | QROBF78S1 | 162 |
| QRKB 363623 | 125 | QROAF30S0DH | 165 | QROA030DHBM | 177 | QROBF78S1DH | 174 |
| QRKB 363632 | 125 | QROAF30S1 | 159 | QROA030DHBW | 176 | QROBF90S0 | 161 |
| QRKB 364223 | 125 | QROAF30S1DH | 168 | QROA030T0 | 157 | QROBF90S0DH | 171 |
| QRKB 364232 | 125 | QROAF36S0 | 158 | QROA030T0DH | 163 | QROBF90S1 | 162 |
| QRKB 423623 | 125 | QROAF36S0DH | 165 | QROA030T1 | 158 | QROBF90S1DH | 174 |
| QRKB 423632 | 125 | QROAF36S1 | 159 | QROA030T1DH | 166 | QROBH30T0 | 160 |
| QRKB 424223 | 125 | QROAF36S1DH | 168 | QROA036BM | 177 | QROBH30T0DH | 170 |
| QRKB 424232 | 125 | QROAF42S0 | 158 | QROA036BW | 176 | QROBH30T1 | 162 |
| QRKB 424233 | 125 | QROAF42S0DH | 165 | QROA036DHBM | 177 | QROBH30T1DH | 173 |
| QRKB 424823 | 125 | QROAF42S1 | 159 | QROA036DHBW | 176 | QROBH36T0 | 160 |
| QRKB 424832 | 125 | QROAF42S1DH | 168 | QROA036T0 | 157 | QROBH36T0DH | 170 |
| QRKB 484223 | 125 | QROAF48S0 | 158 | QROA036T0DH | 163 | QROBH36T1 | 162 |
| QRKB 484232 | 125 | QROAF48S0DH | 165 | QROA036T1 | 158 | QROBH36T1DH | 173 |
| QRKB 484823 | 125 | QROAF48S1 | 159 | QROA036T1DH | 166 | QROBH42T0 | 160 |
| QRKB 484832 | 125 | QROAF48S1DH | 168 | QROA042T0 | 157 | QROBH42T0DH | 170 |
| QRKB 484833 | 125 | QROAF54S0 | 158 | QROA042T0DH | 163 | QROBH42T1 | 162 |
| QRM9A5430 N | 123 | QROAF54S0DH | 165 | QROA042T1 | 158 | QROBH42T1DH | 173 |
| QRM9A5436 N | 123 | QROAF54S1 | 159 | QROA042T1DH | 166 | QROBH48T0 | 160 |
| QRM9A6030 N | 123 | QROAF54S1DH | 168 | QROA048T0 | 157 | QROBH48T0DH | 170 |
| QRM9A6036 N | 123 | QROAF66S0 | 158 | QROA048T0DH | 163 | QROBH48T1 | 162 |
| QRM9A6630 | 123 | QROAF66S0DH | 165 | QROA048T1 | 158 | QROBH48T1DH | 173 |
| QRM9A6636 | 123 | QROAF66S1 | 159 | QROA048T1DH | 166 | QROBH54T0 | 160 |
| QRM9A7230 | 123 | QROAF66S1DH | 168 | QROA054T0 | 157 | QROBH54T0DH | 170 |
| QRM9A7236 | 123 | QROAF78S0 | 158 | QROA054T0DH | 163 | QROBH54T1 | 162 |

| <i>pattern no.</i> | <i>page</i> | <i>pattern no.</i> | <i>page</i> | <i>pattern no.</i> | <i>page</i> | <i>pattern no.</i> | <i>page</i> |
|--------------------|-------------|--------------------|-------------|--------------------|-------------|--------------------|-------------|
| QROBH54T1DH | 173 | QROPH54S0 | 175 | QRSAC7818 | 118 | QRSB1202 | 115 |
| QROBH66T0 | 160 | QROPH84S0 | 175 | QRSAC7836 | 118 | QRSB1203 | 115 |
| QROBH66T0DHDH | 170 | QRP231J | 138, 139 | QRSAC8418 | 118 | QRSB1204 | 115 |
| QROBH66T1 | 162 | QRP232J | 138, 139 | QRSAC8436 | 118 | QRSB161-N | 115 |
| QROBH66T1DHDH | 173 | QRP261J | 138, 139 | QRSAC9018 | 118 | QRSB162-N | 115 |
| QROBH78T0 | 160 | QRP262J | 138, 139 | QRSAC9036 | 118 | QRSB163-N | 115 |
| QROBH78T0DHDH | 170 | QRP301J | 138, 139 | QRSAC9618 | 118 | QRSB484 | 115 |
| QROBH78T1 | 162 | QRP302J | 138, 139 | QRSAP1041 | 113 | QRSB544 | 115 |
| QROBH78T1DHDH | 173 | QRP361J | 138, 139 | QRSAP1042 | 113 | QRSB784 | 115 |
| QROBH84T0 | 160 | QRP362J | 138, 139 | QRSAP1043 | 114 | QRSB844 | 115 |
| QROBH84T0DHDH | 170 | QRPAB17UK | 136 | QRSAP1101 | 113 | QRSB904 | 115 |
| QROBH84T1 | 162 | QRPDHB17UK | 137 | QRSAP1102 | 113 | QRSB964 | 115 |
| QROBH84T1DHDH | 173 | QRPHB2424 | 179 | QRSAP1103 | 114 | QRSBC10218 | 119 |
| QROBO30BM | 177 | QRPHB3624 | 179 | QRSAP261 | 113 | QRSBC10818 | 119 |
| QROBO30BW | 176 | QRPHB4824 | 179 | QRSAP262 | 113 | QRSBC3018 | 119 |
| QROBO30DHBDM | 177 | QRPHB5424 | 179 | QRSAP263 | 113 | QRSBC3618 | 119 |
| QROBO30DHBW | 176 | QRPHB6024 | 179 | QRSAP321 | 113 | QRSBC3636 | 119 |
| QROBO30T0 | 160 | QRPHB7224 | 179 | QRSAP322 | 113 | QRSBC4218 | 119 |
| QROBO30T0DHDH | 169 | QRRAW12048 | 132 | QRSAP323 | 113 | QRSBC4236 | 119 |
| QROBO30T1 | 161 | QRRAW14448 | 132 | QRSAP381 | 113 | QRSBC4818 | 119 |
| QROBO30T1DHDH | 172 | QRRAW16848 | 132 | QRSAP382 | 113 | QRSBC5418 | 119 |
| QROBO36BM | 177 | QRRAW19248 | 132 | QRSAP383 | 113 | QRSBC5436 | 119 |
| QROBO36BW | 176 | QRRAW4848 | 132 | QRSAP441 | 113 | QRSBC6018 | 119 |
| QROBO36DHBDM | 177 | QRRAW9648 | 132 | QRSAP442 | 113 | QRSBC6036 | 119 |
| QROBO36DHBW | 176 | QRSA1021 | 112 | QRSAP443 | 114 | QRSBC6618 | 119 |
| QROBO36T0 | 160 | QRSA1022 | 112 | QRSAP501 | 113 | QRSBC6636 | 119 |
| QROBO36T0DHDH | 169 | QRSA1023 | 112 | QRSAP502 | 113 | QRSBC7218 | 119 |
| QROBO36T1 | 161 | QRSA1024 | 112 | QRSAP503 | 114 | QRSBC7236 | 119 |
| QROBO36T1DHDH | 172 | QRSA1081 | 112 | QRSAP561 | 113 | QRSBC7818 | 119 |
| QROBO42T0 | 160 | QRSA1082 | 112 | QRSAP562 | 113 | QRSBC7836 | 119 |
| QROBO42T0DHDH | 169 | QRSA1083 | 112 | QRSAP563 | 114 | QRSBC8418 | 119 |
| QROBO42T1 | 161 | QRSA1084 | 112 | QRSAP621 | 113 | QRSBC8436 | 119 |
| QROBO42T1DHDH | 172 | QRSA1141 | 112 | QRSAP622 | 113 | QRSBC9018 | 119 |
| QROBO48T0 | 160 | QRSA1142 | 112 | QRSAP623 | 114 | QRSBC9036 | 119 |
| QROBO48T0DHDH | 169 | QRSA1143 | 112 | QRSAP681 | 113 | QRSBC9618 | 119 |
| QROBO48T1 | 161 | QRSA1144 | 112 | QRSAP682 | 113 | QRSBP1041 | 116 |
| QROBO48T1DHDH | 172 | QRSA1201 | 112 | QRSAP683 | 114 | QRSBP1042 | 116 |
| QROBO54T0 | 160 | QRSA1202 | 112 | QRSAP741 | 113 | QRSBP1043 | 117 |
| QROBO54T0DHDH | 169 | QRSA1203 | 112 | QRSAP742 | 113 | QRSBP1101 | 116 |
| QROBO54T1 | 161 | QRSA1204 | 112 | QRSAP743 | 114 | QRSBP1102 | 116 |
| QROBO54T1DHDH | 172 | QRSA161-N | 112 | QRSAP801 | 113 | QRSBP1103 | 117 |
| QROBO66T0 | 160 | QRSA162-N | 112 | QRSAP802 | 113 | QRSBP261 | 116 |
| QROBO66T0DHDH | 169 | QRSA163-N | 112 | QRSAP803 | 114 | QRSBP262 | 116 |
| QROBO66T1 | 161 | QRSA484 | 112 | QRSAP861 | 113 | QRSBP263 | 116 |
| QROBO66T1DHDH | 172 | QRSA544 | 112 | QRSAP862 | 113 | QRSBP321 | 116 |
| QROBO78T0 | 160 | QRSA784 | 112 | QRSAP863 | 114 | QRSBP322 | 116 |
| QROBO78T0DHDH | 169 | QRSA844 | 112 | QRSAP921 | 113 | QRSBP323 | 116 |
| QROBO78T1 | 161 | QRSA904 | 112 | QRSAP922 | 113 | QRSBP381 | 116 |
| QROBO78T1DHDH | 172 | QRSA964 | 112 | QRSAP923 | 114 | QRSBP382 | 116 |
| QROBO84T0 | 160 | QRSAC10218 | 118 | QRSAP981 | 113 | QRSBP383 | 116 |
| QROBO84T0DHDH | 169 | QRSAC10818 | 118 | QRSAP982 | 113 | QRSBP441 | 116 |
| QROBO84T1 | 161 | QRSAC3018 | 118 | QRSAP983 | 114 | QRSBP442 | 116 |
| QROBO84T1DHDH | 172 | QRSAC3618 | 118 | QRSB1021 | 115 | QRSBP443 | 117 |
| QROMH24S0 | 175 | QRSAC3636 | 118 | QRSB1022 | 115 | QRSBP501 | 116 |
| QROMH42S0 | 175 | QRSAC4218 | 118 | QRSB1023 | 115 | QRSBP502 | 116 |
| QROMH48S0 | 175 | QRSAC4236 | 118 | QRSB1024 | 115 | QRSBP503 | 117 |
| QROMH54S0 | 175 | QRSAC4818 | 118 | QRSB1081 | 115 | QRSBP561 | 116 |
| QROMH66S0 | 175 | QRSAC5418 | 118 | QRSB1082 | 115 | QRSBP562 | 116 |
| QROMH78S0 | 175 | QRSAC5436 | 118 | QRSB1083 | 115 | QRSBP563 | 117 |
| QROMH84S0 | 175 | QRSAC6018 | 118 | QRSB1084 | 115 | QRSBP621 | 116 |
| QROMH90S0 | 175 | QRSAC6036 | 118 | QRSB1141 | 115 | QRSBP622 | 116 |
| QROMH96S0 | 175 | QRSAC6618 | 118 | QRSB1142 | 115 | QRSBP623 | 117 |
| QROPH24S0 | 175 | QRSAC6636 | 118 | QRSB1143 | 115 | QRSBP681 | 116 |
| QROPH42S0 | 175 | QRSAC7218 | 118 | QRSB1144 | 115 | QRSBP682 | 116 |
| QROPH48S0 | 175 | QRSAC7236 | 118 | QRSB1201 | 115 | QRSBP683 | 117 |

| <i>pattern no.</i> | <i>page</i> | <i>pattern no.</i> | <i>page</i> |
|--------------------|-------------|--------------------|-------------|
| QRSBP741 | 116 | RTLT5E19 | 178 |
| QRSBP742 | 116 | RTLT5E25 | 178 |
| QRSBP743 | 117 | RTLT5E37 | 178 |
| QRSBP801 | 116 | RTLT5E49 | 178 |
| QRSBP802 | 116 | RTLT5E61 | 178 |
| QRSBP803 | 117 | RTLT5E73 | 178 |
| QRSBP861 | 116 | RTLT5E85 | 178 |
| QRSBP862 | 116 | | |
| QRSBP863 | 117 | | |
| QRSBP921 | 116 | | |
| QRSBP922 | 116 | | |
| QRSBP923 | 117 | | |
| QRSBP981 | 116 | | |
| QRSBP982 | 116 | | |
| QRSBP983 | 117 | | |
| QRSD3627 | 135 | | |
| QRSDA3627 | 135 | | |
| QRSDHD3628 | 135 | | |
| QRSDHDA3628 | 135 | | |
| QRTA2424 | 130 | | |
| QRTA3030 | 130 | | |
| QRTA5454 | 130 | | |
| QRTAW12048 | 131 | | |
| QRTAW14448 | 131 | | |
| QRTAW16848 | 131 | | |
| QRTAW19248 | 131 | | |
| QRTAW4848 | 131 | | |
| QRTAW9648 | 131 | | |
| QRTB2424 | 130 | | |
| QRTB3030 | 130 | | |
| QRTB5454 | 130 | | |
| QRWHTB2424 | 179 | | |
| QRWHTB5424 | 179 | | |
| QRWHTB6024 | 179 | | |
| QRWHTB7224 | 179 | | |
| QRWSU34 | 111 | | |
| QRWSU42 | 111 | | |
| QRWSU49 | 111 | | |
| QRWSU64 | 111 | | |
| QRWSU79 | 111 | | |
| QRWSUH34 | 111 | | |
| QRWSUH42 | 111 | | |
| QRWSUH49 | 111 | | |
| QRWSUH64 | 111 | | |
| QRWSUH79 | 111 | | |
| QS990981 | 110 | | |
| QS994873 | 109 | | |
| QS9A5986 | 110 | | |
| QS9A8002 | 109 | | |
| QS9A8003 | 109 | | |
| QS9B2960 | 109 | | |
| QS9G2320 | 110 | | |
| QS9G2321 | 110 | | |
| QS9G2425 | 110 | | |
| QS9G5498 | 109 | | |
| QS9G5499 | 109 | | |
| QS9G5875 | 109 | | |
| QS9G5876 | 109 | | |
| RBC18 (L/R) | 128 | | |
| RBCC | 128 | | |
| RTAT5E19 | 185 | | |
| RTAT5E25 | 185 | | |
| RTAT5E37 | 185 | | |
| RTAT5E49 | 185 | | |
| RTAT5E61 | 185 | | |

Selling Policy

| | |
|--|---|
| | <p>This Selling Policy supercedes all previous selling policies. Prices, discounts and product offerings are subject to change without notice.</p> |
| Terms & Conditions of Sales | <p>Sales by Knoll, Inc. or Knoll North America Corp. ("Seller") of Knoll Product Lines (hereinafter "Products") within the United States and Canada are made only on the terms which are contained in this Selling Policy. Seller hereby gives notice of its objection to any different or additional terms and conditions. This sale is expressly conditional upon Purchaser's assent to the terms and conditions set forth below. Additional terms and conditions may apply to KnollStudio and KnollTextiles orders. These terms and conditions may be modified or supplemented only by a written document signed by an authorized representative of Seller. These terms and conditions supercede any prior and/or contemporaneous agreements or correspondence between Purchaser and Seller. Written quotations expire thirty (30) days from the date of issuance and can be withdrawn by written notice anytime during that period. Where Purchaser and Seller have entered into the Knoll Electronic Terms and Conditions, all orders, acknowledgements, invoices and other business communications placed or transmitted in accordance with the Knoll Electronic Terms and Conditions shall be deemed to be in writing and signed and shall be valid for all purposes as if they were originated and maintained in documentary form.</p> |
| Ordering Information | <p>All orders must be in writing. The product pattern number(s) contained on Seller's order acknowledgement shall be the final expression of the order.</p> |
| Order Confirmation | <p>A purchase order is not binding on Seller until Purchaser has received Seller's order confirmation or acknowledgment.</p> |
| Pricing Policies | <p>List prices are subject to change without notice.</p> <p>List prices shall be those prices in effect on the date of receipt of a complete purchase order unless shipment is requested more than ninety (90) days after order entry in which case prices in effect on the date of shipment apply. List prices include specified freight costs. Unless specified in writing by Seller, no other charges are included in Seller's list prices.</p> |
| Taxes | <p>All sales, use, excise and other taxes applicable to the sale of the Products shall be paid by Purchaser. If Purchaser claims an exemption from any tax, Purchaser shall submit to Seller the appropriate exemption certificates.</p> |
| Terms of Payment | <p>Payment for one hundred percent (100%) of the net order amount is due within thirty (30) days of the date of invoice, which is issued upon shipment. In case of any discrepancies, such as shortages, and Seller is notified in writing within ten (10) days of receipt of Product, only that portion may be deducted and the balance paid. For orders greater than \$100,000 net, a fifty percent (50%) deposit is due at the time of order placement, with the remainder due within thirty (30) days of the date of invoice.</p> <p>KnollStudio orders less than \$2,000 require payment for one hundred percent (100%) of the net order amount (including any applicable sales tax and charges for inside delivery, special packaging, etc.), due at time of order placement. For KnollStudio orders greater than \$2,000, a one-half (50%) deposit is due at time of order placement with the remainder (including any applicable sales tax and charges for inside delivery, special packaging, etc.) due prior to shipment.</p> <p>If, in the judgment of Seller, Purchaser's financial condition does not justify the terms of the payment, Seller may require full or partial payment in advance.</p> <p>Past due accounts shall be charged one and one-half percent (1.5%) per month, or the highest rate permitted by law, whichever is less, and will be added to the outstanding balance. In the event Purchaser defaults on payment, Purchaser shall be liable for all collection costs, including reasonable attorney's fees and costs.</p> |
| Changes and Cancellation | <p>Purchase orders may not be changed or cancelled, in whole or in part, without prior written consent of Seller. Changes may effect delivery dates. Expenses incurred because of changes shall be charged to Purchaser. In the event of cancellations, Purchaser will be liable for reasonable cancellation charges established by Seller. Orders for special Product, orders including "COM" (hereinafter defined) material and orders pursuant to expedited delivery programs, may not be canceled.</p> |
| Freight Prepaid | <p>Freight is prepaid and included in the price of all Products, except KnollTextiles, within the 48 contiguous United States for orders placed with Knoll, Inc. and within Canada, excluding the Yukon, Northwest Territories, Nunavut and Newfoundland for orders placed with Knoll North America Corp. Packing is tested for rigorous motion and transportation but is not guaranteed to protect furniture from conditions over which the Seller has no control. If special packaging is required for any reason, please consult with your sales representative or dealer. Seller shall select the method of shipment and routing. All shipments shall be tailgate deliveries. Freight for all KnollTextiles orders is prepaid and added to the invoice.</p> |
| Delivery/Freight Charges | <p>Shipments outside the contiguous 48 United States and Canada shall be shipped F.O.B. Origin.</p> <p>For shipments outside the contiguous United States and Canada, Purchaser is responsible for the cost of freight from point of embarkation, including any handling and transportation charges incidental to loading at the point of departure and unloading at the final destination.</p> <p>Conditions beyond the control of Seller, including weather, available facilities and traffic conditions, may affect exact time of delivery. Seller shall not be responsible for specific carrier delivery date or time unless it has made a specific delivery commitment, in writing.</p> <p>Nonstandard methods of shipment and/or additional services are available upon request. Purchaser will be billed for the differential cost of any special services in excess of standard surface carrier freight costs. Premium charges, at Purchaser's request, will be added for airfreight, exclusive use of vehicle and extra, export or special packaging. Accessorial charges will be added for inside delivery, extra labor, reassignment and redelivery.</p> <p>Partial shipments may be made and invoiced by Seller.</p> |
| Claims | <p>All shipments for all Knoll Products within the contiguous United States and Canada are F.O.B. Origin. Risk of loss passes to Purchaser at time of delivery to carrier. Purchaser shall inspect all Products upon receipt and notify Seller within ten (10) working days after receipt of any damage or defects which are, or should be, apparent from an inspection of the Product and its packaging. Failure of Purchaser to make a claim against carrier or notify Seller during the ten (10) working day period shall constitute acceptance of the Products and waiver of any apparent defects, errors or shortages. Seller will agree to repair or replace Product damaged in shipment if Purchaser has notified Seller of freight damage within ten (10) working days after receipt and assigns its rights against the carrier.</p> |
| Seller's Security Interest | <p>Until Seller receives the full payment for the Product, Seller shall have a security interest in the Product. Purchaser agrees to perform all acts, including but not limited to the execution and filing of documentation, which may be necessary to perfect and assure the security interest of Seller.</p> |
| Returns | <p>The return of Products without a written authorization by Seller shall not be accepted. To receive authorization for Product return, please call Customer Service. All Products that are returned pursuant to a valid authorization shall be subject to a twenty-five percent (25%) of list restocking charge. Products not currently offered for sale by Seller (including COM) shall not be authorized for return. All returned Products must be unused, in original condition and in the original Seller packing cartons. No refund or credit shall be given for damaged Products.</p> |
| Held Orders/Storage | <p>If Purchaser requests that an order be held or delayed, prices and terms and conditions in effect at the time of shipment shall apply. If Purchaser requests a delay after the time when Seller can defer production, Purchaser will be invoiced for the Product, payable in accordance with standard terms, when the order is ready for shipment. Seller may transfer the Product to storage, in which case all expenses incurred in connection with storage, including demurrage, preparation for storage, storage charges and handling shall be payable by Purchaser upon submission of invoices by Seller. Risk of loss to the Product shall pass to the Purchaser upon delivery of the Product into storage.</p> |

Selling Policy

| | |
|---------------------------------|---|
| Customer's Own Material | <p>A Purchaser who requests a fabric or other surface material not standard to Seller's line of Products ("COM") must submit samples of the requested material to Seller prior to entry of a purchaser order. Seller shall determine if the material is suitable to its manufacturing processes and meets any requirements of Underwriters Laboratories. If the COM is acceptable, Seller will then establish a price for using the COM or the Product in question. For a description of the procedures for submitting samples and testing, contact customer resources or your sales representative. Seller shall have no responsibility for the appearance, condition, performance, durability, colorfastness or any other physical attribute of the COM. Purchaser shall indemnify and hold Seller harmless for any damages, injuries or losses arising out of or related to use of the COM on the Product.</p> |
| Warranty | <p>Seller warrants to the original Purchaser only that the Products Seller manufactures and sells to Purchaser are free of defects in workmanship and materials, during the applicable warranty period set forth below.</p> <p>Warranty period set forth below is for 24-hour, 7 days a week, multi shift use.</p> <p>Should any failure to conform with this limited warranty appear to a Product listed below during the applicable warranty period from the date of shipment, Seller shall, upon prompt written notice, repair or replace, at its option and costs, the affected part or parts.</p> <p><i>Product and Period of Warranty</i></p> <p><i>Lifetime: AutoStrada, Calibre, Crinion Open Table, Currents, Dividends Horizon, Equity, Morrison, Reff laminate, Series 2 Storage, Template and other non-wood components (except cascade edge worksurfaces, operational parts, controls, electrical, Lighting, Series 2 Veneer Front Storage, special or custom products, see below)</i></p> <p><i>10 Years: AutoStrada, Crinion Open Table, Reff wood components, Series 2 Veneer Front Storage, Wood Casegoods (Magnusson, The Graham Collection) (except wood casegoods upholstered surfaces, see below), Interaction tables (except height adjustment mechanisms for Counterforce, crank-adjustable, and split-top tables and worksurfaces, see below), Reuter overheads, Reuter vertical storage, KnollExtra Sapper Monitor Arm Collection, Adjustable keyboard mechanisms and platforms, Communication Boards (except fabric board textiles, see below), Smokador collection (except leathers, see below), and Orchestra Universal Systems Accessories, Bulldog, Chadwick, Essentials Work Chairs, Generation by Knoll work chair, Life, Moment, RPM and Sapper seating structural and operational parts, controls, casters, pneumatic cylinders, seat and back suspension material (except seating upholstery, textiles and leathers, finishes and labor, see below). Labor to repair Generation by Knoll work chair.</i></p> <p><i>5 Years: Operational parts, controls, electrical, Lighting (except light ballasts, bulbs and power supply, see below), cascade edge worksurfaces, special or custom product, wood veneer products, Currents handerank, Interaction Counterforce, Interaction crank-adjustable, and split-top mechanisms, KnollStudio, KnollExtra Wishbone and Zorro monitor supports, CPU storage and all universal storage drawers, Spark Series seating structural parts, (except seating upholstery, textiles, finishes and labor, see below).</i></p> <p><i>3 Years: Bulldog, Chadwick, Essentials Work Chairs, Life, Moment, RPM, Sapper seating upholstery, textiles and leathers, finishes and labor to repair, Generation by Knoll work chair seating upholstery, textiles and leathers, and finishes, Spark Series seating upholstery and textiles. Fabric boards textiles and Smokador Collection leathers.</i></p> <p><i>2 Years: All other KnollExtra product</i></p> <p><i>1 Year: Light ballasts, bulbs and power supply, seating upholstered ampads and soft ampads, Spark Series seating finishes and labor to repair, wood casegoods upholstered surfaces.</i></p> <p>This warranty does not apply to:</p> <ul style="list-style-type: none">• Damage caused by a carrier other than the Seller.• Normal wear and tear or acts or omissions of parties other than Seller (including user modification, improper use or installation of Products).• COM or other third party materials applied to Products.• Products not installed by or under the auspices of a Knoll Dealer.• Dramatic temperature variations or exposure to unusual conditions.• Except as specifically noted above, textiles and upholstery supplied by <i>KnollTextiles</i> (consult current <i>KnollTextiles</i> price list for applicable warranty). <p>Natural variations occurring in wood, marble, and leather shall not be considered defects, and the Seller does not guarantee the colorfastness or matching of the colors, grains or textures, or surface hardness of such materials. The Seller also does not guarantee the colorfastness of fiberglass panel surfaces. THE EXPRESS WARRANTIES CONTAINED HEREIN ARE IN LIEU OF ALL OTHER WARRANTIES, EXPRESS OR IMPLIED, INCLUDING ANY WARRANTIES OF MERCHANTABILITY AND FITNESS FOR PARTICULAR PURPOSE AND ALL OTHER WARRANTIES ARISING FROM COURSE OF DEALING OR USAGE OF TRADE.</p> <p>The remedies provided above are the Purchaser's sole remedies for any failure of Seller to comply with its obligations regarding the workmanship of its Products. Correction of any nonconformity in the manner and for the period of time provided shall constitute complete fulfillment of all liabilities of Seller, with respect to or arising out of the Product furnished hereunder.</p> |
| Delay/Force Majeure | <p>Seller shall not be liable for failure to perform or for delay in performance due to fire, flood, strike or other labor difficulty, act of God, act of any governmental authority or of the Purchaser, riot, embargo, fuel or energy shortage, wrecks or delay in transportation, inability to obtain necessary labor, materials or manufacturing facilities from usual sources or failure of suppliers to meet their contractual obligations, or due to any cause beyond its reasonable control. If any such event occurs, Seller may extend delivery dates by a period of time necessary to overcome the effect of such delay, allocate available Product or cancel any purchase order.</p> |
| Compliance with Law | <p>PURCHASER IS SOLELY RESPONSIBLE FOR COMPLIANCE WITH ALL APPLICABLE FEDERAL, STATE AND LOCAL LAWS, ORDINANCES, REGULATIONS, RULES AND STANDARDS RELATING TO THE INSTALLATION, MAINTENANCE, USE AND OPERATION OF THE PRODUCTS.</p> |
| Patents | <p>Subject to the following provisions, Seller shall, at its own expense, defend or, at its option, settle any claim, suit or proceeding brought against the Purchaser, and/or its vendees, mediate and immediate, so far as based on an allegation that any Product or any part thereof furnished hereunder constitutes a direct or a contributory infringement of any claim of any patent of the United States or Canada. This obligation shall be effective only if Purchaser shall have made all payments then due hereunder and if Seller is notified promptly in writing and given authority, information and assistance for the defense of said claim, suit or proceeding. Seller shall pay all damages and costs awarded in such suit or proceedings so defended.</p> <p>The foregoing indemnity does not apply to the following:</p> <ul style="list-style-type: none">• Products supplied according to a design other than that of Seller, and which is required by the Purchaser.• Combination of the Product with another product not furnished hereunder unless Seller is a contributory infringer.• Any settlements of a suit or proceeding made without Seller's written consent. |
| Limitations of Liability | <p>SELLER, ITS CONTRACTORS, AUTHORIZED DEALERS AND SUBCONTRACTORS OR SUPPLIERS OF ANY TIER SHALL NOT BE LIABLE TO PURCHASER FOR ANY SPECIAL, INDIRECT, INCIDENTAL OR CONSEQUENTIAL DAMAGES ARISING FROM A BREACH OF THIS AGREEMENT.</p> <p>Purchaser's remedies set forth herein are exclusive and the liability of Seller with respect to the breach of this agreement or any contract entered into between the parties pursuant hereto shall not exceed the price of the Product or part on which such liability is based.</p> |

KnollKey Lock Program

KnollKey Lock Program General Information

Following is the KnollKey lock policy, applicable to all products.

Knoll furniture can be ordered keyed-alike or random keyed. Key-alike and random keying instructions cannot be mixed on any single order. Only one of the two instructions can be used on an individual order. When an order is submitted with mixed (key-alike and random) instructions, Knoll will release the order as key-alike only and lock cores will have to be specified separately.

Key-alike

For the convenience of the user, furniture may be keyed alike at no charge. Write "Key-alike" in the description of your purchase order for any pedestal, overhead, file or other item you wish to have keyed alike.

Using the key-alike instructions, order cores and keys as line items on your purchase order. Do NOT submit a key-alike form. The Knoll East Greenville Lock Center will select key numbers from the standard range of K 001 - K 250. Key numbers will not be repeated unless over 250 sets are ordered. Lock cores keyed-alike will ship separately from the product, ready for field installation.

There is no charge for key-alike orders if placed with the furniture order.

IF THE KEY-ALIKE ORDER IS NOT PLACED AT LEAST TWO WEEKS PRIOR TO THE FURNITURE SHIP DATE, A \$50 HANDLING CHARGE AND AIR FREIGHT CHARGES WILL APPLY.

If product is ordered and shipped random-keyed, additional lock cores for key-alike are billable.

Random-Keying

To specify product keyed-random, write "key-random" in the product description. Random-keyed product is shipped with the lock core factory installed. A shrouded key is included. Random means no effort has been made to match key numbers, or to make them different.

Keys

A Knoll shrouded key is shipped with every lock core. 250 Key numbers are available. For numbers above 250, contact Custom Product Development. Additional keys and key blanks are available. See service parts for more information.

Master Keying

Knoll locks can be controlled by means of a master key. There is no additional per-lock charge for master keying. A letter of approval from the client must accompany orders for master keys.

Installing Lock Cores

Lock cores can be installed or removed in the field by using a change key. Cores must be in the unlocked position to be removed. See service parts for change key pattern number and pricing.

Lock Distribution

All orders for key-alike lock cores/keys are packaged and shipped from the East Greenville Lock Center, regardless of where the pedestals, overhead, or other units are produced. Random keyed product will have cores factory-installed.

How to Specify Key-Alike

Following is an example of how to specify key-alike for a cluster of 10 workstations.

Step 1 - Using the project floorplan, count the number of locks in each workstation.

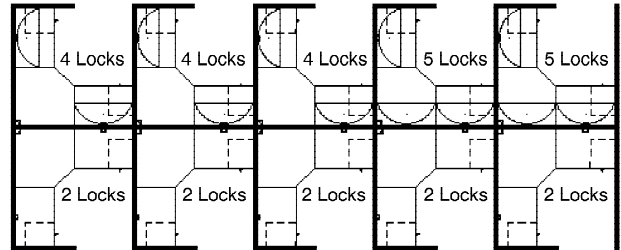

Step 2 - Count the number of workstations with the same quantity of locks. Group together the workstations with a like number of locks.

5 workstations with 2 locks per station
3 workstations with 4 locks per station
2 workstations with 5 locks per station

Step 3 - For the first group (5 sets of 2 locks), enter the number of workstations in the quantity column.

| Qty | Pattern # | Description | Unit List | Ext. List |
|-----|-----------|-------------|-----------|-----------|
| 5 | | | | |

Step 4 - Then enter the pattern number "KSPEC_ _" and add a suffix for the number of locks for that group (i.e., for 2 locks per station, add the suffix "2"). Up to 30 lock cores are available in a set (i.e., KSPEC 30).

| Qty | Pattern # | Description | Unit List | Ext. List |
|-----|-----------|---------------------|-----------|-----------|
| 5 | KSPEC 2 | Set of 2 cores/keys | N / C | N / C |

Step 5 - Repeat for other groups.

| Qty | Pattern # | Description | Unit List | Ext. List |
|-----|-----------|---------------------|-----------|-----------|
| 5 | KSPEC 2 | Set of 2 cores/keys | N / C | N / C |
| 3 | KSPEC 4 | Set of 4 cores/keys | N / C | N / C |
| 2 | KSPEC 5 | Set of 5 cores/keys | N / C | N / C |

Your Key instructions are complete.

Knoll will select key numbers for each set from 250 available numbers. Additional key numbers are available through Custom Product Development. **For additions to existing installations, specify desired key numbers in the description.**

Service Parts

| Pattern # | Description | List Price |
|-------------|---|------------|
| KKEY_ _ _ | Shrouded Key Specify key number desired | \$5 |
| KBLANK | Shrouded Key Blank | \$5 |
| KSPECB_ _ _ | Retrofit Universal Core/Key Specify key number desired | \$18 |
| KCHANGE | Change Key | \$5 |
| KMASTER* | Master Key | \$5 |

*Note: A letter of approval on company letterhead from the client must accompany all orders for master keys.

General Ordering Information

The Products

This guide encompasses all standard products for this product group.

Sizes

Dimensions listed in this guide are indicated as:

H = height

W = width

D = depth

Dia. = diameter

Rad. = radius

Pricing

All prices shown are list.

How to Order

Select pattern numbers and quantities required for your complete installation. Product questions can be addressed in the specific sections of this guide or by contacting your sales representative or customer resource representative at 1-800-343-5665.

Next, select options (if required), along with colors and finishes appropriate to each product. Reference the Finishes and Fabrics pages for color designations.

On large installations, an item's "designated area" can be specified to assist in product organization and handling.

To expedite complete / correct entry of your order, be certain all pattern numbers, quantities, colors and area identifications are completely specified. Also, include complete purchase order numbers, bill-to and ship-to addresses, a contact name and specific factory shipping dates required.

Mail all orders to:

Knoll, Inc.

1235 Water Street

P.O. Box 157

East Greenville, PA 18041

Attention: Order Entry

Once your order is entered at Knoll, an acknowledgment will be mailed to you. You will be advised of your scheduled shipping date within five days of the original acknowledgment. If it is necessary to revise your order, please contact your customer resource representative.

Sustainability Statement

Sustainable design is a key component of Knoll's environmental focus. Our commitment to social responsibility and a healthy environment has prompted us to further articulate our longstanding environmental programs and, with encouragement and support from our colleagues in the industry, we have re-energized our focus on such "green" initiatives as life cycle analysis and LEED™ certification. Knoll is proud to have contributed to projects that have received LEED certification from the U.S. Green Building Council.

For the latest information on Knoll products that help our customers achieve LEED certification, log on to knoll.com, click on "About Knoll" and then "Environmental Focus."